



@server

xSeries 205

Type 8480

Option Installation Guide



IBM xSeries 205
Type 8480



Option Installation Guide

Note:

Before using this information and the product it supports, be sure to read the general information in Appendix A, "Notices" on page 37.

First Edition (August 2002)

© Copyright International Business Machines Corporation 2002. All rights reserved.

US Government Users Restricted Rights – Use, duplication or disclosure restricted by GSA ADP Schedule Contract with IBM Corp.

Contents

Safety	v
Chapter 1. Introduction	1
Notices and statements used in this book	1
Major components of the IBM @server xSeries 205 Type 8480	2
System and PCI extender boards	3
System board internal cable connectors	4
System board external connectors	5
Optional system-management adapter component locations	5
Chapter 2. Installing internal options	7
Installation guidelines	7
System reliability considerations	7
Handling static-sensitive devices	7
Moving the stabilizing feet	8
Removing the side cover	9
Removing the frame-support bracket	10
Working with adapters	11
Adapter considerations	11
Installing an adapter	12
Installing a SCSI adapter	14
Cabling a RAID adapter or single SCSI channel using one hot-swap drive SCSI backplane	14
Installing internal drives	16
Internal drive bays	16
Preinstallation steps	17
Power and signal cables for internal drives	18
Installing a drive in bay 1, 2, 3, or 4	19
Installing a non-hot-swap hard disk drive in bay 5, 6, or 7	21
Installing a hot-swap hard disk drive in bay 5, 6, or 7	23
Installing memory modules	25
Installing a security rope clip	26
Replacing the side cover	28
Replacing the battery	28
Chapter 3. Connecting external options	31
Video connector	32
Keyboard connector	32
Mouse connector	32
Parallel connector	32
Serial connectors	33
Gigabit Ethernet port	33
Configuring the Gigabit Ethernet controller	33
High-performance Ethernet modes	34
Universal Serial Bus (USB) connectors	34
USB cables	34
Audio connectors	35
Line out	35
Line in	35
Microphone	35
Optional system-management adapter ports	36
Appendix A. Notices	37
Edition notice	37

Trademarks	38
Important notes	38
Electronic emission notices	39
Federal Communications Commission (FCC) statement	39
Industry Canada Class B emission compliance statement	40
Avis de conformité à la réglementation d'Industrie Canada	40
European Union EMC Directive conformance statement	40
Japanese Voluntary Control Council for Interference (VCCI) statement	40
Power cords	40
Index	43

Safety

Before installing this product, read the Safety Information.

قبل تركيب هذا المنتج، يجب قراءة الملاحظات الأمنية

Antes de instalar este produto, leia as Informações de Segurança.

在安装本产品之前，请仔细阅读 **Safety Information** (安全信息)。

安裝本產品之前，請先閱讀「安全資訊」。

Prije instalacije ovog produkta obavezno pročitajte Sigurnosne Upute.

Před instalací tohoto produktu si přečtěte příručku bezpečnostních instrukcí.

Læs sikkerhedsforskrifterne, før du installerer dette produkt.

Lees voordat u dit product installeert eerst de veiligheidsvoorschriften.

Ennen kuin asennat tämän tuotteen, lue turvaohjeet kohdasta Safety Information.

Avant d'installer ce produit, lisez les consignes de sécurité.

Vor der Installation dieses Produkts die Sicherheitshinweise lesen.

Πριν εγκαταστήσετε το προϊόν αυτό, διαβάστε τις πληροφορίες ασφάλειας (safety information).

לפני שתתקינו מוצר זה, קראו את הוראות הבטיחות.

A termék telepítése előtt olvassa el a Biztonsági előírásokat!

Prima di installare questo prodotto, leggere le Informazioni sulla Sicurezza.

製品の設置の前に、安全情報をお読みください。

본 제품을 설치하기 전에 안전 정보를 읽으십시오.

Пред да се инсталира овој продукт, прочитајте информацијата за безбедност.

Les sikkerhetsinformasjonen (Safety Information) før du installerer dette produktet.

Przed zainstalowaniem tego produktu, należy zapoznać się z książką "Informacje dotyczące bezpieczeństwa" (Safety Information).

Antes de instalar este produto, leia as Informações sobre Segurança.

Перед установкой продукта прочтите инструкции по технике безопасности.

Pred inštaláciou tohto zariadenia si pečítajte Bezpečnostné predpisy.

Pred namestitvijo tega proizvoda preberite Varnostne informacije.

Antes de instalar este producto, lea la información de seguridad.

Läs säkerhetsinformationen innan du installerar den här produkten.

Statement 1:



DANGER

Electrical current from power, telephone, and communication cables is hazardous.

To avoid a shock hazard:

- **Do not connect or disconnect any cables or perform installation, maintenance, or reconfiguration of this product during an electrical storm.**
- **Connect all power cords to a properly wired and grounded electrical outlet.**
- **Connect to properly wired outlets any equipment that will be attached to this product.**
- **When possible, use one hand only to connect or disconnect signal cables.**
- **Never turn on any equipment when there is evidence of fire, water, or structural damage.**
- **Disconnect the attached power cords, telecommunications systems, networks, and modems before you open the device covers, unless instructed otherwise in the installation and configuration procedures.**
- **Connect and disconnect cables as described in the following table when installing, moving, or opening covers on this product or attached devices.**

To Connect:	To Disconnect:
1. Turn everything OFF.	1. Turn everything OFF.
2. First, attach all cables to devices.	2. First, remove power cords from outlet.
3. Attach signal cables to connectors.	3. Remove signal cables from connectors.
4. Attach power cords to outlet.	4. Remove all cables from devices.
5. Turn device ON.	

Statement 2:



CAUTION:

When replacing the lithium battery, use only IBM Part Number 33F8354 or an equivalent type battery recommended by the manufacturer. If your system has a module containing a lithium battery, replace it only with the same module type made by the same manufacturer. The battery contains lithium and can explode if not properly used, handled, or disposed of.

Do not:

- Throw or immerse into water
- Heat to more than 100° C (212° F)
- Repair or disassemble

Dispose of the battery as required by local ordinances or regulations.

Statement 3:



CAUTION:

When laser products (such as CD-ROMs, DVD drives, fiber optic devices, or transmitters) are installed, note the following:

- Do not remove the covers. Removing the covers of the laser product could result in exposure to hazardous laser radiation. There are no serviceable parts inside the device.
- Use of controls or adjustments or performance of procedures other than those specified herein might result in hazardous radiation exposure.



DANGER

Some laser products contain an embedded Class 3A or Class 3B laser diode. Note the following.

Laser radiation when open. Do not stare into the beam, do not view directly with optical instruments, and avoid direct exposure to the beam.

Class 1 Laser Product
Laser Klasse 1
Laser Klass 1
Luokan 1 Laserlaite
Appareil À Laser de Classe 1

Statement 4:

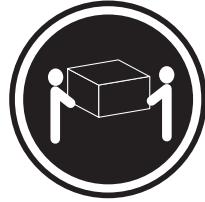

≥ 18 kg (39.7 lb)



≥ 32 kg (70.5 lb)

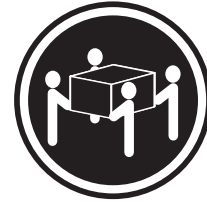

≥ 55 kg (121.2 lb)

CAUTION:
Use safe practices when lifting.

Statement 5:



CAUTION:
The power control button on the device and the power switch on the power supply do not turn off the electrical current supplied to the device. The device also might have more than one power cord. To remove all electrical current from the device, ensure that all power cords are disconnected from the power source.

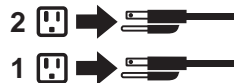

Statement 8:



CAUTION:

Never remove the cover on a power supply or any part that has the following label attached.



Hazardous voltage, current, and energy levels are present inside any component that has this label attached. There are no serviceable parts inside these components. If you suspect a problem with one of these parts, contact a service technician.

Chapter 1. Introduction

Your server supports many optional devices. This *Option Installation Guide* provides information for installing, removing, and connecting the optional devices that your server supports.

In addition to this *Option Installation Guide*, the following IBM @server xSeries 205 Type 8480 documentation is provided with your server:

- *Installation Guide*
This printed publication contains setup and installation instructions.
- *Safety Book*
This multilingual publication is provided in Portable Document Format (PDF) on the *IBM® xSeries Documentation* CD. It contains translated versions of the caution and danger statements that appear in the documentation for your server. Each caution and danger statement has an assigned number, which you can use to locate the corresponding statement in your native language.
- *User's Guide*
This publication is provided in PDF format on the *IBM xSeries Documentation* CD. It contains general information about your server.
- *Hardware Maintenance Manual and Troubleshooting Guide*
This publication is provided in PDF format on the *IBM xSeries Documentation* CD. It contains information to help you solve problems yourself or provide helpful information to a service technician.

Depending on your server model, additional publications might be included on the *IBM xSeries Documentation* CD.

Notices and statements used in this book

The caution statements and the danger statements also appear in the multilingual Safety Information book provided on the *IBM xSeries Documentation* CD. Each statement is numbered for easy reference to the corresponding statement in the safety book.

The notice and statement definitions are as follows:

- **Notes:** These notices provide important tips, guidance, or advice.
- **Important:** These notices provide important information or advice that might help you avoid inconvenient or problem situations.
- **Attention:** These notices indicate possible damage to programs, devices, or data. An attention notice is placed just before the instruction or situation in which damage could occur.
- **Caution:** These statements indicate situations that can be potentially hazardous to you. A caution statement is placed just before the description of a potentially hazardous procedure or situation.

Major components of the IBM @server xSeries 205 Type 8480

The following illustration shows the locations of major components in the IBM @server xSeries 205 Type 8480 server.

Note: The illustrations in this document might look slightly different from your hardware.

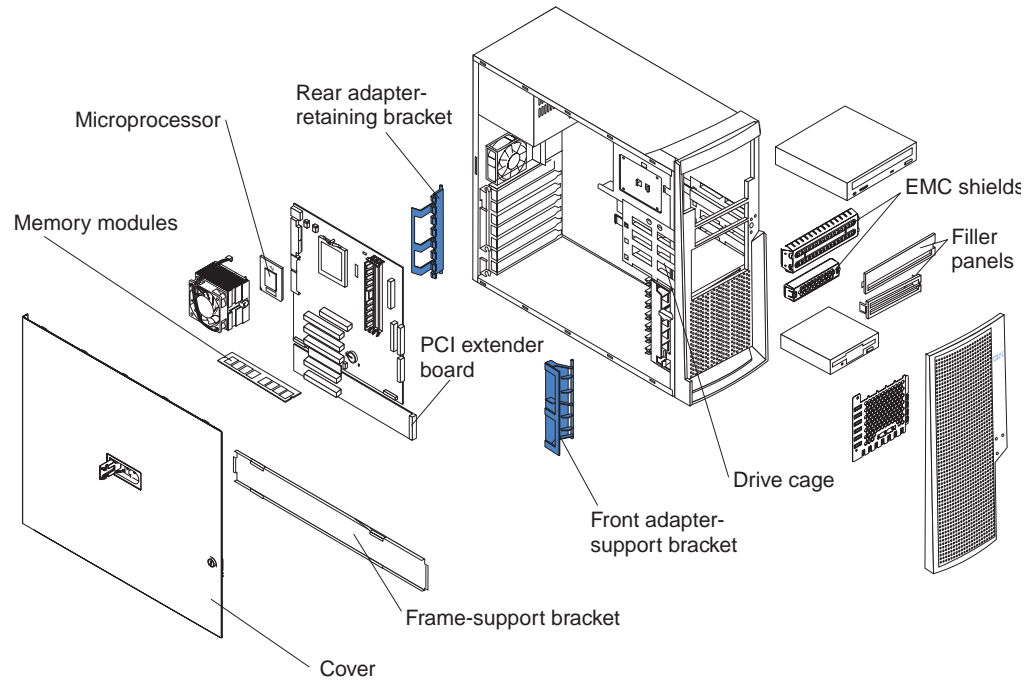

System and PCI extender boards

This illustration identifies parts of the system board and PCI extender board. Depending on installed options, your system board and PCI extender board might look slightly different.

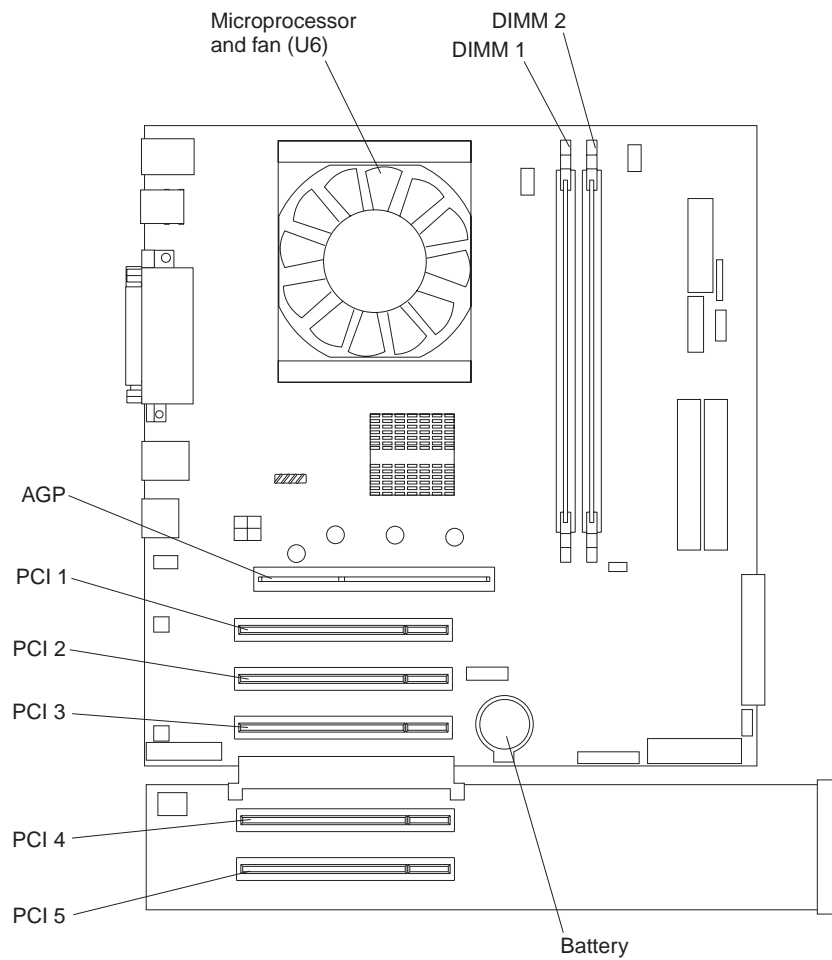

System board internal cable connectors

The following illustration identifies system board connectors for internal cables.

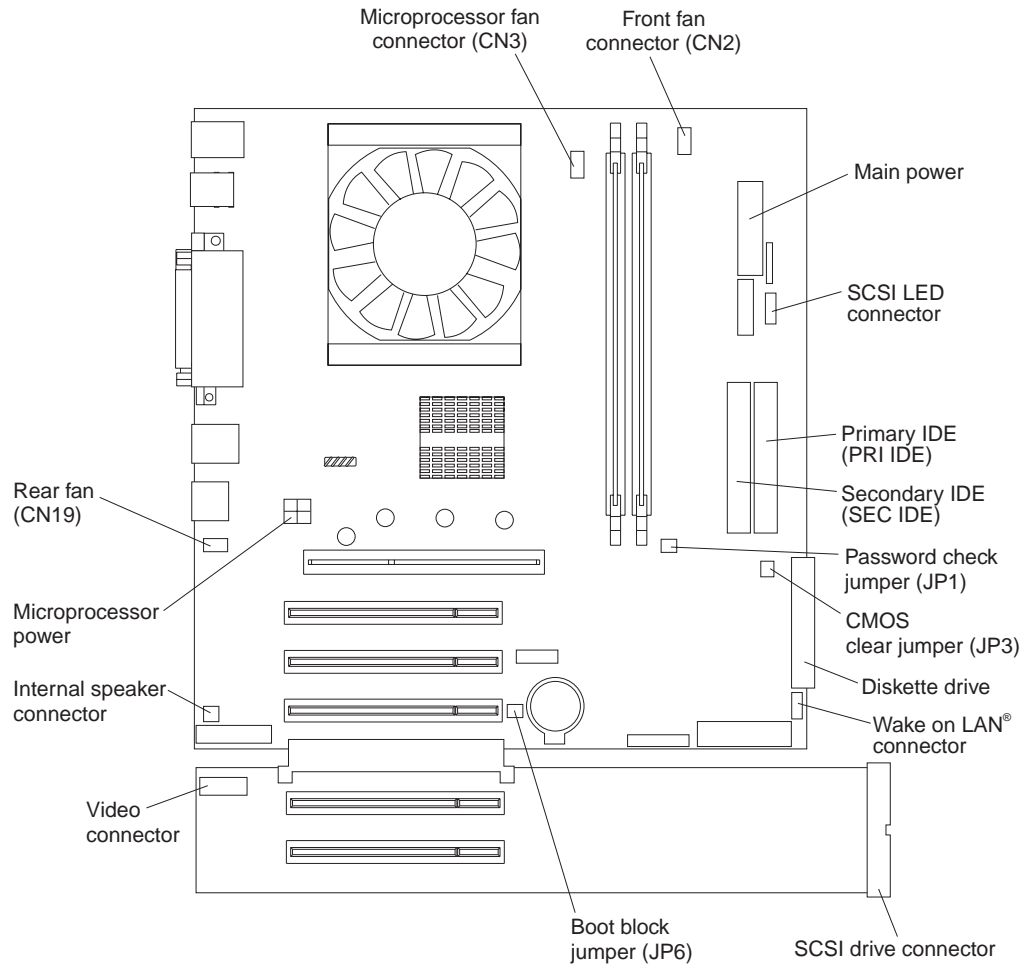

System board external connectors

The following illustration identifies system board connectors for external cables.

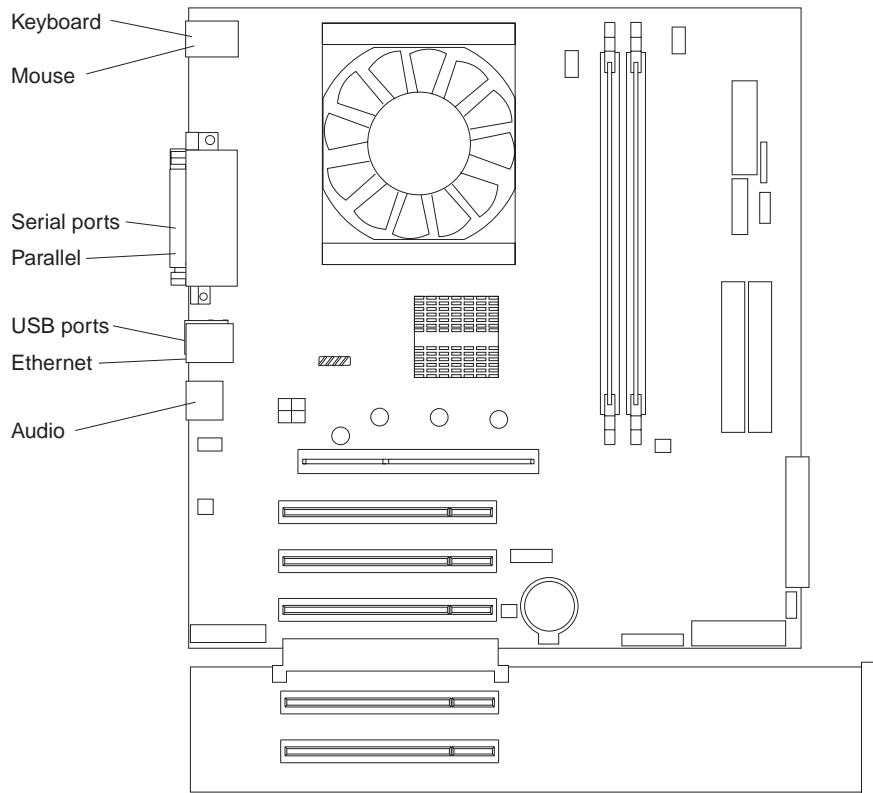

Optional system-management adapter component locations

The following illustration shows the connectors and LEDs for the optional system-management adapter that you can install in PCI slot 1 on the system board.

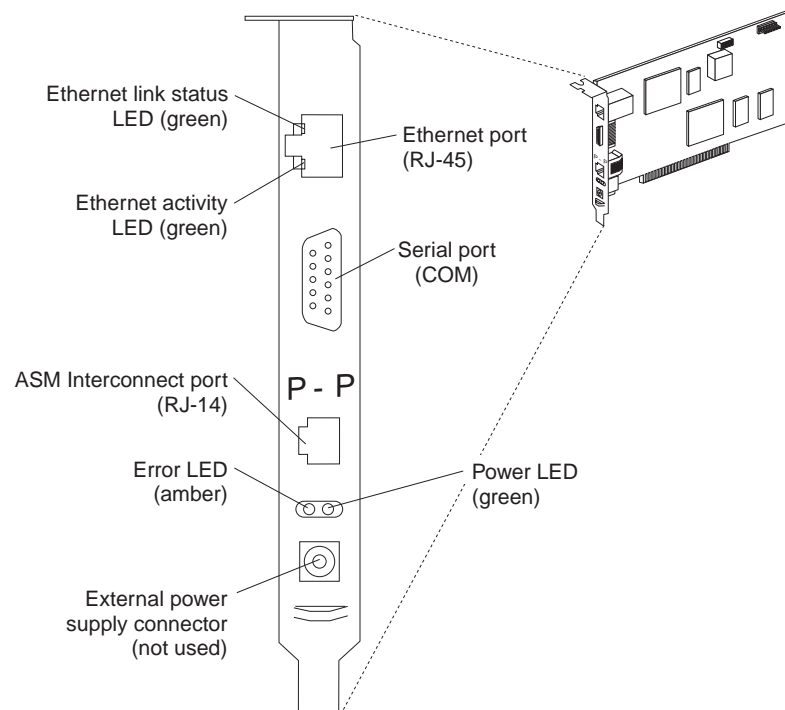

Chapter 2. Installing internal options

This section provides instructions for installing options in an IBM @server xSeries 205 Type 8480.

Installation guidelines

Before you begin to install options in your server, read the following information:

- Read the handling guidelines in "Handling static-sensitive devices", and read the safety statements in "Safety" beginning on page v. These guidelines will help you work safely with your server and options.
- Make sure that you have an adequate number of properly grounded electrical outlets for your server, monitor, and other options that you intend to install.
- Back up all important data before you make changes to disk drives.
- Have a small, flat-blade screwdriver available.
- Before accessing the inside of the IBM @server xSeries 205 Type 8480 server, rotate the two front stabilizing feet a quarter turn towards the server, so they do not break. Before placing the server in an upright position, rotate the two front feet a quarter turn outward from the server. See "Moving the stabilizing feet" on page 8.
- For a list of supported options for your server, go to <http://www.ibm.com/pc/support/> on the World Wide Web.

System reliability considerations

To help ensure proper system cooling and system reliability, make sure that:

- Each of the drive bays has a drive or a filler panel and electromagnetic compatibility (EMC) shield installed.
- There is adequate space around the server to allow the server cooling system to work properly. Leave approximately 51 mm (2 in.) of open space around the front and rear of the server. Do not place objects in front of the fans.
- You have followed the instructions for cabling provided with optional adapters.
- You have replaced a failed fan as soon as possible.

Handling static-sensitive devices

Attention: Static electricity can damage electronic devices, including your server. To avoid damage, keep static-sensitive devices in their static protective package until you are ready to install them.

To reduce the possibility of damage from electrostatic discharge, observe the following precautions.

- Limit your movement. Movement can cause static electricity to build up around you.
- Handle the device carefully, holding it by its edges or its frame.
- Do not touch solder joints, pins, or exposed circuitry.
- Do not leave the device where others can handle and, possibly, damage the device.
- While the device is still in its static-protective package, touch it to an unpainted metal part of the server for at least two seconds. (This drains static electricity from the package and from your body.)

- Remove the device from its package and install it directly into your server without setting the device down. If it is necessary to set the device down, place it in its static-protective package. Do not place the device on your server cover or on a metal table.
- Take additional care when handling devices during cold weather. Heating reduces indoor humidity and increases static electricity.

Moving the stabilizing feet

The four feet on the bottom of the server provide additional stability when the feet are placed in the stabilizing position.

Complete the following steps to place the feet in the stabilizing position:

1. Place the server on its side.
2. Locate the release tab inside the foot; then, lift up on the tab.

Note: The following illustration shows the rear feet located on the bottom rear of the server.

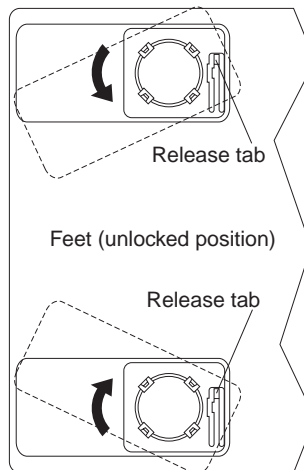

3. Rotate the foot inward to the unlocked position; then, remove the foot from the server.

4. Align the post in the center of the foot with the hole on the bottom of the server and place the foot between the guides as indicated.

Note: The following illustration shows the rear feet located on the bottom rear of the server.

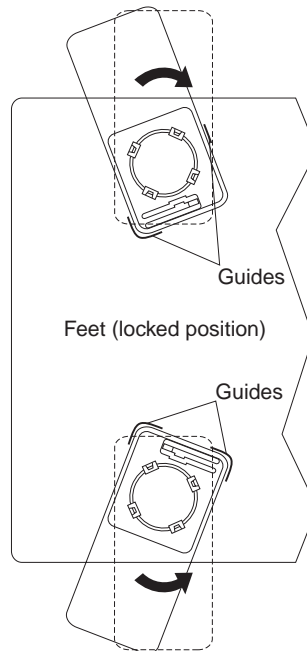

5. Rotate the foot outward until the foot locks into place.
6. Complete steps through for each foot.

Attention: When you need to access the inside of the server to install options, you might find it easier to lay the server on its side. If you do so, make sure the feet are in the horizontal position (see the previous steps). Otherwise, the feet might break off from the server because of the weight of the server.

Removing the side cover

Complete the following steps to remove the side cover of the server.

Note: To remove the side cover, you might find it easier to lay the server on its side. If you do, move the stabilizing feet so that they do not break. See “Moving the stabilizing feet” on page 8.

1. Review the information in “Installation guidelines” on page 7 and “Safety” on page v.
2. Turn off the server and all attached devices.
3. Disconnect all external cables and power cords.

4. Pull the cover-release latch away from the server, and push the side cover toward the rear of the server.

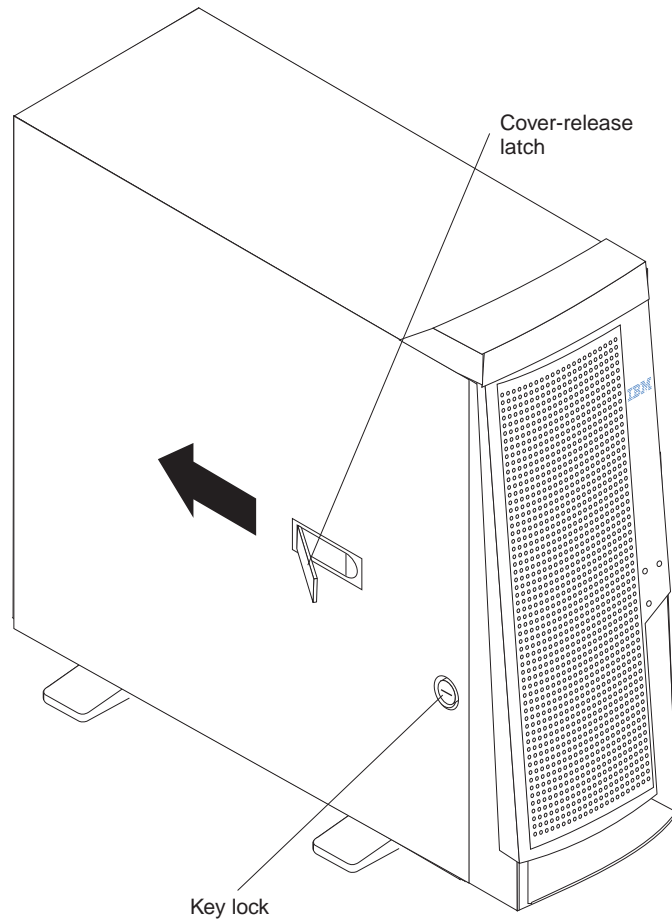

To replace the side cover, see “Replacing the side cover” on page 28.

Attention: For proper cooling and airflow, replace the side cover before turning on the server. Operating the server with the side cover removed might damage server components.

Removing the frame-support bracket

When working with some options, such as hard disk drives, adapters, and memory modules, you must first remove the frame-support bracket to access the existing option.

Complete the following steps to remove the frame-support bracket:

1. Pull out on the rear end of the frame-support bracket approximately 150 mm (6 in.).
2. Pull the rear end of the frame-support bracket away from the server and place the bracket aside.

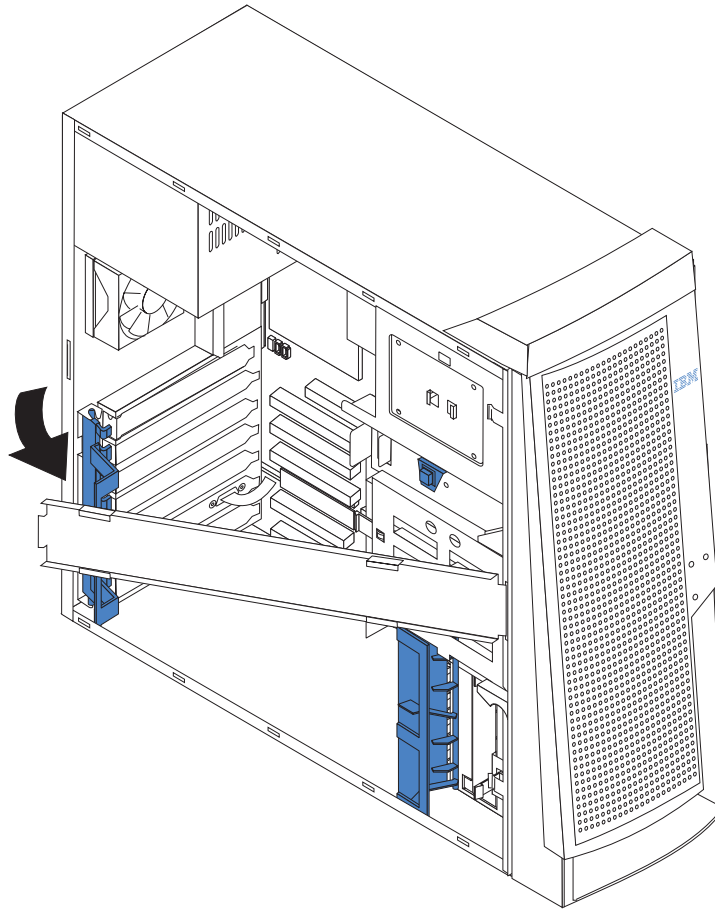

To reinstall the frame-support bracket, reverse the previous steps.

Working with adapters

Your server comes with five 32-bit, 33 MHz PCI adapter connectors or *slots* and one AGP slot. You can install an AGP video adapter in the AGP slot.

See “System and PCI extender boards” on page 3 for the location of PCI expansion slots on the system board and PCI extender board.

Adapter considerations

Before you install adapters, review the following:

- Follow the instructions that come with the adapter in addition to the instructions in this chapter. If you need to change the switch or jumper settings on your adapter, follow the instructions that come with the adapter.
- You can install full-length adapters in all five PCI slots.
- Your server supports 5.0V and universal PCI adapters; it does not support 3.3V adapters.

- Your server uses a rotational interrupt technique to configure PCI adapters. Therefore, you can install a variety of PCI adapters that currently do not support sharing of PCI interrupts.
- PCI slots 1 through 5 are on PCI bus 2.
The system scans the AGP slot and PCI expansion slots 1 through 5 to assign system resources. Then, the system starts devices in the following order, if you have not changed the default startup sequence: the AGP slot, PCI expansion slots 1 and 2, system board integrated drive electronics (IDE) or SCSI devices, and then PCI expansion slots 3 through 5.
- The optional Remote Supervisor Adapter must be installed in PCI slot 1.
- For a list of supported options for your server, go to <http://www.ibm.com/pc/support/> on the World Wide Web.

Installing an adapter

Complete the following steps to install an adapter.

Attention: When you handle static-sensitive devices, take precautions to avoid damage from static electricity. For details about handling these devices, see “Handling static-sensitive devices” on page 7.

1. Review the information in “Safety” beginning on page v.
2. Turn off the server and all attached devices, and disconnect all external cables and power cords; then, remove the side cover. See “Removing the side cover” on page 9.

Note: Check the instructions that come with the adapter for any requirements, restrictions, or cabling instructions. It might be easier to route any cables before you install the adapter.

3. Remove the frame-support bracket. See “Removing the frame-support bracket” on page 10.
4. If you are installing a full-length adapter, rotate the front adapter-retaining bracket to the open position.
5. Rotate the rear adapter-retaining bracket to the open (unlocked) position, and remove it from the server.
6. From the rear of the server, press on the slot cover. Grasp it and pull the expansion-slot cover out of the expansion slot. Store it in a safe place for future use.

Attention: Expansion-slot covers must be installed on all vacant slots. This maintains the electronic emissions standards of the server and ensures proper ventilation of server components.

7. Set any jumpers or switches on the adapter or system board as described by the adapter manufacturer.

- Remove the adapter from the static-protective package, carefully grasp the adapter by the top edge or upper corners, and align it with the expansion slot guides; then, press the adapter *firmly* into the expansion slot.

Note: It is best to move the adapter directly from the static-protective package to the adapter slot. If this is not possible, set the adapter down on its static-protective package on a hard surface. Avoid touching the components and gold-edge connectors on the adapter.

Attention: Be certain that the adapter is correctly seated in the expansion slot before you turn on the server. Incomplete installation of an adapter might damage the system board or the adapter.

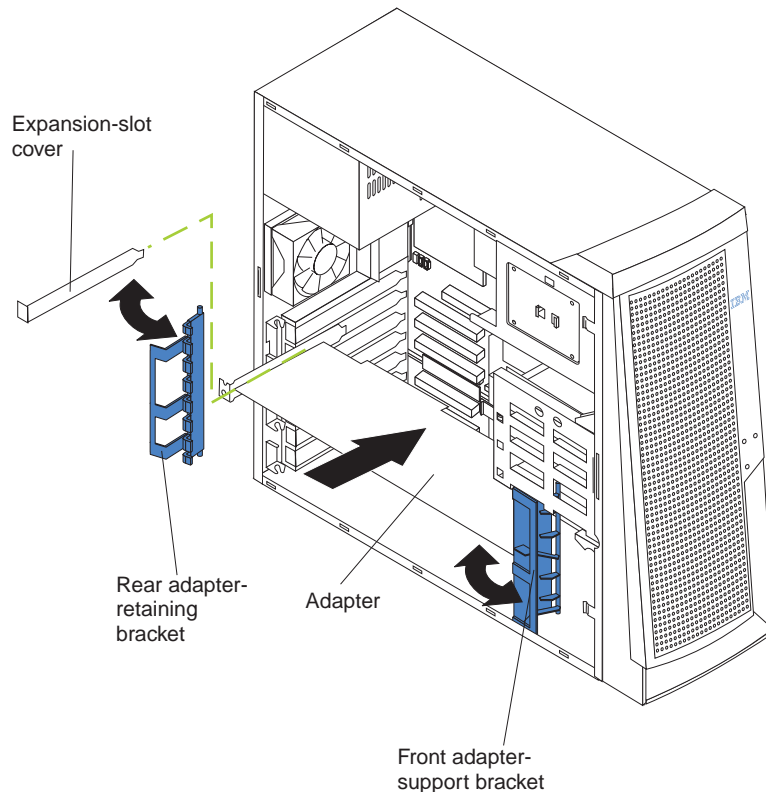

- Connect required cables to the adapter. Route cables so that they do not block airflow from the fans.
 - If you have another adapter to install, repeat steps 1 through 10. If you have another option to install, do so now.
 - If you have installed a full-length adapter, rotate the front adapter-retaining bracket to the closed (locked) position.
 - Reinstall the rear adapter-retaining bracket; then, rotate the bracket to the closed (locked) position.
- Note:** The rear adapter-retaining bracket rests against the side cover. You might find it easier to lay the server on its side to replace the side cover.
- Replace the frame-support bracket.
 - Replace the side cover. See “Replacing the side cover” on page 28 for details.
 - Reconnect the external cables and power cords; then, turn on the attached devices and the server.

Installing a SCSI adapter

Complete the following steps to install a SCSI adapter:

1. Complete steps through of “Installing an adapter” on page 12.
2. Connect the SCSI signal cable to the adapter and one or more of the signal cable connectors to the rear of the SCSI devices.
3. Connect the SCSI activity indicator cable to the adapter and to the SCSI LED connector on the system board. See “System and PCI extender boards” on page 3 for the location of the SCSI LED connector.

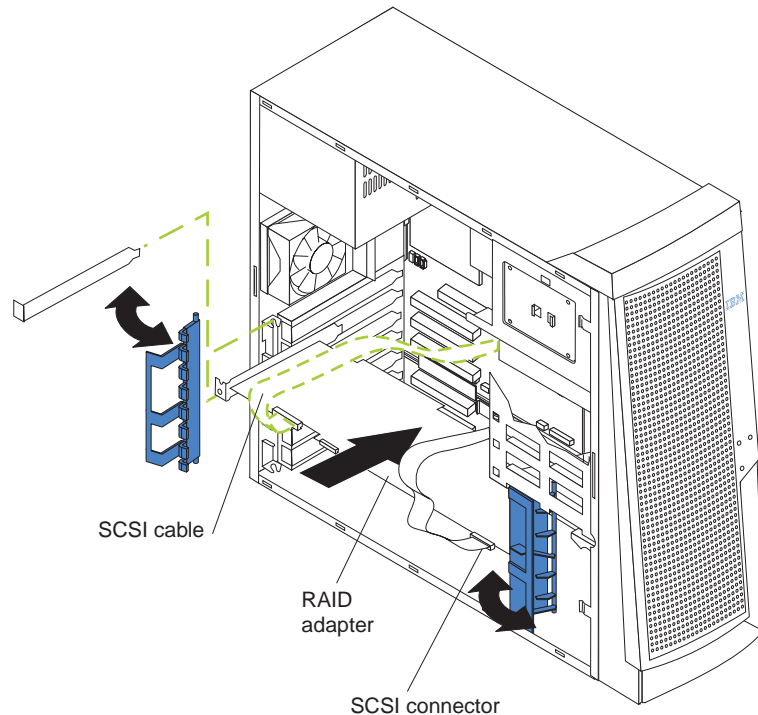

4. If you have other adapters or options to install or remove, do so now.
5. Rotate the front adapter-support bracket to the closed (locked) position.
6. Reinstall the rear adapter-support bracket; then, rotate it to the closed (locked) position.
7. Replace the frame-support bracket.
8. Replace the side cover. See “Replacing the side cover” on page 28 for details.
9. Reconnect the external cables and power cords; then, turn on the attached devices and the server.

Cabling a RAID adapter or single SCSI channel using one hot-swap drive SCSI backplane

You can install an optional RAID adapter in your server to control the internal hot-swap hard disk drives. The illustrations in this section show the cabling for internal hot-swap hard disk drives. You can also cable a RAID adapter to external hard disk drives. See your RAID adapter option documentation for complete instructions for installing a RAID adapter in your server and for additional information about RAID adapters.

One end of the SCSI cable is attached to the connector on the standard SCSI backplane, and the other end is attached to the internal SCSI channel connector on the PCI extender board or RAID adapter.

If you are connecting the server to more than two SCSI channels, you might need to purchase additional SCSI cables. Consult your IBM marketing representative or reseller for additional information about the number and types of cables that your server configuration requires.

The following procedure describes the single-channel cable routing that is necessary when you install a RAID adapter. The illustrations in this section are examples. The cabling that you use for your server depends on your system configuration.

Notes:

1. See the documentation that comes with your adapter for any cabling instructions.
2. Cable identifiers are printed on the cables that come with your server and options. Use these identifiers to connect the cables to the correct connectors. For example, the hard disk drive cables are labeled "HDD option."

Complete the following steps to cable a single SCSI channel on an installed RAID adapter using the standard hot-swap drive SCSI backplane:

1. Determine the number of SCSI channels that you want to use on the RAID adapter.
2. Review the information in "Installation guidelines" on page 7 and "Safety" on page v.
3. Turn off the server and peripheral devices and disconnect all power cords and external cables; then, remove the side cover (see "Removing the side cover" on page 9).
4. If your server comes with a SCSI connector on the PCI extender board, disconnect the SCSI cable from the internal SCSI connector on the PCI extender board.

Attention: When you route the SCSI cable, observe these precautions:

- Do not block the ventilated space in front of the fan assembly.
- Do not route the SCSI cable over the memory board assembly.

5. Route the SCSI cable from the backplane on the hot-swap drive cage (bays 5 to 7) to the internal channel connector on the RAID adapter.

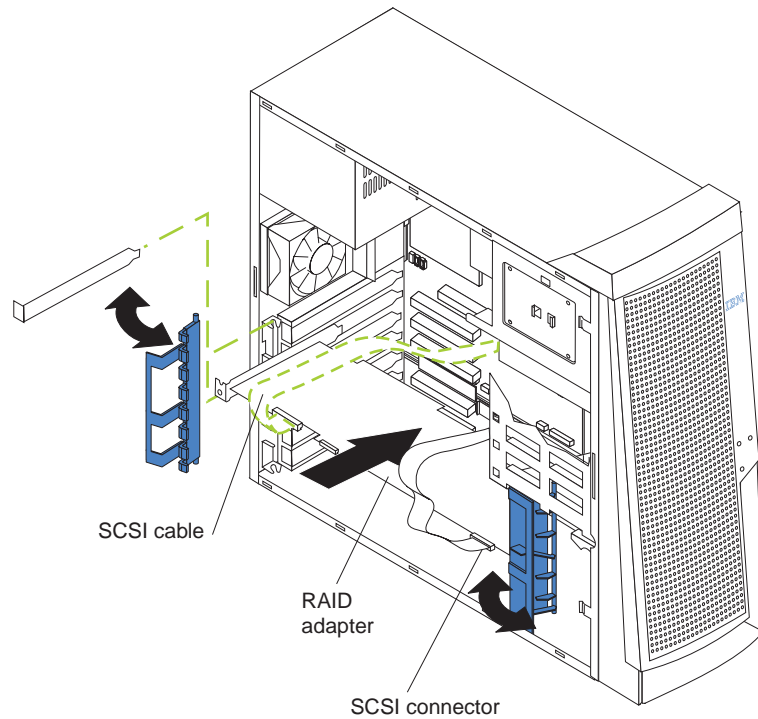

6. If you have other options to install or remove, do so now; otherwise, go to “Replacing the side cover” on page 28.

Installing internal drives

Depending on your server model, you might have one or more of the following drives installed.

- Diskette
- Hard disk
- CD-ROM or DVD-ROM

Internal drive bays

The IBM @server xSeries 205 Type 8480 server comes with an IDE CD-ROM or DVD-ROM drive in bay 1, a 3.5-in., 1.44 MB diskette drive in bay 3, and a hard disk drive installed in bay 4.

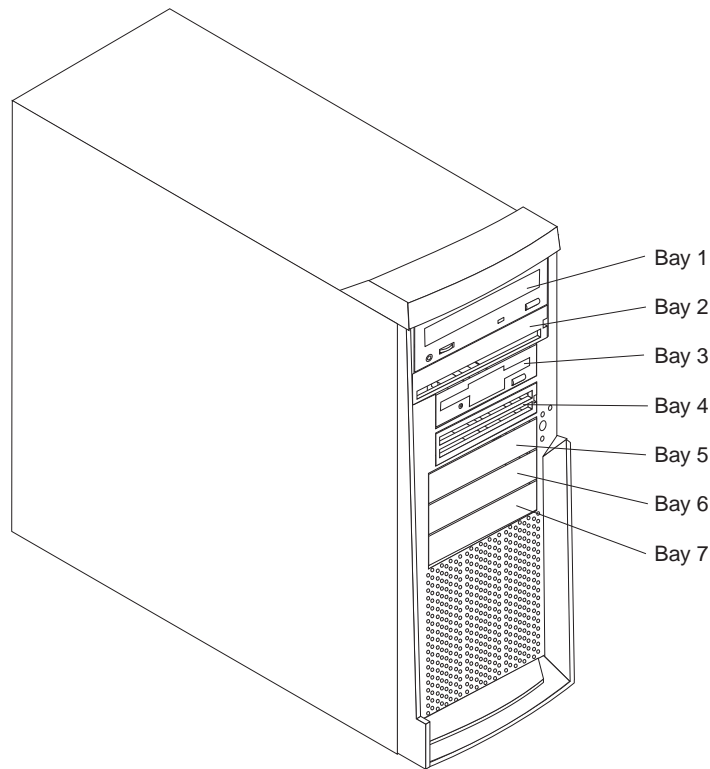

Before you install an internal drive, review the following information:

- Diskette drives, tape drives, CD-ROM, and DVD-ROM drives are examples of removable-media drives. You can install removable-media drives in bays 1, 2, 3, and 4 only.
- You can install a 3.5-in. slim-high, or a 5.25-in. half-high removable-media drive, such as a tape backup drive, in bay 2.
- You can install a 3.5-in. slim-high removable-media drive only in bay 4.
- The IBM xSeries 205 Type 8480 server supports only one diskette drive.
- To install a 3.5-in. drive in a 5.25-in. bay, you must use a 5.25 in. conversion kit, supplied with your option.

Note: Only 3.5-in. options that come with proper mounting hardware are supported in the 5.25-in. bays.

- The electromagnetic interference (EMI) integrity and cooling of the server are protected by having all bays and PCI slots covered or occupied. When you install a drive or PCI adapter, save the EMC shield and filler panel from the bay or the PCI adapter slot cover in the event you later remove the option.
- For a complete list of supported options for your server, go to <http://www.ibm.com/pc/support/> on the World Wide Web.

Preinstallation steps

Before you install drives in your server, verify that you have all the cables and other equipment specified in the documentation that comes with the drive. You might also need to perform certain preinstallation activities. Some of the steps are required only during the initial installation of an option.

Before installing a drive in bays 1, 2, 3, or 4, do the following:

1. Read "Safety" beginning on page v, "Handling static-sensitive devices" on page 7, and the documentation that comes with your drive.
2. Choose the bay in which you want to install the drive.
3. Check the instructions that come with the drive to see if you need to set any switches or jumpers on the drive. If you are installing a SCSI device, be sure to set the SCSI ID for that device.

Power and signal cables for internal drives

Your server uses cables to connect IDE and SCSI devices to the power supply and to the system board. The following cables are provided:

- Four-wire power cables connect the drives to the power supply. At the end of these cables are plastic connectors of various sizes that can be attached to different drives.
- Flat signal cables, also called ribbon cables, connect IDE, SCSI, and diskette drives to the system board. Two or three sizes of ribbon cables come with your server:
 - The wider IDE signal cable has two or three connectors.
 - If the cable has three connectors, one of these connectors is attached to the drive, one is a spare, and the third is attached to the primary or secondary IDE connector on the system board.
 - If the cable has two connectors, one of these connectors is attached to the hard disk drive, and the other is attached to the primary or secondary IDE connector on the system board.
 - Note:** The CD-ROM drive is attached to an ATA 66 signal cable. The hard disk drive is attached to an ATA 100 signal cable. ATA 66 and ATA 100 signal cables are color-coded. The blue connector attaches to the system board. The black connector attaches to the primary device. If the cable has a gray middle connector, it attaches to the secondary device. If you are installing a hard disk drive, you must change the switch setting on the CD-ROM drive to secondary and change the connector used for the CD-ROM drive to the gray middle connector.
 - The narrower signal cable has two connectors, one to attach to the diskette drive, and the other to attach to the connector (FDD1) on the system board.
 - If your server comes with a SCSI connector on the extender board and SCSI hard disk drive, an Ultra160 twisted ribbon cable connects the internal Ultra160 SCSI hard disk drive to the SCSI connector on the PCI extender board. This cable has two additional connectors for attaching more internal SCSI devices.

To locate connectors on the system board, see "System board internal cable connectors" on page 4.

Review the following information before connecting power and signal cables to internal drives:

- The drives that are preinstalled in your server come with power and signal cables attached. If you replace any drives, remember which cable is attached to which drive.
- When you install a drive, ensure that the drive connector at one end of the signal cable is connected to the drive and that the drive connector at the other end is connected to the system board.
- If you have only one IDE device on a cable, it must be set as a primary device.

- If two IDE devices are used on a single cable, one must be designated as the primary device and the other as the secondary device; otherwise, the server might not recognize some of the IDE devices. The primary and secondary designation is determined by switch or jumper settings on each IDE device.
- If two IDE devices are on a single cable and only one is a hard disk drive, the hard disk drive must be set as a primary device.
- You must also set the SCSI ID for any SCSI device that you install in your server. Each SCSI device has its own methods and considerations for setting the SCSI ID. See the instructions that come with the SCSI device for details about setting the SCSI ID for the SCSI device.

Installing a drive in bay 1, 2, 3, or 4

Do the following to install a drive in bay 1, 2, 3, or 4:

Attention: When handling static-sensitive devices, take precautions to avoid damage from static electricity. For details on handling these devices, see “Handling static-sensitive devices” on page 7.

1. Read the information in “Preinstallation steps” on page 17.
2. Turn off the server and attached devices and disconnect the external cables and power cords.
3. Remove the side cover. See “Removing the side cover” on page 9 for details.
4. Remove the frame-support bracket. See “Removing the frame-support bracket” on page 10.
5. Use a screwdriver to pry the filler panel and EMC shield away from the server.

Note: If you are installing a drive that contains a laser, observe the following safety precaution.

Statement 3:



CAUTION:

When laser products (such as CD-ROMs, DVD drives, fiber optic devices, or transmitters) are installed, note the following:

- **Do not remove the covers. Removing the covers of the laser product could result in exposure to hazardous laser radiation. There are no serviceable parts inside the device.**
- **Use of controls or adjustments or performance of procedures other than those specified herein might result in hazardous radiation exposure.**



DANGER

Some laser products contain an embedded Class 3A or Class 3B laser diode. Note the following.

Laser radiation when open. Do not stare into the beam, do not view directly with optical instruments, and avoid direct exposure to the beam.

Class 1 Laser Product
Laser Klasse 1
Laser Klass 1
Luokan 1 Laserlaite
Appareil À Laser de Classe 1

6. Touch the static-protective package containing the drive to any unpainted metal surface on the server; then, remove the drive from the package and place it on a static-protective surface.
7. Set any jumpers or switches on the drive according to the documentation that comes with the drive.
8. You might find it easier to install the new drive into the appropriate opening on the front, and then attach the cables.
9. If you are installing a 5.25-in. drive in bay 2, push the drive into the bay; then, use the two screws to attach the drive to the drive cage.

10. If you are installing a 3.5-in. drive in bay 2, you must attach the 5.25-in conversion kit, supplied with your option, to the 3.5-in. drive.

Note: You can install only a 3.5-in. device in bay 4.

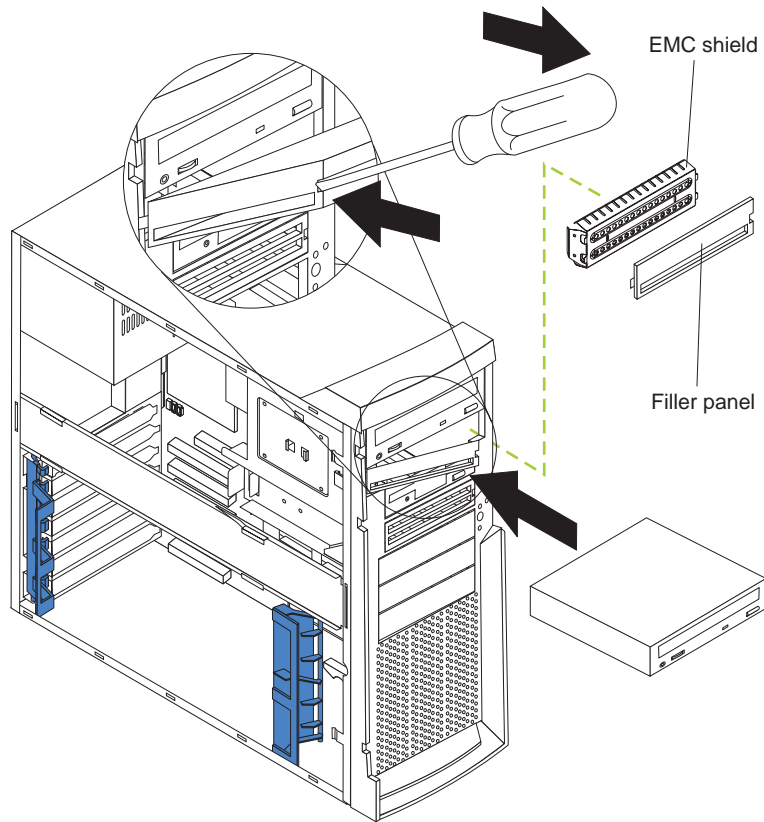

11. If the drive is an IDE device, connect one end of the IDE signal cable into the back of the drive and the other end of the cable into the IDE connector on the system board. For the location of the IDE connectors, see “System board internal cable connectors” on page 4. If the drive is a SCSI device, connect one end of the SCSI signal cable into the back of the drive and the other end of the cable into the 68-pin connector on the PCI connector on the extender board.

Note: Route the signal cable so that it does not block the airflow to the rear of the drives or over the microprocessor.

12. Connect the power cable to the back of the drive. The connectors are keyed and can be inserted only one way.
13. If you have other options to install or remove, do so now.
14. Replace the frame-support bracket.
15. Replace the side cover. See “Replacing the side cover” on page 28 for details.
16. Reconnect the external cables and power cords; then turn on the attached devices and the server.

Installing a non-hot-swap hard disk drive in bay 5, 6, or 7

Bays 5, 6, and 7 are in the drive cage. The drive cage is located just above the front adapter-support bracket.

Note: You might find it useful to work with the server laying on its side.

Complete the following steps to install a non-hot-swap hard disk drive in bay 5, 6, or 7:

1. Review the safety precautions listed in "Safety" beginning on page v.
2. Read the information in "Preinstallation steps" on page 17.
3. Turn off the server and all attached devices. Disconnect all external cables and power cords; then remove the side cover. See "Removing the side cover" on page 9 for details.
4. Remove the frame-support bracket and disconnect the fan cable from the connector on the system board. See "Removing the frame-support bracket" on page 10 for details.
5. If your server has hard disk drives preinstalled in the drive cage, disconnect the power and signal cables from the rear of the drives.
6. Rotate the drive cage out of the server until it locks into place with the drive-cage-retention tab. The open ends of the drive slots and installed drives will face you.
Note: Ensure that the drive cage locks into place over the drive-cage-retention tab by pressing the drive cage all the way up.
7. Attach the guide rails to the side of the drive using the screws provided. If you obtained your optional drive from IBM, the guide rails are blue plastic.
8. Slide the drive into the drive cage until the plastic tabs on the drive guide rails lock into place in the drive cage. Clear any cables that might impede the replacement of the drive cage.
9. Press in on the drive-cage-retention tab, and rotate the cage back into the server.

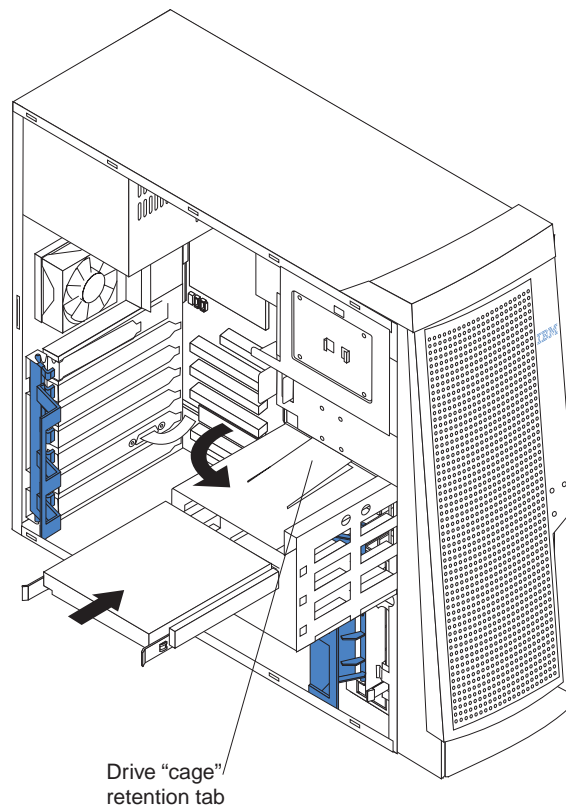

10. Connect the power and signal cables to the rear of each drive.
Note: Route the signal cable so that it does not block the airflow to the rear of the drives or over the microprocessor.
11. If you have other options to install or remove, do so now.

12. Replace the frame-support bracket.
13. Replace the side cover. See “Replacing the side cover” on page 28 for details.
14. Reconnect the external cables and power cords; then, turn on the attached devices and the server.

Installing a hot-swap hard disk drive in bay 5, 6, or 7

If your server is a hot-swap model, you can replace a failed hard disk drive without turning off the server. Therefore, you can continue to operate your server while a hard disk drive is removed or installed. To do this, you must install a hot-swap hard disk drive. If a hot-swap disk drive is connected to an optional hot-swap RAID controller and if your hot-swap drive becomes defective, the RAID controller can rebuild the data from that drive onto another hot-swap drive. See the information that comes with your RAID controller for details.

Each hot-swap drive has a green hard disk drive activity LED and an amber hard disk drive status LED. When the hard disk drive activity LED is flashing, the controller is accessing the hard disk drive. When this occurs, the SCSI activity LED on the front of the server is also lit. The hard disk drive activity LED is illustrated and described in the *User's Guide*. If the hard disk drive status LED for a drive is lit continuously, that individual drive is faulty and requires replacement. When the hard disk drive status LED indicates a drive fault, you can replace a hot-swap drive without turning off the server.

Each hot-swap drive that you plan to install comes mounted in a hot-swap-drive tray. The drive must have a single connector attachment (SCA) connector. Hot-swap-drive trays come with hot-swap drives.

The hot-swap bays are connected to a SCSI backplane. This backplane is the printed circuit board behind the bay. The backplane controls the SCSI IDs for the hot-swap drives.

The following illustration shows the hot-swap-drive backplane component locations, as viewed from the front of the server.

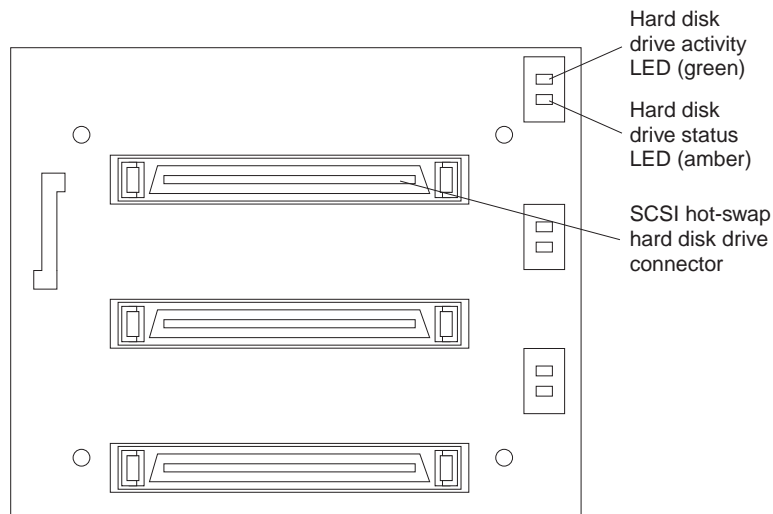

Note: The hard disk drive activity LED and hard disk drive status LED on the backplane match the hard disk drive activity LED and hard disk drive status LED on the hot-swap drive.

The following illustration shows the rear connectors on the hot-swap-drive backplane, as viewed from the rear of the server.

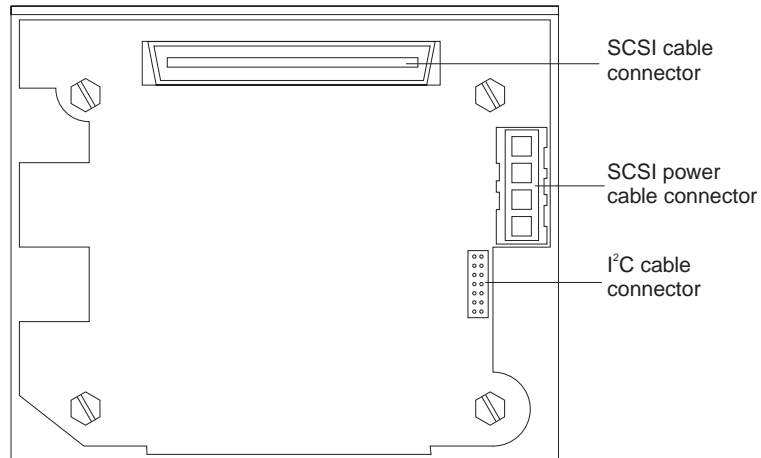

When you install hot-swap hard disk drives, install them in the following order: bay 7, bay 6, and bay 5.

Attention:

- When you handle static-sensitive devices, take precautions to avoid damage from static electricity. For details on handling these devices, see “Handling static-sensitive devices” on page 7.
- To maintain proper system cooling, do not operate the server for more than 10 minutes without either a drive or a filler panel installed in each bay.

Complete the following steps to install a hot-swap hard disk drive in bay 5, 6, or 7.

Note: You do not have to turn off the server to install hot-swap hard disk drives in these bays.

1. Read the information in “Preinstallation steps” on page 17.
2. Remove the filler panel from one of the empty hot-swap bays by inserting your finger into the depression at the left side of the filler panel and pulling it away from the server.

3. Install the hard disk in the hot-swap bay:
 - a. Ensure that the tray handle is open (that is, perpendicular to the drive).
 - b. Align the drive-tray assembly with the guide rails in the bay.
 - c. Gently push the drive-tray assembly into the bay until the drive stops.
 - d. Push the tray handle to the closed (locked) position.

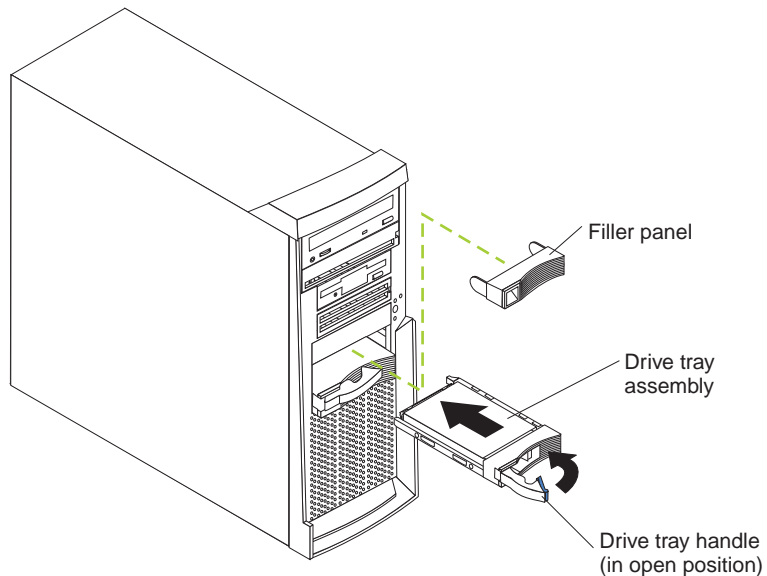

- e. Check the hard disk drive status LED to verify that the hard disk drive is operating properly.

If the amber disk drive status LED for the drive is lit continuously, that individual drive is faulty and needs to be replaced. If the green hard disk drive activity LED is flashing, the drive is being accessed.

Note: If your server has a RAID adapter, you might need to reconfigure your disk arrays after installing hard disk drives. See the information that comes with your RAID adapter.
4. If you have other options to install or remove, do so now.

Installing memory modules

You can increase the amount of memory in your server by installing memory modules. Your IBM xSeries 205 Type 8480 server uses industry-standard dual inline memory modules (DIMMs).

Complete the following steps to install a DIMM:

Attention: When handling static-sensitive devices, take precautions to avoid damage from static electricity. For details on handling these devices, see “Handling static-sensitive devices” on page 7.

1. Review the safety precautions listed in the "Safety" beginning on page v.
2. Turn off the server and all attached devices. Disconnect all external cables and power cords; then remove the side cover. See “Removing the side cover” on page 9 for details.
3. Remove the frame-support bracket. See “Removing the frame-support bracket” on page 10.

4. Touch the static-protective package containing the DIMM to any unpainted metal surface on the server. Then remove the new DIMM from the package.
5. Open the retaining clips and, if necessary, remove any existing DIMM.
6. Turn the DIMM so that the pins align correctly with the connector, and firmly press the DIMM straight down into the connector by applying pressure on both ends of the DIMM simultaneously. The retaining clips snap into the locked position when the DIMM is firmly seated in the connector.

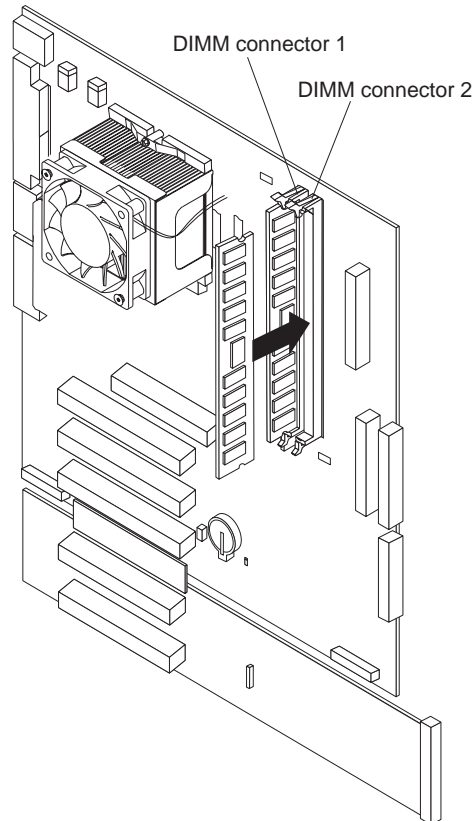

7. If there is a gap between the DIMM and the retaining clips, the DIMM has not been correctly installed. Open the retaining clips, remove the DIMM, then reinsert it.
8. If you have other options to install or remove, do so now.
9. Replace the frame-support bracket.
10. Replace the side cover. See "Replacing the side cover" on page 28.
11. Reconnect the external cables and power cords. Turn on the attached devices, and turn on the server.

Installing a security rope clip

To help prevent theft, you can add a security rope clip and cable to your server.

Complete the following steps to install the rope clip:

1. Review the safety precautions listed in "Safety" beginning on page v.
2. Turn off the server and all attached devices. Disconnect all external cables and power cords; then, remove the side cover. See "Removing the side cover" on page 9 for details.

3. Use a screwdriver to remove the two metal knockouts.
4. Insert the rope clip through the rear panel; then attach and tighten the nuts.
5. Thread the cable through the rope clip and around an object that is not part of or permanently secured to the building structure or foundation and from which the cable cannot be removed. Fasten the cable ends together with a lock. After you add the security cable, be certain it does not interfere with other cables connected to the server.

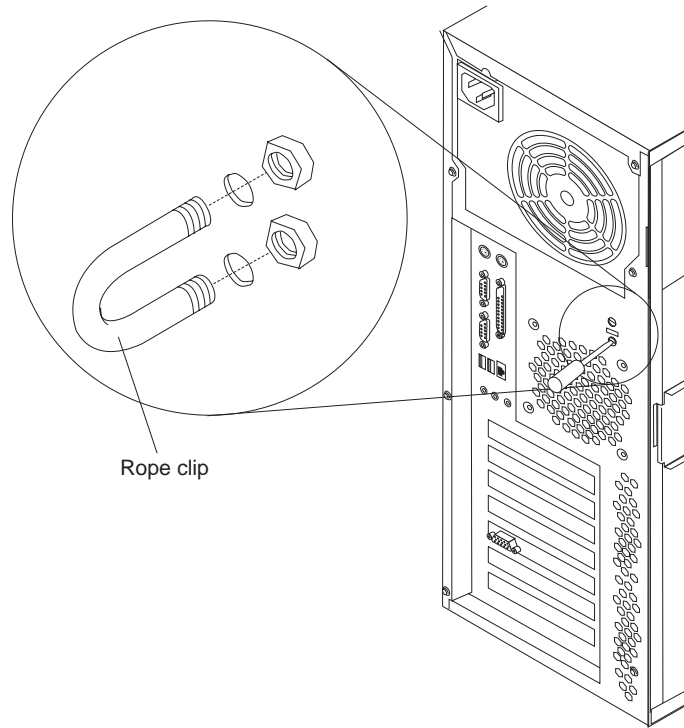

6. Reconnect the external cables and power cords, and turn on the attached devices, and then the server.

Replacing the side cover

Complete the following steps to replace the side cover of the server.

Note: If you removed the frame-support bracket, reinstall it before you replace the side cover. See “Removing the frame-support bracket” on page 10 for details.

1. Clear any cables that might impede the replacement of the side cover.
2. Install the side cover by placing it into position on the server. Be certain the notches on the underside of the side cover match up to the holes along the sides of the server. Press down on the cover-release latch button as you close the cover-release latch to lock the side cover.

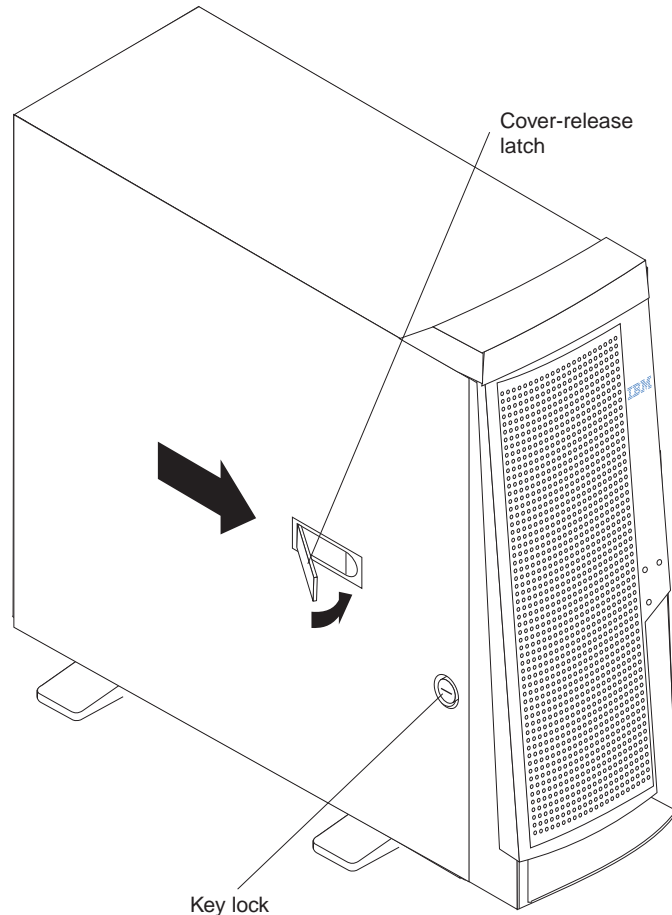

3. If you have not done so already, make sure that the two front stabilizing feet are rotated outward so that they properly support the server. Rotate each individual foot outward 90 degrees.
4. Reconnect the external cables and power cords to the server; then, connect the power cords to electrical outlets.
5. Turn on the attached devices; then, turn on the server.

Replacing the battery

When replacing the battery, you must replace it with a lithium battery of the same type from the same manufacturer. To avoid possible danger, read and follow the information in “Safety” on page v.

To order replacement batteries, call 1-800-772-2227 within the United States, and 1-800-465-7999 or 1-800-465-6666 within Canada. Outside the U.S. and Canada, call your IBM reseller or IBM marketing representative.

Note: After you replace the battery, you must reconfigure your server and reset the system date and time.

Complete the following steps to replace the battery:

1. Follow any special handling and installation instructions supplied with the replacement battery.
2. Turn off the server and all attached devices. Disconnect all external cables and power cords; then, remove the side cover and frame-support bracket. See "Removing the side cover" on page 9 and "Removing the frame-support bracket" on page 10.
3. Complete the following steps to remove the battery:
 - a. Use one fingernail to press the top of the battery clip away from the battery. The battery pops up when released.
 - b. Use your thumb and index finger to lift the battery from the socket.

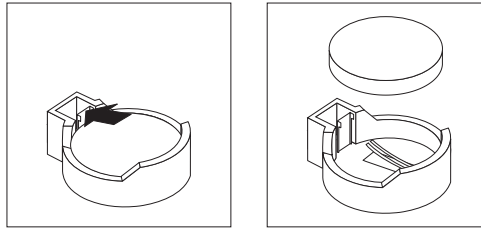

4. Complete the following steps to insert the new battery:
 - a. Tilt the battery so that you can insert it into the socket on the side opposite the battery clip.
 - b. Press the battery down into the socket until it clicks into place. Make sure the battery clip holds the battery securely.

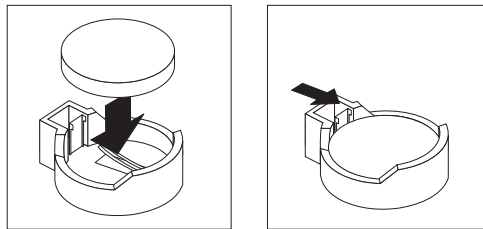

5. Replace the frame-support bracket and the side cover and connect the cables. See "Replacing the side cover" on page 28.
6. Turn on the server.
7. Start the Configuration/Setup Utility program and set configuration parameters.
 - Set the system date and time.
 - Set passwords if necessary.
 - Save the configuration.

Chapter 3. Connecting external options

You can connect a number of optional external devices to the connectors on the rear of the server, such as a printer, a keyboard, or a mouse.

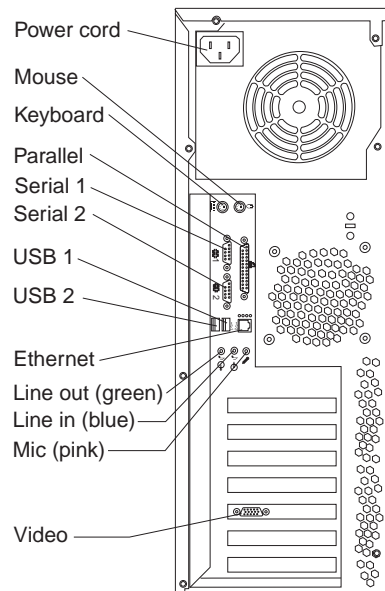

To attach an external device:

1. Read “Installation guidelines” on page 7, review the safety precautions listed in Statement 1 and Statement 5 in “Safety” on page v, and read the documentation that comes with your options.
2. Be sure that your server and all attached devices are turned off.
3. Follow the instructions that come with the option to prepare it for installation and to connect it to the server.

This section provides information about the input/output connectors on the rear of your server. These connectors are:

- One mouse
- One keyboard
- One parallel
- Two serial
- One Ethernet
- Two USB
- Line in
- Line out
- Microphone
- One video (Optional multiple connectors on some models)

Video connector

Your server uses a graphics controller located on the PCI extender card. The video connector is located on the rear of your server. See the illustration on page 31 for the location of this connector.

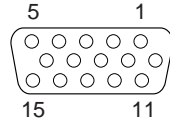

Some models come with a digital video interface (DVI) connector for connecting a digital monitor.

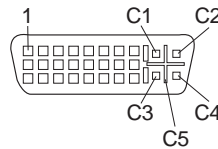

Keyboard connector

Your server has one keyboard connector. See the illustration on page 31 for its location.

Note: If you attach a standard (non-USB) keyboard to the keyboard connector, the USB ports and devices are disabled during the power-on self-test (POST).

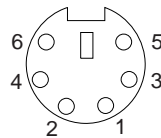

Mouse connector

Your server has one mouse connector that supports a mouse or other pointing device. The mouse connector is located on the rear of your computer. For the location, see the illustration on page 31.

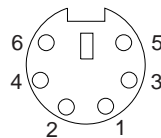

Parallel connector

Your server has one 25-pin, female D-shell parallel connector. This connector supports three standard Institute of Electrical and Electronics Engineers (IEEE) 1284 modes of operation: standard parallel port (SPP), enhanced parallel port (EPP), and extended capability port (ECP). See the illustration on page 31 for the location of this connector.

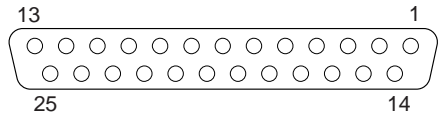

Use the Configuration/Setup Utility program to configure the parallel connector as bidirectional. With this configuration, data can be read from and written to a device. In bidirectional mode, the server supports the ECP and EPP modes.

For instructions to view or change the parallel-connector assignment, see the *User's Guide* on the *IBM Documentation CD*.

Serial connectors

Your server has two standard 9-pin D-shell serial connectors: Serial connector 1 and Serial connector 2. See page 31 for their location.

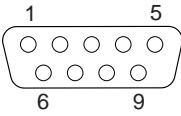

Gigabit Ethernet port

Your server comes with an integrated Gigabit Ethernet controller. This controller provides an interface for connecting to 10-Mbps, 100-Mbps, or 1000-Mbps networks and provides full-duplex (FDX) capability, which enables simultaneous transmission and reception of data on the Ethernet local area network (LAN).

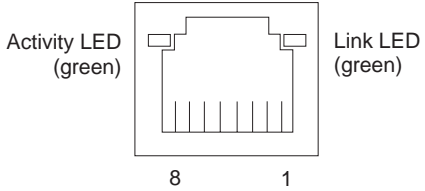

To access the Ethernet port, connect a Category 3, 4, or 5 unshielded twisted-pair (UTP) cable to the RJ-45 connector on the rear of your server.

Note: The 100BASE-TX/1000BASE-T Fast Ethernet standard requires that the cabling in the network be Category 5 or higher.

The Ethernet (RJ-45) connector has two LEDs. The Ethernet-link status LED is on the left. When this green light is on, there is an active connection on the Ethernet port. The Ethernet transmit/receive activity LED is on the right. When this amber LED is on, there is activity between the server and the network. These LEDs have the same functions as the Ethernet-link status LED and the Ethernet transmit/receive activity LED on the rear of the server (see the *User's Guide*).

Configuring the Gigabit Ethernet controller

The Ethernet controller is a PCI Plug and Play device. You do not need to set any jumpers or configure the controller for your operating system before you use the Ethernet controller. However, you must install a device driver to enable your operating

system to address the Ethernet controller. The device drivers are provided on the *Device Drivers and IBM Enhanced Diagnostics CD*.

When you connect your server to the network, the Ethernet controller automatically detects the data-transfer rate (10 Mbps, 100 Mbps, or 1000 Mbps) on the network and then sets the controller to operate at the appropriate rate. In addition, if the Ethernet ports that your server is connected to support auto-negotiation, the Gigabit Ethernet controller will set the appropriate duplex state. That is, the Ethernet controller will adjust to the network data rate, whether the data rate is standard Ethernet (10BASE-T), Fast Ethernet (100BASE-TX/1000BASE-T), half duplex (HDX), or full duplex (FDX). The controller supports half-duplex (HDX) and full-duplex (FDX) modes at both speeds.

High-performance Ethernet modes

Your Ethernet controller supports optional modes, such as teaming, load balancing, fault tolerance, and virtual LANs, which provide higher performance, security, and throughput for your server. These modes apply to the integrated Ethernet controller and to the controllers on supported Ethernet adapters.

Universal Serial Bus (USB) connectors

Your server has two Universal Serial Bus (USB) 2.0 connectors for optional telephony and multimedia devices. USB 2.0 devices configure automatically with Plug and Play technology. See the illustration on page 31 for the location of the USB 2.0 connectors.

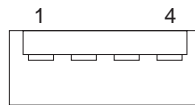

Notes:

1. If you attach a standard (non-USB) keyboard to the keyboard connector, the USB 2.0 connectors and devices will be disabled during the power-on self-test.
2. If you install a USB keyboard that has a mouse connector, the USB keyboard emulates a mouse, and you will not be able to disable the mouse settings in the Configuration/Setup Utility program.

USB cables

Use a 4-pin USB cable to connect external devices to USB connectors.

USB 2.0 technology transfers data at up to 128 megabits per second (Mbps) with a maximum of 127 external devices and a maximum signal distance of 5 meters (16 ft) per segment. You must use devices that support USB 2.0 in order to obtain this maximized data transfer rate.

Audio connectors

The audio connectors are used to connect external audio equipment to your server. See the illustration on page 31 for the location of these connectors.

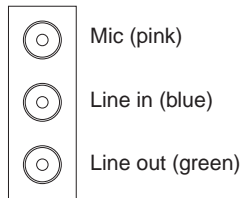

Line out

This connector is used to send audio signals from the server to external devices, such as powered speakers with built-in amplifiers, headphones, multimedia keyboards, or the audio Line in connector on a stereo system.

Note: The internal speaker in your server is disabled when any device is attached to this connector.

Line in

This connector is used to accept audio signals from external devices, such as line output from external audio equipment into the server sound system.

Microphone

This connector is used to connect a microphone to your server when you want to record sounds on the hard-disk drive or use speech recognition software.

Optional system-management adapter ports

The following illustration shows the connectors and LEDs for the Remote Supervisor Adapter (optional system-management adapter). See the Remote Supervisor Adapter option documentation for detailed information about the advanced system management (ASM) interconnect network.

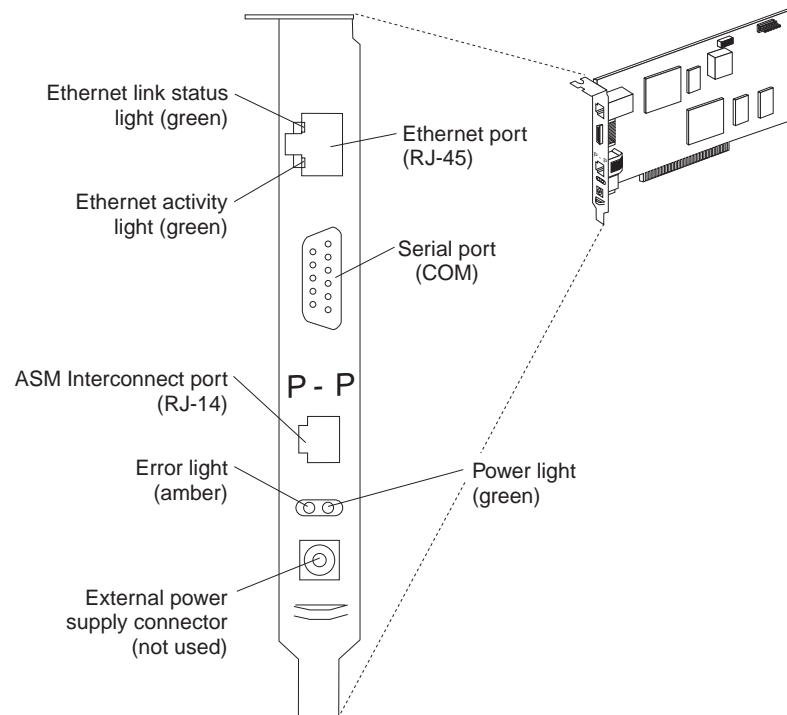

Appendix A. Notices

This publication was developed for products and services offered in the U.S.A.

IBM may not offer the products, services, or features discussed in this document in other countries. Consult your local IBM representative for information on the products and services currently available in your area. Any reference to an IBM product, program, or service is not intended to state or imply that only that IBM product, program, or service may be used. Any functionally equivalent product, program, or service that does not infringe any IBM intellectual property right may be used instead. However, it is the user's responsibility to evaluate and verify the operation of any non-IBM product, program, or service.

IBM may have patents or pending patent applications covering subject matter described in this document. The furnishing of this document does not give you any license to these patents. You can send license inquiries, in writing, to:

*IBM Director of Licensing
IBM Corporation
North Castle Drive
Armonk, NY 10504-1785
U.S.A.*

INTERNATIONAL BUSINESS MACHINES CORPORATION PROVIDES THIS PUBLICATION "AS IS" WITHOUT WARRANTY OF ANY KIND, EITHER EXPRESS OR IMPLIED, INCLUDING, BUT NOT LIMITED TO, THE IMPLIED WARRANTIES OF NON-INFRINGEMENT, MERCHANTABILITY OR FITNESS FOR A PARTICULAR PURPOSE. Some jurisdictions do not allow disclaimer of express or implied warranties in certain transactions, therefore, this statement may not apply to you.

This information could include technical inaccuracies or typographical errors. Changes are periodically made to the information herein; these changes will be incorporated in new editions of the publication. IBM may make improvements and/or changes in the product(s) and/or the program(s) described in this publication at any time without notice.

Any references in this publication to non-IBM Web sites are provided for convenience only and do not in any manner serve as an endorsement of those Web sites. The materials at those Web sites are not part of the materials for this IBM product, and use of those Web sites is at your own risk.

IBM may use or distribute any of the information you supply in any way it believes appropriate without incurring any obligation to you.

Edition notice

© COPYRIGHT INTERNATIONAL BUSINESS MACHINES CORPORATION, 2002.
All rights reserved.

Note to U.S. Government Users — Documentation related to restricted rights — Use, duplication or disclosure is subject to restrictions set forth in GSA ADP Schedule Contract with IBM Corp.

Trademarks

The following terms are trademarks of International Business Machines Corporation in the United States, other countries, or both:

Active PCI	ServerGuide
Alert on LAN	ServerProven
e-business logo	Update Connector
IBM	Wake on LAN
Predictive Failure Analysis	X-Architecture
PS/2	xSeries
ServeRAID	

Lotus, Lotus Notes, SmartSuite, and Domino are trademarks of Lotus Development Corporation and/or IBM Corporation in the United States, other countries, or both.

Intel, Celeron, LANDesk, MMX, NetBurst, Pentium, Pentium II Xeon, Pentium III Xeon, and Xeon are trademarks of Intel Corporation in the United States, other countries, or both.

Microsoft, Windows, and Windows NT are trademarks of Microsoft Corporation in the United States, other countries, or both.

UNIX is a registered trademark of The Open Group in the United States and other countries.

Java and all Java-based trademarks and logos are trademarks or registered trademarks of Sun Microsystems, Inc. in the United States, other countries, or both.

Linux is a registered trademark of Linus Torvalds.

Other company, product, or service names may be trademarks or service marks of others.

Important notes

Processor speeds indicate the internal clock speed of the microprocessor; other factors also affect application performance.

CD-ROM drive speeds list the variable read rate. Actual speeds vary and are often less than the maximum possible.

When referring to processor storage, real and virtual storage, or channel volume, KB stands for approximately 1000 bytes, MB stands for approximately 1 000 000 bytes, and GB stands for approximately 1 000 000 000 bytes.

When referring to hard disk drive capacity or communications volume, MB stands for 1 000 000 bytes, and GB stands for 1 000 000 000 bytes. Total user-accessible capacity may vary depending on operating environments.

Maximum internal hard disk drive capacities assume the replacement of any standard hard disk drives and population of all hard disk drive bays with the largest currently supported drives available from IBM.

Maximum memory may require replacement of the standard memory with an optional memory module.

IBM makes no representation or warranties regarding non-IBM products and services that are ServerProven, including but not limited to the implied warranties of merchantability and fitness for a particular purpose. These products are offered and warranted solely by third parties.

IBM makes no representations or warranties with respect to non-IBM products. Support (if any) for the non-IBM products is provided by the third party, not IBM.

Some software may differ from its retail version (if available), and may not include user manuals or all program functionality.

Electronic emission notices

IBM @server xSeries 205 Type 8480

Federal Communications Commission (FCC) statement

Note: This equipment has been tested and found to comply with the limits for a Class B digital device, pursuant to Part 15 of the FCC Rules. These limits are designed to provide reasonable protection against harmful interference in a residential installation. This equipment generates, uses, and can radiate radio frequency energy and, if not installed and used in accordance with the instructions, may cause harmful interference to radio communications. However, there is no guarantee that interference will not occur in a particular installation. If this equipment does cause harmful interference to radio or television reception, which can be determined by turning the equipment off and on, the user is encouraged to try to correct the interference by one or more of the following measures:

- Reorient or relocate the receiving antenna.
- Increase the separation between the equipment and receiver.
- Connect the equipment into an outlet on a circuit different from that to which the receiver is connected.
- Consult an IBM authorized dealer or service representative for help.

Properly shielded and grounded cables and connectors must be used in order to meet FCC emission limits. Proper cables and connectors are available from IBM authorized dealers. IBM is not responsible for any radio or television interference caused by using other than recommended cables and connectors or by unauthorized changes or modifications to this equipment. Unauthorized changes or modifications could void the user's authority to operate the equipment.

This device complies with Part 15 of the FCC Rules. Operation is subject to the following two conditions: (1) this device may not cause harmful interference, and (2) this device must accept any interference received, including interference that may cause undesired operation.

Responsible party:

International Business Machines Corporation
New Orchard Road
Armonk, NY 10504

Telephone: 1-919-543-2193

FC Tested To Comply
With FCC Standards
FOR HOME OR OFFICE USE

Industry Canada Class B emission compliance statement

This Class B digital apparatus complies with Canadian ICES-003.

Avis de conformité à la réglementation d'Industrie Canada

Cet appareil numérique de la classe B est conforme à la norme NMB-003 du Canada.

European Union EMC Directive conformance statement

This product is in conformity with the protection requirements of EU Council Directive 89/336/EEC on the approximation of the laws of the Member States relating to electromagnetic compatibility. IBM cannot accept responsibility for any failure to satisfy the protection requirements resulting from a nonrecommended modification of the product, including the fitting of non-IBM option cards.

This product has been tested and found to comply with the limits for Class B Information Technology Equipment according to CISPR 22/European Standard EN 55022. The limits for Class B equipment were derived for typical residential environments to provide reasonable protection against interference with licensed communication devices.

Japanese Voluntary Control Council for Interference (VCCI) statement

この装置は、情報処理装置等電波障害自主規制協議会（VCCI）の基準に基づくクラスB情報技術装置です。この装置は、家庭環境で使用することを目的としていますが、この装置がラジオやテレビジョン受信機に近接して使用されると、受信障害を引き起こすことがあります。
取扱説明書に従って正しい取り扱いをして下さい。

Power cords

For your safety, IBM provides a power cord with a grounded attachment plug to use with this IBM product. To avoid electrical shock, always use the power cord and plug with a properly grounded outlet.

IBM power cords used in the United States and Canada are listed by Underwriter's Laboratories (UL) and certified by the Canadian Standards Association (CSA).

For units intended to be operated at 115 volts: Use a UL-listed and CSA-certified cord set consisting of a minimum 18 AWG, Type SVT or SJT, three-conductor cord, a maximum of 15 feet in length and a parallel blade, grounding-type attachment plug rated 15 amperes, 125 volts.

For units intended to be operated at 230 volts (U.S. use): Use a UL-listed and CSA-certified cord set consisting of a minimum 18 AWG, Type SVT or SJT, three-conductor cord, a maximum of 15 feet in length and a tandem blade, grounding-type attachment plug rated 15 amperes, 250 volts.

For units intended to be operated at 230 volts (outside the U.S.): Use a cord set with a grounding-type attachment plug. The cord set should have the appropriate safety approvals for the country in which the equipment will be installed.

IBM power cords for a specific country or region are usually available only in that country or region.

IBM power cord part number	Used in these countries and regions
13F9940	Argentina, Australia, China (PRC), New Zealand, Papua New Guinea, Paraguay, Uruguay, Western Samoa
13F9979	Afghanistan, Algeria, Andorra, Angola, Austria, Belgium, Benin, Bulgaria, Burkina Faso, Burundi, Cameroon, Central African Rep., Chad, China (Macau S.A.R.), Czech Republic, Egypt, Finland, France, French Guiana, Germany, Greece, Guinea, Hungary, Iceland, Indonesia, Iran, Ivory Coast, Jordan, Lebanon, Luxembourg, Malagasy, Mali, Martinique, Mauritania, Mauritius, Monaco, Morocco, Mozambique, Netherlands, New Caledonia, Niger, Norway, Poland, Portugal, Romania, Senegal, Slovakia, Spain, Sudan, Sweden, Syria, Togo, Tunisia, Turkey, former USSR, Vietnam, former Yugoslavia, Zaire, Zimbabwe
13F9997	Denmark
14F0015	Bangladesh, Burma, Pakistan, South Africa, Sri Lanka
14F0033	Antigua, Bahrain, Brunei, Channel Islands, China (Hong Kong S.A.R.), Cyprus, Dubai, Fiji, Ghana, India, Iraq, Ireland, Kenya, Kuwait, Malawi, Malaysia, Malta, Nepal, Nigeria, Polynesia, Qatar, Sierra Leone, Singapore, Tanzania, Uganda, United Kingdom, Yemen, Zambia
14F0051	Liechtenstein, Switzerland
14F0069	Chile, Ethiopia, Italy, Libya, Somalia
14F0087	Israel
1838574	Thailand
6952301	Bahamas, Barbados, Bermuda, Bolivia, Brazil, Canada, Cayman Islands, Colombia, Costa Rica, Dominican Republic, Ecuador, El Salvador, Guatemala, Guyana, Haiti, Honduras, Jamaica, Japan, Korea (South), Liberia, Mexico, Netherlands Antilles, Nicaragua, Panama, Peru, Philippines, Saudi Arabia, Suriname, Taiwan, Trinidad (West Indies), United States of America, Venezuela

Index

A

adapter
 considerations 11
 full length 11
 installing 12
 PCI bus 12
 system management 36
audio connectors 35

B

battery replacement 28
bay
 1, 2, 3, and 4 19
 5, 6, and 7 21
 drive 16
 filler panel 19
bi-directional parallel port configuration 33

C

cable
 external 5
cables
 internal drives 18
 power 18
 power and signal 18
 signal 18
 universal serial bus (USB) 34
cabling
 RAID adapter 14
 SCSI channel 15
 SCSI device 21, 22
CD-ROM drive
 installing 14
components
 hardware 2
 location of 2
 major 2
connecting external options 31
connector
 audio 35
 DVI-I monitor 32
 Ethernet 33
 input/output (I/O) 32
 keyboard 32
 mouse 32
 parallel 32
 serial 33
 universal serial bus (USB) 34
 video 32
connectors
 external 5
cooling 7
cover

removing 9
replacing 28

D

DIMM
 connector locations 25
 installing memory 25
 retaining clips 26
diskette drive
 installing 14, 19, 21
drive
 bay filler panel 19
 installation 19, 21
 installing 14
 preinstallation 17

E

Ethernet
 Gigabit controller 33
 high performance modes 34
 modes 34
 port 33
 teaming 34
Ethernet controller
 configuring 34
Ethernet port 33
expansion bays
 location 16
 type 16

F

Fast Ethernet 34
filler panel 19

H

handling static-sensitive devices 7
hard disk drive, installing 14
hardware, major components 2
hubs, USB 34

I

input/output (I/O)
 connectors 31
 ports 31
installing
 adapters 12
 battery 28
 drive in bays 1, 2, 3, or 4 19

- drives in bays 5, 6, or 7 21
- hot-swap hard disk drives 23
- internal drives 14
- memory modules 25
- non-hot-swap hard disk drives 21
- options 7
- security U-bolt 26

installing drives

- bays 5, 6, and 7 21

internal

- cable connectors 4
- drive bays 16
- drives, installing 14

K

keyboard, connector 32

M

memory

- DIMM 25
- installing 25
- modules 25

modes, Ethernet 34

mouse, connector 32

N

notes, important 38

notices

- attention 1
- caution 1
- important 1

P

parallel port

- bi-directional configuration 33
- connector 32
- connector pin-assignments 32

PCI

- expansion slots 11

pin-assignments

- video 32

port

- Ethernet 33
- keyboard 32
- mouse 32
- parallel 32
- universal serial bus (USB) 34

power cords 40

R

RAID adapter 14

reliability, system 7

removable media drives, installing 14

removing

- side cover 9
- support-bracket assembly 10

replacing

- battery 28
- side cover 28

retaining clips, DIMM 26

S

security U-bolt 26

serial connectors 33

side cover, removing 9

small computer systems interface (SCSI)

- adapter 14
- device 21

stabilizing feet 8

statements

- attention 1
- caution 1
- important 1

static-sensitive devices, handling 7

support-bracket assembly, removing 10

system board

- connectors 4
- options 3

system management

- adapter 5

system reliability 7

T

tape drive, installing 14

trademarks 38

U

universal serial bus (USB)

- cables 34
- connectors 34
- ports 34

V

video

- connector 32
- DVI-I connector 32



Part Number: 59P2107

Printed in the United States of America.

59P2107

