

IBM System Storage DS3000, DS4000, and DS5000

*Hard Disk Drive and Storage Enclosure
Installation and Migration Guide*



Note

Before using this information and the product it supports, be sure to read the general information in “Notices and statements in this document” on page x and “Notices” on page 149.

This edition applies to version 10 modification 60 of the IBM DS Storage Manager, and to all subsequent releases and modifications until otherwise indicated in new editions.

This edition replaces GA32-0962-04.

© **Copyright IBM Corporation 2008, 2013.**

US Government Users Restricted Rights – Use, duplication or disclosure restricted by GSA ADP Schedule Contract with IBM Corp.

Contents

Figures	v
--------------------------	----------

Tables	vii
-------------------------	------------

Introduction	ix
-------------------------------	-----------

Using this document	ix
What's new in this guide	ix
Receiving product updates and support notifications	x
DS Storage Subsystem installation and support guides	x
Notices and statements in this document	x

Chapter 1. Prerequisites to adding capacity and hard disk drive migration . 1

Preparing the storage subsystem.	1
Preparing to export and import drives.	3
Determining the supported number of drives and drive loop pairs	4
Verifying controller, NVSRAM, and ESM firmware compatibility	9
Storage subsystem profile.	12
Physical View pane.	13
Upgrading ESM and controller firmware	13
Drive migration limitations	14
Verifying hard disk drive model compatibility.	17
Viewing the product ID and model of a hard disk drive	19
Bringing storage subsystems and drive loops into optimal state	21
Intermixing storage enclosures	21
Setting enclosure IDs for enclosures in DS4000 and DS5000 storage subsystems	29
DS4000 Fibre Channel and Serial ATA Intermix premium feature.	31
Intermixing EXP100 and EXP710 storage enclosures	32
Intermixing EXP395 and EXP810 storage enclosures	37
Intermixing EXP520 and EXP810 storage enclosures	37
Intermixing EXP810 with EXP100 and EXP710 storage enclosures	38
Intermixing EXP810 and EXP5000 storage enclosures	43
Intermixing EXP5000 and EXP5060 storage enclosures	43
Intermixing storage enclosures for DS4000 and DS5000 storage subsystems	44

Chapter 2. Adding or migrating hard disk drives . 57

Considerations	57
Handling static-sensitive devices	58
Adding new hard disk drives	58

Migrating hard disk drives	59
Step 1: Preliminary activities.	60
Step 2: Verifying drive migration enable settings	61
Step 3: Placing drives offline.	62
Step 4: Removing drives	63
Step 5: Inserting drives	64
Migrating arrays within the same storage subsystem	66
Using the drive migration disable script to add new drives	70
Step 1: Disabling the drive migration settings	70
Step 2: Inserting drives	71
Step 3: Re-enabling the drive migration settings	71

Chapter 3. Adding or migrating storage enclosures . 75

Considerations	75
Step 1: Preliminary activities.	77
Adding new storage enclosures with new hard disk drives	78
Migrating storage enclosures with hard disk drives that have defined logical drive configurations	79
Step 2: Preparing and backing up the drives	80
Step 3: Shutting down and moving the storage enclosures	81
Step 4: Verifying the drive migration enable settings	82
Step 5: Installing and setting storage enclosure IDs and speeds	83
Step 6: Cabling, turning on, and verifying storage enclosure operation.	84
Cabling the new enclosures	84
Connecting storage enclosures at the end (bottom) of a drive loop	86
Connecting storage enclosures in the middle of a drive loop	92
Connecting storage enclosures at the beginning (top) of a drive loop	97
Returning the drive/loop channel to optimal state	101
DS4000 and DS5000 storage subsystem Fibre Channel drive loop schemes	102
Storage subsystem SAS drive channel/loop schemes for enclosures in a DS3000 or DS3500 configuration	106
Storage subsystem SAS drive channel/loop schemes for enclosures in a DCS3700 or in a DCS3700 with Performance Module Controllers configuration	107
Cabling EXP100, EXP710, and EXP810 storage enclosures in DS4700 and DS4800 configurations	109
Step 7: Inserting drives and cabling additional storage enclosures	112
Step 8: Inserting hard disk drives and placing logical drives online	113

Chapter 4. Upgrading a storage subsystem controller 115

Upgrade considerations 115
 Host attachment and premium feature entitlements 115
 Storage firmware migration. 116
 Alternative procedure to upgrade a storage subsystem controller enclosure 117
 Supported upgrades 118
 Configuration behavior after an upgrade and storage subsystem replacement 123
 Storage subsystem behavior when turning on the power with no drives attached 126
Performing an upgrade 126
 Performing an upgrade from a DS4700 or DS4800 storage subsystem to a DS5000 storage subsystem 134
 Redeploying the original storage subsystem 142
 Redeployment limitations 142
 Configuration behavior in a redeployed storage subsystem 142

Appendix. Getting information, help, and service 145

Before you call 145
Using the documentation 145
Finding Storage Manager software, controller firmware, and readme files 145
Getting help and information from the World Wide Web 146
Software service and support 147
Hardware service and support 147

Taiwan Contact Information 147
Fire suppression systems 147

Notices 149

Trademarks 151
Important notes 152
Particulate contamination 153
Documentation format 153
Electronic emission notices 154
 Federal Communications Commission (FCC)
 Class A Statement 154
 Industry Canada Class A Emission Compliance Statement 154
 Avis de conformité à la réglementation d'Industrie Canada 154
 Australia and New Zealand Class A Statement 154
 European Union EMC Directive Conformance Statement 154
 Taiwan Class A Electronic Emission Statement 155
 Germany Electromagnetic Compatibility Directive 155
 People's Republic of China Class A Electronic Emission Statement 156
 Japan Voluntary Control Council for Interference (VCCI) Class A Statement 156
 Japan Electronics and Information Technology Industries Association (JEITA) Statement 156
 Korea Communications Commission (KCC) Class A Statement 157

Index 159

Figures

1. Supported intermixed EXP100 and EXP710 storage enclosure loop configuration (1 of 3)	33
2. Supported intermixed EXP100 and EXP710 storage enclosure loop configuration (2 of 3)	34
3. Supported but not best practice intermixed EXP100 and EXP710 storage enclosure loop configuration (3 of 3)	35
4. Unsupported intermixed EXP100 and EXP710 storage enclosure loop configuration (1 of 2)	36
5. Unsupported intermixed EXP100 and EXP710 storage enclosure loop configuration (2 of 2)	37
6. Supported intermixed DS4000 storage subsystem connected to EXP710 and EXP810 storage enclosure loop configuration	41
7. Supported intermixed DS4000 storage subsystem connected to EXP710 and EXP810 storage enclosure loop configuration	42
8. Best practice intermixed DS4000 storage subsystem connected to EXP710 and EXP810 storage enclosure loop configuration	43
9. Best practice intermixed EXP5000 and EXP5060 storage enclosure drive/loop cable configuration	44
10. Use all drive channel ports when connecting storage enclosures	45
11. Use all drive channel ports when connecting storage enclosures	47
12. Supported cabling for an intermix of EXP100, EXP710, and EXP810 storage enclosures (example 1)	49
13. Supported cabling for an intermix of EXP100, EXP710, and EXP810 storage enclosures (example 2)	50
14. Unsupported cabling for an intermix of EXP100, EXP710, and EXP810 storage enclosures (example 1)	51
15. Unsupported cabling for an intermix of EXP100, EXP710, and EXP810 storage enclosures (example 2)	52
16. Supported cabling to EXP420/EXP520/EXP810/EXP5000 storage enclosure port 1B	53
17. Unsupported cabling to the EXP420/EXP520/EXP810/EXP5000 storage enclosure port	54
18. Supported cabling to the EXP500/EXP100/EXP700/EXP710 storage enclosure ports	55
19. Subsystem Management Logical/Physical View of exported drives	63
20. Drive CRU assembly	64
21. Best practice for reordering a defined array by using empty bays in one storage enclosure	67
22. Best practice for reordering a defined array by using empty bays in two storage enclosures	67
23. Reordering multiple defined arrays across previously used bays in two storage enclosures	68
24. Subsystem Management Logical/Physical View of missing logical drives (controller firmware 7.xx.xx.xx or later)	68
25. Subsystem Management Logical/Physical View of missing logical drives (controller firmware before 7.xx.xx.xx)	69
26. EXP100, EXP500, EXP700, EXP710, EXP395/EXP420/EXP520/EXP810/EXP5000 storage enclosure ID and speed switches	79
27. Example of adding storage enclosure positions within a drive loop	85
28. Cabling an additional EXP700/EXP710/EXP100/EXP500 storage enclosure	89
29. Cabling an additional EXP5000, EXP520, EXP395, EXP810, or EXP420 storage enclosure	90
30. Cabling an additional EXP3000, EXP3512, or EXP3524 storage enclosure	91
31. Cabling an additional EXP5060 storage enclosure	92
32. Cabling an additional storage enclosure to the middle of the drive loop in a DS5000 storage subsystem	96
33. Cabling an additional storage enclosure to the middle of the drive loop in a DS3000 storage subsystem configuration	97
34. Cabling an additional storage enclosure to the top of the drive loop in a DS5000 storage subsystem configuration	100
35. Cabling an additional storage enclosure to the top of the drive loop in a DS3000 storage subsystem configuration	101
36. Best practice cable loop scheme for connecting storage devices	102
37. Alternative cable loop scheme for connecting storage devices	103
38. Alternative cable loop scheme for connecting storage devices	104
39. Unsupported cable loop scheme for connecting storage devices (1 of 2)	105
40. Unsupported cable loop scheme for connecting storage devices (2 of 2)	106
41. Supported EXP710, EXP810, and EXP100 storage enclosure intermix configuration in a DS4700 or DS4800 storage subsystem	110
42. Unsupported EXP710, EXP810, and EXP100 storage enclosure intermix configuration in a DS4700 or DS4800 storage subsystem	111
43. Cabling variations when EXP100, EXP710, and EXP810 storage enclosures are intermixed behind a DS4800 storage subsystem	112
44. Firmware compatibility flowchart for a storage subsystem upgrade	129
45. Firmware compatibility flowchart for a storage subsystem upgrade (continued)	130

46. Firmware compatibility flowchart for a DS4700 or DS4800 to a DS5000 storage subsystem upgrade 138

Tables

1. Supported drives and drive loop pairs in storage subsystems	4	18. EnableDriveMigration.scr file listing	72
2. Machine types, supported controller firmware, and supported Storage Manager software	9	19. DisableDriveMigration.scr file listing	73
3. Compatible storage enclosure ESM firmware level by machine type and model number	12	20. Connecting storage enclosures at the end (bottom) of the best practice cable loop scheme	87
4. Drive migration limitations based on controller firmware levels	15	21. Connecting storage enclosures at the end (bottom) of a SAS drive cable loop scheme in a DS3000, DS3500, DCS3700 or DCS3700 with Performance Module Controllers configuration.	88
5. Snapshot of profile information identifying the product ID of the drive in bay 12 of enclosure ID 1	20	22. Connecting storage enclosures at the middle of the best practice cable loop scheme	94
6. Mixed storage enclosure compatibility for DS3000 storage subsystem models.	23	23. Connecting storage enclosures at the middle of a SAS drive cable loop scheme in a DS3000, DS3500, DCS3700, or DCS3700 with Performance Module Controllers configuration.	95
7. Mixed storage enclosure compatibility for DS4000 storage subsystem models.	23	24. Connecting storage enclosures at the top of the best practice cable loop scheme	99
8. Mixed storage enclosure compatibility for DS5000 storage subsystem models.	23	25. Connecting storage enclosures at the top of a SAS drive cable loop scheme in a DS3000, DS3500, DCS3700, or DCS3700 with Performance Module Controllers configuration	100
9. DS4000 storage subsystems storage enclosure compatibility	24	26. Description of the figure that shows supported EXP710, EXP810, and EXP100 storage enclosure intermix configuration in a DS4700 or DS4800 storage subsystem	110
10. DS3950 and DS5000 storage subsystems storage enclosure compatibility	26	27. Description of the figure that shows an unsupported EXP710, EXP810, and EXP100 storage enclosure intermix configuration in a DS4700 or DS4800 storage subsystem	111
11. Storage enclosure compatibility with storage subsystems by model for DS3000 storage subsystems.	27	28. Description of the figure that shows cabling variations when EXP100, EXP710, and EXP810 storage enclosures are intermixed behind a DS4800 storage subsystem	112
12. DCS3700, DS4000, and DS5000 storage enclosures supported by controller firmware levels	27	29. Supported replacement storage subsystems	118
13. DS3000 storage enclosures supported by controller firmware levels	28	30. Snapshot of profile information that identifies the storage subsystem worldwide identifier (ID).	125
14. Storage enclosure ID settings.	31	31. Limits for particulates and gases	153
15. Supported EXP810, EXP710, and EXP100 storage enclosure combinations per redundant drive channel/loop pair in a DS4000 configuration with no internal drive bays configuration	38		
16. Supported EXP810 and EXP710/EXP100 storage enclosure combinations per redundant drive channel/loop pair in a DS4700 Express storage subsystem	39		
17. Combinations of 14-drive and 16-drive storage enclosures per drive loop for DS4300 dual controller turbo storage subsystems only.	40		

Introduction

This document describes how to add new Fibre Channel, SAS, or SATA hard disk drives or new IBM® System Storage® storage enclosures that contain new Fibre Channel, SAS, or SATA hard disk drives to an existing IBM storage subsystem configuration. This document also describes how to migrate hard disk drives or IBM System Storage storage enclosures that contain hard disk drives from one storage subsystem to another.

This document also describes how to replace the storage subsystem with a new storage subsystem of the same or different model. In this case, all the hard disk drives and storage enclosures in the original configuration become part of the new configuration.

Using this document

Before you begin, familiarize yourself with the information in Chapter 1, “Prerequisites to adding capacity and hard disk drive migration,” on page 1. Your familiarity with the information described in this document is critical to preventing loss of data availability, and in some cases, loss of data.

DS3000, DS3500, DCS3700, DS4000, and DS5000 are the storage subsystem series, which include the following storage subsystem models:

- **DS3000:** DS3200, DS3300, DS3400, and Boot Disk Systems
- **DS3500:** DS3512 and DS3524
- **DCS3700:** DCS3700 and DCS3700 with Performance Module Controllers
- **DS4000:** DS4100, DS4300, DS4400, DS4500, DS4700, and DS4800
- **DS5000:** DS3950, DS5020, DS5100, and DS5300

What's new in this guide

This guide contains information about the following enhancements to IBM DS Storage Manager version 10.83.xx and controller firmware version 7.83.xx.xx:

- New drive migration limitations. For details, see “Drive migration limitations” on page 14.
- Drives with a disk pool configuration cannot be migrated between storage subsystems.
- For the DS3500 and DCS3700 storage subsystem, and the DCS3700 storage subsystem with Performance Module Controllers head swap: If either of these storage subsystems has 7.8x.xx.xx controller firmware, then both the original and the new storage subsystems in the head swap must have the same version of 7.8x.xx.xx firmware.
- Updates about the DCS3700 storage subsystem with Performance Module Controllers.

Receiving product updates and support notifications

Be sure to download the latest levels of the following packages at the time of initial installation and when product updates become available:

- DS Storage Manager host software
- Controller firmware
- Environmental service modules (ESM) firmware
- Hard disk drive firmware

Important: Keep your system up-to-date with the latest firmware and other product updates by subscribing to receive support notifications.

For more information about how to register for support notifications, see <http://www.ibm.com/systems/support/> and click **My notifications**.

DS Storage Subsystem installation and support guides

This document frequently refers to the *IBM System Storage DS Storage Manager Version 10 Installation and Host Support Guide* (for DS Storage Manager V10.77 or earlier), *IBM System Storage DS Storage Manager Installation and Host Support Guide* (for DS Storage Manager V10.83 or later), and the *Installation, User's, and Maintenance Guide* for the storage subsystems.

To access the documentation related to your storage subsystem, operating system, and DS Storage Manager version from the IBM Support Portal, complete the following steps:

1. Go to <http://www.ibm.com/support/entry/portal>.
2. Under **Choose your products**, click **Browse for a product** or **Search for a product**.
3. Under **Choose your task**, click **Documentation**.
4. Under **See your results**, click **View your page**.
5. In the **Product documentation** box, click the link for the publication that you want to access.

Notices and statements in this document

The caution and danger statements in this document are also in the multilingual *Safety Information* document, which is on the *IBM Support Software DVD*. Each statement is numbered for reference to the corresponding statement in your language in the *Safety Information* document.

The following notices and statements are used in this document:

- **Note:** These notices provide important tips, guidance, or advice.
- **Important:** These notices provide information or advice that might help you avoid inconvenient or problem situations.
- **Attention:** These notices indicate potential damage to programs, devices, or data. An attention notice is placed just before the instruction or situation in which damage might occur.
- **Caution:** These statements indicate situations that can be potentially hazardous to you. A caution statement is placed just before the description of a potentially hazardous procedure step or situation.

- **Danger:** These statements indicate situations that can be potentially lethal or hazardous to you. A danger statement is placed just before the description of a potentially lethal or hazardous procedure step or situation.

Before installing this product, read the following danger and caution notices.

Statement 1



DANGER

Electrical current from power, telephone, and communication cables is hazardous.

To avoid a shock hazard:

- Do not connect or disconnect any cables or perform installation, maintenance, or reconfiguration of this product during an electrical storm.
- Connect all power cords to a properly wired and grounded electrical outlet.
- Connect to properly wired outlets any equipment that will be attached to this product.
- When possible, use one hand only to connect or disconnect signal cables.
- Never turn on any equipment when there is evidence of fire, water, or structural damage.
- Disconnect the attached power cords, telecommunications systems, networks, and modems before you open the device covers, unless instructed otherwise in the installation and configuration procedures.
- Connect and disconnect cables as described in the following table when installing, moving, or opening covers on this product or attached devices.

To Connect:	To Disconnect:
<ol style="list-style-type: none"> 1. Turn everything OFF. 2. First, attach all cables to devices. 3. Attach signal cables to connectors. 4. Attach power cords to outlet. 5. Turn device ON. 	<ol style="list-style-type: none"> 1. Turn everything OFF. 2. First, remove power cords from outlet. 3. Remove signal cables from connectors. 4. Remove all cables from devices.

Statement 3



CAUTION:

When laser products (such as CD-ROMs, DVD drives, fiber optic devices, or transmitters) are installed, note the following:

- Do not remove the covers. Removing the covers of the laser product could result in exposure to hazardous laser radiation. There are no serviceable parts inside the device.
- Use of controls or adjustments or performance of procedures other than those specified herein might result in hazardous radiation exposure.





DANGER

Some laser products contain an embedded Class 3A or Class 3B laser diode. Note the following.

Laser radiation when open. Do not stare into the beam, do not view directly with optical instruments, and avoid direct exposure to the beam.

Statement 4

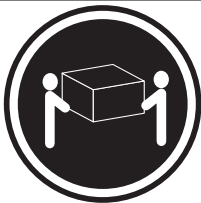

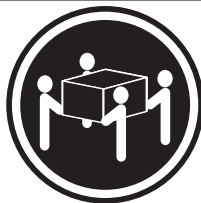
		
≥ 18 kg (39.7 lb)	≥ 32 kg (70.5 lb)	≥ 55 kg (121.2 lb)

CAUTION:

Use safe practices when lifting.

Statement 5



CAUTION:

The power control button on the device and the power switch on the power supply do not turn off the electrical current supplied to the device. The device also might have more than one power cord. To remove all electrical current from the device, ensure that all power cords are disconnected from the power source.

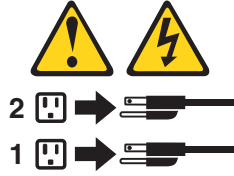

Statement 8



CAUTION:

Never remove the cover on a power supply or any part that has the following label attached.



Hazardous voltage, current, and energy levels are present inside any component that has this label attached. There are no serviceable parts inside these components. If you suspect a problem with one of these parts, contact a service technician.

Statement 29



CAUTION:

This equipment is designed to permit the connection of the earthed conductor of the dc supply circuit to the earthing conductor at the equipment.

This equipment is designed to permit the connection of the earthed conductor of the dc supply circuit to the earthing conductor at the equipment. If this connection is made, all of the following conditions must be met:

- This equipment shall be connected directly to the dc supply system earthing electrode conductor or to a bonding jumper from an earthing terminal bar or bus to which the dc supply system earthing electrode conductor is connected.
- This equipment shall be in the same immediate area (such as, adjacent cabinets) as any other equipment that has a connection between the earthed conductor of the same dc supply circuit and the earthing conductor, and also the point of earthing of the dc system. The dc system shall not be earthed elsewhere.
- The dc supply source shall be located within the same premises as this equipment.
- Switching or disconnecting devices shall not be in the earthed circuit conductor between the dc source and the point of connection of the earthing electrode conductor.

Statement 30



CAUTION:

To reduce the risk of electric shock or energy hazards:

- This equipment must be installed by trained service personnel in a restricted-access location, as defined by the NEC and IEC 60950-1, First Edition, The Standard for Safety of Information Technology Equipment.
- Connect the equipment to a reliably grounded safety extra low voltage (SELV) source. An SELV source is a secondary circuit that is designed so that normal and single fault conditions do not cause the voltages to exceed a safe level (60 V direct current).
- The branch circuit overcurrent protection must be rated 20 A.
- Use 12 American Wire Gauge (AWG) or 2.5 mm² copper conductor only, not exceeding 4.5 meters in length.
- Incorporate a readily available approved and rated disconnect device in the field wiring.



CAUTION:

This unit has more than one power source. To remove all power from the unit, all DC MAINS must be disconnected.



Cable Warning

WARNING: Handling the cord on this product or cords associated with accessories sold with this product will expose you to lead, a chemical known to the State of California to cause cancer and birth defects or other reproductive harm. **Wash hands after handling.**

Chapter 1. Prerequisites to adding capacity and hard disk drive migration

The following notes describe general information that you must consider when you perform the procedures in this document.

- Check the controller firmware readme files, the documentation that comes with your hardware, and this guide for the following information:
 - The latest information about storage subsystem and storage enclosure compatibility
 - The latest information and rules about storage enclosure cabling to the storage subsystem drive port
 - Any requirements of the installed microcode and firmware to support the storage subsystem and storage enclosure
- To prevent damage to the storage subsystem or to the storage enclosure backplane, ensure that the hard disk drives are compatible with your storage subsystem before you install them. Refer to the storage subsystem announcement letter for information about compatible devices.
- For more information about the procedures in this document, contact your IBM marketing representative or authorized reseller.

Preparing the storage subsystem

To prepare the target and source storage subsystems to add storage capacity or migrate hard disk drives, complete the following steps. Unless it is specified otherwise, perform the following steps on the target subsystem for adding new hard disk drive capacity and on both the target and source storage subsystems for migrating hard disk drives with data.

Attention: Failure to complete the following steps before you add storage capacity or migrate hard disk drives might result in loss of data availability or loss of data.

1. Complete a full backup of all data on the storage subsystem.
2. Ensure that the backup was successful.
3. Verify the hardware compatibility and requirements by reviewing the information in “Determining the supported number of drives and drive loop pairs” on page 4 and the storage subsystem announcement letters. If addition of storage enclosures is required, review “Intermixing storage enclosures” on page 21 and the cabling information in the *Installation, User’s, and Maintenance Guide* for any special cabling requirements.
4. If you want to perform a drive migration between storage subsystems, verify that the drives can be migrated to the new storage subsystem.

Note: Currently, drives with disk pools cannot be migrated from one subsystem to another. The data in the disk pool must be backed up to a tape or to drives that are part of traditional arrays. Then, the data is restored to newly created disk pools in another storage subsystem. For more information, see the “Drive migration limitations” on page 14 section.

5. Ensure that the storage subsystem has the latest controller firmware, nonvolatile storage random access memory (NVRAM), and ESM firmware. Also, ensure that the installed controller firmware in the storage subsystem

supports the drives and storage enclosures. See “Verifying controller, NVSRAM, and ESF firmware compatibility” on page 9.

6. Ensure that the hard disk drive firmware is the latest level. Upgrading drive firmware is a nonconcurrent operation. Schedule a maintenance window during which you can stop input and output to the storage subsystem for drive firmware updates.

Note:

- a. 3 Gbps SAS drives in a 6-Gbps SAS enclosure or 6-Gbps SAS drive in a 3-Gbps SAS enclosure is not supported.
 - b. Do not move or migrate Fibre Channel drives from a 1-Gbps Fibre Channel environment to a 2-Gbps Fibre Channel environment unless you install the latest firmware.
7. Verify that the storage subsystem is in Optimal state and does not stop in the middle of long running tasks such as modifications to the dynamic logical drive expansion (DVE) or Array RAID levels. See the Recovery Guru function in the Storage Subsystem Management window for instructions on bringing the storage subsystem into Optimal state. Also, see “Bringing storage subsystems and drive loops into optimal state” on page 21.
 8. Resolve any critical errors reported in the Storage Subsystem MEL.
 9. Save and store the storage subsystem profile and configuration script along with the collect all support data bundle.

Attention: To prevent loss of data, do not store storage subsystem profiles or collect all support data information in the same location as the logical drives defined on your storage subsystem.

10. Obtain and activate any required premium features.
11. Ensure that the hard disk drives are compatible. See “Verifying hard disk drive model compatibility” on page 17. Also, see the information for your drives in the announcement letter.
12. If you are adding capacity, see Chapter 2, “Adding or migrating hard disk drives,” on page 57 or Chapter 3, “Adding or migrating storage enclosures,” on page 75, depending on the task you are performing.
13. (For the source storage subsystem only) Stop all programs, services, and processes in the host servers that access the logical drives defined in the migrated hard disk drives.
14. (For the source storage subsystem only) Ensure that no programs, services, or processes are running in the background that might write data to the logical drives. For example, Microsoft MSCS service periodically writes to the Quorum disk.
15. (For the source storage subsystem only) Unmount the file systems to flush I/O from the server cache to disk.

Note:

- a. In a Microsoft Windows environment, remove the drive letter or the mount points of the mapped LUNs instead of unmounting the file systems.
 - b. See your operating-system documentation for detailed information about the unmount procedure.
16. Back up the changes that you made during this procedure.
 17. If the migrated drives are FDE drives and were configured as part of secured array, save the storage subsystem security (lock) key to unlock the drives after installing them in a new storage subsystem. Without this key, the controllers

cannot unlock the drives to perform input and output processes. For details about the security key, see the *IBM System Storage DS Storage Manager Version 10 Installation and Host Support Guide*.

If the migrated drives from the storage subsystem operate in external license key management mode, ensure that the new storage subsystem also operates in external license key management mode and uses the same external key server.

18. See the applicable chapter to complete the task that you plan to perform.
 - Chapter 2, “Adding or migrating hard disk drives,” on page 57.
 - Chapter 3, “Adding or migrating storage enclosures,” on page 75.
 - Chapter 4, “Upgrading a storage subsystem controller,” on page 115.

Preparing to export and import drives

Complete the following steps on the source storage subsystem to prepare to export drives:

1. Save the storage subsystem configuration so that a copy of the array configuration is available, if the export fails.
2. Stop all I/O and unmount or disconnect the file system.
3. Back up the array data.
4. Use the Locate Array function in the Storage Subsystem Manager window to identify the physical disks that are associated with the array. Then, label each drive with source and target storage subsystem names, array name, and total number of drives in the array. After the drives are exported or offline, you might not be able to use the array locate function to locate the drives that are part of an array, depending on the version of installed controller firmware.
5. Ensure that you have enough blank drive canisters or new drives to cover the drive bays from which the drives are removed to maintain airflow in the storage enclosure.
6. If the source storage subsystem contains secured full data encryption (FDE) arrays, save a copy of the security key in the target storage subsystem.

Verify the following on the target (destination) storage subsystem to prepare to export drives:

- You have enough drive bays for the drives.
- The storage subsystem supports the drives. You cannot exceed the maximum number of drives that the storage subsystem supports.
- The storage subsystem supports the RAID level that you are importing. You cannot exceed the maximum number of logical drives that the storage subsystem supports.
- The target storage subsystem supports RAID level 6, if you are importing RAID level 6.
- The controllers in the storage subsystem have the latest version of controller firmware.
- The latest DS Storage Manager software is installed.
- You have purchased and enabled any premium feature keys.
- If the source storage subsystem operates in external key management mode, the target storage subsystem also operates in external key management mode and is managed by the same external key manager. That way, you do not have to supply the security key to unlock the secured FDE drives when importing them. Otherwise, save the security key in the source storage subsystem.

Determining the supported number of drives and drive loop pairs

Use the information in this section to determine the hardware requirements before you migrate storage subsystems or add hard disk drives. Table 1 provides a list of the supported number of drives and drive loop pairs for each storage subsystem by machine type and model number. It also specifies storage enclosure license requirements.

Note:

1. RAID 6 is supported only in storage subsystems with controller firmware 07.xx.xx.xx.
2. RAID arrays in E-DDMs cannot be migrated to storage subsystems that use EV-DDMs, and vice versa.
3. Do not intermix Fibre Channel (FC) hard disk drives and Serial ATA (SATA) hard disk drives in the same storage subsystem environment unless you purchase the Fibre Channel/SATA intermix premium feature entitlement and upgrade the storage subsystem controller firmware to the version that supports the intermix.
4. The Fibre Channel/SATA intermix premium feature entitlement might be standard in some storage subsystem models. See the documentation that comes with your storage subsystem for information. Also, see “DS4000 Fibre Channel and Serial ATA Intermix premium feature” on page 31.

Table 1. Supported drives and drive loop pairs in storage subsystems

Storage subsystem	Machine type	Model number	Maximum drives	Maximum drive loop/channel pairs	Storage enclosure license requirement
DS4100 (single controller model)	1724	1SC, 1Sx	14	0	None. Storage enclosure attachment not supported.
DS4100	1724	100	112	1	None
DS4200 Express	1814	7VA, 7VH	112	1	Purchase 1–3 and 4–6 storage enclosure attachment entitlements.

Table 1. Supported drives and drive loop pairs in storage subsystems (continued)

Storage subsystem	Machine type	Model number	Maximum drives	Maximum drive loop/channel pairs	Storage enclosure license requirement
DS4300 Fibre Channel	1722	60X 60U	56	1	Purchase storage enclosure entitlements in increments up to three storage enclosures per DS4300 storage subsystem.
DS4300 Fibre Channel (with turbo option) ^{4,5}			112	1	None. The storage subsystem includes a seven storage enclosure entitlement.
DS4300 Fibre Channel (single controller model)		6LU 6LX	14	0	None. Storage enclosure attachment not supported.
DS4400 Fibre Channel ²	1742	1RU 1RX	224	2	None
DS4500 Fibre Channel ²	1742	90X 90U	224	2	None
DS4700 Express Fibre Channel ³	1814	70A 70H 70S 70T	112	1	Purchase 1–3 and 4–6 storage enclosure attachment entitlements.
		72A 72H 72S 72T	112	1	Comes with 1–3 storage enclosure attachment entitlements (64 drives total). Must purchase 4–6 storage enclosure attachments to get 112 drives.

Table 1. Supported drives and drive loop pairs in storage subsystems (continued)

Storage subsystem	Machine type	Model number	Maximum drives	Maximum drive loop/channel pairs	Storage enclosure license requirement
DS4800 Fibre Channel ²	1815	80x ²	224	2	Comes with entitlement to attach up to 112 drives. Must purchase additional entitlements to attach up to 224 drives.
		82x, 84x 88x ²	224	2	None
DS5100 or DS5300	1818	51A 53A	480 ⁷	4	For DS5300 - Must purchase the attach eight EXP5060 premium feature. For DS5100 - To attach up to 448 drives, must purchase entitlement and the attach EXP5060 premium feature.
DS5020 ⁸	1814	20A	112	1	Comes with entitlement to attach up to 32 drives. Must purchase additional entitlements to attach up to 112 drives.
DS3950 ⁹	1814	94H 98H	112	1	Comes with entitlement to attach up to 32 drives. Must purchase additional entitlements to attach up to 112 drives.

Table 1. Supported drives and drive loop pairs in storage subsystems (continued)

Storage subsystem	Machine type	Model number	Maximum drives	Maximum drive loop/channel pairs	Storage enclosure license requirement
DS3200	1726	21X, 22X, HC2	48	1	None if using controller firmware version 6.70.24.xx or later.
DS3300	1726	31X, 32X, 31E, 32E, HC3	48	1	None if using controller firmware version 6.70.24.xx or later.
DS3400	1726	41X, 42X, HC4	48	1	None if using controller firmware version 6.70.24.xx or later.
Boot Disk system	1726	22B	12	0	None
DS3512 ¹⁰	1746	C2A	192 ¹¹	1	Supports 96 standard hard disk drives. Requires the 96-192 hard disk drive expansion feature to support up to 192 drives.
DS3524 ¹⁰	1746	C4A	192 ¹¹	1	Supports 96 standard hard disk drives. Requires the 96-192 hard disk drive expansion feature to support up to 192 drives.
DCS3700 ¹²	1818	80C	180	1	None
DCS3700 with Performance Module Controllers	1818	80C	360	1	None

Table 1. Supported drives and drive loop pairs in storage subsystems (continued)

Storage subsystem	Machine type	Model number	Maximum drives	Maximum drive loop/channel pairs	Storage enclosure license requirement
-------------------	--------------	--------------	----------------	----------------------------------	---------------------------------------

Notes:

1. For the DS4200 Express and DS4700 Express storage subsystems, the maximum number of drives can also be supported by connecting six 16-drive storage enclosures.
2. For the DS4300 turbo option with Fibre Channel drives installed in the DS4300 storage subsystem, the maximum number of drives is supported by connecting seven 14-drive storage enclosures.
3. For the DS4300 turbo option with no drives installed in the DS4300 storage subsystem (and the internal drive bays disabled by a special script applied to the DS4300 controllers), the maximum number of drives can be supported by connecting eight EXP100 or seven EXP810 storage enclosures that have SATA drive CRUs (E-DDMs) installed.
4. There are two cases in the DS4000 and DS5000 storage subsystem configurations in which the maximum number of drives in a drive loop/channel is less than the supported maximum of 112 drives. These cases occur when you are using either of the following configurations:
 - Two or more storage enclosures that have different drive bays capacities
 - A storage subsystem that has internal drive bays with storage enclosures that have different drive bays capacities

Partially filled storage enclosures are not supported. That is, some bays are left empty so that the maximum number of drives in the drive loop does not exceed the value specified by the DS Storage subsystem. For details, see the sections about intermixing EXP500 and EXP700 storage enclosures, EXP100, EXP810, and EXP710 storage enclosures, EXP5000 and EXP5060 storage enclosures or EXP3524 and EXP3512 storage enclosures. For EXP3524 and EXP3512 intermixing, use the information from the 'Connecting storage enclosures to the DS3500' section of the *IBM System Storage DS3500 and EXP3500 Storage Subsystem Installation, User's, and Maintenance Guide*.
5. EXP5000 and EXP5060 are the supported storage enclosures for the DS5100 or DS5300 storage subsystems. The DS5300 (53A) supports a maximum of 448 Fibre Channel and SATA drives. The DS5100 (51A) supports a maximum of 256 Fibre Channel and SATA drives as standard. You can purchase a premium feature to increase the maximum number of Fibre Channel and SATA drives to 448.
6. The EXP520 is the supported storage enclosure for the DS5020 storage subsystem. You must purchase an EXP810 storage enclosure attachment option to attach EXP810 storage enclosures.
7. The EXP395 is the supported storage enclosure for the DS3950 storage subsystem. You must purchase an EXP810 storage enclosure attachment option to attach EXP810 storage enclosures.
8. EXP3514 and EXP3524 are the only supported expansion enclosures for the DS3512 and DS3524 storage subsystems.
9. DS3512 and DS3524 require controller firmware version 7.75.xx.xx and later, because controller firmware version 7.70.xx.xx supports a maximum of 96 drives only.
10. The DCS3700 expansion enclosure is the only supported drive expansion enclosure for the DCS3700 storage subsystem.

Verifying controller, NVSRAM, and ESM firmware compatibility

Use the information in this section to verify controller, NVSRAM, and ESM firmware compatibility before you migrate storage subsystems or add hard disk drives. For firmware compatibility between the migrating and original hardware, the controller firmware and NVSRAM of the target migration storage subsystem must be at the levels that are indicated in Table 2.

You can use the DS Storage Manager Client software and the controller firmware to upgrade the ESM firmware while the storage subsystem receives I/O from the host server, if you select only one storage enclosure to download the ESM firmware at a time in the Select Drive Enclosure To Download ESM Firmware Window.

Note:

1. See the most recent readme file that is included with the storage subsystem controller firmware package. To access the most recent readme file, see “Finding Storage Manager software, controller firmware, and readme files” on page 145.
2. See the readme file for any I/O operation requirements. Some controller firmware upgrade scenarios might require that you first quiesce host I/O operations.
3. See the readme file to ensure that the firmware is compatible with the controller firmware in the storage subsystem that you are upgrading.
4. Although you can upgrade the storage subsystem and ESM firmware while it processes I/O from the host server, schedule upgrades to occur during time periods of low I/O between the storage subsystems and host servers.

Table 2 lists the supported machine types, model numbers, and the latest version of released Storage Manager software and controller firmware levels for each machine type. Review the announcement letter for your drives and the readme file of the ESM and hard disk drive firmware package for any controller firmware and ESM firmware requirements.

Note: If your product contains controller firmware older than 6.xx.xx.xx, use an older storage manager software. IBM DS Storage Manager version 10.77 host software requires that the DS3000/DS4000/DS5000 storage subsystem controller firmware is at version 06.xx.xx.xx or higher. The IBM DS4000 Storage Manager v9.60 supports storage subsystems with controller firmware version 04.xx.xx.xx up to 05.2x.xx.xx. The IBM DS Storage Manager v10.36 supports storage subsystems with controller firmware version 5.3x.xx.xx to 07.36.xx.xx. The IBM DS Storage Manager v10.70 supports storage subsystems with controller firmware version 05.4x.xx.xx to 07.70.xx.xx.

Table 2. Machine types, supported controller firmware, and supported Storage Manager software

Storage subsystem	Machine type	Model	Supported controller firmware level ¹²	Supported Storage Manager software version
IBM Boot Disk System	1726	22B	6.30.xx.xx	10.8x.xx.xx
DS3200	1726	21X, 22X, HC2	7.35.xx.xx	10.8x.xx.xx

Table 2. Machine types, supported controller firmware, and supported Storage Manager software (continued)

Storage subsystem	Machine type	Model	Supported controller firmware level ¹²	Supported Storage Manager software version
DS3300	1726	31X, 32X, 31E, 32E, HC3	7.35.xx.xx	10.8x.xx.xx
DS3400	1726	41X, 42X, HC4	7.35.xx.xx	10.8x.xx.xx
DS3512	1746	C2A	7.7x.xx.xx, 7.8x.xx.xx	10.8x.xx.xx
DS3524	1746	C4A, C2T	7.7x.xx.xx, 7.8x.xx.xx	10.8x.xx.xx
DCS3700	1818	80C	7.77.xx.xx, 7.8x.xx.xx	10.8x.xx.xx
DCS3700 with Performance Module Controllers	1818	80C	7.8x.xx.xx	10.8x.xx.xx
DS3950	1814	94H, 98H	7.7x.xx.xx, 7.8x.xx.xx	10.8x.xx.xx
DS4100	1724	1SC, 1SX, 100	6.12.xx.xx	10.8x.xx.xx
DS4200	1814	7VA/H	6.60.xx.xx, 7.60.xx.xx	10.8x.xx.xx
DS4300 (single controller)	1722	6LU, 6LX	5.34.xx.xx	10.7x.xx.xx, 10.8x.xx.xx
DS4300 (base model)		60U, 60X	6.60.xx.xx	10.7x.xx.xx, 10.8x.xx.xx
DS4300 (turbo model)		60U, 60X	5.41.xx.xx (supports EXP100 only), 6.60.xx	
DS4400	1742	1RU, 1RX	6.12.xx.xx	10.8x.xx.xx
DS4500	1742	90X, 90U	5.41.xx.xx (supports EXP100 only), 6.60.xx	10.7x.xx.xx, 10.8x.xx.xx
DS4700	1814	70A/H, 72A/H	6.60.xx.xx, 7.60.xx.xx	10.8x.xx.xx
DS4800	1815	80A/H	6.60.xx.xx, 7.60.xx.xx	10.8x.xx.xx
		82A/H, 84A/H, 88A/H	6.60.xx.xx, 7.60.xx.xx	10.8x.xx.xx
DS5020	1814	20A	7.7x.xx.xx, 7.8x.xx.xx	10.8x.xx.xx
DS5100 or DS5300	1818	51A, 53A	7.60.xx.xx, 7.7x.xx.xx and 7.8x.xx.xx	10.8x.xx.xx

Important:

1. Controller firmware levels 06.23.xx.xx and 6.60.xx.xx support the DS4200, DS4300, DS4500, DS4700, and DS4800 storage subsystems. This firmware supports the intermixing of EXP100, EXP710, and EXP810 storage enclosures behind these models. It also supports the intermixing of Fibre Channel and SATA drives within the EXP810 storage enclosure.
2. Controller firmware level 06.19.xx.xx supports only the DS4300 (base and turbo models only) and DS4500 storage subsystems. This firmware level supports the intermixing of EXP810, EXP710, and EXP100 storage enclosures behind a DS4000® storage subsystem.
3. Controller firmware levels 06.15.xx.xx and 06.14.xx.xx support only the DS4800 storage subsystem. Controller firmware level 06.15.xx.xx supports EXP100 SATA drive storage enclosures with the DS4800 storage subsystem.
4. Controller firmware 06.16.xx.xx is required to support DS4000 storage subsystems that have EXP810 storage enclosures attached. It does not support EXP100 storage enclosures. Do not download 06.16.xx.xx into DS4000 storage subsystems that have EXP100 storage enclosures attached. If controller firmware 06.16.xx.xx is activated, the storage subsystem does not recognize the drives in EXP100 storage enclosures, causing loss of data availability to the RAID arrays and logical drives that are defined in those drives. Use controller firmware level 06.15.xx.xx if EXP100 storage enclosures are attached or if you plan to attach them in the future.
5. EXP710 storage enclosures are supported with controller firmware version 06.1x.xx.xx, or later.
6. Controller firmware level 06.12.xx.xx or later supports EXP100 SATA drive storage enclosures with the following storage subsystems:
 - DS4100 base models
 - DS4300 base models
 - DS4300 turbo models
 - DS4400
 - DS4500
7. Controller firmware version 7.60.xx.xx and later is required to support the EXP5060 expansion enclosure.
8. Some firmware levels support the intermixing of Fibre Channel and SATA drive storage enclosures in the same DS4000 storage subsystem, if the DS4000 Fibre Channel/SATA Intermix premium feature is enabled. For more information, see the *IBM System Storage DS4000 Fibre Channel and Serial ATA Intermix Premium Feature Installation Overview*.
9. DS4800 storage subsystem model 80A/H does not support controller firmware level 6.16.14.xx and 6.16.15.xx.
10. For the latest NVSRAM versions, see <http://www.ibm.com/systems/support/storage/disk/>.
11. The DS4000 storage subsystem from the factory identifies the NVSRAM version with an “M” prefix instead of an “N” prefix. Both NVSRAM versions are the same, if the rest of the version information is the same. For example, the N1815D480R915V05 and M1815D480R915V05 versions are the same because both versions share “1815D480R915V05” string. The M1815D480R915V05 version was installed at the factory. The N1815D480R915V05 version is available on the web.
12. If the controller firmware of a storage subsystem from which drives are migrated is not version 7.10.xx or later and the controller firmware of the target migration storage subsystem is 7.10.xx or later, only the basic logical drives are migrated. Copy Services logical drives such as FlashCopy®,

VolumeCopy, and Enhanced Remote Mirroring are not migrated. Before you migrate hard disk drives, complete the following steps:

- a. Back up the data in the FlashCopy logical drives and then delete the FlashCopy logical drives and repository logical drives.
 - b. Wait for VolumeCopy mirroring to be completed and then break the VolumeCopy mirroring pairs.
 - c. Remove the Enhanced Remote Mirroring relationships.
13. To verify software version levels or to identify possible interim updates to firmware and NVSRAM file versions that are described in Table 2 on page 9, go to <http://www.ibm.com/systems/support/storage/disk/>.

Before you update the controller firmware and NVSRAM to the version that is indicated in Table 3, see the readme file included in the controller firmware code package for information about upgrades or stepping-stone controller firmware upgrades that you must perform first.

Table 3 lists storage enclosure models by name, machine type, model number, and current ESM firmware level.

Table 3. Compatible storage enclosure ESM firmware level by machine type and model number

Storage subsystem and storage enclosure product name/model	Machine type	Model number	ESM firmware level
DS4000 EXP100	1710	10U	9566 or later .
DS4000 EXP710	1740	710	9682 or later
DS4000 EXP420	1812	8VA, 8VH	98G0 or later
DS4000 EXP810	1812	81A, 81H, 81S, 81T	98G0 or later
DS5000 EXP5000	1818	D1A	98G0 or later
DS5000 EXP520	1814	52A	98G0 or later
DS5000 EXP5060	1818	G1A	9921 or later
DS3950 EXP395	1814	92H	98G0 or later
DS3000 EXP3000	1727	1RX	019A or later
DS3500 EXP3512	1746	E2A	0363 or later
DS3500 EXP3524	1746	E4A	0363 or later
DCS3700 expansion enclosure	1818	80E	0363 or later

Storage subsystem profile

For controllers with firmware level 6.1x.xx.xx or later, go to the Storage Subsystem Management window and click **Storage Subsystem > View Profile**. For controllers with firmware level 5.xx.xx.xx.xx or earlier, click **View > Storage Subsystem Profile**. In either circumstance, when the Storage Subsystem Profile window opens, click the **All** tab and scroll through the **Profile For Storage Subsystem** section to locate the following information.

Note: The **Profile For Storage Subsystem** section contains all the profile information for the entire subsystem. Therefore, it might be necessary to scroll through a large amount of information to locate the firmware level numbers.

Storage Subsystem

- NVSRAM version

- Controller firmware (or appware, bootware, or both) version

See the following example of profile information.

```
Controller in Enclosure 0, Slot A
Status: Online
Current configuration
Firmware version: 06.10.07.00
Appware version: 06.10.07.00
Bootware version: 06.10.07.00
NVSRAM version: 1722F600R910V05
```

Drives

- Firmware level
- ATA translator card (for EXP810 storage enclosure SATA drive only)

ESM

- ESM card firmware level

Physical View pane

Select a procedure to view the firmware level from the Physical View pane of the Storage Subsystem Management window.

To obtain the controller firmware level:

Right-click the **Controller** icon in the Physical View pane of the Storage Subsystem Management window and select **Properties**. The Controller Enclosure properties window opens, and the properties for that controller are shown.

You must perform this step for each individual controller.

To obtain the drive and ATA translator firmware level:

Right-click the **Drive** icon in the Physical View pane of the Storage Subsystem Management window and select **Properties**. The Drive Properties window opens, and the properties for that drive are shown.

You must perform this step for each individual drive.

To obtain the ESM firmware and drive enclosure component firmware levels:

1. In the Physical View pane of the Storage Subsystem Management window, click the **Drive Enclosure Component** icon (the icon farthest to the right). The Drive Enclosure Component Information window opens.
2. Click the **ESM** icon in the left pane. The ESM information is shown in the right pane of the Drive Enclosure Component Information window.
3. Locate the firmware level of each ESM in the drive enclosure.

You must perform this step for each storage enclosure.

Upgrading ESM and controller firmware

Use the information in this section to upgrade the ESM and controller firmware in the source and target storage subsystems before you start the migration procedure.

To upgrade ESM and controller firmware, complete the following steps:

1. Upgrade the DS Storage Manager software to the latest version. For more information, see the applicable *IBM System Storage DS Storage Manager*

Installation and Support Guide. To access the latest document, go to <http://www.ibm.com/systems/support/storage/disk/>.

Note: To maintain compatibility, update the multi-path software on the host server to the level that is supported by or released with the controller firmware that you intend to download. For details about software compatibility, see <http://www.ibm.com/systems/support/storage/config/ssic/index.jsp>.

2. Upgrade the storage enclosure ESM firmware. You can use DS Storage Manager and controller firmware to update the ESM firmware while the storage subsystem is processing I/O from the host server if the ESM firmware download is performed to only one storage enclosure at a time. If you select multiple entries in the ESM firmware download window for ESM firmware download, you must quiesce I/O operations from the host servers before you start the ESM firmware download process.

Note: Even though the storage subsystem supports controller and ESM firmware upgrade while the storage subsystem processes I/O from the host server, schedule controller and ESM firmware upgrades to occur during time periods of low I/O between the storage subsystems and host servers.

3. Upgrade the controller firmware and NVSRAM. See Table 2 on page 9 and step 1 on page 13.

Note: See the readme file in the DS Storage Manager controller firmware package that is associated with the applicable host operating system environment for a support statement about the concurrent controller firmware download (that is, downloading code to the DS4000 storage subsystem while it is processing I/O from the host server).

Attention: Before you upgrade the controller firmware, see the readme file that comes with the firmware for any special prerequisite tasks, ESM firmware, and stepping-stone controller firmware that must be installed before the controller can be upgraded. Failure to do so might result in loss of data availability. There are certain minimum controller firmware level requirements that are associated with various storage enclosures. See Table 7 on page 23, Table 9 on page 24, and Table 12 on page 27 for related information.

Drive migration limitations

In general, drives with existing data and logical drives configuration can be migrated between storage subsystems that have the same level of controller firmware installed or from a source storage subsystem that has an older version of controller firmware installed than the one installed in the destination storage subsystem. However, it is a best practice to limit the drive migration between storage subsystems of the same level of controller firmware. The reason is that different versions of controller firmware might implement different metadata (DACstore) data structures to store the logical drive information. These metadata (DACstore) data structures are not interchangeable. If a newer version of controller firmware changes the metadata structure, all of the controller firmware versions older than this controller firmware cannot decode the metadata structure to obtain the logical drive information in the migrated drives and recreate them in the destination storage subsystem. But, this newer version of controller firmware normally includes the code to decode the previous metadata structure that it changes to allow the migration of the drives in the storage subsystem with older version of controller firmware. For more information about drive migration limitations based on controller firmware levels, see Table 4 on page 15.

Only the logical drive and array definitions along with their data can be migrated between storage subsystems. The Host-to-LUN mappings and the configuration definition and data of the copy services premium features like FlashCopy, VolumeCopy and Remote Mirroring must be removed prior to drive migration. Depending on the version of the installed controller firmware, the LUN mappings and the copy service configuration information can be saved in script file so that they can be recreated in the destination storage subsystem. If the drives with data cannot be migrated to the destination storage subsystem, one has to backup the data in those drives to a different medium like tape and then restores the data into the destination storage subsystem.

Table 4. Drive migration limitations based on controller firmware levels

Source storage subsystem controller firmware level	Destination storage subsystem controller firmware level	Action	Notes
7.8x.xx.xx	7.8x.xx.xx	Drives can be migrated	<ul style="list-style-type: none"> • Drives with disk pool configuration cannot be migrated between storage subsystems. ¹ • DS3500 and DCS3700 ² storage subsystems with controller firmware version 7.86 support T10PI. If an array has been configured and T10PI enabled, it cannot be migrated to a storage subsystem with controller firmware version 7.84 or earlier.
7.7x.xx.xx (DS3500, DCS3700 only)	7.7x.xx.xx (DS3500, DCS3700 only)	Drives can be migrated	
7.1x.xx.xx -7.6x.xx.xx, 7.7x.xx.xx (DS5100, DS5300, DS5020&DS3950 only)	7.1x.xx.xx - 7.6x.xx.xx, 7.7x.xx.xx (DS5100, DS5300, DS5020&DS3950 only)	Drives can be migrated	
6.xx.xx.xx or 5.xx.xx.xx	6.xx.xx.xx or 5.xx.xx.xx	Drives can be migrated	
6.xx.xx.xx or 5.xx.xx.xx	7.8x.xx.xx, 7.7x.xx.xx, 7.1x.xx.xx - 7.6x.xx.xx	Drives can be migrated into the destination storage subsystem when it is powered up and in optimal state.	See notes ³ and ⁴ .
7.1x.xx.xx -7.6x.xx.xx	7.8x.xx.xx, 7.7x.xx.xx	Drives can be migrated into the destination storage subsystem when it is powered up and in optimal state.	

Table 4. Drive migration limitations based on controller firmware levels (continued)

Source storage subsystem controller firmware level	Destination storage subsystem controller firmware level	Action	Notes
7.7x.xx.xx	7.8x.xx.xx	Drives can be migrated into the destination storage subsystem when it is powered up and in optimal state.	
7.8x.xx.xx	7.7x.xx.xx or earlier	Not supported.	
7.7x.xx.xx (DS3500 and DCS3700 only)	7.1x.xx.xx - 7.6x.xx.xx, 6.xx.xx.xx	Not supported	The minimum controller firmware version for DS3500 is 7.70.xx.xx and for DCS3700 is 7.77.xx.xx.
7.7x.xx.xx (DS5100, DS5300, DS5020, DS3950 only)	7.1x.xx.xx - 7.6x.xx.xx	Drives can be migrated	
7.7x.xx.xx (DS5100, DS5300, DS5020, DS3950 only)	6.xx.xx.xx	Supported only when the destination storage subsystem is upgraded to controller firmware version 7.6x.xx.xx or 7.7x.xx.xx first. If that is not possible, the drive migration is not supported.	
7.1x.xx.xx - 7.6x.xx.xx	6.xx.xx.xx	Supported only when the destination storage subsystem is upgraded to the same controller firmware version as in the source storage subsystem first. If that is not possible, the drive migration is not supported	

Note:

1. Check the IBM controller firmware readme file and changelist file for the controller firmware version that supports the drives with disk pool migrations.
2. The above note refers to the regular DCS3700 storage subsystem only, and not to the DCS3700 storage subsystem with Performance Module Controllers.
3. If a RAID array was created by a DS4000 storage subsystem that uses controller firmware level 05.30.xx.xx or earlier, it must be migrated to a storage subsystem with controller firmware level 6.xx.xx.xx first before it can be migrated to a storage subsystem with controller firmware level 7.xx.xx.xx.
4. If a RAID array was created by a DS4000 storage subsystem that uses controller firmware level 05.4x.xx.xx, either upgrade the controller firmware to a supported 6.xx.xx.xx version or migrate it to a storage subsystem with

31
31

controller firmware level 6.xx.xx.xx first before you migrate it to a storage subsystem with controller firmware level 7.xx.xx.xx.

Verifying hard disk drive model compatibility

Use the information in this section to verify hard disk drive compatibility before you start the migration procedure or to add hard disk drives.

- Do not use the drive product identifier as the only source to determine drive compatibility for a subsystem. Drives that have the same product identifier might require a different mounting tray or interposer in a storage subsystem. Instead, use the drive option part number or drive CRU part number to check for drive compatibility in a storage subsystem.
- Ensure that the drives can operate at the interface speed of the drive loop/channel. If not, the drives are in Bypassed mode or are not identified by the controllers. In a few instances, inserting a drive with the wrong drive interface speed causes problems in the drive loops which could result in loss of data access.
- Some storage subsystem and expansion enclosures can support different drive interface speeds. Ensure that these storage subsystem and expansion enclosure speed switches are set to the correct values to support the drive interface speeds. Intermixing storage subsystems and expansion enclosures that support different drive interface speeds is not supported. The drive loop/channel must be set to support the lowest drive interface speed.
- The Fibre Channel drive CRU for the EXP710 storage enclosure is not compatible with the Fibre Channel drive CRU for the EXP810 storage enclosure, although the product ID is the same for both EXP710 and EXP810 storage enclosure drive CRUs. See the documentation that comes with the storage enclosures and the documentation that comes with the hard disk drive options.
- Do not use SATA and Fibre Channel drives or enclosures together in the same drive loop behind a DS4000 storage subsystem unless you obtain the Fibre Channel/SATA intermix premium feature and the storage subsystem supports the Fibre Channel/SATA intermix feature.
- Do not install SATA hard disk drives in storage enclosures that support only Fibre Channel hard disk drives. Do not install Fibre Channel hard disk drives in storage enclosures that support only SATA hard disk drives. The DS3950, DS4700, and DS5020 storage subsystems with an EXP3950, EXP520, EXP810, or EXP5000 expansion enclosures attached are the only models that support both Fibre Channel and SATA hard disk drives.
- Do not install a DS3000 storage subsystem drive in a DS4000 or DS5000 storage subsystem.
- Do not install a DS4000 or DS5000 storage subsystem drive in a DS3000 storage subsystem.
- Solid-state drives require controller firmware version 7.60.xx.xx and higher for the DS5100 and DS5300 storage subsystems, controller firmware version 7.70.xx.xx for the DS5020 storage subsystem, and controller firmware version 7.77.xx.xx for the DS3500 storage subsystem.
- Full data encryption (FDE) drives require controller firmware 7.50.xx.xx and higher for the DS5100 and DS5300 storage subsystems and controller firmware version 7.60.xx.xx and higher for the DS5020 and DS3950 storage subsystems. DS3500 storage subsystems require controller firmware 7.70.xx.xx and higher.
- SAS interface drives with SAS-FC interposer card (FC-SAS drives) require controller firmware 7.77.xx.xx and higher.
- T10PI capable drives require controller firmware version 10.77.xx.xx and later.

- The only DS4000 storage subsystem attached storage enclosure that supports the 4-Gbps hard disk drive and the 2-Gbps drive is the EXP810 storage enclosure; however, it can support only one drive speed in a single drive channel/loop pair. The 2-Gbps drives either are in Bypassed mode or are not identified by the controllers when they are inserted in an EXP810 storage enclosure that is operating at 4-Gbps Fibre Channel speed.
- The EXP395, EXP520, and EXP5000 storage enclosures support 4-Gbps drives only.
- The EXP520 storage enclosure is designed for the DS5020 (1814-20A) storage subsystem. You can connect them at no additional charge. However, if you want to attach the EXP810 storage enclosure to the DS5020 storage subsystem, you must purchase the Attach EXP810 storage enclosure to DS5020 Activation option.
- The EXP395 storage enclosure is designed for the DS3950 storage subsystem. You can connect them at no additional charge. However, if you want to attach the EXP810 storage enclosure to the DS3950 storage subsystem, you must purchase the Attach EXP810 storage enclosure to DS3950 Activation option.
- For information about the EXP5000 and EXP5060 storage enclosures, see Note 2 on page 24.
- The 3 TB and higher capacity EXP5060 SATA drives require the ATA translator firmware in the EXP5060 drive slot to be at version LW1613 or higher. Refer to the flyer that is shipped with your drive option of the EXP5060 IUMG for more information.
- The EXP3512 and EXP3524 storage enclosures are supported with DS3500 storage subsystems only.
- The EXP3000 storage enclosure is supported with DS3000 storage subsystems only.
- The DCS3700 storage expansion enclosure is supported with DCS3700 storage subsystem and DCS3700 storage subsystem with Performance Module Controllers only.
- For information about supported drive capacity and interface and drive speeds, contact your IBM marketing representative or authorized reseller, go to <http://www.ibm.com/systems/support/storage/disk/>, or see the latest Storage Subsystem announcement.

Note:

1. In general, Fibre Channel drives can operate at lower Fibre Channel operating speeds than the speed for which the drive is rated. For example, 2-Gbps Fibre Channel drives also operate at 1-Gbps speed; 4-Gbps Fibre Channel drives also operate at 2-Gbps speed. Check the documentation of the storage subsystem or storage enclosure to determine whether a Fibre Channel drive can operate at a lower speed. The drive might not be certified or might not have the correct form factor for that storage subsystem or storage enclosure.
2. Intermixing 3-Gbps SAS drive storage enclosures (EXP3000 storage enclosure) or 3-Gbps SAS hard disk drives with 6-Gbps SAS drive storage enclosures (EXP3512 and EXP3524 storage enclosure) or 6-Gbps SAS hard disk drives is not supported.

Viewing the product ID and model of a hard disk drive

Use the information in this section to view the product ID and model of a hard disk drive by using the storage server profile before you start the migration procedure or to add hard disk drives. Use the product ID or model to determine whether the drive is a 1 Gbps or 2-Gbps Fibre Channel drive. You can determine the product ID and model of a hard disk drive from the storage server profile through the menu option in the Subsystem Management window. To get the profile, in the Subsystem Management window, click **View -> Storage Subsystem Profile** (if the controller firmware level is 05.xx.xx, or earlier) or **Storage Subsystem -> View Profile** (if the controller firmware level is 06.xx.xx, or later). When the Storage Subsystem Profile window is shown, click the **Drives** tab and scroll down to view the product ID and model of a hard disk drive.

See Table 5 on page 20 for a sample profile that indicates the product ID of the drive in bay 12 of enclosure ID 1 as ST3146756FC F. The **Speed** and **Current Data Rate** fields show that this drive is a 15 krpm drive and is operating at 4-Gbps Fibre Channel data rate. In addition, the drive is security capable and in a secure state that allows input and output processing to the drive from the controller.

Table 5. Snapshot of profile information identifying the product ID of the drive in bay 12 of enclosure ID 1

```

HOT SPARE COVERAGE:
The following arrays are not protected: 0
Total hot spare drives: 0

Standby: 0
In use: 0

DETAILS
Drive at Enclosure 1, Slot 12

Status:                Optimal

Mode:                  Assigned
Raw capacity:          136.732 GB
Usable capacity:       136.232 GB
World-wide identifier: 20:00:00:1d:38:1d:1d:d0:00:00:00:00:00:00:00:00
Associated array:      0
Port    Channel    ID
0       1          11/0xD4
1       5          11/0xD4
Security Capable:     Yes
Secure:               Yes
Read/write accessible: Yes
Security key identifier: 27000000600A0B80004777A40000717049A6B239

Speed:                15,015 RPM
Current data rate:    4 Gbps
Product ID:           ST3146756FC  F
Firmware version:     E097
Serial number:         3QN07PR700009912TLHK
Vendor:               IBM-SSG
Date of manufacture:  October 16, 2008

Drive at Enclosure 1, Slot 13

Status:                Optimal

Mode:                  Assigned
Raw capacity:          136.732 GB
Usable capacity:       136.232 GB
World-wide identifier: 20:00:00:1d:38:1d:1e:7b:00:00:00:00:00:00:00:00
Associated array:      0

Port    Channel    ID
0       5          12/0xD3
1       1          12/0xD3
Security Capable:     Yes
Secure:               Yes
Read/write accessible: Yes
Security key identifier: 27000000600A0B80004777A40000717049A6B239
Speed:                15,015 RPM
Current data rate:    4 Gbps
Product ID:           ST3146756FC  F

```

Bringing storage subsystems and drive loops into optimal state

You can add or migrate storage enclosures only while the storage subsystem is turned on and in optimal state. To bring storage subsystems and drive loops into optimal state, complete the following steps:

1. Bring the storage subsystem to Optimal state before you reconfigure it with new hardware.
2. Use the DS Storage Manager Client program to display the status of the storage subsystem and to correct any problems that might cause the storage subsystem to enter Needs Attention state.
3. Verify that all indicator lights on the storage subsystem are in Optimal state.
4. Use the Read_Link_Status function of the DS Storage Manager Client program and the storage subsystem MEL to verify that all components in the drive loop are in Optimal state. (Optimal state indicates that there are no drive loop component errors in the event log and no errors in the Read_Link_Status window.) If you are using controller firmware 06.10.xx.xx or later, use the drive channel diagnostics to determine whether the drive loop/channel is in Optimal state. For more information about the RLS and drive channel diagnostics if they are supported by the installed version of your controller firmware, see the Subsystem Management window online help of the DS Storage Manager Client program.
Drive channel diagnostics are available only if you are using controller firmware level 06.10.xx.xx or later.
5. If the arrays are in degraded state because of a failed drive, correct the problem before migration.

Note:

1. If necessary, contact IBM support for assistance with event log interpretation.
2. For more information about verifying the Optimal state in storage subsystems and drive loops, see the *Problem Determination Guide* for your storage subsystem.

Before you add drives or storage enclosures, verify that the storage subsystem is not performing any of the following tasks:

- Dynamic logical drive capacity expansion
 - Dynamic logical drive expansion (DVE)
 - Dynamic capacity expansion (DCE)
- Logical drive segment size modification
- Array RAID-level modification
- User-initiated array redundancy checking (click **Array > Check Redundancy** in the Storage Subsystem Management window)
- Remote mirror logical drive synchronization
- FlashCopy or VolumeCopy logical drive creation
- Logical drive reconstruction or copyback (logical drive sparing)

Intermixing storage enclosures

This section describes general information about intermixing storage enclosures in a storage subsystem. Use the information in this section to plan a storage subsystem migration or to add hard disk drives. Special considerations about intermixing EXP810 and EXP5000 storage enclosures are presented in “Intermixing

EXP810 and EXP5000 storage enclosures” on page 43. For information about intermixing EXP520 and EXP810 storage enclosures, see “Intermixing EXP520 and EXP810 storage enclosures” on page 37.

Note: For more information about intermixing legacy storage enclosures such as EXP100, EXP500, EXP700, and EXP710, see “Intermixing storage enclosures for DS4000 and DS5000 storage subsystems” on page 44.

For DS4000 storage subsystems, see “DS4000 Fibre Channel and Serial ATA Intermix premium feature” on page 31 for important information about using the Fibre Channel and SATA Intermix premium feature, including configuration and setup requirements. DS5000 storage subsystems come with the Fibre Channel and SATA Intermix premium feature as standard.

For hardware compatibility, ensure that the environmental service module (ESM) firmware for each storage enclosure and the storage server controller firmware is at or above the levels in Table 2 on page 9 and Table 3 on page 12.

Storage subsystems support the addition of external drive enclosures, which can provide additional storage capacity (as in the case of DS4400, DS4500, DS4800, DS5100, and DS5300 storage subsystems) and capacity expansion beyond the storage capacity of a DS4000 storage subsystem (in DS4100, DS4200 Express, DS4300, DS4700 Express, and DS5020 storage subsystems).

As of the date of this document, IBM supports EXP100, EXP420, EXP500, EXP520, EXP700, EXP710, EXP810, EXP5000, EXP395, and EXP5060 storage enclosures for DS4000 and DS5000 storage subsystems. For the DS3000 storage subsystems, IBM supports the EXP3000 storage enclosure. For the DS3500 storage subsystem, IBM supports the EXP3512 and EXP3524 storage enclosures. For the DCS3700 storage subsystem and the DCS3700 storage subsystem with Performance Module Controllers, IBM supports the DCS3700 storage expansion enclosure.

When you increase the capacity of your storage subsystem in either of these ways, you might choose to add external drive enclosures of the same model and type or of different types. IBM does not support the combination of every external drive enclosure type and model in every storage subsystem configuration. In addition, not all controller firmware levels support all available storage enclosures or storage subsystems.

In general, if a storage subsystem supports multiple storage enclosures with different model numbers and machine types, you can connect the storage enclosures to the storage subsystem on the same redundant drive loop/channel by using the cabling rules that are described in the storage subsystem documentation. As a best practice, group the storage enclosures by model and machine type when you connect cables in the same redundant drive loop/channels. However, because of storage enclosure architecture differences, there might be certain restrictions when you connect some combinations of storage enclosures in the same drive loop/channel. The restrictions are documented in this section and in “Intermixing storage enclosures for DS4000 and DS5000 storage subsystems” on page 44. However, always review the latest version of your storage subsystem *Installation, User's, and Maintenance Guide* for the most up-to-date storage enclosure cabling restrictions.

Table 6 on page 23 indicates which storage enclosures can coexist in the same redundant drive loop, by model for the DS3000 storage subsystems. Table 7 on page 23 indicates which storage enclosures can coexist in the same redundant drive

loop, by model for the DS4000 storage subsystems. Table 8 indicates which storage enclosures can coexist in the same redundant drive loop, by model for the DS5000 storage subsystems.

Table 6. Mixed storage enclosure compatibility for DS3000 storage subsystem models.

Storage enclosure	EXP3000	EXP3512	EXP3524
EXP3512		✓	✓
EXP3524		✓	✓
EXP3000	✓		

Table 7. Mixed storage enclosure compatibility for DS4000 storage subsystem models.

Storage subsystem and attached storage enclosure	DS4000 EXP100 (SATA)	DS4000 EXP420	DS4000 EXP710 (Fibre Channel)	DS4000 EXP810 (Fibre Channel / SATA)
DS4000 EXP100 (SATA)	✓1		✓2	✓4
DS4000 EXP420 (SATA)		✓5		
DS4000 EXP710 (Fibre Channel)	✓2		✓4	✓3
DS4000 EXP810 (Fibre Channel / SATA)	✓4		✓3	✓3

Notes:

- Requires controller firmware 06.10.11.xx or later (DS4300 with turbo option, DS4400, and DS4500 storage subsystems), 06.12.03.xx or later (DS4300 dual controller standard/base, DS4100 base storage subsystems), 06.15.xx.xx (DS4800 storage subsystem), or 06.23.xx.xx or later (DS4700 and DS4800 storage subsystems). Controller firmware 06.16.xx.xx does not support the EXP100 storage enclosure.
There are versions of 05.41.xx.xx controller firmware that also provide EXP100 storage enclosure support for DS4300 (with dual controller standard/base or turbo option), DS4400, and DS4500 storage subsystems or versions of 05.42.xx.xx xx controller firmware that also provide EXP100 storage enclosure support for DS4100 storage subsystems. Instead, use controller firmware level 06.12.xx.xx or later for DS4100, DS4300 (with base or turbo option), DS4400, and DS4500 storage subsystems.
- Supported only with Fibre Channel/SATA intermix entitlement purchase and controller firmware level 06.12.xx.xx or later. In addition, the storage subsystem must also support the Fibre Channel/SATA intermix premium feature.
- Requires controller firmware 06.16.xx.xx or later for DS4800 and DS4700 Express storage subsystems. The EXP810 storage enclosure supports SATA drives with controller firmware level 06.16.8x.xx or later.
- Requires controller firmware level 06.19.xx.xx or later with DS4300 and DS4500 storage subsystems, and version 06.23.xx.xx or later with DS4700 and DS4800 storage subsystems.
You must purchase the Fibre Channel/SATA Intermix premium feature when to intermix EXP100 storage enclosures with EXP810 storage enclosures that have Fibre Channel drive CRUs (E-DDMs) installed.)
- The EXP420 storage enclosure is supported for attachment to the DS4200 storage subsystem only. Requires controller firmware 06.16.8x.xx or later.

Table 8. Mixed storage enclosure compatibility for DS5000 storage subsystem models.

Storage subsystem and storage enclosure	EXP395 (Fibre Channel / SATA)	DS5000 EXP5000 (Fibre Channel / SATA)	DS5000 EXP520 (Fibre Channel / SATA)	DS5000 EXP5060 (SATA)	DS4000 EXP810 (Fibre Channel / SATA)
DS4000 EXP810 (Fibre Channel / SATA)	✓5	✓1, 2	✓3	✓2, 4	✓
DS5000 EXP5000 (Fibre Channel / SATA)		✓1		✓	✓1, 2

Table 8. Mixed storage enclosure compatibility for DS5000 storage subsystem models. (continued)

Storage subsystem and storage enclosure	EXP395 (Fibre Channel / SATA)	DS5000 EXP5000 (Fibre Channel / SATA)	DS5000 EXP520 (Fibre Channel / SATA)	DS5000 EXP5060 (SATA)	DS4000 EXP810 (Fibre Channel / SATA)
DS5000 EXP520 (Fibre Channel / SATA)			✓		✓3
EXP395 (SATA)	✓				✓5
DS5000 EXP5060 (SATA)4		✓		✓	✓2

Notes:

- Requires controller firmware 07.30.xx.xx or later.
- The EXP5000 (1818-D1A) and EXP5060 storage enclosures are designed specifically for the DS5100 and DS5300 (1818-51A and 1818-53A) storage subsystems and are the only supported storage enclosures, with the exception noted in the following paragraph. This is a critical requirement because only the EXP5000 storage enclosure is supported with future enhancements of the DS5100 and DS5300 storage subsystems and only the EXP5000 storage enclosure provides consistent warranty and support terms and conditions (including support services representative installation and support for the entire system, and code upgrades within the initial warranty period).
The only exception is that for client investment protection, existing EXP810 storage enclosures can be migrated from currently installed DS4700 or DS4800 storage subsystems to attach to a DS5100 or DS5300 storage subsystem. A request for price quote (RPQ) approval is required for support of all migration configurations. With approved migration of EXP810 storage enclosures to a DS5100 or DS5300 storage subsystem, special consideration must be given to proper firmware levels and careful coordination of differences in warranty and maintenance terms. You can submit an RPQ request through the normal process.
Purchase of new EXP810 storage enclosures to attach to DS5100 or DS5300 storage subsystem is not supported or configurable in eConfig.
Disk drive modules that can be ordered in bulk or individually as customer installable parts for the EXP810 storage enclosure are not supported for use in the EXP5000 storage enclosure. Only disk drive modules that are ordered as feature codes of 1818-D1A and delivered preinstalled in the EXP5000 storage enclosure or as upgrades (installed only by a support services representative) are supported.
- Controller firmware version 7.6x.xx.xx or later is required. Attachment of the EXP810 storage enclosure to the DS5020 storage subsystem requires the purchase of the Attach EXP810 storage enclosure to DS5020 Activation option.
- Controller firmware version 7.6x.xx.xx or later is required.
- Controller firmware version 7.6x.xx.xx or later is required. Attachment of the EXP810 storage enclosure to the DS3950 storage subsystem requires purchase of the Attach EXP810 storage enclosure to DS3950 Activation option.

Table 9 indicates which storage enclosures can attach to DS4000 storage subsystems. Table 10 on page 26 indicates which storage enclosures can attach to DS5000 storage subsystems. Table 11 on page 27 indicates which storage enclosures can attach to DS3000 storage subsystems.

Table 9. DS4000 storage subsystems storage enclosure compatibility

Storage subsystem	DS4000 EXP100 (SATA)	DS4000 EXP420 (SATA)	DS4000 EXP710 (Fibre Channel)	DS4000 EXP810 (Fibre Channel and SATA)
DS4100 (SATA)	✓			
DS4200 (SATA)		✓		

Table 9. DS4000 storage subsystems storage enclosure compatibility (continued)

Storage subsystem	DS4000 EXP100 (SATA)	DS4000 EXP420 (SATA)	DS4000 EXP710 (Fibre Channel)	DS4000 EXP810 (Fibre Channel and SATA)
DS4300 (turbo option, Fibre Channel)	✓ 2 3 5		✓4	✓5
DS4300 (base model, Fibre Channel)	✓ 1 2 5		✓4	✓5
DS4500 (Fibre Channel, SATA)	✓ 2 3 5		✓4	✓5
DS4700 Express (Fibre Channel)	✓ 2 3 5		✓4	✓
DS4800 (Fibre Channel, SATA)	✓ 2 3 5		✓4	✓

Table 9. DS4000 storage subsystems storage enclosure compatibility (continued)

Storage subsystem	DS4000 EXP100 (SATA)	DS4000 EXP420 (SATA)	DS4000 EXP710 (Fibre Channel)	DS4000 EXP810 (Fibre Channel and SATA)
Notes:				
<p>1. The DS4300 storage subsystem base supports Fibre Channel/SATA intermixing only when the controller firmware is at version 06.12.xx.xx or later and the Fibre Channel/SATA intermix entitlement is purchased. In addition, although the DS4300 storage subsystem (base model) supports Fibre Channel or SATA drives with controller firmware level 05.41.xx.xx, it does not support both in a mixed environment. However, it does support SATA drives in an attached storage enclosure (only) but never in the storage subsystem itself. Also, see note 5.</p> <p>2. DS4000 storage subsystems require the following firmware to manage EXP100 storage enclosures:</p> <p>DS4300 base or turbo and DS4500 Either 05.41.5x.xx or 06.1x.xx.xx or later. If possible, use level 06.60.xx.xx or later.</p> <p>DS4700 Express 06.23.xx.xx or later.</p> <p>DS4800 Use either 06.15.xx.xx, or 06.23.xx.xx or later. If possible, use level 6.60.xx.xx or later. 6.16.xx.xx does not support the EXP100 storage enclosure.</p> <p>3. Requires controller firmware level 06.1x.xx.xx or later. Use level 06.60.xx.xx for DS4300 dual controller standard/base or turbo and DS4500 storage subsystems (also see note 5). For DS4700 Express and DS4800 storage subsystems, use level 06.60.xx.xx (also see footnotes 4 and 5).</p> <p>4. Requires controller firmware 06.16.18.xx or later for DS4800 and 06.16.4x.xx or later for DS4700 Express storage subsystems. Also, see footnote 5 for the controller firmware requirement for intermixing EXP810 storage enclosures and EXP100 storage enclosures.</p> <p>5. With DS4300 and DS4500 storage subsystems, controller firmware level 06.19.xx.xx or later is required to intermix EXP100 storage enclosures and EXP810 storage enclosures. With DS4700 Express and DS4800 storage subsystems, version 06.23.xx.xx or later is required to intermix EXP100 storage enclosures and EXP810 storage enclosures.</p> <p>6. Attachment of the EXP810 storage enclosure to the DS5020 storage subsystem requires the purchase of the Attach EXP810 storage enclosure to DS5020 Activation option.</p> <p>7. Requires controller firmware 07.60.xx.xx or later.</p>				

Table 10. DS3950 and DS5000 storage subsystems storage enclosure compatibility

Storage subsystem	DS3950 EXP395 (Fibre Channel and SATA)	DS5000 EXP5000 (Fibre Channel and SATA)	DS5000 EXP520 (Fibre Channel and SATA)	DS5000 EXP5060 (SATA)	DS5000 EXP810 (Fibre Channel and SATA)
DS3950	✓				✓4
DS5020 (Fibre Channel, SATA)			✓		✓3
DS5100/ DS5300 (Fibre Channel, SATA)		✓		✓1	✓2

Notes:

- Attachment of the EXP810 storage enclosure to the DS5020 storage subsystem requires the purchase of the Attach EXP810 storage enclosure to DS5020 Activation option.
- Requires controller firmware 07.30.xx.xx or later.
- For information about the EXP5000 and EXP5060 storage enclosures, see note 2 on page 24.

4. Controller firmware version 7.6x.xx.xx or later is required. Attachment of the EXP810 storage enclosure to the DS3950 storage subsystem requires the purchase of the Attach EXP810 storage enclosure to DS3950 Activation option.

Table 11. Storage enclosure compatibility with storage subsystems by model for DS3000 storage subsystems

Storage subsystem	EXP3000	EXP3512	EXP3524
DS3200	↙		
DS3300			
DS3400			
DS3512		↙1	↙1
DS3524		↙1	↙1
Note: Requires controller firmware version 7.70.xx.xx or later. Intermixing EXP3000 expansion enclosures and EXP3512/EXP3524 storage subsystems is not supported.			

Table 12. DCS3700, DS4000, and DS5000 storage enclosures supported by controller firmware levels

Firmware level	EXP100	EXP420	EXP710	EXP810	EXP395/ EXP520	EXP5000	EXP5060	DCS3700	DCS3700 with Performance Module Controllers
5.41.xx.xx	Yes	No	No	No	No	No	No	No	No
5.42.xx.xx	Yes	No	No	No	No	No	No	No	No
6.00.xx.xx	No	No	Yes	No	No	No	No	No	No
6.10.xx.xx	No	No	No	No	No	No	No	No	No
6.12.xx.xx	Yes	No	Yes	No	No	No	No	No	No
6.14.xx.xx	Yes	No	Yes	No	No	No	No	No	No
6.15.xx.xx	Yes	No	Yes	No	No	No	No	No	No
6.16.2x.xx	No	No	Yes	Yes	No	No	No	No	No
6.16.8x.xx/ 6.16.9x.xx	No	Yes	Yes	Yes	No	No	No	No	No
6.19.xx.xx	Yes	No	Yes	Yes	No	No	No	No	No
6.23.xx.xx	Yes	Yes	Yes	Yes	No	No	No	No	No
6.60.xx.xx	Yes	Yes	Yes	Yes	No	No	No	No	No
07.10.xx.xx	Yes	Yes	Yes	Yes	No	No	No	No	No
07.30.xx.xx	No	No	No	Yes	No	Yes	No	No	No
07.36.xx.xx	Yes	Yes	Yes	Yes	No	Yes	No	No	No
07.50.xx.xx	Yes	Yes	Yes	Yes	No	Yes	No	No	No
07.60.xx.xx	Yes	Yes	Yes	Yes	Yes	Yes	Yes	No	No
07.70.xx.xx	No	No	No	Yes	Yes	Yes	Yes	No	No
07.77.xx.xx	No	No	No	Yes	Yes	Yes	Yes	Yes	No
07.83.xx.xx or later	No	No	No	No	No	No	No	No	Yes

Note: The EXP420 storage enclosure is not supported in an intermixed SATA/Fibre Channel storage enclosure loop configuration. For more information about

supported intermixed SATA/Fibre Channel storage enclosure loop configurations, see the *IBM TotalStorage DS4000 Fibre Channel and Serial ATA Intermix Premium Feature Installation Overview*.

Table 13. DS3000 storage enclosures supported by controller firmware levels

Firmware level	EXP3000	EXP3512	EXP3524
06.17.xx.xx	Yes	No	No
06.50.xx.xx	Yes	No	No
06.70.xx.xx	Yes	No	No
07.35.xx.xx	Yes	No	No
07.70.xx.xx or later	No	Yes	Yes

Although you can intermix the EXP100 storage enclosures with EXP710 storage enclosures in the same redundant drive loop pair in a DS4000 storage subsystem, you must group together all DS4000 storage subsystems with an EXP710 storage enclosure attached in the redundant drive loop. For more information, see “Intermixing EXP100 and EXP710 storage enclosures” on page 32.

The EXP810 storage enclosures can be intermixed in the same redundant drive channel/loop pair with the EXP100 storage enclosure (controller firmware level 06.19.xx) and EXP710 storage enclosures. The EXP810 storage enclosure speed switch must be set at 2 Gbps. In addition, all of the EXP100 storage enclosures in the redundant drive loop must be grouped together, followed by (or preceding) the group of EXP710 storage enclosures and EXP810 storage enclosures. For more information, see “Intermixing EXP810 with EXP100 and EXP710 storage enclosures” on page 38.

Note: For best operating environment, use storage enclosures of the same machine type / model only (for example, EXP100, EXP710, EXP810, or EXP5000) in the given redundant drive loop/channel in case of more than one redundant drive loop/channels in the storage subsystems, even though intermixing different storage enclosure models in the same redundant drive loop/channel is supported.

Important: To avoid unpredictable results, do not change the speed of a drive loop while the storage subsystem is turned on. Also, the storage enclosures must be power cycled for the new speed setting to be recognized correctly.

To change the speed of a drive loop, complete the following steps:

1. Prepare applications for storage subsystem shutdown.
2. Shut down the storage subsystem.
3. Shut down the storage enclosures.
4. Change the storage enclosure speed settings.
5. Turn on the power to the storage enclosures.
6. Turn on the power to the storage subsystem.
7. Restore storage subsystem host application operations.

Note: For more information about turning on a storage subsystem and turning it off, see the documentation that comes with your storage subsystem. For more information, see <http://www.ibm.com/systems/support/storage/disk/>.

See “DS4000 and DS5000 storage subsystem Fibre Channel drive loop schemes” on page 102 and “Setting enclosure IDs for enclosures in DS4000 and DS5000 storage

subsystems” for details about cabling storage subsystems and storage enclosures together and setting their enclosure IDs.

Setting enclosure IDs for enclosures in DS4000 and DS5000 storage subsystems

Note: All enclosures have enclosure IDs, including enclosures with SAS drive ports. For example, the DS3000 storage system and the EXP3000 and EXP3512 storage enclosures have enclosure IDs in the enclosure mid-plane. However, the enclosure IDs in enclosures with SAS ports were not used to calculate the arbitrated loop physical addresses (AL_PA) of the drives in a configuration as arbitrated as in the case of an enclosure with Fibre Channel drive ports. The only requirement for enclosures with SAS-ports in the mid-plane is that the enclosure IDs must be unique in the subsystem configuration.

Each drive enclosure (including the DS4000 or DS5000 storage subsystems with internal drive bays) in a storage subsystem configuration must have a unique drive enclosure ID. Controllers use a combination of the enclosure ID and the number of the physical bay that a hard disk drive occupies to create a unique loop address or arbitrated loop physical address (AL_PA) for each drive in a drive loop. The enclosure ID is a two-digit number. Best practice is to use the leftmost digit of the enclosure ID to differentiate enclosures from different redundant drive loop/channel pairs and the rightmost digit to differentiate enclosures in the same redundant drive loop/channel pair. The possible values for the digits are 0 through 9 for EXP395, EXP420, EXP500, EXP520, EXP810, EXP5000, and EXP5060 storage enclosures, and 0 through 7 for EXP100, EXP700, and EXP710 storage enclosures.

The enclosure ID of each enclosure (including the DS4000 or DS5000 storage subsystem with internal drive bays) in a redundant drive loop must have a unique rightmost digit. (This was previously a best practice, but it is now a requirement.) This setting enforces hard AL_PAs (unchangeable between Loop Initializations [LIPs]) for the drives and facilitates drive loop troubleshooting in the event of an error. If the rightmost digits are not unique, two or more devices have the same hard AL_PA. In such a case, the controller uses soft AL_PAs for the devices that have identical hard AL_PAs.

Important: Changing enclosure IDs on 14-drive enclosures and storage subsystems with the mechanical enclosure ID switch requires that the DS4000 storage subsystem and all enclosures in the configuration to be power cycled to activate the new settings. Changing the enclosure IDs on 16-drive storage enclosures (EXP395, EXP420, EXP520, EXP810, EXP5000, or EXP5060) and storage subsystems (DS3950, DS4200, DS4700, or DS5020) does not require that all enclosures and the DS4000 or DS5000 storage subsystems be power cycled, if no 14-drive enclosures are being intermixed in the configuration or if the 16-drive enclosures are connected only to a DS4000 storage subsystem with 16 internal drive bays (DS4200 or DS4700).

If the enclosure IDs are not currently set to have a unique rightmost digit for the enclosures in the same redundant drive loop pair, change the enclosure IDs in the next maintenance schedule. This limits unnecessary downtime when you add enclosures of different types (especially EXP810 storage enclosures) to the existing enclosures in the redundant drive loop pair.

You do not have to manually assign an enclosure ID for EXP810 and EXP5000 storage enclosures. The enclosure ID is automatically assigned. However, if you do

manually assign the enclosure ID for the EXP810 or EXP5000 storage enclosure, ensure that the enclosure ID of the EXP810 and EXP5000 storage enclosures in the same drive loop are unique.

Note: If you are using an EXP100, EXP710, and EXP810 storage enclosure in a drive loop, you must set the enclosure ID for the EXP100 and EXP710 storage enclosures. The enclosure ID of the EXP810 storage enclosure is automatically set.

The problem with soft AL_PA addressing is that addresses can change between LIPs. This possibility increases the difficulty of troubleshooting drive loop problems because it is difficult to determine whether the same device with a different address or a different device might be causing a problem. Because the DS4000 storage subsystem can support more enclosures than available values of the enclosure ID ones digit, Table 14 on page 31 suggests enclosure ID settings for various storage enclosure families to minimize soft addressing in a drive loop.

Soft AL_PA addressing might result in an excessive number of drive loop information events being posted in the DS4000 storage subsystem major events log (MEL) especially in a DS4000 storage subsystem that has different storage enclosure types intermixed in the same redundant drive loop pair (for example, DS4300 storage subsystem intermixed with EXP810 and EXP100 storage enclosures in the same drive loop).

Important: The best practice enclosure ID settings is designed to avoid having enclosure IDs of 0 (zero) in a drive loop/channel. Because of the physical design and movement of the mechanical enclosure ID switch, it is possible to leave the switch in a dead zone between ID numbers, which returns an incorrect enclosure ID to the storage management software. The most commonly returned enclosure ID is 0 (zero). In addition to causing the subsystem management software to report an incorrect enclosure ID, this behavior also results in an enclosure ID conflict error with the storage enclosure or DS4000 storage subsystem in which the ID is intentionally set to 0 (zero).

The DS3000, DS3500, DCS3700, DCS3700 with Performance Module Controllers, DS3950, DS4200 Express, DS4700 Express, and DS5020 storage subsystems and the EXP420, EXP810, EXP5000, DCS3700, and EXP5060 storage enclosures do not have mechanical ID switches and are not susceptible to this problem. These storage subsystems and storage enclosures automatically set the enclosure IDs. Do not change these settings, unless the automatic enclosure ID settings result in non-unique single digit settings for enclosures (including the storage subsystems with internal drive bays) in a drive loop/channel of the storage subsystems with Fibre Channel drive loops/channels.

Table 14 on page 31 suggests enclosure ID settings for enclosures in the first two drive loop/channel of the storage subsystems that can have up to 11 storage expansion enclosures in a drive loop to minimize soft AL_PAs. You can follow similar guidelines if you have more than two drive loops/channels behind a storage subsystem. For the second drive loop, the suggested enclosure IDs can be from 20 through 27 if there are eight or fewer enclosures in the first drive loop. Only enclosures with enclosure IDs of 20, 21, and 22 in the first drive loop and 40, 41, and 42 in the second drive loop have soft AL_PAs.

Table 14. Storage enclosure ID settings

Storage enclosures	Enclosure ID for enclosures in the first drive loop	Enclosure ID for enclosures in the second drive loop
1st unit	10	30
2nd unit	11	31
3rd unit	12	32
4th unit	13	33
5th unit	14	34
6th unit	15	35
7th unit	16	36
8th unit	17	37
9th unit	18 (for storage enclosures that have 0-9 as the rightmost digit such as an EXP500) or 21 (for storage enclosures that have 0-7 as the rightmost digit such as an EXP100, EXP700, and EXP710)	38 (for storage enclosures that have 0-9 as the rightmost digit) or 41 (for storage enclosures that have 0-7 as the rightmost digit)
10th unit	19 (for storage enclosures that have 0-9 as the rightmost digit) or 22 (for storage enclosures that have 0-7 as the rightmost digit)	39 (for storage enclosures that have 0-9 as the rightmost digit) or 42 (for storage enclosures that have 0-7 as the rightmost digit)
11th unit	20 (you can connect only EXP500 storage enclosures to up to 11 enclosures in a drive loop)	40 (you can connect only EXP500 storage enclosures to up to 11 enclosures in a drive loop)

DS4000 Fibre Channel and Serial ATA Intermix premium feature

The Fibre Channel/SATA Intermix premium feature supports the concurrent attachment of Fibre Channel and SATA storage enclosures to storage subsystem drive ports or intermixing Fibre Channel and SATA drives within the same storage enclosure behind a storage subsystem.

Notes:

1. For the most current information about the Fibre Channel/SATA Enclosure Intermix premium feature, see <http://www.ibm.com/systems/support/storage/disk/>.
2. You must purchase the DS4000 Fibre Channel/SATA Enclosure Intermix premium feature for each storage subsystem with drive channels/loops intermixing SATA and Fibre Channel technology drives.
3. There is no Fibre Channel/SATA Intermix premium feature option for the DS5000 storage subsystems. The Fibre Channel/SATA Intermix capability is built into the DS5000 storage subsystems. This feature is always enabled in DS5000 storage subsystems. In addition, the Premium Features window in a DS5000 storage subsystem does not display an entry for the Mix Drive Types (Fibre Channel/SATA) feature as one of the available options that can be enabled or disabled.

See the documentation that comes with the Fibre Channel/SATA Intermix premium feature option for the following detailed information:

- Intermix premium feature installation instructions
- Controller firmware requirements
- Supported combinations of DS4000 storage subsystems and storage enclosures
- Cabling schemes
- Important restrictions

The following restrictions apply to the use of the DS4000 Fibre Channel/SATA Intermix premium feature:

EXP100 storage enclosure cabling rules

When you intermix EXP100 storage enclosures with EXP710 and EXP810 storage enclosures behind a DS4700 or DS4800 storage subsystem, follow the cabling rules that are listed in “Cabling EXP100, EXP710, and EXP810 storage enclosures in DS4700 and DS4800 configurations” on page 109.

Setting Enclosure IDs with unique single-digit values

An enclosure ID is a two-digit number. An enclosure ID (sometimes known as a tray ID, or a server ID) consists of two digits. In 14-drive storage enclosures (EXP100/EXP700/EXP710), you can set the enclosure ID manually with the switches on the back of the storage enclosure. In a 16-drive storage enclosure, you can set the enclosure ID through the menu function in the DS Storage Manager Subsystem Management window. Ensure that the rightmost digit of the enclosure ID is unique for every enclosure in a redundant drive loop pair.

Grouping storage enclosures in a redundant drive loop

When you mix enclosures with Fibre Channel and SATA drives in a drive loop (DS4300/DS4400/DS4500 storage subsystem) or behind a drive channel port (DS4700/DS4800/DS5100/DS5300 storage subsystem), group the enclosures with the same drive interface technology or enclosures with drives of the same type (Fibre Channel or SATA) together.

Intermixing EXP100 and EXP710 storage enclosures

Attention: Before you intermix EXP710 and EXP100 storage enclosures in a DS4000 storage subsystem, you must purchase the IBM System Storage DS4000 SATA and Fibre Channel storage enclosure intermix entitlement. You must also check the controller firmware requirements in Table 7 on page 23 for intermix compatibility.

You can intermix EXP100, and EXP710 storage enclosures in the same drive loop. However, you must group all of the EXP710 storage enclosures together to enable the reliability, availability, and serviceability (RAS) features and to optimize the data transfer between the EXP710 storage enclosures.

Important: IBM does not support any configuration in which EXP710 storage enclosures are not grouped together.

Figure 1 on page 33 through Figure 3 on page 35 show three supported EXP710 storage enclosure intermixing cabling configurations in which all EXP710 storage enclosures are grouped together. In Figure 3 on page 35, the EXP710 storage enclosures are grouped together.

Although Figure 1 on page 33 through Figure 5 on page 37 incorporate the DS4000 and DS4300 storage subsystems as examples, other DS4000 storage subsystems

might be supported replacements. The DS4000 and EXP100 storage enclosure would also intermix successfully with an EXP710 storage enclosure.

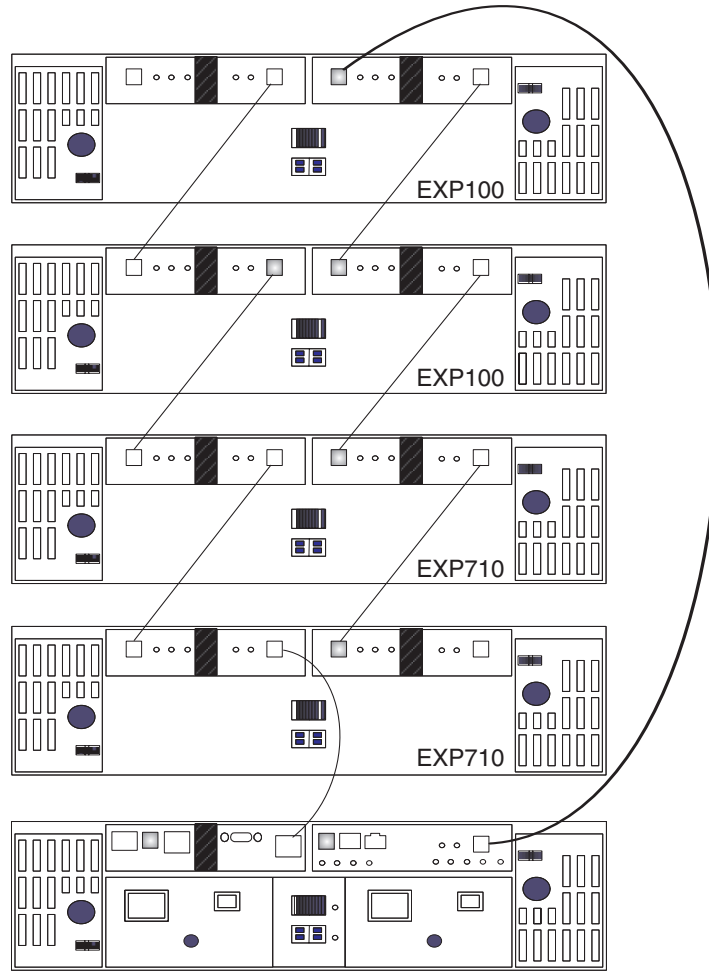

Figure 1. Supported intermixed EXP100 and EXP710 storage enclosure loop configuration (1 of 3)

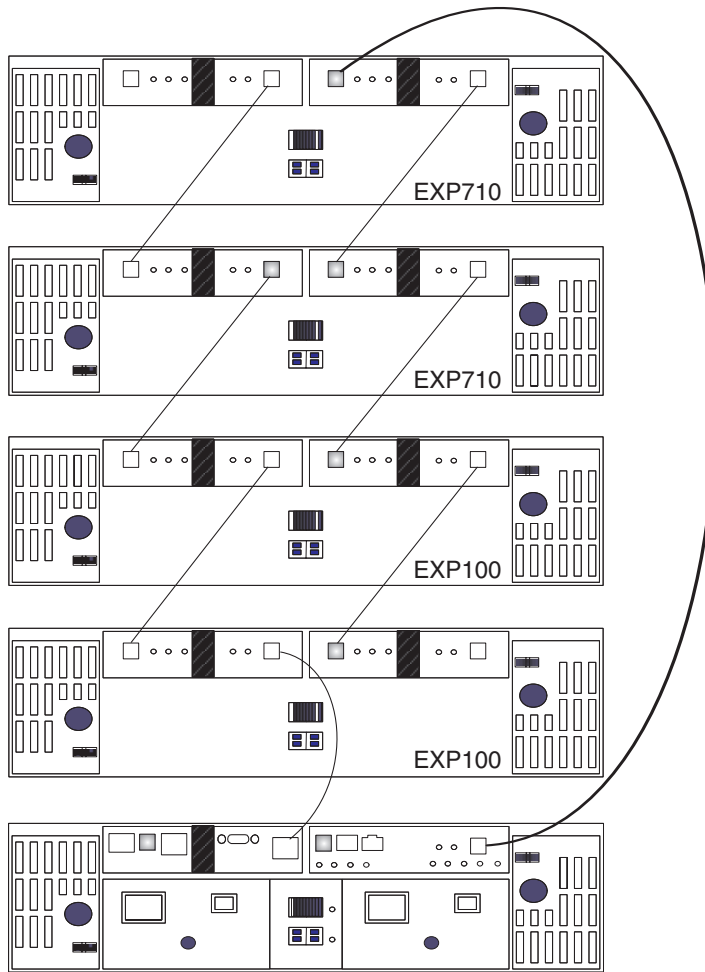

Figure 2. Supported intermixed EXP100 and EXP710 storage enclosure loop configuration (2 of 3)

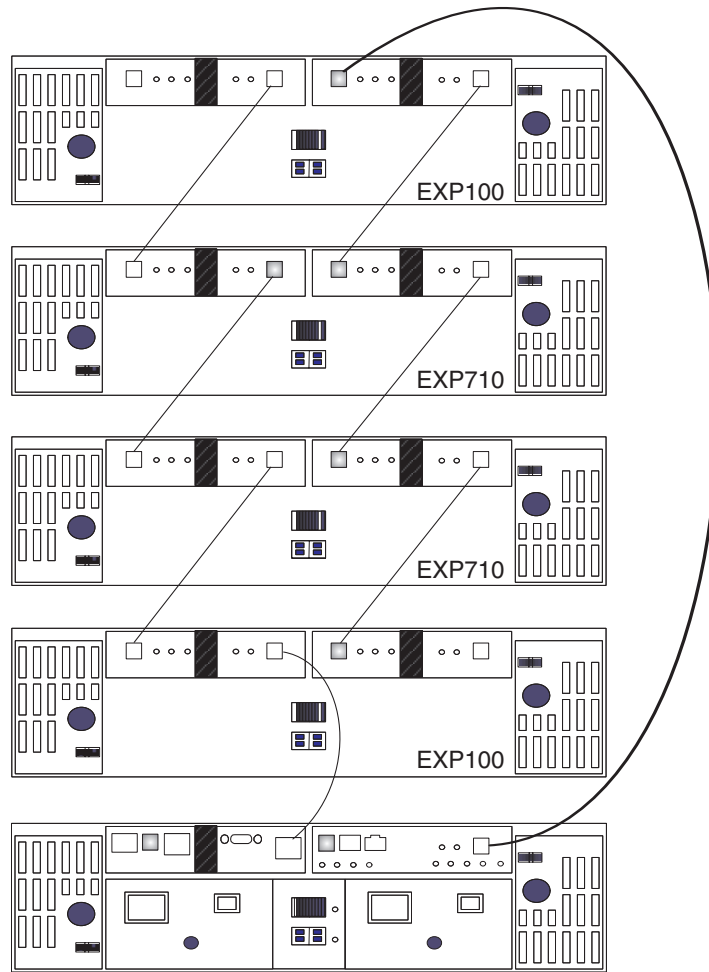

Figure 3. Supported but not best practice intermixed EXP100 and EXP710 storage enclosure loop configuration (3 of 3)

In Figure 4 on page 36 and Figure 5 on page 37, the intermixed configurations shown are not supported because the EXP710 storage enclosures in the redundant drive loop are not grouped together.

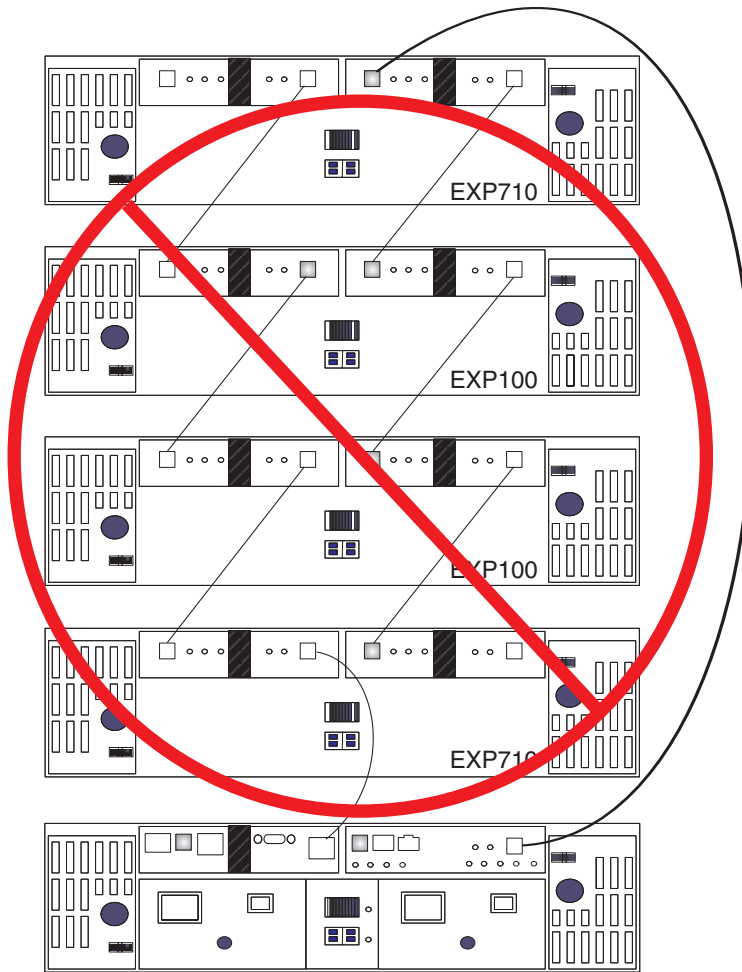

Figure 4. Unsupported intermixed EXP100 and EXP710 storage enclosure loop configuration (1 of 2)

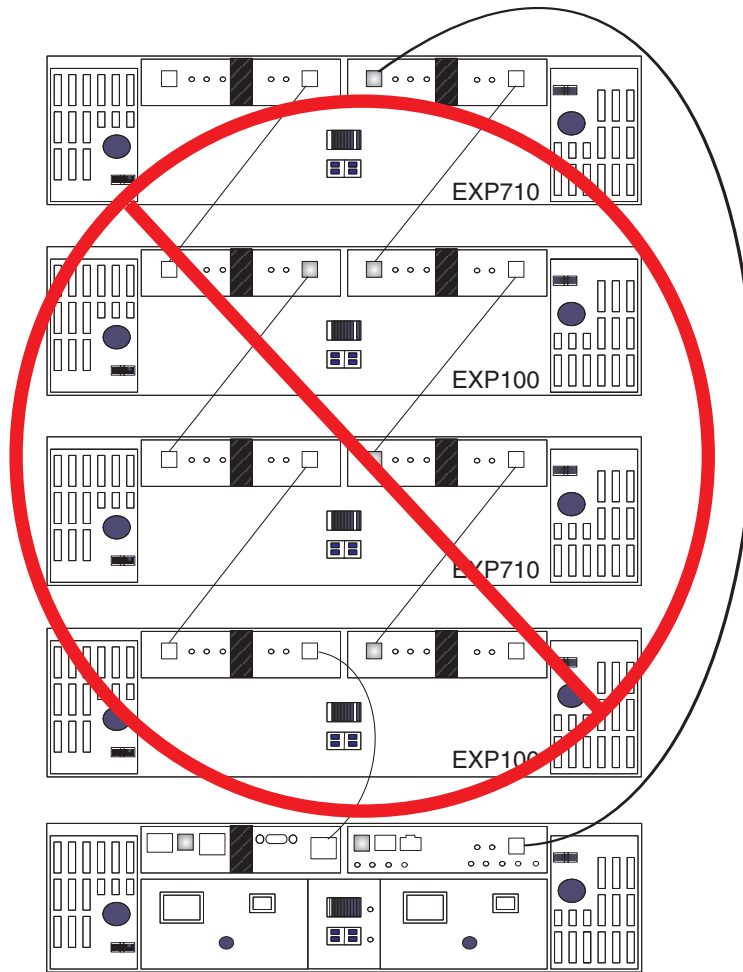

Figure 5. Unsupported intermixed EXP100 and EXP710 storage enclosure loop configuration (2 of 2)

Intermixing EXP395 and EXP810 storage enclosures

You can attach the EXP810 storage enclosure to the DS3950 storage subsystem only after you purchase the Attach EXP810 storage enclosure to DS3950 Activation option and activate it in the DS3950 storage subsystem.

When you cable an EXP810 storage enclosure behind a DS5020 storage subsystem, the EXP810 storage enclosure is cabled in the same manner as an EXP395 storage enclosure. There are no special requirements to cable a mix of EXP810 and EXP395 storage enclosures behind a DS3950 storage subsystem.

Intermixing EXP520 and EXP810 storage enclosures

You can attach the EXP810 storage enclosure to the DS5020 storage subsystem only after you purchase the Attach EXP810 storage enclosure to DS5020 Activation option and activate it in the storage subsystem.

When you cable an EXP810 storage enclosure behind a DS5020 storage subsystem, the EXP810 storage enclosure is cabled in the same manner as an EXP520 storage enclosure. There are no special requirements to cable a mix of EXP810 and EXP520 storage enclosures behind a DS5020 storage subsystem.

Intermixing EXP810 with EXP100 and EXP710 storage enclosures

With controller firmware 6.23.xx.xx.xx or later, DS4300, DS4500, DS4700, and DS4800 storage subsystems support the intermixing of the EXP810 storage enclosure with EXP710 and EXP100 storage enclosures.

Although storage enclosures (EXP710 and EXP810 storage enclosures) do not have to be grouped by drive enclosure type, group them by enclosure type in a redundant drive channel pair to simplify maintenance and troubleshooting. In addition, the EXP810 storage enclosure link rate switch must be set at 2 Gbps.

Notes:

1. The link rate setting becomes effective only after the EXP810 storage enclosure is turned on. Do not change the setting while the EXP810 storage enclosure is operational. Schedule a time to shut down the entire DS4000 configuration to change the link rate speed setting.
2. You must follow specific restrictions when you intermix EXP100 with EXP710 and EXP810 storage enclosures in a DS4700 or DS4800 storage subsystem. See “Cabling EXP100, EXP710, and EXP810 storage enclosures in DS4700 and DS4800 configurations” on page 109 for details.

There are limits to the number of Fibre Channel hard disk drives that you can configure in redundant drive channel pairs. The maximum number of drives dictates a fixed number of supported EXP100 and EXP710 and EXP810 storage enclosure combinations. Table 15 lists the number of EXP100, EXP710, and EXP810 storage enclosures that you can combine for use in a single redundant drive channel/loop pair. The table assumes that a DS4000 storage subsystem is generally capable of addressing the maximum of 112 Fibre Channel hard disk drives for each redundant drive channel/loop pair.

Table 15. Supported EXP810, EXP710, and EXP100 storage enclosure combinations per redundant drive channel/loop pair in a DS4000 configuration with no internal drive bays configuration

Total EXP810 storage enclosures per redundant drive channel/loop pair	Total EXP710, EXP100, or both storage enclosures per redundant drive channel/loop pair	Maximum storage expansion drives per redundant drive channel/loop pair	Maximum drives in mixed EXP100, EXP710, and EXP810 drive channel/loop pair
0	8	8	112
1	6	7	100
2	5	7	102
3	4	7	104
4	3	7	106
5	2	7	108
6	1	7	110
7	0	7	112

Do not mix EXP100, EXP710, and EXP810 storage enclosures together in the same redundant drive channel/loop pair if you plan to operate the EXP810 storage enclosure at a higher speed. Connect all of the EXP710 and EXP100 storage enclosures to a redundant drive channel pair and all of the EXP810 storage enclosures to the other redundant drive channel pair in a DS4800 configuration.

Table 16 shows the supported EXP810 and EXP710 storage enclosures combinations per redundant drive channel/loop pair in a DS4700 Express configuration. The table assumes that a DS4700 Express storage subsystem is generally capable of addressing the maximum of 112 Fibre Channel hard disk drives for each redundant drive channel/loop pair.

The DS4700 Express storage subsystem (with its internal drives) is already counted as one enclosure against the maximum number of enclosures that can be in a redundant channel/loop pair.

Table 16. Supported EXP810 and EXP710/EXP100 storage enclosure combinations per redundant drive channel/loop pair in a DS4700 Express storage subsystem

EXP810 storage enclosures	Total drives in the EXP810 storage enclosures	EXP710 and EXP100 storage enclosures	Total drives in the EXP100 and EXP710 storage enclosures	Total drives in the DS4700 Express storage subsystem	Total drives in a mixed EXP710/EXP100 and EXP810 drive loop
0	0	6	84	16	100
1	16	5	70	16	102
2	32	4	56	16	104
3	48	3	42	16	106
4	64	2	28	16	108
5	80	1	14	16	110
6	96	0	0	16	112

Attention:

1. Do not connect a combination of more than eight EXP710/EXP100 storage enclosures or seven EXP810 storage enclosures to the two ports of a dual-ported drive channel. Failure to observe this limitation might result in loss of data availability.
2. Do not connect more than four EXP810 storage enclosures to each port of the dual-ported drive channel. There are no restrictions to four or fewer storage enclosures connected per drive port for the EXP710 and the EXP100 storage enclosures; however, to maximize drive channel performance, use the same rule for the EXP710 and EXP100 storage enclosures.
3. Add storage enclosures to the DS4800 storage subsystem drive ports in a round-robin fashion. For example, if four EXP810 storage enclosures are cabled to the DS4800 storage subsystem, instead of cabling all four EXP810 storage enclosures to one drive port of a drive channel, you must distribute the enclosures to all drive ports, which results in one enclosure per drive port of a drive channel.
4. Do not connect more than the maximum number of enclosures per drive channel (eight for 14-drive and seven for 16-drive enclosures). When you mix 14-drive and 16-drive enclosures, the maximum number of storage enclosures is seven per redundant drive channel pair.
5. The DS4800 storage subsystem supports storage enclosures that operate at different Fibre Channel speeds (for example, 2 Gbps or 4 Gbps) only when they are installed in separate redundant drive channel pairs. The DS4800 storage subsystem does not support a mix of storage enclosures that operate at different Fibre Channel speeds in the same redundant drive channel pair.
6. Although you can intermix EXP710 and EXP810 storage enclosures in the same redundant drive channel pair, to facilitate maintenance and troubleshooting in the event of failures, cable together storage enclosures of the same type. For example, if EXP710 and EXP810 storage enclosures are in the same redundant drive channel pair, it is a best practice to group the EXP710 storage enclosures together and the EXP810 storage enclosures together.

Table 17 shows the supported storage enclosures combinations per redundant drive channel/loop pair in a DS4300 turbo storage subsystem, if the storage subsystem supports the maximum of 112 Fibre Channel hard disk drives for each redundant drive channel/loop pair.

Table 17. Combinations of 14-drive and 16-drive storage enclosures per drive loop for DS4300 dual controller turbo storage subsystems only

EXP810 storage enclosures	Drives in EXP810 storage enclosures	EXP710 and EXP100 storage enclosures	Drives in EXP710/ EXP100 storage enclosures	Drives in DS4300 storage subsystem	Drives in a mix EXP710 and EXP810 storage enclosures drive loop
0	0	7	98	14	112
1	16	5	70	14	100
2	32	4	56	14	102
3	48	3	42	14	104
4	64	2	28	14	106
5	80	1	14	14	108
6	96	0	0	14	110

Figure 6 and Figure 7 on page 42 illustrate supported cabling of EXP710 and EXP810 storage enclosures in a mixed configuration.

Figure 8 on page 43 shows a bestpractice cabling example of the EXP810 and EXP710 storage enclosures in the same drive channel pair in a DS4800 storage subsystem. All of the EXP810 storage enclosures are cabled together to one port of the dual-port drive channel in each of the controllers. Similarly, all of the EXP710 storage enclosures are cabled together to the other port of the dual-port drive channel.

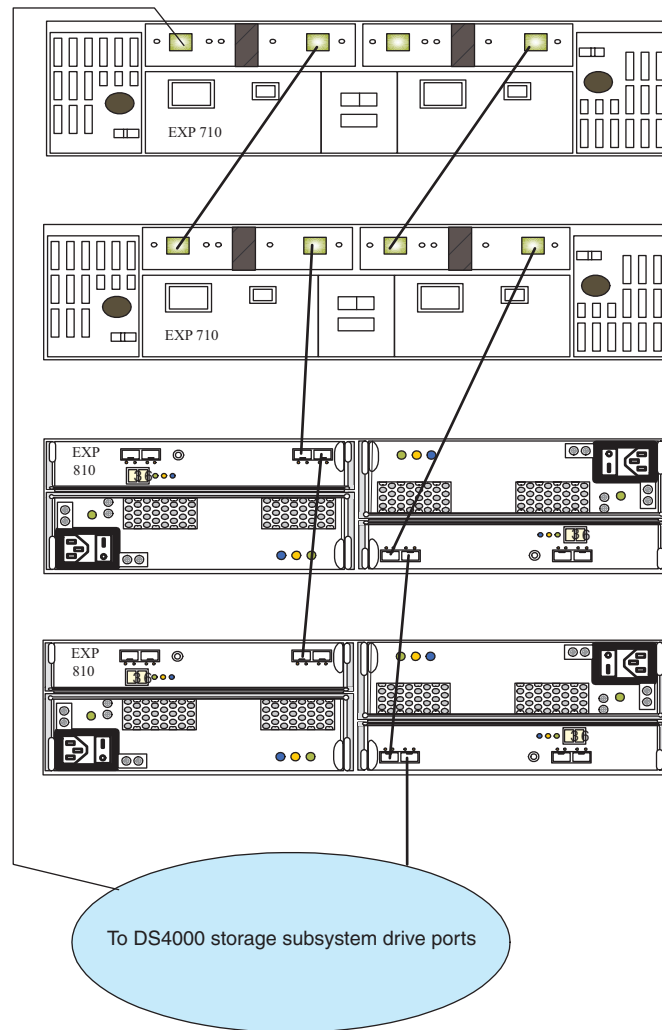

Figure 6. Supported intermixed DS4000 storage subsystem connected to EXP710 and EXP810 storage enclosure loop configuration

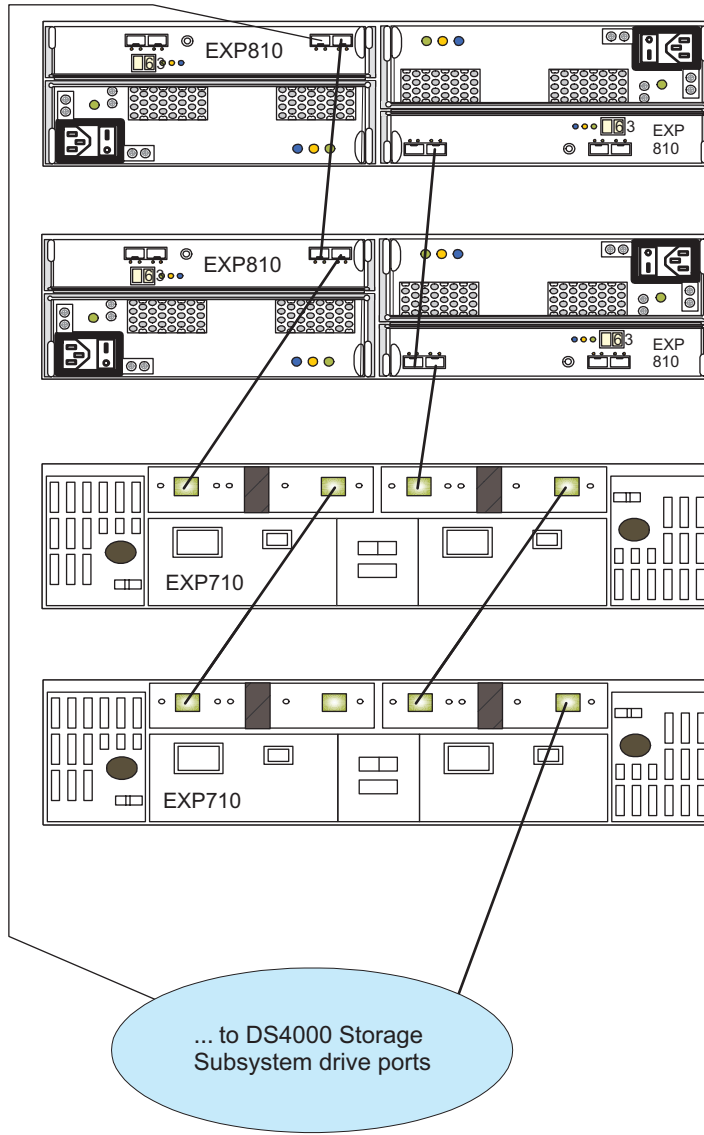

Figure 7. Supported intermixed DS4000 storage subsystem connected to EXP710 and EXP810 storage enclosure loop configuration

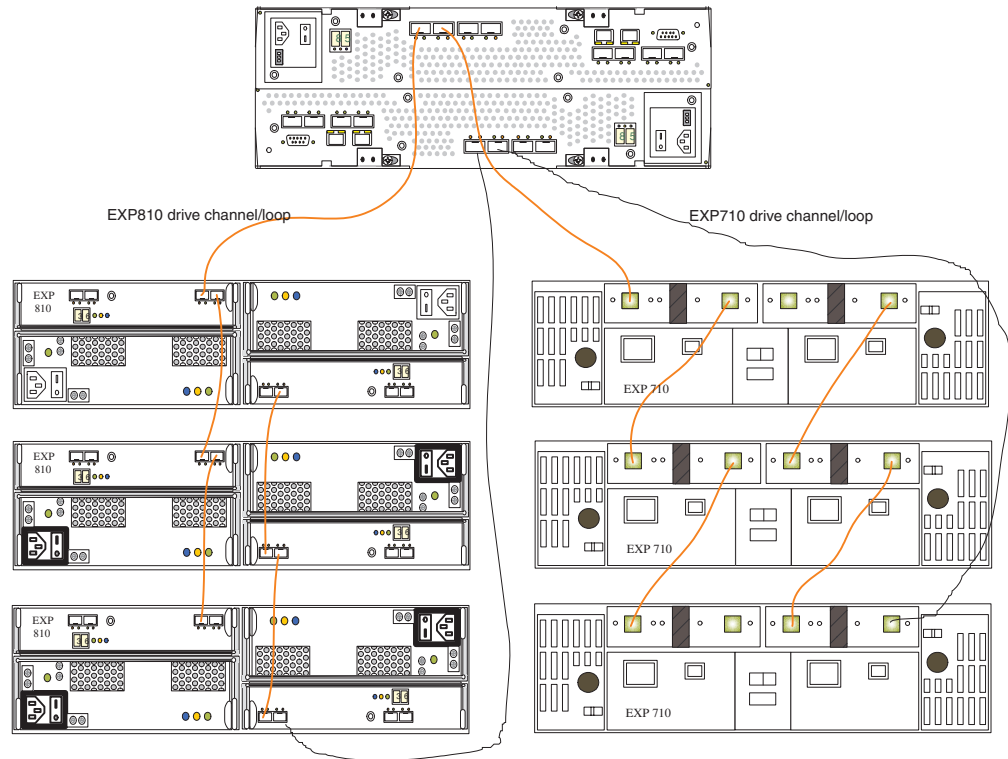

Figure 8. Best practice intermixed DS4000 storage subsystem connected to EXP710 and EXP810 storage enclosure loop configuration

Intermixing EXP810 and EXP5000 storage enclosures

For client investment protection, you can migrate existing EXP810 storage enclosures from currently installed DS4700 or DS4800 storage subsystems to attach to a DS5100 or DS5300 storage subsystem. A request for price quote (RPQ) approval is required for support of all migration configurations. You must give special consideration to proper firmware levels and careful coordination of differences in warranty and maintenance terms. You can submit an RPQ through the normal request process. Purchase of new EXP810 storage enclosures to attach to DS5100 or DS5300 storage subsystem is not supported or configurable in eConfig.

When you cable EXP810 storage enclosures behind a DS5100 or DS5300 storage subsystem, EXP810 storage enclosures are cabled in the same manner as EXP5000 storage enclosures. There are no special requirements to cable a mix of EXP810 and EXP5000 storage enclosures behind a DS5100 or DS5300 storage subsystem.

Intermixing EXP5000 and EXP5060 storage enclosures

The following notes describe information that you must consider when you connect the EXP5000 and EXP5060 storage enclosures in the same storage subsystem redundant drive loop/channel:

- Use the non-trunk cabling scheme to connect the EXP5000 and EXP5060 storage enclosure to the DS5100 or DS5300 drive channel/ports.
- A maximum of three EXP5000 storage enclosures and one EXP5060 storage enclosure can be connected in the same redundant drive loop/channel.

- Cable the EXP5000 and EXP5060 storage enclosures behind the same pair of drive channel ports only if necessary. Best practice is to dedicate the full drive channel (two ports per controller) for cabling the EXP5060 storage enclosure to the storage subsystem controllers to allow the trunked-cabling scheme to be used.
- If the Up to 8 EXP5060 storage enclosure attached feature pack is enabled, the DS5100 or DS5300 storage subsystem supports only EXP5060 storage enclosures in the configuration.

Figure 9 shows a bestpractice cabling example EXP5000 and EXP5060 storage enclosure cabled in the same redundant drive/loop channel.

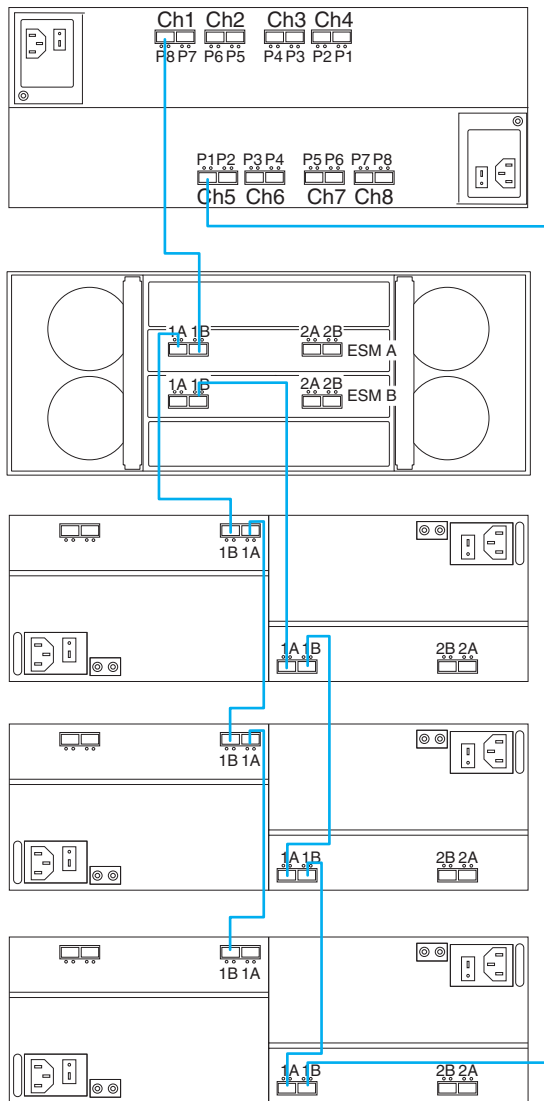

Figure 9. Best practice intermixed EXP5000 and EXP5060 storage enclosure drive/loop cable configuration

Intermixing storage enclosures for DS4000 and DS5000 storage subsystems

This section describes the steps to intermix storage enclosures.

The following notes describe information that you must consider when you connect storage enclosures to the storage subsystem:

- The DS4000 storage subsystem supports the connection of a maximum of two redundant drive loop pairs. The DS5000 storage subsystem supports a maximum of four redundant drive loop pairs. The maximum number of storage enclosures per drive loop depends on the type of storage enclosure and whether intermixing storage enclosures of different drive bays is permitted.
- The maximum number of drives in a storage subsystem configuration varies by model. Some models require additional feature option purchases to enable you to connect the maximum number storage enclosures behind it.
- When you connect the storage enclosures to drive mini hubs, do not use all ports in each of the drive mini hubs in the DS4400 or DS4500 storage subsystem. Connect the Fibre Channel cable to only one port of the drive mini hub and leave the other port unoccupied. However, when you connect the storage enclosures to drive channel ports (such as on the DS4200, DS4700, DS4800, DS5020, DS5100, and DS5300 storage subsystem), use all ports in each of the drive channels. Figure 10 illustrates connecting eight storage enclosures to the DS5000 storage subsystem. The eight enclosures are connected to use all of the drive channel ports in the DS5000 storage subsystem instead of stacking the storage enclosures behind a subset of drive channel ports.

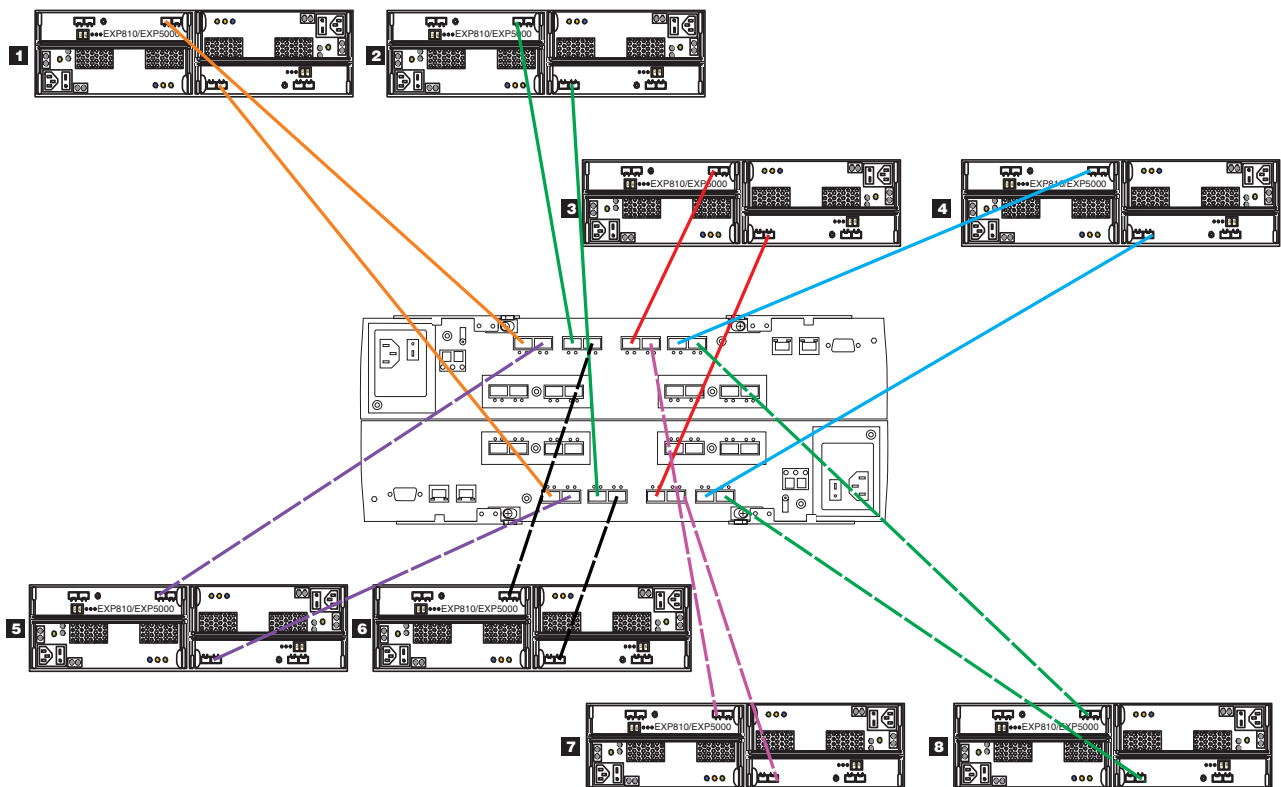

Figure 10. Use all drive channel ports when connecting storage enclosures

- When you cable different types of storage enclosures, if possible, do not mix different types of storage enclosures in the same redundant drive loop pair. Also, when you mix different types of storage enclosures in the same drive channel pair, the link rate setting must be the same for each storage enclosure. IBM does not support different enclosure speed settings in the same drive loop.

The following notes describe information that you must consider when you connect storage enclosures to the storage subsystem:

- Ensure that the enclosure ID of each enclosure in a storage subsystem configuration is unique. For more information, see “Setting enclosure IDs for enclosures in DS4000 and DS5000 storage subsystems” on page 29.
- If it is not possible to avoid mixing different enclosure types in the same redundant drive loop pair, this rule must be strictly observed. When you mix EXP810 and EXP710 storage enclosures in the same drive loop with EXP100 storage enclosures, all of the EXP810 and EXP710 storage enclosures must be grouped together with the EXP100 storage enclosures connected to either end of the storage enclosure group. With this grouping, the controller firmware identifies the EXP810 and EXP710 storage enclosures as the same enclosure type (switched disk storage enclosure, which has an ESM-embedded Fibre Channel loop switch). These two enclosure models must be grouped together if they are contained within a drive loop.

Note: You must cable all of the EXP810 storage enclosures together, followed by all of the EXP710 storage enclosures. Figure 12 on page 49 and Figure 13 on page 50 are examples of correctly cabling the intermix of EXP100 with EXP810 and EXP710 storage enclosures. Figure 14 on page 51 and Figure 15 on page 52 are examples of incorrectly cabling the intermix of these enclosures. One shows the EXP100 storage enclosures cabled between the EXP810 and EXP710 storage enclosures, and the other shows the EXP810 and EXP710 storage enclosures intermingled.

- The storage subsystem drive expansion port must always be connected to the EXP420/EXP520/EXP810/EXP5000 storage enclosure port 1B. Figure 16 on page 53 is an example of correctly cabling the EXP420/EXP520/EXP810/EXP5000 storage enclosure 1B ports to the storage subsystem drive expansion port. Figure 17 on page 54 is an example of incorrect cabling that shows the connection from the storage subsystem drive expansion port to the incorrect EXP420/EXP520/EXP810/EXP5000 storage enclosure port, labeled 1A.
- The storage subsystem drive expansion port must always be connected to the left ESM In port of the last enclosure in a redundant drive loop pair. In addition, the drive expansion port must always be connected to the right ESM Out port of the first enclosure in a redundant drive loop/channel pair. The exception to this rule is when an EXP100 storage enclosure is the first enclosure directly connected to controller A of a DS4700 or DS4800 storage subsystem. In this case, cable from the storage subsystem controller drive port A to the OUT port on the left ESM (ESM A) of the EXP100 storage enclosure. See “Cabling EXP100, EXP710, and EXP810 storage enclosures in DS4700 and DS4800 configurations” on page 109 for details.

Figure 18 on page 55 shows this correct cabling to the 10- or 14-drive storage enclosure ESM ports.

General rules for cabling storage enclosures

The following notes describe information that you must consider when you connect storage enclosures to the storage subsystem:

- The DS4000 storage subsystem supports the connection of a maximum of two redundant drive loop pairs. The DS5000 storage subsystem supports a maximum of four redundant drive loop pairs. The maximum number of storage enclosures per drive loop depends on the type of storage enclosure and whether intermixing storage enclosures of different drive bays is permitted.

- The maximum number of drives in a storage subsystem configuration varies by model. Some models require additional feature option purchases to enable you to connect the maximum number storage enclosures behind it.
- When you connect the storage enclosures to drive mini hubs, do not use all ports in each of the drive mini hubs in the DS4400 or DS4500 storage subsystem. Connect the Fibre Channel cable to only one port of the drive mini hub and leave the other port unoccupied. However, when you connect the storage enclosures to drive channel ports (such as on the DS4200, DS4700, DS4800, DS5020, DS5100, and DS5300 storage subsystem), use all ports in each of the drive channels. Figure 11 illustrates connecting eight storage enclosures to the DS5000 storage subsystem. The eight enclosures are connected to use all of the drive channel ports in the DS5000 storage subsystem instead of stacking the storage enclosures behind a subset of drive channel ports.

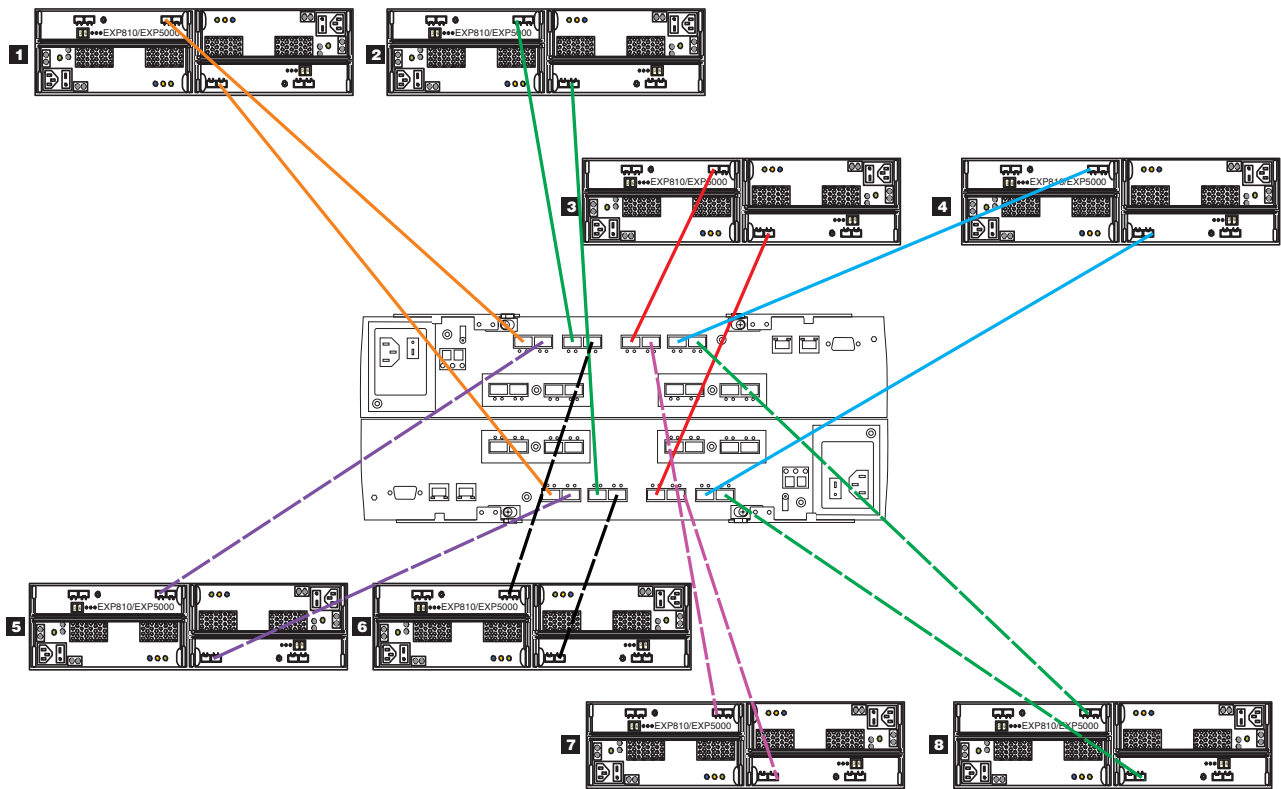

Figure 11. Use all drive channel ports when connecting storage enclosures

- When you cable different types of storage enclosures, if possible, do not mix different types of storage enclosures in the same redundant drive loop pair. Also, when you mix different types of storage enclosures in the same drive channel pair, the link rate setting must be the same for each storage enclosure. IBM does not support different enclosure speed settings in the same drive loop.

The following notes describe information that you must consider when you connect storage enclosures to the storage subsystem:

- Ensure that the enclosure ID of each enclosure in a storage subsystem configuration is unique. For more information, see .
- If it is not possible to avoid mixing different enclosure types in the same redundant drive loop pair, this rule must be strictly observed. When you mix EXP810 and EXP710 storage enclosures in the same drive loop with EXP100 storage enclosures, all of the EXP810 and EXP710 storage enclosures must be

grouped together with the EXP100 storage enclosures connected to either end of the storage enclosure group. With this grouping, the controller firmware identifies the EXP810 and EXP710 storage enclosures as the same enclosure type (switched disk storage enclosure, which has an ESM-embedded Fibre Channel loop switch). These two enclosure models must be grouped together if they are contained within a drive loop.

Note: You must cable all of the EXP810 storage enclosures together, followed by all of the EXP710 storage enclosures. and are examples of correctly cabling the intermix of EXP100 with EXP810 and EXP710 storage enclosures. and are examples of incorrectly cabling the intermix of these enclosures. One shows the EXP100 storage enclosures cabled between the EXP810 and EXP710 storage enclosures, and the other shows the EXP810 and EXP710 storage enclosures intermingled.

- The storage subsystem drive expansion port must always be connected to the EXP420/EXP520/EXP810/EXP5000 storage enclosure port 1B. is an example of correctly cabling the EXP420/EXP520/EXP810/EXP5000 storage enclosure 1B ports to the storage subsystem drive expansion port. is an example of incorrect cabling that shows the connection from the storage subsystem drive expansion port to the incorrect EXP420/EXP520/EXP810/EXP5000 storage enclosure port, labeled 1A.
- The storage subsystem drive expansion port must always be connected to the left ESM In port of the last enclosure in a redundant drive loop pair. In addition, the drive expansion port must always be connected to the right ESM Out port of the first enclosure in a redundant drive loop/channel pair. The exception to this rule is when an EXP100 storage enclosure is the first enclosure directly connected to controller A of a DS4700 or DS4800 storage subsystem. In this case, cable from the storage subsystem controller drive port A to the OUT port on the left ESM (ESM A) of the EXP100 storage enclosure. See for details.
shows this correct cabling to the 10- or 14-drive storage enclosure ESM ports.

Storage enclosure cabling diagrams

The following diagrams illustrate the information that is provided in “General rules for cabling storage enclosures” on page 46. The controllers that are illustrated in the cabling diagrams do not represent any specific storage subsystem.

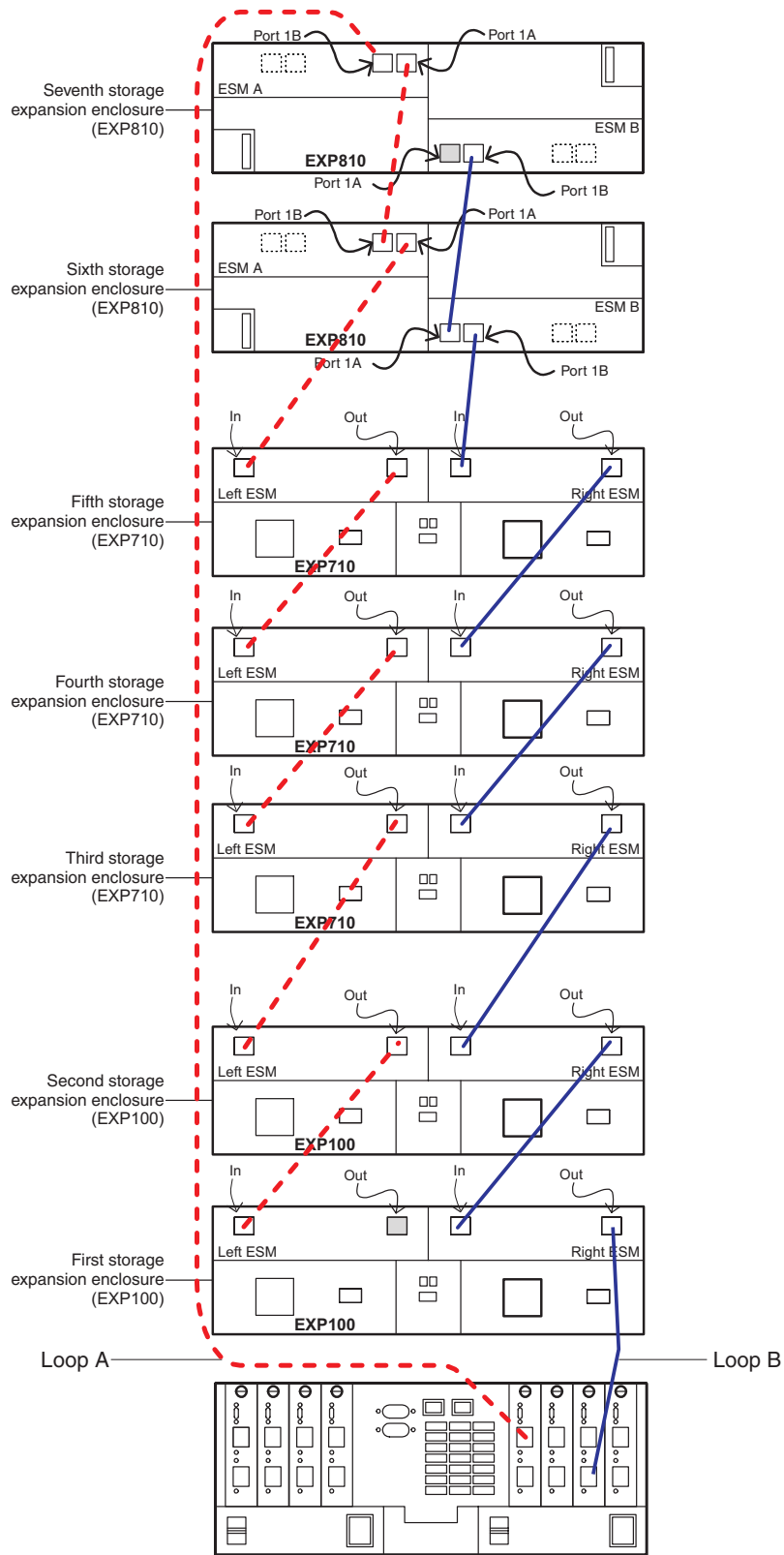

Figure 12. Supported cabling for an intermix of EXP100, EXP710, and EXP810 storage enclosures (example 1)

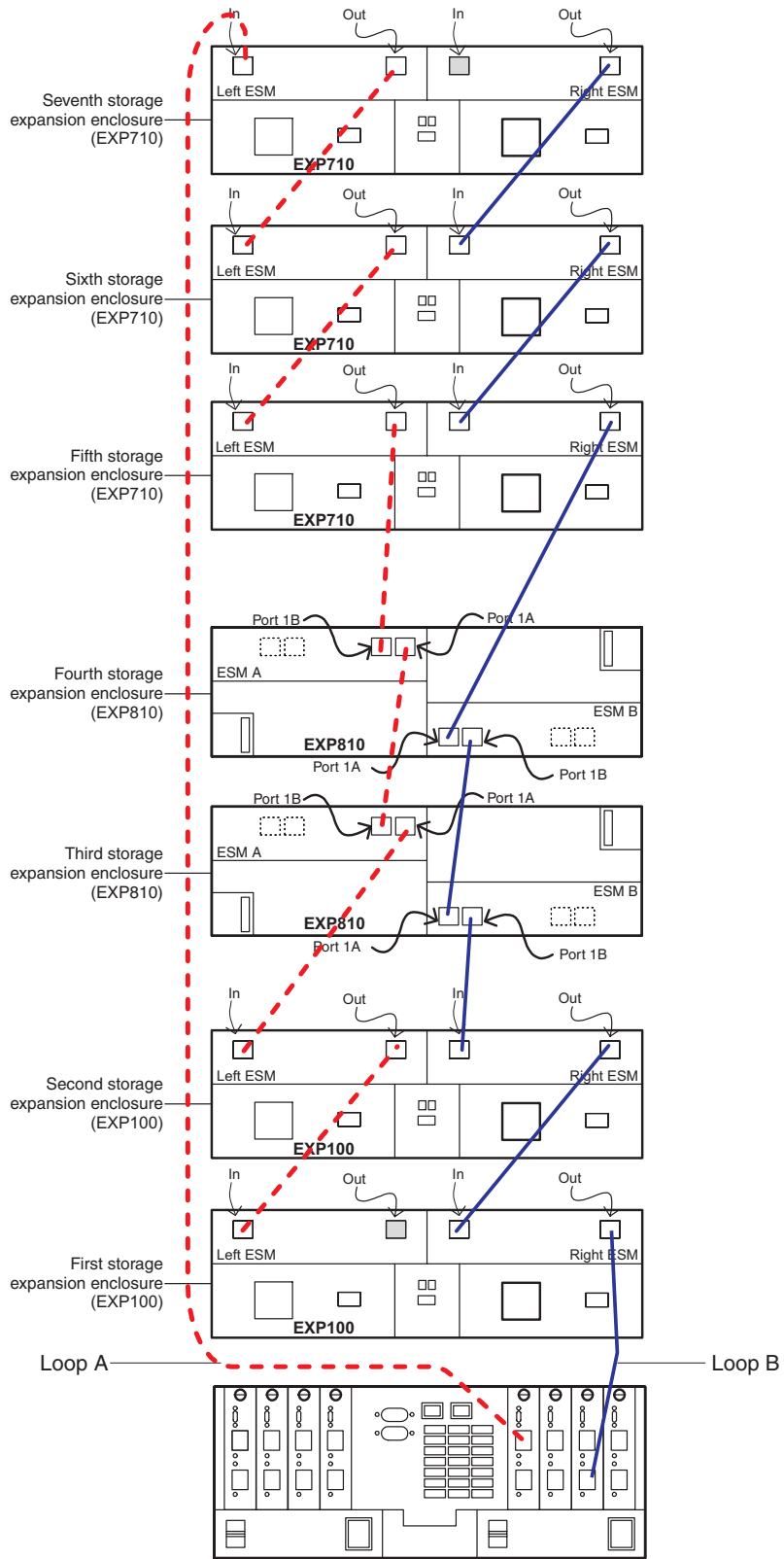

Figure 13. Supported cabling for an intermix of EXP100, EXP710, and EXP810 storage enclosures (example 2)

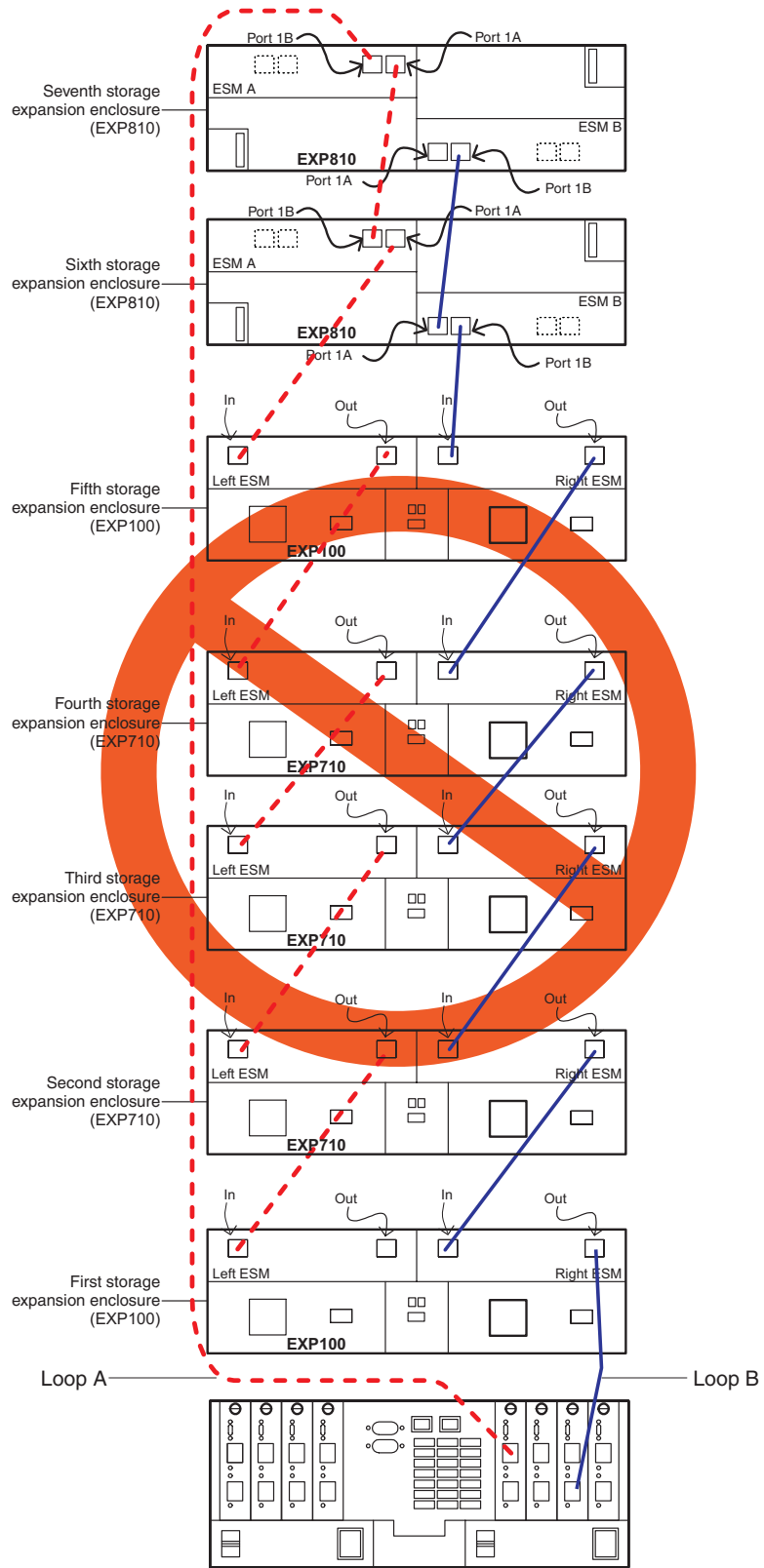

Figure 14. Unsupported cabling for an intermix of EXP100, EXP710, and EXP810 storage enclosures (example 1)

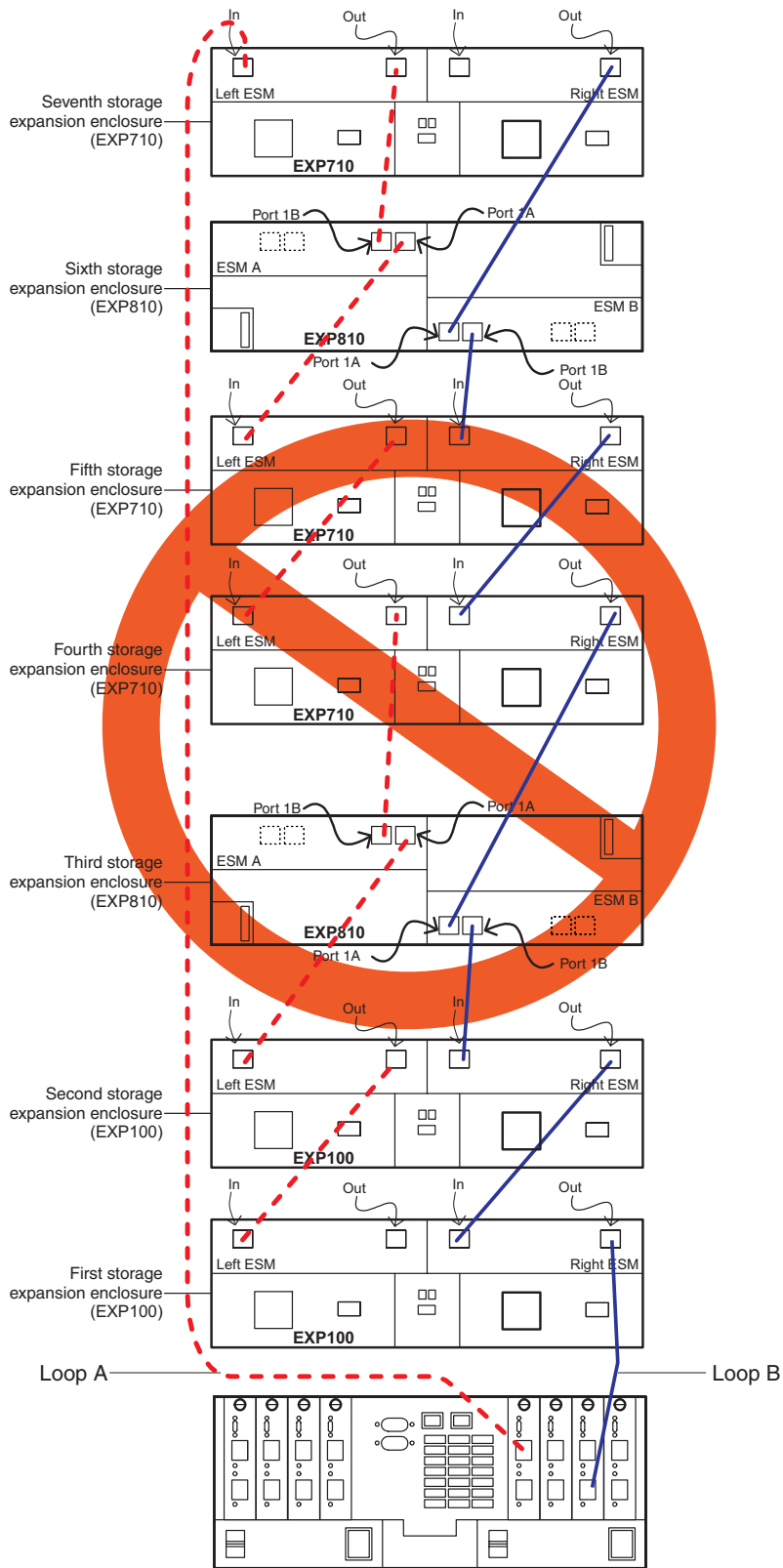

Figure 15. Unsupported cabling for an intermix of EXP100, EXP710, and EXP810 storage enclosures (example 2)

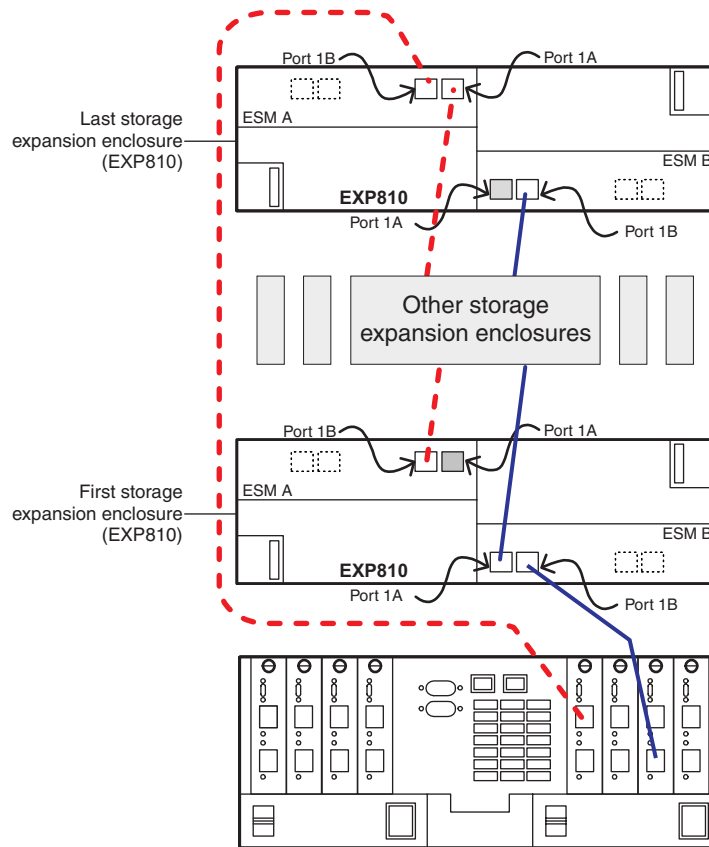

Figure 16. Supported cabling to EXP420/EXP520/EXP810/EXP5000 storage enclosure port 1B

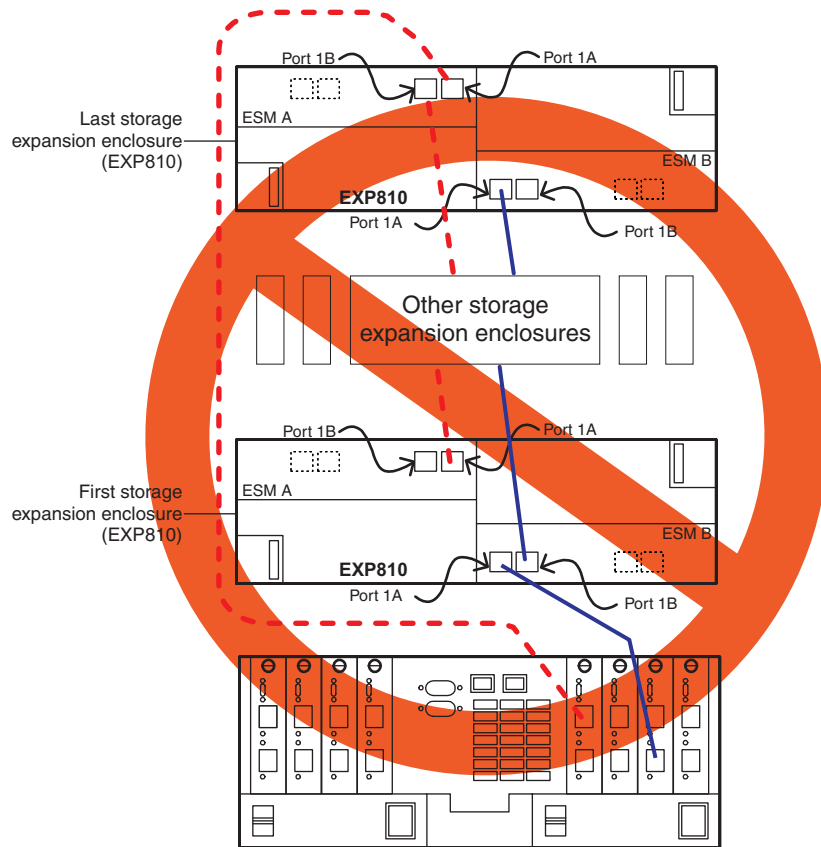

Figure 17. Unsupported cabling to the EXP420/EXP520/EXP810/EXP5000 storage enclosure port

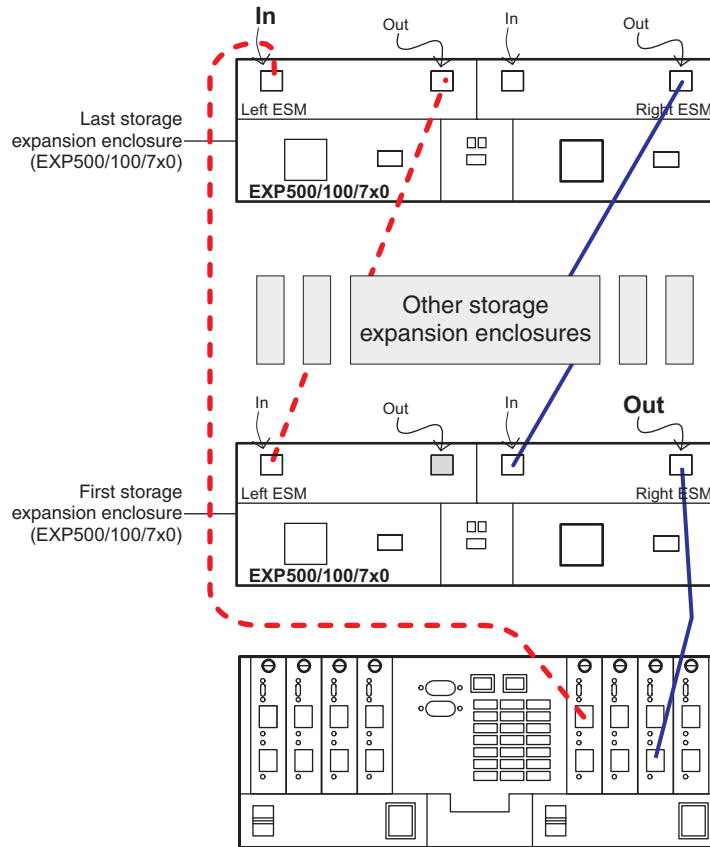

Figure 18. Supported cabling to the EXP500/EXP100/EXP700/EXP710 storage enclosure ports

Chapter 2. Adding or migrating hard disk drives

To add hard disk drives to the storage subsystem configuration or place the drives (that made up a RAID array) in different drive bays, see the following sections:

- To add new hard disk drives to an existing storage subsystem, see “Adding new hard disk drives” on page 58.

Note: Any hard disk drive might contain configuration data. Unless you intend to migrate drives from another storage subsystem (retaining its configuration data), always use this procedure to add hard disk drives to an existing storage subsystem configuration.

- To add new unassigned drives in different drive bays, see “Adding new hard disk drives” on page 58.
- To migrate drives from one storage subsystem configuration to another, see “Migrating hard disk drives” on page 59.
- To rearrange the drives (that made up a RAID array) in different drive bays in the same storage subsystem, see “Migrating arrays within the same storage subsystem” on page 66.

Before you begin, review Chapter 1, “Prerequisites to adding capacity and hard disk drive migration,” on page 1 and “General rules for cabling storage enclosures” on page 46.

Considerations

The following notes describe information that you must consider when you add a hard disk drive to a controller or a storage enclosure:

- Observe proper electrostatic discharge (ESD) procedures when you handle electronic equipment. For more information, see “Handling static-sensitive devices” on page 58.
- Never alter the physical configuration of a storage subsystem while the power is turned off unless you are instructed to do so as part of a configuration procedure. Specifically, never attach storage components to, or remove storage components from, a configured storage subsystem while the power is turned off.
- Updated readme files contain important configuration and procedural information that supersede information in this document. Always check the readme file before you perform any procedure or activity described in this document. To access the most recent readme file, see “Finding Storage Manager software, controller firmware, and readme files” on page 145.
- Before you migrate hard disk drives, complete the following steps to establish drive model compatibility:
 1. Check the drive CRU form factor options.
 2. If the form factors are not the same, there are no replacement parts such as bezels and drive trays. For more information, see the announcement letter, the *Installation, User’s, and Maintenance Guide* for your storage subsystem, and your IBM marketing representative or authorized reseller.
 3. If the form factors are the same, check to determine whether the drive is supported by the storage subsystem.
 4. Ensure that the drive can operate at the storage subsystem drive loop/channel Fibre Channel or SAS speed. For more information, see the

documentation for your storage subsystem, the storage subsystem profile, the announcement letters at the IBM website, or contact your IBM marketing representative or authorized reseller.

- You can migrate drives from systems that have controller firmware level 6.xx or earlier to storage subsystems that have controller firmware level 7.xx or later, or DS Storage Manager software version 10.xx or later. (For information about the type of logical drives that can be migrated, see item 12 on page 11.) However, you cannot migrate drives from systems with controller firmware version 7.xx or later to systems with controller firmware level 6.xx or earlier.

Ensure that the controller firmware level of both the source and target storage subsystems. Upgrade both the source and target storage subsystems to the same controller firmware if possible.

Handling static-sensitive devices

Attention: Static electricity can damage electronic devices and your system. To avoid damage, keep static-sensitive devices in their static-protective packages until you are ready to install them.

To reduce the possibility of electrostatic discharge (ESD), observe the following precautions:

- Limit your movement. Movement can cause static electricity to build up around you.
- Handle the device carefully, holding it by its edges or its frame.
- Do not touch solder joints, pins, or exposed printed circuitry.
- Do not leave the device where others can handle and damage it.
- While the device is still in its static-protective package, touch it to an *unpainted* metal part of the system unit for at least 2 seconds. This drains static electricity from the package and from your body.
- Remove the device from its package and install it directly into the system unit without setting down the device. If it is necessary to set down the device, put it back into its static-protective package. Do not place the device on the system unit cover or on a metal surface. Take additional care when you handle devices during cold weather. Heating reduces indoor humidity and increases static electricity.

Adding new hard disk drives

This section describes the procedure to add new hard disk drives to empty drive bays either in storage subsystems or storage enclosures. If you plan to add a used drive, ensure that there is no configuration data on the drive that you need to preserve. A used drive is a drive that is removed from an existing storage subsystem. It might be configured as part of the RAID array. Add drives to a storage subsystem only while the power is turned on and the storage subsystem is in Optimal state. For more information, see the Recovery Guru function in the Storage Subsystem Management window, the *Problem Determination Guide*, or “Bringing storage subsystems and drive loops into optimal state” on page 21.

Important:

- Do not perform this procedure if you are migrating drives from another DS4000 storage subsystem. This procedure deletes the logical drive configuration in the

migrated hard disk drives. Instead, see the instructions in “Migrating storage enclosures with hard disk drives that have defined logical drive configurations” on page 79.

- Perform the prerequisites that are described in Chapter 1, “Prerequisites to adding capacity and hard disk drive migration,” on page 1 before you perform the activities that are described in this chapter.

To add new drives to the storage subsystem, complete the following steps:

1. Insert drives (one at a time) into the empty drive bays.
2. Wait (up to 5 minutes) until each drive fully spins up and appears in the DS Storage Subsystem Management window before you insert the next drive.
3. If the drives were shown with configuration, select the **Drive** icon in the Physical view and then select the Storage Subsystem Management window menu function **Advanced -> Recovery -> Initialize -> Drive** to erase the configuration data in the drive.

Note: To implement this function in the DS3000 storage subsystem, use the SMcli `start drive [enclosureID, slotID] initialize;` command.

4. If the new drive is an FDE drive and you do not have the storage subsystem security key to unlock it, use the secure erase function to reprovision the drive before you use it.

If the DS Storage Manager initialize drive function does not initialize the drives, see “Using the drive migration disable script to add new drives” on page 70 for instructions for initializing drives.

Migrating hard disk drives

When you migrate hard disk drives from multiple storage subsystems to a single storage subsystem, move all of the hard disk drives from each storage subsystem as an independent set. Ensure that all hard disk drives are transferred before you move another set. If you do not transfer hard disk drives as sets, the newly relocated arrays/logical drives that are defined by using these drives might not appear in the Storage Subsystem Management window.

The procedure for migrating hard disk drives that contain configuration data that you want to preserve is in the following sections:

- “Step 1: Preliminary activities” on page 60
- “Step 2: Verifying drive migration enable settings” on page 61
- “Step 4: Removing drives” on page 63

Important: Do not use the procedure in this section if you are unsure of the quality of the data on the hard disk drives. Importing incorrect configuration data could cause a storage subsystem failure. Ensure that the storage subsystem has the recommended controller firmware version provided on the IBM Support website. If possible, clear the metadata by installing the drive in an expansion enclosure that is directly connected to the host; then, either format the drive or write zeros pattern to the last 1 GB of drive data.

Drives with disk pools cannot be migrated from one subsystem to another. The data in the disk pool must be backed up to a tape or to drives that are part of traditional arrays. Then, the data is restored to newly created disk pools in another storage subsystem.

IBM DS Storage Manager 10.xx with controller firmware level 07.xx.xx.xx supports import migration of RAID arrays that contain logical drives with data when the following prerequisites and limitations are observed:

- RAID arrays are created by an IBM storage subsystem that uses controller firmware level 06.xx.xx.xx or later.
- Hard disk drives in a RAID array must be supported in the target storage enclosure. Read the *Installation, User's, and Maintenance Guide* for the target storage enclosure to determine compatibility.
- Supported RAID arrays in DS4000 storage subsystem can be migrated to storage subsystems that support the 07.xx.xx.xx controller firmware. Only DS4000 storage enclosures that are supported with controller firmware 07.xx.xx.xx can be migrated, for example, EXP100, EXP420, EXP520, EXP710, and EXP810 storage enclosures.
- The target migration storage subsystem must be up and running optimally with controller firmware 07.xx.xx or later and must be greater than or equal to the firmware version of the original subsystem.

Note: For more information, see the “Drive migration limitations” on page 14 section.

Step 1: Preliminary activities

This section describes the procedure to migrate drives from a functioning storage subsystem configuration to another storage subsystem configuration, if the drives contain configuration data that you want to preserve. Add such drives to a storage subsystem only while the power is turned on and the storage subsystem is in Optimal state. See the *DS4000 Problem Determination Guide* or “Bringing storage subsystems and drive loops into optimal state” on page 21 for additional information about assessing the state of a storage subsystem.

To complete the preliminary activities, complete the following steps:

1. Perform the procedure in Chapter 1, “Prerequisites to adding capacity and hard disk drive migration,” on page 1.
2. Stop all programs, services, or processes in the host servers that access the logical drives that are defined in the migrated hard disk drives. Ensure that no programs, services, or processes are running in the background that write data to the logical drives. (For example, the Microsoft MSCS service periodically writes to the Quorum disk.)
3. Unmount the file systems to flush I/O from the server cache to disks.

Note:

- a. In a Microsoft Windows environment, remove the drive letter or the mount points of the mapped LUNs instead of unmounting the file systems.
 - b. See the documentation for your operating system for detailed information about the unmount procedure.
4. Back up the logical drives.
 5. Ensure that the storage subsystem controller and NVSRAM of both the source and destination systems are at or above the levels described in Table 2 on page 9.
 6. Ensure that the names of the logical drives that are associated with hard disk drives on both the source and destination systems are unique.

Note: Periods are not supported as part of label names.

7. If you have not already, save and store the profile and configuration script along with the collect all support data bundle of the storage subsystem from which the drives are migrated.
8. Remove all storage partition mappings to logical drives in arrays that are to be moved.
9. Delete any FlashCopy images of the logical drives that are defined on the drives that you plan to migrate.
10. Remove any remote mirror relationships that use the logical drives that are defined on the drives that you plan to migrate.
11. Ensure that the arrays and logical drives are in Optimal state before you start the migration process. For more information, see the *Problem Determination Guide* or the “Bringing storage subsystems and drive loops into optimal state” on page 21 section.

Note: An array must be in Optimal state before it can be moved. All failed drives must be replaced and rebuilt into the array before it can be exported.

12. If you migrate storage enclosures from a 1-Gbps Fibre Channel environment to a 2-Gbps Fibre Channel environment, verify that the Fibre Channel hard disk drives that you plan to migrate are each capable of 2-Gbps operation and that you installed the latest firmware. Similar considerations apply when you move storage enclosures from a 2-Gbps environment to a 4-Gbps environment.
13. If you migrate the drives to a single controller storage subsystem (for example, DS4300/DS5000 storage subsystem, model 6LU or 6LX), change the preferred owner of the logical drive to controller A, using the DS Storage Manager Client program before you take it offline and remove it from the storage subsystem. To set Controller A as the logical drive preferred owner, right-click the logical drive entry in the Storage Subsystem Management window and click **Change -> Ownership/Preferred Path -> Controller A**.
14. Save the storage subsystem profile of the target migration storage subsystem in a location other than the logical drives that you plan to migrate.
15. If the migrated drives are FDE drives and were configured as part of secured array, save the storage subsystem security (lock) key to unlock the drives after you install them in a new storage subsystem. Without this key, the controllers cannot unlock the drives to perform input and output processes. For details about the security key, see the *IBM System Storage DS Storage Manager Version 10 Installation and Host Support Guide*.
16. If the migrated drives are from storage subsystems that operate in external license key management mode, ensure that the new storage subsystem also operates in external license key management mode and uses the same external key server. Otherwise, save the storage subsystem security (lock) key to unlock the drives.

Step 2: Verifying drive migration enable settings

Note: There is no need to verify drive migration enable settings in storage subsystems or storage enclosures with controller firmware level 7.xx or later and Storage Manager software version 10.xx or later.

The DS4000 storage subsystem drive migration setting must be set to Enable before you insert drives with configuration data. If you do not, the controller ignores the configuration data in the drive and identifies the drive as unconfigured and in

Optimal state. For subsystems with controller firmware level 6.xx only, perform the procedure to run the EnableDriveMigration script to ensure that the drive migration setting is set to Enable before you insert any drives with configuration data. See “Step 3: Re-enabling the drive migration settings” on page 71 for instructions.

Step 3: Placing drives offline

Place the arrays that are defined on the hard disk drives that you plan to migrate in Offline state. The method that you use to place an array in an Offline state varies according to the controller firmware and the DS Storage Manager software versions:

- Before controller firmware level 7.xx or Storage Manager software version 10.xx: Right-click the name of the array in the Storage Subsystem Management window and click **Place -> Offline**.
- The DS3000 storage subsystem supports these array functions through the SMcli interface. See the Storage Manager online help for the SMcli command syntax.
- If the subsystem management window and the storage subsystem SMcli interface do not support placing arrays offline or exporting arrays, the migrated drives must be removed from the storage subsystem after storage subsystem controller enclosure is powered off.
- Controller firmware level 7.xx or later or Storage Manager software version 10.xx or later: Use the Export Array feature as described in this section.

The Export Array function is available on storage subsystems or storage enclosures with controller firmware level 7.xx or later and Storage Manager software version 10.xx or later.

To export the drives, complete the following steps:

1. In the Storage Subsystem Management window, right-click the name of the array that you want to migrate.
2. Select **Advanced -> Export** from the pull-down menu.
3. Read and complete each of the tasks listed in the Export Array window. Select the check box next to each task after you complete it.

Note:

- a. Selecting the check box beside each task does not automatically cause the task to be completed. You must complete each task. Selecting the check box helps you track the tasks that you complete and enables the **Export** button on the Export Array window.
 - b. The DS3000 storage subsystem supports these array functions through the SMcli interface. See the Storage Manager online help for the SMcli command syntax.
4. After you complete all tasks and select the check box beside each task, click **Export**.
 5. In the Export Array dialog window, type yes and click **OK**.

After a successful export, the array appears in Exported - ready to import state when you hover the mouse pointer over the **Array** icon, and the drives appear in Offline state. See Figure 19 on page 63.

Note: In the EXP5060 storage enclosure, the blue SAA LED is lit on the drive. For drive bays that do not have blue SAA LEDs, the drives are indicated by

slowly flashing activity LEDs, or all drive LEDs are off.

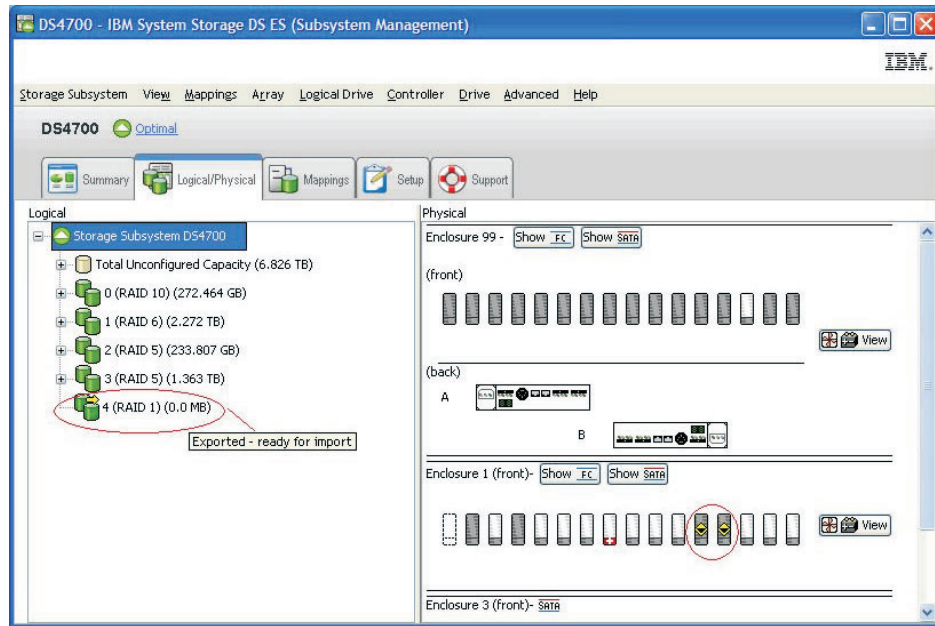

Figure 19. Subsystem Management Logical/Physical View of exported drives

6. Click **Close** to close the Export Array window.

Step 4: Removing drives

See the *Installation, User's and Maintenance Guide* before you perform this procedure to ensure that it applies to your storage subsystem.

To remove the hard disk drives, complete the following steps.

Note: Remove the drives one at a time from the storage enclosure.

1. While the power to the storage subsystem is still turned on, press the inside of the bottom of the tray handle to release the blue latch.
2. Lift the closed latch to its open position. (The latch is at a 90° angle to the front of the drive when it is open.)

Note: Your hard disk drives might have a different latching mechanism than the one shown in Figure 20 on page 64. See the documentation that comes with your storage enclosure for details.

3. Using the handle, slowly pull the drive 1.27 cm (0.5 in.) out of the drive bay.

Note: For EXP5060 and DCS3700 enclosures, and enclosures of DCS3700 with Performance Module Controllers, slowly pull the drive forward until it hits the drawer cross brace.

4. Wait at least 30 seconds to allow the hard disk drive to spin down before you remove it from the drive bay.
5. Place the hard disk drive into an ESD bag or container before you move it to the new DS4000 storage subsystem.

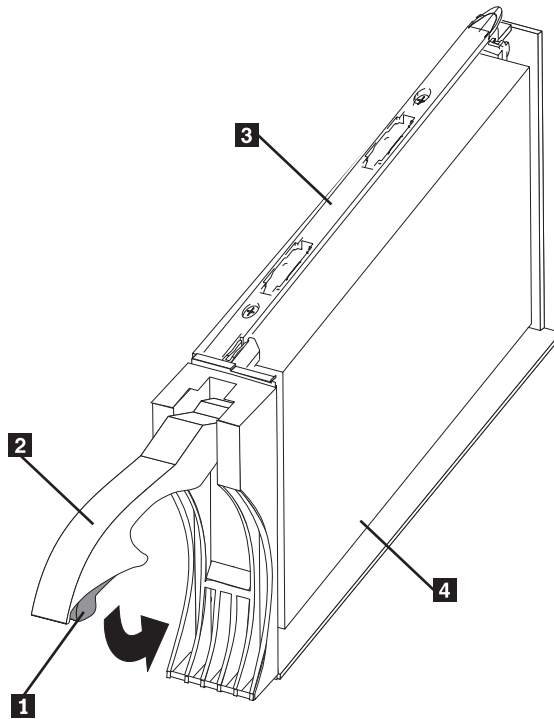

Figure 20. Drive CRU assembly

Legend:

- 1 Blue latch
- 2 Drive CRU handle
- 3 Tray
- 4 Fibre Channel hard disk drive

Attention: Orient drives horizontally and place them in applicable ESD bags or containers before relocation. In transit, use moving equipment that prevents shock to the drives. Never stack drives.

Step 5: Inserting drives

Note:



1. When you migrate hard disk drives from multiple storage subsystems to a single storage subsystem, move all of the hard disk drives from each storage subsystem as an independent set. Ensure that all hard disk drives are transferred before you move another set. If you do not transfer hard disk drives as sets, the newly relocated arrays/logical drives that are defined by using these drives might not appear in the Storage Subsystem Management window.
2. Ensure that the drives are compatible with the storage enclosure. For example, insert a 2-GB drive into a storage enclosure that supports 2-GB drives.
3. The Import Array function is available on storage subsystems or storage enclosures with controller firmware level 7.xx or later and Storage Manager software version 10.xx or later.

Important: Insert migrated drives one at a time while the storage subsystem is turned on and is optimal state to prevent any drive migration problems.

To insert the drives in the target migration storage subsystem, complete the following steps:

1. While the destination storage subsystem is turned on, insert the migrating drives into an empty drive bay one at a time. Wait (up to 5 minutes) until the inserted drive is fully spun up and displayed in the Storage Subsystem Management window before you insert the next drive.
 - On storage subsystems with controller firmware level 6.xx.xx.xx or earlier, as the storage subsystem recognizes the drives, the array and logical drive information is shown on the Logical/Physical view of the Storage Subsystem Management window. The storage subsystem represents arrays in offline state until it recognizes that you insert all of the drives that make up an array.
 - On storage subsystems with controller firmware level 7.10 or later, arrays appear in Contingent state (with an arrow icon) until all of the drives in the array are inserted. The array appears in Exported - ready to import state.
2. If the migrated drives are FDE drives and were configured as part of secured array, use the saved security key to unlock the drives. Without this security key, the controllers cannot unlock the drives to retrieve the array configuration data and data on the drives. Therefore, you cannot import any array/logical drive configuration from the drives or access data in the drives.
3. Depending on the controller firmware and Storage Manager software versions of your system, complete the following steps:
 - With controller firmware and Storage Manager software before controller firmware level 7.xx and Storage Manager software version 10.xx, after you migrate all of the drives, manually change the state of the arrays and logical drives that are involved from Optimal state to Online state if it does not change automatically. To do so, right-click the array name in the Storage Subsystem Management window and click **Place -> Online**.
 - With controller firmware level 7.xx or later and Storage Manager software version 10.xx or later, after you migrate all of the drives, import the array:
 - a. Right-click on the name of the array that you want to import in the Storage Subsystem Management window.
 - b. Select **Advanced -> Import** from the pull-down menu.
 - c. In the confirmation window, click **OK**.
 - d. Click **Import**.
 - e. In the Import Array window, type yes and click **OK**.
After a successful import, the message Array was imported successfully is displayed in the dialog box.
 - f. Click **Close**.

Note: The DS3000 storage subsystem supports these array functions though the SMcli interface. See the Storage Manager online help for the SMcli command syntax.

4. If any of the following conditions occur, contact IBM support for assistance:
 - The **Empty Drive Bay** icon () is displayed for the drive bay into which you inserted the migrating drive.
 - The **Failed Unconfigured Drive** icon () or the **Failed Configured Drive** icon () is displayed for the drive bay into which you inserted the migrating drive.
 - Array configuration data on the drives that you added is incomplete.

- You cannot bring the array online (controller firmware 6.xx.xx.xx and lower) or import the array (controller firmware 7.xx.xx.xx or later).

Attention:

Attention: Do not initialize a hard disk drive that you want to keep (by right-clicking its icon and selecting **Initialize** from the menu) if it contains configuration or user data. Initializing any drives in a defined array causes all hard disk drives that are known to make up that array to return to the Unconfigured Capacity storage pool, deleting their array definitions from the DS4000 storage subsystem configuration. The user data on such drives is lost. When the arrays are online, they are ready to for you to configure and map to host servers. You might also then re-create FlashCopy images of the logical drives.

5. Use the DS Storage Manager program to view the storage partitioning definitions and make any necessary corrections.

Note: The source storage subsystem might indicate that the logical drives are missing. To remove the missing logical drives, right-click each entry and select **Delete** from the menu.

Migrating arrays within the same storage subsystem

Important

1. Ensure that your controller firmware is at or above the level shown in Table 2 on page 9. Do not rearrange more than one array at a time.
2. Unmount the file systems to flush I/O from the server cache to disks.

Note:

- a. In a Microsoft Windows environment, remove the drive letter or the mount points of the mapped LUNs instead of unmounting the file systems.
 - b. See the documentation for your operating system for detailed information about the unmount procedure.
3. Export Array and Import Array functions are available on storage subsystems or storage enclosures with controller firmware level 7.xx or later and Storage Manager software version 10.xx or later. The DS3000 storage subsystem supports these array functions through the SMcli interface. See the Storage Manager online help for the SMcli command syntax.

Note: Because disk pool does not support exporting and importing functions, this functionality is not applicable to drives in disk pools.

Using the configuration data on existing drives, you can redistribute the drives that make up a RAID array across a storage subsystem to which you might be adding storage enclosures. Figure 21 on page 67 illustrates a storage array that is distributed across three drives on a single storage device before and after reordering. When you redistribute each drive to a different position in the same storage enclosure, which is a best practice, the array is automatically redistributed.

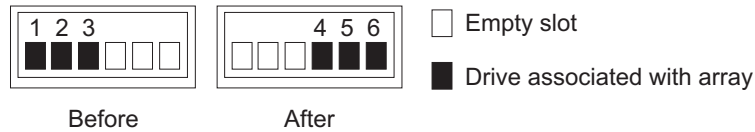

Figure 21. Best practice for reordering a defined array by using empty bays in one storage enclosure

Figure 22 illustrates a storage array that is distributed across three drives on a single storage device before reordering across two storage devices. When the drives are redistributed across an additional storage enclosure in the storage subsystem, which is a best practice, the array is automatically redistributed.

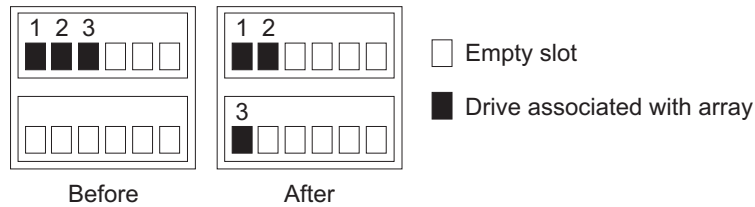

Figure 22. Best practice for reordering a defined array by using empty bays in two storage enclosures

Figure 23 on page 68 illustrates two arrays that are distributed across five drives and two storage enclosures before and after reordering the same drives across other drive bays in the same two storage enclosures.

Note: If the installed controller firmware level is 6.xx.xx.xx or earlier, before you attempt to remove and reinsert any of the drives from either enclosure, place the array into offline state by using the DS Storage Manager Client and completely remove all of the drives of both arrays from both storage enclosures. Wait for DS Storage Manager to display the arrays/logical drives as missing and the drive bays as empty. After you insert the drives that are associated with the first array, wait until that array comes online in a DS Storage Manager Subsystem Management window before you insert the drives that are associated with the second array.

If the installed controller firmware is 7.xx.xx.xx or later, before you attempt to remove and reinsert drives from either enclosures, export the arrays by using the DS Storage Manager Client. After the array is exported, remove the drives and reinsert them in the drive bays in the same storage subsystem. Then, use the DS Storage Manager Client to import the arrays. Note the following information:

- Using the Export function is equivalent to placing the array in Offline state. See “Step 3: Placing drives offline” on page 62 for details on exporting an array.
- When you install the first drive in its new location within the storage subsystem, the **Array** icon appears with an arrow but does not change to Online state automatically. You must use the Import function to place the array in Online state.

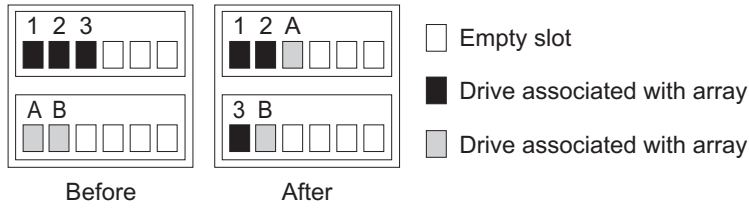

Figure 23. Reordering multiple defined arrays across previously used bays in two storage enclosures

To reorder drives that make up arrays across different drive bays in the same storage subsystem configuration, complete the following steps:

1. Start the DS Storage Manager Client program and open the Storage Subsystem Management window (for the storage subsystem whose drives you are reordering).
2. Mark the drives in the arrays.
3. If the installed controller firmware is 6.xx.xx.xx or earlier, set the arrays that you plan to move to offline state. If the installed controller firmware is 7.xx.xx.xx or later, export the arrays that you plan to move.
4. Unlatch the drives. Wait at least 2 minutes for each drive to spin down.
5. Remove the drives from the bays.
6. Ensure that all of the drives that made up the arrays are removed from their bays.
7. Complete one of the following steps:
 - If the controller firmware is at 7.xx.xx.xx or later and the arrays were exported, skip to step 8 on page 69.

Note: Figure 24 shows the array status as missing an array in subsystem because the array was not exported before the drives that made up the array were removed from the storage subsystem.

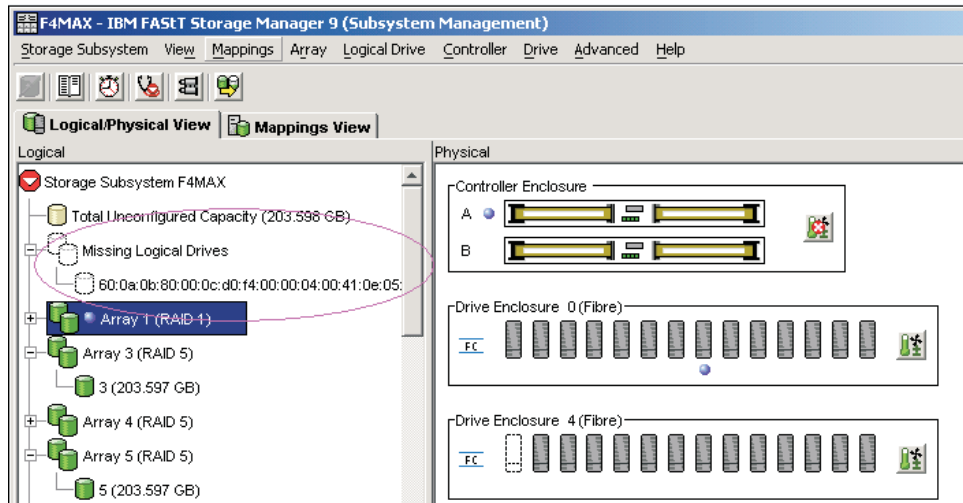

Figure 24. Subsystem Management Logical/Physical View of missing logical drives (controller firmware 7.xx.xx.xx or later)

- If the controller firmware is earlier than 7.xx.xx.xx, wait for DS Storage Manager to mark the arrays/logical drives as missing in the Storage Subsystem Management window. See Figure 25 on page 69.

Attention: Do not proceed to step 8 until all of the defined logical drives in the arrays whose drives are removed from the DS4000 storage subsystem are indicated as missing; otherwise, the controller might mark certain drives that are part of the array as failed, causing the array to be degraded or failed.

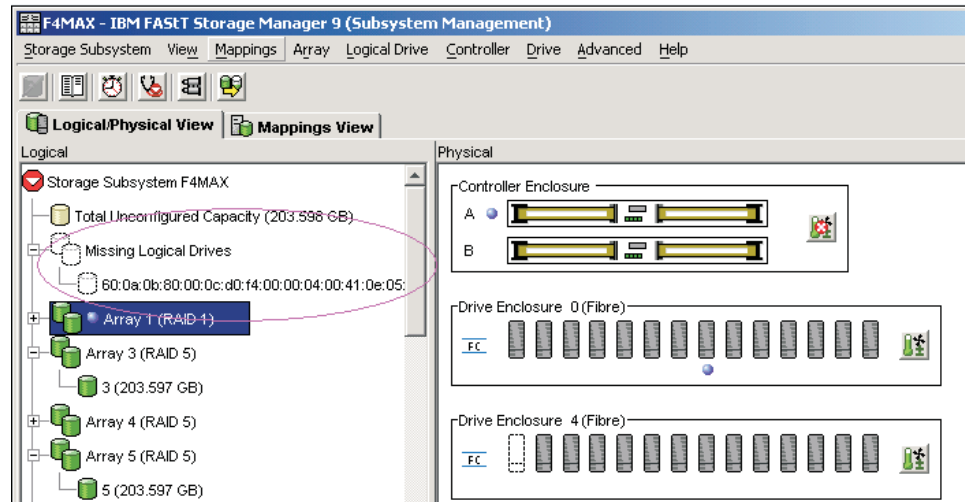

Figure 25. Subsystem Management Logical/Physical View of missing logical drives (controller firmware before 7.xx.xx.xx)

8. Reinsert all of the drives that made up a single array into the empty bays of the storage enclosure. Do not insert the drives into empty bays that are part of another array definition whose drives are still inserted in the storage enclosures. Data on the drives that you insert is replaced with the reconstructed data from the previously installed RAID array.
9. If the installed controller firmware in the storage subsystem is version 6.xx.xx.xx or earlier, the system recognizes the array and brings it online when you finish inserting all of the drives.
On storage subsystems with controller firmware level 7.xx or later and Storage Manager software version 10.xx or later, the system does not bring the array online automatically. You must use the Import function to import the array configuration and place the array online.
10. Repeat steps 8 and 9 for each of the arrays that were removed from the storage enclosure.
11. Use the DS Storage Manager Client program to save a storage subsystem profile and collect the all support data bundle. This information is necessary to restore a storage subsystem configuration in the event of a catastrophic failure. Migration from one storage subsystem configuration to another requires that you save both storage subsystem configuration profiles and collect all support data bundles. For more information, see the DS Storage Manager Client program Subsystem Management window online help, or go to <http://www.ibm.com/systems/support/storage/disk/> to access the latest applicable *IBM System Storage DS Storage Manager Installation and Support Guide*.

Important: To avoid loss of data if a RAID array failure occurs, do not store storage subsystem profiles and collect all support data bundles in the same location as the logical drives.

Note: Do not reinsert drives from multiple arrays in random order into the storage enclosures.

Using the drive migration disable script to add new drives

Attention:

1. You can use this procedure to add new drives, if the installed controller firmware version is 6.xx.xx.xx and earlier and the DS Storage Manager Initialize Drive function does not initialize the drives. However, use this procedure only as a last resort. If possible, follow the procedure in “Adding new hard disk drives” on page 58.
2. Do not use this procedure if the installed controller firmware is version 7.xx.xx.xx or later.
3. To avoid loss of data, follow the procedures in this section exactly.

Do not use these procedures to migrate drives with existing configuration data. Otherwise, the data in the migrated drives is lost. In addition, ensure that “Step 3: Re-enabling the drive migration settings” on page 71 is performed successfully if you do perform procedure in this section. If not, configuration data in the drives in the storage subsystems is deleted when the storage subsystem is power-cycled.

Step 1: Disabling the drive migration settings

Important: Review the information in “Introduction” on page ix and perform the prerequisites that are described in Chapter 1, “Prerequisites to adding capacity and hard disk drive migration,” on page 1 before you perform the activities that are described in this section.

To remove any configuration data that the drives might contain, complete the following steps:

1. Open the Storage Manager Client Enterprise Management window.
2. Right-click the name of the DS4000 storage subsystem to which you intend to add drives and click **Execute Script**.
3. Click **File -> Load Script**.
4. Locate and select the file named `DisableDriveMigration.scr` and click **OK**. The `DisableDriveMigration.scr` file is normally in the `Scripts` directory of the *IBM DS Storage Manager Installation DVD*. Use this file to reset the setting of the DS4000 storage subsystem to ignore configuration data that might be on newly discovered hard disk drives. Table 19 on page 73 provides a listing of the `DisableDriveMigration.scr` file.
5. Click **Tools -> Verify and Execute** to run the script.
6. When the script completes execution, reset both DS4000 controllers to enable the DS4000 drive migration setting.

If you used the `DisableDriveMigration.scr` script that is associated with this document and described in Table 18 on page 72, it is not necessary for you to perform this step because the last two commands in that script file automatically reset the controllers.

To reset the controllers, open the Storage Subsystem Management window and sequentially (one at a time) reset each controller by clicking **Advanced -> Reset Controller**. Then, follow the instructions in the Reset Controller window when it opens.

Step 2: Inserting drives

To insert the hard disk drives, complete the following steps:

1. Insert drives as pairs (two at a time) into the empty drive bays.
2. Wait (up to 5 minutes) until each drive pair fully spins up and appears in the DS Storage Subsystem Management window before you insert the next drive pair.

Step 3: Re-enabling the drive migration settings

Perform this activity to re-enable the drive migration settings if you performed “Step 1: Disabling the drive migration settings” on page 70 to disable DS4000 storage subsystem drive migration settings. If you do not, when you remove a hard disk drive from the storage subsystem, the configuration data is cleared. When the storage subsystem next recognizes such a hard disk drive, it is identified as unconfigured.

Attention: To prevent data loss, set the storage subsystem drive migration to Enable after you complete the hard disk drive addition process.

To re-enable the drive migration settings, complete the following steps:

1. Open the Storage Manager Client Enterprise Management window.
2. Right-click the name of the storage subsystem to which you want to add drives, and click **Execute Script**.
3. Click **File -> Load Script**.
4. Select the file named `EnableDriveMigration.scr` and click **OK**. The `EnableDriveMigration.scr` file is normally in the Scripts directory of the *IBM DS Storage Manager Installation DVD*. Use this file to reset the setting of the DS4000 storage subsystem to check for configuration data that might be on newly discovered hard disk drives. Table 18 on page 72 provides a listing of the `EnableDriveMigration.scr` file.
5. Click **Tools -> Verify and Execute** to run the script.
6. When the script completes execution, reset both controllers to enable the drive migration setting.

If you use the `EnableDriveMigration.scr` script that is associated with this document and described in Table 18 on page 72, it is not necessary for you to perform this step because the last two commands in that script file automatically reset the controllers.

To reset the controllers, open the Storage Subsystem Management window and sequentially (one at a time) reset each controller by clicking **Advanced -> Reset Controller**, and then following the instructions in the Reset Controller window when it opens.

The following figures list the `EnableDriveMigration.scr` and `DisableDriveMigration.scr` files.

Table 18. EnableDriveMigration.scr file listing

```
// Name: Enable Drive Migration
//
// Date: 11-20-2005
// Revision: 1.4
// Version 1.4 fixed the misleading on/off comment - CMVC 296330.
// Comments:
// This script is intended to work with controllers at Firmware 05.30.xx.xx and
// higher only.
//
// This script returned the storage subsystem to it's default operation of importing
// configuration information from disks.
//
// This script reboots both controllers in the storage subsystem unit.
// If your hosts are configured for multi-path support, this can be done with I/O running to the controllers,
// else schedule downtime before running this script.
//
// See the directions at the bottom of this script if you do not have multi
// path software installed and wish to prevent the controller restarts
//
// Show the current state of Drive Migration
show "Showing the current state of Drive Migration. The return value should";
show "be 82, which means drive migration is disable.";
show " ";
show controller[a] nvsrambyte[0x35];
show controller[b] nvsrambyte[0x35];
//
// Setting Drive Migration to Enable
show "Setting Drive Migration to Enable";
set controller[a] nvsrambyte[0x35] = 0x02,0x00;
set controller[b] nvsrambyte[0x35] = 0x02,0x00;
show "Showing the new state of Drive Migration. The return value should";
show "be 80, which means drive migration is enable. This should be the ";
show "default setting for the DS4000 controllers. ";
show " ";show controller[a] nvsrambyte[0x35];
show controller[b] nvsrambyte[0x35];
//
// Reset Controllers to make changes active. Note:
// To prevent the controllers from restarting, add '//' to the beginning
// of each of the lines below. This will comment out the restart of the
// controllers. Important: The controllers will have to be restarted for the
// changes in this script to take effect.
//
show "Resetting controller A";
reset Controller [a];
show "Resetting controller B";
reset Controller [b];
show "Drive Migration is now enabled.";
```

Table 19. DisableDriveMigration.scr file listing

```
// Name: Disable Drive Migration
// Date: 11-20-2005
// Revision: 1.4
// Version 1.4 fixed the misleading on/off comment - CMVC 296330.
// Comments:
// This script is intended to work with controllers at Firmware 05.30.xx.xx
// and higher only.
// This script allows the addition of disk drives while the system is running
// and by clearing the configuration of any drives as unused capacity
// regardless of past configuration of these drives.
//
// Attention: This setting should not be left active after the new disks
// have been added to the subsystem. Leaving this setting active could
// cause the configuration for the DS4000 to be lost if the DS4000
// is power cycled. Please run the EnableDriveMigration.scr after all of
// the disks are added. IN ADDITION, DO NOT USE THIS SCRIPT IF YOU WANT
// TO PRESERVE THE DATA IN THE DRIVES THAT YOU ARE PLANNING TO ADD INTO
// THE EXISTING DS4000 STORAGE SUBSYSTEM CONFIGURATION. Please refer to
// the DS4000 adding capacity and drive migration publication for more
// information.
// This script will reboot both controllers in the storage subsystem unit. If your
// hosts are configured for multi-path support, this can be done with I/O
// running to the controllers. If your hosts are not configured for
// redundant access you much schedule downtime before running this script.
//
// Show the current state of Drive Migration
show "Showing the current state of Drive Migration. The return value should";
show "be 80, which means drive migration is enable. This should be the ";
show "default setting for the DS4000 controllers. ";
show " ";
show controller[a] nvsrambyte[0x35];
show controller[b] nvsrambyte[0x35];
//
// Setting Drive Migration to Disable
show "Setting Drive Migration to Disable";
set controller[a] nvsrambyte[0x35] = 0x02,0x02;
set controller[b] nvsrambyte[0x35] = 0x02,0x02;
show "Showing the new state of Drive Migration. The return value should be";
show "82, which means drive migration is disable. Please run the enableDrive";
show "Migration.scr script as soon as you complete the inserting of ";
show "new drives into the DS4000 storage subsystem slots.";
show " ";
show controller[a] nvsrambyte[0x35];
show controller[b] nvsrambyte[0x35];
//
// Reset Controllers to make changes active
// To prevent the controllers from restarting, add '//' to the beginning of each
// of the lines below. This will comment out the restart of the controllers
// Important: The controllers will have to be restarted for the changes
// in this script to take effect.
show "Resetting controller A";
reset Controller [a];
show "Resetting controller B";
reset Controller [b];
//
show "Drive Migration is now disabled. Add the new drives to the subsystem,";
show "then execute the EnableDriveMigrationScript.scr to re-enable drive ";
show "migration.";
```

Chapter 3. Adding or migrating storage enclosures

This chapter describes the procedure to add storage enclosures in a storage subsystem. It also describes the procedure to migrate storage enclosures from an existing storage subsystem to another working optimal storage subsystem. If the destination storage subsystem is a working configuration, follow the procedure in this chapter to move one or all of the storage enclosures from another storage subsystem configuration into it. The storage subsystem is in Working state when the storage subsystem controllers successfully start with at least two drives in the drive channel.

Note: To migrate the drives in the integrated drive-controller enclosure to another storage subsystem configuration without an integrated drive-controller enclosure, you must purchase a storage enclosure for these drives.

Important: Observe proper ESD procedures when you handle electronic equipment. For more information, see “Handling static-sensitive devices” on page 58.

Attention:

Make additions to the storage subsystem only while the power is turned on and the storage subsystem is in Optimal state. For more information, see “Bringing storage subsystems and drive loops into optimal state” on page 21. You can complete this process while the storage subsystem is receiving I/O from the host server; however, because the drive loops are interrupted momentarily during the addition process, schedule the addition to occur during periods of low I/O between the storage subsystems and host servers.

Considerations

The following notes describe information that you must consider when you add a hard disk drive to a controller or a storage enclosure:

- Updated readme files contain important configuration and procedural information that supersede information in this document. Always check the readme file before you perform any procedure or activity that is described in this document. To access the most recent readme file, see “Finding Storage Manager software, controller firmware, and readme files” on page 145.
- Never alter the physical configuration of a storage subsystem while it is turned off unless you are instructed to do so as part of a storage subsystem configuration procedure. Specifically, never attach storage components to or remove storage components from a configured storage subsystem while it is turned off.
- Every storage subsystem model has unique storage enclosure cabling rules. See the *Installation, User's and Maintenance Guide* for your storage subsystem for information about the storage enclosure cabling rules. You must follow the cabling rules to maintain proper storage subsystem operation.
- When you migrate hard disk drives from multiple storage subsystems to a single storage subsystem, move all of the hard disk drives from each storage subsystem as an independent set. Before you move the next set of hard disk drives, ensure that all the hard disk drives from the previous set are transferred. If you do not transfer hard disk drives as sets, the newly relocated arrays/logical drives might not appear in the Storage Subsystem Management window.

- Before you migrate hard disk drives, perform the following steps to establish drive model compatibility:
 1. Check the drive CRU form factor options.
 2. If the form factors are the same, check to determine whether the subsystem supports the drive. If the form factors are not the same, there are no replacement parts such as bezels and drive trays. For more information, see the announcement letter and the *Installation, Users, and Maintenance Guide* for your storage subsystem, and your IBM marketing representative or authorized reseller.
 3. Ensure that the drive can operate at the storage subsystem drive loop/channel Fibre Channel or SAS speed. For more information, see “Verifying hard disk drive model compatibility” on page 17.
- Not all combinations of the supported storage enclosures are supported as storage enclosures intermixed behind storage subsystems.
- Do not mix SATA and Fibre Channel drives or enclosures together in the same drive loop unless you meet the Fibre Channel/SATA intermix requirements. See “Intermixing storage enclosures” on page 21 for that information.
- Check for drive compatibility in a storage subsystem configuration before you insert a drive in an empty drive slot. For example, do not install SATA drives in EXP700 or EXP710 Fibre Channel drive storage enclosures. Do not install Fibre Channel drives in EXP100 SATA and EXP420 storage enclosures. EXP520, EXP810, and EXP5000 storage enclosures can accept either Fibre Channel or SATA Enhanced Disk Drive Modules (E-DDMs). The EXP420 storage enclosure supports SATA E-DDMs only.
- Do not attach more than four storage enclosures behind a DS4200 Express, DS4700 Express, DS4800, DS5000, or DS5020 storage subsystem drive channel port. For more information, see the *Installation, User's, and Maintenance Guide* for your storage subsystem.
- You can intermix EXP5000 and EXP5060 storage enclosures up to a maximum of 448 drives. To support 480 drives, you must have all EXP5060 storage enclosures and have feature 7372 to attach eight EXP5060 storage enclosures.
- Always connect the storage subsystem controller drive channel port to either the left or right EXP395, EXP420, EXP520, or EXP810, EXP5000, or EXP5060 storage enclosure ESM drive port labeled 1B.
- Always connect the storage subsystem controller drive channel port to either the left or right EXP3000, EXP3512, or EXP3524 ESM drive port labeled IN (SAS In connector) or to the top or bottom DCS3700 storage expansion enclosure ESM drive port.
- When you intermix the storage enclosures in a redundant drive loop/channel pair behind a DS4000 storage subsystem, always group the storage enclosures by type; for example, group the EXP100 storage enclosures together, and group the EXP700 storage enclosures together. You can group the EXP710 and EXP810 storage enclosures together. The EXP710 and EXP810 storage enclosures are considered Switched-ESM types of storage enclosures even though they have different machine types and models.
 Although there are no restrictions against cabling EXP710 and EXP810 storage enclosures together, for ease of future maintenance and to aid in troubleshooting, group the storage enclosures by type in a DS4000 storage subsystem redundant drive loop/channel pair.
- Ensure that the enclosure IDs of each storage enclosure in a redundant drive loop/channel pair behind a storage subsystem have unique values in the single digit (x1) position.

- The EXP395, EXP520, and EXP5000 storage enclosures support 4-Gbps drives only.
- For information about the EXP5000 and EXP5060 storage enclosures, see note 2 on page 24.

The following procedure combines the steps to add storage enclosures that contain new drives to a storage subsystem configuration with the steps to migrate storage enclosures. There are indicators in the steps that are specific to either adding or migrating enclosure tasks. If you are migrating storage enclosures, do not perform the steps that are indicated as being only for adding storage enclosures: performing steps for adding storage enclosures might cause the deletion of the logical drive configuration in the migrated hard disk drives.

Step 1: Preliminary activities

Before you add or migrate storage enclosures, complete the following steps:

1. Ensure that the power to the storage subsystem is turned on and the storage subsystem is in Optimal state.

If this is a migrating enclosure task, also ensure that the subsystem in which the enclosures are to be migrated is turned on and is in Optimal state. For more information, see the *DS3000 Problem Determination Guide*, the Recovery guru for DS3500, DCS3700 (DCS3700 and DCS3700 with Performance Module Controllers), DS4000, and DS5000 storage subsystems, or “Bringing storage subsystems and drive loops into optimal state” on page 21. You can perform this procedure while the storage subsystem is processing I/O from or to the host server; however, because the drive loops are interrupted momentarily during the addition process, schedule any additions to occur during time periods of low I/O between the storage subsystem and host servers.

Note: Although there are no restrictions against cabling EXP100 storage enclosures with EXP700, or EXP710 storage enclosures with EXP810 storage enclosures, for ease of future maintenance and to aid in troubleshooting, group the storage enclosures by type in a DS4000 storage subsystem redundant drive loop/channel pair.

Review the readme file and the *IBM System Storage DS Storage Manager Installation and Support Guide* that is associated with the operating-system environment of the host servers that connect to the storage subsystem for any additional restrictions or required preparation tasks that are specific to your operating-system environment. To access the latest *IBM System Storage DS Storage Manager* installation and support guides, go to <http://www.ibm.com/systems/support/storage/disk/>.

2. Perform a collect all support data bundles and save the storage subsystem configuration.
3. Ensure that the storage subsystem supports the storage enclosures that you are trying to add or migrate.
4. In the drive enclosure migration situation, verify the controller firmware level of both the source and target storage subsystems. Upgrade both source and target storage subsystems to the same controller firmware if possible.
5. If the storage enclosure that is to be migrated is not the same type as the existing storage enclosures (some or all), see “Intermixing storage enclosures” on page 21 for intermix information.

Note: You must group like storage enclosure types in adjacent positions on the Fibre Channel loop when they are intermixed in a DS4000 storage subsystem redundant drive loop configuration.

6. If you are adding new enclosures with new drives, proceed with the steps in “Adding new storage enclosures with new hard disk drives”; otherwise, proceed to the steps in “Migrating storage enclosures with hard disk drives that have defined logical drive configurations” on page 79.

Adding new storage enclosures with new hard disk drives

To add new storage enclosures with new hard disk drives, complete the following steps:

1. Unpack and mount any additional storage enclosures in the rack by using the mounting hardware that is supplied with each storage enclosure.

Important: Do not fully insert hard disk drives into the enclosures at this time. Keep them unlatched and no less than 1.27 cm (0.5 in.) away from their full insertion points in the drive bays.

2. Set the enclosure ID of the additional storage enclosures with Fibre Channel drive ports that have a mechanical enclosure ID switch.

Each enclosure in the storage subsystem configuration must have a unique enclosure ID. In addition, the IDs of enclosures (including the storage subsystem with internal drive bays) that are connected together in the same redundant drive loop/channel pair must each have a unique rightmost digit.

For example, 01, 02, 03, 04 or 11, 12, 13, 14 are the correct IDs of the enclosures, including the subsystems with internal drives that are connected together in a drive loop/channel, whereas 01, 11, 21, 31 or 11, 11, 22, 33 are not the correct IDs of the enclosures that are connected together in a drive loop/channel pair (including the subsystems with internal drives) because the rightmost digits in the enclosure IDs are not unique (01, 11, 21, 31) or the enclosure IDs are not unique (11, 11, 22, 33).

The EXP500 storage enclosure has an enclosure ID switch on each ESM canister. Set each enclosure ID switch to the same unique number as the drive loop. EXP100, EXP700, and EXP710 storage enclosures have one enclosure ID switch between the power supplies. The EXP395, EXP420, EXP520, EXP810, EXP5000, EXP5060, and DCS3700 storage expansion enclosures have a display that shows the enclosure ID. The controller firmware automatically sets the enclosure ID; however, you can change the enclosure ID through the DS Storage Manager Client program.

For more information, see the documentation that comes with your storage enclosure. Figure 26 on page 79 illustrates the location of enclosure ID switches on the EXP100, EXP500, EXP700, EXP710, and EXP420/EXP520/EXP810/EXP5000 storage enclosures.

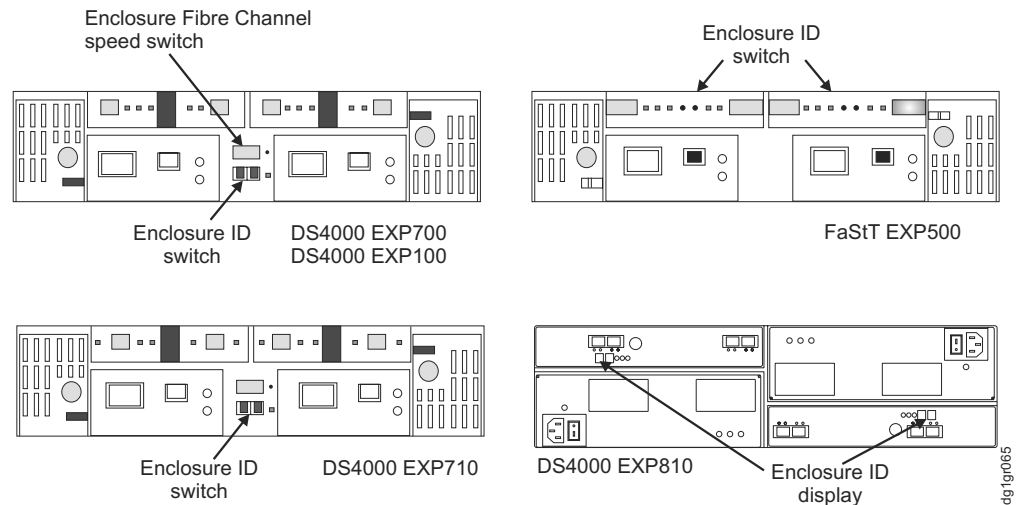

Figure 26. EXP100, EXP500, EXP700, EXP710, EXP395/EXP420/EXP520/EXP810/EXP5000 storage enclosure ID and speed switches

If the storage subsystem to which the storage enclosure attaches is a DS3000, DS3500, DCS3700, DCS3700 with Performance Module Controllers, DS3950, DS4100, DS4200, DS4300, DS4700 Express, or DS5020 storage subsystem, the enclosure IDs of additional storage enclosures must be unique to the storage subsystem. The enclosure ID of DS3500, DCS3700, DCS3700 with Performance Module Controllers, DS4100, and DS4300 storage subsystems is normally set to 00 at the factory. The enclosure ID of the DS3000, DS3950, DS4200, DS4700 Express, and DS5020 storage subsystems is normally set to 85 at the factory.

3. If necessary, ensure that the storage enclosure speed switch is set to the correct drive loop speed, which is the highest speed at which all enclosures in the drive loop/channel can operate. Not all storage enclosures have an enclosure speed switch. For more information, see the storage enclosure documentation. For example, if there is a mix of drive enclosures that are Fibre Channel 4 Gbps capable and Fibre Channel 2 Gbps capable in the same drive loop/channel, all of the enclosures must have the speed switch set at the highest speed that all enclosures can operate, which is Fibre Channel 2-Gbps speed.

Note: If a Fibre Channel enclosure speed switch was originally set to 1 Gbps, do not automatically set it to 2 Gbps unless you are sure that each Fibre Channel hard disk drive that it contains is capable of 2-Gbps operation. Ensure that you installed the latest firmware to enable hard disk drive operation in a 2-Gbps Fibre Channel environment. Similarly, do not automatically change the settings from 2 Gbps to 4 Gbps unless you are sure that the installed drives are capable of a 4-Gbps operation. Do not automatically move up to higher speed unless the installed disk drives can operate at a higher speed.

4. Proceed to “Step 6: Cabling, turning on, and verifying storage enclosure operation” on page 84. Do not perform Activities 3–5.

Migrating storage enclosures with hard disk drives that have defined logical drive configurations

Before you begin, review the “Drive migration limitations” on page 14 section. Drives with disk pools cannot be migrated from one subsystem to another. The data in the disk pool must be backed up to a tape or to drives that are part of traditional arrays. Then, the data is restored to newly created disk pools in another storage subsystem.

To migrate storage enclosures with hard disk drives that have defined logical drive configurations, complete the following steps.

1. Ensure that controller firmware and NVSRAM in both the target migration storage subsystem and the storage subsystem that contains the enclosures that are to be migrated are at the levels in Table 2 on page 9.
2. Ensure that the firmware of the ESMs in the storage enclosures that you plan to migrate are at the levels in Table 3 on page 12.
3. Ensure that the firmware of the ESMs in the storage enclosures that are attached to the target migration storage subsystem is at the levels in Table 3 on page 12.
4. If you migrate storage enclosures from a lower Fibre Channel environment to a higher Fibre Channel environment (for example, moving from 1 Gbps to 2 Gbps or from 2 Gbps to 4 Gbps), verify that each of the Fibre Channel hard disk drives that you plan to migrate are capable of higher Fibre Channel speed operation and that you installed the latest firmware, if required.
Data on drives migrate with those drives when the drives are installed on another storage subsystem. For a successful migration, perform steps 5, 6, 7 and 8 that follow.
5. Delete the storage partitioning mappings of the logical drives.
6. Ensure that all of the IDs of the storage enclosures in the redundant drive loop/channel have unique single digit (x1) values.
7. In addition to array configuration information, any storage partitioning configuration data on drives migrate with those drives when they are installed on another storage subsystem. For this reason, take the following precautions to facilitate the migration process and prevent problems in storage partitioning configuration data migration:
 - a. If a storage partitioning premium feature is enabled on both the original and destination storage subsystems, ensure that the defined host ports, hosts, and host group names are unique to each storage subsystem that is involved in the migration.
 - b. If you must use identical names on both storage subsystems, make the names unique before you perform the drive migration. If necessary, customize the storage partitioning information about the storage subsystem to which you migrated the drives after you complete the migration.
8. Delete any FlashCopy images of logical drives that are defined in the hard disk drives.
9. Remove any remote mirror relationships that involve the logical drives that are defined on the drives that you plan to migrate.
10. Proceed to “Step 2: Preparing and backing up the drives.”

Step 2: Preparing and backing up the drives

To prepare and back up the drives, complete the following steps.

Note: The following procedure is for migrating enclosures with drives that have defined arrays/logical drives only. Do not perform this procedure if you are adding enclosures with new drives or drives that contain unneeded data.

1. If the arrays and logical drives that are involved are not in Optimal state, perform the steps that are necessary to bring these arrays and logical drives to Optimal state before you attempt migration. Use the Recovery Guru function in

the Storage Subsystem Management window of the DS Storage Manager Client program. For more information, “Bringing storage subsystems and drive loops into optimal state” on page 21.

2. If the drive enclosures that you plan to migrate are not in Optimal state, perform the steps that are necessary to bring them to Optimal state before you attempt migration. Use the Recovery Guru function in the Storage Subsystem Management window of the DS Storage Manager Client program. For more information, see “Bringing storage subsystems and drive loops into optimal state” on page 21.
3. Perform a backup of the logical drives that are defined in the storage enclosures.
4. Monitor the storage subsystem event log for any errors in the drive loop or its components for several days before you migrate storage enclosures.
5. Stop all programs, services, or processes in the host servers that access the logical drives that are defined in the migrated hard disk drives. ensure that there are not any running background programs, services, or processes that write data to the logical drives. (For example, Microsoft MSCS service periodically writes to the “Quorum” disk.)
6. Unmount the file systems to flush I/O from the server cache to disks.

Note:

- a. In a Microsoft Windows environment, remove the drive letter or the mount points of the mapped LUNs instead of unmounting the file systems.
 - b. See the documentation for your operating system for detailed information about the unmount procedure.
7. Save the storage subsystem profile and storage subsystem configuration, and collect all support data bundles of the target storage subsystem in a location other than the logical drives that you plan to migrate.
 8. Place the arrays that are defined in the storage enclosures that you plan to migrate in Offline state. The method that you use to place an array in Offline state varies according to the controller firmware and Storage Manager software versions:
 - If the controller firmware level is earlier than 7.xx and the Storage Manager software version is 10.xx, right-click the name of the array in the Storage Subsystem Management window and click **Place -> Offline**.
 - If the controller firmware level is 7.xx or later and the Storage Manager software version is 10.xx or later, use the Export Array feature. See “Step 3: Placing drives offline” on page 62 for details.

Note: The DS3000 storage subsystem supports these array functions though the SMcli interface. See the Storage Manager online help for the SMcli command syntax.

9. If the migrated drives are FDE drives and were configured as part of a secured array, save the security key to unlock the drives after you install them in a new storage subsystem. Without this key, the controllers cannot unlock the drives to perform read and write operations.

Step 3: Shutting down and moving the storage enclosures

To shut down and move the storage enclosure, complete the following steps.

Note: The following procedure is for migrating enclosures with drives that have defined arrays/logical drives only. Do not perform this procedure if you are adding enclosures with new drives or drives that contain unneeded data.

1. Because removing a storage enclosure from a storage subsystem disrupts the drive loops, shut down the storage subsystem while you remove the storage enclosures for migration to another storage subsystem. If you cannot shut down the storage subsystem, reconfigure only one drive loop, making sure that the drive loop that you modify is connected correctly and in Optimal state before you attempt to reconfigure the other drive loop. For more information, see “Bringing storage subsystems and drive loops into optimal state” on page 21.

Take this precaution to prevent the arrays from being inadvertently failed by the storage subsystem controllers because two or more drives in the arrays cannot be reached through either drive loop in the redundant drive loop pair.

Complete the following steps to verify that the drive loops are in Optimal state:

- a. Physically trace the actual cable connections to ensure that connections are properly modified and that the cable connectors are firmly inserted into the SFPs or GBICs.
- b. Ensure that the following LEDs are not lit or flashing in the modified drive loop:
 - ESM fault
 - Port bypass
 - ID conflict
- c. Ensure that the controller drive loop LED remains lit. If the controller drive loop LED is turned off, there are problems in the drive loop, and the loop initialization primitives (LIPs) are generated by the storage subsystem controller.
- d. In the DS Storage Manager Client Subsystem Management window, verify that there are no Loss of ESM path redundancy errors in the storage enclosures that are not migrated.

Do not modify the second drive loop in the redundant drive loop pair until you are sure that the first modified drive loop is operating in Optimal state.

2. Turn off the power to the storage enclosures and move them to the storage subsystem to which you plan to migrate them.

Attention: A storage enclosure with 14 drives weighs up to 45 kg (100 lb). If necessary, remove the drives and other storage enclosure components to reduce the weight of the unit for easier handling. Mark each drive before you remove it so that you can return it to the same drive bay when you reassemble the components. The EXP5060 storage enclosure requires a lift tool and a relocation kit to move the storage enclosure from one location to another. For more information, see the EXP5060 storage enclosure documentation.

Step 4: Verifying the drive migration enable settings

Attention: There is no need to verify drive migration enable settings in storage enclosures with controller firmware level 7.xx or later and Storage Manager software version 10.xx or later.

The DS4000 storage subsystem drive migration setting of the DS4000 storage subsystem with controller firmware 6.xx.xx or earlier must be set to Enable before you insert drives with configuration data. Verify the drive migration setting on the target migration storage subsystem. Perform the procedure to run the EnableDriveMigration.scr script to ensure that the drive migration setting is set to

Enable before you insert any drives with configuration data. See “Step 3: Re-enabling the drive migration settings” on page 71 for instructions.

Step 5: Installing and setting storage enclosure IDs and speeds

Note: The following procedure is for migrating enclosures with drives that have defined arrays/logical drives only. Do not perform this procedure if you are adding enclosures with new drives or drives that contain unneeded data.

To install and set storage enclosure IDs and speeds, complete the following steps:

1. When the storage enclosures and drives are at the location of the storage subsystem to which you are migrating them, install them into the rack. If the drives were removed during transit, return them to the bays from which they were removed, unlatched and no less than 1.27 cm (0.5 in.) away from their full insertion points in the drive bays. If the drives were not removed, unlatch and pull them out no less than 1.27 cm (0.5 in.) away from their full insertion points in the drive bays. For the EXP5060 storage enclosure, leave the drives in the drive relocating boxes.
2. Ensure that the enclosure ID of each enclosure in a storage subsystem configuration is unique. For more information, see “Adding new storage enclosures with new hard disk drives” on page 78.

Important: If the storage subsystem to which the storage enclosure attaches is a DS3000, DS3500, DCS3700, DCS3700 with Performance Module Controllers, DS3950, DS4100, DS4200, DS4300, DS4700, or DS5020 storage subsystem, the IDs of additional storage enclosures must be unique to the storage subsystem. The enclosure ID of DS3500, DCS3700, DCS3700 with Performance Module Controllers, DS4100, and DS4300 storage subsystems is normally set to 00 at the factory. The enclosure ID of the DS3000, DS3950, DS4200, DS4700, and DS5020 storage subsystems is normally set to 85 at the factory.

3. If necessary, ensure that the storage enclosure speed switch is set to the correct drive loop speed, which is the highest speed at which all enclosures in the drive loop/channel can operate. For example, if there is a mix of drive enclosures that are Fibre Channel 4 Gbps capable and Fibre Channel 2 Gbps capable in the same drive loop/channel, all of the enclosures must have the speed switch set at the highest speed at which all enclosures can operate, which is Fibre Channel 2-Gbps speed.

Note: If a Fibre Channel enclosure speed switch was originally set to 1 Gbps, do not automatically set it to 2 Gbps unless you are sure that each Fibre Channel hard disk drive that it now contains is capable of 2-Gbps operation. Ensure that you install the latest firmware to enable hard disk drive operation in a 2-Gbps Fibre Channel environment. Similarly, do not automatically change the settings from 2 Gbps to 4 Gbps unless you are sure that the installed drives are capable of 4-Gbps operation. Do not automatically move up to higher speed unless the installed disk drives can operate at a higher speed.

Note: Before you migrate hard disk drives, be sure to determine the compatibility of drive model capacity, interface type, and speed. For specific information about your drive options in the most current environment, see “Verifying hard disk drive model compatibility” on page 17.

Step 6: Cabling, turning on, and verifying storage enclosure operation

This procedure is for both adding and migrating storage enclosures. The following notes describe information that you must consider when you connect the storage enclosure:

- Connect the new storage enclosure first to any unused drive ports, especially if you are adding storage enclosures of a different type to the configuration.
- If there are not any unused drive ports, connect the new storage enclosure to the existing drive loop that can accommodate additional storage enclosures.
- Add only one storage enclosure at a time to a drive loop, if you intend to attach multiple storage enclosures.
- See the documentation that comes with your storage subsystem to attach the storage enclosures to the storage subsystem. Also, see “DS4000 and DS5000 storage subsystem Fibre Channel drive loop schemes” on page 102 and “Storage subsystem SAS drive channel/loop schemes for enclosures in a DS3000 or DS3500 configuration” on page 106

Attention: Do not power on a storage subsystem with new drives installed in the new storage enclosures. Either remove the drives completely or pull out the drives about one-half inch from the storage enclosure before powering on the storage subsystem. Otherwise, the controllers might not boot up.

If the DS4000 storage subsystem (DS4400 and DS4500 storage subsystems) contains drive minihubs, do not use more than one port per drive minihub. Always leave one of the two drive ports empty in each drive minihub.

Cabling the new enclosures

To complete the addition of storage enclosures, cable the storage enclosures to the end of the storage enclosure drive loop to which you are migrating them. Add only one enclosure at a time to a drive loop, if you intend to attach multiple storage enclosures.

Connect the storage enclosure to any unused drive ports when you add storage enclosures to an existing configuration, especially if you are adding enclosures of a different type to the configuration. See the documentation that comes with your storage subsystem to attach the storage enclosures to the storage subsystem.

If your DS4000 storage subsystem contains drive mini hubs, do not use more than one port per drive mini hub. Always leave one of the two drive ports empty in each drive mini hub.

You can connect storage enclosures at either end, or in the middle, of an existing storage enclosure drive loop. Figure 27 on page 85 shows possible ways of adding enclosures to a storage enclosure drive loop. The options are as follows:

- The beginning, closest to the controller (at the top, directly attached to controller A) as described in “Connecting storage enclosures at the beginning (top) of a drive loop” on page 97.
- The middle, between the existing storage enclosures in the redundant drive loop/channel pair, as described in “Connecting storage enclosures in the middle of a drive loop” on page 92.
- The end, farthest from the controller (at the bottom, directly attached to controller B) as described in “Connecting storage enclosures at the end (bottom) of a drive loop” on page 86.

You might find that connection to the end (at the bottom) directly attached to controller B is best practice because if the existing configuration is not planned for cabling-in storage enclosures at the top or the middle of the drive loop, cluttered drive loop cabling might hinder troubleshooting or cause cabling errors. Depending on your requirements, follow one of the procedures in “Connecting storage enclosures at the end (bottom) of a drive loop” on page 86, “Connecting storage enclosures in the middle of a drive loop” on page 92, or “Connecting storage enclosures at the beginning (top) of a drive loop” on page 97.

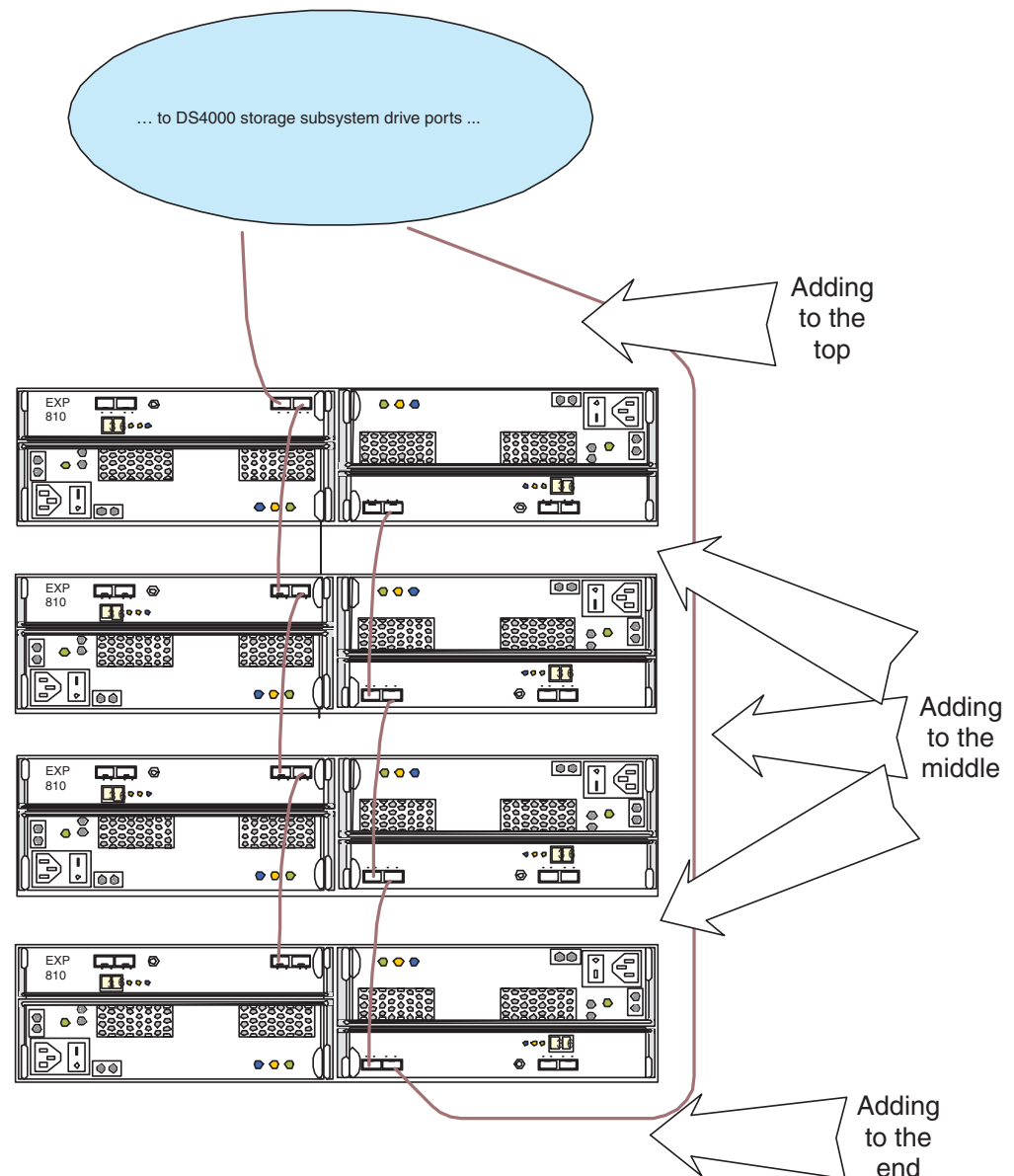

Figure 27. Example of adding storage enclosure positions within a drive loop

The procedures and graphics in “Connecting storage enclosures at the end (bottom) of a drive loop” on page 86 and “Connecting storage enclosures at the beginning (top) of a drive loop” on page 97 illustrate how to connect 10- or 14-drive storage enclosures, for example, an EXP700 or EXP710 to a DS4300 storage subsystem drive loop. To connect 16-drive storage enclosures, for example, an EXP810 to an existing DS4800 storage subsystem drive loop, follow the similar

steps; however, the port names on the EXP700 storage enclosure are different from the port names on the EXP810 storage enclosure. Only typical expansion enclosure additions are shown in the procedure and graphics in these sections. However, the instructions can be adapted for all expansion enclosure addition scenarios. For the appropriate cabling scenario and to adapt the instructions to add an expansion enclosure to an existing drive loop in a storage subsystem configuration, refer to the storage subsystem *Installation, User's and Maintenance Guide*.

Connecting storage enclosures at the end (bottom) of a drive loop

Connecting a new storage enclosure to the end of the drive loop is the best practice to avoid cluttered drive loop cabling that might hinder troubleshooting or cause cabling errors.

To connect a storage enclosure at the end (bottom) of a drive loop, complete the following steps:

Note: See “Examples of connecting storage enclosures at the middle of a drive loop” on page 95 for cabling illustrations and to identify the storage enclosures referred to in the steps.

1. (For storage subsystems and storage enclosures with Fibre Channel drive port connections only) Insert the small form-factor pluggables (SFPs) or gigabit interface converters (GBICs) into only those ports that you intend to use. Do not leave GBICs or SFPs inserted into port connectors without connecting them to other ports by using cables. An unused SFP or GBIC, even pulled slightly away from the socket might generate random errors in the drive loop/channel.
2. (For storage enclosures with mechanical enclosure ID switches) Change the enclosure ID to a unique number with a unique single (x1) digit. See “Setting enclosure IDs for enclosures in DS4000 and DS5000 storage subsystems” on page 29.
3. Extend one of the drive loops (that is, drive loop/channel that is connected to controller A) in a storage subsystem redundant drive loop/channel pair by connecting the ESM port of the left ESM in the last storage enclosure on the existing drive loop/channel A to the ESM port of the left ESM in the new storage enclosure. For EXP5060 storage enclosures and DCS3700 storage expansion enclosures (for both - DCS3700 and DCS3700 with Performance Module Controllers), use the top ESM instead of the left ESM.
4. Ensure that there are not any drives fully inserted in the drive bays; then, turn on the power to the added storage enclosure.
5. Wait a few seconds. Check the drive port LEDs to ensure that the link to the new storage enclosure is up and optimal and that there are no link problems in the modified drive loop A. Ensure that the FC port bypass (FC ports) or SAS link service (SAS port) LEDs are not lit or intermittently lit. Using the DS Storage Manager Client Subsystem Management window, verify that the storage enclosure is added and displayed in the Logical/Physical view of the window. To return the drive loop/channel to optimal state, see “Returning the drive/loop channel to optimal state” on page 101.
6. In the drive loop/channel that is connected to controller B, move the connection from controller B drive port to the ESM port in the right ESM of the last storage enclosure in the existing drive loop/channel B to the ESM port of the right ESM in the new storage enclosure. Controller B drive port is now connected to the ESM port of the new storage enclosure. For EXP5060 storage enclosures, use the bottom ESM instead of the right ESM.

7. Wait a few seconds. Check the drive port LEDs to ensure that the link to the new storage enclosure is up and optimal and that there are no link problems in the modified drive loop B. Ensure that the FC port bypass (FC ports) or SAS link service (SAS port) LEDs are not lit or intermittently lit. Using the DS Storage Manager Client Subsystem Management window, verify that the storage enclosure is added and displayed in the Logical/Physical view of the window. To return the drive loop/channel to optimal state, see “Returning the drive/loop channel to optimal state” on page 101.

Note: The existing storage enclosures are shown with Drive enclosure lost redundancy path errors until you establish the Fibre Channel cabling connection described in step 8.

8. In drive loop B, cable the ESM port in the right ESM of the new storage enclosure to the ESM port in the right ESM of the last storage enclosure in drive loop B. For EXP5060 storage enclosures and DCS3700 storage expansion enclosures (for both - DCS3700 and DCS3700 with Performance Module Controllers), use the bottom ESM instead of the right ESM.
9. Wait a few seconds. Check the drive port LEDs to ensure that the link to the new storage enclosure is up and optimal and that there are no link problems in the modified drive loop B. Ensure that the FC port bypass (FC ports) or SAS link service (SAS port) LEDs are not lit or intermittently lit. Using the DS Storage Manager Client Subsystem Management window, verify that the storage enclosure is added and displayed in the Logical/Physical view of the window. To return the drive loop/channel to optimal state, see “Returning the drive/loop channel to optimal state” on page 101.

Note: The existing storage enclosures are shown with Drive enclosure lost redundancy path errors until you establish the Fibre Channel cabling connection described in step 8.

10. The DS Storage Manager Client Subsystem Management window displays a new storage enclosure with no drives in the configuration.

Connecting storage enclosures at the end (bottom) of the in the DS4000 and DS5000 configuration

For storage subsystem configurations with an initial drive loop/channel cabling scheme similar to the scheme used in Figure 36 on page 102, Table 20 shows how you cable the ports. A port enclosed by () indicates that you remove the connection as part of the step. For more information, refer to Figure 28 on page 89, Figure 29 on page 90, and Figure 31 on page 92.

Note: ESM ports for EXP700, EXP710, EXP100, EXP500, EXP3000, EXP3500, and DCS3700 storage expansion enclosure are referred to as IN and OUT. ESM ports for EXP5060, EXP5000, EXP520, EXP395, EXP810, and EXP420 expansion enclosure are referred to as 1B and 1A. For more information, refer to the expansion enclosure *Installation, User’s, and Maintenance Guide*.

Table 20. Connecting storage enclosures at the end (bottom) of the best practice cable loop scheme

Step	Storage subsystem		Drive expansion 2		Drive expansion 3	
	Controller A	Controller B	Left ESM	Right ESM	Left ESM	Right ESM
3 on page 86			OUT/1A		IN/1B	

Table 20. Connecting storage enclosures at the end (bottom) of the best practice cable loop scheme (continued)

Step	Storage subsystem		Drive expansion 2		Drive expansion 3	
6 on page 86		Drive port x		(OUT/1B)		OUT/1B
8 on page 87				OUT/1B		IN/1A

Connecting storage enclosures at the end (bottom) of a SAS drive cable loop scheme in a DS3000, DS3500, DCS3700, and DCS3700 with Performance Module Controllers configuration

For DS3000, DS3500, DCS3700, and DCS3700 with Performance Module Controllers storage subsystem configurations with an initial drive loop/channel cabling scheme that is similar to the scheme used in “Storage subsystem SAS drive channel/loop schemes for enclosures in a DS3000 or DS3500 configuration” on page 106, Table 21 shows how you cable the ports. A port enclosed by () indicates that you remove the connection as part of the step. For more information, see Figure 30 on page 91.

Table 21. Connecting storage enclosures at the end (bottom) of a SAS drive cable loop scheme in a DS3000, DS3500, DCS3700 or DCS3700 with Performance Module Controllers configuration

Step	Storage subsystem		Drive expansion 2		Drive expansion 3	
	Controller A	Controller B	Left ESM	Right ESM	Left ESM	Right ESM
3 on page 86			OUT		IN	
6 on page 86		Drive port x		(IN)		IN
8 on page 87				IN		OUT

Note: For EXP5060 Storage Enclosures and DCS3700 Storage Expansion Enclosures, use the top ESM instead of the left ESM. Similarly, use the bottom ESM instead of the right ESM.

Examples of connecting storage enclosures at the end (bottom) of a drive loop

The following figures show examples of adding storage enclosures to the bottom of the drive loop/channel.

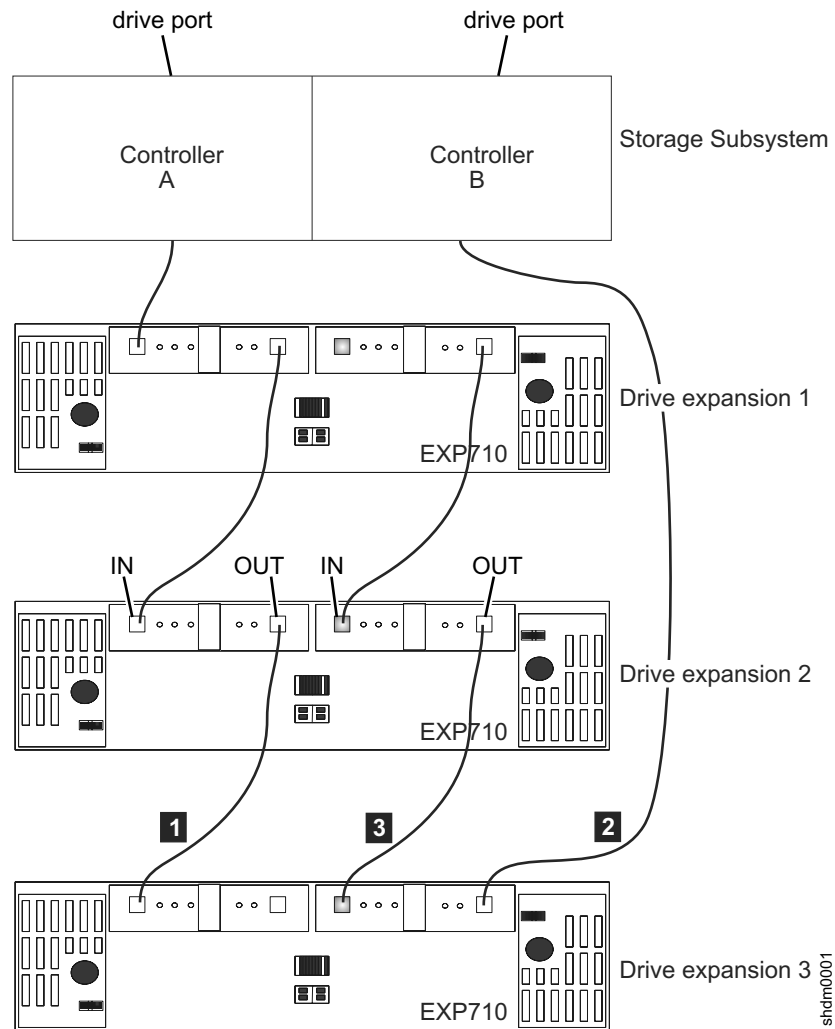

shdm0001

Figure 28. Cabling an additional EXP700/EXP710/EXP100/EXP500 storage enclosure

Legend:

- 1 See step 3 on page 86.
- 2 See step 6 on page 86.
- 3 See step 8 on page 87.

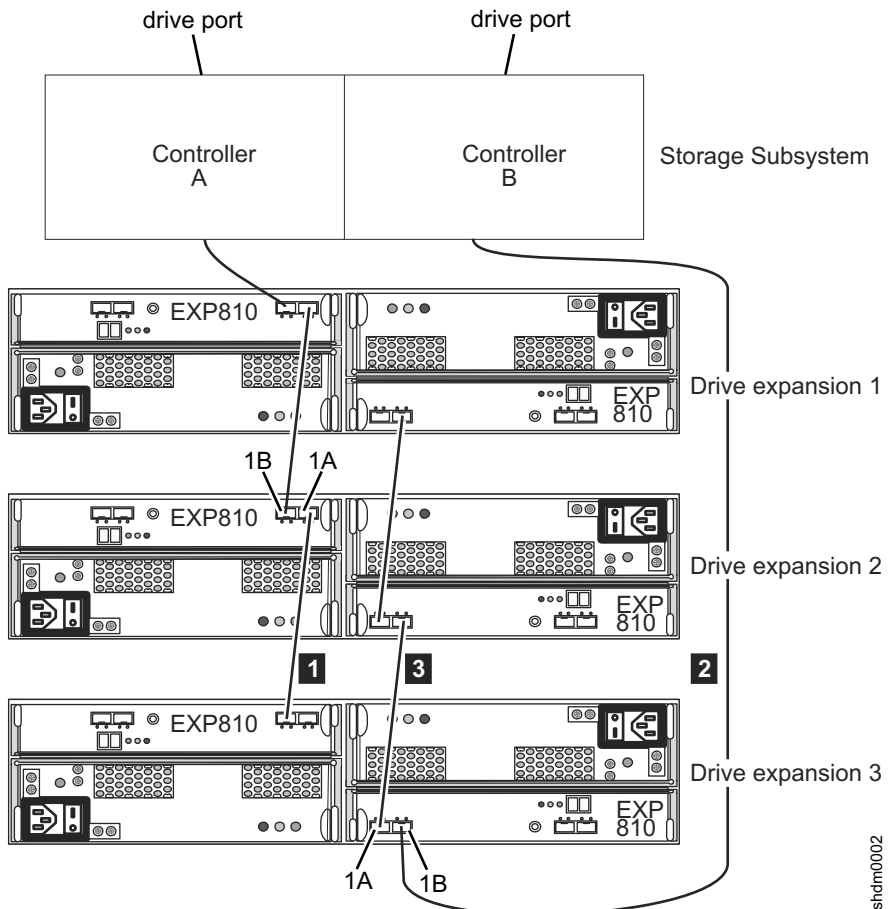

shdm0002

Figure 29. Cabling an additional EXP5000, EXP520, EXP395, EXP810, or EXP420 storage enclosure

Legend:

- 1 See step 3 on page 86.
- 2 See step 6 on page 86.
- 3 See step 8 on page 87.

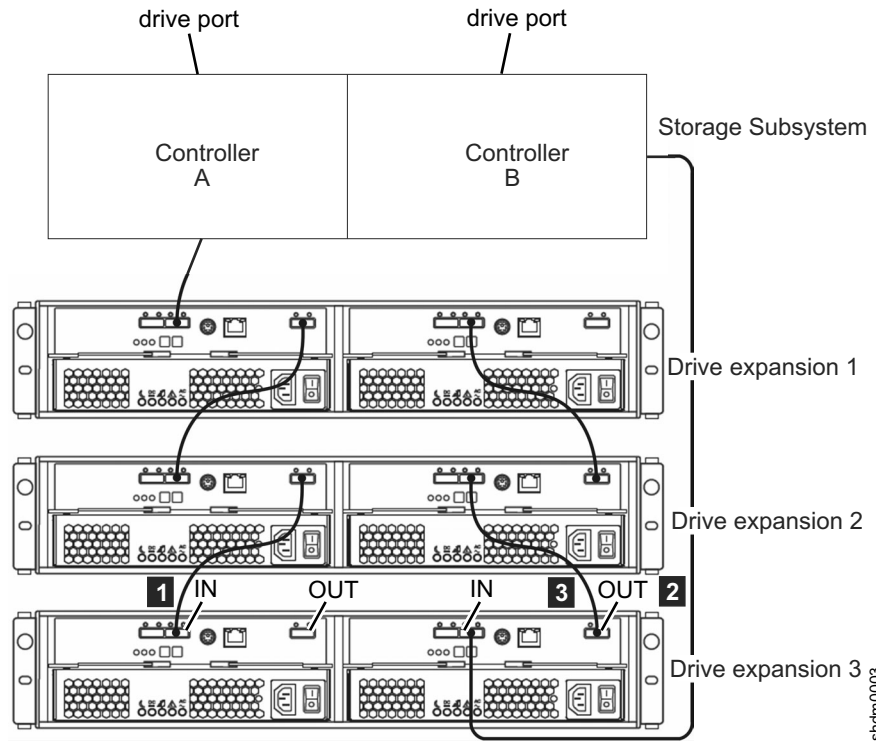
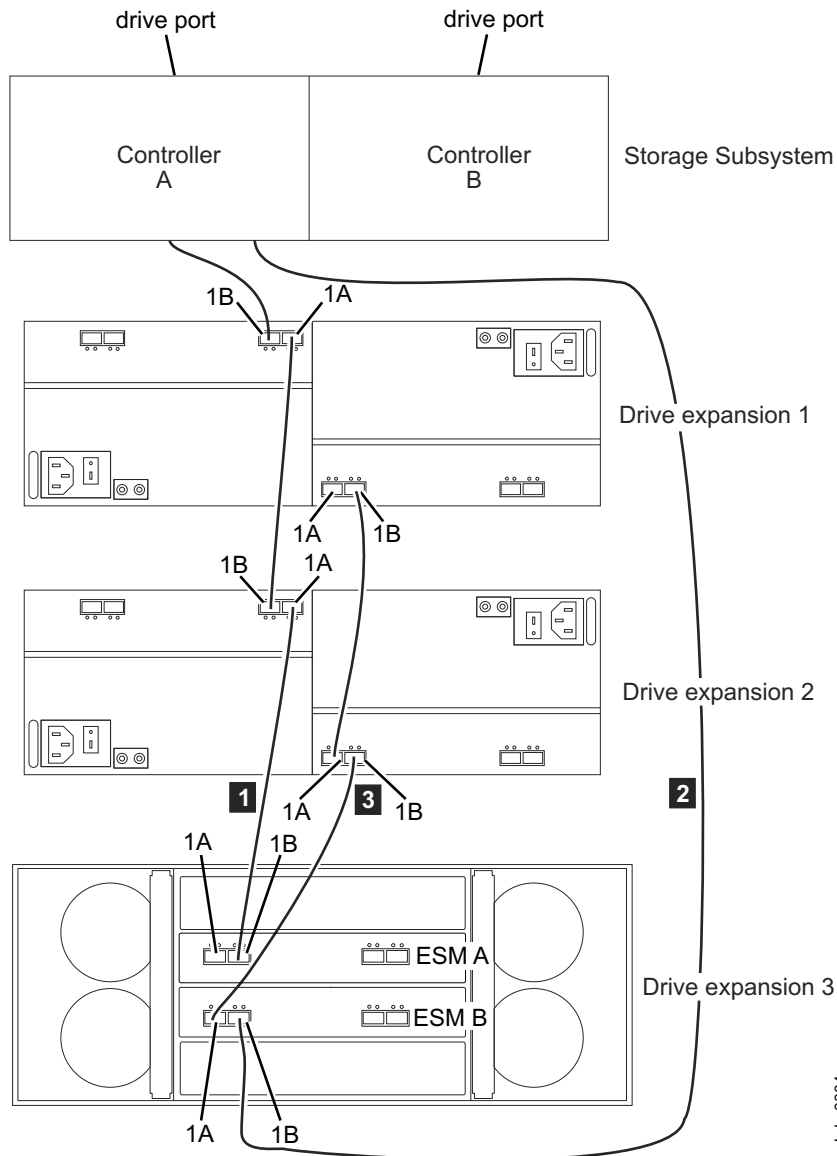

Figure 30. Cabling an additional EXP3000, EXP3512, or EXP3524 storage enclosure

Legend:

- 1 See step 3 on page 86.
- 2 See step 6 on page 86.
- 3 See step 8 on page 87.



shdm0004

Figure 31. Cabling an additional EXP5060 storage enclosure

Legend:

- 1 See step 3 on page 86.
- 2 See step 6 on page 86.
- 3 See step 8 on page 87.

Connecting storage enclosures in the middle of a drive loop

Do not add storage enclosures at the middle of a drive loop, especially if there is insufficient rack space to allow uncluttered cabling of new storage enclosures. However, if this is the only option available, plan the addition carefully and note the existing cabling before changing the configuration. Lack of proper planning might result in cable management issues that contribute to avoidable troubleshooting difficulties.

To connect a storage enclosure at the middle of a drive loop, complete the following steps.

Note: See “Examples of connecting storage enclosures at the middle of a drive loop” on page 95 for cabling illustrations and to identify the storage enclosures that are referred to in the steps.

1. (For storage subsystem and storage enclosures with FC drive port connection only) Insert the small form-factor pluggables (SFPs) or gigabit interface converters (GBICs) into only those ports that you intend to use. Do not leave GBICs or SFPs inserted into port connectors without connecting them to other ports by using cables. An unused SFP or GBIC, even pull slightly away from the socket might generate random errors in the drive loop/channel.
2. (For storage enclosures with mechanical enclosure ID switches) Change the enclosure ID to a unique number with a unique single (x1) digit. See “Setting enclosure IDs for enclosures in DS4000 and DS5000 storage subsystems” on page 29.
3. Move the existing connection between the ESM port of the right ESM in storage enclosure 2 to the ESM port of the right ESM in storage enclosure 1 to the ESM port of the new storage enclosure instead.
4. Ensure that there are not any drives fully inserted in the drive bays; then, turn on the power to the added storage enclosure.
5. Wait a few seconds. Check the drive port LEDs to ensure that the link to the new storage enclosure is up and optimal and that there are no link problems in the modified drive loop A. Ensure that the FC port bypass (FC ports) or SAS link service (SAS port) LEDs are not lit or intermittently lit. Using the DS Storage Manager Client Subsystem Management window, verify that the storage enclosure is added and displayed in the Logical/Physical view of the window. To return the drive loop/channel to optimal state, see “Returning the drive/loop channel to optimal state” on page 101.
6. Add a cabling connection between the ESM of the right ESM in storage enclosure 1 to the ESP port of the right ESM in the new storage enclosure.
7. Wait a few seconds. Check the drive port LEDs to ensure that the link to the new storage enclosure is up and optimal and that there are no link problems in the modified drive loop B. Ensure that the FC port bypass (FC ports) or SAS link service (SAS port) LEDs are not lit or intermittently lit. Using the DS Storage Manager Client Subsystem Management window, verify that the storage enclosure is added and displayed in the Logical/Physical view of the window. To return the drive loop/channel to optimal state, see “Returning the drive/loop channel to optimal state” on page 101.

Note: The existing storage enclosures are shown with Drive enclosure lost redundancy path errors until you establish the Fibre Channel cabling connection described in step 8.

8. Move the existing connection between the ESM port of the left ESM in storage enclosure 1 to the ESM port of the left ESM in storage enclosure 2 to the ESM port of the new storage enclosure instead.
9. Wait a few seconds. Check the drive port LEDs to ensure that the link to the new storage enclosure is up and optimal and that there are no link problems in the modified drive loop B. Ensure that the FC port bypass (FC ports) or SAS link service (SAS port) LEDs are not lit or intermittently lit. Using the DS Storage Manager Client Subsystem Management window, verify that the storage enclosure is added and displayed in the Logical/Physical view of the window. To return the drive loop/channel to optimal state, see “Returning the drive/loop channel to optimal state” on page 101.

Note: The existing storage enclosures are shown with Drive enclosure lost redundancy path errors until you establish the Fibre Channel cabling connection described in step 8 on page 93.

10. Add a cabling connection between the ESM of the left ESM in storage enclosure 2 to the ESP port of the left ESM in the new storage enclosure.
11. Wait a few seconds. Check the drive port LEDs to ensure that the link to the new storage enclosure is up and optimal and that there are no link problems in the modified drive loop B. Ensure that the FC port bypass (FC ports) or SAS link service (SAS port) LEDs are not lit or intermittently lit. Using the DS Storage Manager Client Subsystem Management window, verify that the storage enclosure is added and displayed in the Logical/Physical view of the window. To return the drive loop/channel to optimal state, see “Returning the drive/loop channel to optimal state” on page 101.

Note: The existing storage enclosures are shown with Drive enclosure lost redundancy path errors until you establish the Fibre Channel cabling connection described in step 8 on page 93.

12. The DS Storage Manager Client Subsystem Management window displays a new storage enclosure with no drives in the configuration.

Connecting storage enclosures at the middle of the best practice cable loop scheme in a DS4000 and DS5000 configuration

For storage subsystem configurations with an initial drive loop/channel cabling scheme similar to the scheme used in Figure 36 on page 102, Table 22 shows how you cable the ports by adding a third expansion enclosure in the middle of the first and second expansion enclosures. A port enclosed by () indicates that you remove the connection as part of the step.

Note: ESM ports for EXP700, EXP710, EXP100, EXP500, EXP3000, EXP3500, and DCS3700 storage expansion enclosure are referred to as IN and OUT. ESM ports for EXP5060, EXP5000, EXP520, EXP395, EXP810, and EXP420 expansion enclosure are referred to as 1B and 1A. For more information, refer to the expansion enclosure *Installation, User’s, and Maintenance Guide*.

Table 22. Connecting storage enclosures at the middle of the best practice cable loop scheme

Step	Expansion enclosure 1		Expansion enclosure 2		Expansion enclosure 3 (new)	
	Controller A	Controller B	Left ESM	Right ESM	Left ESM	Right ESM
3 on page 93		(OUT/1B)		IN/1A		OUT/1B
6 on page 93		OUT/1B				IN/1A
8 on page 93	OUT/1A		(IN/1B)		IN/1B	
10			IN/1B		OUT/1A	

Connecting storage enclosures at the middle of a SAS drive cable loop scheme in a DS3000, DS3500, DCS3700, and DCS3700 with Performance Module Controllers configuration

For DS3000, DS3500, DCS3700, and DCS3700 with Performance Module Controllers storage subsystem configurations with an initial drive loop/channel cabling

scheme that is similar to the scheme used in “Storage subsystem SAS drive channel/loop schemes for enclosures in a DS3000 or DS3500 configuration” on page 106, Table 23 shows how you cable the ports by adding a third expansion enclosure in the middle of the first and second expansion enclosures. A port enclosed by () indicates that you remove the connection as part of the step.

Table 23. Connecting storage enclosures at the middle of a SAS drive cable loop scheme in a DS3000, DS3500, DCS3700, or DCS3700 with Performance Module Controllers configuration

Step	Expansion enclosure 1		Expansion enclosure 2		Expansion enclosure 3 (new)	
	Controller A	Controller B	Left ESM	Right ESM	Left ESM	Right ESM
3 on page 93		(IN)		OUT		IN
6 on page 93		IN	IN			OUT
8 on page 93	(OUT)		(IN)		IN	
10 on page 94	OUT		IN		OUT	

Examples of connecting storage enclosures at the middle of a drive loop

The following figures show examples of adding storage enclosures to the middle of the drive loop/channel configuration.

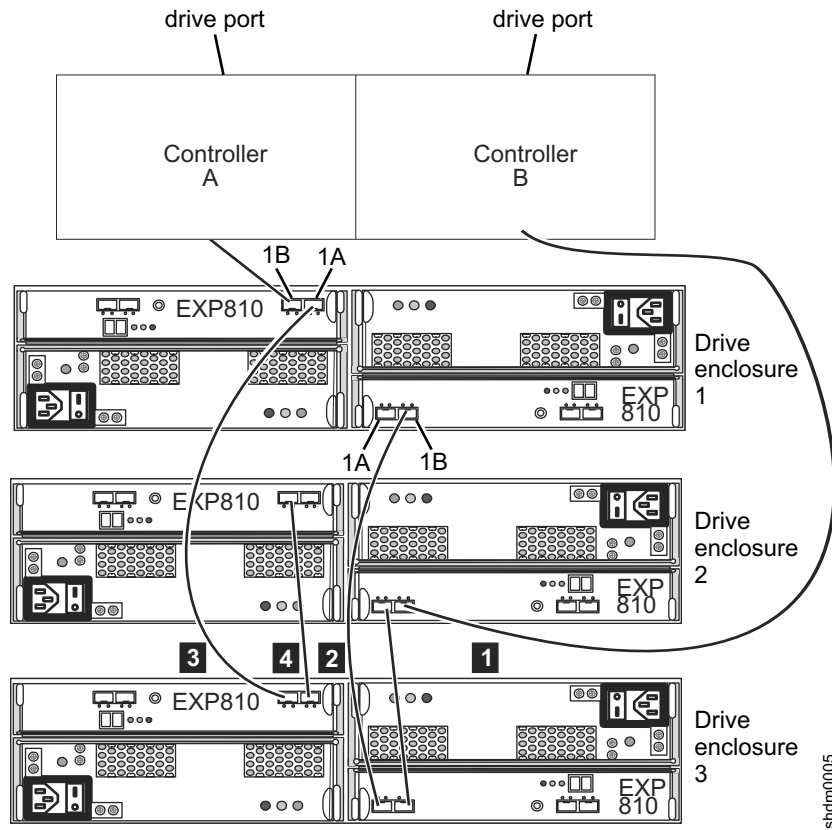

Figure 32. Cabling an additional storage enclosure to the middle of the drive loop in a DS5000 storage subsystem

Legend:

- 1 See step 3 on page 93.
- 2 See step 6 on page 93.
- 3 See step 8 on page 93.
- 4 See step 10 on page 94.

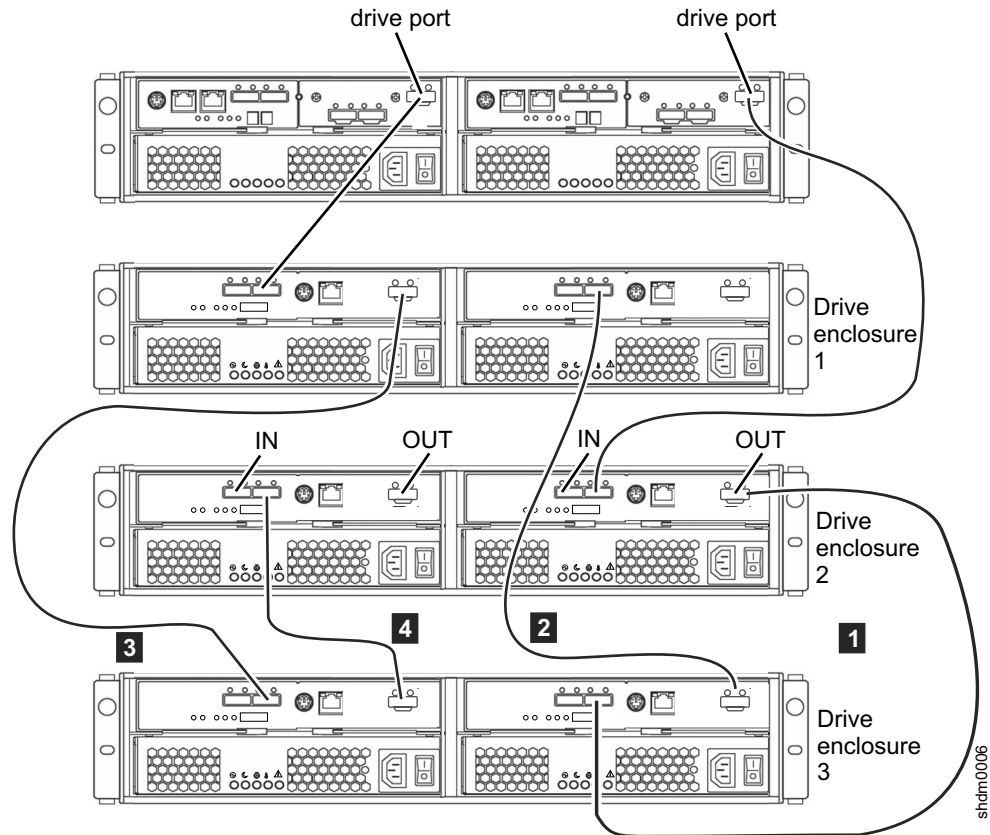

Figure 33. Cabling an additional storage enclosure to the middle of the drive loop in a DS3000 storage subsystem configuration

Legend:

- 1 See step 3 on page 93.
- 2 See step 6 on page 93.
- 3 See step 8 on page 93.
- 4 See step 10 on page 94.

Connecting storage enclosures at the beginning (top) of a drive loop

Do not add storage enclosures at the top of a drive loop, especially if there is insufficient rack space to allow uncluttered cabling. However, if this is the only option available, plan the addition carefully and note the existing cabling before changing the configuration. Lack of proper planning might result in cable management issues that contribute to avoidable troubleshooting difficulties.

Note: Do not add an EXP100 storage enclosure to the beginning of a drive loop in a DS4700 or DS4800 storage subsystem because of the drive cabling limitations and schemes shown in “Cabling EXP100, EXP710, and EXP810 storage enclosures in DS4700 and DS4800 configurations” on page 109. Instead, follow the instructions in “Connecting storage enclosures at the end (bottom) of a drive loop” on page 86. If this is not possible, contact IBM support.

To connect a storage enclosure at the beginning of a drive loop, complete the following steps.

Note: See “Examples of connecting storage enclosures at the top of a drive loop” on page 100 for cabling illustrations and to identify the storage enclosures referred to in the steps.

1. (For storage subsystem and storage enclosures with FC drive port connection only) Insert the small form-factor pluggables (SFPs) or gigabit interface converters (GBICs) into only those ports that you intend to use. Do not leave GBICs or SFPs inserted into port connectors without connecting them to other ports by using cables. An unused SFP or GBIC, even pull slightly away from the socket might generate random errors in the drive loop/channel.
2. (For storage enclosures with mechanical enclosure ID switches) Change the enclosure ID to a unique number with a unique single (x1) digit. See “Setting enclosure IDs for enclosures in DS4000 and DS5000 storage subsystems” on page 29.
3. Add a cabling connection between the ESM of the right ESM in storage enclosure 1 to the ESP port of the right ESM in the new storage enclosure.
4. Ensure that there are not any drives fully inserted in the drive bays; then, turn on the power to the added storage enclosure.
5. Wait a few seconds. Check the drive port LEDs to ensure that the link to the new storage enclosure is up and optimal and that there are no link problems in the modified drive loop A. Ensure that the FC port bypass (FC ports) or SAS link service (SAS port) LEDs are not lit or intermittently lit. Using the DS Storage Manager Client Subsystem Management window, verify that the storage enclosure is added and displayed in the Logical/Physical view of the window. To return the drive loop/channel to optimal state, see “Returning the drive/loop channel to optimal state” on page 101.
6. Move the existing connection between the controller A drive port to the ESM port of the left ESM in storage enclosure 1 to the ESM port of the left ESM in the new storage enclosure instead.
7. Wait a few seconds. Check the drive port LEDs to ensure that the link to the new storage enclosure is up and optimal and that there are no link problems in the modified drive loop B. Ensure that the FC port bypass (FC ports) or SAS link service (SAS port) LEDs are not lit or intermittently lit. Using the DS Storage Manager Client Subsystem Management window, verify that the storage enclosure is added and displayed in the Logical/Physical view of the window. To return the drive loop/channel to optimal state, see “Returning the drive/loop channel to optimal state” on page 101.

Note: The existing storage enclosures are shown with Drive enclosure lost redundancy path errors until you establish the Fibre Channel cabling connection described in step 8.

8. Add a cabling connection between the ESM of the left ESM in storage enclosure 1 to the ESP port of the left ESM in the new storage enclosure.
9. Wait a few seconds. Check the drive port LEDs to ensure that the link to the new storage enclosure is up and optimal and that there are no link problems in the modified drive loop B. Ensure that the FC port bypass (FC ports) or SAS link service (SAS port) LEDs are not lit or intermittently lit. Using the DS Storage Manager Client Subsystem Management window, verify that the storage enclosure is added and displayed in the Logical/Physical view of the window. To return the drive loop/channel to optimal state, see “Returning the drive/loop channel to optimal state” on page 101.

Note: The existing storage enclosures are shown with Drive enclosure lost redundancy path errors until you establish the Fibre Channel cabling connection described in step 8.

10. Wait a few seconds. Check the drive port LEDs to ensure that the link to the new storage enclosure is up and optimal and that there are no link problems in the modified drive loop B. Ensure that the FC port bypass (FC ports) or SAS link service (SAS port) LEDs are not lit or intermittently lit. Using the DS Storage Manager Client Subsystem Management window, verify that the storage enclosure is added and displayed in the Logical/Physical view of the window. To return the drive loop/channel to optimal state, see “Returning the drive/loop channel to optimal state” on page 101.

Note: The existing storage enclosures are shown with Drive enclosure lost redundancy path errors until you establish the Fibre Channel cabling connection described in step 8 on page 98.

11. The DS Storage Manager Client Subsystem Management window displays a new storage enclosure with no drives in the configuration.

Connecting storage enclosures at the top of the best practice cable loop scheme in a DS4000 or DS5000 configuration

For storage subsystem configurations with an initial drive loop/channel cabling scheme similar to the scheme used in Figure 36 on page 102, Table 24 shows how you cable the ports by adding a third expansion enclosure at the top of the first and second expansion enclosures. A port enclosed by () indicates that you remove the connection as part of the step.

Note: ESM ports for EXP700, EXP710, EXP100, EXP500, EXP3000, EXP3500, and DCS3700 storage expansion enclosure are referred to as IN and OUT. ESM ports for EXP5060, EXP5000, EXP520, EXP395, EXP810, and EXP420 expansion enclosure are referred to as 1B and 1A. For more information, refer to the *Installation, User’s, and Maintenance Guide* for the expansion enclosure.

Table 24. Connecting storage enclosures at the top of the best practice cable loop scheme

Step	Storage subsystem		Storage expansion enclosure 1		Storage expansion enclosure 3 (new)	
	Controller A	Controller B	Left ESM	Right ESM	Left ESM	Right ESM
3 on page 98				IN/1A		OUT/1B
6 on page 98	Drive port x		(IN/1B)		IN/1B	
8 on page 98			IN/1B		OUT/1A	

Connecting storage enclosures at the top of a SAS drive cable loop scheme in a DS3000, DS3500, DCS3700, and DCS3700 with Performance Module Controllers configuration

For DS3000, DS3500, DCS3700, or DCS3700 with Performance Module Controllers storage subsystem configurations with an initial drive loop/channel cabling scheme that is similar to the scheme used in “Storage subsystem SAS drive channel/loop schemes for enclosures in a DS3000 or DS3500 configuration” on page 106, Table 25 on page 100 shows how you cable the ports by adding a third expansion enclosure at the top of the first and second expansion enclosures. A port enclosed by () indicates that you remove the connection as part of the step.

Note: ESM ports for EXP700, EXP710, EXP100, EXP500, EXP3000, EXP3500, and DCS3700 storage expansion enclosure are referred to as IN and OUT. ESM ports

for EXP5060, EXP5000, EXP520, EXP395, EXP810, and EXP420 expansion enclosure are referred to as 1B and 1A. For more information, refer to the *Installation, User's, and Maintenance Guide* for the expansion enclosure.

Table 25. Connecting storage enclosures at the top of a SAS drive cable loop scheme in a DS3000, DS3500, DCS3700, or DCS3700 with Performance Module Controllers configuration

Step	Storage subsystem		Storage expansion enclosure 1		Storage expansion enclosure 3 (new)	
	Controller A	Controller B	Left ESM	Right ESM	Left ESM	Right ESM
3 on page 98				OUT		IN
6 on page 98	Drive port x		(IN)		IN	
8 on page 98			IN		OUT	

Examples of connecting storage enclosures at the top of a drive loop

The following figures show examples of adding storage enclosures to the top of the drive loop/channel.

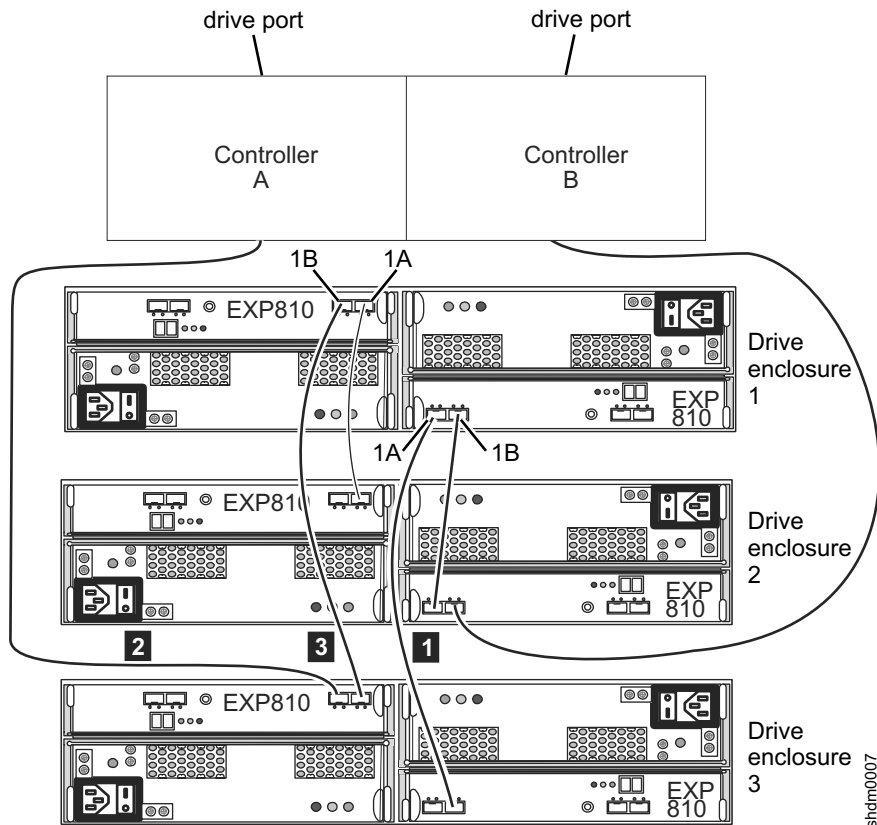

Figure 34. Cabling an additional storage enclosure to the top of the drive loop in a DS5000 storage subsystem configuration

Legend:

- 1 See step 3 on page 98.
- 2 See step 6 on page 98.
- 3 See step 8 on page 98.

Legend:

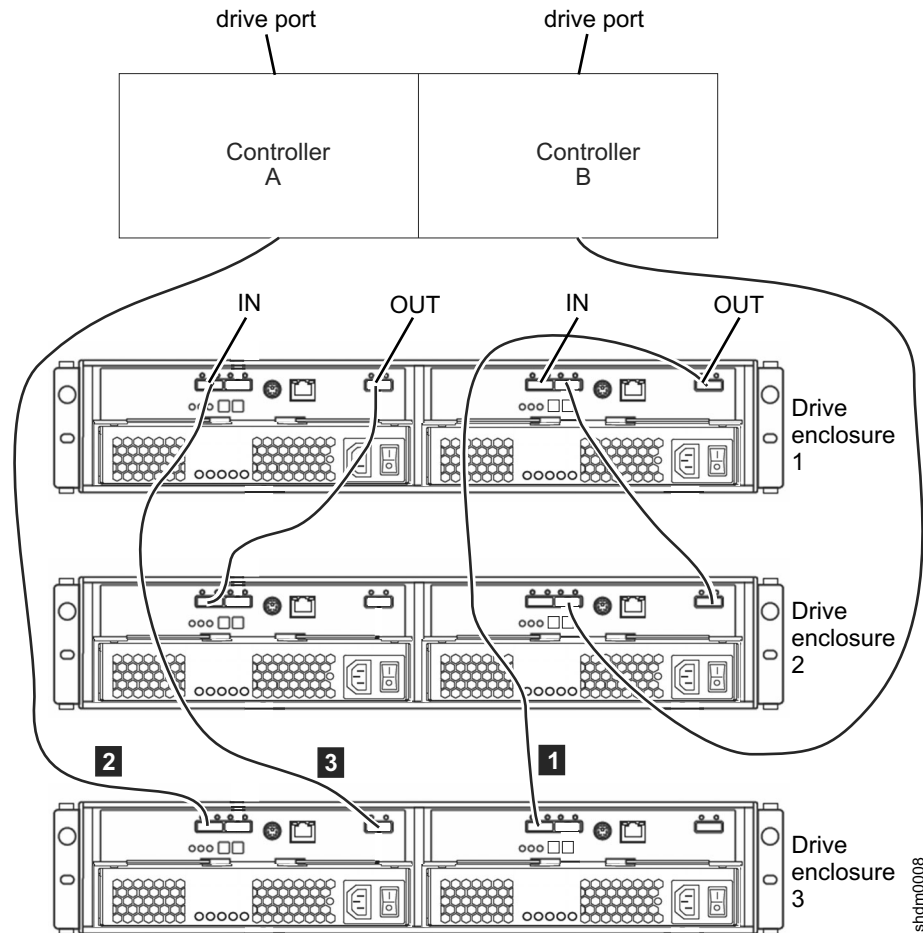

Figure 35. Cabling an additional storage enclosure to the top of the drive loop in a DS3000 storage subsystem configuration

- 1 See step 3 on page 98.
- 2 See step 6 on page 98.
- 3 See step 8 on page 98.

Returning the drive/loop channel to optimal state

To return the drive loop/channel to optimal state, complete the following steps:

1. Reseat the cable.
2. Use a new cable.
3. For a Fibre Channel port, use new SFPs or GBICs. Use the Fibre Channel loopback to verify that the SFP and the Fibre Channel ports are in optimal state.
4. Check the storage enclosure speed switch, if present.
5. Check the new storage enclosure compatibility with the existing storage enclosures.
6. Check for any special cabling requirements.

7. Perform any additional suggestions as indicated by the Recovery Guru function in the Storage Subsystem Management window.
8. If necessary, contact your IBM marketing representative or authorized reseller for assistance.
9. If the problem remains, contact IBM support for assistance.

DS4000 and DS5000 storage subsystem Fibre Channel drive loop schemes

Although various Fibre Channel cable loop schemes are supported, to avoid problems, consistently use one scheme when you connect DS4000 and DS5000 storage subsystems and storage enclosures.

Note: In addition, there are specific restrictions that you must follow when you intermix EXP100 with EXP710 and EXP810 storage enclosures in a DS4700 or DS4800 storage subsystem configuration. See “Cabling EXP100, EXP710, and EXP810 storage enclosures in DS4700 and DS4800 configurations” on page 109 for details.

Figure 36 illustrates the best practice cable loop scheme for connecting DS4000 storage subsystems and storage enclosures.



Figure 36. Best practice cable loop scheme for connecting storage devices

Legend:

- 1 Best practice cabling for EXP100, EXP500, EXP700, and EXP710 storage enclosures with DS4000 storage subsystems except when the EXP100 storage enclosure is the first storage enclosure that is directly connected to a DS4700 or DS4800 storage subsystem controller A drive port. See Figure 38 on page 104 for cabling best practices that apply to this specific case.

- 2 Best practice cabling for an EXP810 storage enclosure with a DS4000 storage subsystem or a storage enclosure with a DS5000 storage subsystem.

Important: Do not use the cable schemes illustrated in Figure 37 or Figure 40 on page 106 because they affect diagnostic capability in the event of drive loop failures.

- Do not connect more than four enclosures behind each drive channel port when you connect to a DS4200, DS4700, DS4800, DS5100, or DS5300 storage subsystem. The DS5100 and DS5300 storage subsystems support only two storage enclosures behind each drive channel port with controller firmware 7.3x.xx.xx and earlier. With controller firmware level 7.5x.xx.xx or later, the DS5100 and DS5300 storage subsystems support up to four storage enclosures behind each drive channel port.
- For a non-EXP810 storage enclosure, connect to the IN port of the ESM on the left and the OUT port of the ESM on the right.
- For an EXP810 storage enclosure, connect to port 1B on either the right or left ESM.



Figure 37. Alternative cable loop scheme for connecting storage devices

Legend:

- 1 Unsupported cabling for EXP100, EXP500, EXP700, and EXP710 storage enclosures with a DS4000 storage subsystem.
- 2 Unsupported cabling for EXP810 storage enclosures only with a DS4000 storage subsystem or storage enclosures with a DS5000 storage subsystem.



Figure 38. Alternative cable loop scheme for connecting storage devices

Legend:

- 1 Best practice cabling for the EXP100 storage enclosure with EXP710 or EXP810 storage enclosures in a DS4700 and DS4800 storage subsystem configuration only when the EXP100 storage enclosure is the first storage enclosure that is directly connected to controller A drive ports. (Unsupported for other DS4000 storage subsystems.) See “Cabling EXP100, EXP710, and EXP810 storage enclosures in DS4700 and DS4800 configurations” on page 109 for more details.
- 2 Unsupported cabling for EXP810 storage enclosure only with a DS4000 storage subsystem or storage enclosures with a DS5000 storage subsystem.

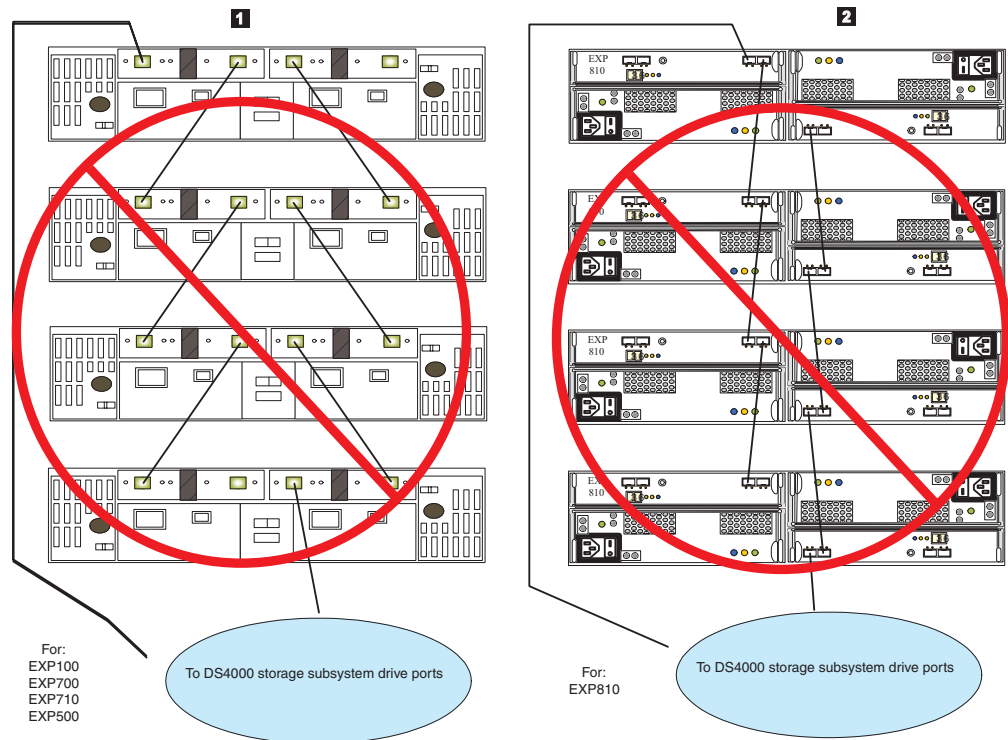

Figure 39. Unsupported cable loop scheme for connecting storage devices (1 of 2)

Legend:

- 1 Unsupported cabling for an EXP100, EXP500, EXP700, and EXP710 storage enclosure with a DS4000 storage subsystem.
- 2 Unsupported cabling for an EXP810 storage enclosure with a DS4000 storage subsystem or a storage enclosure with a DS5000 storage subsystem.

Note: The cable loop scheme in Figure 39 is unsupported because both drive loops are connected to the IN port of the EXP700 storage enclosure. Although this restriction does not specifically apply to other storage enclosures, you must avoid connecting both drive loops in the IN port to prevent accidental unsupported cabling in the EXP700 storage enclosure environment.



Figure 40. Unsupported cable loop scheme for connecting storage devices (2 of 2)

Legend:

- 1 Unsupported cabling for an EXP100, EXP500, EXP700, and EXP710 storage enclosure with a DS4000 storage subsystem.
- 2 Unsupported cabling for an EXP810 storage enclosure with a DS4000 storage subsystem or a storage enclosure with a DS5000 storage subsystem.

Note: The cable loop scheme in Figure 40 is unsupported because of the random pattern between the storage enclosures.

Storage subsystem SAS drive channel/loop schemes for enclosures in a DS3000 or DS3500 configuration

The following illustration shows the supported cabling configuration to connect a DS3000 or DS3500 storage subsystem to the storage enclosures and between the storage enclosures with SAS drive channels.

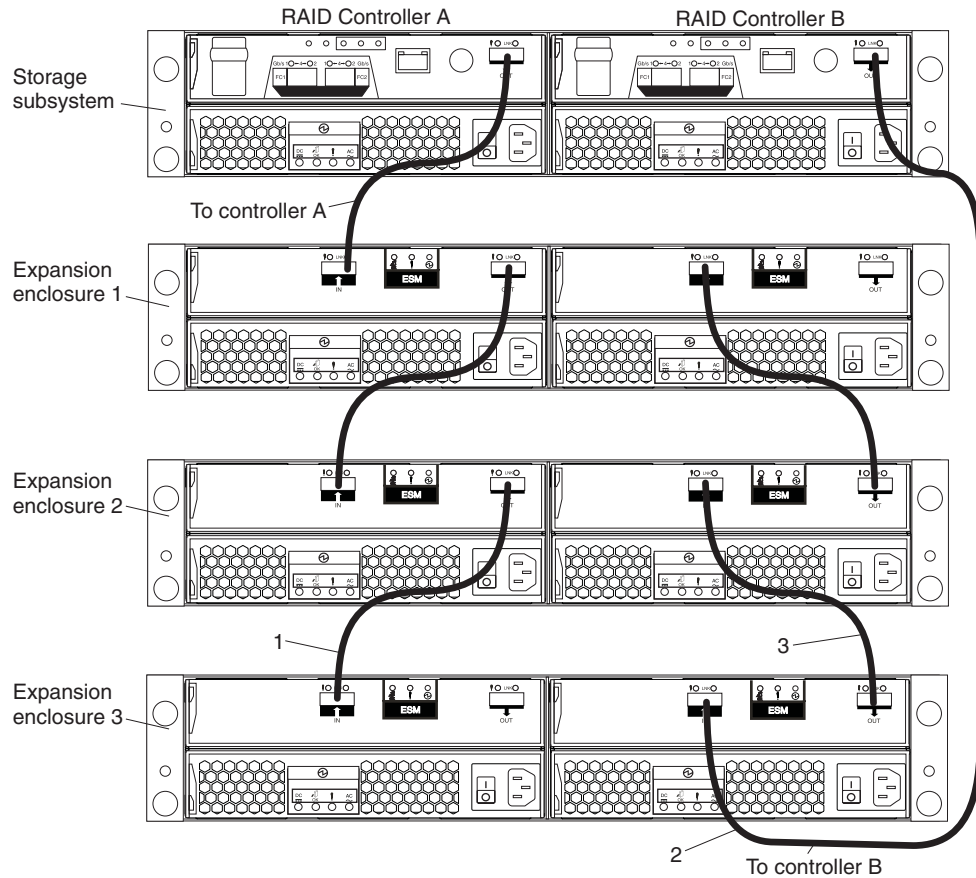

Storage subsystem SAS drive channel/loop schemes for enclosures in a DCS3700 or in a DCS3700 with Performance Module Controllers configuration

The DCS3700 storage subsystem supports up to two DCS3700 storage enclosures per physical expansion port, so multiple DCS3700 storage enclosures can be connected by chaining them together. The DCS3700 storage subsystem with Performance Module Controllers supports up to five DCS3700 storage enclosures per physical expansion port, so multiple DCS3700 storage enclosures can be connected by chaining them together.

The following illustration shows the supported cabling configuration to connect a DCS3700 storage subsystem to the storage enclosures, and between the storage enclosures with SAS drive channels. Similarly, you can connect the DCS3700 storage subsystem with Performance Module Controllers to the DCS3700 storage expansion enclosures.

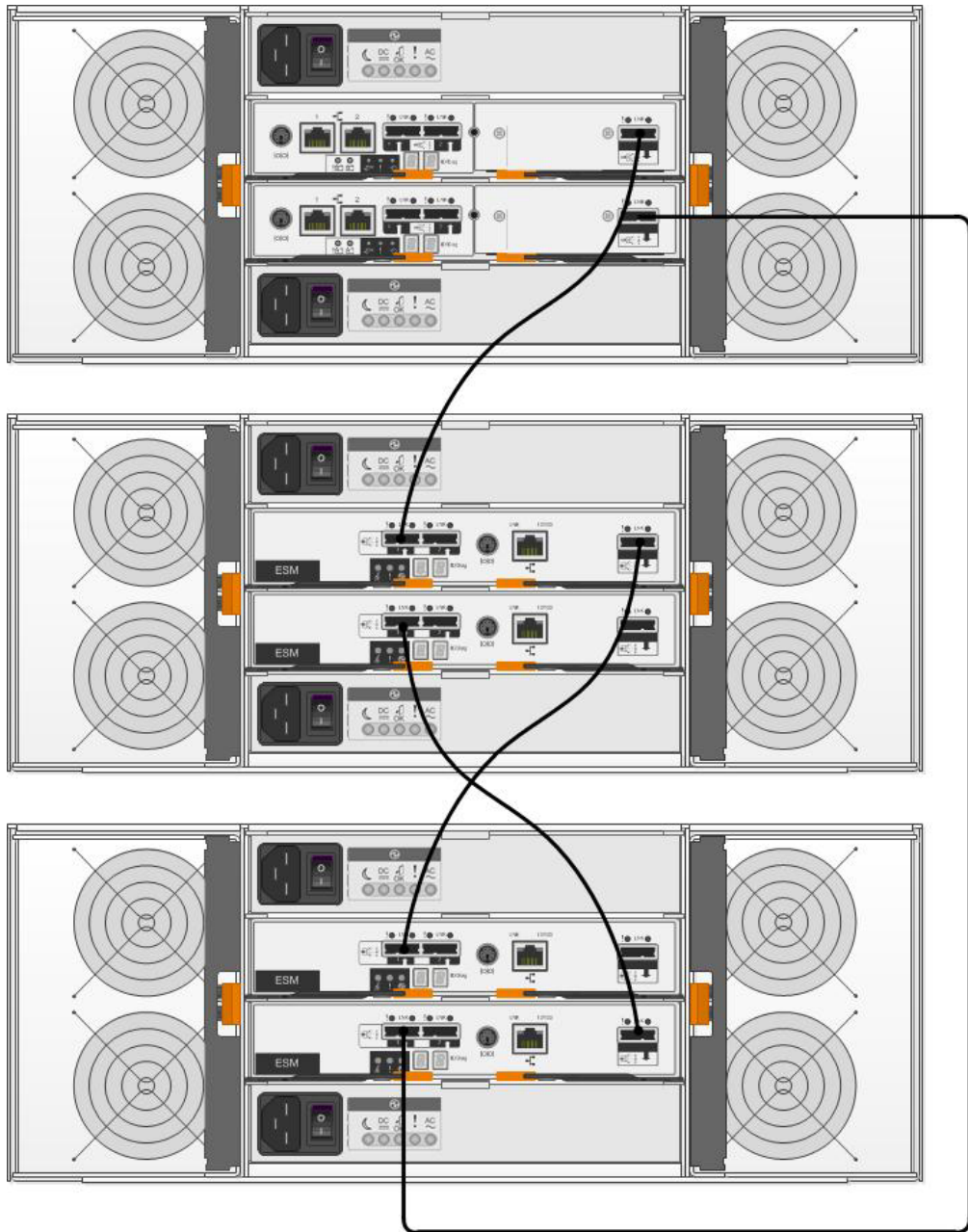

To connect the DCS3700 storage system RAID controllers A and B to multiple DCS3700 expansion enclosures, complete the following steps:

1. Connect the DCS3700 expansion enclosure to controller A:
 - a. Connect one end of a SAS cable to the drive expansion port on controller A.
 - b. Connect the other end of the SAS cable to one of the In (↑) SAS connectors on the ESM in SBB slot A in the DCS3700 expansion enclosure.
2. Connect the SAS cable of the DCS3700 expansion enclosure to the next DCS3700 expansion enclosure in the chain:
 - a. Connect one end of a SAS cable to the Out (↓) SAS connector on the ESM in SBB slot A of the DCS3700 expansion enclosure that you connected.
 - b. Connect the other end of the SAS cable to one of the In (↑) SAS connectors on the ESM in SBB slot A in the next DCS3700 expansion enclosure in the chain.

3. Connect the last DCS3700 expansion enclosure in the chain to controller B:
 - a. Connect one end of a SAS cable to the drive expansion port on controller B.
 - b. Connect the other end of the SAS cable to one of the In (↑) SAS connectors on the ESM in SBB slot B in the last DCS3700 expansion enclosures of the chain that you created.
4. In reverse order (last in chain to first in chain), connect the ESM in SBB slot B to the DCS3700 first expansion enclosure in the chain:
 - a. Connect one end of a SAS cable to the Out (↓) SAS connector on the right ESM of the DCS3700 expansion enclosure that you just connected.

For detailed information about cabling the DCS3700 storage enclosures to the DCS3700 configuration, see the *IBM System Storage DCS3700 Storage Subsystem and DCS3700 Storage Subsystem with Performance Module Controllers Installation, User's, and Maintenance Guide*.

Cabling EXP100, EXP710, and EXP810 storage enclosures in DS4700 and DS4800 configurations

When you intermix EXP100, EXP710, and EXP810 storage enclosures, if it is not possible to cable each group of enclosures by model type in a separate redundant drive loop pair or behind each port of the dual-ported redundant drive channel pair, group them so that EXP810 storage enclosures are between EXP100 and EXP710 storage enclosures.

The following notes describe information that you must consider when an EXP100 storage enclosure is the first storage enclosure that is cabled directly to the controller drive port in the storage subsystem:

- Cable from the controller drive port to the OUT port on the left ESM (ESM A) of the EXP100 storage enclosure.

Note: This is a change from previous cabling best practices in which you cabled from controller A drive port to the IN port on the left ESM (ESM A) of the EXP100 storage enclosure or any other storage enclosures as shown in the previous section.

- If an EXP100 storage enclosure follows the initial EXP100 storage enclosure, cable from the IN port on the left ESM (ESM A) of the first EXP100 storage enclosure to the OUT port on the left ESM of the next EXP100 storage enclosure. Continue this cabling pattern until you encounter an EXP710 or EXP810 storage enclosure; then, cable from the IN port on the left ESM (ESM A) of the EXP100 storage enclosure to the IN port of the EXP710 or EXP810 storage enclosure.
- If an EXP710 or EXP810 storage enclosure follows the initial EXP100 storage enclosure, cable from the IN port on the left ESM (ESM A) of the EXP100 storage enclosure to the IN port of the EXP710 or EXP810 storage enclosure. To cable to the next storage enclosure in the chain, cable from the OUT port of the left ESM of the EXP710 or EXP810 storage enclosure to the IN port of the next storage enclosure.
- Continue the left ESM (ESM A) cabling pattern by cabling from the OUT port to the IN port on subsequent storage enclosures until you complete the chain.

Figure 41 on page 110 shows a supported EXP710, EXP810, and EXP100 storage enclosure intermix configuration in a DS4700 or DS4800 storage subsystem. The cabling is supported because it follows the cabling best practices. The cabling scheme of the DS4000 storage subsystem on the right of the figure shows no change because the EXP100 storage enclosure is not directly connected as the first

storage enclosure to controller drive port A of the DS4000 storage subsystem.

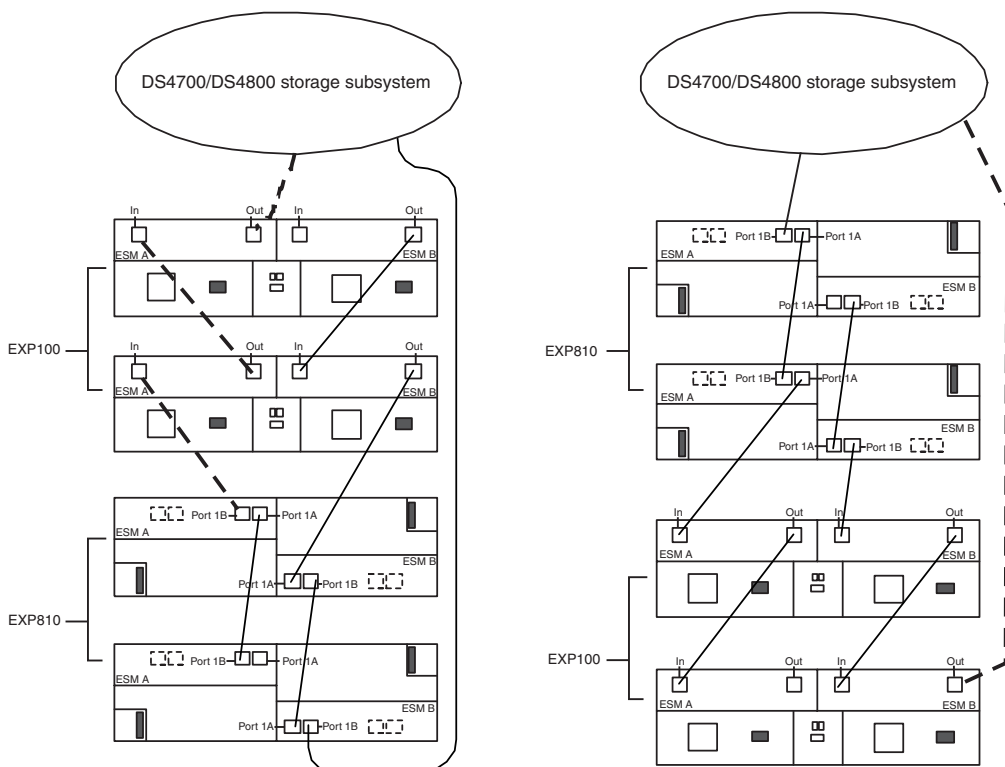

Figure 41. Supported EXP710, EXP810, and EXP100 storage enclosure intermix configuration in a DS4700 or DS4800 storage subsystem

Table 26. Description of the figure that shows supported EXP710, EXP810, and EXP100 storage enclosure intermix configuration in a DS4700 or DS4800 storage subsystem

Number	Description
1	DS4700 or DS4800 storage subsystem
2	EXP100 storage enclosure
3	EXP810 storage enclosure
4	IN port
5	OUT port
6	Port 1B
7	Port 1A

Figure 42 on page 111 shows an unsupported EXP710, EXP810, and EXP100 storage enclosure intermix configuration in a DS4700 or DS4800 storage subsystem. The cabling is unsupported because controller A is cabled to the IN port on the left ESM of the first EXP100.

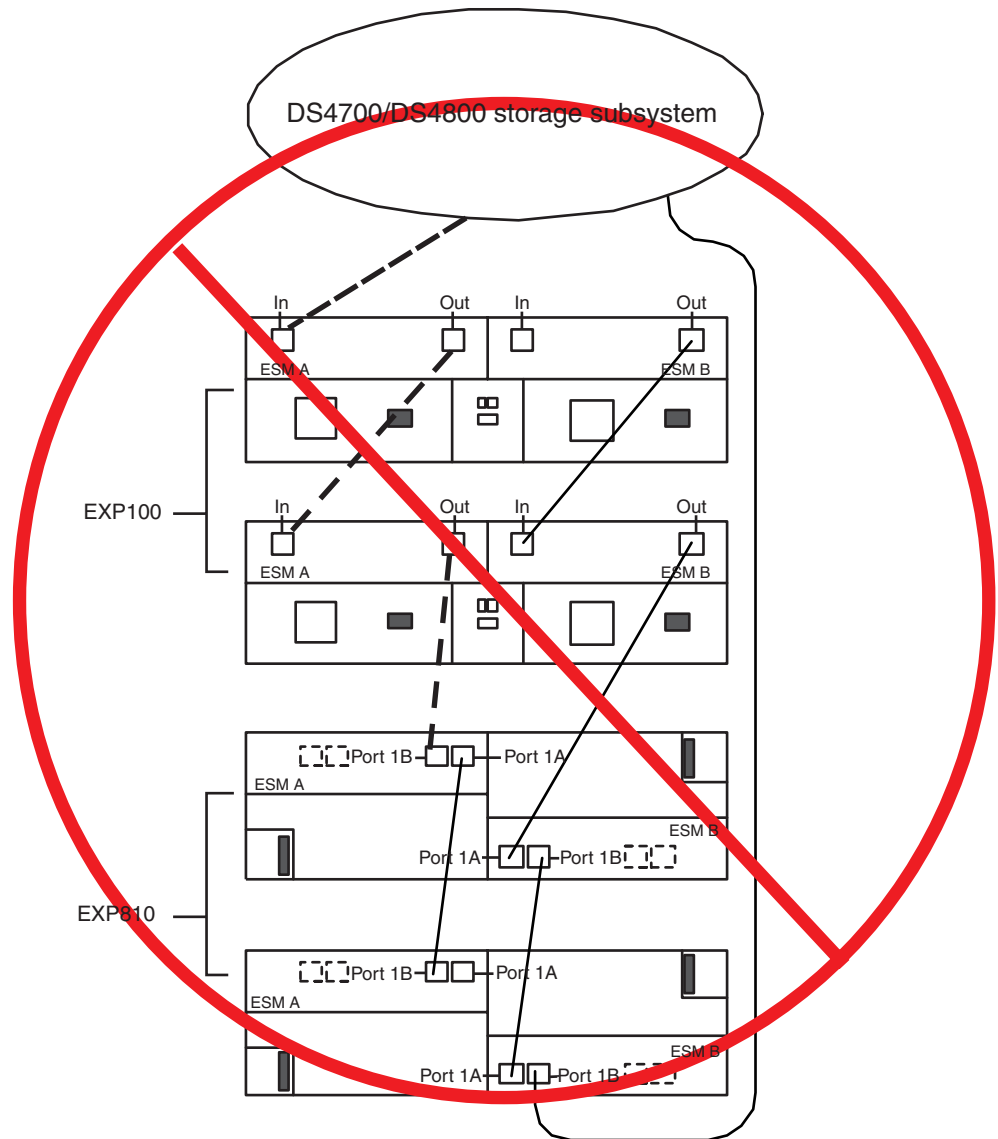

Figure 42. Unsupported EXP710, EXP810, and EXP100 storage enclosure intermix configuration in a DS4700 or DS4800 storage subsystem

Table 27. Description of the figure that shows an unsupported EXP710, EXP810, and EXP100 storage enclosure intermix configuration in a DS4700 or DS4800 storage subsystem

Number	Description
1	DS4700 or DS4800 storage subsystem
2	EXP100 storage enclosure
3	EXP810 storage enclosure
4	IN port
5	OUT port
6	Port 1B
7	Port 1A

Figure 43 shows cabling variations when EXP100, EXP710, and EXP810 storage enclosures are intermixed behind a DS4800 storage subsystem.

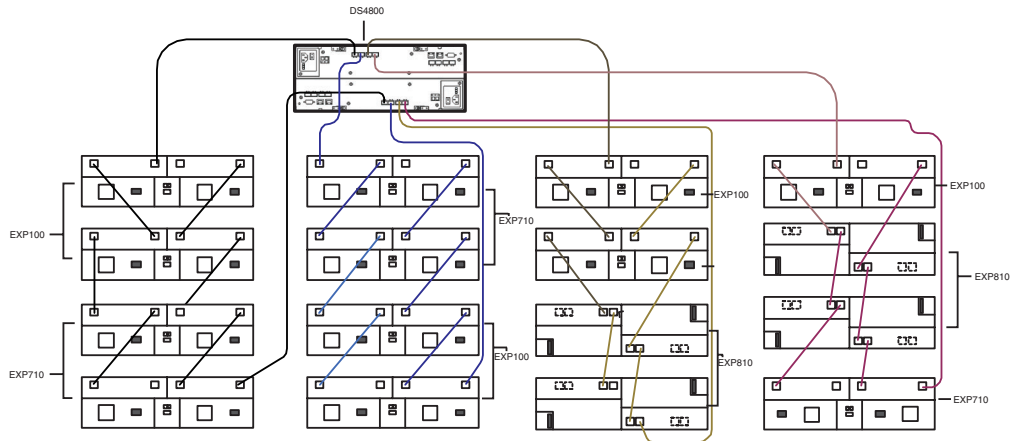

Figure 43. Cabling variations when EXP100, EXP710, and EXP810 storage enclosures are intermixed behind a DS4800 storage subsystem

Table 28. Description of the figure that shows cabling variations when EXP100, EXP710, and EXP810 storage enclosures are intermixed behind a DS4800 storage subsystem

Number	Description
1	DS4800 storage subsystem
2	EXP100 storage enclosure
3	EXP810 storage enclosure
4	EXP710 storage enclosure

Step 7: Inserting drives and cabling additional storage enclosures

Note: Complete the following procedure only if you are adding enclosures with new drives. Otherwise, go to “Step 8: Inserting hard disk drives and placing logical drives online” on page 113.

To insert drives and connect additional storage enclosures, complete the following steps:

1. Insert the applicable drives into empty drive bays in the new enclosure one at a time. Wait (up to 5 minutes) until the inserted drive fully spins up and is identified in the Storage Subsystem Management window; then, insert the next hard disk drive.
2. To connect additional storage enclosures to a drive loop pair, repeat the steps of the applicable procedure in Step 6. Do not proceed to add additional storage enclosures if you are still having problems with the modified drive loop and the newly inserted drives. This step completes the procedure to add enclosures with new drives.

Attention: Plan carefully before you add enclosures to the middle or the top of the drive loop. Cabling errors might cause loss of data availability, or loss of data.

Step 8: Inserting hard disk drives and placing logical drives online

Note: To ensure that the arrays are on the Storage Subsystem Management window, move all of the hard disk drives as independent sets when you migrate hard disk drives from multiple storage subsystems to a single storage subsystem. Ensure that each set successfully transfers before you move another set of drives.

To migrate enclosures with drives that contain logical drive configuration data, complete the following steps:



1. For each additional enclosure that you intend to migrate to the drive loop pair, perform the procedure in “Step 5: Installing and setting storage enclosure IDs and speeds” on page 83 and “Step 6: Cabling, turning on, and verifying storage enclosure operation” on page 84.

Attention: Plan carefully before you add enclosures to the middle or the top of the drive loop. Cabling errors might cause loss of data availability, or loss of data.

2. Insert the drives into the empty drive bays in the new enclosure, one at a time. Wait (up to 5 minutes) until each drive pair fully spins up and is identified in the Storage Subsystem Management window; then, insert the next hard disk drive pair.
3. The array and logical drive information is shown on the Logical/Physical view of the Storage Subsystem Management window. The storage subsystem places the array in Offline state until you insert all the drives in the array.

Note: On storage subsystems with controller firmware level 7.xx or later or Storage Manager software version 10.xx or later, arrays appear in Contingent state (with an arrow icon) until all of the drives in the array are inserted. The array appears in Exported - ready to import state.

4. If the migrated drives are FDE drives and were configured as part of a secured array, use the saved security key from the storage subsystems that these drives are migrated from to unlock the drives. Without this security key, the controllers cannot unlock the drives to retrieve the array configuration data and data on the drives.
5. Depending on the controller firmware and Storage Manager software versions of your system, complete one of the following steps:
 - With controller firmware earlier than level 7.xx and Storage Manager software earlier than version 10.xx, after you insert all of the drives, manually change the state of the arrays and logical drives that are involved from Optimal state to Online state if it is not changed automatically. To do so, right-click the array name in the Storage Subsystem Management window and click **Place -> Online**.
 - With controller firmware level 7.xx or later and Storage Manager software version 10.xx or later, after you insert all of the drives, import the array, using the Import Array function, and complete the following steps:
 - a. Click the name of the array that you want to import in the Storage Subsystem Management window.
 - b. Click **Advanced -> Maintenance -> Import Array**.
 - c. In the confirmation window, click **OK**.
 - d. Click **Import**.
 - e. In the Import Array window, type yes and click **OK**.
 - f. Click **Close**.
6. If any of the following conditions remain, contact IBM support for assistance.

- The **Empty Drive Bay** icon () is displayed for the drive bay into which you inserted the migrating drive.
- The **Failed Unconfigured Drive** icon () or the **Failed Configured Drive** icon () is displayed for the drive bay into which you inserted the migrating drive.
- Array configuration data on the drives that you added is incomplete.
- You cannot bring the array online (controller firmware level 6.xx.xx.xx and earlier) or import the array (controller firmware level 7.xx.xx.xx or later).

Attention: Do not initialize a hard disk drive that you want to keep (by right-clicking its icon and selecting **Initialize** from the pull-down menu) if it contains configuration or user data. Initializing any of the drives in a defined array causes all hard disk drives in an array to return to the Unconfigured Capacity storage pool, deleting their array definitions from the configuration. The user data on such drives is lost.

Result: When the arrays are online, they are ready for you to configure and map to host servers. You might also then re-create FlashCopy images and remote mirror relationships.

7. Use the DS Storage Manager program to view the storage partitioning definitions and make any necessary corrections.
8. The storage subsystem that the drives are migrated from displays the logical drives that are defined in these drives as missing LUNs. To remove these missing LUN entries, right-click each entry and select **Delete** from the menu.

You completed the procedure for migrating enclosures.

Chapter 4. Upgrading a storage subsystem controller

This chapter describes the procedure to replace the storage subsystem controller in a working configuration with a new storage subsystem controller of the same or different model. All the hard disk drives and storage enclosures in the original configuration are part of the new configuration. Use the procedures in this chapter only if no drives are attached to the new storage subsystem. This procedure is also referred to as controller head-swapping. If the new storage subsystem is part of a working configuration where the storage subsystem controllers are booted with at least two drives, see Chapter 3, “Adding or migrating storage enclosures,” on page 75 to migrate the drives and storage enclosures instead.

IBM support is available for controller upgrade assistance, but you must contact your IBM marketing representative or authorized reseller as first-line support. For more information, see “Getting information, help, and service,” on page 145.

Only the replacement of the controller in a single working storage subsystem configuration with another controller is supported. To consolidate the storage enclosures behind multiple controllers in multiple working storage subsystem configurations, perform the applicable controller swap procedure that is described in this chapter to upgrade one working storage subsystem configuration. Then, see Chapter 3, “Adding or migrating storage enclosures,” on page 75 for instructions for migrating the storage enclosures in the other storage subsystems into the new controller storage subsystem configuration.

A readme file is available with the latest information and instructions for each storage subsystem. To access the most recent readme file, see “Finding Storage Manager software, controller firmware, and readme files” on page 145.

Upgrade considerations

Consider the following information before you upgrade a storage subsystem.

Host attachment and premium feature entitlements

The following notes describe information about host attachment and premium feature entitlements that you must consider before you upgrade a storage subsystem.

- To enable premium features in a new or replacement configuration that were enabled in an original configuration, you must purchase the applicable entitlements for the new or replacement storage subsystem, if that premium feature is not standard in the new or replacement storage subsystem. In addition, IBM assigns host attachment kits only to specific storage subsystems. You must also purchase the applicable host attachment kits for new or replacement storage subsystems.
- After the upgrade, premium features that were previously enabled in the original storage subsystem along with the enable-by-default premium features in the new storage subsystem are automatically placed in Out of Compliance state. You must generate new premium feature SAFE keys to re-enable premium features.

Follow the instructions in the Premium Features Activation instructions that come with the Premium Feature kits to generate the premium feature keys. Also, to generate new premium feature keys, go to <http://www-912.ibm.com/PremiumFeatures/>.

Storage firmware migration

The following notes describe information about controller firmware migration that you must consider before you upgrade a storage subsystem:

- You can migrate the drives and storage enclosures in a storage subsystem to a new controller only if the firmware in the controllers of the storage subsystem and the new controller have the same major release version. Only major release versions 6.xx and 7.xx are supported.
- Before you perform a migration from an original storage subsystem controller with firmware version 6.xx to a new storage subsystem controller with firmware version 6.xx, you must upgrade the original and the new storage subsystem controller firmware to the latest version 6.xx.
- To perform a migration from an original storage subsystem controller with firmware version 7.xx to a new storage subsystem controller with firmware version 7.xx, the controller firmware version in the original controller must be the same as or earlier than the controller firmware version in the new controller. As an exception, if either the original or the new DS3500, DCS3700, or DCS3700 subsystem with Performance Module Controllers has controller firmware version 7.8x.xx.xx installed, the original and the new DS3500, DCS3700, or DCS3700 with Performance Module Controllers must be upgraded to the same version as that of the 7.8x.xx.xx controller firmware, before the head-swap. Two extra new drives might need to be purchased to bring up the new storage subsystem for controller firmware upgrading. Otherwise, the controller firmware in the new controller is placed in the Controller Lock Down state.

Complete the following steps, if the 7.xx firmware version in the new storage subsystem is earlier than the 7.xx firmware version in the original controller:

1. Purchase two additional hard disk drives.
 2. Build a configuration with the new hard disk drives and the new subsystem enclosure. You might also need to add a drive expansion enclosure if there are not any available drive slots in the new storage subsystem enclosure.
 3. Use the storage enclosure or drive migration procedures that are listed in this document to add existing enclosures or hard disk drives to the new storage subsystem configuration.
 4. After successful migration, remove the storage enclosure with which you started the new storage subsystem, if necessary.
- Before you perform a migration from an original storage subsystem controller with firmware version 6.xx or earlier to a new storage subsystem controller with firmware version 7.xx or later, you must upgrade the original storage subsystem controller firmware to version 7.xx or later. Otherwise, the controller firmware in the new controller is placed in the Controller Lock Down state.
 - Before you perform a migration from an original storage subsystem controller with firmware version 7.xx or later to a new storage subsystem controller with firmware version 6.xx or earlier, you must upgrade the new storage subsystem controller firmware to version 7.xx or later. You must purchase two additional drives and a storage enclosure to bring the new storage subsystem controller into Optimal state with drives attached before you can update the controller firmware. If the upgrade of the new storage subsystem controller firmware to version 7.xx or later is not possible, the drives that are configured in the storage

subsystem with firmware version 7.xx or later cannot be migrated into a storage subsystem with controller firmware 6.xx or earlier.

Complete the following steps, if the upgrade of the new storage subsystem controller firmware to version 7.xx or later is possible:

1. Purchase two additional hard disk drives and build a configuration with the new hard disk drives and the new subsystem enclosure. You might also need to add a drive expansion enclosure if there are not any available drive slots in the new storage subsystem enclosure.
2. Use the storage enclosure or drive migration procedures that are listed in this document to add existing enclosures or drives to the new storage subsystem configuration.
3. After successful migration, remove the storage subsystem configuration that you built in step 1, if necessary.

Note: For more information, see the “Drive migration limitations” on page 14 section.

Alternative procedure to upgrade a storage subsystem controller enclosure

There is an alternative method to upgrade a storage subsystem controller enclosure. To bring the new storage subsystem controller into an optimal state, you must obtain a minimum of two new drives and a storage expansion enclosure (if the storage subsystem controller did not have any available drive slots). Then you must migrate the drives and drive expansion enclosure from the original storage subsystem to the new storage subsystem.

To upgrade the storage subsystem controller by using this alternative method, complete the following steps:

1. Plan the upgrade. For more information, refer to step 1 on page 126.
2. Purchase two new drives and a drive expansion enclosure (if there are not any available drive slots in the new storage subsystem).
3. Prepare the new storage subsystem for the upgrade:
 - a. Unpack the new storage subsystem, and install it in a rack.
 - b. If required, unpack and connect the storage enclosure to the new storage subsystem. Install the two new drives in the drive slots.
 - c. Power on the drive expansion enclosure (if installed) and the storage subsystem.
 - d. Connect the new storage subsystem to the systems management network. Use the default IP addresses of the controllers, and record the version of the controller firmware on the new storage subsystem.

The default TCP/IP address of controller A Ethernet port 1 is 192.168.128.101. The default TCP/IP address of controller A Ethernet port 2 is 192.168.129.101. The default TCP/IP address of controller B Ethernet port 1 is 192.168.128.102. The default TCP/IP address of controller B Ethernet port 2 is 192.168.129.102.

4. Prepare the original storage subsystem for the upgrade. For more information, refer to step 3 on page 127.
5. Update the controller firmware in the new storage subsystem with the latest online version. To determine the appropriate version of firmware to be installed in the new storage subsystem, refer to Figure 44 on page 129.

- a. Perform steps 4c-4g (see 4 on page 128) and 5a or 5b and 5c (see 5 on page 131) to upgrade the controller firmware and to switch from the original to the new storage subsystem.
6. Migrate the drive and drive expansion enclosures to the new storage subsystem configuration. For more information, refer to “Migrating storage enclosures with hard disk drives that have defined logical drive configurations” on page 79.
7. Prepare the new storage subsystem for use. For more information, refer to step 6 on page 132.

Supported upgrades

The following notes describe information about the supported upgrades that you must consider before you upgrade a storage subsystem:

- Migrating from a configuration with an integrated drive/RAID controller DS4000 storage subsystem to one with the RAID controller requires only an additional storage enclosure for the drives that are installed in the integrated drive/RAID controller.
- Some storage subsystem models require that hard disk drives and storage enclosures operate at a specified Fibre Channel speed. Ensure that the hard disk drive and storage enclosures can operate at that speed before you begin the upgrade.
- As of the date of this document, IBM does not support replacement of SATA or Fibre Channel controllers with one another. Contact your IBM marketing representative or authorized reseller for information.

The following table describes the supported storage subsystem upgrades. You can submit a request for price quote (RPQ) to your IBM marketing representative or authorized reseller for upgrading scenarios of the storage subsystem that are not described in this table.

Table 29. Supported replacement storage subsystems

Storage subsystem model	Supported replacement storage subsystem models
DS3200, DS3300, DS3400	DS3200, DS3300, DS3400
DS3512	<p>DS3512 (DS3524)</p> <p>The DS3512 storage subsystem can be replaced with a DS3524 storage subsystem only if an EXP3512 storage enclosure is available to house the drives in the DS3512 storage subsystem. The DS3512 storage subsystem supports 3.5-inch drives and the DS3524 storage subsystem supports 2.5-inch drives. Also, the DS3524 storage subsystem must be purchased with the minimum number of drives for optimal operation.</p> <p>The existing storage subsystem must be upgraded to controller firmware version 7.8x.xx.xx before the drives in that storage subsystem are head-swapped to a storage subsystem with controller firmware version 7.8x.xx.xx.</p>

Table 29. Supported replacement storage subsystems (continued)

Storage subsystem model	Supported replacement storage subsystem models
DS3524	<p>DS3524 (DS3512)</p> <p>DS3524 storage subsystem can be replaced with a DS3512 storage subsystem only when you purchase an EXP3524 storage enclosure to house the drives in the DS3524 storage subsystem. The DS3524 storage subsystem supports 2.5-inch drives and the DS3512 storage subsystem supports 3.5-inch drives. In addition, the DS3512 storage subsystem must be purchased with the minimum number of drives for optimal operation.</p> <p>The existing storage subsystem must be upgraded to controller fw version 7.8x.xx.xx first before the drives in that storage subsystem can be head-swapped to a storage subsystem with controller firmware version 7.8x.xx.xx.</p>
DCS3700	<p>DCS3700, DCS3700 with Performance Module Controllers</p> <p>The existing storage subsystem must be upgraded to controller firmware version 7.8x.xx.xx before the drives in that storage subsystem are head-swapped to a storage subsystem with controller firmware version 7.8x.xx.xx.</p>
DCS3700 with Performance Module Controllers	DCS3700, DCS3700 with Performance Module Controllers
DS3950	<p>DS5020 DS3950 DS5100 DS5300</p> <p>You can migrate the EXP810 storage enclosure in a working storage subsystem configuration into a DS3950 storage subsystem configuration with purchase of the Attach EXP810 storage enclosure to DS3950 Activation option. To swap the DS3950 storage subsystem for the DS5100 or DS5300 storage subsystem, purchase additional EXP5000 storage enclosures to house the drives in the EXP395 and DS3950 storage enclosures. In addition, if the existing DS3950 storage subsystem configuration has any EXP810 storage enclosures, you can submit an RPQ to migrate these enclosures and drives to the DS5100 or DS5300 storage subsystem configuration.</p> <p>To swap the DS3950 and EXP395s for the DS5020 and EXP520s, the EXP520s must be purchased for the drives in the EXP395s that are connected to the replaced DS3950 enclosure.</p>
DS5020	<p>DS3950 DS5020 DS5100 DS5300</p> <p>You can migrate the EXP810 storage enclosure in a working storage subsystem configuration into a DS5020 storage subsystem configuration with purchase of the Attach EXP810 storage enclosure to DS5020 Activation option.</p> <p>To swap the DS5020 storage subsystem for the DS5100 or DS5300 storage subsystem, you must purchase additional EXP5000 storage enclosures to house the drives in the EXP520 and DS5020 storage enclosures. In addition, if the existing DS5020 storage subsystem configuration has any EXP810 storage enclosures, you can submit an RPQ to migrate these enclosures and drives to the DS5100 or DS5300 storage subsystem configuration.</p> <p>To swap the DS5020 and EXP520s for the DS3950 and EXP395s, the EXP395s must be purchased for the drives in the EXP520s that are connected to the replaced DS5020 enclosure.</p>

Table 29. Supported replacement storage subsystems (continued)

Storage subsystem model	Supported replacement storage subsystem models
DS5100DS5300	<p data-bbox="524 254 607 365">DS3950 DS5020 DS5100 DS5300</p> <p data-bbox="488 396 1421 485">The EXP5000 (1818-D1A) and EXP5060 storage enclosures are designed for the DS5100 and DS5300 (1818-51A and 1818-53A) storage subsystem and are the only storage enclosures that are supported behind the DS5100 and DS5300 storage subsystems.</p> <p data-bbox="488 510 1421 598">You can submit an RPQ to migrate the EXP810 storage enclosures in a working storage subsystem configuration into a DS5100 or DS5300 storage subsystem configuration.</p> <p data-bbox="488 623 1421 850">To swap the DS5100 or DS5300 storage subsystem enclosure for the DS5020 storage subsystem or the DS3950 storage subsystem, you must purchase additional EXP520 storage enclosures or EXP395 storage enclosures to house the drives in the EXP5000 storage enclosures. In addition, if the existing DS5100 or DS5300 storage subsystem configuration has any EXP810 storage enclosures, these enclosures and drives can also be migrated to the DS5020 storage subsystem or DS3950 storage subsystem configuration with the purchase of the Attach EXP810 storage enclosure to DS5020 or DS3950 Activation option.</p> <p data-bbox="488 875 1421 1251">If the existing DS5100 or DS5300 storage subsystem configuration has any EXP5060 storage enclosures, these enclosures and drives cannot be migrated to the new DS5020 storage subsystem configuration. No storage enclosures are compatible with the DS5020 storage subsystems that can be used to house the drives from the EXP5060 storage enclosures. Similarly, you cannot migrate SDD or FDE drives from a DS5100 or DS5300 storage subsystem configuration to a DS3950 storage subsystem configuration. Additionally, you can only migrate SSD or FDE drives from a DS5100 or DS5300 storage subsystem configuration to a DS5020 storage subsystem configuration. You also need to purchase additional premium feature keys (such as the FDE premium feature key) to support the migration of FDE drives from a DS5100 or DS5300 storage subsystem. A fully configured DS5100 or DS5300 storage subsystem requires multiple DS5020 or DS3950 subsystems in order to migrate all of the drives in the configuration.</p> <p data-bbox="488 1276 1421 1306">The DS5020 and DS3950 storage subsystem requires firmware level 7.60.xx.xx or later.</p>

Table 29. Supported replacement storage subsystems (continued)

Storage subsystem model	Supported replacement storage subsystem models
DS4700 Express/DS4800	<p>DS4300 base model DS4300 with turbo option DS4400 DS4500 DS4700 Express DS4800 DS5020 DS5100 DS5300</p> <p>Migration to a DS4300, DS4400, and DS4500 storage subsystems requires that the drive enclosures be operating at 2-Gbps Fibre Channel speed.</p> <p>The DS4800 and DS4700 Express storage subsystems do not support EXP700 (or EXP500) storage enclosures. The EXP700 storage enclosures must be upgraded to EXP710 storage enclosures in the existing DS4000 storage subsystem configuration before you migrate it to the DS4700 Express or DS4800 storage subsystem. (Because of limited parts inventory as of the date of this document, no upgrade is available for an EXP700 to EXP710 storage enclosure upgrade. An RPQ approval is required for the EXP700 storage enclosure to be supported at the 06.60.xx.xx code level.)</p> <p>You cannot replace a DS4800 or a DS4700 Express storage subsystem with a DS4400 storage subsystem, if the existing DS4800 storage subsystem configuration has EXP810 storage enclosures in the drive channels.</p> <p>Migrating more than six EXP710 storage enclosures to a DS4700 Express subsystem requires two DS4700 Express storage subsystems; a maximum of six EXP710 storage enclosures can be attached to a DS4700 Express storage subsystem.</p> <p>If a DS5000 (DS5020/DS5100/DS5300) storage subsystem is used to replace a DS4000 storage subsystem with controller firmware level 6.xx, you must upgrade the DS4000 storage subsystem controller firmware to version 7.xx.xx.xx first. For more information about storage subsystem and storage enclosure compatibility, see Table 9 on page 24. For information about controller firmware compatibility, see Table 2 on page 9.</p> <p>The DS5020 storage subsystem requires controller firmware level 7.60.xx.xx or later. The DS5100 or DS5300 storage subsystem requires controller firmware level 7.30.xx or later.</p> <p>Migration to a DS4300 storage subsystem configuration from a DS4400, DS4500, or DS4800 storage subsystem configuration with more than eight storage enclosures requires more than one DS4300 storage subsystem. See Table 1 on page 4.</p> <p>The DS4300 turbo and DS4500 storage subsystem requires controller firmware level 6.19.xx.xx or later to support the EXP810 storage enclosure attachment.</p> <p>The DS4400 storage subsystem does not support the EXP810 storage enclosures. Migration to the DS4300, DS4400, and DS4500 storage subsystems require the DS4700 and DS4800 controller firmware version 6.xx.</p> <p>Existing EXP810 storage enclosures can be migrated from currently installed DS4700 or DS4800 storage subsystems to attach to a DS5000 storage subsystem through the RPQ process.</p>
DS4200 Express	DS4200 Express

Table 29. Supported replacement storage subsystems (continued)

Storage subsystem model	Supported replacement storage subsystem models
DS4400DS4500	<p>DS4300 base model DS4300 with turbo option DS4400 DS4500 DS4700 Express DS4800</p> <p>Migration to a DS4300 storage subsystem configuration from a DS4400, DS4500, or DS4800 storage subsystem configuration with more than eight storage enclosures requires more than one DS4300 storage subsystem. See Table 1 on page 4.</p> <p>The DS4800 and DS4700 Express storage subsystems do not support EXP700 or EXP500 storage enclosures. The EXP700 storage enclosures must be upgraded to EXP710 storage enclosures in the existing DS4000 storage subsystem configuration before you migrate it to the DS4700 Express or DS4800 storage subsystem. Because of limited parts inventory as of the date of this document, no upgrade is available for an EXP700 to EXP710 storage enclosure upgrade. An RPQ approval is required for the EXP700 storage enclosure to be supported with firmware version 6.60.</p> <p>Migration to a DS4700 Express or DS4800 storage subsystems require that the DS4700 or DS4800 storage subsystem contain firmware version 6.xx.</p> <p>The DS4300 and DS4500 storage subsystem requires controller firmware level 6.19.xx.xx or later to support the EXP810 storage enclosure.</p>
DS4300 base model (dual controller base model)DS4300 turbo (dual controller model with turbo option)	<p>DS4300 base model DS4300 with turbo option DS4400 DS4500 DS4700 Express DS4800</p> <p>DS4300 base model and DS4300 with turbo option storage subsystem configurations do not accommodate EXP500 storage enclosures. Do not migrate the EXP500 storage enclosures in DS4400 or DS4500 storage subsystem configurations to DS4300 base model and DS4300 with turbo option storage subsystem configurations.</p> <p>Migration to the DS4700 Express and DS4800 storage subsystems requires that the DS4700 and DS4800 contain firmware version 6.xx.xx.xx.</p> <p>The DS4300 and DS4500 storage subsystem requires controller firmware level 6.19.xx.xx or later to support the EXP810 storage enclosure.</p>
DS4300 single controller	<p>DS4300 single controller DS4300 base DS4300 with turbo option</p>

Table 29. Supported replacement storage subsystems (continued)

Storage subsystem model	Supported replacement storage subsystem models
DS4100 base	<p>DS4100 base DS4500 DS4700 Express DS4800</p> <p>For the DS4100 base storage subsystem, you must run the following SMclient command to enable dual controller (duplex) operation: set storageSubsystem redundancyMode=duplex;</p> <p>See the online help for information about how to run SMclient commands.</p> <p>For the DS4800 base storage subsystem, the required firmware is version 06.15.2x.xx, and there must not be an attached EXP810 storage enclosure.</p> <p>For the DS4500, DS4700 Express, and DS4800 storage subsystems, the Fibre Channel/SATA intermix premium feature might be required. Additionally, EXP100 storage enclosures must be used to migrate the drives in the DS4100 bays.</p> <p>Migration to the DS4700 Express and DS4800 storage subsystems requires that the DS4700 and DS4800 contain firmware version 6.xx.xx.xx.</p> <p>The DS4500 storage subsystem requires controller firmware level 6.19.xx.xx or later to support the EXP810 storage enclosure.</p>
DS4100 single controller	<p>DS4100 single controller DS4100 base</p> <p>For the DS4100 base storage subsystem, you must run the following SMclient command to enable dual controller (duplex) operation: set storageSubsystem redundancyMode=duplex;</p> <p>See the online help for information about how to run SMclient commands.</p>

Configuration behavior after an upgrade and storage subsystem replacement

The following notes describe the identifier and premium feature behavior after an upgrade and storage subsystem replacement:

- Worldwide name (WWN):

The worldwide names that the original storage subsystem uses before the upgrade are not returned when the upgrade is complete. Instead, the new storage subsystem is identified by WWNs that are based on a new embedded unique identifier.

See your application documentation, device-driver user guide, or related documentation for detailed instructions for updating the WWN of the storage subsystem in the application or device driver. Additionally, to review the readme file and the related *IBM System Storage DS Storage Manager Installation and Support Guide* for information about any preparation tasks or operating-system-specific restrictions, go to <http://www.ibm.com/systems/support/storage/disk/>.

- Controller IP addresses:

When the storage subsystem controllers are assigned static IP addresses, the IP addresses are stored in the controller NVSRAM and in the DACstore on the hard disk drives. If the replacement storage subsystem controllers are assigned the same IP addresses as the original storage subsystem controllers, the two

devices have duplicate IP address in the Ethernet network, if the original storage subsystem controller is deployed. Best practice is to assign new unique IP addresses to replacement storage subsystem controllers.

- Storage array identifier (SAI or SA identifier):

The storage array identifier, or SA identifier, is the identifier that the DS Storage Manager host software (SMclient) uses to uniquely identify managed storage subsystems. The new storage subsystem continues to use the SA identifier of the original DS4000 storage subsystem. This ID is displayed in the storage subsystem profile as the storage subsystem worldwide identifier (ID). See Table 30 on page 125.

Table 30. Snapshot of profile information that identifies the storage subsystem worldwide identifier (ID)

```

PROFILE FOR STORAGE SUBSYSTEM: DS5K (2/26/09 6:16:43 PM)

SUMMARY-----

Number of controllers: 2

High performance tier controllers: Enabled

RAID 6: Enabled

... ..

Number of drives:          2
Mixed drive types:        Enabled
Current drive type(s):    Fibre/Full Disk Encryption(FDE) (2)
Total hot spare drives:   0
    Standby:               0
    In use:                 0

Drive Security: Enabled
Security key identifier: 27000000600A0B80004777A40000717049A6B239

... ..

Current configuration
  Firmware version:          07.50.04.00
  NVSRAM version:           N1818D53R1050V07
  EMW version:              10.50.G5.09
  AMW version:              10.50.G5.09
Pending configuration  Staged firmware download supported:  Yes
  Firmware version:         None
  NVSRAM version:          None
  Transferred on:          None
Controller enclosure audible alarm:  Disabled

NVSRAM configured for batteries:      Yes

Start cache flushing at (in percentage):  80
Stop cache flushing at (in percentage):   80
Cache block size (in KB):                8

Media scan frequency (in days): 30

Failover alert delay (in minutes): 5

Feature enable identifier: 39313435332039313535362049A6AFD8

Feature pack: DS5300
Feature pack submodel ID: 93

Storage subsystem world-wide identifier (ID): 600A0B80004776C20000000049A6BD08

```

- SAFE premium feature identifier (SAFE ID) and premium feature enable status:

The new storage subsystem retains the SAFE ID of the original storage subsystem. It also retains all of the features that were previously enabled on the original storage subsystem. However, the features are set to Out of Compliance state. As a result, the system sends alert notices and establishes a Needs Attention condition. Also, any features that are marked in the NVSRAM for automatic enablement in the new controller are enabled, although their feature states are also set to Out of Compliance state. You must re-enable the premium features with the premium feature SAFE key files. Also, to generate new SAFE keys, go to <https://www-912.ibm.com/PremiumFeatures/jsp/keyPrereq.jsp>.

Because IBM assigns premium feature entitlements only to specific storage subsystems, you must purchase the applicable entitlements for the new storage subsystem to enable all of the premium features that were previously enabled on the original storage subsystem. This SAFE ID is shown in the storage subsystem profile as a feature enable identifier. See Table 30 on page 125.

Storage subsystem behavior when turning on the power with no drives attached

The storage subsystem controllers use the metadata (DACstor) that is stored on the hard disk drives to synchronize. When the controllers are started with no hard disk drives attached, they are in a *split brain* condition. For controllers with firmware version 6.xx, the storage subsystem is shown on the Enterprise Management window with two entities: one for controller A and one for controller B. For controllers with firmware version 7.xx, the storage subsystem is shown on the Enterprise Management window as a single entity. However, if the firmware on the storage subsystem controller is version 7.xx or later, the controller firmware cannot be upgraded when the controller boots with no hard disk drives. To upgrade the controller, obtain two new hard disk drives to bring the storage subsystems into Optimal state with hard disk drives attached (you do not need to upgrade the controller firmware in all cases).

If the controllers contain firmware version 6.xx and you plan to upgrade them with another version of controller firmware version 6.xx, open a Subsystem Management window for both entities and perform firmware upgrades on both entities.

Performing an upgrade

To upgrade a storage subsystem in a configuration, complete the following steps.

Note:

1. See “Performing an upgrade from a DS4700 or DS4800 storage subsystem to a DS5000 storage subsystem” on page 134 for instructions for upgrading from a DS4700 or DS4800 to a DS5000 storage subsystem.
2. Ensure that the data in the existing configuration is backed up in a secure place before you start the upgrade procedure.
3. For more information about performing an upgrade, see “Upgrade considerations” on page 115.

1. Planning the upgrade.

To plan the upgrade, complete the following steps:

- a. See “Supported upgrades” on page 118 to determine whether the new storage subsystem controller is a supported replacement for the original

storage subsystem controller. However, you must submit a request for price quote (RPQ) if the new storage subsystem controller model is not a supported replacement.

- b. Purchase the premium feature entitlements that are enabled in the original storage subsystem for the new storage subsystem, if that premium feature is not standard in the new storage subsystem.
- c. Purchase the host attachment entitlement kits for the new storage subsystem.
- d. Purchase additional storage enclosures, if the original storage subsystem integrates the drives and controllers and the new storage subsystem model contains the controllers only.
- e. Lay out the storage enclosure cabling to the new storage subsystem, if the cabling is different from that of the original storage subsystem. See the *Installation, User's and Maintenance Guide* for your storage subsystem for information about the storage enclosure cabling rules.
- f. Purchase any additional hardware that is required to cable the existing storage enclosures to the new storage subsystem by using the storage enclosure cabling layout as a guide.
- g. Ensure that the original subsystem is in Optimal state. For more information, see "Bringing storage subsystems and drive loops into optimal state" on page 21 and the Recovery Guru in the DS Storage Manager Subsystem Management window.
- h. Perform a full backup of the original storage subsystem and schedule it for downtime.
- i. Retrieve the proofs of purchase for both the original and new storage subsystems and for any additional premium feature entitlements on the new and original storage subsystems.
- j. If there are any switch zoning definitions or applications that rely on the storage subsystem worldwide names, plan to update them to use the new storage subsystem worldwide names after the migration to the new storage subsystem is complete.

2. Preparing the new storage subsystem.

To prepare the new storage subsystem for the upgrade, complete the following steps:

- a. Unpack the new storage subsystem and install it in a rack. Do not connect it to the storage enclosures that are attached to the original storage subsystem.
- b. Connect the new storage subsystem to the systems-management network by using the default IP addresses of the controllers, and record the version of the controller firmware on the new storage subsystem.

The default TCP/IP address of controller A Ethernet port 1 is 192.168.128.101 and the default TCP/IP address of controller A Ethernet port 2 is 192.168.129.101. The default TCP/IP address of controller B Ethernet port 1 is 192.168.128.102 and the default TCP/IP address of controller B Ethernet port 2 is 192.168.129.102.

3. Preparing the original storage subsystem.

To prepare the original storage subsystem for the upgrade, complete the following steps:

- a. If any long-running tasks are processing in the original storage subsystem, ensure that they complete processing. Examples of long-running tasks are:
 - Dynamic logical drive capacity expansion
 - Dynamic logical drive expansion (DVE)

- Dynamic capacity expansion (DCE)
 - Logical drive segment size modification
 - Array RAID-level modification
 - User-initiated array redundancy checking (on the Storage Subsystem Management window, click **Array** -> **Check Redundancy**)
 - Remote mirror logical drive synchronization FlashCopy image or VolumeCopy image logical drive creation
 - Logical drive reconstruction or copyback
- b. Save the storage subsystem profile in a safe location and not on the logical drives that are mapped from the original storage subsystem.
 - c. Record the version of the controller firmware that is on the storage subsystem.
 - d. Collect all support data of the original storage subsystem.
 - e. In the host servers, stop all programs, services, and processes that access the logical drives that are defined in the migrated hard disk drives. Also, ensure that no programs, services, or processes that write data to the logical drives are running in the background.
 - f. Unmount the file systems to flush I/O from the server cache to disks.

Note:

- 1) If you are using a Windows operating system, remove the drive letter or the mount points of the drive-to-LUN map definitions, instead of unmounting the file systems.
 - 2) See your operating-system documentation for information about the file system unmount procedure.
- g. If the original subsystem contains FDE drives that were configured as part of a secured array, save the storage subsystem security (lock) key to unlock the drives. Without this key, the controllers cannot unlock the security-enabled FDE drives. Save the key in a safe location and not on the logical drives that are mapped from the original storage subsystem. Use the **Validate Security key** menu function in the storage manager subsystem to validate the saved security key file and associated pass-phrase. The storage subsystem security (lock) key must be saved with both local or external FDE key management policies.
 - h. Perform an incremental backup of the data that was changed since the full backup that you performed in step 1h on page 127.
 - i. Ensure that the environmental service modules (ESMs) and hard disk drives in the original storage subsystem are updated to the latest firmware version. To download the latest firmware version, go to <http://www.ibm.com/systems/support/storage/disk/>.
4. **Upgrading the controller firmware.**
- To upgrade the controller firmware, complete the following steps:
- a. Use the following flowcharts to determine the firmware version that is required in the new storage subsystem. To download the latest firmware level, go to <http://www.ibm.com/systems/support/storage/disk/>.

Note: The controller firmware is normally listed as either *xx.yy.zz.aa* or *xxyyzzaa*, where *xx.yy* or *xxyy* is the controller firmware version used for compatibility checking. If the first *x* is 0, it might not be identified. For example, 07.36.14.01 is the same as 7.36.14.01. The firmware version that is

used for compatibility checking in this example is 7.36.

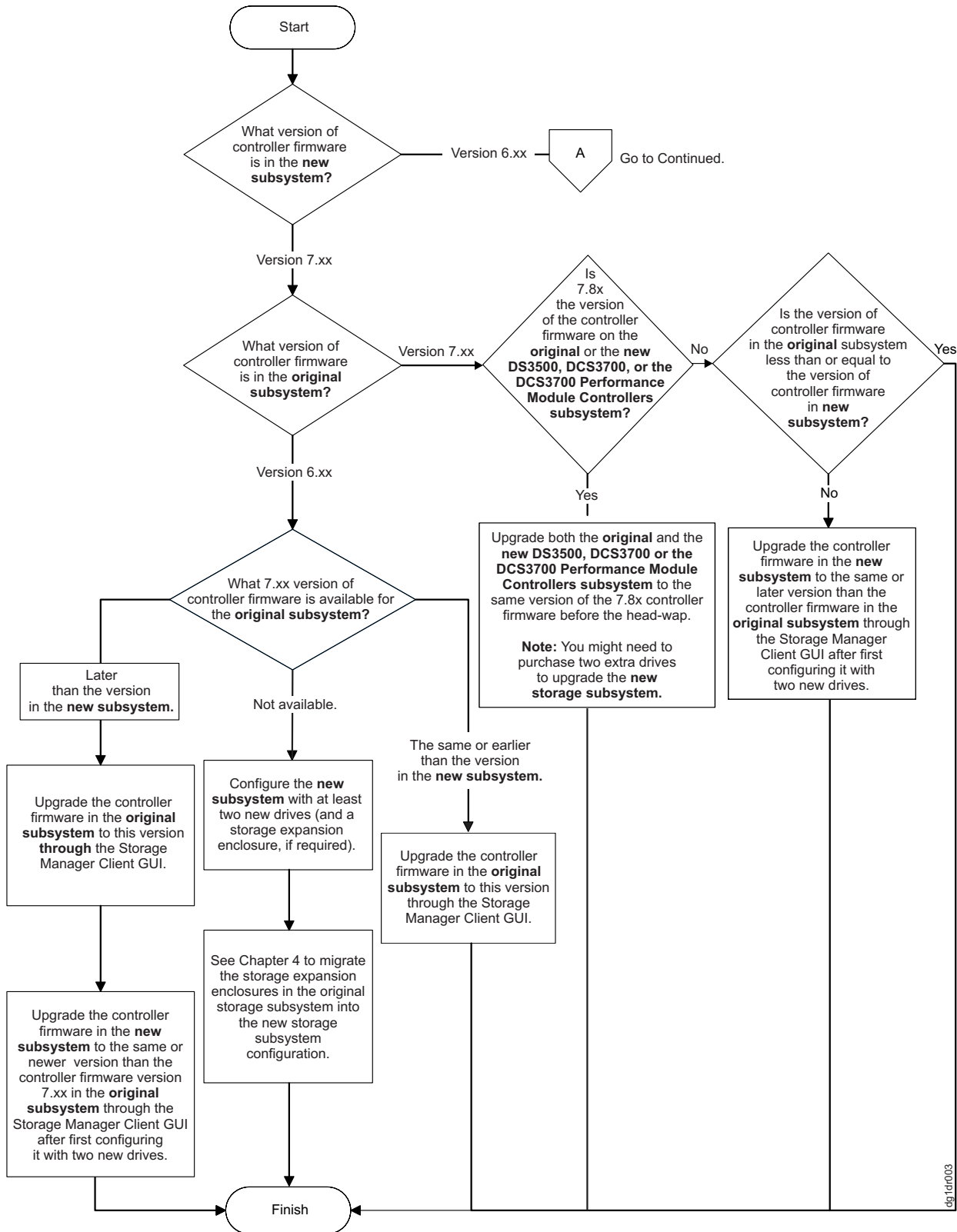

Figure 44. Firmware compatibility flowchart for a storage subsystem upgrade

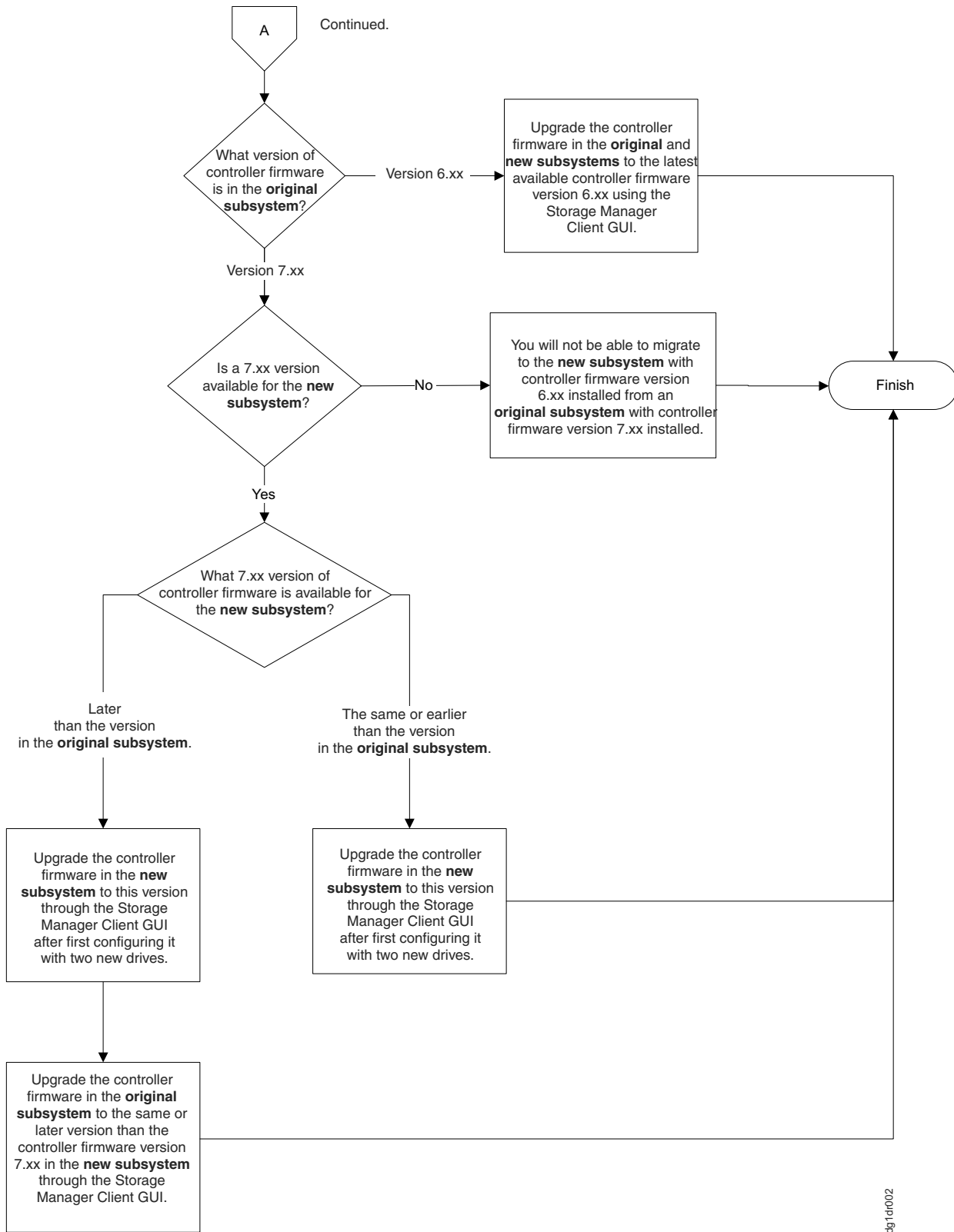

Figure 45. Firmware compatibility flowchart for a storage subsystem upgrade (continued)

- b. If you configured the new storage subsystem with at least two new drives to get the storage subsystem into Optimal state for updating the controller firmware, perform one of the following tasks:

- Leave the new storage subsystem configuration as is. Perform steps 4c-4g, 5a or 5b, and 5c-5e to prepare the original subsystem configuration for drive and drive enclosure migration and to turn off power of the original storage subsystem. Use the procedure in Chapter 3, “Adding or migrating storage enclosures,” on page 75 to migrate the drives and storage enclosures in the original storage subsystem into the new storage subsystem configuration. After you migrate all of the drives and storage expansion enclosures to the new storage subsystem configuration, perform the appropriate steps in step 6 on page 132 to prepare the new storage subsystem for use.
 - Turn off the power to the new storage subsystem controller and remove the two drives (along with the additional storage enclosure, if attached). Continue with step 4c to replace the controller in the original storage subsystem with the new controller.
- c. Save the full configuration of the original storage subsystem into an SMcli script file. Be sure to select the check boxes for storage subsystem settings, logical drive configurations, logical drive-to-LUN map definitions, and topology before you proceed with the configuration save. Ensure that the location that you are saving to is not any of the logical drives that are mapped from the original storage subsystem.
 - d. Delete any FlashCopy images of the logical drives.
 - e. Delete any VolumeCopy logical drive pairs.
 - f. Delete any remote mirror relationships.
 - g. Delete any hosttoLUN mapping definitions in the original storage subsystem.

5. **Switching from the original to the new storage subsystem.**

To switch from the original to the new storage subsystem, complete the following steps:

- a. If the controller firmware that is currently installed is version 7.xx, perform one of the following tasks to export arrays, depending on the availability of hot-spare drives and unconfigured drives in the storage subsystem:
 - If hot-spare drives or unconfigured hard disk drives are installed in the original storage subsystem, export all of the defined arrays.
 - If no hot-spare drives or unconfigured hard disk drives are installed in the original storage subsystem, keep one array on the original storage subsystem and export all the other arrays. One array must be in Optimal state for the storage subsystem to be up and running.

Note: An error occurs if you try to export the last defined array in a storage subsystem configuration and no hot-spare drives or unconfigured drives are installed.

To export an array by using the Storage Subsystem Management window, right-click the name of the array and click **Advanced -> Maintenance -> Export Array**, and follow the instructions in the pop-up window. You can also use the **Start Array *array name* Export** command in the IBM Storage Manager Client script window. The DS3000 storage subsystem supports these array functions through the SMcli interface. See the Storage Manager online help for the SMcli command syntax.

- b. If the controller firmware that is currently installed is version 6.xx, place all the arrays into Offline state. To change an array to Offline state by using the Storage Subsystem Management window, right-click the name of the array

and click **Place -> Offline**. The DS3000 storage subsystem supports these array functions through the SMcli interface. See the Storage Manager online help for the SMcli command syntax.

- c. Turn off the power to the original controller first; then, turn off the power to the storage enclosures. This is the best practice power-off sequence. See the documentation that comes with the storage subsystem for details on the power-off sequence.

Note: The storage subsystem controller must be powered off before the storage enclosure.

- d. Label all the cables that are connected to the original storage subsystem enclosure.
- e. Wait until the LEDs on the storage subsystem chassis are off; then, disconnect all cables from the storage subsystem chassis.
- f. Remove the original storage subsystem enclosure from the rack.
- g. Install the new storage subsystem enclosure in the rack, if you did not do so in step 2a on page 127.

Note: See the documentation that comes with the storage subsystem for rack installation instructions.

- h. If the original storage subsystem is an integrated drive and controller model and the new storage subsystem model contains the controllers only, install any additional storage enclosures in the new storage subsystem and move the drives from the original storage subsystem to the storage enclosure.

Note: If there are enough empty drive bays in the existing storage enclosures, you can move the drives in the original integrated drive-controller enclosure to the empty drive bays.

- i. Insert the SFPs or GBICs into the new storage subsystem drive loop/channel port bays, and cable the storage enclosures to the new storage subsystem, using the cabling layout that you defined in step 1e on page 127.

Note: The IBM service technician who performs the upgrade does not recable the storage enclosures to meet the DS5000 storage subsystem cabling requirement or run new Fibre Channel connections. This is the responsibility of the customer. The IBM service technician makes only host and drive channel connections to the storage subsystem.

- j. Insert the SFPs or GBICs into the new storage subsystem host port bays, and cable the host interface ports and the storage subsystem management ports of the new storage subsystem enclosure.
 - k. Ensure that all of the storage enclosures are set to the same speed for each drive channel/loop.
6. **Preparing the new storage subsystem for use.**

To prepare the new storage subsystem for use, complete the following steps:

- a. If the controller TCP/IP addresses are assigned by using DHCP, update the DHCP records with the new controller Ethernet port MAC addresses.

Note: The controllers first check for a DHCP server during the boot process. If the controllers do not detect a DHCP server, they use either the static IP address (if defined) or the default IP addresses. For more information about changing the controller IP addresses, see the *IBM System Storage DS Storage Manager Installation and Support Guide*. For updated documentation, go to <http://www.ibm.com/systems/support/storage/disk/>.

- b. If necessary, turn off the power to the storage enclosures. Do not turn off the power to the new storage subsystem controller. Check the storage enclosure LEDs to ensure that the storage enclosures are connected properly.
- c. Turn off the power to the new storage subsystem controller.

Note: If the TCP/IP addresses of the Ethernet management ports are statically defined for the original storage subsystem controllers, the TCP/IP addresses are used for the same Ethernet management ports in the new controllers. However, if all of the drives in the original storage subsystem are secured FDE drives, the controllers are not able to read the configuration data in the hard disk drives until they are unlocked. The statically defined TCP/IP addresses that are stored in the hard disk drives are not available until they are unlocked.

- d. Connect the new storage subsystem to the IBM DS Storage Manager Client either through the out-of-band method by using the applicable TCP/IP addresses of the controller Ethernet management ports, or through the in-band method through Fibre Channel connections.

Note: The new storage subsystem identifies itself as the machine type that it replaced until you download the applicable NVSRAM firmware for the new storage subsystem.



- e. If there are FDE drives that were configured as part of a secured array, use the security key backup file to unlock the secured (locked) FDE drives.

Note: If all of the drives in the original storage subsystem are security enabled FDE drives (FDE drives that were defined as part of secured arrays), both controllers are booted to No Drives Found state. This is because the controllers cannot unlock the drives without the applicable security key. When the security enabled FDE drives are unlocked, both controllers are rebooted so that the controllers can read the configuration data that is stored in the drives.

If all the FDE drives are from storage subsystems that operate in external license key management mode, use the security key file you saved (see step 3g on page 128) to unlock the secured FDE drives.

- f. Ensure that the new storage subsystem configuration is in Optimal state and that all of the drives are identified. Use the Recovery Guru in the DS Storage Manager Client Subsystem Management window to resolve any Needs Attention conditions.
- g. Update the controller firmware of the new storage subsystem to the latest available version, if required.
- h. Download the applicable NVSRAM firmware for the new storage subsystem.
- i. Perform one of the following tasks:
 - If the new storage subsystem controller firmware version is 7.xx, import all of the arrays that you exported in step 5a on page 131. Ensure that all of the arrays are online and in Optimal state.
 - If the new storage subsystem controller firmware version is 6.xx, ensure that all of the arrays are online and in Optimal state. If they were not automatically placed into Online state, right-click the array name and click **Place -> Online** in the Storage Subsystem Management window.

- j. If there are any ghost hard disk drives or hard disk drives that are indicated as incompatible, or if any of the following conditions persist, contact IBM support for assistance:

- The **Empty Drive Bay** icon () is displayed for the drive bay into which you inserted the migrating drive.
 - The **Failed Unconfigured Drive** icon () or the **Failed Configured Drive** icon () is displayed for the drive bay into which you inserted the migrating drive.
 - Array configuration data on the drives that you added is incomplete.
 - You cannot bring the array online (controller firmware 6.xx.xx.xx or earlier) or import the array (controller firmware 7.xx.xx.xx or later).
- k. Use the Enable Identifier storage subsystem premium feature to generate and apply premium feature keys to remove Out of Compliance errors on enabled premium features from the original storage subsystem. See the instructions that come with the Enable Identifier premium feature for information about generating the premium feature keys.
- l. Extract the applicable SMCLI commands in the configuration script file that you saved in step 4c on page 131 to re-create the FlashCopy images, VolumeCopy images, remote mirror relationships, and host-to-LUNs map definitions, as required.
- m. Ensure that each enclosure ID in each drive loop/channel contains a unique first-position digit (x1). In addition, if the storage enclosures are recabled behind the new storage subsystem controller, modify the second-position digit (x10) so that it is the same in all IDs for all the storage enclosures in a drive channel/loop.
- If you are using the external key management method to manage the key for the FDE drives, convert the key management method from local to external management. For more information, see the *IBM System Storage DS Storage Manager V10 Installation and Host Support Guide* (for DS Storage Manager V10.77 or earlier) or *IBM System Storage DS Storage Manager V10.8 Installation and Host Support Guide* (for DS Storage Manager V10.83 or later).
- n. Update the switch zoning definitions and any applications that rely on the storage subsystem worldwide names to use the new storage subsystem worldwide names.

7. Redeploying the original storage subsystem controller.

You can redeploy the original storage subsystem if it is used in a configuration in which all of the installed hard disk drives are new. For more information, see “Redeploying the original storage subsystem” on page 142.

Performing an upgrade from a DS4700 or DS4800 storage subsystem to a DS5000 storage subsystem

To upgrade a DS4700 or DS4800 storage subsystem to a DS5000 storage subsystem, complete the following steps.

Note:

1. Ensure that the data in the existing configuration is backed up in a secure place before you start the upgrade procedure.

2. For more information about performing an upgrade, see “Upgrade considerations” on page 115.

1. **Planning the upgrade.**

To plan the upgrade, complete the following steps:

- a. Migrating from a DS4700 or DS4800 storage subsystem to a DS5100 or DS5300 storage subsystem is supported. Submit a request for price quote (RPQ) to migrate any EXP810 storage enclosures that are connected to the existing DS4700 or DS4800 controller.

Note: Only an EXP810 storage enclosure can be migrated from a DS4700 or DS4800 configuration into a DS5100 or DS5300 configuration.

- b. Purchase the premium feature entitlements that are enabled in the original storage subsystem for the new storage subsystem, if the premium features are not standard in the new storage subsystem.
- c. Purchase the host attachment entitlement kits for the new storage subsystem.
- d. If you are migrating from a working DS4700 configuration, purchase an additional EXP5000 storage enclosure to install the hard disk drives in the internal bays of the DS4700.

Note: If there are enough empty drive bays in the existing EXP810 storage enclosures, you can move the drives in the original DS4700 storage enclosure to the empty drive bays.

- e. Lay out the storage enclosure cabling to the new storage subsystem. For more information, see the documentation that comes with the new DS5000 storage subsystem. For information about the storage enclosure cabling rules, see the *Installation, User's and Maintenance Guide* for your storage subsystem.
- f. Purchase any additional hardware that is required to cable the existing storage enclosures to the new storage subsystem by using the storage enclosure cabling layout as a guide.
- g. Ensure that the original subsystem is in Optimal state. For more information, see “Bringing storage subsystems and drive loops into optimal state” on page 21 and the Recovery Guru in the DS Storage Manager Subsystem Management window.
- h. Perform a full backup of the original storage subsystem and schedule it for downtime.
- i. Retrieve the proofs of purchase for both the original and new storage subsystems and for any additional premium feature entitlements on the new and original storage subsystems.
- j. If there are any switch zoning definitions or applications that rely on the storage subsystem worldwide names, plan to update them to use the new storage subsystem worldwide names after the migration to the new storage subsystem is complete.

2. **Preparing the new storage subsystem.**

To prepare the new storage subsystem for the upgrade, complete the following steps:

- a. Unpack the new DS5000 storage subsystem and install it in a rack. Do not connect it to the storage enclosures that are attached to the original DS4700 or DS4800 storage subsystem.

- b. Connect the new storage subsystem to the systems-management network by using the default IP addresses of the controllers, and record the version of the controller firmware on the new storage subsystem.

The default TCP/IP address of controller A Ethernet port 1 is 192.168.128.101, and the default TCP/IP address of controller A Ethernet port 2 is 192.168.129.101. The default TCP/IP address of controller B Ethernet port 1 is 192.168.128.102s 1, and the default TCP/IP address of controller B Ethernet port 2 is 192.168.129.102.

3. Preparing the original storage subsystem.

To prepare the original storage subsystem for the upgrade, complete the following steps:

- a. If any long-running tasks are processing in the original storage subsystem, ensure that they complete processing. Examples of long-running tasks are:
 - Dynamic logical drive capacity expansion
 - Dynamic logical drive expansion (DVE)
 - Dynamic capacity expansion (DCE)
 - Logical drive segment size modification
 - Array RAID-level modification
 - User-initiated array redundancy checking (on the Storage Subsystem Management window, click **Array -> Check Redundancy**)
 - Remote mirror logical drive synchronization FlashCopy image or VolumeCopy image logical drive creation
 - Logical drive reconstruction or copyback
- b. Save the storage subsystem profile in a safe location and not on the logical drives that are mapped from the original storage subsystem.
- c. Record the version of the controller firmware that is on the storage subsystem.
- d. Collect all support data of the original storage subsystem.
- e. In the host servers, stop all programs, services, and processes that access the logical drives that are defined in the migrated hard disk drives. Also, ensure that no programs, services, or processes that write data to the logical drives are running in the background.
- f. Unmount the file systems to flush I/O from the server cache to disks.

Note:

- 1) If you are using a Windows operating system, remove the drive letter or the mount points of the drive-to-LUN map definitions, instead of unmounting the file systems.
 - 2) See your operating-system documentation for information about the file system unmount procedure.
 - g. Perform an incremental backup of the data that was changed since the full backup that you performed in step 1h on page 135.
 - h. Ensure that the environmental service modules (ESMs) and hard disk drives in the original storage subsystem are updated to the latest firmware level. To download the latest firmware level, go to <http://www.ibm.com/systems/support/storage/disk/>.
- ### 4. Upgrading the controller firmware.

To upgrade the controller firmware, complete the following steps:

- a. Use the following flowchart to determine the firmware version that is required in the new storage subsystem. To download the latest firmware level, go to <http://www.ibm.com/systems/support/storage/disk/>.

Note: The controller firmware is normally listed as either *xx.yy.zz.aa* or *xyyzzaa*, where *xx.yy* or *xyyz* is the controller firmware version that is used for compatibility checking. If the first *x* is 0, it might not be identified. For example, 07.36.14.01 is the same as 7.36.14.01. The firmware version that is used for compatibility checking in this example is 7.36.

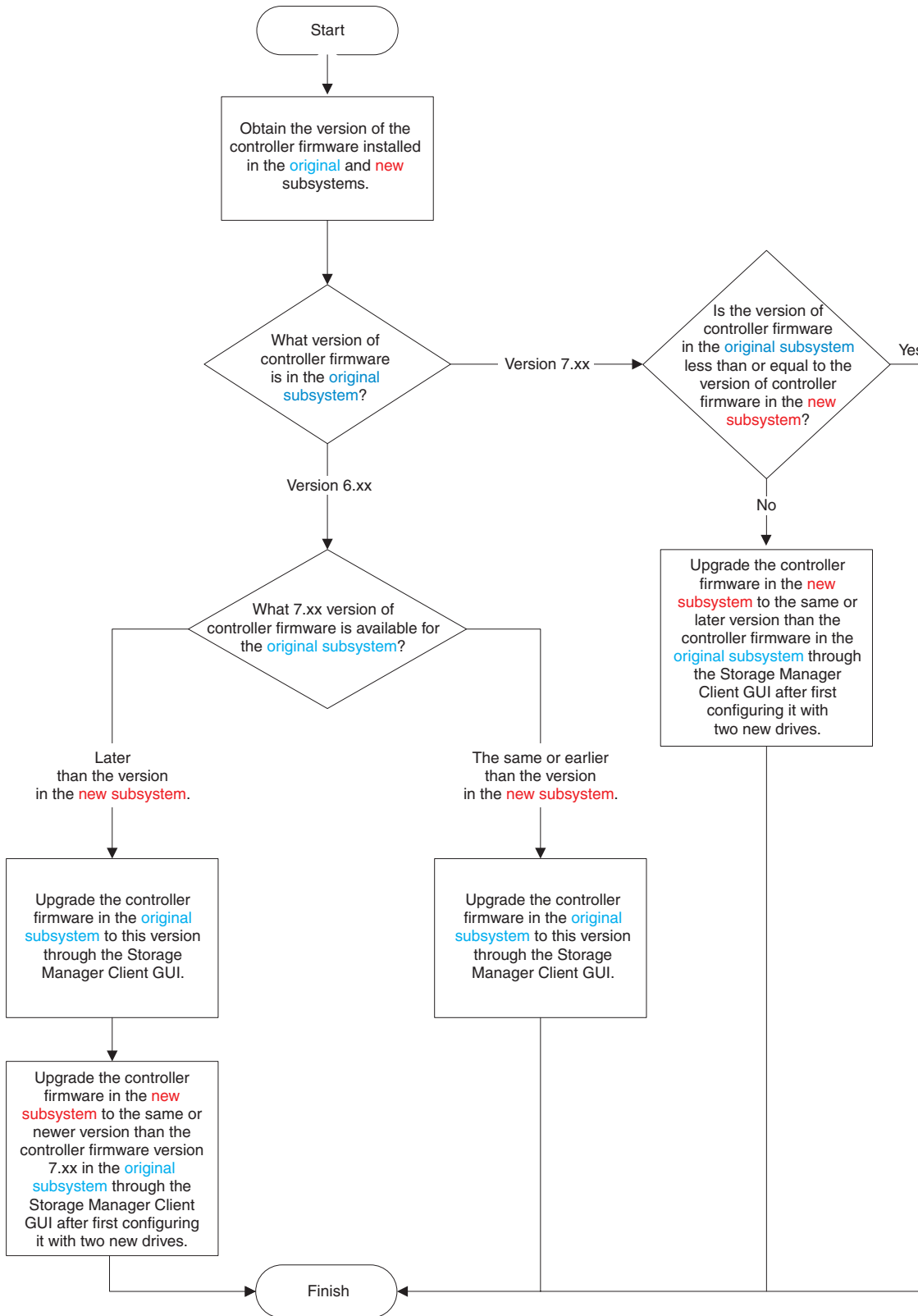

Figure 46. Firmware compatibility flowchart for a DS4700 or DS4800 to a DS5000 storage subsystem upgrade

- b. If you configured the new storage subsystem with at least two new drives to get the storage subsystem into Optimal state for updating the controller firmware, perform one of the following tasks:

- Leave the new storage subsystem configuration as is. Perform steps 4c-4g, 5a or 5b, and 5c-5e to prepare the original subsystem configuration for drive and drive enclosure migration and to turn on power of the original storage subsystem. For more information, see 4c on page 131. Use the procedure in Chapter 3, “Adding or migrating storage enclosures,” on page 75 to migrate the drives and storage enclosures in the original storage subsystem into the new storage subsystem configuration. After you migrate all of the drives and storage expansion enclosures to the new storage subsystem configuration, perform the appropriate steps in step 6 on page 140 to prepare the new storage subsystem for us.
 - Turn off the power to the new storage subsystem controller and remove the two drives (along with the additional storage enclosure, if attached). Continue with step 4c to replace the controller in the original storage subsystem with the new controller.
- c. Save the full configuration of the original storage subsystem into an SMcli script file. Be sure to select the check boxes for storage subsystem settings, logical drive configurations, logical drive-to-LUN map definitions, and topology before you proceed with the configuration save. Ensure that the location that you are saving to is not any of the logical drives that are mapped from the original storage subsystem.
 - d. Delete any FlashCopy images of the logical drives.
 - e. Delete any VolumeCopy logical drive pairs.
 - f. Delete any remote mirror relationships.
 - g. Delete any hosttoLUN mapping definitions in the original storage subsystem.

5. **Switching from the original to the new storage subsystem.**

To switch from the original to the new storage subsystem, complete the following steps:

- a. Perform one of the following tasks to export arrays, depending on the availability of hot-spare drives and unconfigured drives in the storage subsystem:
 - If hot-spare drives or unconfigured hard disk drives are installed in the original storage subsystem, export all of the defined arrays.
 - If no hot-spare drives or unconfigured hard disk drives are installed in the original storage subsystem, keep one array on the original storage subsystem and export all the other arrays. One array must be in Optimal state for the storage subsystem to be up and running.

Note: An error occurs if you try to export the last defined array in a storage subsystem configuration and no hot-spare drives or unconfigured drives are installed.

To export an array by using the Storage Subsystem Management window, right-click the name of the array and click **Advanced -> Maintenance -> Export Array**, and follow the instructions in the pop-up window. You can also use the **Start Array *array name* Export** command in the IBM Storage Manager Client script window.

- b. Turn off the power to the original controller first; then, turn off the power to the storage enclosures. This is the best practice power-off sequence. See the documentation that comes with the storage subsystem for details on the power-off sequence.

Note: Turn off the power to the controller before the storage enclosure.

- c. Label all the cables that are connected to the original storage subsystem enclosure.
- d. Wait until the LEDs on the storage subsystem chassis are off; then, disconnect all cables from the storage subsystem chassis.
- e. Remove the original storage subsystem enclosure from the rack.
- f. Install the new storage subsystem enclosure in the rack, if you did not do so in step 2a on page 135.

Note: See the documentation that comes with the storage subsystem for rack installation instructions.

- g. If the original storage subsystem is a DS4700 storage subsystem, install an EXP5000 storage enclosure and move the hard disk drives from the original storage subsystem to the storage enclosure.

Note: If there are enough empty drive bays in the existing storage enclosures, you can move the drives in the original integrated drive-controller enclosure to the empty drive bays.

- h. Insert the SFPs into the new storage subsystem drive loop/channel port bays and cable the storage enclosures to the new storage subsystem using the cabling layout you defined in step 1e on page 135.

Note: The IBM support services representative that performs the upgrade does not recable the storage enclosures to meet the DS5000 storage enclosure cabling requirement or run new Fibre Channel connections. This is the responsibility of the customer. The IBM support services representative makes only host and drive channel connections to the storage subsystem.

- i. Insert the SFPs into the new storage subsystem host port bays, and cable the host interface ports and the storage subsystem management ports of the new storage subsystem enclosure.
- j. Ensure that all of the storage enclosures are set to the same speed for each drive channel/loop.

6. Preparing the new storage subsystem for use.

To prepare the new storage subsystem for use, complete the following steps:

- a. If the controller TCP/IP addresses are assigned by using DHCP, update the DHCP records with the new controller Ethernet port MAC addresses.

Note: The controllers first check for a DHCP server during the boot process. If the controllers do not detect a DHCP server, they use either the static IP address (if defined) or the default IP addresses. For more information about changing the controller IP addresses, see the *IBM System Storage DS Storage Manager Installation and Support Guide*. For updated documentation, go to <http://www.ibm.com/systems/support/storage/disk/>.

- b. If necessary, turn on the power to the storage enclosures. Do not turn on the power to the new storage subsystem controller. Check the storage enclosure LEDs to ensure that the storage enclosures are connected properly.
- c. Turn on the power to the new storage subsystem controller.



Note: If the TCP/IP addresses of the Ethernet management ports are statically defined for the original storage subsystem controllers, the TCP/IP addresses are used for the same Ethernet management ports in the new controllers.

- d. Connect the new storage subsystem to the IBM DS Storage Manager Client either through the out-of-band method by using the applicable TCP/IP addresses of the controller Ethernet management ports, or through the in-band method through Fibre Channel connections.

Note: The new storage subsystem identifies itself as the machine type that it replaced until you download the applicable NVSRAM firmware for the new storage subsystem.

- e. Ensure that the new storage subsystem configuration is in Optimal state and that all of the drives are identified. Use the Recovery Guru in the DS Storage Manager Client Subsystem Management window to resolve any Needs Attention conditions.
- f. Update the controller firmware of the new storage subsystem to the latest available version, if necessary.
- g. Download the applicable NVSRAM firmware for the new storage subsystem.
- h. Import all of the arrays that were exported in step 5a on page 139. Ensure that all of the arrays are online and in Optimal state.
- i. If there are any ghost hard disk drives or hard disk drives that are indicated as incompatible, or if any of the following conditions persist, contact IBM support for assistance:

- The **Empty Drive Bay** icon () is displayed for the drive bay into which you inserted the migrating drive.

- The **Failed Unconfigured Drive** icon () or the **Failed Configured Drive** icon () is displayed for the drive bay into which you inserted the migrating drive.

- Array configuration data on the drives that you added is incomplete.
 - You cannot bring the array online (controller firmware 6.xx.xx.xx or earlier) or import the array (controller firmware 7.xx.xx.xx or later).
- j. Use the Enable Identifier storage subsystem premium feature to generate and apply premium feature keys to remove Out of Compliance errors on enabled premium features from the original storage subsystem. See the instructions that come with the Enable Identifier premium feature for information about generating the premium feature keys.
 - k. Extract the applicable SMCLI commands in the configuration script file that you saved in step 4c on page 139 to recreate the FlashCopy images, VolumeCopy images, remote mirror relationships, and host-to-LUNs map definitions, as required.
 - l. Ensure that each enclosure ID in each drive loop/channel contains a unique first-position digit (x1). In addition, if the storage enclosures are recabled behind the new storage subsystem controller, modify the second-position digit (x10) so that it is the same in all IDs for all the storage enclosures in a drive channel/loop.
 - m. Update the switch zoning definitions and any applications that rely on the storage subsystem worldwide names to use the new storage subsystem worldwide names.

Redeploying the original storage subsystem

The following notes describe information that you must consider before you redeploy the original storage subsystem.

Redeployment limitations

Controller replacement of a partial set of the storage enclosures, hard disk drives, or both that were part of a working configuration is not supported. In addition, you can redeploy the original storage subsystem controller only if new hard disk drives are used in the redeployed subsystem. This is a requirement regardless of whether the original storage subsystem is redeployed in the same Ethernet network.

A hard disk drive is new if it is not used in any storage subsystem configuration. A hard disk drive that is inserted in a hard disk drive bay of an operational configuration, even if it is not configured as part of any array, is a used hard disk drive. When you redeploy by using new hard disk drives, a new storage array identifier (SA ID or storage subsystem worldwide name) is generated, which allows the management of the redeployed original and the new storage subsystem in the same Ethernet network.

In rare circumstances, the newly generated storage array identifier of the redeployed original storage subsystem is the same as the storage array identifier that was adopted in the new storage subsystem from the migrated hard disk drives. When this happens, the DS Storage Manager Client program cannot manage the redeployed original and new storage subsystem. Also, DS Storage Manager Client program version 10.50 or later identifies both of these subsystems as one managed entry in the Enterprise Management window. To verify this condition, complete the following steps:

1. Exit from the DS Storage Manager Client program.
2. Turn off the power to either the redeployed original or the new storage subsystem.
3. Restart the DS Storage Manager Client program and retrieve the storage subsystem worldwide name from the storage subsystem profile. See Table 30 on page 125.
4. Repeat steps 1 through 3 with the other storage subsystem turned on only to determine the storage subsystem worldwide name.
5. If the storage subsystem worldwide names are the same for both the redeployed original storage subsystem and the new storage subsystem, contact IBM support for help.

Configuration behavior in a redeployed storage subsystem

The following notes describe the identifier and premium feature behavior in a redeployed storage subsystem.

Important: IBM support is available to assist if you plan to redeploy a replaced storage subsystem. For more information, see “Getting information, help, and service,” on page 145.

- Worldwide name (WWN):

The worldwide names that the original storage subsystem uses are retained on the redeployed system. So, the association between any hosts and the storage subsystem is lost.

- Storage array identifier or SA identifier:

Attention: IBM does not support migrating a subset of hard disk drives in an existing configuration to a new configuration with a new storage subsystem while the remaining hard disk drives are installed in an existing storage subsystem configuration.

If both the new and redeployed storage subsystem have the same SA identifier, serious problems result when you start the DS Storage Manager SMclient program. The storage subsystem that the DS Storage Manager SMclient program arbitrarily selects is manageable, and the other storage subsystem is unmanageable. Contact IBM resellers or IBM support if the new and redeployed storage subsystems have the same SA identifier.

- SAFE premium feature identifier (SAFE ID):

The original storage subsystem generates a new SAFE ID when it is redeployed, enabling none of the premium features from the original system. This new SAFE ID prevents the system from using any premium feature key files that were previously acquired and re-enabling any premium features. In cases in which the original storage subsystem contained preinstalled NVSRAM codes to enable certain premium features, NVSRAM codes are cleared from the storage subsystem when the storage subsystem is redeployed and turned on for the first time. Therefore, premium features that were enabled as standard features do not reactivate on the redeployed system. The system retains full data availability, but you must generate new premium feature keys to re-enable premium features. Ensure to have the necessary proof of purchase. To regenerate the new premium feature keys, ensure that you have the machine type, model, and serial number that you previously used to generate the premium feature on the original storage subsystem. Then, go to <http://www-912.ibm.com/PremiumFeatures/>, select the option to reactivate the premium feature, and follow the instructions on the website. Do not select the 'activating premium features' option to regenerate premium feature keys for the original subsystems. You can also generate new premium feature keys by contacting your IBM representatives or resellers.

- Controller IP addresses:

When the storage subsystem controllers are assigned static IP addresses, the IP addresses are stored in the controller NVSRAM and in the DACstore on the hard disk drives. If the replacement storage subsystem controllers are assigned the same IP addresses as the original storage subsystem controllers, the two devices have duplicate IP address in the Ethernet network because the original controller uses the static IP addresses from the NVSRAM when it is redeployed. Best practice is to assign new unique IP addresses to replacement storage subsystem controllers.

Appendix. Getting information, help, and service

If you need help, service, or technical assistance or want more information about IBM products, you will find a wide variety of sources available from IBM to assist you. This section contains information about where to go for additional information about IBM and IBM products, what to do if you experience a problem with your system, and whom to call for service, if it is necessary.

Before you call

Before you call, ensure that you take these steps to try to solve the problem yourself:

- Check all cables to ensure that they are connected.
- Check the power switches to ensure that the system and any optional devices are turned on.
- Use the troubleshooting information in your system documentation, and use the diagnostic tools that come with your system. Information about diagnostic tools is in the *Problem Determination and Service Guide* for your storage subsystem.
- See “Getting help and information from the World Wide Web” on page 146 to access the IBM support websites you can use to check for technical information, hints, tips, and new device drivers.

You can solve many problems without outside assistance by following the troubleshooting procedures that IBM provides in the DS Storage Manager online help or in the documents that are provided with your system and software. The information that comes with your system also describes the diagnostic tests that you can perform. Most subsystems, operating systems, and programs come with information that contains troubleshooting procedures and explanations of error messages and error codes. If you suspect a software problem, see the information for the operating system or program.

Using the documentation

Information about your IBM system and preinstalled software, if any, is available in the documents that come with your system. This includes printed books, online documents, readme files, and help files. See the troubleshooting information in your system documentation for instructions for using the diagnostic programs. The troubleshooting information or diagnostic programs might contain indications that you will need additional or updated device drivers, or other software.

Finding Storage Manager software, controller firmware, and readme files

DS Storage Manager software and controller firmware are available on the product DVD and can also be downloaded from the Web.

Important: Before you install DS Storage Manager software, consult the readme file. Updated readme files contain the latest device driver versions, firmware levels, limitations, and other information not found in this document.

1. Go to <http://www.ibm.com/servers/storage/support/disk/>.
2. Click the link for your storage subsystem (for example, **DS4800**).

3. In the Downloads for DS4800 Midrange Disk system page, click the **Download** tab, and then click **Storage Manager, firmware, HBA, tools, support, and pubs (including readme files)**. The Downloads page for the subsystem opens.
4. For Storage Manager software, click the **Storage Mgr** tab.
5. For the readme file, in the "Current version and readme files" column on the Storage Mgr page, click the readme file link for your host operating system. For controller firmware, click the **Firmware** tab.

Use the *IBM DS Storage Manager Concepts Guide* to become familiar with the terminology and the features of the DS Storage Manager software. This document is available on the DS Storage Manager installation DVD and at the IBM website.

Getting help and information from the World Wide Web

On the World Wide Web, the IBM support websites have up-to-date information about storage subsystems and DS Storage Manager software, including documentation and the most recent software, firmware, and NVSRAM downloads.

IBM System Storage Disk Storage Systems

Go to <http://www.ibm.com/systems/support/storage/disk/> for links to software and firmware downloads, readme files, and support pages for all IBM System Storage disk storage systems.

IBM System Storage Interoperation Center (SSIC)

Go to <http://www.ibm.com/systems/support/storage/config/ssic/index.jsp> for technical support information, including the latest firmware levels.

IBM DS3000, DS4000, DS5000, and BladeCenter® Premium Feature Activation

To activate a premium feature, go to <https://www-912.ibm.com/PremiumFeatures/jsp/keyPrereq.jsp>.

IBM System Storage Interoperability Matrix

Go to <http://www.ibm.com/systems/storage/disk/ds4000/interop-matrix.html> for the latest support information for host operating systems, HBAs, clustering, storage area networks (SANs), DS Storage Manager software and controller firmware.

IBM System Storage Productivity Center

For the latest documentation that supports the IBM System Storage Productivity Center, a new system that is designed to provide a central management console for IBM System Storage DS4000, DS5000, DS8000®, and SAN Volume Controller, go to <http://publib.boulder.ibm.com/infocenter/tivihelp/v4r1/index.jsp>.

IBM System Storage

Go to <http://www.ibm.com/systems/support/storage/disk/> for the latest support information for host operating systems, HBAs, clustering, storage area networks (SANs), DS Storage Manager software and controller firmware.

Storage Area Network (SAN) Support

For information about using SAN switches, including links to SAN user guides and other documents, go to <http://www.ibm.com/systems/support/storage/san>.

Fix Central

Go to <http://www.ibm.com/eserver/support/fixes> for fixes and updates for software, hardware, and host operating systems.

IBM System Storage products

Go to <http://www.storage.ibm.com> for information about all IBM System Storage products.

IBM Publications Center

For IBM publications, go to <http://www.ibm.com/shop/publications/order/>.

Software service and support

Through the IBM Support Line, you can get telephone assistance with usage, configuration, and software problems, for a fee. For information about which products are supported by Support Line in your country or region, go to <http://www.ibm.com/services/sl/products>.

For more information about Support Line and other IBM services, see <http://www.ibm.com/services/>, or see <http://www.ibm.com/planetwide/> for support telephone numbers. In the U.S. and Canada, call 1-800-IBM-SERV (1-800-426-7378).

Hardware service and support

You can receive hardware service through your IBM reseller or IBM Services. To locate a reseller authorized by IBM to provide warranty service, go to <http://www.ibm.com/partnerworld/> and click **Find Business Partners** on the right side of the page. For IBM support telephone numbers, see <http://www.ibm.com/planetwide/>. In the US and Canada, call 1-800-IBM-SERV (1-800-426-7378).

In the US and Canada, hardware service and support is available 24 hours a day, 7 days a week. In the U.K., these services are available Monday through Friday, from 9 a.m. to 6 p.m.

Taiwan Contact Information

IBM Taiwan Product Service Contact Info:
IBM Taiwan Corporation
3F, No 7, Song Ren Rd., Taipei Taiwan
Tel: 0800-016-888

台灣IBM 產品服務聯絡方式：
台灣國際商業機器股份有限公司
台北市松仁路7號3樓
電話：0800-016-888

12c00790

Fire suppression systems

A fire suppression system is the responsibility of the customer. The customer's own insurance underwriter, local fire marshal, or a local building inspector, or all, should be consulted in selecting a fire suppression system that provides the correct level of coverage and protection. IBM designs and manufactures equipment to internal and external standards that require certain environments for reliable operation. Because IBM does not test any equipment for compatibility with fire

suppression systems, IBM does not make compatibility claims of any kind nor does IBM provide recommendations on fire suppression systems.

Notices

This information was developed for products and services offered in the U.S.A.

IBM may not offer the products, services, or features discussed in this document in other countries. Consult your local IBM representative for information on the products and services currently available in your area. Any reference to an IBM product, program, or service is not intended to state or imply that only that IBM product, program, or service may be used. Any functionally equivalent product, program, or service that does not infringe any IBM intellectual property right may be used instead. However, it is the user's responsibility to evaluate and verify the operation of any non-IBM product, program, or service.

IBM may have patents or pending patent applications covering subject matter described in this document. The furnishing of this document does not grant you any license to these patents. You can send license inquiries, in writing, to:

IBM Director of Licensing
IBM Corporation
North Castle Drive
Armonk, NY 10504-1785
U.S.A.

For license inquiries regarding double-byte character set (DBCS) information, contact the IBM Intellectual Property Department in your country or send inquiries, in writing, to:

Intellectual Property Licensing
Legal and Intellectual Property Law
IBM Japan Ltd.
1623-14, Shimotsuruma, Yamato-shi
Kanagawa 242-8502 Japan

The following paragraph does not apply to the United Kingdom or any other country where such provisions are inconsistent with local law: INTERNATIONAL BUSINESS MACHINES CORPORATION PROVIDES THIS PUBLICATION "AS IS" WITHOUT WARRANTY OF ANY KIND, EITHER EXPRESS OR IMPLIED, INCLUDING, BUT NOT LIMITED TO, THE IMPLIED WARRANTIES OF NON-INFRINGEMENT, MERCHANTABILITY OR FITNESS FOR A PARTICULAR PURPOSE. Some states do not allow disclaimer of express or implied warranties in certain transactions, therefore, this statement may not apply to you.

This information could include technical inaccuracies or typographical errors. Changes are periodically made to the information herein; these changes will be incorporated in new editions of the publication. IBM may make improvements and/or changes in the product(s) and/or the program(s) described in this publication at any time without notice.

Any references in this information to non-IBM websites are provided for convenience only and do not in any manner serve as an endorsement of those websites. The materials at those websites are not part of the materials for this IBM product and use of those websites is at your own risk.

IBM may use or distribute any of the information you supply in any way it believes appropriate without incurring any obligation to you.

Licensees of this program who wish to have information about it for the purpose of enabling: (i) the exchange of information between independently created programs and other programs (including this one) and (ii) the mutual use of the information which has been exchanged, should contact:

IBM Corporation
Almaden Research
650 Harry Road
Bldg 80, D3-304, Department 277
San Jose, CA 95120-6099
U.S.A.

Such information may be available, subject to appropriate terms and conditions, including in some cases, payment of a fee.

The licensed program described in this document and all licensed material available for it are provided by IBM under terms of the IBM Customer Agreement, IBM International Program License Agreement or any equivalent agreement between us.

Any performance data contained herein was determined in a controlled environment. Therefore, the results obtained in other operating environments may vary significantly. Some measurements may have been made on development-level systems and there is no guarantee that these measurements will be the same on generally available systems. Furthermore, some measurements may have been estimated through extrapolation. Actual results may vary. Users of this document should verify the applicable data for their specific environment.

Information concerning non-IBM products was obtained from the suppliers of those products, their published announcements or other publicly available sources. IBM has not tested those products and cannot confirm the accuracy of performance, compatibility or any other claims related to non-IBM products. Questions on the capabilities of non-IBM products should be addressed to the suppliers of those products.

All statements regarding IBM's future direction or intent are subject to change or withdrawal without notice, and represent goals and objectives only.

All IBM prices shown are IBM's suggested retail prices, are current and are subject to change without notice. Dealer prices may vary.

This information is for planning purposes only. The information herein is subject to change before the products described become available.

This information contains examples of data and reports used in daily business operations. To illustrate them as completely as possible, the examples include the names of individuals, companies, brands, and products. All of these names are fictitious and any similarity to the names and addresses used by an actual business enterprise is entirely coincidental.

COPYRIGHT LICENSE:

This information contains sample application programs in source language, which illustrate programming techniques on various operating platforms. You may copy, modify, and distribute these sample programs in any form without payment to IBM, for the purposes of developing, using, marketing or distributing application programs conforming to the application programming interface for the operating platform for which the sample programs are written. These examples have not been thoroughly tested under all conditions. IBM, therefore, cannot guarantee or imply reliability, serviceability, or function of these programs. The sample programs are provided "AS IS", without warranty of any kind. IBM shall not be liable for any damages arising out of your use of the sample programs.

Each copy or any portion of these sample programs or any derivative work, must include a copyright notice as follows:

© (your company name) (year). Portions of this code are derived from IBM Corp. Sample Programs.

© Copyright IBM Corp. _enter the year or years_.

If you are viewing this information softcopy, the photographs and color illustrations may not appear.

Trademarks

IBM, the IBM logo, and ibm.com[®] are trademarks or registered trademarks of International Business Machines Corp., registered in many jurisdictions worldwide. Other product and service names might be trademarks of IBM or other companies. A current list of IBM trademarks is available on the web at Copyright and trademark information at www.ibm.com/legal/copytrade.shtml.

Adobe, the Adobe logo, PostScript, and the PostScript logo are either registered trademarks or trademarks of Adobe Systems Incorporated in the United States, and/or other countries.

IT Infrastructure Library is a registered trademark of the Central Computer and Telecommunications Agency which is now part of the Office of Government Commerce.

Intel, Intel logo, Intel Inside, Intel Inside logo, Intel Centrino, Intel Centrino logo, Celeron, Intel Xeon, Intel SpeedStep, Itanium, and Pentium are trademarks or registered trademarks of Intel Corporation or its subsidiaries in the United States and other countries.

Linux is a registered trademark of Linus Torvalds in the United States, other countries, or both.

Microsoft, Windows, Windows NT, and the Windows logo are trademarks of Microsoft Corporation in the United States, other countries, or both.

ITIL is a registered trademark, and a registered community trademark of The Minister for the Cabinet Office, and is registered in the U.S. Patent and Trademark Office.

UNIX is a registered trademark of The Open Group in the United States and other countries.

Java and all Java-based trademarks and logos are trademarks or registered trademarks of Oracle and/or its affiliates.

Cell Broadband Engine is a trademark of Sony Computer Entertainment, Inc. in the United States, other countries, or both and is used under license therefrom.

Linear Tape-Open, LTO, the LTO Logo, Ultrium, and the Ultrium logo are trademarks of HP, IBM Corp. and Quantum in the U.S. and other countries.

Important notes

Processor speed indicates the internal clock speed of the microprocessor; other factors also affect application performance.

CD or DVD drive speed is the variable read rate. Actual speeds vary and are often less than the possible maximum.

When referring to processor storage, real and virtual storage, or channel volume, KB stands for 1024 bytes, MB stands for 1 048 576 bytes, and GB stands for 1 073 741 824 bytes.

When referring to hard disk drive capacity or communications volume, MB stands for 1 000 000 bytes, and GB stands for 1 000 000 000 bytes. Total user-accessible capacity can vary depending on operating environments.

Maximum internal hard disk drive capacities assume the replacement of any standard hard disk drives and population of all hard disk drive bays with the largest currently supported drives that are available from IBM.

Maximum memory might require replacement of the standard memory with an optional memory module.

IBM makes no representation or warranties regarding non-IBM products and services that are ServerProven[®], including but not limited to the implied warranties of merchantability and fitness for a particular purpose. These products are offered and warranted solely by third parties.

IBM makes no representations or warranties with respect to non-IBM products. Support (if any) for the non-IBM products is provided by the third party, not IBM.

Some software might differ from its retail version (if available) and might not include user manuals or all program functionality.

Particulate contamination

Attention: Airborne particulates (including metal flakes or particles) and reactive gases acting alone or in combination with other environmental factors such as humidity or temperature might pose a risk to the storage enclosure that is described in this document. Risks that are posed by the presence of excessive particulate levels or concentrations of harmful gases include damage that might cause the storage enclosure to malfunction or cease functioning altogether. This specification sets forth limits for particulates and gases that are intended to avoid such damage. The limits must not be viewed or used as definitive limits, because numerous other factors, such as temperature or moisture content of the air, can influence the impact of particulates or environmental corrosives and gaseous contaminant transfer. In the absence of specific limits that are set forth in this document, you must implement practices that maintain particulate and gas levels that are consistent with the protection of human health and safety. If IBM determines that the levels of particulates or gases in your environment have caused damage to the storage enclosure, IBM may condition provision of repair or replacement of storage enclosure or parts on implementation of appropriate remedial measures to mitigate such environmental contamination. Implementation of such remedial measures is a customer responsibility.

Table 31. Limits for particulates and gases

Contaminant	Limits
Particulate	<ul style="list-style-type: none">• The room air must be continuously filtered with 40% atmospheric dust spot efficiency (MERV 9) according to ASHRAE Standard 52.2¹.• Air that enters a data center must be filtered to 99.97% efficiency or greater, using high-efficiency particulate air (HEPA) filters that meet MIL-STD-282.• The deliquescent relative humidity of the particulate contamination must be more than 60%².• The room must be free of conductive contamination such as zinc whiskers.
Gaseous	<ul style="list-style-type: none">• Copper: Class G1 as per ANSI/ISA 71.04-1985³• Silver: Corrosion rate of less than 300 Å in 30 days

¹ ASHRAE 52.2-2008 - *Method of Testing General Ventilation Air-Cleaning Devices for Removal Efficiency by Particle Size*. Atlanta: American Society of Heating, Refrigerating and Air-Conditioning Engineers, Inc.

² The deliquescent relative humidity of particulate contamination is the relative humidity at which the dust absorbs enough water to become wet and promote ionic conduction.

³ ANSI/ISA-71.04-1985. *Environmental conditions for process measurement and control systems: Airborne contaminants*. Instrument Society of America, Research Triangle Park, North Carolina, U.S.A.

Documentation format

The publications for this product are in Adobe Portable Document Format (PDF) and should be compliant with accessibility standards. If you experience difficulties when you use the PDF files and want to request a Web-based format or accessible PDF document for a publication, direct your mail to the following address:

*Information Development
IBM Corporation
205/A015
3039 E. Cornwallis Road
P.O. Box 12195*

*Research Triangle Park, North Carolina 27709-2195
U.S.A.*

In the request, be sure to include the publication part number and title.

When you send information to IBM, you grant IBM a nonexclusive right to use or distribute the information in any way it believes appropriate without incurring any obligation to you.

Electronic emission notices

Federal Communications Commission (FCC) Class A Statement

This equipment has been tested and complies with the limits for a Class A digital device, pursuant to Part 15 of the FCC Rules. These limits are designed to provide reasonable protection against harmful interference when the equipment is operated in a commercial environment. This equipment generates, uses, and can radiate radio frequency energy and, if not installed and used in accordance with the instruction manual, may cause harmful interference to radio communications. Operation of this equipment in a residential area is likely to cause harmful interference, in which case the user will be required to correct the interference at his own expense.

Properly shielded and grounded cables and connectors must be used in order to meet FCC emission limits. IBM is not responsible for any radio or television interference caused by using other than recommended cables and connectors or by unauthorized changes or modifications to this equipment. Unauthorized changes or modifications could void the user's authority to operate the equipment.

This device complies with Part 15 of the FCC Rules. Operation is subject to the following two conditions: (1) this device may not cause harmful interference, and (2) this device must accept any interference received, including interference that may cause undesired operation.

Industry Canada Class A Emission Compliance Statement

This Class A digital apparatus complies with Canadian ICES-003.

Avis de conformité à la réglementation d'Industrie Canada

Cet appareil numérique de la classe A est conforme à la norme NMB-003 du Canada.

Australia and New Zealand Class A Statement

Attention: This is a Class A product. In a domestic environment this product might cause radio interference in which case the user might be required to take adequate measures.

European Union EMC Directive Conformance Statement

This product is in conformity with the protection requirements of EU Council Directive 2004/108/EC on the approximation of the laws of the Member States relating to electromagnetic compatibility. IBM cannot accept responsibility for any failure to satisfy the protection requirements resulting from a non-recommended modification of the product, including the fitting of non-IBM option cards.

Attention: This is an EN55022 Class A product. In a domestic environment this product may cause radio interference in which case the user may be required to take adequate measures.

Responsible manufacturer: International Business Machines Corp. New Orchard Road Armonk, New York 10504 Tel: 919-499-1900

European community contact: IBM Deutschland GmbH Technical Regulations, Department M372 IBM-Allee 1, 71139 Ehningen, Germany Tele: +49 7032 15 2941 e-mail: lugi@de.ibm.com

Taiwan Class A Electronic Emission Statement

警告使用者：
這是甲類的資訊產品，在
居住的環境中使用時，可
能會造成射頻干擾，在這
種情況下，使用者會被要
求採取某些適當的對策。

Germany Electromagnetic Compatibility Directive

Deutschsprachiger EU Hinweis:

Hinweis für Geräte der Klasse A EU-Richtlinie zur Elektromagnetischen Verträglichkeit

Dieses Produkt entspricht den Schutzanforderungen der EU-Richtlinie 2004/108/EG zur Angleichung der Rechtsvorschriften über die elektromagnetische Verträglichkeit in den EU-Mitgliedsstaaten und hält die Grenzwerte der EN 55022 Klasse A ein.

Um dieses sicherzustellen, sind die Geräte wie in den Handbüchern beschrieben zu installieren und zu betreiben. Des Weiteren dürfen auch nur von der IBM empfohlene Kabel angeschlossen werden. IBM übernimmt keine Verantwortung für die Einhaltung der Schutzanforderungen, wenn das Produkt ohne Zustimmung der IBM verändert bzw. wenn Erweiterungskomponenten von Fremdherstellern ohne Empfehlung der IBM gesteckt/eingebaut werden.

EN 55022 Klasse A Geräte müssen mit folgendem Warnhinweis versehen werden: "Warnung: Dieses ist eine Einrichtung der Klasse A. Diese Einrichtung kann im Wohnbereich Funk-Störungen verursachen; in diesem Fall kann vom Betreiber verlangt werden, angemessene Maßnahmen zu ergreifen und dafür aufzukommen."

Deutschland: Einhaltung des Gesetzes über die elektromagnetische Verträglichkeit von Geräten

Dieses Produkt entspricht dem "Gesetz über die elektromagnetische Verträglichkeit von Geräten (EMVG)". Dies ist die Umsetzung der EU-Richtlinie 2004/108/EG in der Bundesrepublik Deutschland.

Zulassungsbescheinigung laut dem Deutschen Gesetz über die elektromagnetische Verträglichkeit von Geräten (EMVG) (bzw. der EMC EG Richtlinie 2004/108/EG) für Geräte der Klasse A

Dieses Gerät ist berechtigt, in Übereinstimmung mit dem Deutschen EMVG das EG-Konformitätszeichen - CE - zu führen.

Verantwortlich für die Einhaltung der EMV Vorschriften ist der Hersteller:
International Business Machines Corp. New Orchard Road Armonk, New York
10504 Tel: 919-499-1900

Der verantwortliche Ansprechpartner des Herstellers in der EU ist: IBM
Deutschland GmbH Technical Regulations, Abteilung M372 IBM-Allee 1, 71139
Ehningen, Germany Tele: +049 7032 15 2941 e-mail: lugi@de.ibm.com

Generelle Informationen:

Das Gerät erfüllt die Schutzanforderungen nach EN 55024 und EN 55022 Klasse A.

People's Republic of China Class A Electronic Emission Statement

中华人民共和国“A类”警告声明

声明

此为A级产品，在生活环境中，该产品可能会造成无线电干扰。在这种情况下，可能需要用户对其干扰采取切实可行的措施。

Japan Voluntary Control Council for Interference (VCCI) Class A Statement

この装置は、クラス A 情報技術装置です。この装置を家庭環境で使用する
と電波妨害を引き起こすことがあります。この場合には使用者が適切な対策
を講ずるよう要求されることがあります。 VCCI-A

Translation: This is a Class A product based on the standard of the VCCI Council.
If this equipment is used in a domestic environment, radio interference may occur,
in which case, the user may be required to take corrective actions.

Japan Electronics and Information Technology Industries Association (JEITA) Statement

Japanese Electronics and Information Technology Industries Association (JEITA)
Confirmed Harmonics Guideline (products less than or equal to 20 A per phase).

高調波ガイドライン適合品

jeita

Korea Communications Commission (KCC) Class A Statement

Please note that this equipment has obtained EMC registration for commercial use. In the event that it has been mistakenly sold or purchased, please exchange it for equipment certified for home use.

이 기기는 업무용(A급)으로 전자파적합기기로서 판매자 또는 사용자는 이 점을 주의하시기 바라며, 가정외의 지역에서 사용하는 것을 목적으로 합니다.

Index

A

- accessible documentation 153
- add
 - new hard disk drives 57
 - storage enclosures 75
 - used hard disk drives 58
- adding hard drives, considerations 75
- additional storage enclosures
 - cabling 112
 - inserting drives 112
- AppWare 9
- array
 - cannot bring online 64
 - configuration data for drives
 - incomplete 64
- arrays, migrating 66
- attention 64, 70, 71, 77, 81
- attention notices x
- automatically reset controllers 70, 71

B

- backup
 - logical drives 60, 80
 - storage subsystem data 1
- beginning of drive loop, connect storage enclosures 97
- best practice cable loop scheme
 - DS4000 87, 94, 99
 - DS5000 87, 94, 99
- BootWare 9
- bottom of drive loop, connect storage enclosures 86

C

- cable
 - EXP710 to EXP810 41
 - trace connections 81
- cabling enclosures
 - DS4700 109
 - DS4800 109
- cabling, incorrect 102
- cabling, storage enclosure 84
- cannot bring array online 64
- catastrophic failure 66
- caution statements x
- change Fibre Channel speed settings 28
- check for configuration data 71
- Class A electronic emission notice 154
- configuration behavior, redeployed storage subsystem 142
- configuration data 59
- configure drives 71
- considerations, upgrade 115
- contamination, particulate and gaseous 153
- controller
 - drive loop LED 81
 - firmware level 2

- controller (*continued*)
 - by machine type 9
 - by model number 9
 - by NVSRAM version 9
 - current 9
 - firmware, verify level 1, 9, 60
 - reset automatically 70, 71
- controller firmware 9
 - upgrading 13
- customize storage partitioning information 60

D

- danger statements x
- diagrams, cabling 48
- disable drive migration settings 70
 - become effective 71
- DisableDriveMigration.scr script 71
 - documentation
 - websites 146
- documentation format 153
- documentation, using 145
- drive ID and model, determining 19
- drive loop
 - optimal state 21
 - speed change procedure 28
- drive loop schemes 102
- drive loops A and B 97
- drive migration
 - prerequisites 1
 - settings
 - disable 70
 - re-enable 58
- drive migration disable script, using 70
- drive migration enable settings
 - verifying 82
- drive migration limitations 14
- drive migration settings, verifying 61
- drive/loop channel 101
- drives
 - CRU assembly 63
 - do not appear marked as Failed 64
 - do not display 64
 - remove
 - configuration data 70
 - will not spin up 57
 - drives, inserting 71
 - drives, removing 63
- DS Storage Manager
 - publications x
- DS Storage Manager publications x
 - DS3000 ix
 - DS4000 ix
 - DS4000 Fibre Channel and Serial ATA, Intermix 31
 - DS4000 Storage Subsystem
 - firmware 9
 - NVSRAM 9
 - profile 1

- DS4000 support
 - Web site 9
- DS4300
 - enclosure IDs 78
 - Storage Subsystem firmware and NVSRAM 9
 - Turbo Storage Subsystem firmware and NVSRAM 9
- DS4300 Storage Subsystem
 - migration 121, 122
- DS4400 Storage Subsystem firmware and NVSRAM 9
- DS4500 Storage Subsystem firmware and NVSRAM 9
- DS5000 ix
- DS5000 Storage Subsystem
 - firmware 9
 - NVSRAM 9
- DS5000 support
 - Web site 9

E

- electronic emission Class A notice 154
- electrostatic discharge (ESD) bags 64
- electrostatic discharge (ESD)
 - procedure 57
- electrostatic discharge procedure 58
- Empty Drive icon 64
- EnableDriveMigration.scr script 71
- enclosure ID 29
- end (bottom) of a drive loop
 - connecting storage enclosures 88
- end of drive loop, connect storage enclosures 86
- environmental service module (ESM)
 - firmware 28
- errors
 - drive enclosure lost redundancy path 97
 - loss of ESM path redundancy 81
- ESD procedures 58
- ESM Fault LED 82
- ESM firmware
 - EXP500 9
 - EXP700 9
 - upgrade during I/O 9
 - upgrading 13
 - version, current 9
- event logs, interpreting 21
- execute script 70, 71
- EXP500
 - and EXP700 in a redundant drive loop pair 28
 - ESM firmware 9
 - ID switch location 78, 83
- EXP500 storage enclosure
 - accommodation 122
- EXP700
 - and EXP500 in a redundant drive loop pair 28

- EXP700 (*continued*)
 - ESM firmware 9
 - ID switch location 78, 83
- EXP710
 - cabling 41
- EXP810
 - cabling 41
- export drives 3
- exporting drives 62
- external drive enclosure, benefits 22

F

- Failed icons 64
- FASt200
 - enclosure IDs 78
 - HA Storage Server firmware and NVSRAM 9
 - Storage Subsystem firmware and NVSRAM 9
- FASt500 RAID controller firmware and NVSRAM 9
- FCC Class A notice 154
- Fibre Channel
 - insert drives 57, 58, 64, 78, 112
 - remove connection 97
 - trace cable connections 81
- fire suppression 147
- firmware
 - compatibility 9
 - controller 9
 - controller and NVSRAM levels 60
 - controller, NVSRAM, and ESM levels 1
 - current 9
 - ESM, version by storage enclosure 9
 - updates 9
- firmware and NVSRAM
 - DS4300
 - Storage Subsystem 9
 - Turbo Storage Subsystem 9
 - DS4400 Storage Subsystem 9
 - DS4500 Storage Subsystem 9
 - FASt200
 - HA Storage Subsystem 9
 - Storage Subsystem 9
 - FASt500 RAID controller 9
- FlashCopy
 - delete 60
 - re-create 64

G

- gaseous contamination 153
- GBIC 81
- general rules, cabling 46
- gigabit interface converter 81

H

- handling static-sensitive devices 58
- hard disk drive model 17
- hard disk drives
 - add new 57, 58
 - add storage enclosures containing 75
 - add used 58

- hard disk drives (*continued*)
 - ID/Model Number 57
 - migrate 59
 - prerequisites 1
 - removal 63
 - will not spin up 57
- hard disk drives, adding 57
- hard disk drives, migrating 57
- hard drives
 - inserting 113
- hardware service and support 147
- help

- center 21
- online 66
- prevent data loss 66
- Host attachment 115
- host group names, unique 60
- host names, unique 60
- host ports, unique 60

I

- IBM 21
- icon
 - Empty Drive 64
 - Failed 64
 - Subsystem Management window 64
- ID
 - conflict LED 82
 - switch location 78
- ID/model number, hard disk drive 57
- identify
 - 1 Gbps FC drives 57
 - firmware updates 9
- ignore
 - configuration data setting 70
- impact of new storage subsystem
 - on identification 123
 - on premium features 123
- import array 64
- import drives 3
- important notices x
- IN port 97
- incorrect cabling schemes 102
- insert drives 112
- insert Fibre Channel drives 64
- intermixing DS4000 and DS5000 44
- intermixing EXP395 and EXP810 37
- intermixing EXP5000 and EXP5060 43
- intermixing EXP520 and EXP810 37
- intermixing EXP700s and EXP710s 32
- intermixing EXP810 and EXP5000 storage enclosures 43
- intermixing EXP810, EXP100, EXP710 38
- intermixing storage enclosures 21

L

- LED
 - controller drive loop 81
 - ID conflict 81
 - port bypass 81
- limitations, redeployment 142
- listing
 - DisableDriveMigration.scr script file 71

- listing (*continued*)
 - EnableDriveMigration.scr script file 71
- load script 70, 71
- logical drive
 - backup 60, 80
 - flashcopies, delete 60
 - verify name 60
- Loop Initialization Primitive (LIP) 81
- loss of ESM path redundancy error 81

M

- machine type 1722
 - Model 60U 4, 9
 - Model 60X 4, 9
 - Model 6LU 4, 9
 - Model 6LX 4, 9
- machine type 1740
 - Model 1RU 12
 - Model 1RX 12
- machine type 1742
 - Model 1RU 4, 9
 - Model 1RX 4, 9
 - Model 90U 4, 9
 - Model 90X 4, 9
- machine type 1818
 - Model 51A, 53A 4
- machine type 3542
 - Model 1RU 4, 9
 - Model 1RX 4, 9
 - Model 2RU 4, 9
 - Model 2RX 4, 9
- machine type 3552
 - Model 1RU 4, 9
 - Model 1RX 4, 9
- machine type 3560
 - Model 1RU 12
 - Model 1RX 12
- map drives 71
- maximum
 - allowable drive loop pairs 4
 - allowable drives 4
- menu option
 - Advanced → Reset Controller 70, 71
 - Execute
 - Script 71
 - File → Load Script 70, 71
 - Initialize 64
 - Place → Offline 60, 80
 - Place → Online 64
 - Tools → Verify and Execute 70, 71
- middle of a drive loop
 - connecting storage enclosures 92, 95
- migrate hard disk drives 59
- migrated drives
 - bezels for 77
- migrating arrays 66
- migration to DS4300 Storage Subsystem 121, 122
- migration, storage firmware 116
- mix storage enclosures 28
- mixed configuration
 - EXP710 to EXP810 cabling 41
- model and product ID, determining 19

- model number
 - DS4000 EXP500
 - 1RU 12
 - 1RX 12
 - DS4000 EXP700
 - 1RU 12
 - 1RX 12
 - DS4000 EXP710
 - 710 12
 - DS4100
 - 100 9
 - DS4300
 - 60U 4, 9
 - 60X 4, 9
 - DS4300 Single Controller
 - 6LU 4, 9
 - 6LX 4, 9
 - DS4300 Turbo
 - 60U 4, 9
 - 60X 4, 9
 - DS4400
 - 1RU 4, 9
 - 1RX 4, 9
 - DS4500
 - 90U 4, 9
 - 90X 4, 9
 - DS4800
 - 80x 4
 - 82x 4
 - 84x 4
 - 88x 4
 - DS5000
 - 51A 4
 - 53A 4
 - FAStT200
 - 1RU 4, 9
 - 1RX 4, 9
 - 2RU 4, 9
 - 2RX 4, 9
 - FAStT500
 - 1RU 4, 9
 - 1RX 4, 9
- My Support x

N

- new enclosures, cabling 84
- new storage subsystem impact 123
- notes x
- notes, important 152
- notices 149
 - electronic emission 154
 - FCC, Class A 154
- notices and statements x
- NVSRAM
 - DS4000 Storage Subsystem 9
 - verify level 1, 9
 - version, by controller firmware level 9
- NVSRAM and controller firmware
 - DS4300
 - Storage Subsystem 9
 - Turbo Storage Subsystem 9
 - DS4400 Storage Subsystem 9
 - DS4500 Storage Subsystem 9
 - FAStT200
 - HA Storage Subsystem 9

- NVSRAM and controller firmware
 - (continued)
 - FAStT200 (continued)
 - Storage Subsystem 9
 - FAStT500 RAID controller 9

O

- offline state 64, 80
- online help 66
- online state 64
- optimal state 60, 64, 77, 80, 81
- orientation
 - hard disk drives 64
- OUT port 97

P

- particulate contamination 153
- Physical View pane 13
- place drive online 113
- port bypass LED 81, 82, 97
- premium feature
 - impact of new storage subsystem on 123
- premium feature entitlements 115
- prerequisites
 - adding capacity 1
 - drive migration 1
- prevent
 - data loss 71
 - shock 64, 81
- procedure
 - add new hard disk drives 57
 - add storage enclosures 75
 - disable drive migration settings 70
 - electrostatic discharge (ESD) 57
 - enable drive migration settings 71
 - migrate hard disk drives 59
 - save a module profile report 66
 - save a storage subsystem profile 66
- product ID and model, determining 19
- profile
 - DS4000 Storage Subsystem 66
 - DS5000 Storage Subsystem 66
- purchase
 - entitlements 4

R

- re-enable
 - drive migration settings 58
- Read_Link_Status
 - function 21
- readme 145
- readme file 77
- recommended cabling scheme 102
- redeploying 142
- redistributing data 66
- remote mirror
 - logical drive synchronization 66
 - relationships
 - remove 60
- remove
 - configuration data 70
 - connection 97

- remove (continued)
 - drives 60, 81
 - hard disk drives 63
 - remote mirror relationships 60
 - storage components 57, 59, 75
 - storage enclosure 81
- reordering data 66
- reset
 - controllers 71
 - storage subsystem setting 70, 71
- restore a storage subsystem
 - configuration 66

S

- SAS drive cable loop scheme 88, 94, 99
- SAS drive channel/loop schemes
 - DCS3700 107
 - DS3000 106
- SATA
 - insert drives 64
- Saving a module profile report and state
 - capture information to help prevent data loss 66
- schedule upgrades 77
- script
 - DisableDriveMigration.scr 71
 - editor window 71
 - EnableDriveMigration.scr 71
 - execute 70, 71
 - load 70, 71
- service 145
- service, software 147
- set enclosure ID 29
- set storage enclosure ID 83
- settings
 - disable drive migration
 - become effective 71
 - drive migration
 - disable 70
 - re-enable 58
 - Fibre Channel speed 28
- SFP 81
- shutdown
 - storage enclosure 28
 - storage server 28
- small form-factor pluggable 81
- speed restriction
 - storage enclosure 28
- speed settings
 - drive loop 28
- state
 - Needs Attention 21
 - offline 60, 64, 80
 - online 64
 - optimal 21, 58, 60, 64, 77, 80, 81
- statements and notices x
- static-sensitive devices, handling 58
- storage
 - DS4000 Storage Subsystem profile 1, 66
 - DS5000 Storage Subsystem profile 66
- storage enclosure
 - ID setting 29
- storage enclosure and storage subsystem
 - compatibility 24, 26

- storage enclosure compatibility, mixed 23
- storage enclosure operation, verifying 84
- storage enclosure speed setting 83
- storage enclosure weight 81
- storage enclosures
 - cabling mixed 41
 - ESM firmware level 9
 - ID setting 78, 83
 - speeds restriction 28
- storage enclosures, intermixing 21
- storage enclosures, migrating 79
- Storage Manager
 - installation and support guide 66, 77
 - installation CD 70, 71
- Storage Manager software
 - where to obtain 145
- storage partitioning definitions, view 64
- storage server
 - configuration migration 66
 - controller firmware level 9
 - physical configuration, alter 57, 59, 75
 - status 21
 - upgrade NVSRAM version 9
- storage subsystem
 - identification 123
 - optimal state 21
 - preparing 1
 - restore configuration 66
- storage subsystem and storage enclosure compatibility 24, 26
- storage subsystem behavior 126
- storage subsystem profile
 - restore 66
 - save 1, 66
 - storage 1, 66
- striping data 66
- Subsystem Management window
 - icon 64
- support notifications x
- support, software 147
- supported replacements 118
- switches
 - ID 78
- synchronization
 - remote mirror logical drive 66

T

- taiwan contact 147
- technical assistance 145
- top of a drive loop
 - connecting storage enclosures 100
- top of drive loop, connect storage enclosures 97
- trace cable connections 81
- trademarks 151
- troubleshooting 145
- turning off
 - storage enclosure 28
- turning on
 - storage enclosure 28
 - storage server 28
- turning on, storage enclosure 84

U

- United States electronic emission Class A notice 154
- United States FCC Class A notice 154
- unmount file systems 60, 80
- updates (product updates) x
- upgrade 126
 - schedule 9, 77
 - storage subsystem
 - in configuration 115
- upgrade controller enclosure, alternative procedure 117
- upgrading DS4700, DS4800 134
- used hard disk drives 58

V

- verifying
 - drive migration enable settings 82
- verifying storage enclosure operation 84
- View profile 12

W

- Web site
 - DS4000 documentation x
 - DS4000 support 9
 - DS5000 support 9
- websites
 - list 146
- weight of drive storage enclosure 81
- window
 - Client Subsystem Management 66, 81, 97
 - Enterprise Management 70, 71
 - Load Script file selection 70, 71
 - Read_Link_Status 21
 - Reset Controller 70, 71
 - script editor 70, 71
 - Storage Subsystem Management 60, 64, 70, 71, 80, 112



Part Number: 46W6898

Printed in USA

GA32-0962-05



(1P) P/N: 46W6898

