



IBM DB2 Universal Database for i5/OS
XML Extender Administration and Programming

Version 8.2

SC18-9179-01





IBM DB2 Universal Database for i5/OS
XML Extender Administration and Programming

Version 8.2

SC18-9179-01

Note

Before using this information and the product it supports, please read the general information under "Notices" on page 257.

Second Edition (February 2006)

This edition applies to Version 5 Release 4 of IBM DB2 Database Extenders for i5/OS Version 5 Release 4, 5722-DE1, and to all subsequent releases and modifications until otherwise indicated in new editions. This edition applies only to reduced instruction set computer (RISC) systems.

© Copyright International Business Machines Corporation 1999, 2006. All rights reserved.

US Government Users Restricted Rights – Use, duplication or disclosure restricted by GSA ADP Schedule Contract with IBM Corp.

Contents

Tables	vii
-------------------------	------------

About this guide.	ix
------------------------------------	-----------

Who should use this guide	ix
How to get a current version of this guide	ix
How to use this guide	ix
Highlighting conventions	x

How to read syntax diagrams	xi
--	-----------

Part 1. Introduction 1

Chapter 1. Introduction 3

Introduction to XML Extender	3
XML Documents	3
How XML data is handled in DB2	4
Features of XML Extender	5
XML Extender tutorial lessons	7
Prerequisites	7
Lesson: Storing an XML document in an XML column	8
Lesson: Composing an XML document	17

Part 2. Administration 29

Chapter 2. Administration 31

Administration tools for XML Extender	31
Administration—details	31
The XML operating environment on iSeries.	31
Preparing to administer XML Extender	32
Migrating XML Extender from previous versions	33
Setting up XML Extender samples and the development environment for iSeries.	35
Creating an SQL collection (schema) for the samples	36
Setting up administration tools for iSeries	36
Setting up the tutorial environment for iSeries.	38
XML Extender administration overview	38
Access and storage methods.	39
When to use the XML column method	40
When to use the XML collection method	40
Planning for XML columns	40
Planning for XML collections	42
Validating XML documents automatically	51
Enabling a database for XML	51
Creating an XML table.	52
Storing a DTD in the repository table.	53
Enabling XML columns	54
Planning side tables	57
Indexing side tables	58
Composing XML documents by using SQL mapping	59

Composing XML collections by using RDB_node mapping	62
Decomposing an XML collection by using RDB_node mapping	66

Part 3. Programming 71

Chapter 3. XML columns 73

Managing data in XML columns	73
XML columns as a storage and access method.	73
Defining and enabling an XML column	74
Using indexes for XML column data	75
Storing XML data	76
Default casting functions for storing XML data	77
Storage UDFs for storing XML data	77
Method for retrieving an XML document	78
Retrieving an entire XML document	79
Retrieving element contents and attribute values from XML documents	81
Updating XML data	82
Updating an entire XML document	83
Updating specific elements and attributes of an XML document	83
Methods for searching XML documents	84
Searching the XML document by structure	84
Deleting XML documents.	86
Limitations when invoking functions from Java Database (JDBC).	86

Chapter 4. Managing data in XML collections 89

XML collections as a storage and access method	89
Managing data in XML collections.	90
Preparing to compose XML documents from DB2 data	90
Decomposing XML documents into DB2 UDB data	94
Enabling an XML collection for decomposition	98
Decomposition table size limits.	98
Updating and deleting data in XML collections	99
Updating data in an XML collection	99
Deleting an XML document from an XML collection	100
Searching XML collections	101
Composing XML documents using search criteria	101
Searching for decomposed XML data	102
Mapping schemes for XML collections	102
Requirements for using SQL mapping	105
Requirements for RDB_Node mapping	106
Stylesheets for an XML collection.	109
Location paths	110
Location path syntax	110
Enabling XML collections	112
Disabling XML collections	113

Chapter 5. XML schemas 115

Advantages of using XML schemas instead of DTDs	115
XML schema complexType element	115
Data types, elements and attributes in schemas	116
Simple data types in XML schemas	116
Elements in XML schemas	117
Attributes in XML schemas	117
Examples of an XML schema	117
XML document instance using the schema	118
XML document instance using a DTD	118

Chapter 6. The dxxadm administration command 121

dxxadm command overview	121
Syntax of the dxxadm administration command	121
administration command	121
enable_db option of the dxxadm command	122
disable_db option of the dxxadm command	122
enable_column option of the dxxadm command	123
disable_column option of the dxxadm command	124
enable_collection option of the dxxadm command	125
disable_collection option of the dxxadm command	126

Part 4. Reference 129

Chapter 7. XML Extender user-defined types 131

Chapter 8. XML Extender user-defined functions 133

Types of XML Extender user-defined functions	133
UDT and UDF names for XML Extender	134
Storage functions	134
Storage functions in XML Extender overview	134
XMLCLOBFromFile() function	134
XMLFileFromCLOB() function	135
XMLFileFromVarchar() function	135
XMLVarcharFromFile() function	136
Retrieval functions	137
Retrieval functions in XML Extender	137
Content(): retrieve from XMLFILE to a CLOB	138
Content(): retrieve from XMLVARCHAR to an external server file	139
Content(): retrieval from XMLCLOB to an external server file	140
Extraction functions	141
Extracting functions in XML Extender	141
extractInteger() and extractIntegers()	141
extractSmallint() and extractSmallints()	143
extractDouble() and extractDoubles()	144
extractReal() and extractReals()	145
extractChar() and extractChars()	146
extractVarchar() and extractVarchars()	146
extractCLOB() and extractCLOBs()	148
extractDate() and extractDates()	149
extractTime() and extractTimes()	150

extractTimestamp() and extractTimestamps()	151
Update functions in XML Extender	152
Purpose	152
Syntax	152
Parameters	152
Return type	153
Example	153
Usage	153
Generate unique function	154
Purpose	154
Syntax	154
Return value	154
Example	155
Validation functions	155
SVALIDATE() function	155
DVALIDATE() function	157

Chapter 9. Document access definition (DAD) files 159

Creating a DAD file for XML columns	159
DAD files for XML collections	161
SQL composition	163
RDB node composition	163
Composition from rows that have null values	163
DTD for the DAD file	164
Dynamically overriding values in the DAD file	169

Chapter 10. XML Extender stored procedures 177

XML Extender stored procedures - Overview	177
Calling XML Extender stored procedures	177
XML Extender administration stored procedures	178
XML Extender administration stored procedures - Overview	178
dxxEnableDB() stored procedure	178
dxxDisableDB() stored procedure	179
dxxEnableColumn() stored procedure	180
dxxDisableColumn() stored procedure	181
dxxEnableCollection() stored procedure	182
dxxDisableCollection() stored procedure	182
XML Extender composition stored procedures	183
XML Extender composition stored procedures - Overview	183
dxxGenXML() stored procedure	183
dxxRetrieveXML() stored procedure	187
dxxGenXMLClob stored procedure	190
dxxRetrieveXMLClob stored procedure	192
XML Extender decomposition stored procedures	194
XML Extender decomposition stored procedures - Overview	194
dxxShredXML() stored procedure	194
dxxInsertXML() stored procedure	197

Chapter 11. Extensible stylesheet language transformation (XSLT) 199

Creating an HTML document using an XSLT stylesheet	199
XSLTransformToClob() user-defined function	200
XSLTransformToFile() user-defined function	201

Chapter 12. XML Extender administration support tables	203	Sample DAD file: XML collection: SQL mapping	232
DTD reference table	203	Sample DAD file: XML: RDB_node mapping	234
XML usage table (XML_USAGE)	203		
Chapter 13. Troubleshooting	205	Appendix B. Code page considerations	237
Troubleshooting XML Extender	205	Configuring locale settings	237
Starting the trace for XML Extender	205	Encoding declaration considerations for XML Extender	237
Stopping the trace	206	Consistent encodings and encoding declarations	237
XML Extender UDF return codes	207	Declaring an encoding	238
XML Extender stored procedure return codes	207	Recommendations for preventing inconsistent XML documents	238
SQLSTATE codes and associated message numbers for XML Extender	207	Appendix C. XML Extender limits	239
XML Extender messages	212	XML Extender glossary	243
<hr/>		Index	251
Part 5. Appendixes	227	Notices	257
Appendix A. Samples	229	Trademarks	259
XML DTD sample	229		
XML document sample: getstart.xml	229		
Stylesheet sample: getstart.xsl	230		
Document access definition files	231		
Sample DAD file: XML column	232		

Tables

1.	SALES_TAB table	8	37.	extractReal function parameters	145
2.	List of the XML collection lesson samples	9	38.	extractChar function parameters	146
3.	Elements and attributes to be searched	10	39.	extractVarchar function parameters	147
4.	Side-table columns to be indexed	16	40.	extractCLOB function parameters	148
5.	List of the XML collection lesson samples	21	41.	extractDate function parameters	149
6.	XML Extender stored procedures and commands	32	42.	extractTime function parameters	150
7.	DXXSAMPLES library objects	36	43.	extractTimestamp function parameters	151
8.	The XML Extender UDTs	41	44.	The UDF Update parameters	152
9.	Elements and attributes to be searched	41	45.	Update function rules.	153
10.	The column definitions for the DTD repository table	53	46.	The SVALIDATE parameters	156
11.	The XML Extender storage functions	77	47.	The DVALIDATE parameters	157
12.	The XML Extender default casting functions	77	48.	Department Table	173
13.	The XML Extender storage UDFs	77	49.	Employee Table.	173
14.	The XML Extender retrieval functions.	79	50.	dxxEnableDB() parameters	179
15.	The XML Extender default cast functions	79	51.	dxxDisableDB() parameters	180
16.	The XML Extender extracting functions	82	52.	dxxEnableColumn() parameters	180
17.	Simple location path syntax	111	53.	dxxDisableColumn() parameters	181
18.	The XML Extender's restrictions using location path	111	54.	dxxEnableCollection() parameters	182
19.	dxxadm parameters	121	55.	dxxDisableCollection() parameters	183
20.	enable_db parameters.	122	56.	dxxGenXML() parameters	184
21.	disable_db parameters	123	57.	dxxRetrieveXML() parameters	187
22.	enable_column parameters	124	58.	dxxGenXMLClob parameters	190
23.	disable_column parameters	125	59.	dxxRetrieveXMLClob parameters	193
24.	enable_collection parameters	126	60.	dxxShredXML() parameters	195
25.	disable_collection parameters	126	61.	dxxInsertXML() parameters	197
26.	The XML Extender UDTs	131	62.	XSLTransformDir() parameter descriptions	201
27.	XMLCLOBFromFile parameter	134	63.	DTD_REF table	203
28.	XMLFileFromCLOB() parameters	135	64.	XML_USAGE table	204
29.	XMLFileFromVarchar parameters	136	65.	Trace parameters	206
30.	XMLVarcharFromFile parameter	137	66.	Trace parameters	206
31.	XMLFILE to a CLOB parameter	138	67.	SQLSTATE codes and associated message numbers	207
32.	XMLVarchar to external server file parameters	139	68.	Limits for XML Extender objects	239
33.	XMLCLOB to external server file parameters	140	69.	Limits for user-defined function value	239
34.	extractInteger function parameters	142	70.	Limits for stored procedure parameters	240
35.	extractSmallint function parameters	143	71.	XML Extender limits	240
36.	extractDouble function parameters	144	72.	Limits for XML Extender composition and decomposition	240

About this guide

This section contains the following information:

- “Who should use this guide”
- “How to use this guide”
- “Highlighting conventions” on page x

Who should use this guide

This guide is intended for the following people:

- Those who work with XML data in DB2[®] applications and who are familiar with XML concepts. Readers of this document should have a general understanding of XML and DB2. To learn more about XML, see the following Web site:

<http://www.w3.org/XML>

To learn more about DB2, see the following Web site:

<http://www.ibm.com/software/data/db2/library>

- DB2 database administrators who are familiar with DB2 UDB administration concepts, tools, and techniques.
- DB2 application programmers who are familiar with SQL and with one or more programming languages that can be used for DB2 UDB applications.

How to get a current version of this guide

You can get the latest version of this guide at the XML Extender Web site:

<http://www.ibm.com/software/data/db2/extenders/xmltext/library.html>

How to use this guide

This guide is structured as follows:

Part 1. Introduction

This part provides an overview of the XML Extender and how you can use it in your business applications. It contains a getting-started scenario that helps you get up and running.

Part 2. Administration

This part describes how to prepare and maintain a DB2 UDB database for XML data. Read this part if you need to administer a DB2 UDB database that contains XML data.

Part 3. Programming

This part describes how to manage your XML data. Read this part if you need to access and manipulate XML data in a DB2 UDB application program.

Part 4. Reference

This part describes how to use the XML Extender administration commands, user-defined types, user-defined functions, and stored procedures. It also lists the messages and codes that the XML Extender issues. Read this part if you are familiar with the XML Extender concepts

and tasks, but you need information about a user-defined type (UDT), user-defined function (UDF), command, message, metadata tables, control tables, or code.

Part 5. Appendixes

The appendixes describe the DTD for the document access definition, samples for the examples and getting started scenario, and other IBM® XML products.

Highlighting conventions

This guide uses the following conventions:

Bold text indicates:

- Commands
- Field names
- Menu names
- Push buttons

Italic text indicates

- Variable parameters that are to be replaced with a value
- Emphasized words
- First use of a glossary term

Uppercase letters indicate:

- Data types
- Column names
- Table names

Example text indicates:

- System messages
- Values that you type
- Coding examples
- Directory names
- File names

How to read syntax diagrams

Throughout this book, the syntax of commands and SQL statements is described using syntax diagrams.

Read the syntax diagrams as follows:

- Read the syntax diagrams from left to right, from top to bottom, following the path of the line.

The \blacktriangleright — symbol indicates the beginning of a statement.

The — \blacktriangleright symbol indicates that the statement syntax is continued on the next line.

The \blacktriangleright — symbol indicates that a statement is continued from the previous line.

The — \blacktriangleleft symbol indicates the end of a statement.

Diagrams of syntactical units other than complete statements start with the \blacktriangleright — symbol and end with the — \blacktriangleright symbol.

- Required items appear on the horizontal line (the main path).

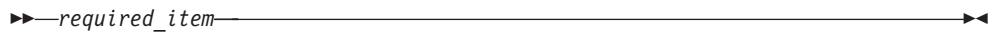

- Optional items appear below the main path.



If an optional item appears above the main path, that item has no effect on the execution of the statement and is used only for readability.

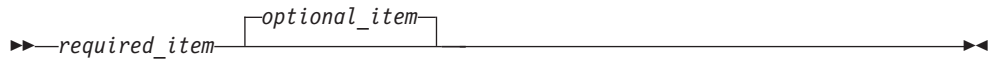

- If you can choose from two or more items, they appear vertically, in a stack. If you *must* choose one of the items, one item of the stack appears on the main path.

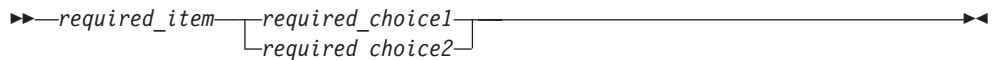

If choosing one of the items is optional, the entire stack appears below the main path.

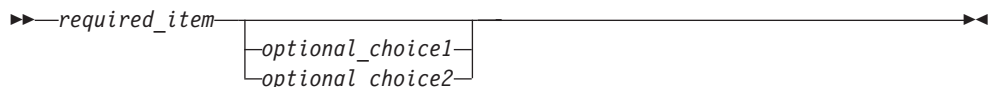

If one of the items is the default, it appears above the main path and the remaining choices are shown below.

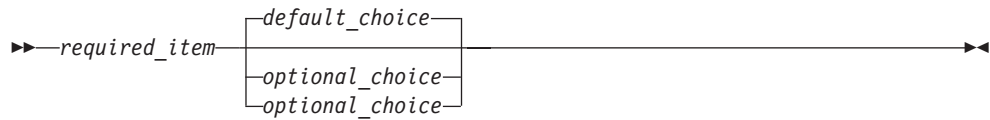

- An arrow returning to the left, above the main line, indicates that an item that can be repeated.



- If the repeat arrow contains punctuation, you must separate repeated items with the specified punctuation.



- A repeat arrow above a stack indicates that you can repeat the items in the stack.
 - Keywords appear in uppercase (for example, `FROM`). In the XML Extender, keywords can be used in any case. Terms that are not keywords appear in lowercase letters (for example, `column-name`). They represent user-supplied names or values.
 - If punctuation marks, parentheses, arithmetic operators, or other such symbols are shown, you must enter them as part of the syntax.

Part 1. Introduction

This part provides an overview of the XML Extender and how you can use it in your business applications.

Chapter 1. Introduction

Introduction to XML Extender

DB2[®]'s XML Extender provides the ability to store and access XML documents, to generate XML documents from existing relational data, and to insert rows into relational tables from XML documents. XML Extender provides new data types, functions, and stored procedures to manage your XML data in DB2 UDB Relational Databases (referred to as "RDB databases" or simply "databases" in this book).

The XML Extender is available for the following operating systems:

- Windows[®] NT
- Windows 2000
- AIX[®]
- Solaris[™] Operating Environment
- Linux
- HP-UX on a PA-RISC 32-bit platform
- HP-UX on a PA-RISC 64-bit platform
- z/OS[™]
- i5/OS[™]

Related concepts:

- "XML Documents" on page 3
- "Features of XML Extender" on page 5
- "XML Extender tutorial lessons" on page 7
- "Lesson: Storing an XML document in an XML column" on page 8
- "Lesson: Composing an XML document" on page 17

XML Documents

Because companies tend to share data between different applications, companies are continually faced with the problem of replicating, transforming, exporting, or saving their data in formats that can be imported into other applications. Many of these transforming processes tend to drop some of the data, or they at least require that users go through the tedious process of ensuring that the data remains consistent. This manual checking consumes both time and money.

One of the ways to address this problem is for application developers to write *Open Database Connectivity (ODBC)* applications, a standard application programming interface (API) for accessing data in both relational and non-relational database management systems. These applications save the data in a database management system. From there, the data can be manipulated and presented in the form in which it is needed for another application. Database applications must be written to convert the data into a form that an application requires. Applications change quickly and quickly become obsolete. Applications that convert data to HTML provide presentation solutions, but the data presented

cannot be practically used for other purposes. A method that separates the data from its presentation is needed to provide a practical form of interchange between applications.

XML—*eXtensible Markup Language*—addresses this problem. XML is extensible because the language is a meta-language that allows you to create your own language based on the needs of your enterprise. You use XML to capture not only the data for your particular application, but also the data structure. Although it is not the only data interchange format, XML has emerged as the accepted standard. By adhering to this standard, applications can share data without first transforming it using proprietary formats.

Because XML is now the accepted standard for data interchange, many applications are emerging that will be able to take advantage of it.

Suppose that you are using a particular project management application and you want to share some of its data with your calendar application. Your project management application could export tasks in XML, which could then be imported as-is into your calendar application. In today's interconnected world, application providers have strong incentives to make an XML interchange format a basic feature of their applications.

How XML data is handled in DB2

Although XML solves many problems by providing a standard format for data interchange, some challenges remain. When building an enterprise data application, you must answer questions such as:

- How often do I want to replicate the data?
- What kind of information must be shared between applications?
- How can I quickly search for the information I need?
- How can I make a particular action, such as a new entry being added, trigger an automatic data interchange between all of my applications?

These kinds of issues can be addressed only by a database management system. By incorporating the XML information and meta-information directly in the database, you can more efficiently obtain the XML results that your other applications need. With the XML Extender, you can take advantage of the power of DB2[®] in many XML applications.

With the content of your structured XML documents in a DB2 UDB database, you can combine structured XML information with traditional relational data. Based on the application, you can choose whether to store entire XML documents in DB2 in user-defined types provided for XML data (XML data types), or you can map the XML content as base data types in relational tables. For XML data types, XML Extender adds the power to search rich data types of XML element or attribute values, in addition to the structural text search that the Net Search Extender provides.

XML Extender provides two methods of storing and access for XML data in DB2:

XML column method

XML collection method

Composes and decomposes contents of XML documents with one or more relational tables.

Features of XML Extender

XML Extender provides the following features to help you manage and exploit XML data with DB2®:

- Administration tools to help you manage the integration of XML data in relational tables
- Storage and access methods for XML data within the database
- A data type definition (DTD) repository for you to store DTDs used to validate XML data
- The ability to validate XML documents using a schema
- A mapping file called the Document Access Definition (DAD), which is used to map XML documents to relational data
- Location paths to specify the location of an element or attribute within an XML document

Administration tools: The XML Extender administration tools help you enable your database and table columns for XML, and map XML data to DB2 relational structures.

You can use the following tools to complete administration tasks for the XML Extender:

- The **dxadm** command can be run from the OS command line.
- Stored procedures can be run from the iSeries Navigator.
- The XML Extender administration stored procedures allow you to invoke administration commands from a program.

Storage and access methods: XML Extender provides two storage and access methods for integrating XML documents with DB2 data structures: XML column and XML collection. These methods have very different uses, but can be used in the same application.

XML column method

This method helps you store intact XML documents in DB2. The XML column method works well for archiving documents. The documents are inserted into columns enabled for XML and can be updated, retrieved, and searched. Element and attribute data can be mapped to DB2 UDB tables (side tables), which can be indexed for fast searches.

XML collection method

This method helps you map XML document structures to DB2 UDB tables so that you can either compose XML documents from existing DB2 UDB data, or decompose XML documents, storing the untagged data in DB2 UDB tables. This method is good for data interchange applications, particularly when the contents of XML documents are frequently updated.

DTDs: The XML Extender also allows you to store DTDs, the set of declarations for XML elements and attributes. When a database is *enabled* for XML, a DTD repository table (DTD_REF) is created. Each row of this table represents a DTD with additional metadata information. Users can access this table to insert their own DTDs. The DTDs are used for validating the structure of XML documents.

DAD files: You specify how structured XML documents are to be processed by XML Extender using a *document access definition (DAD)* file. The DAD file is an XML document that maps the XML document structure to a DB2 UDB table. You

use a DAD file when storing XML documents in a column, or when composing or decomposing XML data. The DAD file specifies whether you are storing documents using the XML column method, or defining an XML collection for composition or decomposition.

Location paths: A *location path* specifies the location of an element or attribute within an XML document. The XML Extender uses the location path to navigate the structure of the XML document and locate elements and attributes.

For example, a location path of `/Order/Part/Shipment/ShipDate` points to the `ShipDate` element, that is a child of the `Shipment`, `Part`, and `Order` elements, as shown in the following example:

```
<Order>
  <Part>
    <Shipment>
      <ShipDate>
+...
```

Figure 1 shows an example of a location path and its relationship to the structure of the XML document.

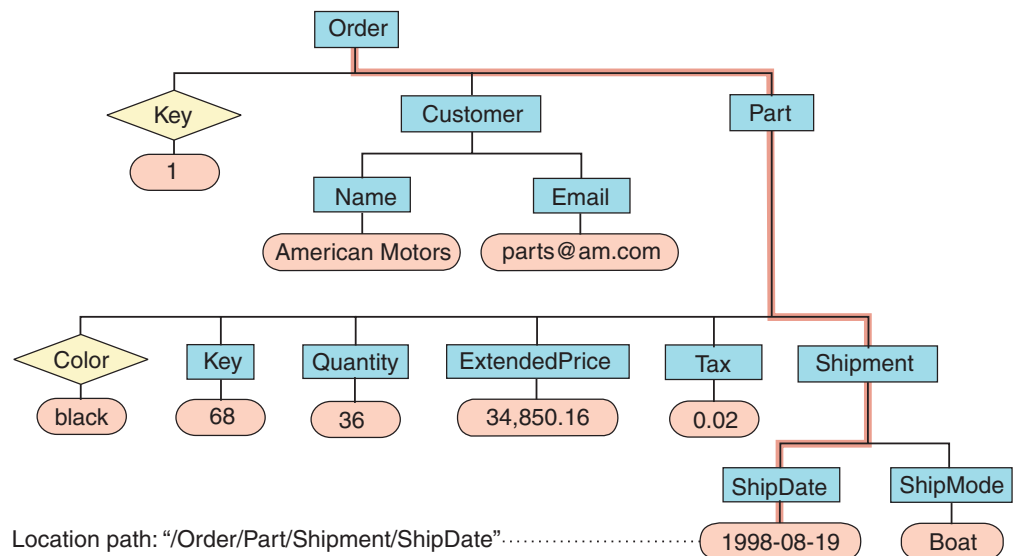

Figure 1. Storing documents as structured XML documents in a DB2 UDB table column

The location path is used in the following situations:

XML columns

- Used to identify the elements and attributes to be extracted or updated when using the XML Extender user-defined functions.
- Also used to map the content of an XML element or attribute to a side table.

XML collections

Used to override values in the DAD file from a stored procedure.

To specify the location path, XML Extender uses a subset of the *XML Path Language (XPath)*, the language for addressing parts of an XML document.

For more information about Xpath, see the following Web page:

<http://www.w3.org/TR/xpath>

Related concepts:

- “How XML data is handled in DB2” on page 4
- “XML Extender tutorial lessons” on page 7
- “Lesson: Storing an XML document in an XML column” on page 8
- “Lesson: Composing an XML document” on page 17

XML Extender tutorial lessons

This tutorial shows you how to get started using XML Extender to access and modify XML data for your applications. Three lessons are provided:

- Storing an XML document in an XML column
- Composing an XML document
- Cleaning up the database

By following the tutorial lessons, you can set up a database using provided sample data, map SQL data to an XML document, store XML documents in the database, and then search and extract data from the XML documents.

In the lessons, you will use XML Extender administration commands, UDFs, and stored procedures. Most of the examples in the rest of the guide draw on the sample data that is used in this section.

In these lessons, you work for ACME Auto Direct, a company that distributes cars and trucks to automotive dealerships.

Prerequisites

To complete the lessons in this tutorial, you must have the following prerequisites installed:

- DB2 Universal Database™ Version 8.2
- Optional: iSeries Navigator to run lesson samples

In addition, you must set up the administration environment. You can use the following environments to complete the Getting Started lessons:

- iSeries Navigator
- OS command line

To use these environments, you must:

1. Restore the sample source code to the samples library. Use the steps in “Unpack and restore sample files and getting started files” on page 35.
2. Restore the XML sample files and the Getting Started executable to an IFS directory. Use the steps in “Unpack and restore sample files and getting started files” on page 35.
3. Create an SQL Schema (collection). Use the steps in “Creating an SQL collection (schema) for the samples” on page 36.
4. Set up the environment from which you will complete the administration tasks.
 - When using the iSeries Navigator - “Setting up the iSeries Navigator interface” on page 37
 - When using the OS command line - “Preparing the sample programs for the iSeries command line” on page 38

Lesson: Storing an XML document in an XML column

The XML Extender provides a method of storing and accessing whole XML documents in the schema. The XML column method enables you to store the document using the XML file types, index the column in side tables, and then query or search the XML document. This storage method is particularly useful for archival applications in which documents are not frequently updated.

This lesson shows you how to use the XML column storage and access method.

The scenario: You have the task of archiving the sales data for the service department. The sales data that you need to work with is stored in XML documents that use the same DTD.

The service department provided a recommended structure for the XML documents and specified which element data will be queried most frequently. The service department wants the XML documents stored in the SALES_TAB table in the SALES_DB schema and wants to be able to search them quickly. The SALES_TAB table will contain two columns with data about each sale, and a third column will contain the XML document. This column is called ORDER.

To store this XML document in the SALES_TAB table, you will:

1. Determine the XML Extender user-defined types (UDTs) in which to store the XML document, as well as which XML elements and attributes will be frequently queried.
2. Set up the SALES_DB schema for XML.
3. Create the SALES_TAB table, and enable the ORDER column so that you can store the intact document in DB2®.
4. Insert a DTD for the XML document for validation.
5. Store the document as an XMLVARCHAR data type.

When you enable the column, you will define side tables to be indexed for the structural search of the document in a document access definition (DAD) file, an XML document that specifies the structure of the side tables.

The SALES_TAB table is described in Table 1. The column to be enabled for XML, ORDER, is shown in italics.

Table 1. SALES_TAB table

Column name	Data type
INVOICE_NUM	CHAR(6) NOT NULL PRIMARY KEY
SALES_PERSON	VARCHAR(20)
<i>ORDER</i>	XMLVARCHAR

The scripts and samples:

For this tutorial, you use a set of scripts to set up your environment and perform the steps in the lessons. The operating system command line scripts are in the dxsamples library. The Navigator SQL Script Files are in the /dxsamples directory.

Table 2 on page 9 lists the samples that are provided to complete the getting started tasks.

Table 2. List of the XML collection lesson samples

Lesson description	OS command line scripts	Navigator SQL Script File
Create and fill SALES_DB tables	C_SALESDB	C_SalesDb.sql
Insert the DTD getstart.dtd into the DTD_REF table	INSERTDTD	InsertDTD.sql
Create SALES_TAB for XML column	C_SALESTAB	C_SalesTab.sql
Add the ORDER column to SALES_TAB	ADDORDER	AddOrder.sql
Enable the ORDER column as an XML column	Manual command described in text	EnableCol.sql
Create indexes on side tables	C_INDEX	C_Index.sql
Insert an XML document into the SALES_TAB XML column	INSERTXML	InsertXML.sql
Query the XML document held in the sales_tab XML column through the side tables	Manual command	QueryCol.sql
Removes sample tables and disables column	D_SALESDB and CLEANUPCLL	CleanupCol.sql

Planning how to store the document:

Before you use the XML Extender to store your documents, you need to:

- Understand the XML document structure.
- Determine the XML user-defined type in which you will store the XML document.
- Determine the XML elements and attributes that the service department will frequently search, so that the content of these can be stored in side tables and indexed to improve performance.

The following sections will explain how to make these decisions.

The XML document structure:

The XML document structure for this lesson takes information for a specific order that is structured by the order key as the top level, then customer, part, and shipping information on the next level.

This lesson provides the sample DTD for you to understand and validate the XML document structure.

Determining the XML data type for the XML column:

The XML Extender provides XML user defined types that you can use to define a column to hold XML documents. These data types are:

XMLVARCHAR

Used for documents smaller than 3 kilobytes stored in DB2. The maximum size of XMLVARCHAR documents can be redefined to as large as 32672 bytes.

XMLCLOB

Used for documents larger than 3 kilobytes stored in DB2. The maximum document size is 2 gigabytes.

XMLFILE

Used for documents stored outside DB2.

In this lesson, you will store a small document in DB2, so you will use the XMLVARCHAR data type.

Determining elements and attributes to be searched:

When you understand the XML document structure and the needs of the application, you can determine which elements and attributes will be searched or extracted most frequently, or those that will be the most expensive to query. The service department will frequently query the order key, customer name, price, and shipping date of an order, and they will need quick performance for these searches. This information is contained in elements and attributes of the XML document structure. Table 3 describes the location paths of each element and attribute.

Table 3. Elements and attributes to be searched

Data	Location Path
order key	/Order/@Key
customer name	/Order/Customer/Name
price	/Order/Part/ExtendedPrice
shipping date	/Order/Part/Shipment/ShipDate

Mapping the XML document to the side tables:

To map your XML documents to a side table, you must create a DAD file for the XML column. The DAD file is used to store the XML document in DB2. It also maps the XML element and attribute contents to DB2 UDB side tables used for indexing, which improves search performance.

After identifying the elements and attributes to be searched, you determine how they should be organized in the side tables, how many tables to use, and which columns are in what table. Organize the side tables by putting similar information in the same table. The document structure is also determined by whether the location path of any elements can be repeated more than once in the document. For example, in the document, the part element can be repeated multiple times, and therefore, the price and date elements can occur multiple times. Elements that can occur multiple times must each be in their own side tables.

You must also determine what DB2 UDB base types the element or attribute values should use, which is determined by the format of the data.

- If the data is text, use VARCHAR.
- If the data is an integer, use INTEGER.
- If the data is a date, and you want to do range searches, use DATE.

In this tutorial, the elements and attributes are mapped to either ORDER_SIDE_TAB, PART_SIDE_TAB or, SHIP_SIDE_TAB. The tables below show which table each element or attribute is mapped to.

ORDER_SIDE_TAB

Column name	Data type	Location path	Multiple occurring?
ORDER_KEY	INTEGER	/Order/@Key	No
CUSTOMER	VARCHAR(16)	/Order/Customer/Name	No

PART_SIDE_TAB

Column name	Data type	Location path	Multiple occurring?
PRICE	DECIMAL(10,2)	/Order/Part/ExtendedPrice	Yes

SHIP_SIDE_TAB

Column name	Data type	Location path	Multiple occurring?
DATE	DATE	/Order/Part/Shipment/ShipDate	Yes

Enabling the server:

To store XML information in the database, you need to enable it for the XML Extender. When you enable a database for XML, XML Extender:

- Creates user-defined types (UDTs), user-defined functions (UDFs), and stored procedures
- Creates and populates control tables with the necessary metadata that the XML Extender requires
- Creates the DB2XML schema and assigns the necessary privileges

To enable the database for XML:

Use one of the following methods to enable the database.

- **Navigator:** Enter the command:
Run EnableDB.sql
- **OS command line:** Enter:
CALL PGM(QDBXM/QZXADM) PARM(enable_db dbname)
Where *dbname* is the name of your database.

Creating and populating the SALES_DB tables:

To set up the lesson environment, create and populate the SALES_DB tables. These tables contain the tables described in the planning sections.

To create the tables, use one of the following methods:

- **Navigator:** Enter the command:
Run C_SalesDb.sql
- **OS command line:** Enter the following command:
RUNSQLSTM SRCFILE(DXXSAMPLES/SQLSTMT)
SRCMBR(C_SALESDB) NAMING(*SQL)

Enabling the XML column and storing the document:

In this lesson, you will enable a column for XML Extender and store an XML document in the column. For these tasks, you will:

1. Store the DTD in the DTD repository.
2. Create a DAD file for the XML column.
3. Create the SALES_TAB table.
4. Add the column of XML type .
5. Enable the XML column.
6. View the column and side tables.
7. Index the side tables for structural search.
8. Store the XML document.
9. Query the XML document.

Storing the DTD in the DTD repository:

You can use a DTD to validate XML data in an XML column. The XML Extender creates a table in the XML-enabled database, called DTD_REF. The table is known as the DTD repository and is available for you to store DTDs. When you validate XML documents, you must store the DTD in this repository. The DTD for this lesson is in

/dxxsamples/dtd/getstart.dtd

- **Navigator:** Enter the command

Run InsertDTD.sql

- **OS command line:** Enter:

```
RUNSQLSTM SRCFILE(DXXSAMPLES/SQLSTMT)
          SRCMBR(INSERTDTD) NAMING(*SQL)
```

Creating a DAD file for the XML column:

This section explains how you create a DAD file for the XML column. In the DAD file, you specify that the access and storage method you are using is XML column. In the DAD file you define the tables and columns for indexing.

In the following steps, elements in the DAD are referred to as *tags* and the elements of your XML document structure are referred to as *elements*. A sample of a DAD file similar to the one you will create is in

/dxxsamples/dad/getstart_xcolumn.dad. It has some minor differences from the file generated in the following steps. If you use it for the lesson, the file paths might be different than for your environment; the <validation> value is set to NO, rather than YES.

To create a DAD file for use with XML column:

1. Open a text editor and name the file getstart_xcolumn.dad
All the tags used in the DAD file are case sensitive.
2. Create the DAD header, with the XML and the DOCTYPE declarations.

```
<?xml version="1.0"?>
<!DOCTYPE DAD SYSTEM " /dxxsamples/dtd/dad.dtd">
```

The DAD file is an XML document and requires XML declarations.

3. Insert start and end (<DAD> and</DAD>) tags for the document. All other tags are located inside these tags.
4. Insert start and end (<DTDID> and</DTDID>) tags with a DTD ID to specify a DTD if the document will be validated:

```
<dtdid> /dxxsamples/dtd/getstart.dtd</dtdid>
```

Verify that this string matches the value used as the first parameter value when you insert the DTD in the DTD repository table. For example, the path that you use for the DTDID might be different from the string you inserted in the DTD reference table if you are working on a different system drive.

5. Insert start and end (<validation> and </validation>) tags and a keyword YES or NO to indicate whether you want XML Extender to validate the XML document structure using the DTD that you inserted into the DTD reference table. For example:

```
<validation>YES</validation>
```

The value of <validation> can be in mixed case.

6. Insert start and end (<Xcolumn> and </Xcolumn>) tags to specify that the storage method is XML column.
7. Create side tables. For each side table that you want to create:
 - a. Insert start and end (<table> and </table>) tags for each side table that is to be generated, and specify the name of the side table in double quotation marks using the "name=" attribute as shown here:

```
<Xcolumn>
<table name="order_side_tab">
</table>
<table name="part_side_tab">
</table>
<table name="ship_side_tab">
</table>
</Xcolumn>
```

- b. Inside the table tags, insert a <column> tag for each column that you want the side table to contain. Each column has four attributes: name, type, path, and multi_occurrence:

name Specifies the name of the column that is created in the side table.

type Indicates the data type in the side table for each indexed element or attribute.

path Specifies the location path in the XML document for each element or attribute to be indexed.

multi_occurrence

Indicates whether the element or attribute referred to by the path attribute can occur more than once in the XML document. The possible values for *multi_occurrence* are *YES* or *NO*. If the value is *NO*, then you can mention more than one column tag in the side table. If the value is *YES*, you can mention only one column in the side table.

```
<Xcolumn>
<table name="order_side_tab">
  <column name="order_key"
    type="integer"
    path="/Order/@Key"
    multi_occurrence="NO"/>
  <column name="customer"
    type="varchar(50)"
    path="/Order/Customer/Name"
    multi_occurrence="NO"/>
</table>
<table name="part_side_tab">
  <column name="price"
    type="decimal(10,2)"
    path="/Order/Part/ExtendedPrice">
```

```

        multi_occurrence="YES"/>
</table>
<table name="ship_side_tab">
  <column name="date"
    type="DATE"
    path="/Order/Part/Shipment/ShipDate"
    multi_occurrence="YES"/>
</table>
</Xcolumn>

```

8. Ensure that you have the necessary end tags:
 - A closing </Xcolumn> tag after the last </table> tag
 - A closing </DAD> tag after the </Xcolumn> tag
9. Save the file with the following name:

```
getstart_xcolumn.dad
```

You can compare the file that you just created with the sample file, /dxxsamples/dad/getstart_xcolumn.dad. This file is a working copy of the DAD file required to enable the XML column and create the side tables. The sample files contain references to files that use absolute path names. Check the sample files and change these values for your directory paths.

Creating the SALES_TAB table:

In this section you create the SALES_TAB table. Initially, it has two columns with the sale information for the order.

To create the table:

Enter the following CREATE TABLE statement using one of the following methods:

- **Navigator:** Enter the command:

```
Run C_SalesTab.sql
```
- **OS command line:** Enter:

```
RUNSQLSTM SRCFILE(DXXSAMPLES/SQLSTMT)
          SRCMBR(C_SALESTAB) NAMING(*SQL)
```

Adding the column of XML type:

Add a new column to the SALES_TAB table. This column will contain the intact XML document that you generated earlier and must be of an XML UDT. The XML Extender provides multiple data types. In this lesson, you will store the document as XMLVARCHAR.

To add the column of XML type:

Run the SQL ALTER TABLE statement using one of the following three methods:

- **Navigator:** Enter the command:

```
Run AddOrder.sql
```
- **OS command line:** Enter:

```
RUNSQLSTM SRCFILE(DXXSAMPLES/SQLSTMT)
          SRCMBR(ADDORDER) NAMING(*SQL)
```

Enabling the XML column:

After you create the column of XML type, you enable it for XML Extender. When you enable the column, XML Extender reads the DAD file and creates the side tables. Before enabling the column, you must:

- Determine whether you want to create a default view of the XML column, which contains the XML document joined with the side-table columns. You can specify the default view when querying the XML document. In this lesson, you will specify a view with the `-v` parameter.
- Determine whether you want to specify a primary key as the *ROOT ID*, the column name of the primary key in the application table and a unique identifier that associates all side tables with the application table. If you do not specify a primary key, XML Extender adds the `DXXROOT_ID` column to the application table, and to the side tables.

The `ROOT_ID` column is used as key to tie the application and side tables together, which allows the XML Extender to automatically update the side tables if the XML document is updated. In this lesson, you will specify the name of the primary key in the command (`INVOICE_NUM`) with the `-r` parameter. The XML Extender will then use the specified column as the `ROOT_ID` and add the column to the side tables.

To enable the column for XML:

Run the `dxadm enable_column` command, using one of the following three methods:

- **Navigator:** Enter the command:

```
Run EnableCol.sql
```

- **OS command line:** Enter:

```
CALL QDBXM/QZXMADM PARM(enable_column dbname  
Sales_Tab Order  
'/dxxsamples/dad/getstart_xcolumn.dad' '-v'  
sales_order_view '-r' invoice_num)
```

Where *dbname* is the name of your database.

The XML Extender creates the side tables with the `INVOICE_NUM` column and creates the default view.

Important: Do not modify the side tables in any way. Updates to the side tables should only be made through updates to the XML document itself. The XML Extender will automatically update the side tables when you update the XML document in the XML column.

Viewing the column and side tables:

When you enabled the XML column, you created a view of the XML column and side tables. You can use this view when working with the XML column.

To view the XML column and side-table columns:

Submit the following SQL `SELECT` statement from the DB2 UDB command line:

```
SELECT * FROM SALES_ORDER_VIEW
```

The view shows the columns in the side tables, as specified in the `getstart_xcolumn.dad` file.

Indexing side tables for structural search:

Creating indexes on side tables allows you to do fast structural searches of the XML document. In this section, you create indexes on key columns in the side tables that were created when you enabled the XML column, ORDER. The service department has specified which columns their employees are likely to query most often. Table 4 describes these columns that you will index.

Table 4. Side-table columns to be indexed

Column	Side table
ORDER_KEY	ORDER_SIDE_TAB
CUSTOMER	ORDER_SIDE_TAB
PRICE	PART_SIDE_TAB
DATE	SHIP_SIDE_TAB

To index the side tables:

Run the following CREATE INDEX SQL commands using one of the following three methods:

- **Navigator:** Enter the command:

```
Run C_Index.sql
```

- **OS command line:** Enter:

```
RUNSQLSTM SRCFILE(DXXSAMPLES/SQLSTMT)
SRCMBR(C_INDEX) NAMING(*SQL)
```

Storing the XML document:

Now that you enabled a column that can contain an XML document and indexed the side tables, you can store the document using the functions that the XML Extender provides. When storing data in an XML column, you either use default casting functions or XML Extender UDFs. Because you will be storing an object of the base type VARCHAR in a column of the XML UDT XMLVARCHAR, you will use the default casting function.

To store the XML document:

1. Open the XML document `/dxxsamples/xml/getstart.xml`. Ensure that the file path in the DOCTYPE matches the DTD ID specified in the DAD and when inserting the DTD in the DTD repository. You can verify they match by querying the DB2XML.DTD_REF table and by checking the DTDID element in the DAD file. If you are using a different drive and directory structure than the default, you need to change the path in the DOCTYPE declaration to match your directory structure.
2. Run the SQL INSERT command, using one of the following methods:

- **Navigator:** Enter the command:

```
Run InsertXML.sql
```

- **OS command line:** Enter:

```
RUNSQLSTM SRCFILE(DXXSAMPLES/SQLSTMT)
SRCMBR(INSERTXML) NAMING(*SQL)
```

Verify that the tables have been updated. Run the following SELECT statements for the tables from the command line.

```
SELECT * FROM SALES_TAB
SELECT * FROM PART_SIDE_TAB
SELECT * FROM ORDER_SIDE_TAB
SELECT * FROM SHIP_SIDE_TAB
```

Querying the XML document:

You can search the XML document with a direct query against the side tables. In this step, you will search for all orders that have a price over 2500.00.

To query the side tables:

Run the SQL SELECT statement, using one of the following methods:

- **Navigator:** Enter the command:

```
Run QueryCol.sql
```

- **DB2 command line:**

Enter:

```
select distinct sales_person from schema.sales_tab S,
part_side_tab P where price > 2500.00
and S.invoice_num = P.invoice_num;
```

Where *schema* is the schema name that you created in “Creating an SQL collection (schema) for the samples” on page 36.

The result set should show the names of the salespeople who sold an item that had a price greater than 2500.00.

You have completed the getting started tutorial for storing XML documents in DB2 UDB tables. For Example:

```
SALES_PERSON
```

```
-----
```

```
Sriram Srinivasan
```

Related concepts:

- “Managing data in XML columns” on page 73
- “XML Extender tutorial lessons” on page 7

Lesson: Composing an XML document

This lesson teaches you how to compose an XML document from existing DB2® data.

The scenario:

You have the task of taking information in an existing purchase order database, SALES_DB, and extracting requested information from it to be stored in XML documents. The service department will then use these XML documents when working with customer requests and complaints. The service department has requested specific data to be included and has provided a recommended structure for the XML documents.

Using existing data, you will compose an XML document, `getstart.xml`, from data in these tables.

To compose an XML document, you will plan and create a DAD file that maps columns from the related tables to an XML document structure that provides a purchase order record. Because this document is composed from multiple tables, you will create an XML collection and associate these tables with an XML structure and a DTD. You use this DTD to define the structure of the XML document. You can also use it to validate the composed XML document in your applications.

The existing database data for the XML document is described in the following tables. The column names with an asterisk are columns that the service department has requested in the XML document structure.

ORDER_TAB

Column name	Data type
ORDER_KEY *	INTEGER
CUSTOMER	VARCHAR(16)
CUSTOMER_NAME *	VARCHAR(16)
CUSTOMER_EMAIL *	VARCHAR(16)

PART_TAB

Column name	Data type
PART_KEY *	INTEGER
COLOR *	CHAR(6)
QUANTITY *	INTEGER
PRICE *	DECIMAL(10,2)
TAX *	REAL
ORDER_KEY	INTEGER

SHIP_TAB

Column name	Data type
DATE *	DATE
MODE *	CHAR(6)
COMMENT	VARCHAR(128)
PART_KEY	INTEGER

Planning:

Before you use the XML Extender to compose your documents, you need to determine the structure of the XML document and how it corresponds to the structure of your database data. This section provides an overview of the XML document structure that the service department requested, and the DTD that you will use to define the structure of the XML document. This section also shows how this document maps to the columns that contain the data used to populate the documents.

Determining the document structure:

The XML document structure takes information for a specific order from multiple tables and creates an XML document for the order. These tables each contain

related information about the order and can be joined on their key columns. The service department wants a document that is structured by the order number as the top level, and then customer, part, and shipping information. The service department wants the document structure to be intuitive and flexible, with elements that describe the data rather than the structure of the document. (For example, the customer's name should be in an element called "customer," rather than a paragraph.)

After you design the document structure, you create a DTD to describe the structure of the XML document. This lesson provides an XML document and a DTD for you. Using the rules of the DTD, and the hierarchical structure of the XML document, you can create a hierarchical map of your data, as shown in Figure 2.

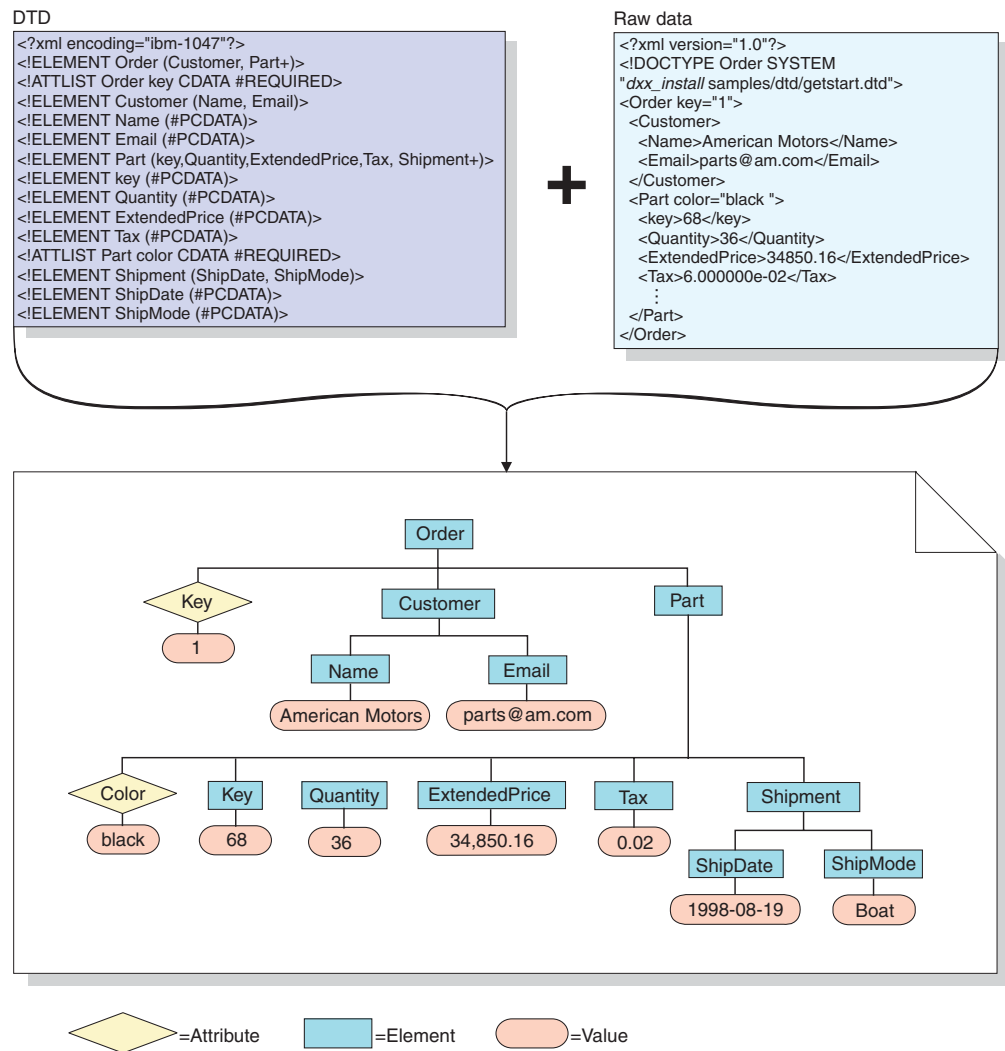

Figure 2. The hierarchical structure of the DTD and XML document

Mapping the XML document and database relationship:

After you design the structure and create the DTD, you need to show how the structure of the document relates to the DB2 UDB tables that you will use to

populate the elements and attributes. You can map the hierarchical structure to specific columns in the relational tables, as shown in Figure 3.

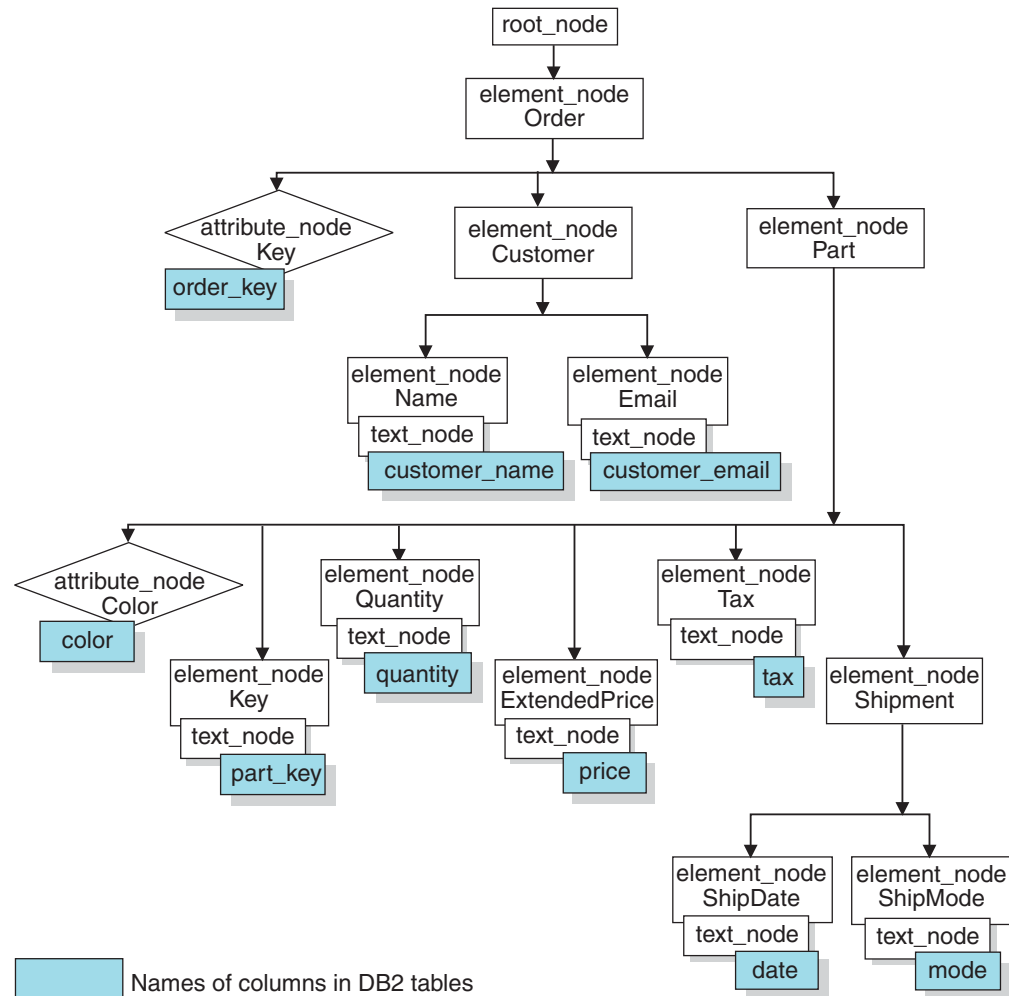

Figure 3. XML document mapped to relational table columns

This figure uses nodes to show elements, attributes, and text within the XML document structure. These nodes are used in the DAD file and are explained more fully in later steps.

Use this relationship description to create DAD files that define the relationship between the relational data and the XML document structure.

In this tutorial, you will be creating a DAD file for the XML collection used to compose the document. The XML collection DAD file maps the tables with existing data to the XML document structure.

To create the XML collection DAD file, you need to understand how the XML document corresponds to the database structure, as described in Figure 3, so that you can describe from what tables and columns the XML document structure derives data for elements and attributes. You will use this information to create the DAD file for the XML collection.

The scripts and samples:

This lesson provides a set of scripts for you to use to set up your environment. The OS command line scripts are in the dxsamples library. The Navigator SQL Script Files are in the /dxsamples directory.

Table 5 lists the samples that are provided to complete the getting started tasks.

Table 5. List of the XML collection lesson samples

Lesson description	OS command line scripts	Navigator SQL Script File
Create and fill SALES_DB tables	C_SALESDB	C_SalesDb.sql
Composes an XML document and returns it to a result table	Manual command	Genxml_sql.sql
Removes sample tables and disables column	D_SALESDB and CLEANUPCOL	CleanupCllcc.sql

Setting up the lesson environment:

If you have already completed the first lesson "Store an XML document in an XML column", skip to 22.

In this section, you:

- Enable the database.
- Create and populate the tables used for the lessons.

Enabling the database:

To store XML information in the database, you need to enable it for the XML Extender. When you enable a database for XML, the XML Extender:

- Creates the user-defined types (UDTs), user-defined functions (UDFs), and stored procedures.
- Creates and populates control tables with the necessary metadata that the XML Extender requires.
- Creates the DB2XML schema and assigns the necessary privileges.

Important: If you completed the XML column lesson and did not clean up your environment, you might be able skip this step.

To enable the database for XML, use one of the following methods:

- **Navigator:** Enter the command:

```
Run EnableDB.sql
```

- **OS command line:** Enter:

```
CALL PGM(QDBXM/QZXADM) PARM(enable_db
  dbname)
```

Where dbname is the name of your database.

Creating and populating the SALES_DB tables:

To set up the lesson environment, create and populate the SALES_DB tables. These tables contain the tables described in the planning sections.

To create the tables:

- **Navigator:** Run `C_SalesDb.sql`
- **(iSeries) OS command line:** Enter the following command:

```
RUNSQLSTM SRCFILE(DXXSAMPLES/SQLSTMT)
          SRCMBR(C_SALESDB) NAMING(*SQL)
```

Creating the DAD file for the XML collection:

Because the data already exists in multiple tables, you will create an XML collection, which associates the tables with the XML document. You define the collection by creating a DAD file.

In this section, you create the mapping scheme in the DAD file that specifies the relationship between the tables and the structure of the XML document.

In the following steps, elements in the DAD are referred to as *tags* and the elements of your XML document structure are referred to as *elements*. A sample of a DAD file similar to the one you will create is in `/dxxsamples/dad/getstart_xcollection.dad`.

It has some minor differences from the file generated in the following steps. If you use it for the lesson, note that the file paths might be different than in your environment and you might need to update the sample file.

To create the DAD file for composing an XML document:

1. From the `/dxxsamples/xml` directory, open a text editor and create a file called `getstart_xcollection.dad`.
2. Create the DAD header, using the following text:

```
<?xml version="1.0"?>
<!DOCTYPE DAD SYSTEM "/dxxsamples/dtd/dad.dtd">
```
3. Insert the `<DAD></DAD>` tags. All other tags are located inside these tags.
4. Specify `<validation></validation>` tags to indicate whether the XML Extender validates the XML document structure when you insert a DTD into the DTD repository table. This lesson does not require a DTD and the value is **NO**.

```
<validation>NO</validation>
```

The value of the `<validation>` tags can be mixed case.

5. Use the `<Xcollection></Xcollection>` tags to define the access and storage method as XML collection. The access and storage methods define that the XML data is stored in a collection of DB2 UDB tables.

```
<Xcollection>
</Xcollection>
```
6. After the `<Xcollection>` tag, provide an SQL statement to specify the tables and columns used for the XML collection. This method is called SQL mapping and is one of two ways to map relational data to the XML document structure. Enter the following statement:

```
<Xcollection
<SQL_stmt>
  SELECT o.order_key, customer_name, customer_email, p.part_key, color,
  quantity, price, tax, ship_id, date, mode from order_tab o, part_tab p,
  (select db2xml.generate_unique()
as ship_id, date, mode, part_key from ship_tab) as s
  WHERE o.order_key = 1 and
  p.price > 20000 and
  p.order_key = o.order_key and
```

```

        s.part_key = p.part_key
    ORDER BY order_key, part_key, ship_id
</SQL_stmt>
</Xcollection>

```

This SQL statement uses the following guidelines when using SQL mapping. See Figure 3 on page 20 for the document structure.

- Columns are specified in top-down order, by the hierarchy of the XML document structure. For example, the columns for the order and customer elements are first, those for the part element are second, and those for the shipment are third.
 - The columns for a repeating section, or nonrepeating section, of the template that requires data from the database are grouped together. Each group has an object ID column: ORDER_KEY, PART_KEY, and SHIP_ID.
 - The object ID column is the first column in each group. For example, O.ORDER_KEY precedes the columns related to the key attribute and p.PART_KEY precedes the columns for the Part element.
 - The SHIP_TAB table does not have a single key conditional column, and therefore, the generate_unique user-defined function is used to generate the SHIP_ID column.
 - The object ID columns are then listed in top-down order in an ORDER BY statement. The columns in ORDER BY are not qualified by any schema and table name, and they match the column names in the SELECT clause.
7. Add the following prolog information to be used in the composed XML document:

```
<prolog?xml version="1.0"?></prolog>
```

This exact text is required for all DAD files.

8. Add the <doctype></doctype> tags to be used in the XML document you are composing. The <doctype> tag contains the path to the DTD stored on the client.

```
<doctype>!DOCTYPE Order SYSTEM
"/dxxsamples/dtd/getstart.dtd"</doctype>
```

9. Define the root element of the XML document using the <root_node></root_node> tags. Inside the root_node, specify the elements and attributes that make up the XML document.
10. Map the XML document structure to the DB2 UDB relational table structure using the following three types of nodes:

element_node

Specifies the element in the XML document. Element_nodes can have child element_nodes.

attribute_node

Specifies the attribute of an element in the XML document.

text_node

Specifies the text content of the element and the column data in a relational table for bottom-level element_nodes.

Figure 3 on page 20 shows the hierarchical structure of the XML document and the DB2 UDB table columns, and indicates what kinds of nodes are used. The shaded boxes indicate the DB2 UDB table column names from which the data will be extracted to compose the XML document.

To add each type of node, one type at a time:

- a. Define an <element_node> tag for each element in the XML document.

```

<root_node>
<element_node name="Order">
  <element_node name="Customer">
    <element_node name="Name">
    </element_node>
    <element_node name="Email">
    </element_node>
  </element_node>
  <element_node name="Part">
    <element_node name="key">
    </element_node>
    <element_node name="Quantity">
    </element_node>
    <element_node name="ExtendedPrice">
    </element_node>
    <element_node name="Tax">
    </element_node>
    <element_node name="Shipment" multi_occurrence="YES">
      <element_node name="ShipDate">
      </element_node>
      <element_node name="ShipMode">
      </element_node>
    </element_node> <!-- end Shipment -->
  </element_node> <!-- end Part -->
</element_node> <!-- end Order -->
</root_node>

```

The <Shipment> child element has an attribute of multi_occurrence=YES. This attribute is used for elements without an attribute, that are repeated in the document. The <Part> element does not use the multi-occurrence attribute because it has an attribute of color, which makes it unique.

- b. Define an <attribute_node> tag for each attribute in your XML document. These attributes are nested in the appropriate element_node. The added attribute_nodes are highlighted in bold:

```

<root_node>
<element_node name="Order">
  <attribute_node name="key">
  </attribute_node>
  <element_node name="Customer">
    <element_node name="Name">
    </element_node>
    <element_node name="Email">
    </element_node>
  </element_node>
  <element_node name="Part">
    <attribute_node name="color">
    </attribute_node>
    <element_node name="key">
    </element_node>
    <element_node name="Quantity">
    </element_node>
  </element_node>
  ...
  </element_node> <!-- end Part -->
</element_node> <!-- end Order -->
</root_node>

```

- c. For each bottom-level element_node, define <text_node> tags to indicate that the XML element contains character data to be extracted from DB2 UDB when the document is composed.

```

<root_node>
<element_node name="Order">
  <attribute_node name="key">
  </attribute_node>

```

```

<element_node name="Customer">
  <element_node name="Name">
    <text_node>
    </text_node>
  </element_node>
  <element_node name="Email">
    <text_node>
    </text_node>
  </element_node>
</element_node>
<element_node name="Part">
  <attribute_node name="color">
  </attribute_node>
  <element_node name="key">
    <text_node>
    </text_node>
  </element_node>
  <element_node name="Quantity">
    <text_node>
    </text_node>
  </element_node>
  <element_node name="ExtendedPrice">
    <text_node>
    </text_node>
  </element_node>
  <element_node name="Tax">
    <text_node>
    </text_node>
  </element_node>
  <element_node name="Shipment" multi_occurrence="YES">
    <element_node name="ShipDate">
      <text_node>
      </text_node>
    </element_node>
    <element_node name="ShipMode">
      <text_node>
      </text_node>
    </element_node>
  </element_node> <!-- end Shipment -->
</element_node> <!-- end Part -->
</element_node> <!-- end Order -->
</root_node>

```

- d. For each bottom-level `element_node`, define a `<column/>` tag. These tags specify from which column to extract data when composing the XML document and are typically inside the `<attribute_node>` or the `<text_node>` tags. The columns defined in the `<column/>` tag must be in the `<SQL_stmt>` `SELECT` clause.

```

<root_node>
<element_node name="Order">
  <attribute_node name="key">
    <column name="order_key"/>
  </attribute_node>
  <element_node name="Customer">
    <element_node name="Name">
      <text_node>
        <column name="customer_name"/>
      </text_node>
    </element_node>
    <element_node name="Email">
      <text_node>
        <column name="customer_email"/>
      </text_node>
    </element_node>
  </element_node>
  <element_node name="Part">

```

```

<attribute_node name="color">
  <column name="color"/>
</attribute_node>
<element_node name="key">
  <text_node>
    <column name="part_key"/>
  </text_node>
<element_node name="Quantity">
  <text_node>
    <column name="quantity"/>
  </text_node>
</element_node>
<element_node name="ExtendedPrice">
  <text_node>
    <column name="price"/>
  </text_node>
</element_node>
<element_node name="Tax">
  <text_node>
    <column name="tax"/>
  </text_node>
</element_node>
<element_node name="Shipment" multi_occurrence="YES">
  <element_node name="ShipDate">
    <text_node>
      <column name="date"/>
    </text_node>
  </element_node>
  <element_node name="ShipMode">
    <text_node>
      <column name="mode"/>
    </text_node>
  </element_node>
</element_node> <!-- end Shipment -->
</element_node> <!-- end Part -->
</element_node> <!-- end Order -->
</root_node>

```

11. Ensure that you have the necessary end tags:

- An ending `</root_node>` tag after the last `</element_node>` tag
- An ending `</Xcollection>` tag after the `</root_node>` tag
- An ending `</DAD>` tag after the `</Xcollection>` tag

12. Save the file as `getstart_xcollection.dad`.

You can compare the file that you created with the sample file `/dxxsamples/dad/getstart_xcollection.dad`. This file is a working copy of the DAD file required to compose the XML document. The sample file contains location paths and file path names that might need to be changed to match your environment to be run successfully.

In your application, if you will use an XML collection frequently to compose documents, you can define a collection name by enabling the collection. Enabling the collection registers it in the XML_USAGE table and helps improve performance when you specify the collection name (rather than the DAD file name) when running stored procedures. In these lessons, you do not enable the collection.

Composing the XML document:

In this step, you use the `dxxGenXML()` stored procedure to compose the XML document specified by the DAD file. This stored procedure returns the document as an XMLVARCHAR UDT.

To compose the XML document:

Use one of the following methods:

- **Navigator:** Run **Genxml_sql.sql**

- **OS command line:** Enter:

```
CALL DXXSAMPLES/GENX PARM(dbName'/dxxsamples  
/dad/getstart_xcollection.dad' result_tab doc ' ')
```

Where *dbName* is the name of your relational database.

Tip: This step teaches you how to generate one or more composed XML documents using DB2 UDB stored procedure's result set feature. Using a result set allows you to fetch multiple rows to generate more than one document. When you generate each document, you can export it to a file. This method is the simplest way to demonstrate using result sets. For more efficient ways of fetching data, see the CLI examples in the DXXSAMPLES/QCSRC source file.

Cleaning up the tutorial environment:

If you want to clean up the lesson environment, you can run one of the provided scripts or enter the commands from the command line to:

- Disable the XML column, ORDER.
- Drop tables created in the lessons.
- Delete the DTD from the DTD repository table.

You might receive error messages if you have not completed both lessons in this section. You can ignore these errors.

To clean up the tutorial environment:

Run the cleanup command files, using one of the following methods:

Navigator:

- To clean up the XML column environment, run **CleanupCol.sql**
- To clean up the XML collection environment, run **CleanupCllec.sql**

OS command line:

- To clean up the XML column environment:

1. Enter:

```
RUNSQLSTM SRCFILE(DXXSAMPLES/SQLSTMT)  
SRCMBR(D_SALESDB) NAMING(*SQL)
```

2. Enter:

```
CALL PGM(QDBXM/QZXADM)  
PARM(disable_column &DBNAME Sales_Tab Order)
```

3. Enter:

```
RUNSQLSTM SRCFILE(DXXSAMPLES/SQLSTMT)  
SRCMBR(CLEANUPCOL) NAMING(*SQL)
```

- To clean up the XML collection environment, enter:

```
RUNSQLSTM SRCFILE(DXXSAMPLES/SQLSTMT)  
SRCMBR(D_SALESDB) NAMING(*SQL)
```

Related concepts:

- "Managing data in XML collections" on page 90

- “XML Extender tutorial lessons” on page 7

Part 2. Administration

This part describes how to perform administration tasks for the XML Extender.

Chapter 2. Administration

Administration tools for XML Extender

The XML Extender administration tools help you enable your database and table columns for XML, and map XML data to DB2[®] relational structures. The XML Extender provides the following command line tool and programming interfaces for administration tasks that you can use.

Administration—details

The XML operating environment on iSeries

The following sections describe the XML operating environment for iSeries.

Application programming

All the XML Extender facilities supplied for application programs run in the iSeries environment as stored procedures or user-defined functions (UDFs). Some of the UDFs that refer to the XML file data type, require access to an IFS system. The DB2 UDB XML trace file, is also written to an IFS file.

Two C header files are provided for developing XML Extender applications. These files contain useful constants for calling the stored procedures and for the definitions of error codes. The header files are available in the following directories, after installation of the product:

- /qibm/proddata/db2extenders/xml/include/dxx.h
- /qibm/proddata/db2extenders/xml/include/dxxrc.h

To develop C++ applications with these headers, use the `INCDIR('/qibm/proddata/db2extenders/xml/include')` option on the `CRTCPPMOD` iSeries command.

Administration environment

When performing administration tasks in the iSeries environment, you use the XML Extender Administration wizard, the Qshell, the Navigator, or the native operating system (OS) command line.

Administration wizard

You can use either an Administration wizard from Windows or UNIX client, or an iSeries environment to complete administration tasks.

Qshell

You can run the administration command, `dxxadm`, and its options, in the Qshell. The administration command is described in Chapter 6, “The `dxxadm` administration command,” on page 121, and provide options for managing XML column, XML collection, and databases for the XML Extender.

Navigator

You can call administration stored procedures in the Navigator. The administration stored procedures are described in “XML Extender administration stored procedures - Overview” on page 178, and provide options for managing XML column, XML collection, and databases for the XML Extender.

OS command line

You can run the administration program, QZXMADM, from the OS command line. This program uses the administration command parameters described in Chapter 6, “The dxxadm administration command,” on page 121, and provide options for managing XML column, XML collection, and databases for the XML Extender.

The following table summarizes the administration environment for the XML Extender.

Table 6. XML Extender stored procedures and commands

Environment	Qshell	Navigator	OS Command Line
Sample files	DAD, DTD, and XML files are stored under the <i>dxxsamples</i> directory. <ul style="list-style-type: none"> <i>dxxsamples/dtd/dad.dtd</i> <i>dxxsamples/dtd/*.*</i> <i>dxxsamples/dad/*.*</i> <i>dxxsamples/xml/*.*</i> 	DAD, DTD, and XML files are stored under the <i>dxxsamples</i> directory. <ul style="list-style-type: none"> <i>dxxsamples/getstart.exe</i> <i>dxxsamples/dtd/dad.dtd</i> <i>dxxsamples/dtd/*.*</i> <i>dxxsamples/dad/*.*</i> <i>dxxsamples/xml/*.*</i> 	DAD, DTD, and XML files are stored under the <i>dxxsamples</i> directory. <ul style="list-style-type: none"> <i>dxxsamples/dtd/dad.dtd</i> <i>dxxsamples/dtd/*.*</i> <i>dxxsamples/dad/*.*</i> <i>dxxsamples/xml/*.*</i>
Program executable files	DXXSAMPLES library, which is pointed to by symbolic links in <i>dxxsamples/*</i> .	DXXSAMPLES library on iSeries; no executables on Windows or UNIX.	DXXSAMPLES library: <ul style="list-style-type: none"> Sample SQL scripts in the SQLSTMT file Sample CL source in the QCLSRC file Sample C++ source in the QCSRC file
Command scripts	None	*.SQL files in <i>path/DXXSAMPLES</i>	DXXSAMPLES/SQLSTMT

Preparing to administer XML Extender

To run XML Extender, you need to install the following software.

Required software for i5/OS™:

- DB2 Universal Database™ Version 5 Release 4
- iSeries International components for unicode (option 39 of 5722SS1) QICU
- iSeries System Openness Includes (option 13 of 5722SS1) QSYSINC
- iSeries Portable App Solutions Environment (option 33 of 5722SS1) QPASE (needed for compiles)
- WebSphere® Development ToolSet (options 51, 52 of 5722WDS) ILE-C, ILE-C++ family
- XML Toolkit for iSeries (5733XT1)
- You might also need 5722JV1 if you plan to develop applications that use Java™ or Web-based applications.

Optional software:

- For structural text search, the DB2 Universal Database Net Search Extender Version 7.2, which is available with DB2 Universal Database (options 1 and 3 of 5722DE1)
- For XML Extender administration wizard:

Migrating XML Extender from previous versions

If you have been using an earlier version of XML Extender, you must migrate a database that is enabled for XML Extender before using an existing XML-enabled database with XML Extender Version 8.2.

Before you install DB2 UDB XML Extender Version 8.2, apply the most recent Version 8 PTF, and follow the migration instructions contained in the PTF cover letter.

Procedure:

To automatically migrate an XML enabled database and XML enabled columns:

1. Install DB2 UDB XML Extender Version 8.2.
2. Install the latest PTFs
3. From the operating system command line, enter:

```
CALL QDBXM/QZXMIGV
```

IASP considerations

For an iSeries system, an independent auxiliary storage pool (IASP) device can be used as an external database. This IASP can be enabled for XML Extender. Consider the following when enabling an IASP database for XML extender:

- You can enable your *SYSBAS database or a database on an IASP for XML extender.
- You can enable more than one IASP database for XML extender, but you can only have one active IASP database at a time.
- If you have enabled the *SYSBAS database for XML extender, you will not be able to enable an IASP database.

Migrating XML Extender data from SYSBAS to an IASP

To move your XML data from SYSBAS to an IASP, detailed planning is required.

Different Save/Restore steps will be required for:

- XML collection database files
- database files with XML user-defined types (UDTs)
- XML column database files

To migrate to an IASP:

1. Save your XML data using the steps described in “Saving and restoring for XML columns and XML collections” on page 34.
2. Disable all XML columns.
3. Disable all XML collections.
4. Drop all schemas that contain XML data (the data that you saved in step 1.)
5. Drop all columns that were defined with XML Extender UDTs.
6. Disable the SYSBAS database for XML Extender.
7. Sign off.
8. Sign on.
9. Execute the SETASPGRP to the IASP group.
10. Enable the IASP database for XML Extender.

11. Restore your XML data using the directions in “Saving and restoring for XML columns and XML collections.”

Saving and restoring for XML columns and XML collections

On the i5/OS, save and restore procedures for schemas have the following restrictions:

- Do not save, restore, or delete the DB2XML schema (library).
- The following conditions apply when you restore user-created schemas that contain database files used by XML Extender:
 - Schemas that contain XML collections, but do not contain XML-enabled columns, can be restored at the library level using SAVLIB and RSTLIB commands, provided the database on the new system has been enabled for XML Extender. If the XML collection was enabled on the old system, you must re-enable the XML collection on the new system.
 - Schemas that contain columns of XML user-defined types (XMLCLOB, XMLVarchar, etc.) can be restored at the library level, provided that the column has not been enabled for XML and the database on the new system has been enabled for XML Extender.
 - Schemas that contain columns that have been enabled for XML cannot be restored at the library level. The base table and the side tables (database files) can be restored at the object level using the RSTOBJ command.

The following procedures tell you how to restore schemas with database files that are used with XML collections and XML columns.

To restore XML collection database files:

1. Enable the database on the target system for XML Extender.
2. Restore the XML collection database files using RSTLIB.
3. If the XML collection was enabled on the original system, run the enable_collection command to enable the XML collection on the target system.

To restore database files with XML user-defined types:

1. Enable the database on the target system for XML Extender.
2. Restore the database files using the RSTLIB command.

To restore XML column database files:

1. Enable the database on the target system for XML Extender.
2. Restore the base table, using the RSTOBJ command.
3. Remove any old triggers that were defined in the base table using the RMVPFTRG command.
4. Enable the XML column on the target system. You must use the '-r' parameter to identify the primary key of the base table if the '-r' parameter was used to enable the base table on the previous system.
5. Add user-defined triggers to the base table using the ADDPFTRG command, and restore those programs on the target system.
6. Restore the data to the side tables using the RSTOBJ command.

Restrictions: You cannot restore database files with RSTLIB when they contain XML-enabled columns for the following reasons:

- Important metadata that is stored in the XML Extender is not restored to the new system when you restore your library and database files. This metadata can only be created on the target system by running the enable_column command.

- When you restore your library with RSTLIB, SQL triggers in your library will be unusable because the prerequisite metadata will be missing from the XML Extender. The presence of these triggers will prevent you from running the enable_column command.

Setting up XML Extender samples and the development environment for iSeries

The following sections describe how to set up the administration environment, depending on the approach you plan to use for your application

- For all environments - “Unpack and restore sample files and getting started files”
- For all environments - “Creating an SQL collection (schema) for the samples” on page 36
- For the administration environment of your choice:
 - When using the wizard - “Setting up the Wizard” on page 37
 - When using the Qshell command line - “Setting up the Qshell” on page 37
 - When using the Navigator - “Setting up the iSeries Navigator interface” on page 37
 - When using the OS command line - “Preparing the sample programs for the iSeries command line” on page 38
- To run the getting started lessons - “Setting up the tutorial environment for iSeries” on page 38

Unpack and restore sample files and getting started files

The samples are shipped as two iSeries Save File objects in the product directory. These files are:

QDBXM/QZXMSAMP1

Contains a SAVLIB save file for the DXXSAMPLES library. The library contains sample C and CL source code, C header files, and SQL statements for application development.

QDBXM/QZXMSAMP2

Contains a SAV save file of an IFS directory tree that will contain sample XML, DTD, and Data Access Definition (DAD) files, and a self-extracting GetStart.exe file to be used with the Navigator.

The first step in preparing to use the administration environment is to have the iSeries administrator unpack and restore these save files to your system.

The administrator should:

- Unpack QDBXM/QZXMSAMP1 Save File to restore Samples source code and SETUP program to your system.

From the OS command line, enter:

```
RSTLIB SAVLIB(DXXSAMPLES)
DEV(*SAVF)
SAVF(QDBXM/QZXMSAMP1)
```

The RSTLIB command unpacks the save file in the DXXSAMPLES library and it contains the objects listed in Table 7 on page 36:

Table 7. DXXSAMPLES library objects

Object	Type	Attribute	Description
SETUP	PGM	CLP	Compiles sample programs and Add IFS
H	FILE	PF-SRC	C Header files
QCLSRC	FILE	PF-SRC	Interface for Navigator
QCSRC	FILE	PF-SRC	Sample programs
SQLSTMT	FILE	PF-SRC	SQL statements for samples

- Unpack QDBXM/QZXMSAMP2 Save File to restore XML files and GetStart.exe to the user's system.

From the OS command line, enter:

```
RST DEV('/qsys.lib/qdbxm.lib/qzxmsamp2.file')
      OBJ('/QIBM/UserData/DB2Extenders/XML/Samples')
```

The RST DEV command restores the save file to the XML files to the IFS directory, /QIBM/UserData/DB2Extenders/XML/Samples.

A symbolic link, /dxxsamples, is created during the samples set up, and points to IFS directory, /QIBM/UserData/DB2Extenders/XML/Samples. The term *dxxsamples* used throughout this book refers to either of these values.

Creating an SQL collection (schema) for the samples

You need to have a schema to run the samples because a set of stored procedures and tables with sample data will be created in this schema.

When creating an SQL schema, it is recommended that the name of the schema the user ID that you will use while running the samples because of default schema rules in SQL.

If you already have an SQL schema matching this user ID, you do not need to create a new schema.

To create the schema:

1. From the OS command line, open an SQL session by entering:
STRSQL
2. From the SQL session, enter:
CREATE SCHEMA *UserId*

Where *UserId* is user ID that you use when you run the samples.

Setting up administration tools for iSeries

The tools you can use for administration tools were described in “Administration environment” on page 31. You can choose any of these environments to perform the administration tasks. Some of these environments require set up to be used with the XML Extender administration commands, the stored procedures, and the samples. The following sections describe the set up requirements.

Setting up the Wizard

See the XML Extender Web site:

<http://www.ibm.com/software/data/db2/extenders/xmlext/downloads.html>

Setting up the Qshell

No set up required, except for installation of the Qshell option.

Setting up the iSeries Navigator interface

You can use the iSeries Navigator to run administration commands, SQL statements, stored procedures, and to complete the Getting Started lessons. If you plan to use the iSeries Navigator, complete the following steps to download and build the sample programs. Building the sample programs prepares the environment for running the administration stored procedures and is required.

1. Download and unpack the GetStart.exe file.
 - a. Create a directory on the Windows operating system, called *path/dxxsamples*. *path* is the drive and directory under which the *dxxsamples* directory is to be located.
 - b. From a Windows command line, enter:

```
FTP SystemId
```

Where *SystemId* is the host name of the iSeries system where you have restored the save file to the *dxxsamples* directory.
Enter the requested user ID and password.
 - c. Enter the following FTP command to change to binary mode: Binary.
 - d. Enter the following FTP command to move the getting started exe file to the *dxxsamples* directory:

```
get dxxsamples/getstart.exe path/dxxsamples/getstart.exe
```
 - e. Close the FTP session with the following command:

```
exit
```
 - f. From the *path/dxxsamples* directory, enter:

```
GetStart.exe
```
2. Start the iSeries Navigator.
3. Expand the tree for your iSeries system, and right click **Database**. A menu is displayed.
4. From the menu, click **Run SQL Scripts**.
5. Open the *path/dxxsamples/setup.sql* script file.
6. Change all occurrences of &SCHEMA to the schema name you created in "Creating an SQL collection (schema) for the samples" on page 36:
 - a. Click the **Edit -> Replace** from the menu. The Search and Replace window opens.
 - b. From the Search and Replace window, replace all occurrences of &SCHEMA with your schema name.
7. Change all occurrences of &DBNAME to the RDB database name for the system where you will run the sample programs. To determine this name, run the **WRKRDBDIRE** command from the OS command line. From the list of registered databases, select the name with the remote address of *LOCAL.
 - a. Click the **Edit -> Replace** from the menu. The Search and Replace window opens.
 - b. From the Search and Replace window, replace all occurrences of &DBNAME with the local database name.

8. Save the setup.sql file
9. Repeat steps 5-8 for each SQL file.
10. Open the *path/dxxsamples/Setup.sql* script file and click **Run all**.

You are now ready to begin the Getting Started lessons, using the iSeries Navigator.

The sample programs you have just built can be used to enter administration commands and DB2 UDB commands.

Preparing the sample programs for the iSeries command line

You can use the OS command line to run administration commands and to complete the Getting Started lessons.

To run administration commands, there is no set up.

If you plan to use the OS command line for the samples and getting started lessons, run SETUP to build all sample programs. From the OS command line, enter:

```
CALL DXXSAMPLES/SETUP
```

Setting up the tutorial environment for iSeries

The following sections describe the required steps to set up the environment to perform the Getting Started lessons, which will help you use the provided samples for developing your own applications.

You can use the following environments to complete the Getting Started lessons:

- iSeries Navigator
- OS command line

To use these environments, you must:

1. Restore the sample source code to the samples library. Use the steps in “Unpack and restore sample files and getting started files” on page 35.
2. Restore the XML sample files and the Getting Started executable to an IFS directory. Use the steps in “Unpack and restore sample files and getting started files” on page 35.
3. Create an SQL Schema (collection). Use the steps in “Creating an SQL collection (schema) for the samples” on page 36.
4. Set up the environment from which you will complete the administration tasks.
 - When using the iSeries Navigator - “Setting up the iSeries Navigator interface” on page 37
 - When using the OS command line - “Preparing the sample programs for the iSeries command line”

XML Extender administration overview

When you plan an application that uses XML documents, you first decide whether you will:

- Compose XML documents from data in the database.
- Store existing XML documents. If you will store XML documents, you must also decide if you want them to be stored as intact XML documents in a column or decomposed into relational data.

After you make this decision, you can then decide:

- Whether to validate your XML documents
- Whether to index XML column data for fast search and retrieval
- How to map the structure of the XML document to DB2® UDB relational tables

Access and storage methods

The XML Extender provides two access and storage methods to use DB2® as an XML repository: XML column and XML collection. You need to decide which of these methods best matches your application's needs for accessing and manipulating XML data.

XML column

Stores and retrieves entire XML documents as DB2 UDB column data. The XML data is represented by an XML column.

XML collection

Decomposes XML documents into a collection of relational tables or composes XML documents from a collection of relational tables.

The nature of your application determines which access and storage method is most suitable, and how to structure your XML data.

You use the DAD file to associate XML data with DB2 UDB tables through these two access and storage methods. Figure 4 shows how the DAD specifies the access and storage methods.

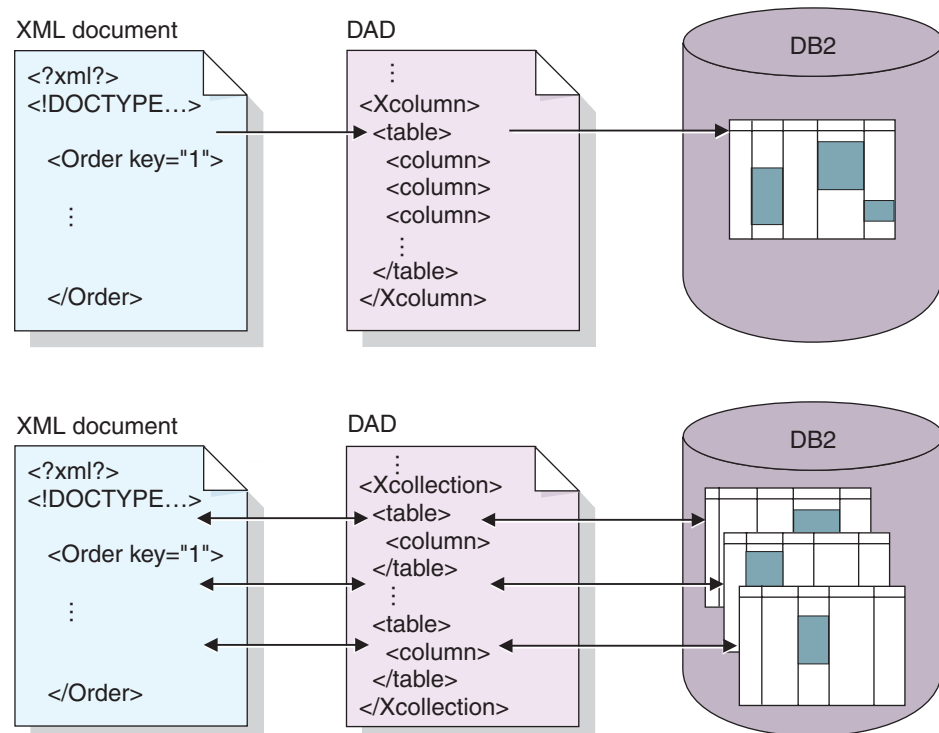

Figure 4. The DAD file maps the XML document structure to a DB2 UDB relational data structure and specifies the access and storage method.

The DAD file defines the location of key files like the DTD, and specifies how the XML document structure relates to your DB2 UDB data. Most important, it defines the access and storage method that you use in your application.

Related concepts:

- “When to use the XML column method” on page 40
- “When to use the XML collection method” on page 40

Related reference:

- “Storage functions in XML Extender overview” on page 134

When to use the XML column method

Use XML columns in any of the following situations:

- The XML documents already exist or come from an external source and you prefer to store the documents in the native XML format. You want to store them in DB2® for integrity, archival, and auditing purposes.
- The XML documents are read frequently, but not updated.
- You want to use file name data types to store the XML documents (external to DB2 UDB) in the local or remote file system and use DB2 UDB for management and search operations.
- You need to perform range searches based on the values of XML elements or attributes, and you know what elements or attributes will frequently be used in the search arguments.
- The documents have elements with large text blocks and you want to use the DB2 UDB Text Extender for structural text search while keeping the entire documents intact.

When to use the XML collection method

Use XML collections in any of the following situations:

- You have data in your existing relational tables and you want to compose XML documents based on a certain DTD.
- You have XML documents that need to be stored with collections of data that map well to relational tables.
- You want to create different views of your relational data using different mapping schemes.
- You have XML documents that come from other data sources. You care about the data but not the tags, and want to store pure data in your database and you want the flexibility to decide whether to store the data in existing tables or in new tables.

Planning for XML columns

Before you begin working with the XML Extender to store your documents, you need to understand the structure of the XML document so that you can determine how to index elements and attributes in the document. When planning how to index the document, you need to determine:

- The XML user-defined type in which you will store the XML document
- The XML elements and attributes that your application will frequently search, so that their content can be stored in side tables and indexed to improve performance
- Whether or not to validate XML documents in the column with a DTD

- The structure of the side tables and how they will be indexed

Determining the XML data type for the XML column

The XML Extender provides XML user defined types that you use to define a column to hold XML documents. These data types are described in Table 8.

Table 8. The XML Extender UDTs

User-defined type column	Source data type	Usage description
XMLVARCHAR	VARCHAR(<i>varchar_len</i>)	Stores an entire XML document as VARCHAR data type within DB2. Used for documents that are smaller than 3K stored in DB2. (The maximum size can be redefined up to 32672 K)
XMLCLOB	CLOB(<i>clob_len</i>)	Stores an entire XML document as a CLOB data type within DB2. Used for documents larger than 3K stored in DB2. The maximum document size is 2 gigabytes.
XMLFILE	VARCHAR(512)	Stores the file name of an XML document in DB2, and stores the XML document in a file local to the DB2 UDB server. Used for documents stored outside DB2.

Determining elements and attributes to be indexed

When you understand the XML document structure and the needs of your application, you can determine which elements and attributes to be searched. These are usually the elements and attributes that will be searched or extracted most frequently, or those that will be the most expensive to query. The location paths of each element and attribute can be mapped to relational tables (side tables) that contain these objects in the DAD file for XML columns. The side tables are then indexed.

For example, Table 9 shows an example of types of data and location paths of element and attribute from the Getting Started scenario for XML columns. The data was specified as information to be frequently searched and the location paths point to elements and attributes that contain the data. These location paths can then be mapped to side tables in the DAD file.

Table 9. Elements and attributes to be searched

Data	Location path
order key	/Order/@key
customer	/Order/Customer/Name
price	/Order/Part/ExtendedPrice
shipping date	/Order/Part/Shipment/ShipDate

The DAD file

For XML columns, the DAD file primarily specifies how documents that are stored in an XML column are to be indexed, and is an XML-formatted document, residing

at the client. The DAD file specifies a DTD to use for validating documents inserted into the XML column. The DAD file has a data type of CLOB. This file can be up to 100 KB.

The DAD file for XML columns provides a map of any XML data that is to be stored in side tables for indexing.

To specify the XML column access and storage method, you use the following tag in the DAD file.

<Xcolumn>

Specifies that the XML data is to be stored and retrieved as entire XML documents in DB2 UDB columns that are enabled for XML data.

An XML-enabled column is of the XML Extender's UDT. Applications can include the column in any *user table*. You access the XML column data mainly through SQL statements and the XML Extender's UDFs.

Planning for XML collections

When planning for XML collections, you have different considerations for composing documents from DB2 UDB data, decomposing XML document into DB2 UDB data, or both. The following sections address planning issues for XML collections, and address composition and decomposition considerations.

Validation

After you choose an access and storage method, you can determine whether to validate your data. You validate XML data using a DTD or a schema. Using a DTD or schema ensures that the XML document is valid and lets you perform structured searches on your XML data.

To validate using a DTD, you might

need to have a DTD in the XML Extender repository. See "Storing a DTD in the repository table" on page 53 to learn how to insert a DTD into the repository.

Important: Make the decision whether to validate XML data before inserting XML data into DB2. The XML Extender does not support the validation of data that has already been inserted into DB2.

Considerations:

- You can use only one DTD for composition.
- You can use multiple schemas for composition.
- If you do not choose to validate a document, the DTD specified by the XML document is not processed. It is important that DTDs be processed to resolve entities and attribute defaults even when processing document fragments that cannot be validated.

The DAD file

For XML collections, the DAD file maps the structure of the XML document to the DB2 UDB tables from which you either compose the document, or to where you decompose the document.

For example, if you have an element called <Tax> in your XML document, you might need to map <Tax> to a column called TAX. You define the relationship between the XML data and the relational data in the DAD.

The DAD file is specified either while enabling a collection, or when you use the DAD file in XML collection *stored procedures*. The DAD is an XML-formatted document, residing at the client. If you choose to validate XML documents with a DTD, the DAD file can be associated with that DTD. When used as the input parameter of the XML Extender stored procedures, the DAD file has a data type of CLOB. This file can be up to 100 KB.

To specify the XML collection access and storage method, you use the following tag in the DAD file:

<Xcollection>

Specifies that the XML data is either to be decomposed from XML documents into a collection of relational tables, or to be composed into XML documents from a collection of relational tables.

An XML collection is a virtual name for a set of relational tables that contains XML data. Applications can enable an XML collection of any user tables. These user tables can be existing tables of legacy business data or tables that the XML Extender recently created. You access XML collection data mainly through the stored procedures that the XML Extender provides.

The DAD specifies mappings between elements or attributes of the XML document and columns of tables. It uses the following kinds of nodes to specify these mappings:

root_node

Specifies the root element of the document.

element_node

Identifies an element, which can be the root element or a child element.

text_node

Represents the CDATA text of an element.

attribute_node

Represents an attribute of an element.

Figure 5 on page 44 shows a fragment of the mapping that is used in a DAD file. The nodes map the XML document content to table columns in a relational table.

```

<?xml version="1.0"?>
<!DOCTYPE DAD SYSTEM "dxx_install/dtd/dad.dtd">
<DAD>
  ...
  <Xcollection>
  <SQL_stmt>
    ...
  </SQL_stmt>
  <prolog?xml version="1.0"?</prolog>
  <doctype!DOCTYPE Order SYSTEM "dxx_install/sample/dtd/getstart.dtd
  "</doctype> <root_node>
    <element_node name="Order">           --> Identifies the element <Order>
      <attribute_node name="key">         --> Identifies the attribute "key"
        <column name="order_key"/>       --> Defines the name of the column,
                                          "order_key", to which the element
                                          and attribute are mapped
      </attribute_node>
      <element_node name="Customer">     --> Identifies a child element of
        <text_node>                       --> Specifies the CDATA text for the
          <column name="customer">       --> Defines the name
                                          to which the child
                                          element is mapped
        </text_node>
      </element_node>
      ...
    </element_node>
    ...
  </root_node>
</Xcollection>
</DAD>

```

Figure 5. Node definitions

In this example, the first two columns in the SQL statement have elements and attributes mapped to them.

Mapping schemes for XML collections

If you are using an XML collection, you must select a *mapping scheme* that defines how XML data is represented in a relational database. Because XML collections must match a hierarchical structure that is used in XML documents with a relational structure, you should understand how the two structures compare. Figure 6 on page 45 shows how the hierarchical structure can be mapped to relational table columns.

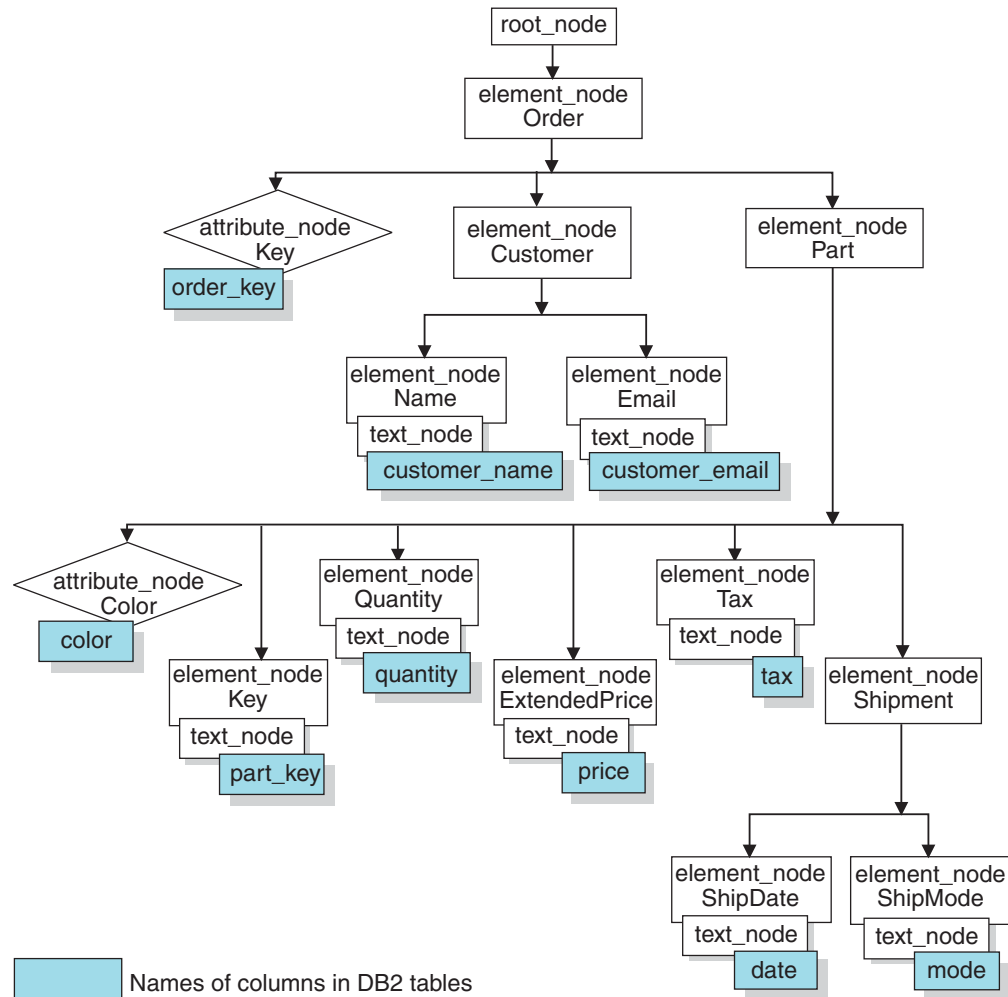

Figure 6. XML document structure mapped to relational table columns

The XML Extender uses the mapping scheme when composing or decomposing XML documents that are located in multiple relational tables. Before you create the DAD file, you must think about how your XML data is mapped to the XML collection.

Types of mapping schemes: The mapping scheme is specified in the <Xcollection> element in the DAD file. The XML Extender provides two types of mapping schemes: *SQL mapping* and *Relational Database (RDB_node) mapping*.

SQL mapping

Allows direct mapping from relational data to XML documents through a single SQL statement. SQL mapping is used for composition; it is not used for decomposition. SQL mapping is defined with the SQL_stmt element in the DAD file. The content of the SQL_stmt is a valid SQL statement. The SQL_stmt maps the columns in the SELECT clause to XML elements or attributes that are used in the XML document. When defined for composing XML documents, the column names in the SQL statement's SELECT clause are used to define the value of an *attribute_node* or a content of *text_node*. The FROM clause defines the tables containing the data; the WHERE clause specifies the *join* and search *condition*.

The SQL mapping gives DB2 UDB users the power to map the data using SQL. When using SQL mapping, you must be able to join all tables in one

SELECT statement to form a query. If one SQL statement is not sufficient, consider using RDB_node mapping. To tie all tables together, the *primary key* and *foreign key* relationship is recommended among these tables.

RDB_node mapping

Defines the location of the content of an XML element or the value of an XML attribute so that the XML Extender can determine where to store or retrieve the XML data.

This method uses the XML Extender-provided *RDB_node*, which contains one or more node definitions for tables, optional columns, and optional conditions. The tables and columns are used to define how the XML data is to be stored in the database. The condition specifies the criteria for selecting XML data or the way to join the XML collection tables.

To define a mapping scheme, you create a DAD with an <Xcollection> element. Figure 7 shows a fragment of a sample DAD file with an XML collection SQL mapping that composes a set of XML documents from data in three relational tables.

```
<?xml version="1.0"?>
<!DOCTYPE DAD SYSTEM "dxx_install/dtd/dad.dtd">
<DAD>
  <dtdid>dxx_install/dad/getstart.dtd</dtdid>
  <validation>YES</validation>
  <Xcollection>
    <SQL_stmt>
      SELECT o.order_key, customer, p.part_key, quantity, price, tax, date,
             ship_id, mode, comment
      FROM order_tab o, part_tab p,
           (select db2xml.generate_unique()
            as ship_id, date, mode, from ship_tab) as
    S
      WHERE p.price > 2500.00 and s.date > "1996-06-01" AND
            p.order_key = o.order_key and s.part_key = p.part_key
    </SQL_stmt>
  <prolog?xml version="1.0"?</prolog>
  <doctype>!DOCTYPE DAD SYSTEM "dxx_install/dtd/
    getstart.dtd"</doctype>
  <root_node>
    <element_node name="Order">
      <attribute_node name="key">
        <column_name="order_key"/>
      </attribute_node>
      <element_node name="Customer">
        <text_node>
          <column name="customer"/>
        </text_node>
      </element_node>
    ...
  </element_node><!--end Part-->
</element_node><!--end Order-->
</root_node>
</Xcollection>
</DAD>
```

Figure 7. SQL mapping scheme

The XML Extender provides several stored procedures that manage data in an XML collection. These stored procedures support both types of mapping, but require that the DAD file follow the rules that are described in "Mapping scheme requirements" on page 47.

Mapping scheme requirements: The following sections describe requirements for each type of the XML collection mapping schemes.

Requirements for SQL mapping

In this mapping scheme, you must specify the `SQL_stmt` element in the DAD `<Xcollection>` element. The `SQL_stmt` should contain a single SQL statement that can join multiple relational tables with the query *predicate*. In addition, the following clauses are required:

- **SELECT clause**

- Ensure that the name of the column is unique. If two tables have the same column name, use the `AS` keyword to create an alias name for one of them.
- Group the columns of the same table together, and use the logical hierarchical level of the relational tables. This means group the tables according to the level of importance as they map to the hierarchical structure of your XML document. In the `SELECT` clause, the columns of the higher-level tables should proceed the columns of lower-level tables. The following example demonstrates the hierarchical relationship among tables:

```
SELECT o.order_key, customer, p.part_key, quantity, price, tax,  
       ship_id, date, mode
```

In this example, `order_key` and `customer` from table `ORDER_TAB` have the highest relational level because they are higher on the hierarchical tree of the XML document. The `ship_id`, `date`, and `mode` from table `SHIP_TAB` are at the lowest relational level.

- Use a single-column candidate key to begin each level. If such a key is not available in a table, the query should generate one for that table using a table expression and the user-defined function, `generate_unique()`. In the above example, the `o.order_key` is the primary key for `ORDER_TAB`, and the `part_key` is the primary key of `PART_TAB`. They appear at the beginning of their own group of columns that are to be selected. Because the `SHIP_TAB` table does not have a primary key, one needs to be generated, in this case, `ship_id`. It is listed as the first column for the `SHIP_TAB` table group. Use the `FROM` clause to generate the primary key column, as shown in the following example.

- **FROM clause**

- Use a table expression and the user-defined function, `generate_unique()`, to generate a single key for tables that do not have a primary single key. For example:

```
FROM order_tab as o, part_tab as p,  
     (select db2xml.generate_unique() as  
      ship_id, date, mode from ship_tab) as s
```

In this example, a single column candidate key is generated with the function, `generate_unique()` and given an alias named `ship_id`.

- Use an alias name when needed to make a column distinct. For example, you could use `o` for `ORDER_TAB`, `p` for `PART_TAB`, and `s` for `SHIP_TAB`.

- **WHERE clause**

- Specify a primary and foreign key relationship as the join condition that ties tables in the collection together. For example:

```
WHERE p.price > 2500.00 AND s.date > "1996-06-01" AND
      p.order_key = o.order_key AND s.part_key = p.part_key
```

- Specify any other search condition in the predicate. Any valid predicate can be used.

- **ORDER BY clause**

- Define the ORDER BY clause at the end of the SQL_stmt.
- Ensure that the column names match the column names in the SELECT clause.
- Specify the column names or identifiers that uniquely identify entities in the entity-relationship design of the database. An identifier can be generated using a table expression and the function generate_unique, or a user-defined function (UDF).
- Maintain the top-down order of the hierarchy of the entities. The column specified in the ORDER BY clause must be the first column listed for each entity. Keeping the order ensures that the XML documents to be generated do not contain incorrect duplicates.
- Do not qualify the columns in ORDER BY by any schema or table name.

Although the SQL_stmt has the preceding requirements, it is powerful because you can specify any predicate in your WHERE clause, as long as the expression in the predicate uses the columns in the tables.

Requirements when using RDB_node mapping

When using this mapping method, do not use the element SQL_stmt in the <Xcollection> element of the DAD file. Instead, use the RDB_node element as a child of the top element_node and of each attribute_node and text_node.

There are no ordering restrictions on predicates of the root node condition.

- **RDB_node for the top element_node**

The *top element_node* in the DAD file represents the root element of the XML document. Specify an RDB_node for the top element_node as follows:

- Line ending characters are allowed in condition statements.
- Condition elements can reference a column name an unlimited number of times.
- Specify all tables that are associated with the XML documents. For example, the following mapping specifies three tables in the RDB_node of the element_node <Order>, which is the top element_node:

```
<element_node name="Order">
  <RDB_node>
    <table name="order_tab"/>
    <table name="part_tab"/>
    <table name="ship_tab"/>
    <condition>
      order_tab.order_key = part_tab.order_key AND
      part_tab.part_key = ship_tab.part_key
    </condition>
  </RDB_node>
```

The condition element can be empty or missing if there is only one table in the collection.

- If you are decomposing, or are enabling the XML collection specified by the DAD file, you must specify a primary key for each table. The primary key can consist of a single column or multiple columns, called a composite key. The primary key is specified by adding an attribute key to the table element of the RDB_node. When a composite key is supplied, the key attribute is specified by the names of key columns separated by a space. For example:

```
<table name="part_tab" key="part_key price"/>
```

The information specified for decomposition is ignored when composing a document.

- Use the orderBy attribute to recompose XML documents containing elements or attributes with multiple occurrence back to their original structure. This attribute allows you to specify the name of a column that will be the key used to preserve the order of the document. The orderBy attribute is part of the table element in the DAD file, and it is an optional attribute.

- **RDB_node for each attribute_node and text_node**

You need to specify an RDB_node for each attribute_node and text_node, telling the stored procedure from which table, which column, and under which query condition to get the data. You must specify the table and column values; the condition value is optional.

- Specify the name of the table containing the column data. The table name must be included in the RDB_node of the top element_node. In this example, for text_node of element <Price>, the table is specified as PART_TAB.

```
<element_node name="Price">
  <text_node>
    <RDB_node>
      <table name="part_tab"/>
      <column name="price"/>
      <condition>
        price > 2500.00
      </condition>
    </RDB_node>
  </text_node>
</element_node>
```

- Specify the name of the column that contains the data for the element text. In the previous example, the column is specified as PRICE.
- Specify a condition if you want XML documents to be generated using the query condition. Allowable syntax for <condition> is as follows:

- columnname
- operator
- literal

In the example above, the condition is specified as price > 2500.00. Only the data meeting the condition is in the generated XML documents. The condition must be a valid WHERE clause.

- If you are decomposing a document, or are enabling the XML collection specified by the DAD file, you must specify the column type for each attribute_node and text_node. This ensures the correct data type for each column when new tables are created during the enabling of an XML collection. Column types are specified by adding the attribute type to the column element. For example,

```
<column name="order_key" type="integer"/>
```

The information specified for decomposition is ignored when composing a document.

- Maintain the top-down order of the hierarchy of the entities. This means ensure the element nodes are nested properly so that the XML Extender understands the relationship between the elements when composing or decomposing. For example, using the following DAD file, that does not nest Shipment inside of Part:

```
<element_node name="Part">
  ...
  <element_node name="ExtendedPrice">
    ...
  </element_node>
  ...
</element_node> <!-- end of element Part -->

<element_node name="Shipment" multi_occurrence="YES">
  <element_node name="ShipDate">
    ...
  </element_node>
  <element_node name="ShipMode">
    ...
  </element_node>
</element_node> <!-- end of element Shipment-->
```

Which might produce an XML file in which the Part and Shipment are sibling elements.

```
<Part color="black ">
  <key>68</key>
  <Quantity>36</Quantity>
  <ExtendedPrice>34850.16</ExtendedPrice>
  <Tax>6.000000e-2</Tax>
</Part>

<Shipment>
  <ShipDate>1998-08-19</ShipDate>
  <ShipMode>BOAT </ShipMode>
</Shipment>
```

When you would rather have a DAD that nests Shipment inside of Part:

```
<element_node name="Part">
  ...
  <element_node name="ExtendedPrice">
    ...
  </element_node>
  ...
  <element_node name="Shipment" multi_occurrence="YES">
    <element_node name="ShipDate">
      ...
    </element_node>
    <element_node name="ShipMode">
      ...
    </element_node>
  </element_node> <!-- end of element Shipment-->
</element_node> <!-- end of element Part -->
```

Which produces an XML file with Shipment as a child element of Part:

```
<Part color="black ">
  <key>68</key>
  <Quantity>36</Quantity>
  <ExtendedPrice>34850.16</ExtendedPrice>
```



```

<Tax>6.000000e-2</Tax>
<Shipment>
  <ShipDate>1998-08-19</ShipDate>
  <ShipMode>BOAT </ShipMode>
</Shipment>
</Part>

```

With the RDB_node mapping approach, you don't need to supply SQL statements. However, putting complex query conditions in the RDB_node element can be more difficult.

Validating XML documents automatically

After you choose an access and storage method, either XML column or XML collection, you can determine whether to *validate* the XML documents. You can also validate XML documents that are composed from XML collections.

You can have your XML data validated automatically by specifying YES for validation in the DAD file. To have a document validated when it is stored into DB2®, you must specify a DTD within the <dtid> element or in the <!DOCTYPE> specification in the original document. To have a document validated when it is composed from an XML collection in DB2, you must specify a DTD within the <dtid> element or within the <doctype> element in the DAD file.

The following factors should be taken into consideration when you decide whether to validate your documents.

- The DTD ID or schema is useful only if you decide to validate the XML document.

To validate the DAD with a schema, insert the schema tags that associate the DAD file with the schema file. For example:

```

<schemabindings>
<nonamespacelocation location="path/schema_name.xsd"/>
</schemabindings>

```

- You do not need a DTD to store or archive XML documents.
- It might be necessary to process the DTD to set entity values and attribute defaults regardless of whether you choose to validate.
- If you specify NO for validation in the DAD, then the DTD specified by the XML document is not processed.
- Validating your XML data has a performance impact.

Enabling a database for XML

Before you can store or retrieve XML documents from DB2 UDB with XML Extender, you enable the database for XML. The XML Extender enables the database you are connected to.

When you enable a database for XML, the XML Extender does the following things:

- Creates all the user-defined types (UDTs), user-defined functions (UDFs), and stored procedures
- Creates and populates control tables with the necessary metadata that the XML Extender requires
- Creates the DB2XML schema and assigns the necessary privileges

The fully qualified name of an XML function is `db2xml.function-name`, where `db2xml` is an identifier that provides a logical grouping for SQL objects. You can use the fully qualified name anywhere you refer to a UDF or a UDT. You can also omit the schema name when you refer to a UDF or a UDT; in this case, DB2 UDB uses the function path to determine the function or data type.

For i5/OS, you can enable a database for XML Extender using either your *SYSBAS database or an independent auxiliary storage pool (IASP). You can enable more than one IASP database for XML Extender. Only one IASP database can be active at a time. You cannot enable an IASP database for XML Extender if the *SYSBAS database is enabled.

Procedure:

You can enable a database with the Administration wizard or from a command line.

The following example enables an existing database called SALES_DB.

```
CALL QDBXM/QZXMADM PARM(enable_db SALES_DB)
```

To enable a database using the Administration wizard, you need to complete the following tasks:

1. Start the Administration wizard and click **Enable database** from the LaunchPad window.
If a database is already enabled, the button will read **Disable database**. If the database is disabled, the button will read **Enable database**
When the database is enabled, you are returned to the LaunchPad window.

After you have enabled a database, you will be able to store and retrieve XML documents from DB2 UDB using the XML extender.

Related concepts:

- “Migrating XML Extender from previous versions” on page 33

Creating an XML table

This task is part of the larger task of defining and enabling an XML column.

An XML table is used to store intact XML documents. To store whole documents in your database with DB2 UDB XML Extender, you must create a table so that it contains a column with an XML user-defined type (UDT). DB2 UDB XML Extender provides you with three user-defined types to store your XML documents as column data. These UDTs are: XMLVARCHAR, XMLCLOB, and XMLFILE. When a table contains a column of XML type, you can then enable the table for XML.

You can create a new table to add a column of XML type using the administration wizard or the command line.

Procedure:

To create a table with a column of XML type using the command line:

Open the DB2 UDB command prompt and type a Create Table statement.

For example, in a sales application, you might want to store an XML-formatted line-item order in a column called ORDER of a table called SALES_TAB. This table also has the columns INVOICE_NUM and SALES_PERSON. Because it is a small order, you store the sales order using the XMLVARCHAR type. The primary key is INVOICE_NUM. The following CREATE TABLE statement creates a table with a column of XML type:

```
CREATE TABLE sales_tab(
    invoice_num    char(6)    NOT NULL PRIMARY KEY,
    sales_person   varchar(20),
    order          db2xml.XMLVarchar);
```

After you have created a table, the next step is to enable the column for XML data.

Related concepts:

- “Planning side tables” on page 57

Storing a DTD in the repository table

You can use a DTD to validate XML data in an XML column or in an XML collection. DTDs can be stored in the DTD repository table, a DB2 UDB table called DTD_REF. The DTD_REF table has a schema name of DB2XML. Each DTD in the DTD_REF table has a unique ID. The XML Extender creates the DTD_REF table when you enable a database for XML. You can insert the DTD from the command line or by using the administration wizard.

Procedure:

To insert the DTD using the administration wizard:

1. Start the administration wizard and click **Import a DTD** from the Launchpad window to import an existing DTD file into the DTD repository for the current database. The Import a DTD window opens.
2. Specify the DTD file name in the **DTD file name** field.
3. Type the DTD ID in the **DTD ID** field.
The DTD ID is an identifier for the DTD. It can also be the path that specifies the location of the DTD on the local system. The DTD ID must match the value that is specified in the DAD file for the <DTDID> element.
4. Optional: Type the name of the author of the DTD in the **Author** field.
5. Click **Finish** to insert the DTD into the DTD repository table, DB2XML.DTD_REF, and return to the Launchpad window.

To insert a DTD from the command line, issue a SQL INSERT statement from Table 10. For example:

```
INSERT into DB2XML.DTD_REF values('dxx_install
/samples/db2xml/dtd/getstart.dtd',
db2xml.XMLClobFromFile('/dxxsamples/dtd/getstart.dtd'),
0, 'user1', 'user1', 'user1');
```

Table 10. The column definitions for the DTD repository table

Column name	Data type	Description
DTDID	VARCHAR(128)	ID of the DTD.
CONTENT	XMLCLOB	Content of the DTD.
USAGE_COUNT	INTEGER	Number of XML columns and XML collections in the database that use this DTD.

Table 10. The column definitions for the DTD repository table (continued)

Column name	Data type	Description
AUTHOR	VARCHAR(128)	Author of the DTD, optional information for the user to input.
CREATOR	VARCHAR(128)	User ID that does the first insertion.
UPDATOR	VARCHAR(128)	User ID that does the last update.

Enabling XML columns

To store an XML document in a DB2 UDB database, you must enable for XML the column that will contain the document. Enabling a column prepares it for indexing so that it can be searched quickly. You can enable a column by using the XML Extender Administration wizard or the command line. The column must be of XML type.

When XML Extender enables an XML column, it performs the following operations:

- Reads the DAD file to:
 - Check for the existence of the DTD in the DTD_REF table, if the DTDID was specified.
 - Create side tables on the XML column for indexing purpose.
 - Prepare the column to contain XML data.
- Optionally creates a *default view* of the XML table and side tables. The default view displays the application table and the side tables.

Column name limit: For i5/OS, the column size limit in a view is 10 characters.
- Specifies a ROOT ID column, if one has not been specified.

After you enable the XML column, you can:

- Create indexes on the side tables
- Insert XML documents in the XML column
- Query, update, or search the XML documents in the XML column.

You can enable XML columns using the Administration wizard or from a DB2 command line.

Procedure (using the Administration Wizard):

To enable XML columns using the Administration wizard:

1. Set up and start the Administration wizard.
2. Click **Work with XML Columns** from the LaunchPad window to view the tasks related to the XML Extender columns. The Select a Task window opens.
3. Click **Enable a Column** and then **Next** to enable an existing column.
4. Select the table that contains the XML column from the **Table name** field.
5. Select the column being enabled from the **Column name** field. The column must exist and be of XML type.
6. Type the DAD path and file name in the **DAD file name** field, or click ... to browse for an existing DAD file. For example:

```
dxx_install/dad/getstart.dad
```
7. (Optional) Type the name of an existing table space in the **Table space** field.

The table space default contains side tables that the XML Extender created. If you specify a table space, the side tables are created in the specified table space. If you do not specify a table space, the side tables are created in the default table space.

8. (Optional) Type the name of the default view in the **Default view** field.

When specified, the default view is automatically created when the column is enabled and joins the XML table and all of the related side tables.

9. (Optional) Type the column name of the primary key for the table in the **Root ID** field. This is recommended.

The XML Extender uses the value of **Root ID** as a unique identifier to associate all side tables with the application table. The XML Extender adds the DXXROOT_ID column to the application table and generates an identifier.

10. Click **Finish** to enable the XML column, create the side tables, and return to the LaunchPad window.

- If the column is successfully enabled, you receive the message: column is enabled.
- If the column is not successfully enabled, an error message is displayed. You have to correct the DAD and start the enabling process again.

Procedure (using the Command Line):

To enable an XML column using the command line use the DXXADM enable_column, which has the syntax and parameters explained in this section

Syntax:

```

▶▶—dxxadm—enable_column—dbName—tbName—colName—DAD_file—————▶
▶
┌—v—default_view┐ ┌—r—root_id┐

```

Parameters:

dbName

The name of the RDB database.

tbName

The name of the table that contains the column to be enabled.

colName

The name of the XML column that is being enabled.

DAD_file

The name of the file that contains the document access definition (DAD).

default_view

Optional. The name of the default view that the XML Extender created to join an application table and all of the related side tables.

root_id

Optional, but recommended. The column name of the primary key in the application table and a unique identifier that associates all side tables with the application table. Known as ROOT_ID. The XML Extender uses the value of ROOT_ID as a unique identifier to associate all side tables with the application table. If the ROOT ID is not specified, the XML Extender adds the DXXROOT_ID column to the application table and generates an identifier.

Restriction: If the application table has a column name of DXXXROOT_ID, you must specify the *root_id* parameter; otherwise, an error occurs.

Example:

From the Qshell:

```
dxxadm enable_column SALES_DB myschema.sales_tab order getstart.dad
-v sales_order_view -r INVOICE_NUMBER
```

From the OS command line:

```
CALL QDBXM/QZXADM PARM(enable_column SALES_DB 'MYSCHEMA.SALES_TAB'
ORDER 'getstart.dad' '-v' sales_order_view '-r' INVOICE_NUMBER)
```

From the iSeries Navigator:

```
CALL MYSCHEMA.QZXADM('enable_column', 'SALES_DB', 'MYSCHEMA.SALES_TAB',
'ORDER', 'getstart.dad', '-v sales_order_view', '-r INVOICE_NUMBER');
```

In this example, the ORDER column is enabled in the SALES_TAB table . The DAD file is getstart.dad, the default view is sales_order_view, and the ROOT ID is INVOICE_NUMBER.

Using this example, the SALES_TAB table has the following columns:

Column Name	Data type
INVOICE_NUM	CHAR(6)
SALES_PERSON	VARCHAR(20)
ORDER	XMLVARCHAR

The following side tables are created based on the DAD specification:

ORDER_SIDE_TAB:

Column name	Data type	Path expression
ORDER_KEY	INTEGER	/Order/@key
CUSTOMER	VARCHAR(50)	/Order /Customer/Name
INVOICE_NUM	CHAR(6)	N/A

PART_SIDE_TAB:

Column name	Data type	Path expression
PART_KEY	INTEGER	/Order/Part/@key
PRICE	DOUBLE	/Order/Part /ExtendedPrice
INVOICE_NUM	CHAR(6)	N/A

SHIP_SIDE_TAB:

Column name	Data type	Path expression
DATE	DATE	/Order/Part /Shipment/ShipDate
INVOICE_NUM	CHAR(6)	N/A

All the side tables have the column INVOICE_NUM of the same type, because the ROOT ID is specified by the primary key INVOICE_NUM in the application table. After the column is enabled, the value of the INVOICE_NUM is inserted in side tables when a row is inserted in the main table. Specifying the *default_view* parameter when enabling the XML column, ORDER, creates a default view, sales_order_view. The view joins the above tables using the following statement:

```
CREATE VIEW sales_order_view(invoice_num, sales_person, order,
                             order_key, customer, part_key, price, date)
AS
SELECT sales_tab.invoice_num, sales_tab.sales_person, sales_tab.order,
       order_tab.order_key, order_tab.customer,
       part_tab.part_key, part_tab.price,
       ship_tab.date
FROM sales_tab, order_tab, part_tab, ship_tab
WHERE sales_tab.invoice_num = order_tab.invoice_num
      AND sales_tab.invoice_num = part_tab.invoice_num
      AND sales_tab.invoice_num = ship_tab.invoice_num
```

Planning side tables

Side tables are DB2[®] tables used to extract the content of an XML document that will be searched frequently. The XML column is associated with side tables that hold the contents of the XML document. When the XML document is updated in the application table, the values in the side tables are automatically updated.

Figure 8 shows an XML column with side tables.

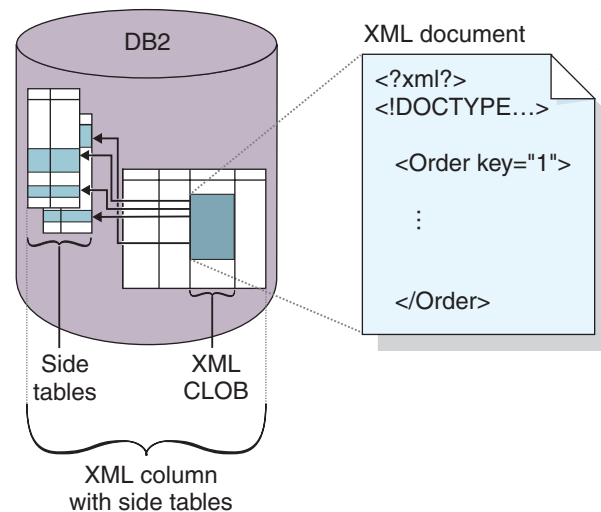

Figure 8. An XML column whose content is mapped in side tables. There is an XML file in the column that is associated with side tables that hold the contents of the XML document.

When planning for side tables, you must consider how to organize the tables, how many tables to create, and whether to create a default view for the side tables. Base these decisions on whether elements and attributes can occur multiple times and your requirements for query performance. Do not plan to update the side tables in any way; they will be automatically updated when the document is updated in the XML column.

Multiple occurrence:

When elements and attributes occur multiple times in side tables, consider the following issues in your planning:

- For elements or attributes in an XML document that have multiple occurrences, you must create a separate side table for each XML element or attribute with multiple occurrences, due to the complex structure of XML documents. This means that elements or attributes have location paths that occur multiple times and must be mapped to a table with only one column. You cannot have any other columns in the table.
- When a document has multiple occurring location paths, XML Extender adds a column named `DXX_SEQNO` with a type of `INTEGER` in each side table to track the order of elements that occur more than once. With `DXX_SEQNO`, you can retrieve a list of the elements in the same order as the original XML document by specifying `ORDER BY DXX_SEQNO` in an SQL query.

Default views and query performance:

When you enable an XML column, you can specify a default, read-only view that joins the application table with the side tables using a unique ID, called the `ROOT ID`. With the default view, you can search XML documents by querying the side tables. For example, if you have the application table `SALES_TAB`, and the side tables `ORDER_TAB`, `PART_TAB` and `SHIP_TAB`, your query might look as follows:

```
SELECT sales_person FROM sales_order_view
      WHERE price > 2500.00
```

The SQL statement returns the names of salespeople in the `SALES_TAB` who have orders stored in the column `ORDER`, and where the `PRICE` column is greater than 2500.00.

The advantage of querying the default view is that it provides a virtual single view of the application table and side tables. However, the more side tables that are created, the more expensive the query. Therefore, creating the default view is recommended only when the total number of side-table columns is small. Applications can create their own views that join the important side table columns.

Column name limit: For `i5/OS™`, the column size limit in a view is 10 characters. To use a longer name, you must generate the view manually or use alias names

Indexing side tables

This task is part of the larger task of defining and enabling an XML column.

Side tables contain the XML data in the columns that you specified when you created the DAD file. After you enable an XML column and create side tables, you can index the side tables. Indexing these tables helps you improve the performance of the queries against the XML documents.

Procedure:

To create an index for your side tables from a DB2 UDB command line, use the `DB2 CREATE INDEX SQL` statement from the DB2 UDB command line.

The following example creates indexes on four side tables using the DB2 command prompt.

```

CREATE INDEX KEY_IDX
  ON ORDER_SIDE_TAB(ORDER_KEY)

CREATE INDEX CUSTOMER_IDX
  ON ORDER_SIDE_TAB(CUSTOMER)

CREATE INDEX PRICE_IDX
  ON PART_SIDE_TAB(PRICE)

CREATE INDEX DATE_IDX
  ON SHIP_SIDE_TAB(DATE)

```

Composing XML documents by using SQL mapping

You should use SQL mapping to compose XML documents if you want to use an SQL statement to define the table and columns that you will derive the data in the XML document. You can use SQL mapping only for composing XML documents. You create a DAD file to compose the XML document with SQL mapping.

Prerequisites:

Before you compose your documents, you must first map the relationship between your DB2 UDB tables and the XML document. This step includes mapping the hierarchy of the XML document and specifying how the data in the document maps to a DB2 UDB table.

Procedure:

To compose XML documents from the command line, complete the following steps:

1. Create a new document in a text editor and type the following syntax:

```

<?XML version="1.0"?>
<!DOCTYPE DAD SYSTEM "path/dad.dtd">

```

2. Insert the <DAD> </DAD> tags.

The DAD element will contain all the other elements.

3. Insert the tags used for validating the DAD with a DTD or schema.

- To validate the composed XML document with a DTD, insert the DTDID tags that associate the DAD file with the XML document DTD. For example:

```

<dtdid>dtd_name</dtdid>

```

- To validate the composed XML document with a schema, insert the schema tags that associate the DAD file with the schema file. For example:

```

<schemabindings>
<nonamespace:location location="path/schema_name.xsd"/>
</schemabindings>

```

The dtd or schema is useful only if you decide to validate the XML document. Use the validation tag to indicate whether DB2 UDB XML Extender validates the XML document:

- If you want to validate the XML document, then type:

```

<validation>YES</validation>

```

- If you do not want to validate the XML document type:

```

<validation>NO</validation>

```

4. Type <XCollection> </XCollection> tags to specify that you are using XML collections as the access and storage method for your XML data.
5. Inside the <Xcollection> </Xcollection> tags, insert the <SQL_stmt> </SQL_stmt> tags to specify the SQL statement that will map the relational

data to the XML documents. This statement is used to query data from DB2 UDB tables. The following example shows a sample SQL query:

```
<SQL_stmt>
  SELECT o.order_key, customer_name, customer_email, p.part_key, color,
         quantity, price, tax, ship_id, date, mode from order_tab o, part_tab p,
         (select db2xml.generate_unique()
          as ship_id, date, mode, part_key from ship_tab) as s
         WHERE o.order_key = 1 and
                p.price > 20000 and
                p.order_key = o.order_key and
                s.part_key = p.part_key
         ORDER BY order_key, part_key, ship_id
</SQL_stmt>
```

The example SQL statement for mapping the relational data to the XML document meets the following requirements:

- Columns are specified in top-down order by the hierarchy of the XML document structure.
 - The columns for an entity are grouped together.
 - The object ID column is the first column in each group.
 - The Order_tab table does not have a single key column, and therefore, the generate_unique UDF is used to generate the ship_id column.
 - In the ORDER BY clause, the object ID columns are listed in order corresponding to the top-down hierarchy of tables to which they belong. The columns in ORDER BY should not be qualified by any schema and the column names must match the column names in the SELECT clause.
6. Add the following prolog information to be used in the composed XML document. If you need to specify an encoding value for internationalization, add the ENCODING attribute and value.
- ```
<prolog>?xml version="1.0"?</prolog>
```
7. Type the <doctype> </doctype> tag. This tag contains the DOCTYPE declaration to be inserted in each composed document. For example:

```
<doctype>! DOCTYPE Order SYSTEM "dxxsamples/dtd/getstart.dtd"</doctype>
```

8. Specify the root element and the elements and attributes that make up the XML document:

  - a. Add the <root></root\_node> tag to define the root element. All the elements and attributes that make up the XML document are specified within the root\_node.
  - b. Use the <element\_node>, <attribute\_node>, <text\_node>, and <column> tags to specify the names of elements and attributes in the composed document and to map them to the columns specified in the SQL statement.

**<element\_node> tag**

Specifies the elements in the XML document. Set the name attribute of the element\_node tag to the name of the element. Each element\_node can have child element\_nodes.

**<attribute\_node> tag**

Specifies the attributes of an element in the XML document. An <attribute\_node> tag is a child element of <element\_node>. Set the name attribute of the attribute\_node tag to the name of the attribute.

**<text\_node> tag**

Specifies the text content of the element and the column data in a relational table for bottom-level element\_nodes. For each

bottom-level element, specify <text\_node> tags that indicate that the element contains character data to be extracted from DB2 when the document is composed. For each bottom-level element\_node, use a <column> tag to specify from which column to extract data when the XML document is composed. Column tags are typically inside the <attribute\_node> or the <text\_node> tags. All column names defined must be in the <SQL\_stmt> SELECT clause at the beginning of the DAD file.

**<column> tag**

Specifies the column from which the data is retrieved for the element or attribute value.

9. Ensure that the ending tags are in the appropriate places:
  - a. Ensure that an ending </root\_node> tag is after the last </element\_node> tag.
  - b. Ensure that an ending </Xcollection> tag is after the </root\_node> tag.
  - c. Ensure that an ending </DAD> tag is after the </Xcollection> tag.
10. Save the file as *file.dad*. Where *file* is the name of your file.

The following Windows example shows a complete DAD:

```
<?xml version="1.0"?>
<!DOCTYPE DAD SYSTEM "C:\dxx_xml\test\dtd\dad.dtd">
<DAD>
<validation>NO</validation>
<Xcollection>
<SQL_stmt> select o.order_key, customer_name, customer_email,
 p.part_key, color, qty, price, tax, ship_id, date, mode from order_tab o,
 part_tab p, (select db2xml.generate_unique() as
 ship_id, date, mode, part_key from ship_tab) s where
 o.order_key = 1 and p.price . 20000 and p.order_key
 = o.order_key and s.part_key =p.part_key ORDER BY order_key,
 part_key, ship_id</SQL_stmt>
<prolog?XML version="1.0"?></prolog>
<doctype>!DOCTYPE ORDER SYSTEM "dxxsamples\dtd\Order.dtd"
</doctype>
<root_node>
<element_node name="Order">
<attribute_node name="key">
 <column name="order_key"/>
</attribute_node>
<element_node name="Customer">
 <element_node name="NAME">
 <text_node><column name="customer_name"/></text_node>
 </element_node>
</element_node>
<element_node name="Part">
 <attribute_node name="color">
 <column name="color"/>
 </attribute_node>
 <element_node name="key">
 <text_node><column name="part_key"/></text_node>
 </element_node>
 <element_node name="Quantity">
 <text_node><column name="qty"/></text_node>
 </element_node>
 <element_node name="ExtendedPrice">
 <text_node><column name="price"/></text_node>
 </element_node>
 <element_node name="Tax">
 <text_node><column name="tax"/></text_node>
 </element_node>
 <element_node name="Shipment" multi_occurrence="YES">
```

```

<element_node name=shipDate">
 <text_node><column name="date"/></text_node>
 <element_node>
 <element_node name="ShipMode">
 <text_node><column name="mode"/></text_node>
 </element_node>
 </element_node>
</element_node>
</root_node>
</Xcollection>
</DAD>

```

Call the dxxGenXML stored procedure to compose using the DAD. For more information on tests2x, see “Dynamically overriding values in the DAD file” on page 169.

## Composing XML collections by using RDB\_node mapping

You must first create a DAD file, and then compose the XML collection using the DAD file that you created. Use <RDB\_node> to specify DB2 UDB tables, columns, and conditions for an element or attribute node. The <RDB\_node> uses the following elements:

<b>table</b>	Defines the table that corresponds to the element.
<b>column</b>	Defines the column that contains the corresponding element.
<b>condition</b>	Optionally specifies a condition on which insertion into the column occurs.

The child elements that are used in the RDB\_node element depend on the context of the node and use the following rules:

If the node type is:	The following RDB child elements are used:		
	Table	Column	Condition
Root element	Yes	No	Yes <sup>1</sup>
Attribute	Yes	Yes	Optional
Text	Yes	Yes	Optional

<sup>1</sup> Required to show relationships between multiple tables.

**Restriction:** If you compose your XML collections using RDB\_node mapping, all statements of a given element must map to columns in the same table.

### Procedure:

To prepare a DAD file to use for decomposing an XML document using the RDB\_node mapping:

- Start with a XML file that includes the following items:
  - The following header, where *path/dad.dtd* is the path and file name of the DTD for the DAD:
 

```

<?xml version="1.0"?>
<!DOCTYPE DAD SYSTEM "path/dad.dtd">

```
  - The <DAD></DAD> tags. This element contains all other elements.
- Insert the tags used for validating the DAD with a DTD or schema:

- To validate the XML document with a DTD, insert the dtdid tag that associates the DAD file with the XML document DTD. For example:  
`<dtdid>dtd_name</dtdid>`
- To validate the XML document with a schema, insert the schemabindings tag that associates the DAD file with the schema file. For example:  
`<schemabindings>  
<nonamespace location="path/schema_name.xsd"/>  
</schemabindings>`

The dtdid or schema is useful only if you decide to validate the XML document. Use the validation tag to indicate whether DB2 UDB XML Extender validates the XML document:

- If you want to validate the XML document, then type:  
`<validation>YES</validation>`
  - If you do not want to validate the XML document type:  
`<validation>NO</validation>`
3. Insert `<XCollection>` `</XCollection>` tags to specify that you are using XML collections as the access and storage method for your XML data.
  4. Add the following prolog information. If you need to specify an encoding value for internationalization, add the ENCODING attribute and value.  
`<prolog?xml version="1.0"?</prolog>`
  5. Add the `<doctype>` `</doctype>` tag. For example:  
`<doctype>! DOCTYPE Order SYSTEM "dxsample/dtd/getstart.dtd"</doctype>`
  6. Define the root\_node using the `<root_node>` `</root_node>` tag.
  7. Inside the root\_node, map the elements and attributes in the XML document to element nodes and attribute nodes that correspond to DB2 UDB data. These nodes provide a path from the XML data to the DB2 UDB data.
    - a. Define a top level, root element\_node. This element\_node contains:
      - Table elements with a join condition to specify the collection.
      - Child elements
      - Attributes

To specify the table and condition:

- 1) Create an RDB\_node element within an element\_node element. For example:

```
<element_node name="name">
 <RDB_node>
 </RDB_node>
</element_node>
```

- 2) Define a `<table>` element for each table that contains data to be included in the XML document. For example, if you have three tables, ORDER\_TAB, PART\_TAB, and SHIP\_TAB, that have column data to be in the document, create a table node for each. For example:

```
<RDB_node>
 <table name="ORDER_TAB">
 <table name="PART_TAB">
 <table name="SHIP_TAB">
</RDB_node>
```

- 3) Define a join condition for the tables in the collection. The syntax is:

```
table_name.table_column = table_name.table_column AND
table_name.table_column = table_name.table_column ...
```

For example:

```

<RDB_node>
<table name="ORDER_TAB">
<table name="PART_TAB">
<table name="SHIP_TAB">
<condition>
 order_tab.order_key = part_tab.order_key AND
 part_tab.part_key = ship_tab.part_key
</condition>
</RDB_node>

```

- 4) Optional: Specify a primary key for each table. The primary key consists of a single column or multiple columns, called a composite key. To specify the primary key, add an attribute key to the table element of the RDB\_node. The following example defines a primary key for each of the tables in the RDB\_node of the root element\_node Order:

```

<element_node name="Order">
 <RDB_node>
 <table name="order_tab" key="order_key"/>
 <table name="part_tab" key="part_key price"/>
 <table name="ship_tab" key="date mode"/>
 <condition>
 order_tab.order_key = part_tab.order_key AND
 part_tab.part_key = ship_tab.part_key
 </condition>
 </RDB_node>

```

The key attribute is required for decomposition and enabling a collection.

- b. Define an <element\_node> tag for each element in your XML document that maps to a column in a DB2 UDB table. For example:

```

<element_node name="name">
</element_node>

```

An element node can have one of the following types of elements:

**text\_node** To specify that the element has content to a DB2 UDB table. It does not have child elements.

**attribute\_node** To specify an attribute.

**child elements** Children of the element\_node.

The text\_node contains an RDB\_node to map content to a DB2 UDB table and column name.

For example, to fetch the content of a column called TAX to create an XML element, <tax>.

**XML document:**

```

<Tax>0.02</Tax>

```

In this case, you want the value 0.02 to be fetched in the column TAX.

In the DAD file, you specify an <RDB\_node> tag to map the XML element to the DB2 UDB table and column.

**DAD file:**

```

<element_node name="Tax">
 <text_node>
 <RDB_node>
 <table name="part_tab"/>

```

```

 <column name="tax"/>
 </RDB_node>
</text_node>
</element_node>

```

The <RDB\_node> tag specifies that the value of the Tax element is a text value, the data is stored in the PART\_TAB table in the TAX column.

- c. Define an <attribute\_node> tag for each attribute in your XML document that maps to a column in a DB2 UDB table. For example:

```

<attribute_node name="key">
</attribute_node>

```

The attribute\_node has an RDB\_node to map the attribute value to a DB2 UDB table and column.

For example, you might have an attribute key for an element <Order>. The value key must be fetched from a column PART\_KEY. The XML document looks like this:

```

<Order key="1">

```

**XML document:** In the DAD file, create an attribute\_node for key and indicate the table where the value of 1 is to be fetched.

**DAD file:**

```

<attribute_node name="key">
 <RDB_node>
 <table name="part_tab">
 <column name="part_key"/>
 </RDB_node>
 </attribute_node>

```

8. Optional: Specify the column type for the RDB\_node for each attribute\_node and text\_node. By doing so, you can use the DAD for both composition and decomposition. In composition, specifying the column type does not result in any additional data type checking. To specify the column types, add the attribute type to the column element. The following example defines the column type as an INTEGER:

```

<attribute_node name="key">
 <RDB_node>
 <table name="order_tab"/>
 <column name="order_key" type="integer"/>
 </RDB_node>
</attribute_node>

```

9. Ensure that the ending tags are in the appropriate places:
  - a. Ensure that an ending </root\_node> tag is after the last </element\_node> tag.
  - b. Ensure that an ending </Xcollection> tag is after the </root\_node> tag.
  - c. Ensure that an ending </DAD> tag is after the </Xcollection> tag.

Call the dxxGenXML stored procedure to compose using the DAD. For information on dxxGenXML, see “dxxGenXML() stored procedure” on page 183.

**Related concepts:**

- “Mapping schemes for XML collections” on page 102
- “Location paths” on page 110
- “DAD files for XML collections” on page 161
- “Requirements for RDB\_Node mapping” on page 106
- “XML Extender composition stored procedures - Overview” on page 183

### Related tasks:

- “Decomposing an XML collection by using RDB\_node mapping” on page 66
- “Managing data in XML collections” on page 90

## Decomposing an XML collection by using RDB\_node mapping

You must first create a DAD file. Use the <RDB\_node> to specify DB2 UDB tables, columns, and conditions for an element or attribute node. The <RDB\_node> uses the following elements:

<b>table</b>	Defines the table that corresponds to the element.
<b>column</b>	Defines the column that contains the corresponding element.
<b>condition</b>	Optionally specifies a condition on which insertion into the column occurs.

The child elements that are used in the <RDB\_node> depend on the context of the node and use the following rules:

If the node type is:	RDB child element is used:		
	Table	Column	Condition
Root element	Yes	No	Yes <sup>1</sup>
Attribute	Yes	Yes	optional
Text	Yes	Yes	optional

<sup>1</sup> Required to show relationships between multiple tables.

### Procedure:

To prepare a DAD file to use for decomposing an XML document using the RDB\_node mapping:

1. Create a file in any text editor. Create a DAD header by typing the following syntax:

```
<?xml version="1.0"?>
<!DOCTYPE DAD SYSTEM "path/dad.dtd">
```

Where *path/dad.dtd* is the path and file name of the DTD for the DAD.

The DAD file must be either stored in an Integrated File System (IFS) directory, or created as a physical file member with a link in the IFS directory pointing to the member.

2. Insert the <DAD> </DAD> tags.
3. Insert the tags used for validating the DAD with a DTD or schema.
  - To validate the XML document with a DTD, insert the dtdid tag that associates the DAD file with the XML document DTD. For example:  

```
<dtdid>dtd_name</dtdid>
```
  - To validate the XML document with a schema, insert the schemabinding tag that associates the DAD file with the schema file. For example:  

```
<schemabindings>
<nonamespacelocation location="path/schema_name.xsd"/>
</schemabindings>
```



The dtdid or schema is useful only if you decide to validate the XML document. Use the validation tag to indicate whether DB2 UDB XML Extender validates the XML document:

- If you want to validate the XML document, then type:  
`<validation>YES</validation>`
- If you do not want to validate the XML document type:  
`<validation>NO</validation>`

4. Insert `<XCollection>` `</XCollection>` tags to specify that you are using XML collections as the access and storage method for your XML data.
5. Add the following prolog information. If you need to specify an encoding value for internationalization, add the `ENCODING` attribute and value.  
`<prolog>?xml version="1.0"?</prolog>`
6. Add the `<doctype>``</doctype>` tags. For example:  
`<doctype>! DOCTYPE Order SYSTEM "dxxsample/dtd/getstart.dtd"</doctype>`
7. Define the `root_node` using the `<root_node>` `</root_node>` tags.
8. Inside the `root_node`, map the elements and attributes in the XML document to element nodes and attribute nodes that correspond to DB2 UDB data. These nodes provide a path from the XML data to the DB2 UDB data.
  - a. Define a top level, root element `node`. This `node` contains:
    - Table elements with a join condition to specify the collection.
    - Child elements
    - Attributes

To specify the table and condition:

- 1) Create an `RDB_node` element within an `element_node` element. For example:

```
<element_node name="name">
 <RDB_node>
 </RDB_node>
</element_node>
```

- 2) Define a `<table>` element for each table that contains data to be included in the XML document. For example, if you have three tables, `ORDER_TAB`, `PART_TAB`, and `SHIP_TAB`, that have column data to be in the document, create a table node for each. For example:

```
<RDB_node>
 <table name="ORDER_TAB">
 <table name="PART_TAB">
 <table name="SHIP_TAB">
</RDB_node>
```

- 3) Define a join condition for the tables in the collection. The syntax is:

```
table_name.table_column = table_name.table_column AND
table_name.table_column = table_name.table_column ...
```

For example:

```
<RDB_node>
 <table name="ORDER_TAB">
 <table name="PART_TAB">
 <table name="SHIP_TAB">
 <condition>
 order_tab.order_key = part_tab.order_key AND
 part_tab.part_key = ship_tab.part_key
 </condition>
</RDB_node>
```

- 4) Optional: Specify a primary key for each table. The primary key consists of a single column or multiple columns, called a composite key. To specify the primary key, add an attribute key to the table element of the RDB\_node. The following example defines a primary key for each of the tables in the RDB\_node of the root element\_node Order:

```
<element_node name="Order">
 <RDB_node>
 <table name="order_tab" key="order_key"/>
 <table name="part_tab" key="part_key price"/>
 <table name="ship_tab" key="date mode"/>
 <condition>
 order_tab.order_key = part_tab.order_key AND
 part_tab.part_key = ship_tab.part_key
 </condition>
 </RDB_node>
```

The key attribute is required for decomposition and enabling a collection.

- b. Define an <element\_node> tag for each element in your XML document that maps to a column in a DB2 UDB table. For example:

```
<element_node name="name">
</element_node>
```

An element node can have one of the following types of elements:

**text\_node** To specify that the element has content to a DB2 UDB table. It does not have child elements.

**attribute\_node** To specify an attribute.

**child elements** Children of the element\_node.

The text\_node contains an RDB\_node to map content to a DB2 UDB table and column name.

For example, you might have an XML element <Tax> for which you want to store the untagged content into a column called TAX. For example, the XML document would look like this:

```
<Tax>0.02</Tax>
```

In this case, you want the value 0.02 to be stored in the column TAX.

In the DAD file, you specify an <RDB\_node> tag to map an XML document or attribute values to the DB2 UDB table and column name.

**DAD file:**

```
<element_node name="Tax">
 <text_node>
 <RDB_node>
 <table name="part_tab"/>
 <column name="tax"/>
 </RDB_node>
 </text_node>
</element_node>
```

The <RDB\_node> tag specifies that the value of the Tax element is a text value, the data is stored in the PART\_TAB table in the TAX column.

- c. Define an <attribute\_node> tag for each attribute in your XML document that maps to a column in a DB2 UDB table. For example:

```
| <attribute_node name="key">
| </attribute_node>
```

The attribute\_node has an RDB\_node to map the attribute value to a DB2 UDB table and column.

For example, you might have an attribute key for an Order element. The value key needs to be stored in a column PART\_KEY.

**XML document:**

```
| <Order key="1">
```

In the DAD file, create an attribute\_node for key and indicate the table where to store the value of 1.

**DAD file:**

```
| <attribute_node name="key">
| <RDB_node>
| <table name="part_tab">
| <column name="part_key"/>
| </RDB_node>
| </attribute_node>
```

9. Specify the column type for the RDB\_node for each attribute\_node and text\_node. This ensures the correct data type for each column where the untagged data will be stored. To specify the column types, add the attribute type to the column element. The following example defines the column type as an INTEGER:

```
| <attribute_node name="key">
| <RDB_node>
| <table name="order_tab"/>
| <column name="order_key" type="integer"/>
| </RDB_node>
| </attribute_node>
```

10. Ensure that the ending tags are in the appropriate places:
- Ensure that an ending </root\_node> tag is after the last </element\_node> tag.
  - Ensure that an ending </Xcollection> tag is after the </root\_node> tag.
  - Ensure that an ending </DAD> tag is after the </Xcollection> tag.

Call the dxxShredXML stored procedure to decompose using the DAD. For information on dxxShredXML, see “dxxShredXML() stored procedure” on page 194.

**Related concepts:**

- “XML Extender decomposition stored procedures - Overview” on page 194

**Related tasks:**

- “Decomposing XML documents into DB2 UDB data” on page 94
- “Calling XML Extender stored procedures” on page 177



---

## **Part 3. Programming**

This part describes programming techniques for managing your XML data.



---

## Chapter 3. XML columns

This section describes how to manage data in XML columns using DB2.

---

### Managing data in XML columns

When you use XML columns to store data, you store an entire XML document in its native format as column data in DB2. This access and storage method allows you to keep the XML document intact, while giving you the ability to index and search the document, retrieve data from the document, and update the document.

After you enable a database for XML, the following user-defined types (UDTs), provided by XML Extender, are available for your use:

#### **XMLCLOB**

Use this UDT for XML document content that is stored as a character large object (CLOB) in DB2.

#### **XMLVARCHAR**

Use this UDT for XML document content that is stored as a VARCHAR in DB2.

#### **XMLFILE**

Use this UDT for an XML document that is stored in a file on a local file system.

You can create or alter application tables to have columns of XML UDT data type. These tables are known as XML tables.

After you enable a column in a table for XML, you can create the XML column and perform the following management tasks:

- Store XML documents in DB2
- Retrieve XML data or documents from DB2
- Update XML documents
- Delete XML data or documents

To perform all of these tasks, use the user-defined functions (UDFs) provided by XML Extender. Use default casting functions to store XML documents in DB2. Default casting functions cast the SQL base type to the XML Extender user-defined types and convert instances of a data type (origin) into instances of a different data type (target).

#### **Related concepts:**

- “XML columns as a storage and access method” on page 73
- “Using indexes for XML column data” on page 75

---

### XML columns as a storage and access method

There will be times when you want to store and maintain the document structure as it currently is. XML contains all the necessary information to create a set of documents.

For example, if you are a news publishing company that serves articles over the Web, you might want to maintain an archive of published articles. In such a scenario, XML Extender lets you store your complete or partial XML articles in a column of a DB2® table, which is the *XML column*, as shown in Figure 9.

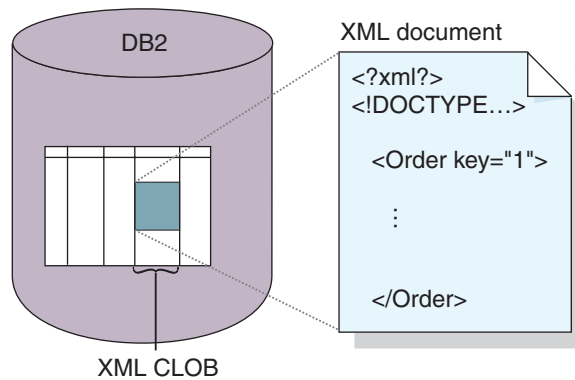

Figure 9. Storing structured XML documents in a DB2 UDB table column

The XML column storage and access method allows you to manage your XML documents using DB2. You can store XML documents in a column of XML type and you can query the contents of the document to find a specific element or attribute. You can associate and store a DTD in DB2 UDB for one or more documents. Additionally, you can map element and attribute content to DB2 UDB tables, called *side tables*. These side tables can be indexed for improved query performance, but are not indexed automatically. The column that is used to store the document is called an XML column. It specifies that the column is used for the XML column storage and access method.

In the document access definition (DAD) file you enter `<Xcolumn>` and `</Xcolumn>` tags to denote that the storage and access method that you will use is XML column. The DAD will then map the XML element and attribute content to be stored in side tables.

Before you begin working with XML Extender to store your documents, you need to understand the structure of the XML document so that you can determine how to index elements and attributes in the document. When planning how to index the document, you need to determine:

- The XML user-defined type in which you will store the XML document
- The XML elements and attributes that your application will frequently search, so that their content can be stored in side tables and indexed to improve performance
- Whether or not you want to validate XML documents in the column with a DTD

---

## Defining and enabling an XML column

You use XML columns to store and access entire XML documents in the database. This storage method allows you to store documents using the XML file types, index the columns in side tables, and query or search XML documents.

Use XML columns when you want to store entire XML documents into a DB2 table column if the document is not going to be frequently updated or if you want to store intact XML documents.



If you want to map XML document structures to DB2 UDB tables so that you can compose XML documents from existing DB2 UDB data or decompose XML documents into DB2 data, then you should use XML collections instead of XML columns.

**Procedure:**

To define and enable an XML column from the command line:

1. Create a document access definition (DAD) file.
2. Create a table in which the XML documents are stored.
3. Index side tables.

The XML column is created as an XML user data type. After these tasks are complete, you will be able to store XML documents in the column. These documents can then be updated, searched, and extracted.

**Related concepts:**

- “XML columns as a storage and access method” on page 73
- “Using indexes for XML column data” on page 75
- “Validating XML documents automatically” on page 51
- “Lesson: Storing an XML document in an XML column” on page 8

**Related tasks:**

- “Creating a DAD file for XML columns” on page 159
- “Creating an XML table” on page 52
- “Indexing side tables” on page 58
- “Managing data in XML columns” on page 73

---

## Using indexes for XML column data

An important planning decision when using XML columns, is whether to index the side tables for XML column documents. This decision should be made based on how often you need to access the data and how critical performance is during structural searches.

When using XML columns, which contain entire XML documents, you can create side tables to contain columns of XML element or attribute values, then create indexes on these columns. You must determine the elements and attributes for which you need to create the index.

XML column indexing allows frequently queried data of general data types (such as integer, decimal, or date) to be indexed using the native DB2® index support from the database engine. The XML Extender extracts the values of XML elements or attributes from XML documents and stores them in the side tables, allowing you to create indexes on these side tables. You can specify each column of a side table with a location path that identifies an XML element or attribute and an SQL data type.

The XML Extender automatically populates the side table when you store XML documents in the XML column.

For fast search, create indexes on these columns using the DB2 UDB *B-tree indexing* technology. See the DB2 UDB documentation for more information on *B-tree indexing*.

You must keep the following considerations in mind when creating an index:

- For elements or attributes in an XML document that have *multiple occurrences*, you must create a separate side table for each XML element or attribute with multiple occurrences due to the complex structure of XML documents.
- You can create multiple indexes on an XML column.
- You can associate side tables with the application table using the ROOT ID, the column name of the primary key in the application table and a unique identifier that associates all side tables with the application table. You can decide whether you want the primary key of the application table to be the ROOT ID, although it cannot be the composite key. This method is recommended.

If the single primary key does not exist in the application table, or for some reason you don't want to use it, XML Extender alters the application table to add a column DXXROOT\_ID, which stores a unique ID that is created at the insertion time. All side tables have a DXXROOT\_ID column with the unique ID. If the primary key is used as the ROOT ID, all side tables have a column with the same name and type as the primary key column in the application table, and the values of the primary keys are stored.

- If you enable an XML column for the DB2 UDB Net Search Extender, you can also use the Net Search Extender's structural-text feature. The Net Search Extender has "*section search*" support, which extends the capability of a conventional full-text search by allowing search words to be matched within a specific document context that is specified by location paths. The *structural-text index* can be used with XML Extender's indexing on general SQL data types.

---

## Storing XML data

Using XML Extender, you can insert intact XML documents into an XML column. If you define side tables, XML Extender automatically updates these tables. When you store an XML document directly, XML Extender stores the base type as an XML type.

### Prerequisites:

- Ensure that you created or updated the DAD file.
- Determine what data type to use when you store the document.
- Choose a method (casting functions or UDFs) for storing the data in the DB2<sup>®</sup> table.

Specify an SQL INSERT statement that specifies the XML table and column to contain the XML document.

The XML Extender provides two methods for storing XML documents: default casting functions and storage UDFs.

Table 11 shows when to use each method.

Table 11. The XML Extender storage functions

If the DB2 UDB base type is ...	Store in DB2 UDB as ...			
	XMLVARCHAR	XMLCLOB	XMLDBCLOB	XMLFILE
VARCHAR	XMLVARCHAR()	N/A	N/A	XMLFileFromVarchar()
CLOB	N/A	XMLCLOB()	XMLDBCLOB, casting function	XMLFileFromCLOB()
FILE	XMLVarcharFromFile()	XMLCLOBFromFile()	XMLDBCLOBFromFile, UDF	XMLFILE

## Default casting functions for storing XML data

For each UDT, a default casting function exists to cast the SQL base type to the UDT. You can use the casting functions provided by XML Extender in your VALUES clause to insert data. Table 12 shows the provided casting functions:

Table 12. The XML Extender default casting functions

Casting function	Return type	Description
XMLVARCHAR(VARCHAR)	XMLVARCHAR	Input from memory buffer of VARCHAR
XMLCLOB(CLOB)	XMLCLOB	Input from memory buffer of CLOB or a CLOB locator
XMLFILE(VARCHAR)	XMLFILE	Store only the file name

For example, the following statement inserts a cast VARCHAR type into the XMLVARCHAR type:

```
EXEC SQL INSERT INTO sales_tab
VALUES('123456', 'Sriram Srinivasan', DB2XML.XMLVarchar(:xml_buff))
```

## Storage UDFs for storing XML data

For each XML Extender UDT, a storage UDF exists to import data into DB2 from a resource other than its base type. For example, if you want to import an XML file document to DB2 UDB as an XMLCLOB data type, you can use the function XMLCLOBFromFile().

Table 13 shows the storage functions provided by the XML Extender.

Table 13. The XML Extender storage UDFs

Storage user-defined function	Return type	Description
XMLVarcharFromFile()	XMLVARCHAR	Reads an XML document from a file on the server and returns the value of the XMLVARCHAR data type. Optional: Specify the encoding of the file.

Table 13. The XML Extender storage UDFs (continued)

Storage user-defined function	Return type	Description
XMLCLOBFromFile()	XMLCLOB	Reads an XML document from a file on the server and returns the value of the XMLCLOB data type. Optional: Specify the encoding of the file.
XMLFileFromVarchar()	XMLFILE	Reads an XML document from memory as VARCHAR data, writes the document to an external file, and returns the value of the XMLFILE data type, which is the file name. Optional: Specify the encoding of the external file.
XMLFileFromCLOB()	XMLFILE	Reads an XML document from memory as CLOB data or as a CLOB locator, writes the document to an external file, and returns the value of the XMLFILE data type, which is the file name. Optional: Specify the encoding of the external file.

For example, using the XMLCLOBFromFile() function, the following statement stores a record in an XML table as an XMLCLOB:

```
EXEC SQL INSERT INTO sales_tab(ID, NAME, ORDER)
VALUES('1234', 'MyName',
XMLCLOBFromFile('/dxxsamples/xml/getstart.xml'))
```

The example imports the XML document from the file named /dxxsamples/xml/getstart.xml into the column ORDER in the table SALES\_TAB.

## Method for retrieving an XML document

Using XML Extender, you can retrieve either an entire document or the contents of elements and attributes. When you retrieve an XML column directly, the XML Extender returns the UDT as the column type. For details about retrieving data, see the following sections:

- “Retrieving an entire XML document” on page 79
- “Retrieving element contents and attribute values from XML documents” on page 81

The XML Extender provides two methods for retrieving data: default casting functions and the Content() overloaded UDF. Table 14 on page 79 shows when to use each method.

Table 14. The XML Extender retrieval functions

When the XML type is ...	Retrieve from DB2 UDB as ...			
	VARCHAR	CLOB	DBCLOB	FILE
XMLVARCHAR	VARCHAR	N/A	N/A	Content() UDF
XMLCLOB	N/A	XMLCLOB	N/A	Content() UDF
XMLFILE	N/A	Content() UDF	N/A	FILE

## Retrieving an entire XML document

### Procedure:

To retrieve an entire XML document:

1. Ensure that you stored the XML document in an XML table and determine what data you want to retrieve.
2. Choose a method (casting functions or UDFs) for retrieving the data in the DB2 UDB table.
3. If you are using the overloaded Content() UDF, determine the data type of the data that is being retrieved, and which data type is to be exported.
4. The XML column from which the element or attribute is to be extracted must be defined as either an XMLVARCHAR, XMLCLOB as LOCATOR, or XMLFILE data type.

Specify an SQL query that specifies the XML table and column from which to retrieve the XML document.

### Default casting functions for retrieving XML data

The default casting function provided by DB2 UDB for UDTs converts an XML UDT to an SQL base type, and then operates on it. In your SELECT statement, you can use the casting functions that are provided by XML Extender to retrieve data. Table 15 shows the provided casting functions.

Table 15. The XML Extender default cast functions

Casting used in SELECT clause	Return type	Description
varchar(XMLVARCHAR)	VARCHAR	XML document in VARCHAR
clob(XMLCLOB)	CLOB	XML document in CLOB
varchar(XMLFile)	VARCHAR	XML file name in VARCHAR

For example, the following SQL statement retrieves the XMLVARCHAR column, order, from the SALES\_TAB table, casts the column to VARCHAR, and finally passes the column as a parameter to the LENGTH function. The LENGTH function does not accept a parameter of type XMLVARCHAR, which requires casting.

```
SELECT DB2XML.XMLVarchar(order) from SALES_TAB
```

### Using the Content() UDF for retrieving XML data

Use the Content() UDF to retrieve the document content from external storage to memory, or export the document from internal storage to an external file, which is a file that is external to DB2 UDB on the DB2 UDB server.

For example, you might have your XML document stored as an XMLFILE data type. If you want to operate on it in memory, you can use the Content() UDF, which can take an XMLFILE data type as input and return a CLOB.

The Content() UDF performs two different retrieval functions, depending on the specified data type. It can:

- Retrieve a document from external storage and put it in memory.

You can use Content() UDF to retrieve the XML document to a memory buffer or a CLOB *locator* (a host variable with a value that represents a single LOB value in the database server) when the document is stored as the external file.

Use the following function syntax, where *xmlobj* is the XML column being queried:

**XMLFILE to CLOB:**

Content(*xmlobj* XMLFile)

- Retrieve a document from internal storage and export it to an external file.

You can use the Content() UDF to retrieve an XML document that is stored inside DB2 UDB as an XMLCLOB data type and export it to a file on the database server file system. The Content() UDF returns the name of the file as a VARCHAR data type.

Use the following function syntax:

**XML type to external file:**

Content(*xmlobj* XML type, *filename* varchar(512), *targetencoding* varchar(100))

Where:

*xmlobj* Is the name of the XML column from which the XML content is to be retrieved. *xmlobj* can be of type XMLVARCHAR or XMLCLOB.

*filename*

Is the name of the external file in which the XML data is to be stored.

*targetencoding*

Optional: Specifies the encoding of the output file.

In the example below, a small C program segment with embedded SQL statements (SQL statements coded within an application program) shows how an XML document is retrieved from a file to memory. This example assumes that the data type of the ORDER column is XMLFILE.

```
EXEC SQL BEGIN DECLARE SECTION;
 SQL TYPE IS CLOB_LOCATOR xml_buff;
EXEC SQL END DECLARE SECTION;
EXEC SQL CONNECT TO SALES_DB;
EXEC SQL DECLARE c1 CURSOR FOR
 SELECT Content(order) from sales_tab
EXEC SQL OPEN c1;
 do {
EXEC SQL FETCH c1 INTO :xml_buff;
 if (SQLCODE != 0) {
 break;}
 else { /* do whatever you need to do with the XML doc in buffer */}
 }
EXEC SQL CLOSE c1;
EXEC SQL CONNECT RESET;
```

## Retrieving element contents and attribute values from XML documents

You can retrieve (extract) the content of an element or the value of an attribute from one or more XML documents (single document or collection document search). The XML Extender provides user-defined extracting functions that you can specify in the SQL SELECT clause for each of the SQL data types.

Retrieving element content and attribute values is useful when developing your applications, because you can access XML data as relational data. For example, you might have 1000 XML documents that are stored in the ORDER column in the SALES\_TAB table. To retrieve the names of all customers who have ordered items over \$2500, use the following SQL statement with the extracting UDF in the SELECT clause:

```
SELECT extractVarchar(Order, '/Order/Customer/Name') from sales_order_view
WHERE price > 2500.00
```

In this example, the extracting UDF retrieves the content of the <customer> element from the ORDER column and stores it as a VARCHAR data type. The location path is /Order/Customer/Name. Additionally, the number of returned values is reduced by using a WHERE clause, which specifies that only the contents of the <customer> element with a sub-element <ExtendedPrice> that has a value greater than 2500.00.

Table 16 on page 82 shows the UDFs that you can use to extract element content and attribute values, using the following syntax for scalar functions.

### Syntax:

`extract` *retrieved\_datatype*(*xmlobj*, *path*)

*retrieved\_datatype*

The data type that is returned from the extracting function; it can be one of the following types:

- INTEGER
- SMALLINT
- DOUBLE
- REAL
- CHAR
- VARCHAR
- CLOB
- DATE
- TIME
- TIMESTAMP

*xmlobj* The name of the XML column from which the element or attribute is to be extracted. This column must be defined as one of the following XML user-defined types:

- XMLVARCHAR
- XMLCLOB as LOCATOR
- XMLFILE

*path* The location path of the element or attribute in the XML document (such as /Order/Customer/Name).

**Restriction:** Extracting UDFs can support location paths that have predicates with attributes, but not elements. For example, the following predicate is supported:

```
'/Order/Part[@color="black "]/ExtendedPrice'
```

The following predicate is not supported:

```
'/Order/Part/Shipment/[Shipdate < "11/25/00"]'
```

Table 16 shows the extracting functions, both in scalar and table format.

*Table 16. The XML Extender extracting functions*

Scalar function	Returned column name (table function)	Return type
extractInteger()	returnedInteger	INTEGER
extractSmallint()	returnedSmallint	SMALLINT
extractDouble()	returnedDouble	DOUBLE
extractReal()	returnedReal	REAL
extractChar()	returnedChar	CHAR
extractVarchar()	returnedVarchar	VARCHAR
extractCLOB()	returnedCLOB	CLOB
extractDate()	returnedDate	DATE
extractTime()	returnedTime	TIME
extractTimestamp()	returnedTimestamp	TIMESTAMP

**Scalar function example:** In the following example, one value is inserted with the attribute key value of 1. The value is extracted as an integer and automatically converted to a DECIMAL type.

```
CREATE TABLE t1(key decimal(3,2));
INSERT into t1
 (SELECT db2xml.extractInteger(db2xml.xmlfile('/dxsamples/xml/getstart.xml'),
 '/Order[@Key="1"]/@Key')
 FROM db2xml.onerow) ;
SELECT * from t1;
```

**Table function example:** In the following example, each key value (@Key) for the sales order is extracted as an INTEGER.

```
SELECT * from table(DB2XML.extractIntegers(DB2XML.XMLFile
 ('/dxsamples/xml/getstart.xml'), '/Order/@Key')) as x;
```

---

## Updating XML data

With XML Extender, you can update the entire XML document by replacing the XML column data, or you can update the values of specified elements or attributes.

### Procedure

To update XML data:

1. The XML document must be stored in an XML table.
2. You must know what data you want to retrieve.
3. You must choose a method for updating the data in the DB2 UDB table (casting functions or UDFs).
4. Specify an SQL query that specifies the XML table and column to update.



## Updating an entire XML document

You can update an XML document by using a default casting function, or by using a storage UDF.

### Updating with a default casting function

For each user-defined type (UDT), a default casting function exists to cast the SQL base type to the UDT. You can use the XML Extender-provided casting functions to update the XML document.

For example, the following statement updates the XMLVARCHAR type from the cast VARCHAR type, assuming that `xml_buf` is a host variable that is defined as a VARCHAR type.

```
EXEC SQL UPDATE sales_tab SET=DB2XML.XMLVarchar(:xml_buf)
```

### Updating XML documents with a storage UDF

For each of the XML Extender UDTs, a storage UDF exists to import data into DB2 UDB from a resource other than its base type. You can use a storage UDF to update the entire XML document by replacing it.

The following example updates the XML object from the file named `/dxxsamples/xml/getstart.xml` to the ORDER column in the SALES\_TAB table.

```
UPDATE sales_tab
 set order = db2xml.XMLVarcharFromFile('
/dxxsamples/xml/getstart.xml')
WHERE sales_person = 'MyName'
```

## Updating specific elements and attributes of an XML document

Use the Update UDF to make specific changes, rather than updating the entire document. When you use this UDF, you specify the location path of the element or attribute whose value will be replaced. You do not need to edit the XML document; XML Extender makes the change for you.

### Syntax:

```
Update(xmlobj, path, value)
```

The syntax has the following components:

*xmlobj* The name of the XML column for which the value of the element or attribute is to be updated.

*path* The location path of the element or attribute that is to be updated.

*value* The new value that is to be updated.

For example, the following statement replaces the value of the <Customer> element with IBM:

```
UPDATE sales_tab
 set order = db2xml.Update(order, '/Order/Customer/Name', 'IBM')
WHERE sales_person = 'Sriram Srinivasan'
```

**Multiple occurrence:** When you specify a location path in the Update UDF, the content of every element or attribute with a matching path is updated with the supplied value. If a location path occurs in a document more than once, the Update UDF replaces all of the existing values with the value provided in the *value* parameter.

---

## Methods for searching XML documents

Searching XML data is similar to retrieving XML data: both techniques retrieve data for further manipulation but they search by using the content of the WHERE clause as the criteria for retrieval.

The XML Extender provides several methods for searching XML documents that are stored in an XML column. You can:

- Search document structure and return results based on element content or attribute values.
- Search a view of the XML column and its side tables.
- Search the side tables directly for better performance.
- Search using extracting UDFs with WHERE clauses.
- Use the DB2<sup>®</sup> Net Search Extender to search column data within the structural content for a text string.

With XML Extender you can use indexes to quickly search columns in side tables. These columns contain XML element content or attribute values that are extracted from XML documents. By specifying the data type of an element or attribute, you can search on an SQL data type or do range searches. For example, in the purchase order example, you could search for all orders that have an extended price of over 2500.00.

Additionally, you can use the Net Search Extender to do structural text search or full text search. For example, you might have a column called RESUME that contains resumes in XML format. If you want to find the names of all applicants who have Java<sup>™</sup> skills, you could use the DB2 UDB Net Search Extender to search on the XML documents for all resumes where the <skill> element contains the character string "JAVA".

The following section describes search methods:

- "Searching the XML document by structure"

### Searching the XML document by structure

Using XML Extender search features, you can search XML data in a column based on the document structure (the elements and attributes in the document).

#### Procedures:

To search the data, you can:

- Directly query the side tables.
- Use a *joined view*.
- Use extracting UDFs.

These search methods are described in the following examples are based on the following scenario. The SALES\_TAB table has an XML column named ORDER. This column has three side tables, ORDER\_SIDE\_TAB, PART\_SIDE\_TAB, and SHIP\_SIDE\_TAB. A default view, sales\_order\_view, was specified when the ORDER column was enabled. This view joins these tables using the following CREATE VIEW statement:

```
CREATE VIEW sales_order_view(invoice_num, sales_person, order,
 order_key, customer, part_key, price, date)
AS
```

```

SELECT sales_tab.invoice_num, sales_tab.sales_person, sales_tab.order,
 order_side_tab.order_key, order_side_tab.customer,
 part_side_tab.part_key, ship_side_tab.date
FROM sales_tab, order_side_tab, part_side_tab, ship_side_tab
WHERE sales_tab.invoice_num = order_side_tab.invoice_num
 AND sales_tab.invoice_num = part_side_tab.invoice_num
 AND sales_tab.invoice_num = ship_side_tab.invoice_num

```

### Example: searching with direct query on side tables

Direct query with subquery search provides the best performance for a structural search when the side tables are indexed.

#### Procedure:

You can use a query or subquery to search side tables correctly.

For example, the following statement uses a query and subquery to directly search a side table:

```

SELECT sales_person from sales_tab
WHERE invoice_num in
 (SELECT invoice_num from part_side_tab
 WHERE price > 2500.00)

```

In this example, invoice\_num is the primary key in the SALES\_TAB table.

### Example: searching from a joined view

The XML Extender can create a default view that joins the application table and the side tables using a unique ID. You can use this default view, or any view that joins an application table and side tables, to search column data and query the side tables. This method provides a single virtual view of the application table and its side tables. However, the more side tables that are created, the longer the query takes to run.

**Tip:** You can use the root ID, or DXXROOT\_ID (created by XML Extender), to join the tables when you create your own view.

For example, the following statement searches the view named SALES\_ORDER\_VIEW and returns the values from the SALES\_PERSON column where the line item orders have a price greater than 2500.00.

```

SELECT sales_person from sales_order_view
WHERE price > 2500.00

```

### Example: searching with extracting UDFs

You can also use XML Extender's extracting UDFs to search on elements and attributes, when you did not create indexes or side tables for the application table. Using the extracting UDFs to scan the XML data is expensive and should only be used with WHERE clauses that restrict the number of XML documents that are included in the search.

The following statement searches with an extracting XML Extender UDF:

```

SELECT sales_person from sales_tab
WHERE extractVarchar(order, '/Order/Customer/Name')
 like '%IBM%'
AND invoice_num > 100

```

In this example, the extracting UDF extracts </Order/Customer/Name> elements that contain the substring IBM®.

### Example: searching on elements or attributes with multiple occurrence

When you search on elements or attributes that have multiple occurrence, use the DISTINCT clause to prevent duplicate values.

The following statement searches with the DISTINCT clause:

```
SELECT sales_person from sales_tab
 WHERE invoice_num in
 (SELECT DISTINCT invoice_num from part_side_tab
 WHERE price > 2500.00)
```

In this example, the DAD file specifies that /Order/Part/Price has multiple occurrence and creates a side table, PART\_SIDE\_TAB, for it. The PART\_SIDE\_TAB table might have more than one row with the same invoice\_num. Using DISTINCT returns only unique values.

---

## Deleting XML documents

Use the SQL DELETE statement to delete the row containing an XML document from an XML column. You can specify a WHERE clause to delete specific documents.

For example, the following statement deletes all documents that have a value for <ExtendedPrice> greater than 2500.00:

```
DELETE from sales_tab
 WHERE invoice_num in
 (SELECT invoice_num from part_side_tab
 WHERE price > 2500.00)
```

The corresponding rows in the side tables are automatically deleted.

---

## Limitations when invoking functions from Java Database (JDBC)

When using parameter markers in functions, a JDBC restriction requires that the parameter marker for the function must be cast to the data type of the column into which the returned data will be inserted. The function selection logic does not know what data type the argument might turn out to be, and it cannot resolve the reference.

For example, JDBC cannot resolve the following code:

```
DB2XML.XMLdefault_casting_function(length)
```

You can use the CAST specification to provide a type for the parameter marker, such as VARCHAR, and then the function selection logic can proceed:

```
DB2XML.XMLdefault_casting_function(CAST(? AS cast_type(length))
```

### Examples:

In the following examples, The Sales\_Tab table has three columns.

The invoice\_num column has a data type of Char(6), the sales\_person column has a data type of Varchar(20), and the order column has a data type of XMLVarchar.

**Example 1:** In the following example, the parameter marker is cast as VARCHAR. The parameter being passed is an XML document, which is cast as VARCHAR(1000) and inserted into the column ORDER.

```
String query = "insert into sales_tab(invoice_num, sales_person, order) values
(?,?,DB2XML.XMLVarchar(cast (? as varchar(1000))))";
```

**Example 2:** In the following example, the parameter marker is cast as VARCHAR. The parameter being passed is a file name and its contents are converted to VARCHAR and inserted into the column ORDER.

```
String query = "insert into sales_tab(invoice_num, sales_person, order) values
(?,?,DB2XML.XMLVarcharfromFILE(cast (? as varchar(1000))))";
```



---

## Chapter 4. Managing data in XML collections

---

### XML collections as a storage and access method

Relational data is either *decomposed* from incoming XML documents or used to *compose* outgoing XML documents. Decomposed data is the untagged content of an XML document stored in one or more database tables. Or, XML documents are composed from existing data in one or more database tables. If your data is to be shared with other applications, you might want to be able to compose and decompose incoming and outgoing XML documents and manage the data as necessary to take advantage of the relational capabilities of DB2®. This type of XML document storage is called *XML collection*.

An example of an XML collection is shown in Figure 10.

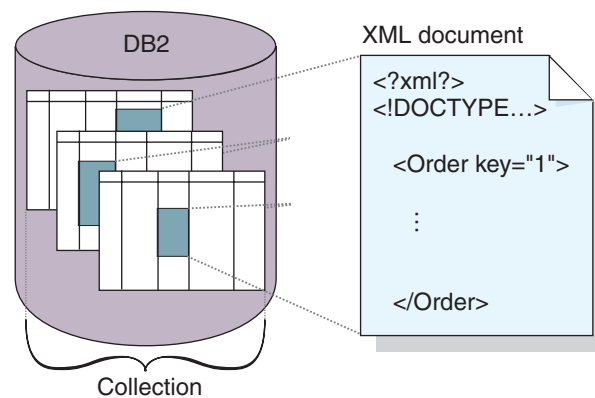

Figure 10. Storing documents as untagged data in DB2 UDB tables

The XML collection is defined in a DAD file, which specifies how elements and attributes are mapped to one or more relational tables. The collection is a set of columns, associated with a DAD file, that contain the data in a particular XML document or set of XML documents. You can define a collection name by enabling it, and then refer to it by name when issuing a stored procedure to compose or decompose XML documents. It is called an enabled XML collection. The collection is given a name so that it is easily run with stored procedures that compose and decompose the XML documents.

When you define a collection in the DAD file, you use one of two types of mapping schemes, *SQL mapping* or *RDB\_node mapping* that define the tables, columns, and conditions used to associate XML data with DB2 UDB tables. SQL mapping uses SQL SELECT statements to define the DB2 UDB tables and conditions used for the collection. RDB\_node mapping uses an XPath-based relational database node, or RDB\_node, which has child elements.

Stored procedures are provided to compose or decompose XML documents. Stored procedure names are qualified by DB2XML, which is the *schema name* of XML Extender.

---

## Managing data in XML collections

An XML collection is a set of relational tables that contain data that is mapped to XML documents. This access and storage method lets you compose an XML document from existing data, decompose an XML document, and use XML as an interchange method.

The relational tables that make up the collection can be new tables, or existing tables that have data that is to be used with XML Extender to compose XML documents for your applications. Column data in these tables does not contain XML tags; it contains the content and values that are associated with elements and attributes, respectively. You use stored procedures to store, retrieve, update, search, and delete XML collection data.

### Preparing to compose XML documents from DB2 data

Composition is the generation of a set of XML documents from relational data in an XML collection. You can compose XML documents using stored procedures. To use these stored procedures, create a document access definition (DAD) file. A DAD file specifies the mapping between the XML document and the DB2 table structure. The stored procedures use the DAD file to compose the XML document.

#### Procedure::

Before you begin composing XML documents:

1. Map the structure of the XML document to the relational tables that contain the contents of the element and attribute values.
2. Select a mapping method: SQL mapping or RDB\_node mapping.
3. Prepare the DAD file.

The XML Extender provides four stored procedures to compose XML documents:

- dxxGenXML()
- dxxGenXMLCLOB()
- dxxRetrieveXML()
- dxxRetrieveXMLCLOB

#### Composing documents using dxxGenXML

Use the dxxGenXML stored procedure to compose the document. You do not have to enable a collection to use this stored procedure. The stored procedure uses a DAD file instead.

The dxxGenXML stored procedure constructs XML documents using data that is stored in XML collection tables, which are specified by the <Xcollection> element in the DAD file. This stored procedure inserts each XML document as a row into a result table. You can also open a cursor on the result table and fetch the result set. The result table must be created by the application and always has one column of VARCHAR, CLOB, XMLVARCHAR, or XMLCLOB type that is used to store the XML data.

Additionally, if the value of the validation element in the DAD file is YES, XML Extender adds the column DXX\_VALID of INTEGER type into the result table if the DXX\_VALID column is not in the table yet. The XML Extender inserts a value of 1 for a valid XML document and 0 for an invalid document.



The stored procedure `dxxGenXML` also allows you to specify the maximum number of rows that are to be generated in the result table. This shortens processing time. The stored procedure returns the actual number of rows in the table and any return codes and messages.

The corresponding stored procedure for decomposition is `dxxShredXML`; it also takes the DAD as the input parameter and does not require that the XML collection be enabled.

**Procedure:**

To compose an XML collection using the `dxxGenXML` stored procedure, embed a stored procedure call in your application using the following stored procedure declaration:

```
dxxGenXML(CLOB(100K) DAD, /* input */
 char(32) resultTabName, /* input */
 char(30) result_column, /* input */
 char(30) valid_column, /* input */
 integer overrideType, /* input */
 varchar(1024) override, /* input */
 integer maxRows, /* input */
 integer numRows, /* output */
 long returnCode, /* output */
 varchar(1024) returnMsg) /* output */
```

**Example:** The following example composes an XML document:

```
#include "dxx.h"
#include "dxxrc.h"

EXEC SQL INCLUDE SQLCA;
EXEC SQL BEGIN DECLARE SECTION;
SQL TYPE is CLOB(100K) dad; /* DAD */

char result_tab[32]; /* name of the result table */
char result_colname[32]; /* name of the result column */
char valid_colname[32]; /* name of the valid column, will set to NULL */
char override[2]; /* override, will set to NULL*/
short overrideType; /* defined in dxx.h */
short max_row; /* maximum number of rows */
short num_row; /* actual number of rows */
long returnCode; /* return error code */
char returnMsg[1024]; /* error message text */
short dad_ind;
short rtab_ind;
short rcol_ind;
short vcol_ind;
short ovtpe_ind;
short ov_ind;
short maxrow_ind;
short numrow_ind;
short returnCode_ind;
short returnMsg_ind;
EXEC SQL END DECLARE SECTION;

FILE *file_handle;
long file_length=0;

/* create table */
EXEC SQL CREATE TABLE xml_order_tab (xmlorder XMLVarchar);

/* initialize the DAD CLOB object. */
file_handle = fopen("/dxx/dad
/getstart_xcollection.dad", "r");
```

```

if (file_handle != NULL) {
 file_length = fread ((void *) &dad.data,
 1, FILE_SIZE, file_handle);
 if (file_length == 0) {
 printf ("Error reading dad file
 /dxx/dad
 /getstart_xcollection.dad\n");
 rc = -1;
 goto exit;
 } else
 dad.length = file_length;
}
else {
 printf("Error opening dad file \n",);
 rc = -1;
 goto exit;
}
/* initialize host variable and indicators */
strcpy(result_tab,"xml_order_tab");
strcpy(result_colname, "xmlorder")
valid_colname = '\0';
override[0] = '\0';
overrideType = NO_OVERRIDE;
max_row = 500;
num_row = 0;
returnCode = 0;
msg_txt[0] = '\0';
dad_ind = 0;
rtab_ind = 0;
rcol_ind = 0;
vcol_ind = -1;
ov_ind = -1;
ovtype_ind = 0;
maxrow_ind = 0;
numrow_ind = -1;
returnCode_ind = -1;
returnMsg_ind = -1;

/* Call the stored procedure */
EXEC SQL CALL "DB2XML.dxxGenXML"
 (:dad:dad_ind;
 :result_tab:rtab_ind,
 :result_colname:rcol_ind,
 :valid_colname:vcol_ind,
 :overrideType:ovtype_ind,:override:ov_ind,
 :max_row:maxrow_ind,:num_row:numrow_ind,
 :returnCode:returnCode_ind,:returnMsg:returnMsg_ind);

if (SQLCODE < 0) {
 EXEC SQL ROLLBACK;
} else
 EXEC SQL COMMIT;
}

exit:
 return rc;

```

After the stored procedure is called, the result table contains 250 rows because the SQL query specified in the DAD file generated 250 XML documents.

### Composing documents using dxxRetrieveXML

The dxxRetrieveXML stored procedure works in the same way as the dxxGenXML stored procedure, except that it takes the name of an enabled XML collection instead of a DAD file. When an XML collection is enabled, a DAD file is stored in

the XML\_USAGE table. Therefore, XML Extender retrieves the DAD file and uses it to compose the document in the same way as the dxxGenXML stored procedure.

The corresponding stored procedure for decomposition is dxxInsertXML; it also takes the name of an enabled XML collection.

**Procedure:**

To compose an XML collection using the dxxRetrieveXML stored procedure, embed a stored procedure call in your application using the following stored procedure declaration:

```
dxxRetrieveXML(char() collectionName, /* input */
 char() resultTabName, /* input */
 char(30) result_column, /* input */
 char(30) valid_column, /* input */
 integer overrideType, /* input */
 varchar(1024) override, /* input */
 integer maxRows, /* input */
 integer numRows, /* output */
 long returnCode, /* output */
 varchar(1024) returnMsg) /* output */
```

**Example:** The following example is of a call to dxxRetrieveXML(). It assumes that a result table is created with the name of XML\_ORDER\_TAB and that the table has one column of XMLVARCHAR type.

```
#include "dxx.h"
#include "dxxrc.h"

EXEC SQL INCLUDE SQLCA;
EXEC SQL BEGIN DECLARE SECTION;
char collectionName[32]; /* name of an XML collection */
char result_tab[32]; /* name of the result table */
char result_colname[32]; /* name of the result column */
char valid_colname[32]; /* name of the valid column, will set to NULL*/
char override[2]; /* override, will set to NULL*/
short overrideType; /* defined in dxx.h */
short max_row; /* maximum number of rows */
short num_row; /* actual number of rows */
long returnCode; /* return error code */
char returnMsg[1024]; /* error message text */
short collectionName_ind;
short rtab_ind;
short rcol_ind;
short vcol_ind;
short ovtype_ind;
short ov_ind;
short maxrow_ind;
short numrow_ind;
short returnCode_ind;
short returnMsg_ind;
EXEC SQL END DECLARE SECTION;

/* create table */
EXEC SQL CREATE TABLE xml_order_tab (xmlorder XMLVarchar);

/* initial host variable and indicators */
strcpy(collection, "sales_ord");
strcpy(result_tab, "xml_order_tab");
strcpy(result_col, "xmlorder");
valid_colname[0] = '\0';
override[0] = '\0';
overrideType = NO_OVERRIDE;
max_row = 500;
```

```

num_row = 0;
returnCode = 0;
msg_txt[0] = '\0';
collectionName_ind = 0;
rtab_ind = 0;
rcol_ind = 0;
vcol_ind = -1;
ov_ind = -1;
ovtype_ind = 0;
maxrow_ind = 0;
numrow_ind = -1;
returnCode_ind = -1;
returnMsg_ind = -1;

/* Call the stored procedure */
EXEC SQL CALL "DB2XML.DXXRETRIEVEXML" (:collectionName:collectionName_ind,
 :result_tab:rtab_ind,
 :result_colname:rcol_ind,
 :valid_colname:vcol_ind,
 :overrideType:ovtype_ind,:override:ov_ind,
 :max_row:maxrow_ind,:num_row:numrow_ind,
 :returnCode:returnCode_ind,
 :returnMsg:returnMsg_ind);

if (SQLCODE < 0) {
 EXEC SQL ROLLBACK;
 else
 EXEC SQL COMMIT;
}

```

#### Related concepts:

- “XML collections as a storage and access method” on page 89
- “Mapping schemes for XML collections” on page 102
- “Location paths” on page 110
- “DAD files for XML collections” on page 161
- “XML Extender composition stored procedures - Overview” on page 183

#### Related tasks:

- “Composing XML collections by using RDB\_node mapping” on page 62
- “Stylesheets for an XML collection” on page 109
- “Decomposing an XML collection by using RDB\_node mapping” on page 66
- “Updating and deleting data in XML collections” on page 99
- “Searching XML collections” on page 101

---

## Decomposing XML documents into DB2 UDB data

To decompose an XML document is to parse down the data inside of an XML document and store it in relational tables. The XML Extender provides stored procedures to decompose XML data from source XML documents into relational tables. To use these stored procedures, you must create a DAD file, which specifies the mapping between the XML document and DB2 UDB table structure. The stored procedures use the DAD file to decompose the XML document.

Before you decompose an XML document into DB2 UDB data:

1. Map the structure of the XML document to the relational tables that contain the contents of the elements and attributes values.
2. Prepare the DAD file, using RDB\_node mapping.

### 3. Optional: Enable the XML collection.

#### Procedure::

Use one of the two stored procedures provided by DB2 UDB XML Extender to decompose XML documents, `dxxShredXML()` or `dxxInsertXML`.

#### `dxxShredXML()`

This stored procedure is used for applications that do occasional updates or for applications that do not want the overhead of administering the XML data. The stored procedure `dxxShredXML()` does not require an enabled collection; it uses a DAD file instead.

The stored procedure `dxxShredXML()` takes two input parameters, a DAD file and the XML document that is to be decomposed; it returns two output parameters: a return code and a return message. It inserts data from an XML document into an XML collection according to the `<Xcollection>` specification in the input DAD file. The `dxxShredXML()` stored procedure then decomposes the XML document, and inserts untagged XML data into the tables specified in the DAD file. The tables that are used in the `<Xcollection>` of the DAD file are assumed to exist, and the columns are assumed to meet the data types specified in the DAD mapping. If this is not true, an error message is returned.

The corresponding stored procedure for composition is `dxxGenXML()`; it also takes the DAD as the input parameter and does not require that the XML collection be enabled.

#### To decompose an XML collection with `dxxShredXML()`

Embed a stored procedure call in your application using the following stored procedure declaration:

```
dxxShredXML(CLOB(100K) DAD, /* input */
 CLOB(1M) xmlobj, /* input */
 long returnCode, /* output */
 varchar(1024) returnMsg) /* output */
```

**Example:** The following example is a call to `dxxShredXML()`:

```
#include "dxx.h"
#include "dxxrc.h"

EXEC SQL INCLUDE SQLCA;
EXEC SQL BEGIN DECLARE SECTION;
SQL TYPE is CLOB(100K) dad; /* DAD */

SQL TYPE is CLOB(100K) xmlDoc; /* input xml document */

long returnCode; /* return error code */
char returnMsg[1024]; /* error message text */
short dad_ind;
short xmlDoc_ind;
short returnCode_ind;
short returnMsg_ind;
EXEC SQL END DECLARE SECTION;

FILE *file_handle;
long file_length=0;

/* initialize the DAD CLOB object. */
file_handle = fopen("/dxx
/dad/getstart_xcollection.dad", "r");
if (file_handle != NULL) {
 file_length = fread ((void *) &dad.data, 1, FILE_SIZE,
```

```

file handle);
if (file_length == 0) {
 printf("Error reading dad file getstart_xcollection.dad\n");
 rc = -1;
 goto exit;
} else
 dad.length = file_length;
}
else {
 printf("Error opening dad file \n");
 rc = -1;
 goto exit;
}

/* Initialize the XML CLOB object. */
file_handle = fopen("/dxx
/xml/getstart_xcollection.xml", "r");
if (file_handle != NULL) {
 file_length = fread ((void *) &xmlDoc.data, 1,
 FILE_SIZE, file_handle);
 if (file_length == 0) {
 printf ("Error reading xml file
 getstart_xcollection.xml \n");
 rc = -1;
 goto exit;
 } else
 xmlDoc.length = file_length;
}
else {
 printf("Error opening xml file \n");
 rc = -1;
 goto exit;
}

/* initialize host variable and indicators */
returnCode = 0;
msg_txt[0] = '\0';
dad_ind = 0;
xmlDoc_ind = 0;
returnCode_ind = -1;
returnMsg_ind = -1;

/* Call the stored procedure */
EXEC SQL CALL "DB2XML.DXXSHREDXML" (:dad:dad_ind,
 :xmlDoc:xmlDoc_ind,
 :returnCode:returnCode_ind,
 :returnMsg:returnMsg_ind);

if (SQLCODE < 0) {
 EXEC SQL ROLLBACK;
} else
 EXEC SQL COMMIT;
}

exit:
return rc;

```

### **dxxInsertXML()**

This stored procedure is used for applications that make regular updates. The stored procedure `dxxInsertXML()` works the same as `dxxShredXML()`, except that `dxxInsertXML()` takes an enabled XML collection as its first input parameter.

The stored procedure `dxxInsertXML()` inserts data from an XML document into an enabled XML collection, which is associated with a DAD file. The DAD file contains specifications for the collection tables and the mapping.

The collection tables are checked or created according to the specifications in the <Xcollection>. The stored procedure dxxInsertXML() then decomposes the XML document according to the mapping, and it inserts untagged XML data into the tables of the named XML collection.

The corresponding stored procedure for composition is dxxRetrieveXML(); it also takes the name of an enabled XML collection.

**Procedure:**

To decompose an XML collection: dxxInsertXML():

Embed a stored procedure call in your application using the following stored procedure declaration:

```
dxxInsertXML(char(
) collectionName, /* input */
 CLOB(1M) xmlObj, /* input */
 long returnCode, /* output */
 varchar(1024) returnMsg) /* output */
```

**Example:** The following is an example of a call to dxxInsertXML():

```
#include "dxx.h"
#include "dxxrc.h"

EXEC SQL INCLUDE SQLCA;
EXEC SQL BEGIN DECLARE SECTION;
char collectionName[32]; /* name of an XML collection */
SQL TYPE is CLOB(100K) xmlDoc; /* input xml document */
long returnCode; /* return error code */
char returnMsg[1024]; /* error message text */
short collectionName_ind;
short xmlDoc_ind;
short returnCode_ind;
short returnMsg_ind;
EXEC SQL END DECLARE SECTION;

FILE *file_handle;
long file_length=0;

/* initialize the DAD CLOB object. */

file_handle = fopen("dxxsamples/dad
/getstart_xcollection.dad", "r");
if (file_handle != NULL) {
 file_length = fread ((void *) &dad.data, 1, FILE_SIZE,
 file_handle);
 if (file_length == 0) {
 printf ("Error reading dad file getstart_xcollection.dad\n");
 rc = -1;
 goto exit;
 } else
 dad.length = file_length;
}
else {
 printf("Error opening dad file \n");
 rc = -1;
 goto exit;
}

/* initialize host variable and indicators */
strcpy(collectionName, "sales_ord");
returnCode = 0;
msg_txt[0] = '\0';
collectionName_ind = 0;
xmlDoc_ind = 0;
returnCode_ind = -1;
```

```

returnMsg_ind = -1;

/* Call the stored procedure */
EXEC SQL CALL "db2xml.DXXINSERTXML"
 (:collection_name:collection_name_ind,
 :xmlDoc:xmlDoc_ind,
 :returnCode:returnCode_ind,
 :returnMsg:returnMsg_ind);

if (SQLCODE < 0) {
 EXEC SQL ROLLBACK;
 else
 EXEC SQL COMMIT;
}

exit:
return rc;

```

## Enabling an XML collection for decomposition

In most cases, you need to enable an XML collection before using the stored procedures. Cases where you must enable the collections are:

- When decomposing XML documents into new tables, an XML collection must be enabled because all tables in the XML collection are created by the XML Extender when the collection is enabled.
- When keeping the sequence of elements and attributes that have multiple occurrence is important. The XML Extender preserves only the sequence order of elements or attributes of multiple occurrence for tables that are created when a collection is enabled. When XML documents are decomposed into existing relational tables, the sequence order is not guaranteed to be preserved.

See the section about the `dxxadm` administration command for information about the `enable_collection` option.

If you want to pass the DAD file when the tables already exist in your database, you do not need to enable an XML collection.

## Decomposition table size limits

Decomposition uses `RDB_node` mapping to specify how an XML document is decomposed into DB2 UDB tables by extracting the element and attribute values and storing them in table rows. The values from each XML document are stored in one or more DB2 UDB tables. Each table can have a maximum of 500736 rows decomposed from each document.

For example, if an XML document is decomposed into five tables, each of the five tables can have up to 500736 rows for that particular document.

Using multiple-occurring elements (elements with location paths that can occur more than once in the XML structure) affects the number of rows. For example, a document that contains an element `<Part>` that occurs 20 times might be decomposed as 20 rows in a table. When using multiple occurring elements, consider that a maximum of 500736 rows can be decomposed into one table from a single document.

### Related concepts:

- “XML Extender decomposition stored procedures - Overview” on page 194

### Related tasks:



- “Decomposing an XML collection by using RDB\_node mapping” on page 66
- “Calling XML Extender stored procedures” on page 177

**Related reference:**

- “dxxInsertXML() stored procedure” on page 197
- “dxxShredXML() stored procedure” on page 194

---

## Updating and deleting data in XML collections

You can update, delete, search, and retrieve XML collections. However, the purpose of using an XML collection is to store or retrieve untagged data in database tables. The data in existing database tables has nothing to do with any incoming XML documents; update, delete, and search operations consist of normal SQL access to these tables.

The XML Extender provides the ability to perform operations on the data from an XML collection view. You can run SQL UPDATE and DELETE statements to modify the data that is used for composing XML documents, and therefore, update the XML collection. Performing SQL operations on the collection tables affects the generated documents.

- To update a document, do not delete a row containing the primary key of the table, which is the foreign key row of the other collection tables. When the primary key and foreign key row is deleted, the document is deleted.
- To replace or delete elements and attribute values, you can delete and insert rows in lower-level tables without deleting the document.
- To delete a document, delete the row that composes the top element\_node specified in the DAD.

### Updating data in an XML collection

The XML Extender allows you to update untagged data that is stored in XML collection tables. By updating XML collection table values, you are updating the text of an XML element, or the value of an XML attribute. Updates can also delete an instance of data from multiple-occurring elements or attributes.

From an SQL point of view, changing the value of the element or attribute is an update operation, and deleting an instance of an element or attribute is a delete operation. From an XML point of view, if the element text or attribute value of the root element\_node exists, the XML document still exists and is, therefore, an update operation. SQL operations on collection tables affect documents that will be generated from the tables.

**Requirements:** When you update data in an XML collection, observe the following rules:

- Specify the primary-foreign key relationship among the collection tables when the existing tables have this relationship. If they do not, ensure that there are columns that can be joined.
- Include the join condition that is specified in the DAD file:
  - For SQL mapping, include the join condition in the <SQL\_stmt> element.
  - For RDB\_node mapping, include the join condition in the top <condition> element of the root element node.

## Updating element and attribute values

In an XML collection, element text and attribute values are all mapped to columns in database tables. Regardless of whether the column data previously exists or is decomposed from incoming XML documents, you replace the data using the normal SQL update technique.

To update an element or attribute value, specify a WHERE clause in the SQL UPDATE statement that contains the join condition that is specified in the DAD file.

### Example:

```
UPDATE SHIP_TAB
 set MODE = 'BOAT'
WHERE MODE='AIR' AND PART_KEY in
 (SELECT PART_KEY from PART_TAB WHERE ORDER_KEY=68)
```

The <ShipMode> element value is updated from AIR to BOAT in the SHIP\_TAB table, where the key is 68.

## Deleting element and attribute instances

To update composed XML documents by eliminating multiple-occurring elements or attributes, delete a row containing the field value that corresponds to the element or attribute value, using the WHERE clause. If you do not delete the row that contains the values for the top element\_node, deleting element values is considered an update of the XML document.

For example, in the following DELETE statement, you are deleting a <shipment> element by specifying a unique value of one of its sub-elements.

```
DELETE from SHIP_TAB
 WHERE DATE='1999-04-12'
```

Specifying a DATE value deletes the row that matches this value. The composed document originally contained two <shipment> elements, but now contains one.

## Deleting an XML document from an XML collection

You can delete an XML document that is composed from a collection. This means that if you have an XML collection that composes multiple XML documents, you can delete one of these composed documents. Performing SQL operations on the collection tables affects the generated documents.

### Procedure:

To delete the document, delete a row in the table that composes the top element\_node that is specified in the DAD file. This table contains the primary key for the top-level collection table and the foreign key for the lower-level tables. Deleting the document with this method works only if the primary-key and foreign-key constraints are fully specified in the SQL and if the relationship of the tables shown in the DAD match those constraints exactly.

### Example:

The following DELETE statement specifies the value of the primary key column.

```
DELETE from order_tab
 WHERE order_key=1
```

ORDER\_KEY is the primary key in the table ORDER\_TAB, which is the top-level table as specified in the DAD. Deleting this row deletes one XML document that is generated during composition. Therefore, from the XML point of view, one XML document is deleted from the XML collection.

---

## Searching XML collections

This section describes searching an XML collection in terms of generating XML documents using search criteria, and searching for decomposed XML data.

### Composing XML documents using search criteria

This task is the same as composition using a condition.

#### Procedure:

You can specify the search criteria using the following search criteria:

- Specify the condition in the text\_node and attribute\_node of the DAD file
- Specify the *override* parameter when using the dxxGenXML() and dxxRetrieveXML() stored procedures.

For example, if you enabled an XML collection, sales\_ord, using the DAD file, order.dad, but you now want to override the price using form data derived from the Web, you can override the value of the <SQL\_stmt> DAD element, as follows:

```
EXEC SQL INCLUDE SQLCA;
EXEC SQL BEGIN DECLARE SECTION;
...
EXEC SQL END DECLARE SECTION;

float price_value;

/* create table */
EXEC SQL CREATE TABLE xml_order_tab (xmlorder XMLVarchar);

/* initialize host variable and indicators */
strcpy(collection,"sales_ord");
strcpy(result_tab,"xml_order_tab");
overrideType = SQL_OVERRIDE;
max_row = 20;
num_row = 0;
returnCode = 0;
msg_txt[0] = '\0';
override_ind = 0;
overrideType_ind = 0;
rtab_ind = 0;
maxrow_ind = 0;
numrow_ind = -1;
returnCode_ind = -1;
returnMsg_ind = -1;

/* get the price_value from some place, such as form data */
price_value = 1000.00 /* for example*/

/* specify the overwrite */
sprintf(overwrite,
 "SELECT o.order_key, customer, p.part_key, quantity, price,
 tax, ship_id, date, mode
 FROM order_tab o, part_tab p,

(select db2xml.generate_unique()
 as ship_id, date, mode from ship_tab) as s
WHERE p.price > %d and s.date >'1996-06-01' AND
```

```

 p.order_key = o.order_key and s.part_key = p.part_key",
 price_value);

/* Call the stored procedure */
EXEC SQL CALL db2xml.dxxRetrieveXML(:collection:collection_ind,
 :result_tab:rtab_ind,
 :overrideType:overrideType_ind,:overwrite:overwrite_ind,
 :max_row:maxrow_ind,:num_row:numrow_ind,
 :returnCode:returnCode_ind,:returnMsg:returnMsg_ind);

```

The condition of price > 2500.00 in order.dad is overridden by price > ?, where ? is based on the input variable *price\_value*.

## Searching for decomposed XML data

You can use normal SQL query operations to search collection tables. You can join collection tables, or use subqueries, and then do a structural-text search on text columns. Apply the results of the structural search to retrieve or generate the specified XML document.

---

## Mapping schemes for XML collections

If you are using an XML collection, you must select a *mapping scheme*, which specifies how XML data is represented in a relational database. Because XML collections must match the hierarchical structure of XML documents with a relational structure for relational databases, you should understand how the two structures compare. Figure 11 on page 103 shows how the hierarchical structure can be mapped to relational table columns.

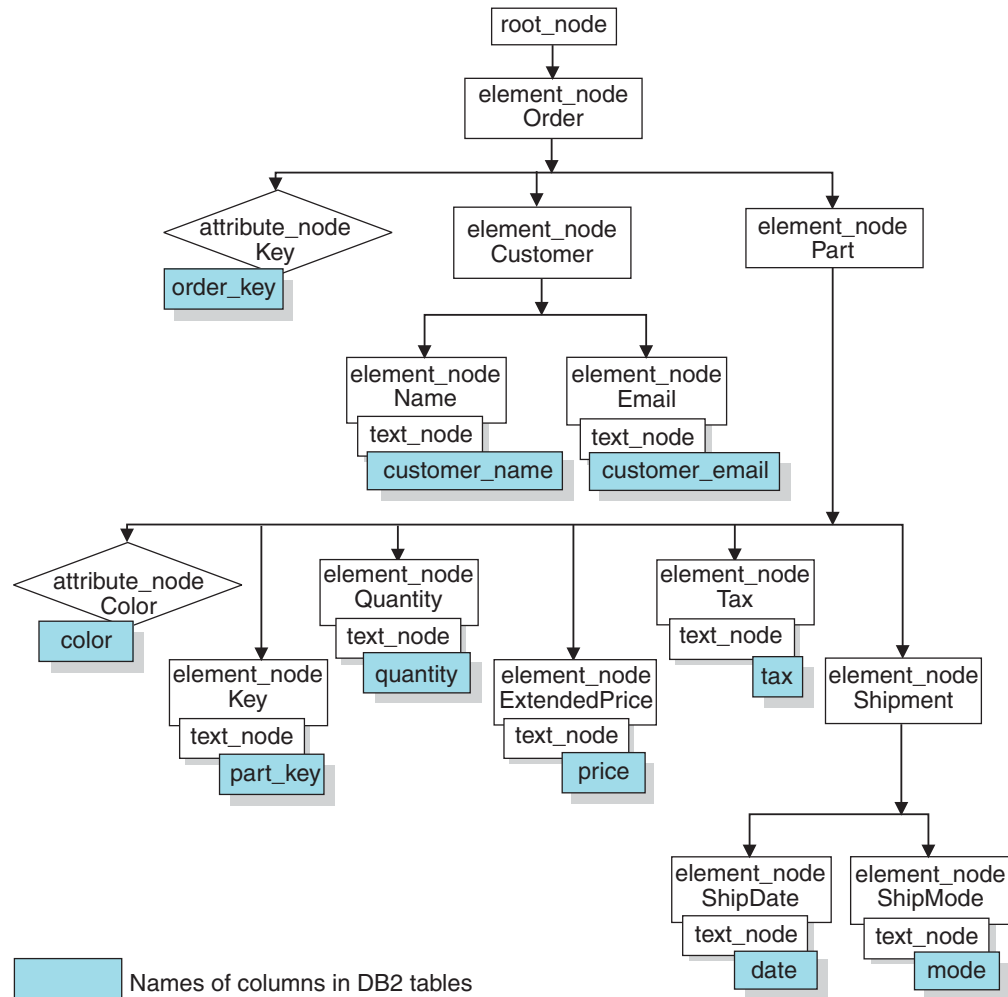

Figure 11. XML document structure mapped to relational table columns

The XML Extender uses a mapping scheme when composing or decomposing XML documents that are located in multiple relational tables. Before you create the DAD file, you must think about how your XML data is mapped to the XML collection.

**Types of mapping schemes:**

Use <Xcollection> to specify the mapping scheme in the DAD file. The XML Extender provides two types of mapping schemes: *SQL mapping* and *Relational Database (RDB\_node) mapping*.

**SQL mapping**

This method allows direct mapping from relational data to XML documents through a single SQL statement. SQL mapping is used for composition only. The content of the <SQL\_stmt> element must be a valid SQL statement. The <SQL\_stmt> element specifies columns in the SELECT clause that are mapped to XML elements or attributes later in the DAD. When defined for composing XML documents, the column names in the SELECT clause of the SQL statement are used to associate the value of an *attribute\_node* or a content of *text\_node* with columns that have the same *name\_attribute*. The FROM clause defines the tables containing the data; the WHERE clause specifies the *join* and search *condition*.

SQL mapping gives DB2<sup>®</sup> users the power to map the data using SQL. When using SQL mapping, you must be able to join all tables in one SELECT statement to form a query. If one SQL statement is not sufficient, consider using RDB\_node mapping. To tie all tables together, the *primary key* and *foreign key* relationship is recommended among these tables.

### RDB\_node mapping

Defines the location of the content of an XML element or the value of an XML attribute so that XML Extender can determine where to store or retrieve the XML data.

This method uses XML Extender-provided *RDB\_node*, which contains one or more node definitions for tables, optional columns, and optional conditions. The <table> and <column> elements in the DAD define how the XML data is to be stored in the database. The condition specifies the criteria for selecting XML data or the way to join the XML collection tables.

To define a mapping scheme, you must create a DAD file with an <Xcollection> element. Figure 12 shows a fragment of a sample DAD file with SQL mapping for an XML collection, which composes a set of XML documents from data in three relational tables.

```
<?xml version="1.0"?>
<!DOCTYPE DAD SYSTEM "dxx_install/samples/db2xml/dtd/dad.dtd">
<DAD>
 <dtdid>/dxxsamples/dad/getstart.dtd</dtdid>
 <validation>YES</validation>
 <Xcollection>
 <SQL_stmt>
 SELECT o.order_key, customer, p.part_key, quantity, price, tax, date,
 ship_id, mode, comment
 FROM order_tab o, part_tab p,
 (select db2xml.generate_unique()
 as ship_id, date, mode, from ship_tab) as
 WHERE p.price > 2500.00 and s.date > "1996-06-01" AND
 p.order_key = o.order_key and s.part_key = p.part_key
 </SQL_stmt>
 <prolog>?xml version="1.0"?</prolog>
 <doctype>!DOCTYPE DAD SYSTEM
 "
 /dxxsamples/dtd/getstart.dtd"</doctype>
 <root_node>
 <element_node name="Order">
 <attribute_node name="Key">
 <column name="order_key"/>
 </attribute_node>
 <element_node name="Customer">
 <text_node>
 <column name="customer"/>
 </text_node>
 </element_node>
 </element_node><!--end Part-->
 </element_node><!--end Order-->
 </root_node>
</Xcollection>
</DAD>
```

Figure 12. SQL mapping scheme

The XML Extender provides several stored procedures that manage data in an XML collection. These stored procedures support both types of mapping.

**Related concepts:**

- “DAD files for XML collections” on page 161
- “Requirements for using SQL mapping” on page 105
- “Requirements for RDB\_Node mapping” on page 106

**Related tasks:**

- “Composing XML documents by using SQL mapping” on page 59
- “Composing XML collections by using RDB\_node mapping” on page 62
- “Decomposing an XML collection by using RDB\_node mapping” on page 66

---

## Requirements for using SQL mapping

### Requirements when using SQL mapping

In this mapping scheme, you must specify the <SQL\_stmt> element inside the DAD <Xcollection> element. The <SQL\_stmt> must contain a single SQL statement that can join multiple relational tables with the query *predicate*. In addition, the following clauses are required:

- **SELECT clause**

- Ensure that the name of the column is unique. If two tables have the same column name, use the AS keyword to create an alias name for one of them.
- Group columns of the same table together and order the tables according to the tree level as they map to the hierarchical structure of your XML document. The first column in each column grouping is an object ID. In the SELECT clause, the columns of the higher-level tables must precede the columns of lower-level tables. The following example demonstrates the hierarchical relationship among tables:

```
SELECT o.order_key, customer, p.part_key, quantity, price, tax,
 ship_id, date, mode
```

In this example, the `order_key` and `customer` columns from the `ORDER_TAB` table have the highest relational level because they are higher on the hierarchical tree of the XML document. The `ship_id`, `date`, and `mode` columns from the `SHIP_TAB` table are at the lowest relational level.

- Use a single-column candidate key to begin each level. If such a key is not available in a table, the query should generate one for that table using a table expression and the `generate_unique()` user-defined function. In the above example, the `o.order_key` is the primary key for `ORDER_TAB`, and the `part_key` is the primary key of `PART_TAB`. They appear at the beginning of their own group of columns that are to be selected. The `ship_id` is generated as a primary key because the `SHIP_TAB` table does not have a primary key. `ship_id` is listed as the first column for the `SHIP_TAB` table group. Use the `FROM` clause to generate the primary key column, as shown in the following example.

- **FROM clause**

- Use a table expression and the `generate_unique()` user-defined function to generate a single key for tables that do not have a primary single key. For example:

```
FROM order_tab as o, part_tab as p,
 (select
 db2xml.generate_unique() as
 ship_id, date, mode, part key from ship_tab) as s
```

In this example, a single column candidate key is generated with the `generate_unique()` function and given an alias named `ship_id`.

- Use an alias name when it is necessary to make a column distinct. For example, you could use `o` for columns in the `ORDER_TAB` table, `p` for columns in the `PART_TAB` table, and `s` for columns in the `SHIP_TAB` table.

- **WHERE clause**

- Specify a primary and foreign key relationship as the join condition that ties tables in the collection together. For example:

```
WHERE p.price > 2500.00 AND s.date > "1996-06-01" AND
 p.order_key = o.order_key AND s.part_key = p.part_key
```

- Specify any other search condition in the predicate. Any valid predicate can be used.

- **ORDER BY clause**

- Define the ORDER BY clause at the end of the `SQL_stmt`. Ensure that there is nothing after the column names such as `ASC` or `DESC`.
- Ensure that the column names match the column names in the `SELECT` clause.
- List all object ID's in the same relative order as they appear in the `SELECT` clause.
- An identifier can be generated using a table expression and the `generate_unique()` function or a user defined function.
- Maintain the top-down order of the hierarchy of the entities. The first column specified in the ORDER BY clause must be the first column listed for each entity. Keeping the order ensures that the XML documents to be generated do not contain incorrect duplicates.
- Do not qualify the columns in the ORDER BY clause with a schema or table name.

The `<SQL_stmt>` element is powerful because you can specify any predicate in your `WHERE` clause, as long as the expression in the predicate uses the columns in the tables.

**Related reference:**

- Appendix A, "Samples," on page 229

---

## Requirements for RDB\_Node mapping

When using `RDB_Node` as your mapping method, do not use the `<SQL_stmt>` element in the `<Xcollection>` element of the DAD file. Instead, use the `RDB_node` element as a child of the top `element_node` and of each `attribute_node` and `text_node`.

- **RDB\_node for the top element\_node**

The top `element_node` in the DAD file represents the root element of the XML document. Specify an `RDB_node` for the top `element_node` as follows:

- Specify all tables that are associated with the XML collection. For example, the following mapping specifies three tables in the `<RDB_node>` of the `<Order>` element node, which is the top element node:

```
<element_node name="Order">
 <RDB_node>
 <table name="order_tab"/>
 <table name="part_tab"/>
 <table name="ship_tab"/>
```



```

 <condition>
 order_tab.order_key = part_tab.order_key AND
 part_tab.part_key = ship_tab.part_key
 </condition>
 </RDB_node>

```

The condition element can be empty or missing if there is only one table in the collection.

- Condition elements can reference a column name an unlimited number of times.
- If you are enabling a collection, you must specify a primary key for each table. The primary key can consist of a single column or multiple columns, called a composite key. Specify the primary key by adding an *attribute key* to the table element of the RDB\_node. When you supply a composite key, the *key* attribute will be specified by the names of key columns separated by a space. For example:

```
<table name="part_tab" key="part_key price"/>
```

The information specified for decomposition is ignored if the same DAD is used for composition.

- Use the orderBy attribute to recompose XML documents containing elements or attributes with multiple occurrence back to their original structure. This attribute allows you to specify the name of a column that will be the key used to preserve the order of the document. The orderBy attribute is part of the table element in the DAD file, and it is an optional attribute. When you decompose XML documents in an XML collection, you can lose the order of multiple-occurring elements and attribute values, unless you specify the order in the DAD file. To preserve this order, you should use the RDB\_node mapping scheme and specify the orderBy attribute for the table containing the root element in its RDB\_node.

Spell out the table name and the column name in the <table>tag.

- **RDB\_node for each attribute\_node and text\_node**

The XML Extender needs to know from where in the database to retrieve the data. XML Extender also needs to know where in the database to put the content from an XML document. You must specify an RDB\_node for each attribute node and text node. You must also specify the table and column names; the condition value is optional.

1. Specify the name of the table containing the column data. The table name must be included in the RDB\_node of the top element\_node. In this example, for text\_node of element <Price>, the table is specified as PART\_TAB.

```

<element_node name="Price">
 <text_node>
 <RDB_node>
 <table name="part_tab"/>
 <column name="price"/>
 <condition>
 price > 2500.00
 </condition>
 </RDB_node>
 </text_node>
</element_node>

```

2. Specify the name of the column that contains the data for the element text. In the previous example, the column is specified as PRICE.
3. Specify a query condition if you want XML documents to be generated using that condition. Only the data meeting the condition is in the generated XML documents. The condition must be a valid WHERE clause. In the example

above, the condition is specified as `price > 2500.00`, so only rows where the price is over 2500 will be included in the XML documents.

4. If you are decomposing a document, or enabling the XML collection specified by the DAD file, you must specify the column type for each attribute node and text node. By specifying the column type for each attribute node and text node, you ensure that the correct data type for each column when new tables are created during the enabling of an XML collection. Column types are specified by adding the attribute type to the column element. For example:

```
<column name="order_key" type="integer"/>
```

The column type specified when decomposing a document is ignored for composition.

- Maintain the top-down order of the hierarchy of the entities. Ensure that the element nodes are nested properly so that XML Extender understands the relationship between the elements when composing or decomposing documents. For example, the following DAD file does not nest Shipment inside of Part:

```
<element_node name="Part">
 ...
 <element_node name="ExtendedPrice">
 ...
 </element_node>
 ...
</element_node> <!-- end of element Part -->

<element_node name="Shipment" multi_occurrence="YES">
 <element_node name="ShipDate">
 ...
 </element_node>
 <element_node name="ShipMode">
 ...
 </element_node>
</element_node> <!-- end of element Shipment-->
```

This DAD file produces an XML documents in which the Part and Shipment elements are siblings.

```
<Part color="black ">
 <key>68</key>
 <Quantity>36</Quantity>
 <ExtendedPrice>34850.16</ExtendedPrice>
 <Tax>6.000000e-2</Tax>
</Part>

<Shipment>
 <ShipDate>1998-08-19</ShipDate>
 <ShipMode>BOAT </ShipMode>
</Shipment>
```

The following code shows the shipment element nested inside the Part element in the DAD file.

```
<element_node name="Part">
 ...
 <element_node name="ExtendedPrice">
 ...
 </element_node>
 ...
 <element_node name="Shipment" multi_occurrence="YES">
 <element_node name="ShipDate">
 ...
 </element_node>
 <element_node name="ShipMode">
```

```
...
</element_node>
```

```
</element_node> <!-- end of element Shipment-->
</element_node> <!-- end of element Part -->
```

Nesting the shipment element inside the part element produces an XML file with Shipment as a child element of the Part element:

```
<Part color="black ">
 <key>68</key>
 <Quantity>36</Quantity>
 <ExtendedPrice>34850.16</ExtendedPrice>
 <Tax>6.000000e-2</Tax>
 <Shipment>
 <ShipDate>1998-08-19</ShipDate>
 <ShipMode>BOAT </ShipMode>
 </Shipment>
</Part>
```

There are no ordering restrictions on predicates of the root node condition.

With the RDB\_node mapping approach, you don't need to supply SQL statements. However, putting complex query conditions in the RDB\_node element can be more difficult.

For a subtree of the DAD with element\_nodes and attribute\_nodes that map to the same table, the following is true:

- Attribute nodes do not have to be the first children of the lowest common ancestor of the element nodes that map to the same table.
- Attribute nodes can appear anywhere in the subtree, as long as they are not involved in a join condition.

**Restrictions:** The limit for the number of tables allowed in a RDB\_node mapping DAD is 30. The number of columns allowed per table is 500. The number of times each table or column can be specified in the join predicates of the condition statement is unlimited

---

## Stylesheets for an XML collection

When composing documents, XML Extender also supports processing instructions for stylesheets, using the <stylesheet> element. The processing instructions must be inside the <Xcollection> root element, located with the <doctype> and <prolog> defined for the XML document structure. For example:

```
<?xml version="1.0"?>
<!DOCTYPE DAD SYSTEM "c:\dtd\dad.dtd">
<DAD>
 <SQL_stmt>
 ...
 </SQL_stmt>
 <Xcollection>
 ...
 <prolog>...</prolog>
 <doctype>...</doctype>
 <stylesheet?xml-stylesheet type="text/css" href="order.css"?></stylesheet>
 </root_node>...</root_node>
 ...
</Xcollection>
...
</DAD>
```

---

## Location paths

A *location path* defines the location of an XML element or attribute within the structure of the XML document. The XML Extender uses the location path for the following purposes:

- To locate the elements and attributes to be extracted when using extraction UDFs such as `dxxRetrieveXML`.
- To specify the mapping between an XML element or attribute and a DB2® column when defining the indexing scheme in the DAD for XML columns
- For structural text search, using the Net Search Extender
- To override the XML collection DAD file values in a stored procedure.

Figure 13 shows an example of a location path and its relationship to the structure of the XML document.

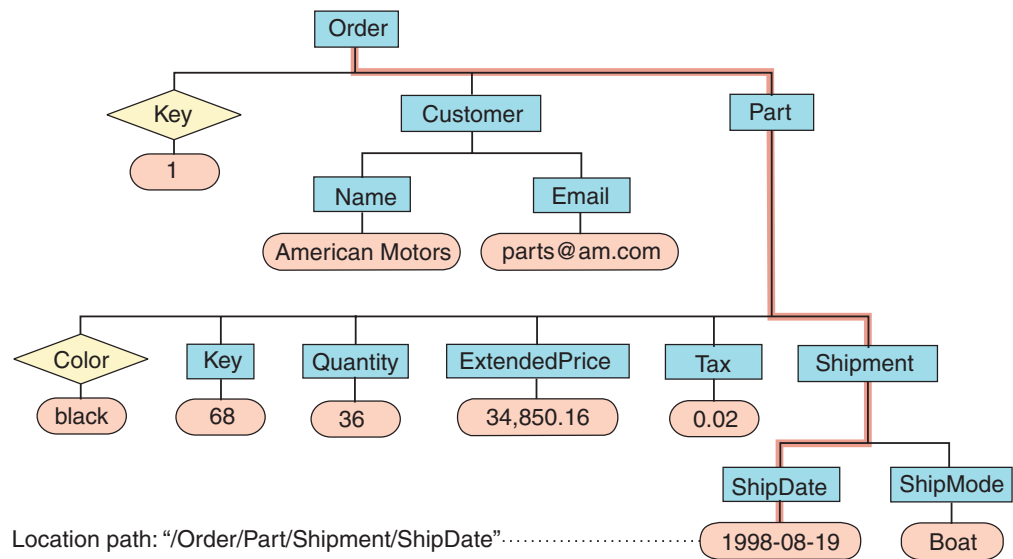

Figure 13. Storing documents as structured XML documents in a DB2 UDB table column

### Related reference:

- “Location path syntax” on page 110

---

## Location path syntax

XML Extender uses the location path to navigate the XML document structure. The following list describes the location path syntax that is supported by the XML Extender. A single slash (/) path indicates that the context is the whole document.

1. / Represents the XML root element. This the element that contains all the other elements in the document.
2. /tag1 Represents the element *tag1* under the root element.
3. /tag1/tag2/.../tagn Represents an element with the name *tagn* as the child of the descending chain from root, *tag1*, *tag2*, through *tagn-1*.

4. *//tag<sub>n</sub>*  
Represents any element with the name *tag<sub>n</sub>*, where double slashes (//) denote zero or more arbitrary tags.
5. */tag<sub>1</sub>//tag<sub>n</sub>*  
Represents any element with the name *tag<sub>n</sub>*, a descendent of an element with the name *tag<sub>1</sub>* under root, where double slashes (//) denote zero or more arbitrary tags.
6. */tag<sub>1</sub>/tag<sub>2</sub>/@attr<sub>1</sub>*  
Represents the attribute *attr<sub>1</sub>* of an element with the name *tag<sub>2</sub>*, which is a child of element *tag<sub>1</sub>* under root.
7. */tag<sub>1</sub>/tag<sub>2</sub>[@attr<sub>1</sub>="5"]*  
Represents an element with the name *tag<sub>2</sub>* whose attribute *attr<sub>1</sub>* has the value 5. The *tag<sub>2</sub>* is a child of the *tag<sub>1</sub>* element under root.
8. */tag<sub>1</sub>/tag<sub>2</sub>[@attr<sub>1</sub>="5"]/.../tag<sub>n</sub>*  
Represents an element with the name *tag<sub>n</sub>*, which is a child of the descending chain from root, *tag<sub>1</sub>*, *tag<sub>2</sub>*, through *tag<sub>n-1</sub>*, where the attribute *attr<sub>1</sub>* of *tag<sub>2</sub>* has the value 5.

### Simple location path

*Simple location path* is a type of location path used in the XML column DAD file. A simple location path is represented as a sequence of element-type names that are connected by a single slash (/). The values of each attribute are enclosed within square brackets following the element type. Table 17 summarizes the syntax for simple location path.

Table 17. Simple location path syntax

Subject	Location path	Description
XML element	<i>/tag<sub>1</sub>/tag<sub>2</sub>/.../tag<sub>n-1</sub>/tag<sub>n</sub></i>	An element content identified by the element named <i>tag<sub>n</sub></i> and its parents
XML attribute	<i>/tag<sub>1</sub>/tag<sub>2</sub>/.../tag<sub>n-1</sub>/tag<sub>n</sub>/@attr<sub>1</sub></i>	An attribute named <i>attr<sub>1</sub></i> of the element identified by <i>tag<sub>n</sub></i> and its parents

### Location path usage

The syntax of the location path is dependent on the context in which you are accessing the location of an element or attribute. Because the XML Extender uses one-to-one mapping between an element or attribute, and a DB2 column, it restricts the syntax rules for the DAD file and functions. Table 18 describes in which contexts the syntax options are used.

Table 18. The XML Extender's restrictions using location path

Use of the location path	Location path supported
Value of path attribute in the XML column DAD mapping for side tables	<i>/tag<sub>1</sub>/tag<sub>2</sub>/.../tag<sub>n</sub></i> and <i>/tag<sub>1</sub>/tag<sub>2</sub>/@attr<sub>1</sub></i> (simple location path described in Table 17)
Extracting UDFs	All location paths <sup>1</sup>
Update UDF	All location paths <sup>1</sup>
Net Search Extender's search UDF	<i>/tag<sub>1</sub>/tag<sub>2</sub>/.../tag<sub>n</sub></i> — Exception: the root mark is specified without the slash. For example: <i>tag<sub>1</sub>/tag<sub>2</sub>/.../tag<sub>n</sub></i>

Table 18. The XML Extender's restrictions using location path (continued)

Use of the location path	Location path supported
<sup>1</sup> The extracting and updating UDFs support location paths that have predicates with attributes, but not elements.	

**Related concepts:**

- "Location paths" on page 110

## Enabling XML collections

Enabling an XML collection parses the DAD file to identify the tables and columns related to the XML document, and records control information in the XML\_USAGE table. Enabling an XML collection is optional for:

- Decomposing an XML document and storing the data in new DB2 UDB tables
- Composing an XML document from existing data in multiple DB2 UDB tables

If the same DAD file is used for composing and decomposing, you can enable the collection for both composition and decomposition.

You can enable an XML collection with the XML Extender Administration wizard, with the **dxxadm** command with the `enable_collection` option, or with the XML Extender stored procedure `dxxEnableCollection()`.

**Using the Administration wizard:**

To enable an XML collection using the wizard:

1. Set up and start the Administration wizard.
2. Click **Work with XML Collections** from the Launchpad window. The Select a Task window opens.
3. Click **Enable a Collection** and then **Next**. The Enable a Collection window opens.
4. Select the name of the collection that you want to enable in the **Collection name** field.
5. Specify the DAD file name in the **DAD file name** field.
6. Click **Finish** to enable the collection and return to the Launchpad window.
  - If the collection is successfully enabled, an Enabled collection is successful message is displayed.
  - If the collection is not successfully enabled, an error message is displayed. Repeat the steps above until the collection is successfully enabled.

**Enabling collections using the dxxadm command:**

To enable an XML collection, enter the **dxxadm** command from a DB2 UDB command line:

**Syntax:**

```
▶▶—dxxadm—enable_collection—dbName—collection—DAD_file—▶▶
```

**Parameters:**

*dbName*

The name of the RDB database.

*collection*

The name of the XML collection. This value is used as a parameter for the XML collection stored procedures.

*DAD\_file*

The name of the file that contains the document access definition (DAD).

**Example:** The following example enables a collection called `sales_ord` in the database `SALES_DB` using the command line. The DAD file uses SQL mapping.

From the Qshell:

```
dxxadm enable_collection SALES_DB sales_ord getstart_collection.dad
```

From the OS command line:

```
CALL QDBXM/QZXADM PARM(enable_collection SALES_DB sales_ord
'getstart_collection.dad')
```

From the Operations Navigator:

```
CALL MYSCHEMA.QZXADM('enable_collection', 'SALES_DB', 'sales_ord',
'getstart_collection.dad');
```

After you enable the XML collection, you can compose or decompose XML documents using the XML Extender stored procedures.

**Related concepts:**

- “XML collections as a storage and access method” on page 89

**Related tasks:**

- “Disabling XML collections” on page 113
- “Managing data in XML collections” on page 90

---

## Disabling XML collections

Disabling an XML collection removes the record in the `XML_USAGE` table that identifies tables and columns as part of a collection. It does not drop any data tables. You disable a collection when you want to update the DAD and need to re-enable a collection, or when you want to drop a collection.

You can disable an XML collection with the XML Extender Administration wizard, with the `dxxadm` command with the `disable_collection` option, or with the XML Extender stored procedure `dxxDisableCollection()`.

**Procedure:**

To disable an XML collection using the Administration wizard:

1. Start the Administration wizard.
2. Click **Work with XML Collections** from the Launchpad window to view the XML Extender collection related tasks. The Select a Task window opens.
3. Click **Disable an XML Collection** and then **Next** to disable an XML collection. The Disable a Collection window opens.

4. Type the name of the collection that you want to disable in the **Collection name** field.
5. Click **Finish** to disable the collection and return to the Launchpad window.
  - If the collection is successfully disabled, Disabled collection is successful message is displayed.
  - If the collection is not successfully disabled, an error box is displayed. Repeat the steps above until the collection is successfully disabled.

To disable an XML collection from the command line, enter the **dxxadm** command.

**Syntax:**

►—dxxadm—disable\_collection—dbName—collection—►

**Parameters:**

*dbName*

The name of the RDB database.

*collection*

The name of the XML collection. This value is used as a parameter for the XML collection stored procedures.

**Example:**

From the Qshell:

```
dxxadm disable_collection SALES_DB sales_ord
```

From the OS command line:

```
CALL QDBXM/QZXMADM PARM(disable_collection SALES_DB sales_ord)
```

From the Operations Navigator:

```
CALL MYSCHEMA.QZXMADM('disable_collection', 'SALES_DB', 'sales_ord');
```

**Related concepts:**

- “XML collections as a storage and access method” on page 89
- “XML Extender administration stored procedures - Overview” on page 178

**Related tasks:**

- “Managing data in XML collections” on page 90



---

## Chapter 5. XML schemas

The XML schema can be used in place of a DTD to define the specifications for the content of XML documents. The XML schema uses XML format or XML syntax to define the elements and attribute names of an XML document, and defines the type of content that the elements and attributes are allowed to contain.

---

### Advantages of using XML schemas instead of DTDs

DTDs are easier to code and validate than an XML schema. However, the advantages to using an XML schema are shown in the following list:

- XML schemas are valid XML documents that can be processed by tools such as the XSD Editor in WebSphere® Studio Application Developer, XML Spy, or XML Authority.
- XML schemas are more powerful than DTDs. Everything that can be defined by the DTD can also be defined by schemas, but not vice versa.
- XML schemas support a set of data types, similar to the ones used in most common programming languages, and provide the ability to create additional types. You can constrain the document content to the appropriate type. For example, you can replicate the properties of fields found in DB2®.
- XML schemas support regular expressions to set constraints on character data, which is not possible if you use a DTD.
- XML schemas provide better support for XML namespaces, which enable you to validate documents that use multiple namespaces, and to reuse constructs from schemas already defined in different namespaces.
- XML schemas provide better support for modularity and reuse with include and import elements.
- XML schemas support inheritance for element, attribute, and data type definitions.

**Related tasks:**

- “Data types, elements and attributes in schemas” on page 116

**Related reference:**

- “Examples of an XML schema” on page 117

---

### XML schema complexType element

The XML schema element `complexType` is used to define an element type that can consist of sub-elements. For example, the following tags show the projection of an address in an XML document:

```
<billTo country="US">
 <name>Dan Jones</name>
 <street>My Street</street>
 <city>My Town</city>
 <state>CA</state>
 <zip>99999</zip>
</billTo>
```

The structure of this element can be defined in the XML schema as follows:

```

1 <xsd:element name="billTo" type="USAddress"/>
2 < xsd:complexType name="USAddress">
3 <xsd:sequence>
4 < xsd:element name="name" type="xsd:string"/>
5 < xsd:element name="street" type="xsd:string"/>
6 < xsd:element name="city" type="xsd:string"/>
7 < xsd:element name="state" type="xsd:string"/>
8 < xsd:element name="zip" type="xsd:decimal"/>
9 </xsd:sequence>
10 < xsd:attribute name="country"
 type="xsd:NMTOKEN" use="fixed"
 value="US"/>
12</xsd:complexType>

```

In the above example, it is assumed that the xsd prefix has been bound to the XML schema namespace. Lines 2 through 12 define the complexType USAddress as a sequence of five elements and one attribute. The order of the elements is determined by the order in which they appear in the sequence tag.

The inner elements are from data type xsd:string or xsd:decimal. Both are predefined simple data types.

Alternatively, you can use the <all> tag or the <choice> tag instead of the <sequence> tag. With the all tag, all sub-elements must appear, but do not need to appear in any particular order. With the choice tag, exactly one of the sub-elements must appear in the XML document

You can also use a user-defined data type to define other elements.

---

## Data types, elements and attributes in schemas

### Simple data types in XML schemas

XML schemas provide a set of simple built-in data types. You can derive other data types from them by applying constraints.

**Example 1:** The range of base type xsd:positiveInteger is limited to 0 to 100.

```

< xsd:element name="quantity">
 < xsd:simpleType>
 < xsd:restriction base="xsd:positiveInteger">
 < xsd:maxExclusive value="100"/>
 </xsd:restriction>
 </xsd:simpleType>
</xsd:element>

```

**Example 2:** The base type xsd:string is limited by a regular expression.

```

<xsd:simpleType name="SKU">
 < xsd:restriction base="xsd:string">
 < xsd:pattern value="\d{3}-[A-Z]{2}"/>
 </xsd:restriction>
</xsd:simpleType>

```

**Example 3:** Shows an enumerated type based on the string built-in type.

```

<xsd:simpleType name="SchoolClass">
 < xsd:restriction base="xsd:string">
 < xsd:enumeration value="WI"/>
 < xsd:enumeration value="MI"/>
 < xsd:enumeration value="II"/>
 </xsd:restriction>
</xsd:simpleType>

```

```

 < xsd:enumeration value="DI"/>
 < xsd:enumeration value="AI"/>
 </xsd:restriction>
</xsd:simpleType>

```

## Elements in XML schemas

To declare an element in an XML schema you must indicate the name and type as an attribute of the element element. For example:

```
<xsd:element name="street" type="xsd:string"/>
```

Additionally, you can use the attributes `minOccurs` and `maxOccurs` to determine the maximum or minimum number of times that the element must appear in the XML document. The default value of `minOccurs` and `maxOccurs` is 1.

## Attributes in XML schemas

Attribute declarations appear at the end of an element definition. For example:

```

<xsd:complexType name="PurchaseOrderType">
 < xsd:sequence>
 < xsd:element name="billTo" type="USAddress"/>
 < xsd:sequence>
 < xsd:attribute name="orderDate" type="xsd:date"/>
 </xsd:complexType>

```

### Related concepts:

- “Advantages of using XML schemas instead of DTDs” on page 115

### Related tasks:

- “Validation functions” on page 155

### Related reference:

- “Examples of an XML schema” on page 117
- “XML schema `complexType` element” on page 115

---

## Examples of an XML schema

It is a good strategy to write XML schemas by first designing the data structure of your XML document using a UML tool. After you design the structure, you can map the structure into your schema document. The following example shows an XML schema.

```

1 <?xml version="1.0" encoding="UTF-8"?>
2 <xs:schema xmlns:xs='http://www.w3.org/2001/XMLSchema'>
3
4 <xs:element name="personnel">
5 <xs:complexType>
6 <xs:sequence>
7 <xs:element ref="person" minOccurs='1' maxOccurs='unbounded' />
8 </xs:sequence>
9 </xs:complexType>
10 </xs:element>
11
12 <xs:element name="person">
13 <xs:complexType>
14 <xs:sequence>
15 <xs:element ref="name"/>
16 <xs:element ref="email" minOccurs='0' maxOccurs='4' />
17 </xs:sequence>
18 <xs:attribute name="id" type="xs:ID" use='required' />

```

```

19 </xs:complexType>
20 </xs:element>
21
22 <xs:element name="name">
23 <xs:complexType>
24 <xs:sequence>
25 <xs:element ref="family"/>
26 <xs:element ref="given"/>
27 </xs:sequence>
28 </xs:complexType>
29 </xs:element>
30
31 <xs:element name="family" type='xs:string' />
32 <xs:element name="given" type='xs:string' />
33 <xs:element name="email" type='xs:string' />
34 </xs:schema>

```

The first two lines declare that this XML schema is XML 1.0 compatible and Unicode 8 decoded, and specify use of the XML schema standard namespace, which enables access to basic XML schema data types and structures.

Lines 4 to 10 define the `personnel` as a `complexType` that consists of a sequence of 1 to *n* persons. The `complexType` is then defined in lines 12 to 20. It consists of the `complexType` element name and the element `email`. The `email` element is optional (`minOccurs = '0'`), and can appear up to four times (`maxOccurs = '4'`). The greater the number of occurrences of an element, the longer it will take to validate the schema. In contrast, in a DTD you can choose only 0, 1, or unlimited appearances of an element.

Lines 22 to 29 define the `name` type that is used for the person type. The name type consists of a sequence of a `family` and a `given` element.

Lines 31 to 33 define the single elements `family`, `given`, and `e-mail`, which contain type strings that have been declared.

## XML document instance using the schema

The following example is an XML document that is an instance of the *personnel.xsd* schema.

```

1 <?xml version="1.0" encoding="UTF-8"?>
2 <personnel xmlns:xsi="http://www.w3.org/2001/XMLSchema-instance"
3 xsi:noNamespaceSchemaLocation='personsnr.xsd'>
4
5 <person id="Big.Boss" >
6 <name><family>Boss</family><given>Big</given></name>
7 <email>chief@foo.com</email>
8 </person>
9
10 <person id="one.worker">
11 <name><family>Worker</family><given>One</given></name>
12 <email>one@foo.com</email>
13 </person>
14
15 <person id="two.worker">
16 <name><family>Worker</family><given>Two</given></name>
17 <email>two@foo.com</email>
18 </person>
19 </personnel>

```

## XML document instance using a DTD

This example shows how this XML schema would be realized as a DTD.

```
1 <?xml version="1.0" encoding="UTF-8"?>
2 <!ELEMENT email (#PCDATA)>
3 <!ELEMENT family (#PCDATA)>
4 <!ELEMENT given (#PCDATA)>
5 <!ELEMENT name (family, given)>
6 <!ELEMENT person (name, email*)>
7
8 <!ATTLIST person
9 id ID #REQUIRED>
10 <!ELEMENT personnel (person+)>
```

Using a DTD you can set the maximum occurrence of email to only 1 or unlimited occurrences.

Using this DTD, the XML document instance would be the same as shown in the top example, except line 2 would be changed to:

```
<!DOCTYPE personnel SYSTEM "personsnr.dtd">
```

**Related concepts:**

- “Advantages of using XML schemas instead of DTDs” on page 115

**Related tasks:**

- “Data types, elements and attributes in schemas” on page 116
- “Validation functions” on page 155

**Related reference:**

- “XML schema complexType element” on page 115



---

## Chapter 6. The dxxadm administration command

---

### dxxadm command overview

The XML Extender provides an administration command, **dxxadm**, for completing the following administration tasks from the Q-shell or the OS command line.

- Enabling or disabling a database for XML Extender
- Enabling or disabling an XML column
- Enabling or disabling an XML collection

**Related concepts:**

- “Administration tools for XML Extender” on page 31
- “XML Extender administration overview” on page 38

---

### Syntax of the dxxadm administration command

```
➤ dxxadm -a [enable_db|disable_db|enable_column|disable_column|enable_collection|disable_collection] parameters
```

**Parameters:**

Table 19. dxxadm parameters

Parameter	Description
<i>enable_db</i>	Enables XML Extender features for a database.
<i>disable_db</i>	Disables XML Extender features for a database.
<i>enable_column</i>	Enables an XML column so that XML documents can be stored in the column.
<i>disable_column</i>	Disables the XML-enabled column.
<i>enable_collection</i>	Enables an XML collection according to the specified DAD.
<i>disable_collection</i>	Disables an XML-enabled collection.

---

### administration command

The following **dxxadm** are available to system programmers:

- enable\_column
- enable\_collection
- enable\_db
- disable\_column
- disable\_collection
- disable\_db

## enable\_db option of the dxxadm command

### Purpose:

Enables XML Extender features for a database. When the database is enabled, the XML Extender creates the following objects:

- The XML Extender user-defined types (UDTs).
- The XML Extender user-defined functions (UDFs).
- The XML Extender DTD repository table, DTD\_REF, which stores DTDs and information about each DTD.
- The XML Extender usage table, XML\_USAGE, which stores common information for each column that is enabled for XML and for each collection.

### Syntax:

►►—dxxadm—enable\_db—*db\_name*—————◄◄

### Parameters:

Table 20. enable\_db parameters

Parameter	Description
<i>db_name</i>	The name of the RDB database in which the XML data resides.

### Example::

The following example enables the database SALES\_DB.

From the Qshell:

```
dxxadm enable_db SALES_DB
```

From the OS command line:

```
CALL QDBXM/QZXMADM PARM(enable_db SALES_DB)
```

From the iSeries Navigator:

```
CALL MYSCHEMA.QZXMADM('enable_db', 'SALES_DB');
```

### Related reference:

- “dxxadm command overview” on page 121

## disable\_db option of the dxxadm command

### Purpose:

Disables XML Extender features for a database; this action is called “disabling a database.” When the database is disabled, it can no longer be used by the XML Extender. When the XML Extender disables the database, it drops the following objects:

- The XML Extender user-defined types (UDTs).
- The XML Extender user-defined functions (UDFs).
- The XML Extender DTD repository table, DTD\_REF, which stores DTDs and information about each DTD.



- The XML Extender usage table, XML\_USAGE, which stores common information for each column that is enabled for XML and for each collection.

**Important:** You must disable all XML columns before attempting to disable a database. The XML Extender cannot disable a database that contains columns or collections that are enabled for XML Extender. You must also drop all tables that have columns defined with XML Extender user-defined types, such as XMLCLOB.

**Syntax:**

► `dxxadm disable_db db_name` ◄

**Parameters:**

*Table 21. disable\_db parameters*

Parameter	Description
<i>db_name</i>	The name of the RDB database in which the XML data resides

**Example::**

The following example disables the database SALES\_DB.

From the Qshell:

```
dxxadm disable_db SALES_DB
```

From the OS command line:

```
CALL QDBXM/QZXMADM PARM(disable_db SALES_DB)
```

From the iSeries Navigator:

```
CALL MYSCHEMA.QZXMADM('disable_db', 'SALES_DB');
```

**Related concepts:**

- “XML Extender administration stored procedures - Overview” on page 178
- Chapter 12, “XML Extender administration support tables,” on page 203

**Related reference:**

- “How to read syntax diagrams” on page xi

## enable\_column option of the dxxadm command

**Purpose:**

Connects to a database and enables an XML column so that it can contain the XML Extender UDTs. When enabling a column, the XML Extender completes the following tasks:

- Determines whether the XML table has a primary key; if not, the XML Extender alters the XML table and adds a column called DXXROOT\_ID.
- Creates side tables that are specified in the DAD file with a column containing a unique identifier for each row in the XML table. This column is either the root ID that the user specified or the DXXROOT\_ID that was named by the XML Extender.
- Optionally creates a default view for the XML table and its side tables, optionally using a name that you specify.

## Syntax:

```
► dxxadm enable_column db_name tab_name column_name DAD_file ►
└─v default_view ┘ └─r root_id ┘
```

## Parameters:

Table 22. enable\_column parameters

Parameter	Description
<i>db_name</i>	The name of the RDB database in which the XML data resides.
<i>tab_name</i>	The name of the table in which the XML column resides.
<i>column_name</i>	The name of the XML column.
<i>DAD_file</i>	The name of the DAD file that maps the XML document to the XML column and side tables.
<i>-v default_view</i>	The name of the default view that joins the XML column and side tables.
<i>-r root_id</i>	The name of the primary key in the XML column table that is to be used as the root_id for side tables. The root_id is optional.

## Example::

The following example enables an XML column.

From the Qshell:

```
dxxadm enable_column SALES_DB MYSCHEMA.SALES_TAB ORDER getstart.dad
-v sales_order_view -r INVOICE_NUMBER
```

From the OS command line:

```
CALL QDBXM/QZXADM PARM(enable_column SALES_DB 'MYSCHEMA.SALES_TAB'
ORDER 'getstart.dad' '-v' sales_order_view '-r' INVOICE_NUMBER)
```

From the iSeries Navigator:

```
CALL MYSCHEMA.QZXADM('enable_column', 'SALES_DB', 'MYSCHEMA.SALES_TAB',
'ORDER', 'getstart.dad', '-v sales_order_view', '-r INVOICE_NUMBER');
```

## disable\_column option of the dxxadm command

### Purpose:

Connects to a database and disables the XML-enabled column. When the column is disabled, it can no longer contain XML data types. When an XML-enabled column is disabled, the following actions are performed:

- The XML column usage entry is deleted from the XML\_USAGE table.
- The USAGE\_COUNT is decremented in the DTD\_REF table.
- All triggers that are associated with this column are dropped.
- All side tables that are associated with this column are dropped.

**Important:** You must disable an XML column before dropping an XML table. If an XML table is dropped but its XML column is not disabled, the XML Extender keeps both the side tables that it created and the XML column entry in the XML\_USAGE table.

**Syntax:**

►—dxxadm—disable\_column—db\_name—tab\_name—column\_name—◄

**Parameters:**

Table 23. disable\_column parameters

Parameter	Description
db_name	The name of the RDB database in which the data resides.
tab_name	The name of the table in which the XML column resides.
column_name	The name of the XML column.

**Examples:**

The following example disables an XML-enabled column.

From the Qshell:

```
dxxadm disable_column SALES_DB MYSCHEMA.SALES_TAB ORDER
```

From the OS command line:

```
CALL QDBXM/QZXADM PARM(disable_column SALES_DB 'MYSCHEMA.SALES_TAB' ORDER)
```

From the iSeries Navigator:

```
CALL MYSCHEMA.QZXADM('disable_column', 'SALES_DB',
'MYSCHEMA.SALES_TAB', 'ORDER');
```

**Related reference:**

- “enable\_collection option of the dxxadm command” on page 125

## enable\_collection option of the dxxadm command

**Purpose:**

Connects to a database and enables an XML collection according to the specified DAD. When running the XML Extender on a partitioned Enterprise Server Edition environment, check that all of the tables specified in your DAD file included at least one column that is qualified to be a partitioning key. When enabling a collection, the XML Extender does the following tasks:

- Creates an XML collection usage entry in the XML\_USAGE table.
- For RDB\_node mapping, creates collection tables specified in the DAD if the tables do not exist in the database.

**Syntax:**

►—dxxadm—enable\_collection—db\_name—collection\_name—DAD\_file—◄

**Parameters:**

Table 24. enable\_collection parameters

Parameter	Description
<i>db_name</i>	The name of the RDB database in which the data resides.
<i>collection_name</i>	The name of the XML collection.
<i>DAD_file</i>	The name of the DAD file that maps the XML document to the relational tables in the collection.

**Examples:**

The following example enables an XML collection.

From the Qshell:

```
dxxadm enable_collection SALES_DB sales_ord
getstart_xcollection.dad
```

From the OS command line:

```
CALL QDBXM/QZXMADM PARM(enable_collection SALES_DB sales_ord
'getstart_collection.dad')
```

From the iSeries Navigator:

```
CALL MYSCHEMA.QZXMADM('enable_collection', 'SALES_DB', 'sales_ord',
'getstart_collection.dad');
```

## disable\_collection option of the dxxadm command

**Purpose:**

Connects to a database and disables an XML-enabled collection. The collection name can no longer be used in the composition (dxxRetrieveXML) and decomposition (dxxInsertXML) stored procedures. When an XML collection is disabled, the associated collection entry is deleted from the XML\_USAGE table. Disabling the collection does not drop the collection tables that are created during when you use enable\_collection option.

**Syntax:**

►► dxxadm—disable\_collection—*db\_name*—*collection\_name*—◄◄

**Parameters:**

Table 25. disable\_collection parameters

Parameter	Description
<i>db_name</i>	The name of the RDB database in which the data resides.
<i>collection_name</i>	The name of the XML collection.

**Example::**

The following example disables an XML collection.

From the Qshell:

```
dxxadm disable_collection SALES_DB sales_ord
```

From the OS command line:

```
CALL QDBXM/QZXMADM PARM(disable_collection SALES_DB sales_ord)
```

From the iSeries Navigator:

```
CALL MYSCHEMA.QZXMADM('disable_collection', 'SALES_DB', 'sales_ord');
```



---

## Part 4. Reference

This part provides syntax information for the XML Extender administration command, user-defined data types (UDTs), user-defined functions (UDFs), and stored procedures. Message text is also provided for problem determination activities.





---

## Chapter 7. XML Extender user-defined types

The data types are used to define the column in the application table that will be used to store the XML document. You can also store XML documents as files on the file system, by specifying a file name.

All XML Extender's user-defined types have the qualifier DB2XML, which is the schema name of the DB2 UDB XML Extender user-defined types. For example:  
db2xml.XMLVarchar

The XML Extender creates UDTs for storing and retrieving XML documents. Table 26 describes the UDTs.

Table 26. The XML Extender UDTs

User-defined type column	Source data type	Usage description
XMLVARCHAR	VARCHAR( <i>varchar_len</i> )	Stores an entire XML document as VARCHAR inside DB2. You can redefine XMLVARCHAR up to 32 KB. To change the size of an XMLVARCHAR UDT, create the UDT before you enable the database for XML Extender.
XMLCLOB	CLOB( <i>clob_len</i> )	Stores an entire XML document as a character large object (CLOB) inside DB2.
XMLFILE	VARCHAR(512)	Specifies the fully-qualified file name of the local file server. If XMLFILE is specified for the XML column, then the XML Extender stores the XML document in an external server file. The Text Extender cannot be enabled with XMLFILE. You must ensure integrity between the file content, DB2, and the side table created for indexing.

Where *varchar\_len* and *clob\_len* are specific to the operating system.

For XML Extender on i5/OS™, *varchar\_len* = 3K and *clob\_len* = 10M.

To change the size of an XMLVARCHAR or XMLCLOB UDT, create the UDT before you enable the database for XML Extender.

Procedure:

To change the size of an XMLVARCHAR or XMLCLOB UDT of an enabled database:

1. Back up all data in the XML Extender-enabled database.

2. Drop all XML collection tables or XML column side tables.
3. Disable the database with the `dxxadm disable_dbcommand`.
4. Create the XMLVARCHAR or XMLCLOB user-defined type.
5. Enable the database with the `dxxadm enable_dbcommand`.
6. Re-create and reload the tables.

These UDTs are used only to specify the types of application columns; they do not apply to the side tables that the XML Extender creates.

**Related concepts:**

- “XML columns as a storage and access method” on page 73

**Related tasks:**

- “Saving and restoring for XML columns and XML collections” on page 34

---

## Chapter 8. XML Extender user-defined functions

A user-defined function (UDF) is a function that is defined to the database management system and can be referenced in SQL statements. This section describes user-defined functions that are provided by DB2 UDB XML Extender.

---

### Types of XML Extender user-defined functions

The XML Extender provides functions for storing, retrieving, searching, and updating XML documents, and for extracting XML elements or attributes.

All the UDFs have the schema name DB2XML.

The types of XML Extender functions are described in the following list:

#### **storage functions**

Storage functions insert intact XML documents in XML-enabled columns as XML data types.

#### **retrieval functions**

Retrieval functions retrieve XML documents from XML columns in a DB2<sup>®</sup> database.

#### **extracting functions**

Extracting functions extract and convert the element content or attribute value from an XML document to the data type that is specified by the function name. The XML Extender provides a set of extracting functions for various SQL data types.

#### **update function**

The Update function modifies an entire XML document or specified element content or attribute values and returns a copy of an XML document with an updated value, which is specified by the location path.

#### **generate\_unique function**

The generate\_unique function returns a unique key.

#### **Validation functions**

Validation functions validate XML documents against either an XML schema or a DTD.

The XML user-defined functions allow you to perform searches on general SQL data types. Additionally, you can use the DB2 UDB Net Search Extender with XML Extender to perform structural and *full text searches* on text in XML documents. This search capability can be used, for example, to improve the usability of a Web site that publishes large amounts of readable text, such as newspaper articles or *Electronic Data Interchange (EDI)* applications, which have frequently searchable elements or attributes.

Restriction: When using parameter markers in UDFs, a Java<sup>™</sup> database (JDBC) restriction requires that the parameter marker for the UDF must be cast to the data type of the column into which the returned data will be inserted.

---

## UDT and UDF names for XML Extender

The full name of a DB2<sup>®</sup> function is *schema-name.function-name*, where *schema-name* is an identifier that provides a logical grouping for a set of SQL objects. The schema name for XML Extender UDFs and UDTs is DB2XML. In the documentation, references are made only to the function name.

You can specify UDTs and UDFs without the schema name if you add the schema name to the function path. The function path is an ordered list of schema names. DB2 UDB uses the order of schema names in the list to resolve references to functions and UDTs. You can specify the function path by specifying the SQL statement SET CURRENT FUNCTION PATH. This statement sets the function path in the CURRENT FUNCTION PATH special register.

---

## Storage functions

### Storage functions in XML Extender overview

Use storage functions to insert XML documents into a DB2 UDB database. You can use the default casting functions of a UDT directly in INSERT or SELECT statements. Additionally, XML Extender provides UDFs to take XML documents from sources other than the UDT base data type and convert them to the specified UDT.

### XMLCLOBFromFile() function

**Purpose:**

Reads an XML document from a server file and returns the document as an XMLCLOB type.

**Syntax:**

```
►► XMLCLOBFromFile (—fileName—, src_encoding)
```

**Parameters:**

Table 27. XMLCLOBFromFile parameter

Parameter	Data type	Description
<i>fileName</i>	VARCHAR(512)	The fully qualified server file name.
<i>src_encoding</i>	VARCHAR(100)	The encoding of the source file.

**Results:**

XMLCLOB as LOCATOR

**Example:**

The following example reads an XML document from a file on a server and inserts it into an XML column as an XMLCLOB type. The encoding of the server file is explicitly specified as iso-8859-1.

```
EXEC SQL INSERT INTO sales_tab(ID, NAME, ORDER)
VALUES('1234', 'Sriram Srinivasan',
XMLCLOBFromFile(
'/dxxsamples/xml/getstart.xml', 'iso-8859-1'))
```

The column ORDER in the SALES\_TAB table is defined as an XMLCLOB type.

## XMLFileFromCLOB() function

### Purpose:

Reads an XML document as CLOB locator, writes it to an external server file, and returns the file name and path as an XMLFILE type.

### Syntax:

```
►► XMLFileFromCLOB(—buffer—, —fileName—, —targetencoding—)◄◄
```

### Parameters:

Table 28. XMLFileFromCLOB() parameters

Parameters	Data type	Description
<i>buffer</i>	CLOB as LOCATOR	The buffer containing the XML document.
<i>fileName</i>	VARCHAR(512)	The fully qualified server file name.
<i>targetencoding</i>	VARCHAR(100)	The encoding of the output file.

### Results:

XMLFILE

### Example:

The following example reads an XML document as CLOB locator (a host variable with a value that represents a single LOB value in the database server), writes it to an external server file, and inserts the file name and path as an XMLFILE type in an XML column. The function will encode the output file in ibm-808.

```
EXEC SQL BEGIN DECLARE SECTION;
SQL TYPE IS CLOB_LOCATOR xml_buff;
EXEC SQL END DECLARE SECTION;

EXEC SQL INSERT INTO sales_tab(ID, NAME, ORDER)
VALUES('1234', 'Sriram Srinivasan',
XMLFileFromCLOB(:xml_buff, '/dxxsamples/xml/getstart.xml', 'ibm-808'))
```

The column ORDER in the SALES\_TAB table is defined as an XMLFILE type. If you have an XML document in your buffer, you can store it in a server file.

## XMLFileFromVarchar() function

### Purpose:

Reads an XML document from memory as VARCHAR, writes it to an external server file, and returns the file name and path as an XMLFILE type.

**Syntax:**

►►XMLFileFromVarchar(—buffer—,—fileName—,—targetencoding—)

**Parameters:**

Table 29. XMLFileFromVarchar parameters

Parameter	Data type	Description
<i>buffer</i>	VARCHAR(3K)	The buffer containing the XML document.
<i>fileName</i>	VARCHAR(512)	The fully qualified server file name.
<i>targetencoding</i>	VARCHAR(100)	The encoding of the output file.

**Results:**

XMLFILE

**Example:**

The following examples reads an XML document from memory as VARCHAR, writes it to an external server file, and inserts the file name and path as an XMLFILE type in an XML column. The function will encode the output file in iso-8859-1.

```
EXEC SQL BEGIN DECLARE SECTION;
 struct { short len; char data[3000]; } xml_buff;
EXEC SQL END DECLARE SECTION;

EXEC SQL INSERT INTO sales_tab(ID, NAME, ORDER)
 VALUES('1234', 'Sriram Srinivasan',
 XMLFileFromVarchar(:xml_buff, '/dxxsamples/xml/getstart.xml', 'iso-8859-1'))
```

The column ORDER in the SALES\_TAB table is defined as an XMLFILE type.

## XMLVarcharFromFile() function

**Purpose:**

Reads an XML document from a server file and returns the document as an XMLVARCHAR type.

**Syntax:**

►►XMLVarcharFromFile(—fileName—,—src\_encoding—)

**Parameters:**

Table 30. XMLVarcharFromFile parameter

Parameter	Data type	Description
<i>fileName</i>	VARCHAR(512)	The fully qualified server file name.
<i>src_encoding</i>	VARCHAR(100)	The encoding of the source file.

**Results:**

XMLVARCHAR

**Example:**

The following example reads an XML document from a server file and inserts it into an XML column as an XMLVARCHAR type. The encoding of the server file is explicitly specified as ibm-808.

```
EXEC SQL INSERT INTO sales_tab(ID, NAME, ORDER)
VALUES('1234', 'Sriram Srinivasan',
XMLVarcharFromFile('/dxxsamples/xml/getstart.xml', 'ibm-808'))
```

In this example, a record is inserted into the SALES\_TAB table. The function XMLVarcharFromFile() imports the XML document from a file that is explicitly specified to be encoded in ibm-808 into DB2 UDB and stores it as a XMLVARCHAR.

## Retrieval functions

### Retrieval functions in XML Extender

The XML Extender provides an overloaded function Content(), which is used for retrieval. This overloaded function refers to a set of retrieval functions that have the same name, but behave differently based on where the data is being retrieved. You can also use the default casting functions to convert an XML UDT to the base data type.

The Content() functions provide the following types of retrieval:

- **Retrieval from external storage at the server to a host variable at the client.**  
You can use Content() to retrieve an XML document to a memory buffer when it is stored as an external server file. You can use Content(): retrieve from XMLFILE to a CLOB for this purpose.
- **Retrieval from internal storage to an external server file**  
You can also use Content() to retrieve an XML document that is stored inside DB2 UDB and store it to a server file on the DB2 UDB server's file system. The following Content() functions are used to store information on external server files:
  - Content(): retrieve from XMLVARCHAR to an external server file
  - Content(): retrieval from XMLCLOB to an external server file

## Content(): retrieve from XMLFILE to a CLOB

### Purpose:

Retrieves data from a server file and stores it in a CLOB LOCATOR.

### Syntax:

►► Content(—xmlobj—)◄◄

### Parameters:

Table 31. XMLFILE to a CLOB parameter

Parameter	Data type	Description
<i>xmlobj</i>	XMLFILE	The XML document.

### Results:

CLOB (*clob\_len*) as LOCATOR

*clob\_len* for DB2 UDB is 2G.

### Example:

The following example retrieves data from a server file and stores it in a CLOB locator.

```
char subsystem[20];
long retcode = 0, reason = 0;
extern "OS" { int DSNALI(char * functn, ...); }

extern "OS" short DSNTIAR(struct sqlca *sqlca,
 error_struct *error_message,
 long *data_len);

EXEC SQL BEGIN DECLARE SECTION;
SQL TYPE IS CLOB_LOCATOR xml_buff;
EXEC SQL END DECLARE SECTION;

/* Attach to subsystem */
rc = DSNALI("OPEN ", subsystem, "PLANNAME",
 &retcode, &reason);
if (retcode != 0)
{
 /* print error message */
 goto exit;
}

EXEC SQL DECLARE c1 CURSOR FOR

 SELECT Content(order) from sales_tab
 WHERE sales_person = 'Sriram Srinivasan'

EXEC SQL OPEN c1;

do {
 EXEC SQL FETCH c1 INTO :xml_buff;
 if (SQLCODE != 0) {
 break;
 }
 else {
 /* do with the XML doc in buffer */
 }
}
```



```

 }

EXEC SQL CLOSE c1;

/* Detach from subsystem */
DSNALI("CLOSE", "SYNC", &retcode, &reason);
if (retcode != 0) {
 /* print error message */
}

```

The column ORDER in the SALES\_TAB table is of an XMLFILE type, so the Content() UDF retrieves data from a server file and stores it in a CLOB locator.

**Related tasks:**

- “Updating and deleting data in XML collections” on page 99

## Content(): retrieve from XMLVARCHAR to an external server file

**Purpose:**

Retrieves the XML content that is stored as an XMLVARCHAR type and stores it in an external server file.

**Syntax:**

```

Content((xmlobj, filename, targetencoding))

```

**Important:** If a file with the specified name already exists, the content function overrides its content.

**Parameters:**

Table 32. XMLVarchar to external server file parameters

Parameter	Data type	Description
<i>xmlobj</i>	XMLVARCHAR	The XML document.
<i>filename</i>	VARCHAR(512)	The fully qualified server file name.
<i>targetencoding</i>	VARCHAR(100)	The encoding of the output file.

**Results:**

VARCHAR(512)

**Example:**

The following example retrieves the XML content that is stored as XMLVARCHAR type and stores it in an external file located on the server. The UDF encodes the file in 'ibm-808'.

```

CREATE table app1 (id int NOT NULL, order DB2XML.XMLVarchar);
INSERT into app1 values (1, '<?xml version="1.0"?>
<!DOCTYPE SYSTEM

```

```
"dxxsample/dtd/getstart.dtd"->
 <Order key="1">
 <Customer>
 <Name>American Motors</Name>
 <Email>parts@am.com</Email>
 </Customer>
 <Part color="black">
 <key>68</key>
 <Quantity>36</Quantity>
 <ExtendedPrice>34850.16</ExtendedPrice>
 <Tax>6.000000e-02</Tax>
 <Shipment>
 <ShipDate>1998-08-19</ShipDate>
 <ShipMode>AIR </ShipMode>
 </Shipment>
 <Shipment>
 <ShipDate>1998-08-19</ShipDate>
 <ShipMode>BOAT </ShipMode>
 </Shipment>
 </Part>
 </Order>');

SELECT DB2XML.Content(order, '
/dxxsamples/dad/getstart_column.dad', 'ibm-808')
from app1 where ID=1;
```

**Related tasks:**

- “Method for retrieving an XML document” on page 78

**Related reference:**

- “Retrieval functions in XML Extender” on page 137

## Content(): retrieval from XMLCLOB to an external server file

**Purpose:**

Retrieves the XML content that is stored as an XMLCLOB type and stores it in an external server file.

**Syntax:**

```
Content(—xmlobj—, —filename—, —targetencoding—)
```

**Important:** If a file with the specified name already exists, the content function overrides its content.

**Parameters:**

Table 33. XMLCLOB to external server file parameters

Parameter	Data type	Description
<i>xmlobj</i>	XMLCLOB as LOCATOR	The XML document.
<i>filename</i>	VARCHAR(512)	The fully qualified server file name.
<i>targetencoding</i>	VARCHAR(100)	The encoding of the output file.

## Results:

VARCHAR(512)

## Example:

The following example retrieves the XML content that is stored as an XMLCLOB type and stores it in an external file located on the server. The UDF encodes the file in 'ibm-808'.

```
CREATE table app1 (id int NOT NULL, order DB2XML.XMLCLOB);
```

```
INSERT into app1 values (1, '<?xml version="1.0"?>
<!DOCTYPE SYSTEM
"dxxsamples/dtd/getstart.dtd"->
 <Order key="1">
 <Customer>
 <Name>American Motors</Name>
 <Email>parts@am.com</Email>
 </Customer>
 <Part color="black">
 <key>68</key>
 <Quantity>36</Quantity>
 <ExtendedPrice>34850.16</ExtendedPrice>
 <Tax>6.000000e-02</Tax>
 <Shipment>
 <ShipDate>1998-08-19</ShipDate>
 <ShipMode>AIR </ShipMode>
 </Shipment>
 <Shipment>
 <ShipDate>1998-08-19</ShipDate>
 <ShipMode>BOAT </ShipMode>
 </Shipment>
 </Part>
 </Order>');

SELECT DB2XML.Content(order,
'dxxsamples/xml/getstart.xml', 'ibm-808')
from app1 where ID=1;
```

---

## Extraction functions

### Extracting functions in XML Extender

The extracting functions extract the element content or attribute value from an XML document and return the requested SQL data types. The XML Extender provides a set of extracting functions for various SQL data types. The extracting functions take two input parameters. The first parameter is the XML Extender UDT, which can be one of the XML UDTs. The second parameter is the location path that specifies the XML element or attribute. Each extracting function returns the value that is specified by the location path.

The examples assume you are using the DB2 UDB command shell, in which you do not need to type "DB2" at the beginning of each command.

### extractInteger() and extractIntegers()

#### Purpose:

Extracts the element content or attribute value from an XML document and returns the data as INTEGER type.

**Syntax:**

►►extractInteger(—xmlobj—,—path—)◄◄

**Table function:**

►►extractIntegers(—xmlobj—,—path—)◄◄

**Parameters:**

*Table 34. extractInteger function parameters*

Parameter	Data type	Description
<i>xmlobj</i>	XMLVARCHAR, XMLFILE, or XMLCLOB	The column name.
<i>path</i>	VARCHAR	The location path of the element or attribute.

**Returned type:**

INTEGER

**Examples:**

In the following example, one value is returned when the attribute value of key = "1". The value is extracted as an INTEGER. The examples assume that you are using the DB2 UDB command shell, in which you do not need to type "DB2" at the beginning of each command.

```
CREATE TABLE t1(key INT);
INSERT INTO t1 values (
 DB2XML.extractInteger(DB2XML.XMLFile(
 '/dxxsamples/xml/getstart.xml'),
 '/Order/Part[@color="black "]/key'));
SELECT * from t1;
```

**Table function example:**

In the following example, each order key for the sales orders is extracted as INTEGER. The examples assume that you are using the DB2 UDB command shell, in which you do not need to type "DB2" at the beginning of each command.

```
SELECT *
FROM TABLE(
 DB2XML.extractIntegers(DB2XML.XMLFile('/dxxsamples/xml/getstart.xml'),
 '/Order/Part/key')) AS X;
```

**Related concepts:**

- "Location paths" on page 110
- "UDT and UDF names for XML Extender" on page 134
- "Types of XML Extender user-defined functions" on page 133

**Related reference:**

- "Extracting functions in XML Extender" on page 141

## extractSmallint() and extractSmallints()

### Purpose:

Extracts the element content or attribute value from an XML document and returns the data as SMALLINT type.

### Syntax:

```
▶▶ extractSmallint(—xmlobj—, —path—) ▶▶
```

### Table function:

```
▶▶ extractSmallints(—xmlobj—, —path—) ▶▶
```

### Parameters:

Table 35. extractSmallint function parameters

Parameter	Data type	Description
<i>xmlobj</i>	XMLVARCHAR, XMLFILE, or XMLCLOB	The column name.
<i>path</i>	VARCHAR	The location path of the element or attribute.

### Returned type:

SMALLINT

### Examples:

In the following example, the value of key in all sales orders is extracted as SMALLINT. The examples assume that you are using the DB2 UDB command shell, in which you do not need to type “DB2” at the beginning of each command.

```
CREATE TABLE t1(key INT);
INSERT INTO t1 values (
 DB2XML.extractSmallint(db2xml.xmlfile('/dxxsamples/xml/getstart.xml'),
 '/Order/Part[@color="black "]/key'));
SELECT * from t1;
```

### Table function example:

In the following example, the value of key in all sales orders is extracted as SMALLINT. The examples assume that you are using the DB2 UDB command shell, in which you do not need to type “DB2” at the beginning of each command.

```
SELECT *
FROM TABLE(
 DB2XML.extractSmallints(DB2XML.XMLFile('/dxxsamples/xml/getstart.xml'),
 '/Order/Part/key')) AS X;
```

### Related concepts:

- “UDT and UDF names for XML Extender” on page 134
- “Types of XML Extender user-defined functions” on page 133

### Related reference:

- “Extracting functions in XML Extender” on page 141

## extractDouble() and extractDoubles()

### Purpose:

Extracts the element content or attribute value from an XML document and returns the data as DOUBLE type.

### Syntax:

►► extractDouble(—xmlobj—, —path—) ◀◀

### Table function:

►► extractDoubles(—xmlobj—, —path—) ◀◀

### Parameters:

Table 36. extractDouble function parameters

Parameter	Data type	Description
<i>xmlobj</i>	XMLVARCHAR, XMLFILE, or XMLCLOB	The column name.
<i>path</i>	VARCHAR	The location path of the element or attribute.

### Returned Type:

DOUBLE

### Examples:

The following example automatically converts the price in an order from a DOUBLE type to a DECIMAL. The examples assume that you are using the DB2 command shell, in which you do not need to type “DB2” at the beginning of each command.

```
CREATE TABLE t1(price DECIMAL(9,2));
INSERT INTO t1 values (
 DB2XML.extractDouble(DB2XML.xmlfile('/dxxsamples/xml/getstart.xml'),
 '/Order/Part[@color="black "]/ExtendedPrice');
SELECT * from t1;
```

### Table function example:

In the following example, the value of ExtendedPrice in each part of the sales order is extracted as DOUBLE. The examples assume that you are using the DB2 UDB command shell, in which you do not need to type DB2 UDB at the beginning of each command.

```
SELECT CAST(RETURNEDDOUBLE AS DOUBLE)
FROM TABLE(
 DB2XML.extractDoubles(DB2XML.XMLFile('/dxxsamples/xml/getstart.xml'),
 '/Order/Part/ExtendedPrice')) AS X;
```

### Related concepts:

- “UDT and UDF names for XML Extender” on page 134

### Related reference:

- “Extracting functions in XML Extender” on page 141

## extractReal() and extractReals()

### Purpose:

Extracts the element content or attribute value from an XML document and returns the data as REAL type.

### Syntax:

►► extractReal (—xmlobj—, —path—) ◀◀

### Table function:

►► extractReals (—xmlobj—, —path—) ◀◀

### Parameters:

Table 37. extractReal function parameters

Parameter	Data type	Description
<i>xmlobj</i>	XMLVARCHAR, XMLFILE, or XMLCLOB	The column name.
<i>path</i>	VARCHAR	The location path of the element or attribute.

### Returned type:

REAL

### Examples:

In the following example, the value of ExtendedPrice is extracted as a REAL. The examples assume that you are using the DB2 UDB command shell, in which you do not need to type “DB2” at the beginning of each command.

```
CREATE TABLE t1(price DECIMAL(9,2));
INSERT INTO t1 values (
 DB2XML.extractReal(DB2XML.xmlfile('/dxxsamples/xml/getstart.xml'),
 '/Order/Part[@color="black"]/ExtendedPrice');
SELECT * from t1;
```

### Table function example:

In the following example, the value of ExtendedPrice is extracted as a REAL. The examples assume that you are using the DB2 UDB command shell, in which you do not need to type “DB2” at the beginning of each command.

```
SELECT CAST(RETURNEDREAL AS REAL)
FROM TABLE(
 DB2XML.extractReals(DB2XML.XMLFile('/dxxsamples/xml/getstart.xml'),
 '/Order/Part/ExtendedPrice')) AS X;
```

### Related concepts:

- “UDT and UDF names for XML Extender” on page 134
- “Types of XML Extender user-defined functions” on page 133

### Related reference:

- “Extracting functions in XML Extender” on page 141
- “XML Extender UDF return codes” on page 207

## extractChar() and extractChars()

### Purpose:

Extracts the element content or attribute value from an XML document and returns the data as CHAR type.

### Syntax:

```
►► extractChar—(—xmlobj—, —path—)◄◄
```

### Table function:

```
►► extractChars—(—xmlobj—, —path—)◄◄
```

### Parameters:

Table 38. *extractChar* function parameters

Parameter	Data type	Description
<i>xmlobj</i>	XMLVARCHAR, XMLFILE, or XMLCLOB	The column name.
<i>path</i>	VARCHAR	The location path of the element or attribute.

### Returned type:

CHAR

### Examples:

In the following example, the value of Name is extracted as CHAR. The examples assume that you are using the DB2 UDB command shell, in which you do not need to type “DB2” at the beginning of each command.

```
CREATE TABLE t1(name char(30));
INSERT INTO t1 values (
 DB2XML.extractChar(DB2XML.xmlfile('/dxxsamples/xml/getstart.xml'),
 '/Order/Customer/Name'));
SELECT * from t1;
```

### Table function example:

In the following example, the value of Color is extracted as CHAR. The examples assume that you are using the DB2 UDB command shell, in which you do not need to type “DB2” at the beginning of each command.

```
SELECT *
FROM TABLE(
 DB2XML.extractChars(DB2XML.XMLFile('/dxxsamples/xml/getstart.xml'),
 '/Order/Part/@color')) AS X;
```

### Related reference:

- “Extracting functions in XML Extender” on page 141
- “How to read syntax diagrams” on page xi

## extractVarchar() and extractVarchars()

### Purpose:



Extracts the element content or attribute value from an XML document and returns the data as VARCHAR type.

**Syntax:**

►►extractVarchar(—xmlobj—,—path—)◄◄

**Table function:**

►►extractVarchars(—xmlobj—,—path—)◄◄

**Parameters:**

Table 39. extractVarchar function parameters

Parameter	Data type	Description
<i>xmlobj</i>	XMLVARCHAR, XMLFILE, or XMLCLOB	The column name.
<i>path</i>	VARCHAR	The location path of the element or attribute.

**Returned type:**

VARCHAR(4K)

**Examples:**

In a database with more than 1000 XML documents that are stored in the column ORDER in the SALES\_TAB table, you might want to find all the customers who have ordered items that have an ExtendedPrice greater than 2500.00. The following SQL statement uses the extracting UDF in the SELECT clause:

```
SELECT extractVarchar(Order, '/Order/Customer/Name') from sales_order_view
WHERE price > 2500.00
```

The examples assume that you are using the DB2 UDB command shell, in which you do not need to type “DB2” at the beginning of each command. The UDF extractVarchar() takes the column ORDER as the input and the location path /Order/Customer/Name as the select identifier. The UDF returns the names of the customers. With the WHERE clause, the extracting function evaluates only those orders with an ExtendedPrice greater than 2500.00.

In the following example, the value of Name is extracted as VARCHAR. The examples assume that you are using the DB2 UDB command shell, in which you do not need to type “DB2” at the beginning of each command.

```
CREATE TABLE t1(name varchar(30));
INSERT INTO t1 values (
 DB2XML.extractVarchar(DB2XML.xmlfile('/dxxsamples/xml/getstart.xml'),
 '/Order/Customer/Name'));
SELECT * from t1;
```

**Table function example:**

In the following example, the value of Color is extracted as VARCHAR. The examples assume that you are using the DB2 UDB command shell, in which you do not need to type “DB2” at the beginning of each command.

```
SELECT*
 FROM TABLE(
 DB2XML.extractVarchars(DB2XML.XMLFile('/dxxsamples/xml/getstart.xml'),
 '/Order/Part/@color')) AS X;
```

**Related concepts:**

- “UDT and UDF names for XML Extender” on page 134
- “Types of XML Extender user-defined functions” on page 133

**Related reference:**

- “Extracting functions in XML Extender” on page 141
- “XML Extender UDF return codes” on page 207

## extractCLOB() and extractCLOBs()

**Purpose:**

Extracts a fragment of XML documents, with element and attribute markup and content of elements and attributes, including sub-elements. This function differs from the other extract functions, which return only the content of elements and attributes. The extractClob(s) functions are used to extract document fragments, whereas extractVarchar(s) and extractChar(s) are used to extract simple values.

**Syntax:**

►►—extractCLOB—(—xmlobj—,—path—)—————►►

**Table function:**

►►—extractCLOBs—(—xmlobj—,—path—)—————►►

**Parameters:**

Table 40. extractCLOB function parameters

Parameter	Data type	Description
<i>xmlobj</i>	XMLVARCHAR, XMLFILE, or XMLCLOB	The column name.
<i>path</i>	VARCHAR	The location path of the element or attribute.

**Returned type:**  
CLOB(10K)

**Examples:**

In this example, all name element content and tags are extracted from a purchase order. The examples assume that you are using the DB2 UDB command shell, in which you do not need to type “DB2” at the beginning of each command.

```
CREATE TABLE t1(name DB2XML.xmlclob);
INSERT INTO t1 values (
 DB2XML.extractClob(DB2XML.xmlfile('/dxxsamples/xml/getstart.xml'),
 '/Order/Customer/Name'));
SELECT * from t1;
```

**Table function example:**

In this example, all of the color attributes are extracted from a purchase order. The examples assume that you are using the DB2 UDB command shell, in which you do not need to type “DB2” at the beginning of each command.

```
SELECT *
FROM TABLE(
 DB2XML.extractCLOBs(DB2XML.XMLFile('/dxxsamples/xml/getstart.xml'),
 '/Order/Part/@color')) AS X;
```

**Related concepts:**

- “Types of XML Extender user-defined functions” on page 133

**Related reference:**

- “Extracting functions in XML Extender” on page 141

## extractDate() and extractDates()

**Purpose:**

Extracts the element content or attribute value from an XML document and returns the data as DATE type. The date must be in the format: YYYY-MM-DD.

**Syntax:**

►► extractDate(—xmlobj—, —path—) ◀◀

**Table function:**

►► extractDates(—xmlobj—, —path—) ◀◀

**Parameters:**

Table 41. extractDate function parameters

Parameter	Data type	Description
xmlobj	XMLVARCHAR, XMLFILE, or XMLCLOB	The column name.
path	VARCHAR	The location path of the element or attribute.

**Returned type:**

DATE

**Examples:**

In the following example, the value of ShipDate is extracted as DATE. The examples assume that you are using the DB2 UDB command shell, in which you do not need to type “DB2” at the beginning of each command.

```
CREATE TABLE t1(shipdate DATE);
INSERT INTO t1 values (
 DB2XML.extractDate(DB2XML.xmlfile('/dxxsamples/xml/getstart.xml'),
 '/Order/Part[@color="red "]/Shipment/ShipDate'));
SELECT * from t1;
```

**Table function example:**

In the following example, the value of ShipDate is extracted as DATE.

```

SELECT *
 FROM TABLE(
 DB2XML.extractDates(DB2XML.XMLFile('/dxxsamples/xml/getstart.xml'),
 '/Order/Part[@color="black "]/Shipment/ShipDate')) AS X;

```

**Related concepts:**

- “Types of XML Extender user-defined functions” on page 133

**Related reference:**

- “Extracting functions in XML Extender” on page 141
- “XML Extender UDF return codes” on page 207

## extractTime() and extractTimes()

**Purpose:**

Extracts the element content or attribute value from an XML document and returns the data as TIME type.

**Syntax:**

►► extractTime(—xmlobj—, —path—)◄◄

**Table function:**

►► extractTimes(—xmlobj—, —path—)◄◄

**Parameters:**

Table 42. extractTime function parameters

Parameter	Data type	Description
xmlobj	XMLVARCHAR, XMLFILE, or XMLCLOB	The column name.
path	VARCHAR	The location path of the element or attribute.

**Returned type:**

TIME

**Examples:**

The examples assume that you are using the DB2 UDB command shell, in which you do not need to type “DB2” at the beginning of each command.

```

CREATE TABLE t1(testtime TIME);
INSERT INTO t1 values (
 DB2XML.extractTime(DB2XML.XMLCLOB(
 '<stuff><data>11.12.13</data></stuff>'), '//data'));
SELECT * from t1;

```

**Table function example:**

```

select *
from table(
 DB2XML.extractTimes(DB2XML.XMLCLOB(
 '<stuff><data>01.02.03</data><data>11.12.13</data></stuff>'),
 '//data')) as x;

```

**Related concepts:**

- “UDT and UDF names for XML Extender” on page 134
- “Types of XML Extender user-defined functions” on page 133

**Related reference:**

- “Extracting functions in XML Extender” on page 141

## extractTimestamp() and extractTimestamps()

**Purpose:**

Extracts the element content or attribute value from an XML document and returns the data as `TIMESTAMP` type.

**Syntax:**

►► extractTimestamp(—xmlobj—, —path—) ◀◀

**Table function:**

►► extractTimestamps(—xmlobj—, —path—) ◀◀

**Parameters:**

*Table 43. extractTimestamp function parameters*

Parameter	Data type	Description
<i>xmlobj</i>	XMLVARCHAR, XMLFILE, or XMLCLOB	The column name.
<i>path</i>	VARCHAR	The location path of the element or attribute.

**Returned type:**

`TIMESTAMP`

**Examples:**

The examples assume that you are using the DB2 UDB command shell, in which you do not need to type “DB2” at the beginning of each command.

```
CREATE TABLE t1(testtimestamp TIMESTAMP);
INSERT INTO t1 values (
 DB2XML.extractTimestamp(DB2XML.XMLCLOB(
 '<stuff><data>2003-11-11-11.12.13.888888</data></stuff>'),
 '//data'));
SELECT * from t1;
```

**Table function example:**

```
select * from
table(DB2XML.extractTimestamps(DB2XML.XMLClob(
 '<stuff><data>2003-11-11-11.12.13.888888
 </data><data>2003-12-22-11.12.13.888888</data></stuff>'),
 '//data')) as x;
```

XML Extender will automatically normalize timestamps extracted from XML documents to comply with the DB2 timestamp format if needed. Timestamps are normalized to the `yyyy-mm-dd-hh.mm.ss.nnnnnn` format or the `yyyy-mm-dd-hh mm.ss.nnnnnn` format. For example:

2003-1-11-11.12.13

will be normalized to:  
2003-01-11-11.12.13.000000

**Related concepts:**

- “UDT and UDF names for XML Extender” on page 134
- “Types of XML Extender user-defined functions” on page 133

**Related reference:**

- “Extracting functions in XML Extender” on page 141
- “XML Extender UDF return codes” on page 207

---

## Update functions in XML Extender

The Update() function updates a specified element or attribute value in one or more XML documents stored in the XML column. You can also use the default casting functions to convert an SQL base type to the XML UDT.

### Purpose

Takes the column name of an XML UDT, a location path, and a string of the update value and returns an XML UDT that is the same as the first input parameter. With the Update() function, you can specify the element or attribute that is to be updated.

### Syntax

►► Update(—xmlobj—, —path—, —value—) ◀◀

### Parameters

Table 44. The UDF Update parameters

Parameter	Data type	Description
<i>xmlobj</i>	XMLVARCHAR, XMLCLOB as LOCATOR	The column name.
<i>path</i>	VARCHAR	The location path of the element or attribute.
<i>value</i>	VARCHAR	The update string.

**Restriction:** The Update function does not have an option to disable output escaping; the output of an extractClob (which is a tagged fragment) cannot be inserted using this function. Use textual values only.

**Restriction:** Note that the Update UDF supports location paths that have predicates with attributes, but not elements. For example, the following predicate is supported:

```
'/Order/Part[@color="black "]/ExtendedPrice'
```

The following predicate is not supported:  
 '/Order/Part/Shipment/[Shipdate < "11/25/00"]'

## Return type

Data type	Return type
XMLVARCHAR	XMLVARCHAR
XMLCLOB as LOCATOR	XMLCLOB

## Example

The following example updates the purchase order handled by the salesperson Sriram Srinivasan.

```
UPDATE sales_tab
 set order = db2xml.update(order, '/Order/Customer/Name', 'IBM')
 WHERE sales_person = 'Sriram Srinivasan'
```

In this example, the content of /Order/Customer/Name is updated to IBM.

## Usage

When you use the Update function to change a value in one or more XML documents, it replaces the XML documents within the XML column. Based on output from the XML parser, some parts of the original document are preserved, while others are lost or changed. The following sections describe how the document is processed and provide examples of how the documents look before and after updates.

### How the Update() function processes the XML document

When the Update() function replaces XML documents, it must reconstruct the document based on the XML parser output. Table 45 describes how the parts of the document are handled, with examples.

Table 45. Update function rules

Item or node type	XML document code example	Status after update
XML declaration	<?xml version='1.0' encoding='utf-8' standalone='yes' >	The XML declaration is preserved.
DOCTYPE Declaration	<!DOCTYPE books SYSTEM "http://dtds.org/books.dtd" > <!DOCTYPE books PUBLIC "local.books.dtd" "http://dtds.org/books.dtd" > <!DOCTYPE books> -Any of <!DOCTYPE books ( S ExternalID ) ? [ internal-dtd-subset ] > -Such as <!DOCTYPE books [ <!ENTITY mydog "Spot"> ] >? [ internal-dtd-subset ] >	The document type declaration is preserved:

Table 45. Update function rules (continued)

Item or node type	XML document code example	Status after update
Comments	<code>&lt;!-- comment --&gt;</code>	Comments are preserved outside the root element.  Comments inside the root element are discarded.
Elements	<code>&lt;books&gt; content &lt;/books&gt;</code>	Elements are preserved.
Attributes	<code>id='1' date="01/02/2003"</code>	Attributes of elements are preserved. <ul style="list-style-type: none"> <li>• After update, double quotation marks are used to delineate values.</li> <li>• Data within attributes is lost.</li> <li>• Entities are replaced.</li> </ul>
Text Nodes	<code>This section is about my dog &amp;mydog;.</code>	Text nodes (element content) are preserved. <ul style="list-style-type: none"> <li>• Data within text nodes is lost.</li> <li>• Entities are replaced.</li> </ul>

### Multiple occurrence

When a location path is provided in the Update() UDF, the content of every element or attribute with a matching path is updated with the supplied value. This means that if a document has multiple occurring location paths, the Update() function replaces the existing values with the value provided in the *value* parameter.

You can specify a predicate in the *path* parameter to provide distinct locations paths to prevent unintentional updates. The Update() UDF supports location paths that have predicates with attributes, but not elements.

## Generate unique function

### Purpose

The generate unique function returns a character string that is unique compared to any other execution of the same function. There are no arguments to this function (the empty parentheses must be specified). The result of the function is a unique value. The result cannot be null.

### Syntax

►►—db2xml.generate\_unique()—◀◀

### Return value

VARCHAR(13)



## Example

The following example uses `db2xml.generate_unique()` to generate a unique key for a column to be indexed.

```
<SQL_stmt>
SELECT o.order_key, customer_name, customer_email, p.part_key, color,
quantity, price, tax, ship_id, date, mode from order_tab o, part_tab p,
(select db2xml.generate_unique()
 as ship_id, date, mode, part_key from ship_tab) as s
WHERE o.order_key = 1 and
 p.price > 20000 and
 p.order_key = o.order_key and
 s.part_key = p.part_key
ORDER BY order_key, part_key, ship_id
</SQL_stmt>
```

---

## Validation functions

DB2 XML Extender offers two user defined functions (UDFs) that validate XML documents against either an XML schema or a DTD.

An element in an XML document is valid according to a given schema if the associated element type rules are satisfied. If all elements are valid, the whole document is valid. With a DTD, however, there is no way to require a specific root element. The validation functions return 1 if the document is valid or they return 0 and write an error message in the trace file if the document is invalid. The functions are:

**db2xml.svalidate:**

Validates an XML document instance against the specified schema.

**db2xml.dvalidate:**

Validates an XML document instance against the specified DTD.

## SVALIDATE() function

This function validates an XML document against a specified schema (or the one named in the XML document) and returns 1 if the document is valid or 0 if not. This function assumes that an XML document and a schema exist on the file system or as a CLOB in DB2.

Before you run the SVALIDATE function, ensure that XML Extender is enabled with your database by running the following command:

```
CALL QDBXM/QZXADM PARM(enable_db mydbname)
```

If the XML document fails the validation, an error message is written to the XML Extender trace file. Enable the trace before executing the SVALIDATE command.

## Syntax

```
►► SVALIDATE (—xmlobj— [—schemadoc—] [—schemalocation—])
```

## Parameters

Table 46. The SVALIDATE parameters

Parameter	Data type	Description
<i>xmlobj</i>  Required. Only one <i>xmlobj</i> allowed.	VARCHAR(256)	The fully-qualified file name of the XML document to be verified.
	CLOB(2G)	XML column that contains the document to be verified.
<i>schemadoc</i>  Optional. No default. Only one <i>schemadoc</i> allowed.	VARCHAR(256)	The fully-qualified file name of the schema document (with no target namespace) with which to validate the XML document.
	CLOB(2G)	XML column that contains the schema (with no target namespace) with which to validate the XML document.
<i>schemalocation</i>  Optional. No default. Not allowed if <i>nonamespace</i> <i>schemadoc</i> is data type CLOB.	VARCHAR(256)	Namespace URI and fully-qualified schema document file name pairs to use for validation. You can specify one or more pairs separated by a space.

## Examples

**Example 1:** This example validates *equiplog2001.xml* against the schema that is specified within the document.

```
select db2xml.svalidate('/dxxsamples/xml/equiplog2001..xml') from db2xml.onerow
```

**Example 2:** This example validates an XML document using the specified schema, and both the document and schema are stored in DB2 UDB tables.

```
select db2xml.svalidate(doc,schema) from xml where id=1
```

### Example 3:

This example validates the XML document in CLOB column *xml* in *a\_table* against the specified *nonamespace* schema *schema1.xsd* and the specified list of namespace schemas, *schema2.xsd* and *schema3.xsd*, that are associated with target namespaces *http://ns1* and *http://ns2*:

```
select db2xml.svalidate(
 xml,
 'xsd/schema1.xsd',
 'http://ns1 /dxxsamples/schema2.xsd
 http://ns2 /dxxsamples/schema3.xsd')
from a_table where id=2
```

### Example 4:

This example validates *test.xml* against the specified list of schemas, *schema1.xsd* and *schema2.xsd*, that are associated with target namespaces, *http://ns1* and *http://ns2*.

```
select db2xml.svalidate(
 '/dxxsamples/xml/test.xml',
 '
 '
```



```
select db2xml.dvalidate (doc,dtdid) from equiplogs, db2xml.dtd_ref \
 where dtdid='equip.dtd'
```

**Related reference:**

- “Starting the trace for XML Extender” on page 205

---

## Chapter 9. Document access definition (DAD) files

---

### Creating a DAD file for XML columns

This task is part of the larger task of defining and enabling an XML column.

To access your XML data and enable columns for XML data in an XML table, you need to define a document access definition (DAD) file. This file defines the attributes and key elements of your data that need to be searched within the column. For XML columns, the DAD file primarily specifies how documents stored within it are to be indexed. The DAD file also specifies a DTD or schema to use for validating documents that are inserted into the XML column. DAD files are stored as a CLOB data type, and their size limit is 100 KB.

#### Prerequisites:

Before you create the DAD file, you need to:

- Decide which elements or attributes you expect to use often in your search. The elements or attributes that you specify are extracted into the side tables for fast searches by the XML Extender.
- Define the location path to represent each element or attribute indexed in a side table. You must also specify the type of data that you want the element or attribute to be converted to.

#### Procedure:

To create a DAD file:

1. Create a new document in a text editor and type the following syntax:

```
<?XML version="1.0"?>
<!DOCTYPE DAD SYSTEM <"path/dtd/dad.dtd">.
```

*"path/dtd/dad.dtd "* is the path and file name of the DTD for the DAD file. A DTD is provided in `dxx_install\samples\db2xml\dtd`

2. Insert DAD tags after the lines from step 1.

```
<DAD>
</DAD>
```

This element will contain all the other elements.

3. Specify validation for the document and the column:

- If you want to validate your entire XML document against a DTD or schema before it is inserted into the database:
  - Insert the appropriate tag to specify how you want to validate the document:

```
<dtdid>dtd_name.dtd</dtdid>
```
  - Insert the following tag to validate the document using a schema:

```
<schemabindings>
<nonamespacelocation location="path/schema_name.xsd"/>
</schemabindings>
```
  - Validate the column by inserting the following tag:

```
<validation>YES</validation>
```

- If you don't want to validate the document, use the following tag:  
`<validation>NO</validation>`
4. Insert `<Xcolumn>` `</Xcolumn>` tags to specify that you are using XML columns as the access and storage method for your XML data.
  5. Specify side tables. For each side table that you want to create:
    - a. Specify a `<table></table>` tag. For example:

```
<table name="person_names">
</table>
```

- b. Inside the table tags, insert a `<column>` tag for each column that you want the side table to contain. Each column has four attributes: name, type, path and, multi\_occurrence.

**Example:**

```
<table name="person_names">>
<column name="fname"
 type="varchar(50)"
 path="/person/firstName"
 multi_occurrence="NO"/>
<column name="lname"
 type="varchar(50)"
 path="/person/lastName"
 multi_occurrence="NO"/>
</table>
```

Where:

**name** Specifies the name of the column that is created in the side table.

**type** Indicates the SQL data type in the side table for each indexed element or attribute

**path** Specifies the location path in the XML document for each element or attribute to be indexed

**multi\_occurrence**

Indicates whether the element or attribute referred to by the path attribute can occur more than once in the XML document. The possible values for **multi\_occurrence** are **YES** or **NO**. If the value is **NO**, then multiple columns can be specified per table. If the value is **YES**, you can specify only one column in the side table.

6. Save your file with a DAD extension.

The following example shows a complete DAD file:

```
<?xml version="1.0"?>
<!DOCTYPE DAD SYSTEM "dxsamples\dtd\dad.dtd">
<DAD>
<dtid>C:\SG246130\code\person.dtd</dtid>
<validation>YES</validation>
<Xcolumn>
 <table name="person_names">
 <column name="fname"
 type="varchar(50)"
 path="/person/firstName"
 multi_occurrence="NO"/>
 <column name="lname"
 type="varchar(50)"
 path="/person/lastName"
 multi_occurrence="NO"/>
 </table>
 <table name="person_phone_number">
 <column name="pnumber">
```

```

 type="varchar(20)"
 path="/person/phone/number"
 multi_occurrence="YES"/>
</table>
<table name="person_phone_number">
 <column name="pnumber"
 type="varchar(20)"
 path="/person/phone/number"
 multi_occurrence="YES"/>
</table>
<table name="person_phone_type">
 <column name="ptype"
 type="varchar(20)"
 path="/person/phone/type"
 multi_occurrence="YES"/>
</table>
<Xcolumn>
</DAD>

```

Now that you created a DAD file, the next step to defining and enabling an XML column is to create the table in which your XML documents will be stored.

**Related concepts:**

- “XML collections as a storage and access method” on page 89
- “DAD files for XML collections” on page 161

## DAD files for XML collections

For XML collections, the DAD file maps the structure of the XML document to the DB2<sup>®</sup> tables from which you compose the document. You can also decompose documents to the DB2 UDB tables using the DAD file.

For example, if you have an element called <Tax> in your XML document, you need to map <Tax> to a column called TAX. You use the DAD file to define the relationship between the XML data and the relational data.

You must specify the DAD file either while enabling a collection, or when you are using the DAD file in stored procedures for XML collections. The DAD is an XML-formatted document, residing at the client. If you choose to validate XML documents with a DTD, the DAD file can be associated with that DTD. When used as the input parameter of the XML Extender stored procedures, the DAD file has a data type of CLOB. This file can be up to 100 KB.

To specify the XML collection access and storage method, use the <Xcollection> tag in your DAD file.

**<Xcollection>**

Specifies that the XML data is either to be decomposed from XML documents into a collection of relational tables, or to be composed into XML documents from a collection of relational tables.

An XML collection is a set of relational tables that contains XML data. Applications can enable an XML collection of any user tables. These user tables can be tables of existing business data or tables that XML Extender recently created.

| The DAD specifies mappings between elements or attributes of the XML document  
 | and columns of tables. It uses the following kinds of nodes to specify these  
 | mappings:

	<b>root_node</b>
	Specifies the root element of the document.
	<b>element_node</b>
	Identifies an element, which can be the root element or a child element.
	<b>text_node</b>
	Represents the CDATA text of an element.
	<b>attribute_node</b>
	Represents an attribute of an element.

Figure 14 shows a fragment of the mapping that is used in a DAD file. The nodes map the XML document content to table columns in a relational table.

```

<?xml version="1.0"?>
<!DOCTYPE DAD SYSTEM "dxsamples\dtd\dad.dtd">
<DAD>
 ...
 <Xcollection>
 <SQL_stmt>
 ...
 </SQL_stmt>
 <prolog?xml version="1.0"?</prolog>
 <doctype>!DOCTYPE Order SYSTEM
 "dxsamples/dtd/getstart.dtd"</doctype>
 <root_node>
 <element_node name="Order"> --> Identifies the element <Order>
 <attribute_node name="key"> --> Identifies the attribute "key"
 <column name="order_key"/> --> Defines the name of the column,
 "order_key", to which the
 element and attribute are
 mapped
 </attribute_node>
 <element_node name="Customer"> --> Identifies a child element of
 <Order> as <Customer>
 <text_node> --> Specifies the CDATA text for
 the element <Customer>
 <column name="customer"> --> Defines the name of the column,
 "customer", to which the child
 element is mapped
 </text_node>
 </element_node>
 ...
 </element_node>
 ...
 </root_node>
 </Xcollection>
</DAD>

```

Figure 14. Node definitions for the XML document as mapped to the XML collection table

In this example, the first two columns have elements and attributes mapped to them.

You can use the XML Extender administration wizard or an editor to create and update the DAD file.

**Related concepts:**

- “Mapping schemes for XML collections” on page 102



## SQL composition

You can compose XML documents using columns with the same name. Selected columns with the same name, even if from diverse tables, must be identified by a unique alias so that every variable in the select clause of the SQL statement is different. The following example shows how you would give unique aliases to columns that have the same names.

```
<SQL_stmt>select o.order_key as oorder_key,
 key, customer_name, customer_email,
 p.part_key, p.order_key as porder_key,
 color, qty, price, tax, ship_id, date, mode
from order_tab o,part_tab p
order by oorder_key, part_key</SQL_stmt>
```

You can also compose XML documents using columns with generated random values. If an SQL statement in a DAD file has a random value, you must give the random value function an alias to use it in the ORDER BY clause. This requirement is necessary because the value is not associated with any column in a given table. See the alias for generate\_unique at the end of the ORDER BY clause in the following example.

```
<SQL_stmt>select o.order_key, customer_name,customer_email,
 p.part_key,color,qty,price,tax,ship_id,
 date, mode
from order_tab o,part_tab p,
table (select db2xml.generate_unique()
as ship_id, date, mode,
 part_key
 from ship_tab) s
where o.order_key=1 and p.price>2000 and
o.order_key=o.order_key and s.part_key
order by order_key, part_key,ship_id</SQL_stmt>
```

## RDB node composition

The following restrictions apply to RDB node composition:

- The condition associated with any non-root\_node RDB node DAD file must compare against a literal.
- The condition associated with any lower level RDB node in the DAD must compare against a literal.
- The condition associated with a root\_node describes the relationship between the tables involved in the RDB node composition. An example is a primary foreign key relationship.
- Each equality in the condition associated with a top-level RDB\_node specifies the join relationship between columns of two tables and is applied separately from the other equalities. That is, all the predicates connected by AND do not apply simultaneously for a single join condition; they simulate an outer join when the document is composed. The parent-child relationship between each pair of tables is determined by their relative nesting in the DAD file. For example:

```
<condition>order_tab.order_key=part_tab.order_key AND
part_tab.part_key=ship_tab.part_key</condition>
```

## Composition from rows that have null values

You can use columns that have null values to compose XML documents.

The following example illustrates how you can generate an XML document from a table *MyTable* which has a row containing a null value in column *Col 1*. The DAD used in the example is *nullcol.dad*.

```
<?xml version="1.0"?>
<!DOCTYPE DAD SYSTEM "c:\dxx\dtd\dad.dtd">
<DAD>
<validation>NO validation>NO>
<Xcollection>
<SQL_stmt>SELECT 1 as X, Col1 FROM MyTable order by X, Col1<\SQL_stmt>
<prolog>?xml version="1.0"?prolog>?xml version="1.0"?>
<doctype>!DOCTYPE Order SYSTEM "e:\t3xml\x.dtd">
<root_node>
<element_node name="MyColumn">
<element_node name="Column1" multi_occurrence="YES">
 <text_node>
 <column name="Col1"/>
 </text_node>
</element_node>
</element_node>
</root_node>
</Xcollection>
</DAD>
```

MyTable

Col 1
1
3
-

Run *dxxGenXML* to produce the following document. There is no third *Column1* element because that row in the table had a null value.

```
<?xml version="1.0"?>
<!DOCTYPE Order SYSTEM "e:\t3xml\x.dtd">
<MyColumn>
 <Column1>1</Column1>
 <Column1>3</Column1>
</MyColumn>
<condition>order_tab.order_key=part_tab.order_key AND
part_tab.part_key=ship_tab.part_key</condition>
```

---

## DTD for the DAD file

This topic describes the document type declarations (DTD) for the document access definition (DAD) file. The DAD file itself is a tree-structured XML document and requires a DTD. The DTD file name is *dad.dtd*. The following example shows the DTD for the DAD file.

```
<?xml encoding="US-ASCII"?>
 <!ELEMENT DAD ((schemabindings | dtdid)?, validation,
(Xcolumn | Xcollection))>
 <!ELEMENT dtdid (#PCDATA)>
 <!ELEMENT schemabindings (nonamespacelocation)>
 <!ELEMENT nonamespacelocation (empty)>
 <!ATTLIST nonamespacelocation location CDATA #REQUIRED>
 <!ELEMENT validation (#PCDATA)>
```

```

<!ELEMENT Xcolumn (table+)>
<!ELEMENT table (column+)>
<!ATTLIST table name CDATA #REQUIRED
 key CDATA #IMPLIED
 orderBy CDATA #IMPLIED>
<!ELEMENT column EMPTY>
<!ATTLIST column
 name CDATA #REQUIRED
 type CDATA #IMPLIED
 path CDATA #IMPLIED
 multi_occurrence CDATA #IMPLIED>
<!ELEMENT Xcollection (SQL_stmt?, prolog, doctype, root_node)>
<!ELEMENT SQL_stmt (#PCDATA)>
<!ELEMENT prolog (#PCDATA)>
<!ELEMENT doctype (#PCDATA | RDB_node)*>
<!ELEMENT root_node (element_node)>
<!ELEMENT element_node (RDB_node*,
 attribute_node*,
 text_node?,
 element_node*,
 namespace_node*,
 process_instruction_node*,
 comment_node*)>
<!ATTLIST element_node
 name CDATA #REQUIRED
 ID CDATA #IMPLIED
 multi_occurrence CDATA "NO"
 BASE_URI CDATA #IMPLIED>
<!ELEMENT attribute_node (column | RDB_node)>
<!ATTLIST attribute_node
 name CDATA #REQUIRED>
<!ELEMENT text_node (column | RDB_node)>
<!ELEMENT RDB_node (table+, column?, condition?)>
<!ELEMENT condition (#PCDATA)>
<!ELEMENT comment_node (#PCDATA)>
<!ELEMENT process_instruction_node (#PCDATA)>

```

The DAD file has four major elements:

- DTDID
- validation
- Xcolumn
- Xcollection

Xcolumn and Xcollection have child element and attributes that aid in the mapping of XML data to relational tables in DB2. The following list describes the major elements and their child elements and attributes. Syntax examples are taken from the previous example.

#### DTDID element

DTDs that are provided to XML Extender are stored in the DTD\_REF table. Each DTD is identified by a unique ID that is provided in the DTDID tag of the DAD file. The DTDID points to the DTD that validates the XML documents, or guides the mapping between XML collection tables and XML documents. For XML collections, this element is required only for validating input and output XML documents. For XML columns, this element is needed only to validate input XML documents. The DTDID must be the same as the SYSTEM ID specified in the doctype of the XML documents.

**Syntax:** <!ELEMENT dtdid (#PCDATA)>

**validation element**

Indicates whether the XML document is to be validated with the DTD for the DAD. If YES is specified, then the DTDID must also be specified.

**Syntax:** <!ELEMENT validation(#PCDATA)>

**Xcolumn element**

Defines the indexing scheme for an XML column. It is composed of zero or more tables.

**Syntax:** <!ELEMENT Xcolumn (table\*)>Xcolumn has one child element, table.

**table element**

Defines one or more relational tables created for indexing elements or attributes of documents stored in an XML column.

**Syntax:**

```
<!ELEMENT table (column+)>
<!ATTLIST table name CDATA #REQUIRED
 key CDATA #IMPLIED
 orderBy CDATA #IMPLIED>
```

The table element has one mandatory and two implied attributes:

**name attribute**

Specifies the name of the side table.

**key attribute**

The primary single key of the table.

**orderBy attribute**

The names of the columns that determine the sequence order of multiple-occurring element text or attribute values when generating XML documents.

The table element has one child element:

**column element**

Maps an attribute of a CDATA node from the input XML document to a column in the table.

**Syntax:**

```
<!ATTLIST column
 name CDATA #REQUIRED
 type CDATA #IMPLIED
 path CDATA #IMPLIED
 multi_occurrence CDATA #IMPLIED>
```

The column element has the following attributes:

**name attribute**

Specifies the name of the column. It is the alias name of the location path that identifies an element or attribute.

**type attribute**

Defines the data type of the column. It can be any SQL data type.

**path attribute**

Shows the location path of an XML element or attribute and must be the simple location path as specified in Table 3.1.a.

### **multi\_occurrence attribute**

Specifies whether this element or attribute can occur more than once in an XML document. Values can be YES or NO.

### **Xcollection**

Defines the mapping between XML documents and an XML collection of relational tables.

#### **Syntax:**

```
<!ELEMENT Xcollection(SQL_stmt?, prolog, doctype, root_node)>
```

Xcollection has the following child elements:

#### **SQL\_stmt**

Specifies the SQL statement that XML Extender uses to define the collection. Specifically, the statement selects XML data from the XML collection tables, and uses the data to generate the XML documents in the collection. The value of this element must be a valid SQL statement. It is only used for composition, and only a single SQL\_stmt is allowed.

**Syntax:** <!ELEMENT SQL\_stmt #PCDATA >

#### **prolog**

The text for the XML prolog. The same prolog is supplied to all documents in the entire collection. The value of prolog is fixed.

**Syntax:** <!ELEMENT prolog #PCDATA>

#### **doctype**

Defines the text for the XML document type definition.

#### **Syntax:**

```
<!ELEMENT doctype (#PCDATA | RDB_node)*>
```

doctype is used to specify the DOCTYPE of the resulting document. Define an explicit value. This value is supplied to all documents in the entire collection.

doctype has one child element:

#### **root\_node**

Defines the virtual root node. root\_node must have one required child element, element\_node, which can be used only once. The element\_node under the root\_node is actually the root\_node of the XML document.

**Syntax:** <!ELEMENT root\_node(element\_node)>

#### **RDB\_node**

Defines the DB2 UDB table where the content of an XML element or value of an XML attribute is to be stored or from where it will be retrieved. rdb\_node is a child element of element\_node, text\_node, and attribute\_node and has the following child elements:

**table** Specifies the table in which the element or attribute content is stored.

#### **column**

Specifies the column in which the element or attribute content is stored.

**condition**

Specifies a condition for the column. Optional.

**element\_node**

Represents an XML element. It must be defined in the DAD specified for the collection. For the RDB\_node mapping, the root element\_node must have an RDB\_node to specify all tables containing XML data for itself and all of its child nodes. It can have zero or more attribute\_nodes and child element\_nodes, as well as zero or one text\_node. For elements other than the root element no RDB\_node is needed.

**Syntax:**

An element\_node is defined by the following child elements:

**RDB\_node**

(Optional) Specifies tables, column, and conditions for XML data. The RDB\_node for an element needs to be defined only for the RDB\_node mapping. In this case, one or more tables must be specified. The column is not needed because the element content is specified by its text\_node. The condition is optional, depending on the DTD and query condition.

**child nodes**

Optional: An element\_node can also have the following child nodes:

**element\_node**

Represents child elements of the current XML element.

**attribute\_node**

Represents attributes of the current XML element.

**text\_node**

Represents the CDATA text of the current XML element.

**attribute\_node**

Represents an XML attribute. It is the node that defines the mapping between an XML attribute and the column data in a relational table.

**Syntax:**

The attribute\_node must have definitions for a name attribute, and either a column or a RDB\_node child element. attribute\_node has the following attribute:

**name** The name of the attribute.

attribute\_node has the following child elements:

**column**

Used for the SQL mapping. The column must be specified in the SELECT clause of SQL\_stmt.

**RDB\_node**

Used for the RDB\_node mapping. The node defines the

mapping between this attribute and the column data in the relational table. The table and column must be specified. The condition is optional.

**text\_node**

Represents the text content of an XML element. It is the node that defines the mapping between an XML element content and the column data in a relational table.

**Syntax:** It must be defined by a column or an RDB\_node child element:

**column**

Needed for the SQL mapping. In this case, the column must be in the SELECT clause of SQL\_stmt.

**RDB\_node**

Needed for the RDB\_node mapping. The node defines the mapping between this text content and the column data in the relational table. The table and column must be specified. The condition is optional.

**Related concepts:**

- “DAD files for XML collections” on page 161

**Related tasks:**

- “Dynamically overriding values in the DAD file” on page 169

---

## Dynamically overriding values in the DAD file

**Procedure:**

For dynamic queries you can use two optional parameters to override conditions in the DAD file: *override* and *overrideType*. Based on the input from *overrideType*, the application can override the <SQL\_stmt> tag values for SQL mapping or the conditions in RDB\_nodes for RDB\_node mapping in the DAD.

These parameters have the following values and rules:

*overrideType*

This parameter is a required input parameter (IN) that flags the type of the *override* parameter. The *overrideType* parameter has the following values:

**NO\_OVERRIDE**

Specifies not to override a condition in the DAD file.

**SQL\_OVERRIDE**

Specifies to override a condition in the DAD file with an SQL statement.

**XML\_OVERRIDE**

Specifies to override a condition in the DAD file with an XPath-based condition.

*override*

This parameter is an optional input parameter (IN) that specifies the override condition for the DAD file. The syntax of the input value corresponds to the value specified on the *overrideType* parameter:

- If you specify NO\_OVERRIDE, the input value is a NULL string.
- If you specify SQL\_OVERRIDE, the input value is a valid SQL statement.

If you use SQL\_OVERRIDE as an SQL statement, you must use the SQL mapping scheme in the DAD file. The input SQL statement overrides the SQL statement specified by the <SQL\_stmt> element in the DAD file.

- If you specify XML\_OVERRIDE, the input value is a string that contains one or more expressions.

If you use XML\_OVERRIDE and an expression, you must use the RDB\_node mapping scheme in the DAD file. The input XML expression overrides the RDB\_node condition specified in the DAD file. The expression uses the following syntax:

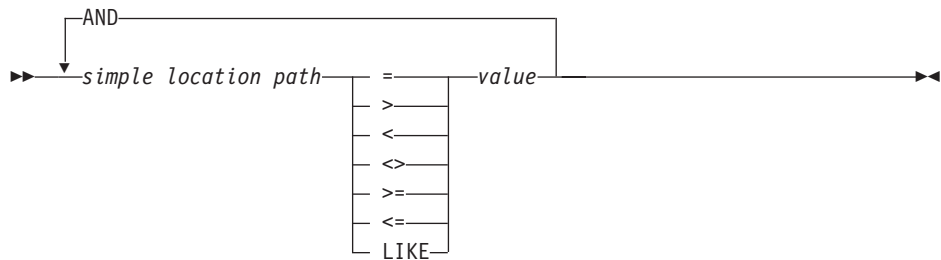

This syntax has the following components:

*simple location path*

Specifies a simple location path, using syntax defined by XPath..

**operators**

The SQL operators shown in the syntax diagram can have a space to separate the operator from the other parts of the expression.

Spaces around the operators are optional. Spaces are mandatory around the LIKE operator.

*value*

A numeric value or a string enclosed in single quotation marks.

**AND**

And is treated as a logical operator on the same location path. If a simple location path is specified more than once in the override string, then all the predicates for that simple location path are applied simultaneously.

If you specify XML\_OVERRIDE, the condition for the RDB\_node in the text\_node or attribute\_node that matches the simple location path is overridden by the specified expression.

XML\_OVERRIDE is not completely XPath compliant. The simple location path is used only to identify the element or attribute that is mapped to a column.

The following examples use SQL\_OVERRIDE and XML\_OVERRIDE to show dynamic override.

**Example 1:** A stored procedure using SQL\_OVERRIDE. In this example, the <xcollection> element in the DAD file must have an <SQL\_stmt> element. The *override* parameter overrides the value of <SQL\_stmt>, by changing the price to be greater than 50.00, and the date to be greater than 1998-12-01.

```
#include "dxx.h"
#include "dxxrc.h"

EXEC SQL INCLUDE SQLCA;
```



```

EXEC SQL BEGIN DECLARE SECTION;
char collectionName[32]; /* name of an XML collection */
char result_tab[32]; /* name of the result table */
char result_colname[32]; /* name of the result column */
char valid_colname[32]; /* name of the valid column, will set to NULL*/
char override[512]; /* override */
short overrideType; /* defined in dxx.h */
short max_row; /* maximum number of rows */
short num_row; /* actual number of rows */
long returnCode; /* return error code */
char returnMsg[1024]; /* error message text */
short collectionName_ind;
short rtab_ind;
short rcol_ind;
short vcol_ind;
short ovtype_ind;
short ov_ind;
short maxrow_ind;+
short numrow_ind;
short returnCode_ind;
short returnMsg_ind;
EXEC SQL END DECLARE SECTION;
float price_value;

/* create table */
EXEC SQL CREATE TABLE xml_order_tab (xmlorder XMLVarchar);

/* initial host variable and indicators */
strcpy(collection, "sales_ord");
strcpy(result_tab, "xml_order_tab");
strcpy(result_col, "xmlorder");
valid_colname[0] = '\0';

/* get the price_value from some place, such as from data */
price_value = 1000.00 /* for example */

/* specify the override */
sprintf(override,
 " SELECT o.order_key, customer, p.part_key,
 quantity, price, tax, ship_id, date, mode
 FROM order_tab o, part_tab p,
 table(select db2xml.generate_unique()
 as ship_id, date, mode from ship_tab) s
 WHERE p.price > %d and s.date >'1996-06_01' AND
 p.order_key = o.order_key and s.part_key = p.part_key",
 price_value);

overrideType = SQL_OVERRIDE;
max_row = 0;
num_row = 0;
returnCode = 0;
msg_txt[0] = '\0';
collectionName_ind = 0;
rtab_ind = 0;
rcol_ind = 0;
vcol_ind = -1;
ov_ind = 0;
ovtype_ind = 0;
maxrow_ind = 0;
numrow_ind = -1;
returnCode_ind = -1;
returnMsg_ind = -1;

/* Call the stored procedure */
EXEC SQL CALL "DB2XML.DXXRETRIEVEXML" (:collectionName:collectionName_ind,
 :result_tab:rtab_ind,
 :result_colname:rcol_ind,

```

```

 :valid_colname:vcol_ind,
 :overrideType:ovtype_ind,:override:ov_ind,
 :max_row:maxrow_ind,:num_row:numrow_ind,
 :returnCode:returnCode_ind,
 :returnMsg:returnMsg_ind);

if (SQLCODE < 0) {
 EXEC SQL ROLLBACK;
 else
 EXEC SQL COMMIT;
}

```

**Example 2:** A stored procedure using XML\_OVERRIDE. In this example, the <collection> element in the DAD file has an RDB\_node for the root element\_node. The *override* value is XML-content based. The XML Extender converts the simple location path to the mapped DB2 UDB column.

```

#include "dxx.h"
#include "dxxrc.h"

EXEC SQL INCLUDE SQLCA;
EXEC SQL BEGIN DECLARE SECTION;
char collectionName[32]; /* name of an XML collection */
char result_tab[32]; /* name of the result table */
char result_colname[32]; /* name of the result column */
char valid_colname[32]; /* name of the valid column, will set to NULL*/
char override[256]; /* override, SQL_stmt*/
short overrideType; /* defined in dxx.h */
short max_row; /* maximum number of rows */
short num_row; /* actual number of rows */
long returnCode; /* return error code */
char returnMsg[1024]; /* error message text */
short collectionName_ind;
short rtab_ind;
short rcol_ind;
short vcol_ind;
short ovtype_ind;
short ov_ind;
short maxrow_ind;
short numrow_ind;
short returnCode_ind;
short returnMsg_ind;
EXEC SQL END DECLARE SECTION;

/* create table */
EXEC SQL CREATE TABLE xml_order_tab (xmlorder XMLVarchar);

/* initial host variable and indicators */
strcpy(collection, "sales_ord");
strcpy(result_tab, "xml_order_tab");
strcpy(result_col, "xmlorder");
valid_colname[0] = '\0';
sprintf(override, "%s %s",
 "/Order/Part Price > 50.00 AND ",
 "/Order/Part/Shipment/ShipDate > '1998-12-01'");
overrideType = XML_OVERRIDE;
max_row = 500;
num_row = 0;
returnCode = 0;
msg_txt[0] = '\0';
collectionName_ind = 0;
rtab_ind = 0;
rcol_ind = 0;
vcol_ind = -1;
ov_ind = 0;
ovtype_ind = 0;
maxrow_ind = 0;

```

```

numrow_ind = -1;
returnCode_ind = -1;
returnMsg_ind = -1;

/* Call the stored procedure */
EXEC SQL CALL "DB2XML.DXXRETRIEVEXML"
 (:collectionName:collectionName_ind,
 :result_tab:rtab_ind,
 :result_colname:rcol_ind,
 :valid_colname:vcol_ind,
 :overrideType:ovtype_ind,:override:ov_ind,
 :max_row:maxrow_ind,:num_row:numrow_ind,
 :returnCode:returnCode_ind,:returnMsg:returnMsg_ind);

if (SQLCODE < 0) {
 EXEC SQL ROLLBACK;
 else
 EXEC SQL COMMIT;
}

```

### Multiple Overrides

XML Extender supports multiple overrides on the same path. All overrides specified to the RDB node will be accepted.

You can specify multiple XML overrides on the same location path to refine set conditions in your search. In the following example, an XML document is composed from the two tables using the test.dad file.

*Table 48. Department Table*

Department Number	Department Name
10	Engineering
20	Operations
30	Marketing

*Table 49. Employee Table*

Employee Number	Department Number	Salary
123	10	\$98,000.00
456	10	\$87,000.00
111	20	\$65,000.00
222	20	\$71,000.00
333	20	\$66,000.00
500	30	\$55,000.00

The DAD file test.dad illustrated below contains a condition comparing the variable *deptno* with the value 10. To expand the search to greater than 10 and less than 30, you must override this condition. You must set the override parameter when calling dXXGenXML as follows:

```

/ABC.com/Department>10 AND /ABC.com/Department<30

<?xml version="1.0"?>
<!DOCTYPE DAD SYSTEM "C:\dxx_xml\test\dtd\dad.dtd">
<DAD>
<dtdid>E:\dtd\lineItem.dtd</dtdid>
<validation>NO</validation>

```

```

<Xcollection>
<prolog>?xml version="1.0"?</prolog>
<doctype!DOCTYPE Order SYSTEM "C:\dxx_xml\test\dtd\LineItem.dtd"</doctype>
<root_node>
<element_node name="ABC.com">
<TDB_node>
<table name="dept" key="deptno"/>
<table name="empl" key="emplno"/>
<condition>dept deptno=empl.deptno</condition>
</RDB_node>

<element_node name="Department" multi_occurrence="YES">
<text_node>
<RDB_node>
<table name="dept"/>
<column name="deptno">
<condition>deptno=10</condition><RDB_node></RDB_node><text_node></text_node>
<element_node name="Employees" multi_occurrence="YES">

<text_node>

<RDB_node>

<table name="dept"><column name="deptnot"><condition>deptno=10</condition>
</table></RDB_node></text_node>
<element_node name="Employees" multi_occurrence="YES">

<element_node name="EmployeeNo">

<text_node>

<RDB_node>

<table name="empl"><column name="emplno"><condition>emplno<500</condition>
</table></RDB_node></text_node></element_node>
<element_node name="Salary">

<text_node>

<RDB_node>

<table name="empl"><column name="salary"><condition>salary>5000.00</condition>
</table></RDB_node></text_node></element_node></element_node></element_node>

```

To compose an XML document without an override, enter tests2x mydb test.dad result\_tab or you can invoke dxxGenXML without setting an override. This will generate a document similar to this:

```

<?xml version="1.0">
<!DOCTYPE Order SYSTEM "C:\dxx_xml\test\dtd\LineItem.dtd">
<ABC.com>
<Department>10
<Employees>
<EmployeeNo>123</EmployeeNo>
<Salary>98,000.00</Salary>
</Employees>
<Employees>
<EmployeeNo>456</EmployeeNo>
<Salary>87,000.00</Salary>
</Employees>
</Department>
</ABC.COM>

```

To override the DAD file you can invoke dxxGenXML as mentioned above, or you can run the test2x program with the specified conditions:

```
tests2x mydb test.dad result_tab -o 2 "/ABC.com/Department>10 AND
/ABC.com/Department<30"
```

```
<?xml version="1.0">
<!DOCTYPE Order SYSTEM "C:\dxx_xml\test\dtd\LineItem.dtd">
<ABC.com>
<Department>20
<Employees>
<EmployeeNo>111</EmployeeNo>
<Salary>65,000.00</Salary>
</Employees>
<EmployeeNo>222</EmployeeNo>
<Salary>71,000.00</Salary>
</Employees>
<Employees>
<EmployeeNo>333</EmployeeNo>
<Salary>66,000.00</Salary>
</Employees>
</Department>
</ABC.com>
```

**Related concepts:**

- “DAD files for XML collections” on page 161

**Related tasks:**

- “Creating a DAD file for XML columns” on page 159

**Related reference:**

- “DTD for the DAD file” on page 164



---

## Chapter 10. XML Extender stored procedures

---

### XML Extender stored procedures - Overview

The XML Extender provides stored procedures (also called *procedures*) for administration and management of XML columns and collections. These stored procedures can be called from the DB2 client. The client interface can be embedded in SQL, ODBC, or JDBC. See the section on stored procedures in the *DB2 UDB for iSeries SQL Programming* for details about how to call stored procedures.

The stored procedures use the schema DB2XML, which is the schema name of the XML Extender.

The XML Extender provides three types of stored procedures:

**Administration stored procedures**

assist users in completing administrative tasks

**Composition stored procedures**

generate XML documents using data in existing database tables

**Decomposition stored procedures**

break down or shred incoming XML documents and store data in new or existing database tables

Before calling stored procedures, you must follow the set up procedures for all environments. Sample programs that call stored procedures are located in DXXSAMPLES/QCSRC.

Ensure that you include the XML Extender external header files in the program that calls stored procedures. The header files are located in the /qibm/ProdData/DB2Extenders/XML/include directory. The header files are:

**dxx.h**            The XML Extender defined constant and data types

**dxxrc.h**         The XML Extender return code

The syntax for including these header files is:

```
#include "dxx.h"
#include "dxxrc.h"
```

Make sure that the path of the include files is specified in your makefile with the compilation option.

---

### Calling XML Extender stored procedures

You can use XML Extender in different operating systems from a single client application, by writing the stored procedure names in both uppercase and lowercase. To call the stored procedures in this way, use the `result_colname` and `valid_colname` versions of the composition stored procedures. Using this method gives you the following benefits:

- You can use these stored procedures in all DB2 Universal Database environments because you can include many columns in the result table. The

versions of the stored procedures that do not support `result_colname` and `valid_colname` require exactly one column in the result table.

- You can use a declared temporary table as your result table. Your temporary table is identified by a schema that is set to "session". Declared temporary tables enable you to support multi-user client environments.

Use uppercase when you call the DB2 XML Extender stored procedures to access the stored procedures consistently across platforms.

**Procedure:**

Call XML Extender using the following syntax:

```
CALL DB2XML.function_entry_point
```

Where:

*function\_entry\_point*

Specifies the name of the function.

In the CALL statement, the arguments that are passed to the stored procedure must be host variables, not constants or expressions. The host variables can have null indicators.

See samples for calling stored procedures in the DXXSAMPLES/QCSRC source file, In the DXXSAMPLES/QCSRC source directory, SQX code files are provided to call XML collection stored procedures using embedded SQL.

---

## XML Extender administration stored procedures

### XML Extender administration stored procedures - Overview

These stored procedures are used for administration tasks, such as enabling or disabling an XML column or collection. They are called by the XML Extender administration wizard and the administration command **dxxadm**.

- `dxxEnableDB()`
- `dxxDisableDB()`
- `dxxEnableColumn()`
- `dxxDisableColumn()`
- `dxxEnableCollection()`
- `dxxDisableCollection()`

### **dxxEnableDB()** stored procedure

**Purpose:**

Enables the database. When the database is enabled, the XML Extender creates the following objects:

- The XML Extender user-defined types (UDTs).
- The XML Extender user-defined functions (UDFs).
- The XML Extender DTD repository table, `DTD_REF`, which stores DTDs and information about each DTD.



- The XML Extender usage table, XML\_USAGE, which stores common information for each column and collection that is enabled for XML Extender.

**Syntax:**

```
DB2XML.dxxEnableDB(char(dbName) dbName, /* input */
 long returnCode, /* output */
 varchar(1024) returnMsg) /* output */
```

**Parameters:**

*Table 50. dxxEnableDB() parameters*

Parameter	Description	IN/OUT parameter
<i>dbName</i>	The database name.	IN
<i>returnCode</i>	The return code from the stored procedure.	OUT
<i>returnMsg</i>	The message text that is returned in case of error.	OUT

**Related concepts:**

- “XML Extender administration stored procedures - Overview” on page 178
- Chapter 12, “XML Extender administration support tables,” on page 203

**Related tasks:**

- “Enabling a database for XML” on page 51
- “Calling XML Extender stored procedures” on page 177

**Related reference:**

- Appendix C, “XML Extender limits,” on page 239

## dxxDisableDB() stored procedure

**Purpose:**

Disables the database. When XML Extender disables the database, it drops the following objects:

- The XML Extender user-defined types (UDTs).
- The XML Extender user-defined functions (UDFs).
- The XML Extender DTD repository table, DTD\_REF, which stores DTDs and information about each DTD.
- The XML Extender usage table, XML\_USAGE, which stores common information for each column that is enabled for XML Extender and for each collection.

**Important:** You must disable all XML columns before attempting to disable a database. The XML Extender cannot disable a database that contains columns or collections that are enabled for XML Extender.

**Syntax:**

```
DB2XML.dxxDisableDB(char(dbName) dbName, /* input */
 long returnCode, /* output */
 varchar(1024) returnMsg) /* output */
```

**Parameters:***Table 51. dxxDisableDB() parameters*

Parameter	Description	IN/OUT parameter
<i>dbName</i>	The database name.	IN
<i>returnCode</i>	The return code from the stored procedure.	OUT
<i>returnMsg</i>	The message text that is returned in case of error.	OUT

**Related concepts:**

- “XML Extender administration stored procedures - Overview” on page 178
- Chapter 12, “XML Extender administration support tables,” on page 203

**Related tasks:**

- “Calling XML Extender stored procedures” on page 177

**Related reference:**

- Appendix C, “XML Extender limits,” on page 239

## dxxEnableColumn() stored procedure

**Purpose:**

Enables an XML column. When enabling a column, the XML Extender completes the following tasks:

- Determines whether the XML table has a primary key; if not, the XML Extender alters the XML table and adds a column called DXXROOT\_ID.
- Creates side tables that are specified in the DAD file with a column containing a unique identifier for each row in the XML table. This column is either the *root\_id* that is specified by the user, or it is the DXXROOT\_ID that was named by the XML Extender.
- Creates a default view for the XML table and its side tables, optionally using a name you specify.

**Syntax:**

```
DB2XML.dxxEnableColumn(char(dbName) dbName, /* input */
 char(tbName) tbName, /* input */
 char(colName) colName, /* input */
 CLOB(100K) DAD, /* input */
 char(defaultView) defaultView, /* input */
 char(rootID) rootID, /* input */
 long returnCode, /* output */
 varchar(1024) returnMsg) /* output */
```

**Parameters:***Table 52. dxxEnableColumn() parameters*

Parameter	Description	IN/OUT parameter
<i>dbName</i>	The database name.	IN
<i>tbName</i>	The name of the table containing the XML column.	IN

Table 52. *dxxEnableColumn()* parameters (continued)

Parameter	Description	IN/OUT parameter
<i>colName</i>	The name of the XML column.	IN
<i>DAD</i>	A CLOB containing the DAD file.	IN
<i>defaultView</i>	The name of the default view joining the application table and side tables.	IN
<i>rootID</i>	The name of the single primary key in the application table that is to be used as the root ID for the side table.	IN
<i>returnCode</i>	The return code from the stored procedure.	OUT
<i>returnMsg</i>	The message text that is returned in case of error.	OUT

**Related concepts:**

- “XML columns as a storage and access method” on page 73
- “XML Extender administration stored procedures - Overview” on page 178

**Related tasks:**

- “Calling XML Extender stored procedures” on page 177

**Related reference:**

- Appendix C, “XML Extender limits,” on page 239

## **dxxDisableColumn() stored procedure**

**Purpose:**

Disables the XML-enabled column.

**Syntax:**

```
DB2XML.dxxDisableColumn(char(dbName) dbName, /* input */
 char(tbName) tbName, /* input */
 char(colName) colName, /* input */
 long returnCode, /* output */
 varchar(1024) returnMsg) /* output */
```

**Parameters:**

Table 53. *dxxDisableColumn()* parameters

Parameter	Description	IN/OUT parameter
<i>dbName</i>	The database name.	IN
<i>tbName</i>	The name of the table containing the XML column.	IN
<i>colName</i>	The name of the XML column.	IN
<i>returnCode</i>	The return code from the stored procedure.	OUT
<i>returnMsg</i>	The message text that is returned in case of error.	OUT

**Related reference:**

- Appendix C, “XML Extender limits,” on page 239

## **dxxEnableCollection() stored procedure**

**Purpose:**

Enables an XML collection that is associated with an application table.

**Syntax:**

```
dxxEnableCollection(char(dbName) dbName, /* input */
 char(colName) colName, /* input */
 CLOB(100K) DAD, /* input */
 long returnCode, /* output */
 varchar(1024) returnMsg) /* output */
```

**Parameters:**

*Table 54. dxxEnableCollection() parameters*

Parameter	Description	IN/OUT parameter
<i>dbName</i>	The database name.	IN
<i>colName</i>	The name of the XML collection.	IN
<i>DAD</i>	A CLOB containing the DAD file.	IN
<i>returnCode</i>	The return code from the stored procedure.	OUT
<i>returnMsg</i>	The message text that is returned in case of error.	OUT

**Related concepts:**

- “XML collections as a storage and access method” on page 89
- “XML Extender administration stored procedures - Overview” on page 178

**Related tasks:**

- “Calling XML Extender stored procedures” on page 177

**Related reference:**

- Appendix C, “XML Extender limits,” on page 239

## **dxxDisableCollection() stored procedure**

**Purpose:**

Disables an XML-enabled collection, removing markers that identify tables and columns as part of a collection.

**Syntax:**

```
dxxDisableCollection(char(dbName) dbName, /* input */
 char(colName) colName, /* input */
 long returnCode, /* output */
 varchar(1024) returnMsg) /* output */
```

**Parameters:***Table 55. dxxDisableCollection() parameters*

Parameter	Description	IN/OUT parameter
<i>dbName</i>	The database name.	IN
<i>colName</i>	The name of the XML collection.	IN
<i>returnCode</i>	The return code from the stored procedure.	OUT
<i>returnMsg</i>	The message text that is returned in case of error.	OUT

**Related reference:**

- Appendix C, “XML Extender limits,” on page 239

---

## XML Extender composition stored procedures

### XML Extender composition stored procedures - Overview

The composition stored procedures `dxxGenXML()`, `dxxRetrieveXML()`, `dxxGenXMLCLOB()`, and `dxxRetrieveXMLCLOB()` are used to generate XML documents using data in existing database tables. The `dxxGenXML()` stored procedure takes a DAD file as input; it does not require an enabled XML collection. The `dxxRetrieveXML()` stored procedure takes an enabled XML collection name as input.

The following performance enhancements have been made for composition stored procedures, `dxxGenXMLClob` and `DXXRetrieveXMLClob`.

- On i5/OS™ and zSeries® operating systems, the length of the override parameter has been increased to 16 KB.
- The requirement for an intermediate result table has been removed.
- By using these stored procedures:
  - You reduce the instruction path length because there is no need to create result tables.
  - You simplify your programming.
- Use the stored procedures that require an intermediate result table if you want to produce more than one document.

### **dxxGenXML() stored procedure**

**Purpose:**

Constructs XML documents using data that is stored in the XML collection tables that are specified by the `<Xcollection>` in the DAD file and inserts each XML document as a row into the result table. You can also open a cursor on the result table and fetch the result set.

To provide flexibility, `dxxGenXML()` also lets the user specify the maximum number of rows to be generated in the result table. This decreases the amount of time the application must wait for the results during any trial process. The stored procedure returns the number of actual rows in the table and any error information, including error codes and error messages.

To support dynamic query, `dxxGenXML()` takes an input parameter, *override*. Based on the input *overrideType*, the application can override the `SQL_stmt` for SQL mapping or the conditions in `RDB_node` for `RDB_node` mapping in the DAD file. The input parameter *overrideType* is used to clarify the type of the *override*.

**Syntax:**

```
dxxGenXML(CLOB(100K) DAD, /* input */
 char(resultTabName) resultTabName, /* input */

 char(resultColumn) result_column,
 char(validColumn) valid_column,
 integer overrideType /* input */
 varchar(varchar_value) override,

 integer maxRows, /* input */
 integer numRows, /* output */
 long returnCode, /* output */
 varchar(1024) returnMsg) /* output */
```

Where the `varchar_value` is 32672 for Windows and UNIX, and 16366 for i5/OS and z/OS.

**Parameters:**

Table 56. *dxxGenXML()* parameters

Parameter	Description	IN/OUT parameter
<i>DAD</i>	A CLOB containing the DAD file.	IN
<i>resultTabName</i>	The name of the result table, which should exist before the call. The table contains only one column of either XMLVARCHAR or XMLCLOB type.	IN
<i>result_column</i>	The name of the column in the result table in which the composed XML documents are stored.	IN
<i>valid_column</i>	The name of the column that indicates whether the XML document is valid when it is validated against a document type definition (DTD).	IN
<i>overrideType</i>	A flag to indicate the type of the following <i>override</i> parameter: <ul style="list-style-type: none"> <li><b>NO_OVERRIDE</b>: No override.</li> <li><b>SQL_OVERRIDE</b>: Override by an <code>SQL_stmt</code>.</li> <li><b>XML_OVERRIDE</b>: Override by an XPath-based condition.</li> </ul>	IN

Table 56. *dxxGenXML()* parameters (continued)

Parameter	Description	IN/OUT parameter
<i>override</i>	<p>Overrides the condition in the DAD file. The input value is based on the <i>overrideType</i>.</p> <ul style="list-style-type: none"> <li>• <b>NO_OVERRIDE</b>: A NULL string.</li> <li>• <b>SQL_OVERRIDE</b>: A valid SQL statement. Using this <i>overrideType</i> requires that SQL mapping is used in the DAD file. The input SQL statement overrides the <i>SQL_stmt</i> in the DAD file.</li> <li>• <b>XML_OVERRIDE</b>: A string that contains one or more expressions that are separated by the word AND. Using this <i>overrideType</i> requires that <i>RDB_node</i> mapping is used in the DAD file.</li> </ul>	IN
<i>maxRows</i>	The maximum number of rows in the result table.	IN
<i>numRows</i>	The actual number generated rows in the result table.	OUT
<i>returnCode</i>	The return code from the stored procedure.	OUT
<i>returnMsg</i>	The message text that is returned in case of error.	OUT

**Examples:**

The following example fragment assumes that a result table is created with the name of XML\_ORDER\_TAB, and that the table has one column of XMLVARCHAR type. A complete, working sample is located in DXXSAMPLES/QCSRC (GENX).

```
#include "dxx.h"
#include "dxxrc.h"

EXEC SQL INCLUDE SQLCA;
EXEC SQL BEGIN DECLARE SECTION;
SQL TYPE is CLOB(100K) dad; /* DAD */

char result_tab[32]; /* name of the result table */
char result_colname[32]; /* name of the result column */
char valid_colname[32]; /* name of the valid column, will set to NULL */
char override[2]; /* override, will set to NULL*/
short overrideType; /* defined in dxx.h */
short max_row; /* maximum number of rows */
short num_row; /* actual number of rows */
long returnCode; /* return error code */
char returnMsg[1024]; /* error message text */
short dad_ind;
short rtab_ind;
short rcol_ind;
short vcol_ind;
short ovtype_ind;
short ov_ind;
short maxrow_ind;
short numrow_ind;
short returnCode_ind;
short returnMsg_ind;
EXEC SQL END DECLARE SECTION;

FILE *file_handle;
```

```

long file_length=0;

/* create table */
EXEC SQL CREATE TABLE xml_order_tab (xmlorder XMLVarchar);

/* initialize the DAD CLOB object. */
file_handle = fopen("/dxx/dad/getstart_xcollection.dad", "r");
if (file_handle != NULL) { file_length = fread ((void *) &dad.data
, 1, FILE_SIZE, file_handle);
 if (file_length == 0) {
 printf("Error reading dad file
/dxx/dad/getstart_xcollection.dad\n");
 rc = -1;
 goto exit;
 } else
 dad.length = file_length;
}
else {
 printf("Error opening dad file \n",);
 rc = -1;
 goto exit;
}
/* initialize host variable and indicators */
strcpy(result_tab,"xml_order_tab");
strcpy(result_colname, "xmlorder")
valid_colname = '\0';
override[0] = '\0';
overrideType = NO_OVERRIDE;
max_row = 500;
num_row = 0;
returnCode = 0;
msg_txt[0] = '\0';
dad_ind = 0;
rtab_ind = 0;
rcol_ind = 0;
vcol_ind = -1;
ov_ind = -1;
ovtype_ind = 0;
maxrow_ind = 0;
numrow_ind = -1;
returnCode_ind = -1;
returnMsg_ind = -1;

/* Call the stored procedure */
EXEC SQL CALL "DB2XML.DXXGENXML" (:dad:dad_ind,
 :result_tab:rtab_ind,
 :result_colname:rcol_ind,
 :valid_colname:vcol_ind,
 :overrideType:ovtype_ind,:override:ov_ind,
 :max_row:maxrow_ind,:num_row:numrow_ind,
 :returnCode:returnCode_ind,
 :returnMsg:returnMsg_ind);

if (SQLCODE < 0) {
 EXEC SQL ROLLBACK;
 else
 EXEC SQL COMMIT;
}

exit:
 return rc;

```

#### Related concepts:

- “XML Extender composition stored procedures - Overview” on page 183

#### Related tasks:



- “Composing XML documents by using SQL mapping” on page 59
- “Composing XML collections by using RDB\_node mapping” on page 62
- “Calling XML Extender stored procedures” on page 177

## dxxRetrieveXML() stored procedure

### Purpose:

The stored procedure dxxRetrieveXML() serves as a means for retrieving decomposed XML documents. As input, dxxRetrieveXML() takes a name of an enabled XML collection, the name of the created result table, and the maximum number of rows to be returned. It returns a result set of the result table, the actual number of rows in the result set, an error code, and message text.

To support dynamic query, dxxRetrieveXML() takes an input parameter, *override*. Based on the input *overrideType*, the application can override the SQL\_stmt for SQL mapping or the conditions in RDB\_node for RDB\_node mapping in the DAD file. The input parameter *overrideType* is used to clarify the type of the *override*.

The requirements of the DAD file for dxxRetrieveXML() are the same as the requirements for dxxGenXML(). The only difference is that the DAD is not an input parameter for dxxRetrieveXML(), but it is the name of an enabled XML collection.

### Syntax:

```
dxxRetrieveXML(char(collectionName) collectionName, /* input */
 char(resultTabName) resultTabName, /* input */
 char(resultColumn) result_column,
 char(validColumn) valid_column,
 integer overrideType, /* input */
 varchar(varchar_value) override,
 integer maxRows, /* input */
 integer numRows, /* output */
 long returnCode, /* output */
 varchar(1024) returnMsg) /* output */
```

Where *varchar\_value* is 32672 for Windows and UNIX and 16366 for iSeries and z/OS.

### Parameters:

Table 57. dxxRetrieveXML() parameters

Parameter	Description	IN/OUT parameter
<i>collectionName</i>	The name of an enabled XML collection.	IN
<i>resultTabName</i>	The name of the result table, which should exist before the call. The table contains only one column of either XMLVARCHAR or XMLCLOB type.	IN
<i>result_column</i>	The name of the column in the result table in which the composed XML documents are stored.	IN

Table 57. *dxxRetrieveXML()* parameters (continued)

Parameter	Description	IN/OUT parameter
<i>valid_column</i>	The name of the column that indicates whether the XML document is valid when it is validated against a document type definition (DTD).	IN
<i>overrideType</i>	A flag to indicate the type of the following <i>override</i> parameter: <ul style="list-style-type: none"> <li>• <b>NO_OVERRIDE</b>: No override.</li> <li>• <b>SQL_OVERRIDE</b>: Override by an SQL_stmt.</li> <li>• <b>XML_OVERRIDE</b>: Override by an XPath-based condition.</li> </ul>	IN
<i>override</i>	Overrides the condition in the DAD file. The input value is based on the <i>overrideType</i> . <ul style="list-style-type: none"> <li>• <b>NO_OVERRIDE</b>: A NULL string.</li> <li>• <b>SQL_OVERRIDE</b>: A valid SQL statement. Using this <i>overrideType</i> requires that SQL mapping is used in the DAD file. The input SQL statement overrides the SQL_stmt in the DAD file.</li> <li>• <b>XML_OVERRIDE</b>: A string that contains one or more expressions separated by the word AND. Using this <i>overrideType</i> requires that RDB_node mapping is used in the DAD file.</li> </ul>	IN
<i>maxRows</i>	The maximum number of rows in the result table.	IN
<i>numRows</i>	The actual number of generated rows in the result table.	OUT
<i>returnCode</i>	The return code from the stored procedure.	OUT
<i>returnMsg</i>	The message text that is returned in case of error.	OUT

**Examples:**

The following fragment is an example of a call to *dxxRetrieveXML()*. In this example, a result table is created with the name of XML\_ORDER\_TAB, and it has one column of XMLVARCHAR type. A complete, working sample is located in /dxxsamples/QCSRC (RTRX).

```
#include "dxx.h"
#include "dxxrc.h"

EXEC SQL INCLUDE SQLCA;
EXEC SQL BEGIN DECLARE SECTION;
char collectionName[32]; /* name of an XML collection */
char result_tab[32]; /* name of the result table */
char result_colname[32]; /* name of the result column */
char valid_colname[32]; /* name of the valid column, will set to NULL*/
char override[2]; /* override, will set to NULL*/
short overrideType; /* defined in dxx.h */
```

```

short max_row; /* maximum number of rows */
short num_row; /* actual number of rows */
long returnCode; /* return error code */
char returnMsg[1024]; /* error message text */
short collectionName_ind;
short rtab_ind;
short rcol_ind;
short vcol_ind;
short ovtype_ind;
short ov_ind;
short maxrow_ind;
short numrow_ind;
short returnCode_ind;
short returnMsg_ind;
EXEC SQL END DECLARE SECTION;

/* create table */
EXEC SQL CREATE TABLE xml_order_tab (xmlorder XMLVarchar);

/* initial host variable and indicators */
strcpy(collection, "sales_ord");
strcpy(result_tab, "xml_order_tab");
strcpy(result_col, "xmlorder");
valid_colname[0] = '\0';
override[0] = '\0';
overrideType = NO_OVERRIDE;
max_row = 500;
num_row = 0;
returnCode = 0;
msg_txt[0] = '\0';
collectionName_ind = 0;
rtab_ind = 0;
rcol_ind = 0;
vcol_ind = -1;
ov_ind = -1;
ovtype_ind = 0;
maxrow_ind = 0;
numrow_ind = -1;
returnCode_ind = -1;
returnMsg_ind = -1;

/* Call the stored procedure */
EXEC SQL CALL "db2xml.dxxRetrieveXML"
 (:collectionName:collectionName_ind,
 :result_tab:rtab_ind,
 :result_colname:rcol_ind,
 :valid_colname:vcol_ind,
 :overrideType:ovtype_ind,:override:ov_ind,
 :max_row:maxrow_ind,:num_row:numrow_ind,
 :returnCode:returnCode_ind,:returnMsg:returnMsg_ind);

if (SQLCODE < 0) {
 EXEC SQL ROLLBACK;
 else
 EXEC SQL COMMIT;
}

```

#### Related concepts:

- “XML Extender composition stored procedures - Overview” on page 183

#### Related tasks:

- “Composing XML documents by using SQL mapping” on page 59
- “Composing XML collections by using RDB\_node mapping” on page 62
- “Calling XML Extender stored procedures” on page 177

**Related reference:**

- Appendix C, “XML Extender limits,” on page 239

## **dxxGenXMLClob stored procedure**

**Purpose:**

As input, `dxxGenXMLClob` takes a buffer containing the DAD. It constructs XML documents using data that is stored in the XML collection tables that are specified by the `<Xcollection>` in the DAD and returns the first and typically the only XML document generated into the `resultDoc` CLOB.

**Syntax:**

```
dxxGenXMLClob(CLOB(100k) DAD /*input*/
 integer overrideType, /*input*/
 varchar(varchar_value) override, /*input*/
 CLOB(1M) resultDoc, /*output*/
 integer valid, /*output*/
 integer numDocs, /*output*/
 long returnCode, /*output*/
 varchar(1024) returnMsg) /*output*/
```

Where `varchar_value` is 32672 for Windows and UNIX and 16366 for i5/OS and z/OS.

**Parameters:**

Table 58. `dxxGenXMLClob` parameters

Parameter	Description	IN/OUT parameter
<code>DAD</code>	A CLOB containing the DAD file.	IN
<code>overrideType</code>	A flag to indicate the type of <code>override</code> parameter:  <b>NO_OVERRIDE</b> No override.  <b>SQL_OVERRIDE</b> Override by an <code>SQL_stmt</code>  <b>XML_OVERRIDE</b> Override by an XPath-based condition.	IN

Table 58. *dxxGenXMLClob* parameters (continued)

Parameter	Description	IN/OUT parameter
<i>override</i>	<p>Overrides the condition in the DAD file. The input value is based on the <i>overrideType</i>.</p> <p><b>NO_OVERRIDE</b> A NULL string.</p> <p><b>SQL_OVERRIDE</b> A valid SQL statement. Using this <i>overrideType</i> requires that SQL mapping be used in the DAD file. The input SQL statement overrides the <i>SQL_stmt</i> in the DAD file.</p> <p><b>XML_OVERRIDE</b> A string that contains one or more expressions separated by the word AND. Using this <i>overrideType</i> requires that <i>RDB_node</i> mapping be used in the DAD file</p>	IN
<i>resultDoc</i>	A CLOB that contains the composed XML document.	OUT
<i>valid</i>	<p>valid is set as follows:</p> <ul style="list-style-type: none"> <li>• If VALIDATION=YES then valid=1 for successful validation or valid=0 for unsuccessful validation.</li> <li>• If VALIDATION=NO then valid=NULL.</li> </ul>	OUT
<i>numDocs</i>	<p>The number of XML documents that would be generated from the input data.</p> <p><b>Note:</b> Currently only the first document is returned.</p>	OUT
<i>returnCode</i>	The return code from the stored procedure.	OUT
<i>returnMsg</i>	The message text that is returned in case of error.	OUT

The CLOB parameter size is 1 MB. If you have CLOB files that are larger than 1 MB, XML Extender provides a command file to redefine the stored procedure parameter. Download the *crtgenxc.zip* file from the DB2 UDB XML Extender Web site. This ZIP file contains the following programs:

#### **crtgenxc.db2**

For use on XML Extender V7.2 FixPak 5 and later for UNIX and Windows.

### **crtgenxc.iseries**

For use with XML Extender for iSeries

### **crtgenxc.zos.jcl and crtgenxc.zos.cmd**

For use with XML Extender for OS/390 V7, APAR PQ58249 and later.

For i5/OS, place the file as a member into a file. (For example, put the file into DXXSAMPLES/SQLSTMT).

**To specify the CLOB length:** Open the file in an editor and modify the *resultDoc* parameter, shown in the following example.

```
out resultDoc clob(clob_size),
```

**Size recommendation:** The size limit of the *resultDoc* parameter depends on your system setup, but be aware that the amount specified in this parameter is the amount allocated by JDBC, regardless of the size of the document. The size should accommodate your largest XML files, but should not exceed 1.5 gigabytes.

To run the command file on i5/OS, from the command line, enter:

```
RUNSQLSTM SRCFILE(DXXSAMPLES/SQLSTMT) SRCMBR(CRTGENXC) NAMING(*SQL)
```

Where *DXXSAMPLES/SQLSTMT* matches the Library and File names into which you downloaded the file.

### **Related concepts:**

- “XML Extender composition stored procedures - Overview” on page 183

### **Related tasks:**

- “Composing XML documents by using SQL mapping” on page 59
- “Composing XML collections by using RDB\_node mapping” on page 62
- “Calling XML Extender stored procedures” on page 177

### **Related reference:**

- Appendix C, “XML Extender limits,” on page 239

## **dxxRetrieveXMLClob stored procedure**

### **Purpose:**

The *dxxRetrieveXMLClob* stored procedure enables document composition from relational data.

The requirements for using *dxxRetrieveXMLClob* are the same as the requirements for *dxxGenXMLClob*. The only difference is that the DAD is not an input parameter for *dxxRetrieveXMLClob*, but it is the name of an enabled XML collection.

### **Syntax:**

```
dxxRetrieveXMLClob(char(collectionName) collectionName /*input*/
 integer overrideType, /*input*/
 varchar(varchar_value) override, /*input*/
 CLOB(1M) resultDoc, /*output*/
 integer valid, /*output*/
 integer numDocs, /*output*/
 long returnCode, /*output*/
 varchar(1024) returnMsg) /*output*/
```

**Parameters:**

Table 59. *dxxRetrieveXMLClob* parameters

Parameter	Description	IN/OUT parameter
<i>collectionName</i>	The name of an enabled XML collection.	IN
<i>overrideType</i>	A flag to indicate the type of <i>override</i> parameter:  <b>NO_OVERRIDE</b> No override.  <b>SQL_OVERRIDE</b> Override by an SQL_stmt  <b>XML_OVERRIDE</b> Override by an XPath-based condition.	IN
<i>override</i>	Overrides the condition in the DAD file. The input value is based on the <i>overrideType</i> .  <b>NO_OVERRIDE</b> A NULL string.  <b>SQL_OVERRIDE</b> A valid SQL statement. Using this <i>overrideType</i> requires that SQL mapping be used in the DAD file. The input SQL statement overrides the SQL_stmt in the DAD file.  <b>XML_OVERRIDE</b> A string that contains one or more expressions separated by the word AND. Using this <i>overrideType</i> requires that RDB_node mapping be used in the DAD file	IN
<i>resultDoc</i>	A CLOB that contains the composed XML document.	IN
<i>valid</i>	valid is set as follows: <ul style="list-style-type: none"> <li>• If VALIDATION=YES then valid=1 for successful validation or valid=0 for unsuccessful validation.</li> <li>• If VALIDATION=NO then valid=NULL.</li> </ul>	OUT
<i>numDocs</i>	The number of XML documents that would be generated from the input data. NOTE: currently only the first document is returned.	OUT
<i>returnCode</i>	The return code from the stored procedure.	OUT
<i>returnMsg</i>	The message text that is returned in case of error.	OUT

The CLOB parameter size is 1 MB. If you have CLOB files that are larger than 1 MB, XML Extender provides a command file to redefine the stored procedure

parameter. Download the `crtgenxc.zip` file from the DB2 UDB XML Extender Web site. This ZIP file contains the following programs:

**crtgenxc.db2**

For use on XML Extender V7.2 Fixpak 5 and later for UNIX and Windows.

**crtgenxc.iseries**

For use with XML Extender for iSeries

**crtgenxc.zos.jcl and crtgenxc.zos.cmd**

For use with XML Extender for OS/390 V7, APAR PQ58249 and later.

For i5/OS, place the file as a member into a file. (For example, put the file into `DXXSAMPLES/SQLSTMT`).

**To specify the CLOB length:** Open the file in an editor and modify the `resultDoc` parameter, shown in the following example.

```
out resultDoc clob(clob_size),
```

**Size recommendation:** The size limit of the `resultDoc` parameter depends on your system setup, but be aware that the amount specified in this parameter is the amount allocated by JDBC, regardless of the size of the document. The size should accommodate your largest XML files, but should not exceed 1.5 gigabytes.

To run the command file on i5/OS, from the command line, enter:

```
RUNSQLSTM SRCFILE(DXXSAMPLES/SQLSTMT) SRCMBR(CRTGENXC) NAMING(*SQL)
```

Where `DXXSAMPLES/SQLSTMT` matches the Library and File names into which you downloaded the file.

**Related concepts:**

- “XML Extender composition stored procedures - Overview” on page 183

**Related tasks:**

- “Composing XML documents by using SQL mapping” on page 59
- “Composing XML collections by using RDB\_node mapping” on page 62
- “Calling XML Extender stored procedures” on page 177

**Related reference:**

- Appendix C, “XML Extender limits,” on page 239

---

## XML Extender decomposition stored procedures

### XML Extender decomposition stored procedures - Overview

The decomposition stored procedures `dxxInsertXML()` and `dxxShredXML()` are used to break down or shred incoming XML documents and to store data in new or existing database tables. The `dxxInsertXML()` stored procedure takes an enabled XML collection name as input. The `dxxShredXML()` stored procedure takes a DAD file as input; it does not require an enabled XML collection.

### **dxxShredXML() stored procedure**

**Purpose:**



Decomposes XML documents, based on a DAD file mapping, storing the content of the XML elements and attributes in specified DB2 UDB tables. In order for `dxxShredXML()` to work, all tables specified in the DAD file must exist, and all columns and their data types that are specified in the DAD must be consistent with the existing tables. The stored procedure requires that the columns specified in the join condition, in the DAD, correspond to primary- foreign key relationships in the existing tables. The join condition columns that are specified in the `RDB_node` of the root `element_node` must exist in the tables.

The stored procedure fragment in this section is a sample for explanation purposes. A complete, working sample is located in `DXXSAMPLES/QCSRC(SHDX)`.

**Syntax:**

```
dxxShredXML(CLOB(100K) DAD, /* input */
 CLOB(1M) xmlobj, /* input */
 long returnCode, /* output */
 varchar(1024) returnMsg) /* output */
```

**Parameters:**

*Table 60. dxxShredXML() parameters*

Parameter	Description	IN/OUT parameter
<i>DAD</i>	A CLOB containing the DAD file.	IN
<i>xmlobj</i>	An XML document object in XMLCLOB type.	IN
<i>returnCode</i>	The return code from the stored procedure.	OUT
<i>returnMsg</i>	The message text that is returned in case of error.	OUT

**Examples:**

The following fragment is an example of a call to `dxxShredXML()`. A complete, working sample is located in `DXXSAMPLES/QCSRC(SHDX)`.

```
#include "dxx.h"
#include "dxxrc.h"

EXEC SQL INCLUDE SQLCA;
EXEC SQL BEGIN DECLARE SECTION;
SQL TYPE is CLOB(100K) dad; /* DAD */

SQL TYPE is CLOB(100K) xmlDoc; /* input xml document */

long returnCode; /* return error code */
char returnMsg[1024]; /* error message text */
short dad_ind;
short xmlDoc_ind;
short returnCode_ind;
short returnMsg_ind;
EXEC SQL END DECLARE SECTION;

FILE *file_handle;
long file_length=0;

/* initialize the DAD CLOB object. */
file_handle = fopen("/dxxsamples/dad/getstart_xcollection.dad", "r");
if (file_handle != NULL) {
```

```

 file_length = fread ((void *) &dad.data
, 1, FILE_SIZE, file_handle);
 if (file_length == 0) {
 printf ("Error reading dad file getstart_xcollection.dad\n");
 rc = -1;
 goto exit;
 } else
 dad.length = file_length;
}
else {
 printf("Error opening dad file \n");
 rc = -1;
 goto exit;
}

/* Initialize the XML CLOB object. */
file_handle = fopen("/dxxsamples/xml/getstart_xcollection.xml", "r");
if (file_handle != NULL) {
 file_length = fread ((void *) &xmlDoc.data
, 1, FILE_SIZE,
 file_handle);
 if (file_length == 0) {
 printf ("Error reading xml file getstart_xcollection.xml \n");
 rc = -1;
 goto exit;
 } else
 xmlDoc.length = file_length;
}
else {
 printf("Error opening xml file \n");
 rc = -1;
 goto exit;
}

/* initialize host variable and indicators */
returnCode = 0;
msg_txt[0] = '\0';
dad_ind = 0;
xmlDoc_ind = 0;
returnCode_ind = -1;
returnMsg_ind = -1;

/* Call the stored procedure */
EXEC SQL CALL "DB2XML.DXXSHREDXML" (:dad:dad_ind;
 :xmlDoc:xmlDoc_ind,
 :returnCode:returnCode_ind,
 :returnMsg:returnMsg_ind);

if (SQLCODE < 0) {
 EXEC SQL ROLLBACK;
}
else
 EXEC SQL COMMIT;
}

exit:
 return rc;

```

**Related concepts:**

- “XML Extender decomposition stored procedures - Overview” on page 194

**Related tasks:**

- “Decomposing an XML collection by using RDB\_node mapping” on page 66
- “Decomposing XML documents into DB2 UDB data” on page 94
- “Calling XML Extender stored procedures” on page 177

**Related reference:**

- Appendix C, "XML Extender limits," on page 239

## **dxxInsertXML() stored procedure**

**Purpose:**

Takes two input parameters, the name of an enabled XML collection and the XML document that are to be decomposed, and returns two output parameters, a return code and a return message.

**Syntax:**

```
dxxInsertXML(char(collectionName) collectionName, /*input*/
 CLOB(1M) xmlobj, /* input */
 long returnCode, /* output */
 varchar(1024) returnMsg) /* output */
```

**Parameters:**

*Table 61. dxxInsertXML() parameters*

Parameter	Description	IN/OUT parameter
<i>collectionName</i>	The name of an enabled XML collection.	IN
<i>xmlobj</i>	An XML document object in CLOB type.	IN
<i>returnCode</i>	The return code from the stored procedure.	OUT
<i>returnMsg</i>	The message text that is returned in case of error.	OUT

**Examples:**

In the following fragment example, the `dxxInsertXML()` call decomposes the input XML document `dxx_install/xml/order1.xml` and inserts data into the `SALES_ORDER` collection tables according to the mapping that is specified in the DAD file with which it was enabled with. A complete, working sample is located in `DXXSAMPLES/QCSRC(INSX)`.

```
#include "dxx.h"
#include "dxxrc.h"

EXEC SQL INCLUDE SQLCA;
EXEC SQL BEGIN DECLARE SECTION;
char collectionName[32]; /* name of an XML collection */
SQL TYPE is CLOB(100K) xmlDoc; /* input xml document */
long returnCode; /* return error code */
char returnMsg[1024]; /* error message text */
short collectionName_ind;
short xmlDoc_ind;
short returnCode_ind;
short returnMsg_ind;
EXEC SQL END DECLARE SECTION;

FILE *file_handle;
long file_length=0;

/* initialize the DAD CLOB object. */
file_handle = fopen("/dxxsamples/dad/getstart_xcollection.dad", "r");
```

```

if (file_handle != NULL) {
 file_length = fread ((void *) , &dad.data;
1, FILE_SIZE, file_handle);
 if (file_length == 0) {
 printf ("Error reading dad file getstart_xcollection.dad\n");
 rc = -1;
 goto exit;
 } else
 dad.length = file_length;
}
else {
 printf("Error opening dad file \n");
 rc = -1;
 goto exit;
}

/* initialize host variable and indicators */
strcpy(collectionName, "sales_ord");
returnCode = 0;
msg_txt[0] = '\0';
collectionName_ind = 0;
xmlDoc_ind = 0;
returnCode_ind = -1;
returnMsg_ind = -1;

/* Call the stored procedure */
EXEC SQL CALL "DB2XML.DXXINSERTXML" (:collection_name:collection_name_ind,
 :xmlDoc:xmlDoc_ind,
 :returnCode:returnCode_ind,
 :returnMsg:returnMsg_ind);

if (SQLCODE < 0) {
 EXEC SQL ROLLBACK;
 else
 EXEC SQL COMMIT;
}

exit:
 return rc;

```

**Related concepts:**

- “XML Extender decomposition stored procedures - Overview” on page 194

**Related tasks:**

- “Decomposing an XML collection by using RDB\_node mapping” on page 66
- “Decomposing XML documents into DB2 UDB data” on page 94
- “Calling XML Extender stored procedures” on page 177

**Related reference:**

- Appendix C, “XML Extender limits,” on page 239

---

## Chapter 11. Extensible stylesheet language transformation (XSLT)

---

### Creating an HTML document using an XSLT stylesheet

The Extensible stylesheet language transformation(XSLT) consists of a series of markups that can be used to apply formatting rules to each of the elements inside an XML document. XSL works by applying various style rules to the contents of an XML document based on the elements that it encounters. By design, XSLT stylesheets are regular XML documents.

Originally created for page layout, XSLT is now used in a variety of ways. For example, it can be used as a general-purpose translation tool, a system for reorganizing document content, or a way to generate multiple results such as HTML, WAP, and SVG from a single source.

XSLT is a critical bridge between XML processing and more familiar languages such as HTML.XSLT, and allows you to transform an XML structure into other data types by removing or replacing the XML tags. It also allows you to change the order of the information, extract some special information, or sort the information.

#### Prerequisites:

To create an HTML document using a stylesheet, you need to complete the following tasks:

1. Create an XML file in the result table.
2. Create a stylesheet.

You can create your HTML file by using XSLTransformToFile or XSLTransformToClob. This output file can be written either on the DB2 UDB server or from the command line in a text editor.

#### Procedure:

To create your HTML file on the DB2 UDB server, type the following syntax:

```
SELECT XSLTransformToFile(CAST(doc AS CLOB(4k)),
 '$dxx_install$\samples\db2xml\xslt\getstart.xml',
 0,
 '$dxx_install$\samples\db2xml\html\getstart.html')
FROM RESULT_TAB
```

where *\$dxx\_install\$* is the directory where you installed DB2 XML Extender.

#### Related reference:

- “Stylesheet sample: getstart.xml” on page 230
- “XSLTransformToClob() user-defined function” on page 200
- “XSLTransformToFile() user-defined function” on page 201

## XSLTransformToClob() user-defined function

### Purpose:

XSLTransformToClob() reads an XML document as CLOB locator and a stylesheet as CLOB or from a file, and returns the document as CLOB.

### Syntax:

```

>> XSLTransformToClob(—xmlobj—,—stylesheet—, —param—,—validate—)

```

### Parameters:

Parameter	Data type	Description
xmlobj	CLOB	The XML document
stylesheet	CLOB,	The style sheet
	VARCHAR	The location and name of the stylesheet input file
param	CLOB	The XML parameter document.
	VARCHAR	The location and name of the XML parameter fil.
validate	INTEGER	Enable (1) or disable (0) validation of the xmlobj

### Results:

The XSLTransformToClob() returns a data of CLOB type if successful.

### Examples:

The following example creates a sample table and stores two files in the getstart.xml and getstart.xml tables. To create the sample table, the DB2 UDB database must be enabled for XML Extender. Create a file named xslt\_param.xml containing the following lines:

```

<?xml version="1.0"?>
<params xmlns="http://www.ibm.com.XSLtransformParameters">
<param name="noShipments" value="true"/>
<param name="headline">The customers...</param>
</params>

```

```

CREATE TABLE xslt_tab(xmlobj CLOB(4k), stylesheet CLOB(4k), parameters CLOB(4k))
INSERT INTO xslt_tab(xmlobj, stylesheet)
VALUES(DB2XML.XMLCLOBFromFile(dxsamples\xml\getstart.xml),
DB2XML.XMLCLOBFromFile(dxsamples\xslt\getstart.xml))
DB2XML.XMLCLOBFromFile(xslt_param.xml))

```

**Example 1:** The following example transforms an XML document into a HTML document using the table created:

```

SELECT XSLTransformToClob(xmlobj, stylesheet, 0)
FROM xslt_tab

```

**Example 2:** This example transforms an XML document into an HTML document using a stylesheet file

```

SELECT XSLTransformToClob(xmlobj,
/dxxsamples/xslt/getstart.xml', 1)
FROM xslt_tab

```

**Example 3:** In this example the output is changed by additional parameters. The XML parameter document must define the namespace. The parameters must be wrapped in the `<param>` element. The corresponding value also can be specified in a *value* attribute, or in the content of the `<param>` element.

```
SELECT XSLTransformToClob(
 xmlobj,
 'dxxsamples\xslt\getstart.xml',
 parameters,
 1,
 'dxxsamples\html\getstart.html')
FROM xslt_tab
```

## XSLTransformToFile() user-defined function

### Purpose:

Reads an XML document as a CLOB and a style sheet as a CLOB or from a file. The XSLTransformToFile() user-defined function(UDF) then writes the results from the style sheet and XML document into a file. When a directory and a file extension are given as parameters, the UDF will create a file with a unique filename in this directory.

### Syntax:

```
►► XSLTransformToFile(—xmlobj—, —stylesheet—, —validate—, —
 , —param—
► filename—, —dir—, —suffix—)
```

### Parameters:

Table 62. XSLTransformDir() parameter descriptions

Parameter	Data type	Description
<i>xmlobj</i>	CLOB	The XML document
<i>stylesheet</i>	CLOB	The style sheet
	VARCHAR	The location and name of the stylesheet input file
<i>param</i>	VARCHAR	The XML parameter document
	VARCH	The location and name of the XML parameter file
<i>validate</i>	INTEGER	Enable (1) or disable (0) validation of the xmlobj
<i>filename</i>	VARCHAR	The name of the output file
<i>dir</i>	VARCHAR	The directory of the output file
<i>suffix</i>	VARCHAR	The suffix of the output file

### Results:

The XSLTransformToFile() returns a VARCHAR for the written file name.

### Examples:

The following example creates a sample table and stores two files in the

getstart.xml and getstart.xsl tables. To create the sample table, the DB2 UDB database must be enabled for XML Extender. Create file xslt\_param.xml containing the following lines:

```
<?xml version="1.0"?>
<params xmlns="http://www.ibm.com.XSLtransformParameters">
<param name="noShipments" value="true"/>
<param name="headline">The customers...</param>
</params>

CREATE TABLE xslt_tab(xmlobj CLOB(4k), stylesheet CLOB(4k), parameters CLOB(4k))

INSERT INTO xslt_tab(xmlobj, stylesheet) VALUES(
DB2XML.XMLCLOBFromFile('
 dxsamples\xml\getstart.xml'),
DB2XML.XMLCLOBFromFile('
 dxsamples\xslt\getstart.xsl'))
DB2XML.XMLCLOBFromFile('
 xslt_param.xml'))
```

**Example 1:** This example transforms the XML document into an HTML document and writes the created document to the specified file:

```
SELECT XSLTransformFile(xmlobj, stylesheet, 0
'/dxsamples/html/getstart.html')
FROM xslt_tab
```

**Example 2:** This example writes an HTML document to a file using a stylesheet file. Validation is enabled but the result is the same. This feature is necessary to include default values from an XML schema in the transformation process. No parameters are specified. The file name is generated by the UDF.

```
SELECT XSLTransformToFile(xmlobj,
'/dxsamples/xslt/getstart.xsl', 1
'/dxsamples/html/getstart.html')
FROM xslt_tab
```

**Example 3:** In this example the output is changed by additional parameters. The XML parameter document must define the namespace. The parameters must be wrapped in the *<param>* element. The corresponding value also can be specified in a *value* attribute, or in the content of the *<param>* element.

```
SELECT XSLTransformToFile(
 xmlobj,
 'dxsamples\xslt\getstart.xsl',
 parameters,
 1,
 'dxsamples/html/getstart.html')
FROM xslt_tab
```

**Example 4:** This example writes an HTML document into a file using a stylesheet file and stores the file name for each row in an additional column in the table.

```
UPDATE TABLE xslt_tab ADD COLUMN filename VARCHAR(512)
UPDATE TABLE xslt_tab SET filename =
XSLTransformToFile(xmlobj,stylesheet, param, 1,
'/dxsamples/html', 'html')
FROM xslt_tab
```



---

## Chapter 12. XML Extender administration support tables

When a database is enabled, a DTD repository table (DTD\_REF) and an XML\_USAGE table are created. The DTD\_REF table contains information about all of the DTDs. The XML\_USAGE table stores common information for each XML-enabled column. Each is created with specific PUBLIC privileges.

---

### DTD reference table

The XML Extender also serves as an XML DTD repository. When a database is XML-enabled, a DTD repository table, DTD\_REF, is created. Each row of this table represents a DTD with additional metadata information. You can access this table, and insert your own DTDs. The DTDs in the DTD\_REF table are used to validate XML documents and to help applications to define a DAD file. It has the schema name of DB2XML. A DTD\_REF table can have the columns shown in Table 63.

Table 63. DTD\_REF table

Column name	Data type	Description
DTDID	VARCHAR(128)	The primary key (unique and not NULL). It is used to identify the DTD. When the DTD is specified in the DAD file, the DAD file must adhere to the schema that is defined by the DTD.
CONTENT	XMLCLOB	The content of the DTD.
USAGE_COUNT	INTEGER	The number of XML columns and XML collections in the database that use the DTD to define their DAD files.
AUTHOR	VARCHAR(128)	The author of the DTD. This information is optional.
CREATOR	VARCHAR(128)	The user ID that does the first insertion. This column is optional.
UPDATOR	VARCHAR(128)	The user ID that does the last update. This column is optional.

A DTD can be modified by the application only when the USAGE\_COUNT is zero.

#### Privileges granted to PUBLIC

Privileges of INSERT, UPDATE, DELETE, and SELECT are granted for PUBLIC.

---

### XML usage table (XML\_USAGE)

The XML\_USAGE table stores common information for each XML-enabled column. The XML\_USAGE table's schema name is DB2XML, and its primary key is (*table\_name*, *col\_name*). Only read privileges of this table are granted to PUBLIC. An XML\_USAGE table is created at the time the database is enabled. The columns in the XML\_USAGE table are shown in Table 64 on page 204.

Table 64. XML\_USAGE table

Column name	Description
table_schema	For an XML column, the schema name of the user table that contains an XML column. For an XML collection, a value of DXX_COLL as the default schema name.
table_name	For an XML column, the name of the user table that contains an XML column. For an XML collection, a value DXX_COLLECTION, which identifies the entity as a collection.
col_name	The name of the XML column or XML collection. It is part of the composite key along with the table_name.
DTDID	A string associating a DTD inserted into DTD_REF with a DTD specified in a DAD file; this value must match the value of the DTDID element in the DAD. This column is a foreign key.
DAD	The content of the DAD file that is associated with the XML column or XML collection.
access_mode	Specifies which access mode is used: 1 for XML collection, 0 for XML column
default_view	Stores the default view name if there is one.
trigger_suffix	Not NULL. For unique trigger names.
validation	Has a value of 1 to validate, and 0 to skip validation.
version	The trigger version of the XML column.
root_id	The root ID of the XML column.
side_tab_qual	The side table qualifier.

Do not add, modify, or delete entries from the XML\_USAGE table; it is for XML Extender internal use only.

#### Privileges granted to PUBLIC

For XML\_USAGE, the privilege of SELECT is granted for PUBLIC. INSERT, DELETE, and UPDATE are granted to DB2XML.



**Parameters:**

Table 65. Trace parameters

Parameter	Description
<i>user_profile</i>	The name of the user profile associated with the job within which the XML Extender is running.
<i>trace_directory</i>	Name of an existing path and directory where the <i>dxxINSTANCE.trc</i> is placed. Required, no default.

**Examples:**

The following examples show starting the trace, with file, *dxxdb2inst1.trc*, in the */u/user1/dxx/trace* directory.

**From the Qshell:**

```
dxxttc on user1 /u/user1/trace
```

**From the iSeries Navigator:**

```
call myschema.QZXMTRC('on', 'user1', '/u/user1/trace');
```

**From the OS command line:**

```
call QDBXM/QZXMTRC PARM(on user1 '/u/user1/trace')
```

---

## Stopping the trace

**Purpose:**

Turns the trace off. Trace information is no longer logged.

**Recommendation:** Because running the trace log file size is not limited and can impact performance, turn trace off in a production environment.

**Syntax:**

**Stopping the trace from the Qshell:**

```
▶▶—dxxttc—off—user_profile—▶▶
```

**Stopping the trace from the iSeries Navigator:**

```
call schema.QZXMTRC('off', 'user_profile');
```

**Stopping the trace from the OS command line:**

```
call QDBXM/QZXMTRC PARM(off user_profile)
```

**Parameters:**

Table 66. Trace parameters

Parameter	Description
<i>user_profile</i>	The name of the user profile associated with the job within which the XML Extender is running.

**Examples:**

The following examples demonstrate stopping the trace.

**From the Qshell:**

```
dxstrc off user1
```

**From the iSeries Navigator:**

```
call myschema.QZXMTRC('off', 'user1');
```

**From the OS command line:**

```
call QDBXM/QZXMTRC PARM(off user1)
```

---

## XML Extender UDF return codes

Embedded SQL statements return codes in the `SQLCODE`, `SQLWARN`, and `SQLSTATE` fields of the `SQLCA` structure. This structure is defined in an `SQLCA INCLUDE` file. (For more information about the `SQLCA` structure and `SQLCA INCLUDE` file, see the *DB2 Application Development Guide*.)

DB2 CLI calls return `SQLCODE` and `SQLSTATE` values that you can retrieve using the `SQLERROR` function. (For more information about retrieving error information with the `SQLERROR` function, see the *CLI Guide and Reference*.)

An `SQLCODE` value of 0 means that the statement ran successfully (with possible warning conditions). A positive `SQLCODE` value means that the statement ran successfully but with a warning. (Embedded SQL statements return information about the warning that is associated with 0 or positive `SQLCODE` values in the `SQLWARN` field.) A negative `SQLCODE` value means that an error occurred.

DB2 associates a message with each `SQLCODE` value. If an XML Extender UDF encounters a warning or error condition, it passes associated information to DB2 UDB for inclusion in the `SQLCODE` message.

Embedded SQL statements and DB2 UDB CLI calls that invoke the DB2 XML Extender UDFs might return `SQLCODE` messages and `SQLSTATE` values that are unique to these UDFs, but DB2 UDB returns these values in the same way that it does for other embedded SQL statements or other DB2 UDB CLI calls. Thus, the way that you access these values is the same as for embedded SQL statements or DB2 UDB CLI calls that do not start the DB2 UDB XML Extender UDFs.

---

## XML Extender stored procedure return codes

The XML Extender provides return codes to help resolve problems with stored procedures. When you receive a return code from a stored procedure, check the following file, which matches the return code with an XML Extender error message number and the symbolic constant.

```
/qibm/ProdData/DB2Extenders/XML/include/dxxrc.h
```

**Related reference:**

- “`SQLSTATE` codes and associated message numbers for XML Extender” on page 207

---

## SQLSTATE codes and associated message numbers for XML Extender

Table 67. *SQLSTATE* codes and associated message numbers

SQLSTATE	Message Number	Description
00000	DXXnnnnI	No error occurred.

Table 67. SQLSTATE codes and associated message numbers (continued)

SQLSTATE	Message Number	Description
01HX0	DXXD003W	The element or attribute specified in the path expression is missing from the XML document.
38X00	DXXC000E	The XML Extender is unable to open the specified file.
38X01	DXXA072E	XML Extender tried to automatically bind the database before enabling it, but could not find the bind files.
	DXXC001E	The XML Extender could not find the file specified.
38X02	DXXC002E	The XML Extender is unable to read data from the specified file.
38X03	DXXC003E	The XML Extender is unable to write data to the file.
	DXXC011E	The XML Extender is unable to write data to the trace control file.
38X04	DXXC004E	The XML Extender was unable to operate the specified locator.
38X05	DXXC005E	The file size is greater than the XMLVarchar size, and the XML Extender is unable to import all the data from the file.
38X06	DXXC006E	The file size is greater than the size of the XMLCLOB, and the XML Extender is unable to import all the data from the file.
38X07	DXXC007E	The number of bytes in the LOB locator does not equal the file size.
38X08	DXXD001E	A scalar extraction function used a location path that occurs multiple times. A scalar function can use only a location path that does not have multiple occurrence.
38X09	DXXD002E	The path expression is syntactically incorrect.
38X10	DXXG002E	The XML Extender was unable to allocate memory from the operating system.
38X11	DXXA009E	This stored procedure is for an XML column only.
38X12	DXXA010E	While attempting to enable the column, the XML Extender could not find the DTD ID, which is the identifier specified for the DTD in the document access definition (DAD) file.

Table 67. SQLSTATE codes and associated message numbers (continued)

SQLSTATE	Message Number	Description
	DXXQ060E	The XML Extender could not find the SCHEMA ID while attempting to enable the column. The SCHEMA ID corresponds to the value of the location attribute of the nonnamespace location tag which is inside the schemabindings tag in the DAD file.
38X13	DXXQ072E	The XML Extender uses the XML Parser that is delivered with the XML Toolkit for iSeries.
38X14	DXXD000E	There was an attempt to store an invalid document into a table. Validation failed.
38X15	DXXA056E	The validation element in the document access definition (DAD) file is wrong or missing.
	DXXA057E	The name attribute of a side table in the document access definition (DAD) file is wrong or missing.
	DXXA058E	The name attribute of a column in the document access definition (DAD) file is wrong or missing.
	DXXA059E	The type attribute of a column in the document access definition (DAD) file is wrong or missing.
	DXXA060E	The path attribute of a column in the document access definition (DAD) file is wrong or missing.
	DXXA061E	The multi_occurrence attribute of a column in the document access definition (DAD) file is wrong or missing.
	DXXQ000E	A mandatory element is missing from the document access definition (DAD) file.
	DXXQ056E	The specified element/attribute cannot be mapped to a column that is specified as part of a foreign key. Data values for foreign keys are determined by that of the primary keys; a mapping of the specified element/attribute in the XML document to a table and column is not necessary.
	DXXQ057E	The schemabindings and DTD ID tags cannot exist together in the DAD file.
	DXXQ058E	The nonnamespace location tag inside the schemabindings tag is missing in the DAD file.

Table 67. SQLSTATE codes and associated message numbers (continued)

SQLSTATE	Message Number	Description
	DXXQ059E	The doctype tag cannot be located inside the XCollection tag in the DAD for schema validation.
	DXXQ062E	This error condition is usually caused by a missing multi_occurrence = YES specification on the parent element_node of the given element or attribute.
	DXXQ063E	The value of the multi_occurrence attribute on the specified element_node in the document access definition (DAD) file is wrong or missing. The value must be 'yes' or 'no', case insensitive.
	DXXQ064E	A key column specified in the join condition was not mapped to any element or attribute node.
38X16	DXXG004E	A null value for a required parameter was passed to an XML stored procedure.
38X17	DXXQ001E	The SQL statement in the document access definition (DAD) file or the statement that overrides it is not valid. A SELECT statement is required for generating XML documents.
38X18	DXXG001E	XML Extender encountered an internal error.
	DXXG006E	XML Extender encountered an internal error while using CLI.
38X19	DXXQ002E	The system is running out of space in memory or disk. There is no space to contain the resulting XML documents.
38X20	DXXQ003W	The user-defined SQL query generates more XML documents than the specified maximum. Only the specified number of documents are returned.
38X21	DXXQ004E	The specified column is not one of the columns in the result of the SQL query.
38X22	DXXQ005E	The mapping of the SQL query to XML is incorrect.
38X23	DXXQ006E	An attribute_node element in the document access definition (DAD) file does not have a name attribute.
38X24	DXXQ007E	The attribute_node element in the document access definition (DAD) does not have a column element or RDB_node.



Table 67. SQLSTATE codes and associated message numbers (continued)

SQLSTATE	Message Number	Description
38X25	DXXQ008E	A text_node element in the document access definition (DAD) file does not have a column element.
38X26	DXXQ009E	The specified result table could not be found in the system catalog.
38X27	DXXQ010E DXXQ040E	The RDB_node of the attribute_node or text_node must have a table.
	DXXQ011E	The RDB_node of the attribute_node or text_node must have a column.
	DXXQ017E	An XML document generated by the XML Extender is too large to fit into the column of the result table.
	DXXQ040E	The specified element name in document access definition (DAD) file is wrong.
38X28	DXXQ012E	XML Extender could not find the expected element while processing the DAD.
	DXXQ016E	All tables must be defined in the RDB_node of the top element in the document access definition (DAD) file. Sub-element tables must match the tables defined in the top element. The table name in this RDB_node is not in the top element.
38X29	DXXQ013E	The element table or column must have a name in the document access definition (DAD) file.
	DXXQ015E	The condition in the condition element in the document access definition (DAD) file has an invalid format.
	DXXQ061E	The format of the string representation is invalid. If the string is a date, time, or timestamp value, the syntax does not conform to its data type.
38X30	DXXQ014E	An element_node element in the document access definition (DAD) file does not have a name attribute.
	DXXQ018E	The ORDER BY clause is missing from the SQL statement in a document access definition (DAD) file that maps SQL to XML.
38X31	DXXQ019E	The objids element does not have a column element in the document access definition (DAD) file that maps SQL to XML.

Table 67. SQLSTATE codes and associated message numbers (continued)

SQLSTATE	Message Number	Description
38X33	DXXG005E	This parameter is not supported in this release. It will be supported in the future release.
38X34	DXXG000E	An invalid file name was specified.
38X36	DXXA073E	The database was not bound when you tried to enable it.
38X37	DXXG007E	The server operating system locale is inconsistent with the DB2 UDB code page.
38X38	DXXG008E	The server operating system locale can not be found in the code page table.
38X41	DXXQ048E	The stylesheet processor returned an internal error. The XML document or the stylesheet might not be valid.
38X42	DXXQ049E	The specified output file already exists in this directory.
38X43	DXXQ050E	The UDF was unable to create a unique file name for the output document in the specified directory because it does not have access. All file names that can be generated are in use or directory might not exist.
38X44	DXXQ051E	One or more input or output parameters have no valid value.
38X45	DXXQ055E	ICU error encountered during conversion operation.

## XML Extender messages

**DXXA000I** Enabling column *<column\_name>*. Please Wait.

**Explanation:** This is an informational message.

**User response:** No action required.

**DXXA001S** An unexpected error occurred in build *<build\_ID>*, file *<file\_name>*, and line *<line\_number>*.

**Explanation:** An unexpected error occurred.

**User response:** If this error persists, contact your Software Service Provider. When reporting the error, be sure to include all the message text, the trace file, and an explanation of how to reproduce the problem.

**DXXA002I** Connecting to database *<database>*.

**Explanation:** This is an informational message.

**User response:** No action required.

**DXXA003E** Cannot connect to database *<database>*.

**Explanation:** The database specified might not exist or could be corrupted.

**User response:**

1. Ensure the database is specified correctly.
2. Ensure the database exists and is accessible.
3. Determine if the database is corrupted. If it is, ask your database administrator to recover it from a backup.

**DXXA004E** Cannot enable database *<database>*.

**Explanation:** The database might already be enabled or might be corrupted.

**User response:**

1. Determine if the database is enabled.
2. Determine if the database is corrupted. If it is, ask your database administrator to recover it from a backup.

---

**DXXA005I** Enabling database *<database>*. Please wait.

**Explanation:** This is an informational message.

**User response:** No action required.

---

**DXXA006I** The database *<database>* was enabled successfully.

**Explanation:** This is an informational message.

**User response:** No action required.

---

**DXXA007E** Cannot disable database *<database>*.

**Explanation:** The database cannot be disabled by XML Extender if it contains any XML columns or collections.

**User response:** Backup any important data, disable any XML columns or collections, and update or drop any tables until there are no XML data types left in the database.

---

**DXXA008I** Disabling column *<column\_name>*. Please Wait.

**Explanation:** This is an information message.

**User response:** No action required.

---

**DXXA009E** Xcolumn tag is not specified in the DAD file.

**Explanation:** This stored procedure is for XML Column only.

**User response:** Ensure the Xcolumn tag is specified correctly in the DAD file.

---

**DXXA010E** Attempt to find DTD ID *<dtid>* failed.

**Explanation:** While attempting to enable the column, the XML Extender could not find the DTD ID, which is the identifier specified for the DTD in the document access definition (DAD) file.

**User response:** Ensure the correct value for the DTD ID is specified in the DAD file.

---

**DXXA011E** Inserting a record into DB2XML.XML\_USAGE table failed.

**Explanation:** While attempting to enable the column, the XML Extender could not insert a record into the DB2XML.XML\_USAGE table.

**User response:** Ensure the DB2XML.XML\_USAGE table exists and that a record by the same name does not already exist in the table.

---

---

**DXXA012E** Attempt to update DB2XML.DTD\_REF table failed.

**Explanation:** While attempting to enable the column, the XML Extender could not update the DB2XML.DTD\_REF table.

**User response:** Ensure the DB2XML.DTD\_REF table exists. Determine whether the table is corrupted or if the administration user ID has the correct authority to update the table.

---

**DXXA013E** Attempt to alter table *<table\_name>* failed.

**Explanation:** While attempting to enable the column, the XML Extender could not alter the specified table.

**User response:** Check the privileges required to alter the table.

---

**DXXA014E** The specified root ID column: *<root\_id>* is not a single primary key of table *<table\_name>*.

**Explanation:** The root ID specified is either not a key, or it is not a single key of table *table\_name*.

**User response:** Ensure the specified root ID is the single primary key of the table.

---

**DXXA015E** The column DXXROOT\_ID already exists in table *<table\_name>*.

**Explanation:** The column DXXROOT\_ID exists, but was not created by XML Extender.

**User response:** Specify a primary column for the root ID option when enabling a column, using a different different column name.

---

**DXXA016E** The input table *<table\_name>* does not exist.

**Explanation:** The XML Extender was unable to find the specified table in the system catalog.

**User response:** Ensure that the table exists in the database, and is specified correctly.

---

**DXXA017E** The input column *<column\_name>* does not exist in the specified table *<table\_name>*.

**Explanation:** The XML Extender was unable to find the column in the system catalog.

**User response:** Ensure the column exists in a user table.

---

---

**DXXA018E The specified column is not enabled for XML data.**

**Explanation:** While attempting to disable the column, XML Extender could not find the column in the DB2XML.XML\_USAGE table, indicating that the column is not enabled. If the column is not XML-enabled, you do not need to disable it.

**User response:** No action required.

---

**DXXA019E A input parameter required to enable the column is null.**

**Explanation:** A required input parameter for the enable\_column() stored procedure is null.

**User response:** Check all the input parameters for the enable\_column() stored procedure.

---

**DXXA020E Columns cannot be found in the table <table\_name>.**

**Explanation:** While attempting to create the default view, the XML Extender could not find columns in the specified table.

**User response:** Ensure the column and table name are specified correctly.

---

**DXXA021E Cannot create the default view <default\_view>.**

**Explanation:** While attempting to enable a column, the XML Extender could not create the specified view.

**User response:** Ensure that the default view name is unique. If a view with the name already exists, specify a unique name for the default view.

---

**DXXA022I Column <column\_name> enabled.**

**Explanation:** This is an informational message.

**User response:** No response required.

---

**DXXA023E Cannot find the DAD file.**

**Explanation:** While attempting to disable a column, the XML Extender was unable to find the document access definition (DAD) file.

**User response:** Ensure you specified the correct database name, table name, or column name.

---

**DXXA024E The XML Extender encountered an internal error while accessing the system catalog tables.**

**Explanation:** The XML Extender was unable to access system catalog table.

**User response:** Ensure the database is in a stable state.

---

---

**DXXA025E Cannot drop the default view <default\_view>.**

**Explanation:** While attempting to disable a column, the XML Extender could not drop the default view.

**User response:** Ensure the administration user ID for XML Extender has the privileges necessary to drop the default view.

---

**DXXA026E Unable to drop the side table <side\_table>.**

**Explanation:** While attempting to disable a column, the XML Extender was unable to drop the specified table.

**User response:** Ensure that the administrator user ID for XML Extender has the privileges necessary to drop the table.

---

**DXXA027E Could not disable the column.**

**Explanation:** XML Extender could not disable a column because an internal trigger failed. Possible causes:

- The system is out of memory.
- A trigger with this name does not exist.

**User response:** Use the trace facility to create a trace file and try to correct the problem. If the problem persists, contact your Software Service Provider and provide the trace file.

---

**DXXA028E Could not disable the column.**

**Explanation:** XML Extender could not disable a column because an internal trigger failed. Possible causes:

- The system is out of memory.
- A trigger with this name does not exist.

**User response:** Use the trace facility to create a trace file and try to correct the problem. If the problem persists, contact your Software Service Provider and provide the trace file.

---

**DXXA029E Could not disable the column.**

**Explanation:** XML Extender could not disable a column because an internal trigger failed. Possible causes:

- The system is out of memory.
- A trigger with this name does not exist.

**User response:** Use the trace facility to create a trace file and try to correct the problem. If the problem persists, contact your Software Service Provider and provide the trace file.

---

---

**DXXA030E Could not disable the column.**

**Explanation:** XML Extender could not disable a column because an internal trigger failed. Possible causes:

- The system is out of memory.
- A trigger with this name does not exist.

**User response:** Use the trace facility to create a trace file and try to correct the problem. If the problem persists, contact your Software Service Provider and provide the trace file.

---

**DXXA031E Unable to reset the DXXROOT\_ID column value in the application table to NULL.**

**Explanation:** While attempting to disable a column, the XML Extender was unable to set the value of DXXROOT\_ID in the application table to NULL.

**User response:** Ensure that the administrator user ID for XML Extender has the privileges necessary to alter the application table.

---

**DXXA032E Decrement of USAGE\_COUNT in DB2XML.XML\_USAGE table failed.**

**Explanation:** While attempting to disable the column, the XML Extender was unable to reduce the value of the USAGE\_COUNT column by one.

**User response:** Ensure that the DB2XML.XML\_USAGE table exists and that the administrator user ID for XML Extender has the necessary privileges to update the table.

---

**DXXA033E Attempt to delete a row from the DB2XML.XML\_USAGE table failed.**

**Explanation:** While attempting to disable a column, the XML Extender was unable to delete its associate row in the DB2XML.XML\_USAGE table.

**User response:** Ensure that the DB2XML.XML\_USAGE table exists and that the administration user ID for XML Extender has the privileges necessary to update this table.

---

**DXXA034I XML Extender has successfully disabled column <column\_name>.**

**Explanation:** This is an informational message

**User response:** No action required.

---

**DXXA035I XML Extender is disabling database <database>. Please wait.**

**Explanation:** This is an informational message.

**User response:** No action is required.

---

**DXXA036I XML Extender has successfully disabled database <database>.**

**Explanation:** This is an informational message.

**User response:** No action is required.

---

**DXXA037E The specified table space name is longer than 18 characters.**

**Explanation:** The table space name cannot be longer than 18 alphanumeric characters.

**User response:** Specify a name less than 18 characters.

---

**DXXA038E The specified default view name is longer than 18 characters.**

**Explanation:** The default view name cannot be longer than 18 alphanumeric characters.

**User response:** Specify a name less than 18 characters.

---

**DXXA039E The specified ROOT\_ID name is longer than 18 characters.**

**Explanation:** The ROOT\_ID name cannot be longer than 18 alphanumeric characters.

**User response:** Specify a name less than 18 characters.

---

**DXXA046E Unable to create the side table <side\_table>.**

**Explanation:** While attempting to enable a column, the XML Extender was unable to create the specified side table.

**User response:** Ensure that the administrator user ID for XML Extender has the privileges necessary to create the side table.

---

**DXXA047E Could not enable the column.**

**Explanation:** XML Extender could not enable a column because an internal trigger failed. Possible causes:

- The DAD file has incorrect syntax.
- The system is out of memory.
- Another trigger exists with the same name.

**User response:** Use the trace facility to create a trace file and try to correct the problem. If the problem persists, contact your Software Service Provider and provide the trace file.

---

**DXXA048E Could not enable the column.**

**Explanation:** XML Extender could not enable a column because an internal trigger failed. Possible causes:

- The DAD file has incorrect syntax.

- The system is out of memory.
- Another trigger exists with the same name.

**User response:** Use the trace facility to create a trace file and try to correct the problem. If the problem persists, contact your Software Service Provider and provide the trace file.

**DXXA049E Could not enable the column.**

**Explanation:** XML Extender could not enable a column because an internal trigger failed. Possible causes:

- The DAD file has incorrect syntax.
- The system is out of memory.
- Another trigger exists with the same name.

**User response:** Use the trace facility to create a trace file and try to correct the problem. If the problem persists, contact your Software Service Provider and provide the trace file.

**DXXA050E Could not enable the column.**

**Explanation:** XML Extender could not enable a column because an internal trigger failed. Possible causes:

- The DAD file has incorrect syntax.
- The system is out of memory.
- Another trigger exists with the same name.

**User response:** Use the trace facility to create a trace file and try to correct the problem. If the problem persists, contact your Software Service Provider and provide the trace file.

**DXXA051E Could not disable the column.**

**Explanation:** XML Extender could not disable a column because an internal trigger failed. Possible causes:

- The system is out of memory.
- A trigger with this name does not exist.

**User response:** Use the trace facility to create a trace file and try to correct the problem. If the problem persists, contact your Software Service Provider and provide the trace file.

**DXXA052E Could not disable the column.**

**Explanation:** XML Extender could not disable a column because an internal trigger failed. Possible causes:

- The DAD file has incorrect syntax.
- The system is out of memory.
- Another trigger exists with the same name.

**User response:** Use the trace facility to create a trace file and try to correct the problem. If the problem

persists, contact your Software Service Provider and provide the trace file.

**DXXA053E Could not enable the column.**

**Explanation:** XML Extender could not enable a column because an internal trigger failed. Possible causes:

- The DAD file has incorrect syntax.
- The system is out of memory.
- Another trigger exists with the same name.

**User response:** Use the trace facility to create a trace file and try to correct the problem. If the problem persists, contact your Software Service Provider and provide the trace file.

**DXXA054E Could not enable the column.**

**Explanation:** XML Extender could not enable a column because an internal trigger failed. Possible causes:

- The DAD file has incorrect syntax.
- The system is out of memory.
- Another trigger exists with the same name.

**User response:** Use the trace facility to create a trace file and try to correct the problem. If the problem persists, contact your Software Service Provider and provide the trace file.

**DXXA056E The validation value <validation\_value> in the DAD file is invalid.**

**Explanation:** The validation element in document access definition (DAD) file is wrong or missing.

**User response:** Ensure that the validation element is specified correctly in the DAD file.

**DXXA057E A side table name <side\_table\_name> in DAD is invalid.**

**Explanation:** The name attribute of a side table in the document access definition (DAD) file is wrong or missing.

**User response:** Ensure that the name attribute of a side table is specified correctly in the DAD file.

**DXXA058E A column name <column\_name> in the DAD file is invalid.**

**Explanation:** The name attribute of a column in the document access definition (DAD) file is wrong or missing.

**User response:** Ensure that the name attribute of a column is specified correctly in the DAD file.

---

**DXXA059E** The type *<column\_type>* of column *<column\_name>* in the DAD file is invalid.

**Explanation:** The type attribute of a column in the document access definition (DAD) file is wrong or missing.

**User response:** Ensure that the type attribute of a column is specified correctly in the DAD file.

---

**DXXA060E** The path attribute *<location\_path>* of *<column\_name>* in the DAD file is invalid.

**Explanation:** The path attribute of a column in the document access definition (DAD) file is wrong or missing.

**User response:** Ensure that the path attribute of a column is specified correctly in the DAD file.

---

**DXXA061E** The multi\_occurrence attribute *<multi\_occurrence>* of *<column\_name>* in the DAD file is invalid.

**Explanation:** The multi\_occurrence attribute of a column in the document access definition (DAD) file is wrong or missing.

**User response:** Ensure that the multi\_occurrence attribute of a column is specified correctly in the DAD file.

---

**DXXA062E** Unable to retrieve the column number for *<column\_name>* in table *<table\_name>*.

**Explanation:** XML Extender could not retrieve the column number for *column\_name* in table *table\_name* from the system catalog.

**User response:** Make sure the application table is well defined.

---

**DXXA063I** Enabling collection *<collection\_name>*. Please Wait.

**Explanation:** This is an information message.

**User response:** No action required.

---

**DXXA064I** Disabling collection *<collection\_name>*. Please Wait.

**Explanation:** This is an information message.

**User response:** No action required.

---

---

**DXXA065E** Calling stored procedure *<procedure\_name>* failed.

**Explanation:** Check the shared library db2xml and see if the permission is correct.

**User response:** Make sure the client has permission to run the stored procedure.

---

**DXXA066I** XML Extender has successfully disabled collection *<collection\_name>*.

**Explanation:** This is an informational message.

**User response:** No response required.

---

**DXXA067I** XML Extender has successfully enabled collection *<collection\_name>*.

**Explanation:** This is an informational message.

**User response:** No response required.

---

**DXXA068I** XML Extender has successfully turned the trace on.

**Explanation:** This is an informational message.

**User response:** No response required.

---

**DXXA069I** XML Extender has successfully turned the trace off.

**Explanation:** This is an informational message.

**User response:** No response required.

---

**DXXA070W** The database has already been enabled.

**Explanation:** The enable database command was executed on the enabled database

**User response:** No action is required.

---

**DXXA071W** The database has already been disabled.

**Explanation:** The disable database command was executed on the disabled database

**User response:** No action is required.

---

**DXXA072E** XML Extender couldn't find the bind files. Bind the database before enabling it.

**Explanation:** XML Extender tried to automatically bind the database before enabling it, but could not find the bind files

**User response:** Bind the database before enabling it.

---

---

**DXXA073E** The database is not bound. Please bind the database before enabling it.

**Explanation:** The database was not bound when user tried to enable it.

**User response:** Bind the database before enabling it.

---

**DXXA074E** Wrong parameter type. The stored procedure expects a STRING parameter.

**Explanation:** The stored procedure expects a STRING parameter.

**User response:** Declare the input parameter to be STRING type.

---

**DXXA075E** Wrong parameter type. The input parameter should be a LONG type.

**Explanation:** The stored procedure expects the input parameter to be a LONG type.

**User response:** Declare the input parameter to be a LONG type.

---

**DXXA076E** XML Extender trace instance ID invalid.

**Explanation:** Cannot start trace with the instance ID provided.

**User response:** Ensure that the instance ID is a valid iSeries user ID.

---

**DXXA077E** The license key is not valid. See the server error log for more detail.

**Explanation:** The software license has expired or does not exist.

**User response:** Contact your service provider to obtain a new software license.

---

**DXXC000E** Unable to open the specified file.

**Explanation:** The XML Extender is unable to open the specified file.

**User response:** Ensure that the application user ID has read and write permission for the file.

---

**DXXC001E** The specified file is not found.

**Explanation:** The XML Extender could not find the file specified.

**User response:** Ensure that the file exists and the path is specified correctly.

---

---

**DXXC002E** Unable to read file.

**Explanation:** The XML Extender is unable to read data from the specified file.

**User response:** Ensure that the application user ID has read permission for the file.

---

**DXXC003E** Unable to write to the specified file.

**Explanation:** The XML Extender is unable to write data to the file.

**User response:** Ensure that the application user ID has write permission for the file or that the file system has sufficient space.

---

**DXXC004E** Unable to operate the LOB Locator:  
*rc=<locator\_rc>*.

**Explanation:** The XML Extender was unable to operate the specified locator.

**User response:** Ensure the LOB Locator is set correctly.

---

**DXXC005E** Input file size is greater than XMLVarchar size.

**Explanation:** The file size is greater than the XMLVarchar size and the XML Extender is unable to import all the data from the file.

**User response:** Use the XMLCLOB column type.

---

**DXXC006E** The input file exceeds the DB2 UDB LOB limit.

**Explanation:** The file size is greater than the size of the XMLCLOB and the XML Extender is unable to import all the data from the file.

**User response:** Decompose the file into smaller objects or use an XML collection.

---

**DXXC007E** Unable to retrieve data from the file to the LOB Locator.

**Explanation:** The number of bytes in the LOB Locator does not equal the file size.

**User response:** Ensure the LOB Locator is set correctly.

---

**DXXC008E** Can not remove the file *<file\_name>*.

**Explanation:** The file has a sharing access violation or is still open.

**User response:** Close the file or stop any processes that are holding the file. You might have to stop and restart DB2.

---



---

**DXXC009E** Unable to create file to *<directory>* directory.

**Explanation:** The XML Extender is unable to create a file in directory *directory*.

**User response:** Ensure that the directory exists, that the application user ID has write permission for the directory, and that the file system has sufficient space for the file.

---

**DXXC010E** Error while writing to file *<file\_name>*.

**Explanation:** There was an error while writing to the file *file\_name*.

**User response:** Ensure that the file system has sufficient space for the file.

---

**DXXC011E** Unable to write to the trace control file.

**Explanation:** The XML Extender is unable to write data to the trace control file.

**User response:** Ensure that the application user ID has write permission for the file or that the file system has sufficient space.

---

**DXXC012E** Cannot create temporary file.

**Explanation:** Cannot create file in system temp directory.

**User response:** Ensure that the application user ID has write permission for the file system temp directory or that the file system has sufficient space for the file.

---

**DXXC013E** The results of the extract UDF exceed the size limit for the UDF return type.

**Explanation:** The data returned by an extract UDF must fit into the size limit of the return type of the UDF, as defined in the DB2 UDB XML Extender Administration and Programming guide. For example, the results of `extractVarchar` must be no more than 4000 bytes (including the terminating NULL).

**User response:** Use an extract UDF that has a larger size limit for the return type: 254 bytes for `extractChar()`, 4 KB for `extractVarchar()`, and 2 GB for `extractClob()`.

---

**DXXD000E** An invalid XML document is rejected.

**Explanation:** There was an attempt to store an invalid document into a table. Validation has failed.

**User response:** Check the document with its DTD using an editor that can view invisible invalid characters. To suppress this error, turn off validation in the DAD file.

---

**DXXD001E** *<location\_path>* occurs multiple times.

**Explanation:** A scalar extraction function used a location path that occurs multiple times. A scalar function can only use a location path that does not have multiple occurrences.

**User response:** Use a table function (add an 's' to the end of the scalar function name).

---

**DXXD002E** A syntax error occurred near position *<position>* in the search path.

**Explanation:** The path expression is syntactically incorrect.

**User response:** Correct the search path argument of the query. Refer to the documentation for the syntax of path expressions.

---

**DXXD003W** Path not found. Null is returned.

**Explanation:** The element or attribute specified in the path expression is missing from the XML document.

**User response:** Verify that the specified path is correct.

---

**DXXG000E** The file name *<file\_name>* is invalid.

**Explanation:** An invalid file name was specified.

**User response:** Specify a correct file name and try again.

---

**DXXG001E** An internal error occurred in build *<build\_ID>*, file *<file\_name>*, and line *<line\_number>*.

**Explanation:** XML Extender encountered an internal error.

**User response:** Contact your Software Service Provider. When reporting the error, be sure to include all the messages, the trace file and how to reproduce the error.

---

**DXXG002E** The system is out of memory.

**Explanation:** The XML Extender was unable to allocate memory from the operating system.

**User response:** Close some applications and try again. If the problem persists, refer to your operating system documentation for assistance. Some operating systems might require that you reboot the system to correct the problem.

---

**DXXG004E** Invalid null parameter.

**Explanation:** A null value for a required parameter was passed to an XML stored procedure.

**User response:** Check all required parameters in the argument list for the stored procedure call.

---

**DXXG005E Parameter not supported.**

**Explanation:** This parameter is not supported in this release, will be supported in the future release.

**User response:** Set this parameter to NULL.

---

**DXXG006E Internal Error CLISTATE=<clistate>, RC=<cli\_rc>, build <build\_ID>, file <file\_name>, line <line\_number> CLIMSG=<CLI\_msg>.**

**Explanation:** XML Extender encountered an internal error while using CLI.

**User response:** Contact your Software Service Provider. Potentially this error can be caused by incorrect user input. When reporting the error, be sure to include all output messages, trace log, and how to reproduce the problem. Where possible, send any DADs, XML documents, and table definitions which apply.

---

**DXXG007E Locale <locale> is inconsistent with DB2 UDB code page <code\_page>.**

**Explanation:** The server operating system locale is inconsistent with DB2 UDB code page.

**User response:** Correct the server operating system locale and restart DB2.

---

**DXXG008E Locale <locale> is not supported.**

**Explanation:** The server operating system locale can not be found in the code page table.

**User response:** Correct the server operating system locale and restart DB2.

---

**DXXG017E The limit for XML\_Extender\_constant has been exceeded in build build\_ID, file file\_name, and line line\_number.**

**Explanation:** The limit for the XML Extender constant named was exceeded in the code location specified by the build, file, and line number.

**User response:** Check if your application has exceeded a value in the limits table in the *DB2 UDB XML Extender Administration and Programming Guide*. If no limit has been exceeded, contact your Software Service Provider. When reporting the error, include all output messages, trace files, and information on how to reproduce the problem such as input DADs, XML documents, and table definitions.

---

**DXXM001W A DB2 UDB error occurred.**

**Explanation:** DB2 encountered the specified error.

**User response:** See any accompanying messages for further explanation and refer to DB2 UDB messages and

codes documentation for your operating system.

---

**DXXQ000E <Element> is missing from the DAD file.**

**Explanation:** A mandatory element is missing from the document access definition (DAD) file.

**User response:** Add the missing element to the DAD file.

---

**DXXQ001E Invalid SQL statement for XML generation.**

**Explanation:** The SQL statement in the document access definition (DAD) or the one that overrides it is not valid. A SELECT statement is required for generating XML documents.

**User response:** Correct the SQL statement.

---

**DXXQ002E Cannot generate storage space to hold XML documents.**

**Explanation:** The system is running out of space in memory or disk. There is no space to contain the resulting XML documents.

**User response:** Limit the number of documents to be generated. Reduce the size of each documents by removing some unnecessary element and attribute nodes from the document access definition (DAD) file.

---

**DXXQ003W Result exceeds maximum.**

**Explanation:** The user-defined SQL query generates more XML documents than the specified maximum. Only the specified number of documents are returned.

**User response:** No action is required. If all documents are needed, specify zero as the maximum number of documents.

---

**DXXQ004E The column <column\_name> is not in the result of the query.**

**Explanation:** The specified column is not one of the columns in the result of the SQL query.

**User response:** Change the specified column name in the document access definition (DAD) file to make it one of the columns in the result of the SQL query. Alternatively, change the SQL query so that it has the specified column in its result.

---

**DXXQ005E Wrong relational mapping. The element <element\_name> is at a lower level than its child column <column\_name>.**

**Explanation:** The mapping of the SQL query to XML is incorrect.

**User response:** Make sure that the columns in the result of the SQL query are in a top-down order of the

relational hierarchy. Also make sure that there is a single-column candidate key to begin each level. If such a key is not available in a table, the query should generate one for that table using a table expression and the DB2 UDB built-in function generate\_unique().

---

**DXXQ006E An attribute\_node element has no name.**

**Explanation:** An attribute\_node element in the document access definition (DAD) file does not have a name attribute.

**User response:** Ensure that every attribute\_node has a name in the DAD file.

---

**DXXQ007E The attribute\_node <attribute\_name> has no column element or RDB\_node.**

**Explanation:** The attribute\_node element in the document access definition (DAD) does not have a column element or RDB\_node.

**User response:** Ensure that every attribute\_node has a column element or RDB\_node in the DAD.

---

**DXXQ008E A text\_node element has no column element.**

**Explanation:** A text\_node element in the document access definition (DAD) file does not have a column element.

**User response:** Ensure that every text\_node has a column element in the DAD.

---

**DXXQ009E Result table <table\_name> does not exist.**

**Explanation:** The specified result table could not be found in the system catalog.

**User response:** Create the result table before calling the stored procedure.

---

**DXXQ010E RDB\_node of <node\_name> does not have a table in the DAD file.**

**Explanation:** The RDB\_node of the attribute\_node or text\_node must have a table.

**User response:** Specify the table of RDB\_node for attribute\_node or text\_node in the document access definition (DAD) file.

---

**DXXQ011E RDB\_node element of <node\_name> does not have a column in the DAD file.**

**Explanation:** The RDB\_node of the attribute\_node or text\_node must have a column.

**User response:** Specify the column of RDB\_node for attribute\_node or text\_node in the document access definition (DAD) file.

---

**DXXQ012E Errors occurred in DAD.**

**Explanation:** XML Extender could not find the expected element while processing the DAD.

**User response:** Check that the DAD is a valid XML document and contains all the elements required by the DAD DTD. Consult the XML Extender publication for the DAD DTD.

---

**DXXQ013E The table or column element does not have a name in the DAD file.**

**Explanation:** The element table or column must have a name in the document access definition (DAD) file.

**User response:** Specify the name of table or column element in the DAD.

---

**DXXQ014E An element\_node element has no name.**

**Explanation:** An element\_node element in the document access definition (DAD) file does not have a name attribute.

**User response:** Ensure that every element\_node element has a name in the DAD file.

---

**DXXQ015E The condition format is invalid.**

**Explanation:** The condition in the condition element in the document access definition (DAD) has an invalid format.

**User response:** Ensure that the format of the condition is valid.

---

**DXXQ016E The table name in this RDB\_node is not defined in the top element of the DAD file.**

**Explanation:** All tables must be defined in the RDB\_node of the top element in the document access definition (DAD) file. Sub-element tables must match the tables defined in the top element. The table name in this RDB\_node is not in the top element.

**User response:** Ensure that the table of the RDB node is defined in the top element of the DAD file.

---

**DXXQ017E The column in the result table <table\_name> is too small.**

**Explanation:** An XML document generated by the XML Extender is too large to fit into the column of the result table.

**User response:** Drop the result table. Create another result table with a bigger column. Rerun the stored procedure.

---

**DXXQ018E** The ORDER BY clause is missing from the SQL statement.

**Explanation:** The ORDER BY clause is missing from the SQL statement in a document access definition (DAD) file that maps SQL to XML.

**User response:** Edit the DAD file. Add an ORDER BY clause that contains the entity-identifying columns.

---

**DXXQ019E** The element objids has no column element in the DAD file.

**Explanation:** The objids element does not have a column element in the document access definition (DAD) file that maps SQL to XML.

**User response:** Edit the DAD file. Add the key columns as sub-elements of the element objids.

---

**DXXQ020I** XML successfully generated.

**Explanation:** The requested XML documents have been successfully generated from the database.

**User response:** No action is required.

---

**DXXQ021E** Table <table\_name> does not have column <column\_name>.

**Explanation:** The table does not have the specified column in the database.

**User response:** Specify another column name in DAD or add the specified column into the table database.

---

**DXXQ022E** Column <column\_name> of <table\_name> should have type <type\_name>.

**Explanation:** The type of the column is wrong.

**User response:** Correct the type of the column in the document access definition (DAD).

---

**DXXQ023E** Column <column\_name> of <table\_name> cannot be longer than <length>.

**Explanation:** The length defined for the column in the DAD is too long.

**User response:** Correct the column length in the document access definition (DAD).

---

**DXXQ024E** Can not create table <table\_name>.

**Explanation:** The specified table can not be created.

**User response:** Ensure that the user ID creating the table has the necessary authority to create a table in the database.

---

---

**DXXQ025I** XML decomposed successfully.

**Explanation:** An XML document has been decomposed and stored in a collection successfully.

**User response:** No action is required.

---

**DXXQ026E** XML data <xml\_name> is too large to fit in column <column\_name>.

**Explanation:** The specified piece of data from an XML document is too large to fit into the specified column.

**User response:** Increase the length of the column using the ALTER TABLE statement or reduce the size of the data by editing the XML document.

---

**DXXQ028E** Cannot find the collection <collection\_name> in the XML\_USAGE table.

**Explanation:** A record for the collection cannot be found in the XML\_USAGE table.

**User response:** Verify that you have enabled the collection.

---

**DXXQ029E** Cannot find the DAD in XML\_USAGE table for the collection <collection\_name>.

**Explanation:** A DAD record for the collection cannot be found in the XML\_USAGE table.

**User response:** Ensure that you have enabled the collection correctly.

---

**DXXQ030E** Wrong XML override syntax.

**Explanation:** The XML\_override value is specified incorrectly in the stored procedure.

**User response:** Ensure that the syntax of XML\_override is correct.

---

**DXXQ031E** Table name cannot be longer than maximum length allowed by DB2.

**Explanation:** The table name specified by the condition element in the DAD is too long.

**User response:** Correct the length of the table name in document access definition (DAD).

---

**DXXQ032E** Column name cannot be longer than maximum length allowed by DB2.

**Explanation:** The column name specified by the condition element in the DAD is too long.

**User response:** Correct the length of the column name in the document access definition (DAD).

---

---

**DXXQ033E Invalid identifier starting at <identifier>**

**Explanation:** The string is not a valid DB2 UDB SQL identifier.

**User response:** Correct the string in the DAD to conform to the rules for DB2 UDB SQL identifiers.

---

**DXXQ034E Invalid condition element in top RDB\_node of DAD: <condition>**

**Explanation:** The condition element must be a valid WHERE clause consisting of join conditions connected by the conjunction AND.

**User response:** See the XML Extender documentation for the correct syntax of the join condition in a DAD.

---

**DXXQ035E Invalid join condition in top RDB\_node of DAD: <condition>**

**Explanation:** Column names in the condition element of the top RDB\_node must be qualified with the table name if the DAD specifies multiple tables.

**User response:** See the XML Extender documentation for the correct syntax of the join condition in a DAD.

---

**DXXQ036E A Schema name specified under a DAD condition tag is longer than allowed.**

**Explanation:** An error was detected while parsing text under a condition tag within the DAD. The condition text contains an id qualified by a schema name that is too long.

**User response:** Correct the text of the condition tags in document access definition (DAD).

---

**DXXQ037E Cannot generate <element> with multiple occurrences.**

**Explanation:** The element node and its descendants have no mapping to database, but its multi\_occurrence equals YES.

**User response:** Correct the DAD by either setting the multi\_occurrence to NO or create a RDB\_node in one of its descendants.

---

**DXXQ038E The SQL statement is too long: SQL\_statement**

**Explanation:** The SQL statement specified in the <SQL\_stmt> element of DAD exceeds the allowed number of bytes.

**User response:** Reduce the length of the SQL statement to less than or equal to 32765 bytes for Windows and UNIX, or 16380 bytes for OS/390 and iSeries.

---

---

**DXXQ039E Too many columns specified for a table in the DAD file.**

**Explanation:** A DAD file used for decomposition or RDB composition can have a maximum of 100 text\_node and attribute\_node elements that specify unique columns within the same table.

**User response:** Reduce the total number of text\_node and attribute\_node elements that refer to unique columns within the same table 100 or less.

---

**DXXQ040E The element name <element\_name> in the DAD file is invalid.**

**Explanation:** The specified element name in the document access definition (DAD) file is wrong.

**User response:** Ensure that the element name is typed correctly in the DAD file. See the DTD for the DAD file.

---

**DXXQ041W XML document successfully generated. One or more override paths specified is invalid and ignored.**

**Explanation:** Specify only one override path.

**User response:** Ensure that the element name is typed correctly in the DAD file. See the DTD for the DAD file.

---

**DXXQ043E Attribute <attr\_name> not found under element <elem\_name>.**

**Explanation:** The attribute <attr\_name> was not present in element <elem\_name> or one of its child elements.

**User response:** Ensure the attribute appears in the XML document everywhere that the DAD requires it.

---

**DXXQ044E Element <elem\_name> does not have an ancestor element<ancestor>.**

**Explanation:** According to the DAD, <ancestor> is an ancestor element of <elem\_name> . In the XML document, one or more element <elem\_name> does not have such an ancestor.

**User response:** Ensure that the nesting of elements in the XML document conforms to what is specified in the corresponding DAD.

---

**DXXQ045E Subtree under element <elem\_name> contains multiple attributes named<attrib\_name>.**

**Explanation:** A subtree under <elem\_name> in the XML document contains multiple instances of attribute<attrib\_name> , which according to the DAD, is to be decomposed into the same row. Elements or

---

attributes that are to be decomposed must have unique names.

**User response:** Ensure that the element or attribute in the subtree has a unique name.

---

**DXXQ046W The DTD ID was not found in the DAD.**

**Explanation:** In the DAD, VALIDATION is set to YES, but the DTDID element is not specified. No validation check is performed.

**User response:** No action is required. If validation is needed, specify the DTDID element in the DAD file.

---

**DXXQ047E Parser error on line <mv> linenumber</mv> column *colnumber*: *msg***

**Explanation:** The parser could not parse the document because of the reported error.

**User response:** Correct the error in the document, consulting the XML specifications if necessary.

---

**DXXQ048E Internal error - see trace file.**

**Explanation:** The stylesheet processor returned an internal error. The XML document or the stylesheet might not valid.

**User response:** Ensure the XML document and the stylesheet are valid.

---

**DXXQ049E The output file already exists.**

**Explanation:** The specified output file already exists in this directory.

**User response:** Change the output path or file name for the output document to a unique name or delete the existing file.

---

**DXXQ050E Unable to create a unique file name.**

**Explanation:** The UDF was unable to create a unique file name for the output document in the specified directory because it does not have access, all file names that can be generated are in use or directory might not exist.

**User response:** Ensure that the UDF has access to the specified directory, change to a directory with available file names.

---

**DXXQ051E No input or output data.**

**Explanation:** One or more input or output parameters have no valid value.

**User response:** Check the statement to see if required parameters are missing.

---

**DXXQ052E An error occurred while accessing the DB2XML.XML\_USAGE table.**

**Explanation:** Either the database has not been enabled or the table DB2XML.XML\_USAGE has been dropped.

**User response:** Ensure that the database has been enabled and the table DB2XML.XML\_USAGE is accessible.

---

**DXXQ053E An SQL statement failed : *msg***

**Explanation:** An SQL statement generated during XML Extender processing failed to execute.

**User response:** Examine the trace for more details. If you cannot correct the error condition, contact your softwareService provider. When reporting the error, be sure to include all the messages, the trace file and how to reproduce the error.

---

**DXXQ054E Invalid input parameter: *param***

**Explanation:** The specified input parameter to a stored procedure or UDF is invalid.

**User response:** Check the signature of the relevant stored procedure or UDF, and ensure the actual input parameter is correct.

---

**DXXQ055E ICU error: *uerror***

**Explanation:** ICU error encountered during conversion operation.

**User response:** Report the error to your software service provider. Include trace file, error message, and instructions to reproduce the error.

---

**DXXQ056E Element/attribute *xmlname* cannot be mapped to the column designated as part of the foreign key (column *column* in table *table*).**

**Explanation:** The specified element/attribute cannot be mapped to a column that is specified as part of a foreign key. Data values for foreign keys are determined by that of the primary keys; a mapping of the specified element/attribute in the xml document to a table and column is not necessary.

**User response:** Remove the RDB\_node mapping to the specified column and table in the DAD.

---

**DXXQ057E The schemabindings and dtdid tags cannot exist together in the DAD file.**

**Explanation:** The schemabindings and dtdid tags cannot exist together in the DAD file.

**User response:** Check that either the schemabindings tag or the dtdid tag exists in the DAD file, but not both.

---

**DXXQ058E** The nonamespacelocation tag inside the schemabindings tag is missing in the DAD file.

**Explanation:** The nonamespacelocation tag inside the schemabindings tag is missing in the DAD file.

**User response:** Add the nonamespacelocation tag to the schemabindings tag.

---

**DXXQ059E** The doctype tag cannot be located inside the XCollection tag in the DAD for schema validation.

**Explanation:** The doctype tag cannot be located inside the XCollection tag in the DAD for schema validation.

**User response:** Remove the doctype tag inside the Xcollection tag for schema validation.

---

**DXXQ060E** Attempt to find SCHEMA ID *schemaid* failed.

**Explanation:** The XML Extender could not find the SCHEMA ID while attempting to enable the column. The SCHEMA ID corresponds to the value of the location attribute of the nonamespacelocation tag which is inside the schemabindings tag in the DAD file.

**User response:** Check that the correct value for the SCHEMA ID is specified in the DAD file.

---

**DXXQ061E** The format of the string is invalid.

**Explanation:** The format of the string representation is invalid. If the string is a date, time, or timestamp value, the syntax does not conform to its data type.

**User response:** Check that the format of the date, time, or timestamp value conforms to the format for its data type.

---

**DXXQ062E** No rows of result set for *table* are left to produce a XML value for *element*.

**Explanation:** This error condition is usually caused by a missing multi\_occurrence = YES specification on the parent element\_node of the given element or attribute.

**User response:** Check the DAD that the value of multi\_occurrence on the parent element\_node correctly reflects the multiplicity of child element\_nodes.

---

**DXXQ063E** The multi\_occurrence attribute value on *elementname* in the DAD file is invalid.

**Explanation:** The value of the multi\_occurrence attribute on the specified element\_node in the document access definition (DAD) file is wrong or missing. The value must be 'yes' or 'no', case insensitive.

**User response:** Ensure that the multi\_occurrence

attribute is specified correctly in the DAD file.

---

**DXXQ064E** Column *column* not found in foreign table *table*.

**Explanation:** A key column specified in the join condition was not mapped to any element or attribute node.

**User response:** Check to make sure the join condition specified in the DAD file is correct, and all key columns are mapped to element or attribute nodes.

---

**DXXQ065I** All triggers relating to XML enabled columns have been successfully regenerated.

**Explanation:** This is an informational message only.

**User response:** No action required.

---

**DXXQ066E** The primary key for table *tablename* does not exist.

**Explanation:** XML Extender could not determine the primary key for table *tablename*. Check that the primary key for the table was not dropped after the column was enabled for XML.

**User response:** Alter the table to add the primary key specified as the ROOT ID when the column was enabled for XML.

---

**DXXQ067E** Attempt to *action* failed.

**Explanation:** While attempting to *action*, a SQL error occurred.

**User response:** Contact your Software Service Provider. When reporting the error, be sure to include the XML Extender trace file.

---

**DXXQ068E** Cannot set current SQLID to [userid]. SQLCODE = [sqlcode].

**Explanation:** While attempting to set current sqlid to a secondary authorization id, a SQL error occurred.

**User response:** Check that you are specifying a valid secondary authorization id and that you have authorization for the id.

---

**DXXQ069E** Cannot find element/attribute *xmlitemname* mapped to table *tablename* as foreign key for table *tab2name*.

**Explanation:** The mapping, including multi-occurrence usage, as specified by the DAD does not allow the value of *xmlitemname* to be used to populate a foreign key value of *tab2name*.

**User response:** Check the following: join condition involving the two tables; the value of multi\_occurrence

| attribute of the highest level element mapping to  
| *tablename* and its wrapper; the presence of other items  
| that is a child of an ancestor of *xmliitemname* mapping  
| to a different table than *tablename*.

---

| **DXXQ070E** Cannot open trace file *tracefile* for  
| output.

| **Explanation:** The open of the trace file failed.

| **User response:** Ensure that the process writing the  
| trace file has write permission and that the file resides  
| on a read/write file system.

---

| **DXXQ071E** The number of mapped LOB columns  
| that is allowed for a composition  
| exceeds the maximum of *loblimit*.

| **Explanation:** The number of mapped LOB columns  
| that is specified in a composition DAD exceeds the  
| maximum number allowed. Reduce the number of LOB  
| columns.

| **User response:** Check whether the LOB columns that  
| are specified in the DAD have exceeded the maximum  
| number. If the limit has not been exceeded, contact  
| your Software Service Provider. When reporting the  
| error, include all messages, trace files, and information  
| on how to reproduce the problem such as input DADs  
| and table definitions.

---

| **DXXQ072E** XML Extender for iSeries requires the  
| XML Toolkit for iSeries (*prodid*) with  
| installation of option *parseropt*.

| **Explanation:** The XML Extender uses the XML Parser  
| that is delivered with the XML Toolkit for iSeries.

| **User response:** Install the XML Toolkit for iSeries with  
| the required option.

---

| **DXXQ073E** The database is not enabled.

| **Explanation:** The *dxxadm* administration command  
| was executed on a database that was not enabled.

| **User response:** Check that the database has been  
| enabled. If the database is not XML-enabled, you do  
| not need to disable it.



---

## Part 5. Appendixes



---

## Appendix A. Samples

This appendix shows the sample objects that are used with examples in this book.

- “XML DTD sample”
- “XML document sample: getstart.xml”
- “Document access definition files” on page 231
  - “Sample DAD file: XML column” on page 232
  - “Sample DAD file: XML collection: SQL mapping” on page 232
  - “Sample DAD file: XML: RDB\_node mapping” on page 234

---

### XML DTD sample

The following DTD is used for the getstart.xml document that is referenced throughout this guide.

```
<!xml encoding="US-ASCII"?>

<!ELEMENT Order (Customer, Part+)>
<!ATTLIST Order key CDATA #REQUIRED>
<!ELEMENT Customer (Name, Email)>
<!ELEMENT Name (#PCDATA)>
<!ELEMENT Email (#PCDATA)>
<!ELEMENT Part (key, Quantity, ExtendedPrice, Tax, Shipment+)>
<!ELEMENT key (#PCDATA)>
<!ELEMENT Quantity (#PCDATA)>
<!ELEMENT ExtendedPrice (#PCDATA)>
<!ELEMENT Tax (#PCDATA)>
<!ATTLIST Part color CDATA #REQUIRED>
<!ELEMENT Shipment (ShipDate, ShipMode)>
<!ELEMENT ShipDate (#PCDATA)>
<!ELEMENT ShipMode (#PCDATA)>
```

*Figure 15. Sample XML DTD: getstart.dtd*

---

### XML document sample: getstart.xml

The following XML document, getstart.xml, is the sample XML document that is used in examples throughout this guide. It contains XML tags to form a purchase order.

```

<?xml version="1.0"?>
<!DOCTYPE Order SYSTEM "dxxsamples/dtd/getstart.dtd">
<Order key="1">
 <Customer>
 <Name>American Motors</Name>
 <Email>parts@am.com</Email>
 </Customer>
 <Part color="black ">
 <key>68</key>
 <Quantity>36</Quantity>
 <ExtendedPrice>34850.16</ExtendedPrice>
 <Tax>6.000000e-02</Tax>
 <Shipment>
 <ShipDate>1998-08-19</ShipDate>
 <ShipMode>BOAT </ShipMode>
 </Shipment>
 <Shipment>
 <ShipDate>1998-08-19</ShipDate>
 <ShipMode>AIR </ShipMode>
 </Shipment>
 </Part>
 <Part color="red ">
 <key>128</key>
 <Quantity>28</Quantity>
 <ExtendedPrice>38000.00</ExtendedPrice>
 <Tax>7.000000e-02</Tax>
 <Shipment>
 <ShipDate>1998-12-30</ShipDate>
 <ShipMode>TRUCK </ShipMode>
 </Shipment>
 </Part>
</Order>

```

Figure 16. Sample XML document: *getstart.xml*

---

## Stylesheet sample: *getstart.xsl*

The following XML stylesheet, *getstart.xsl*, is the sample stylesheet that is included in the samples directory of DB2.

```

| <?xml version="1.0" encoding="UTF-8"?>
| <xsl:stylesheet version="1.0" xmlns:xsl="http://www.w3.org/1999/XSL/Transform">
|
| <xsl:template match="/">
| <html>
| <head/>
| <body>
|
| <ol style="list-style:decimal outside">
| <xsl:for-each select="Order">
| Orderkey : <xsl:value-of select="@key"/>

|
| <xsl:for-each select="Customer">
| Customer

| <xsl:for-each select="Name | Email">
| <xsl:value-of select="name()"/><xsl:text> : </xsl:text><xsl:value-of select="."/>
| <xsl:text>, </xsl:text>
| </xsl:for-each>
| </xsl:for-each>
|
|

| <ol type="A">
| <xsl:for-each select="Part">
| Parts

| Color : <xsl:value-of select="@color"/><xsl:text>, </xsl:text>
|
| <xsl:for-each select="key | Quantity | ExtendedPrice | Tax">
| <xsl:value-of select="name()"/><xsl:text> : </xsl:text><xsl:value-of select="."/>
| <xsl:text>, </xsl:text>
| </xsl:for-each>
|
|

| <ol type="a">
| <xsl:for-each select="Shipment">
| Shipment

| <xsl:for-each select="ShipDate | ShipMode">
| <xsl:value-of select="name()"/><xsl:text> : </xsl:text><xsl:value-of select="."/>
| <xsl:text>, </xsl:text>
| </xsl:for-each>
|
| </xsl:for-each>
|
|

|
| </xsl:for-each>
|
|
| </xsl:for-each>
|
|
| </body>
| </html>
| </xsl:template>
| </xsl:stylesheet>

```

Figure 17. Sample stylesheet: *getstart.xsl*

---

## Document access definition files

The following sections contain document access definition (DAD) files that map XML data to DB2 UDB relational tables, using either XML column or XML collection access modes.

- “Sample DAD file: XML column” on page 232

- “Sample DAD file: XML collection: SQL mapping” shows a DAD file for an XML collection using SQL mapping.
- “Sample DAD file: XML: RDB\_node mapping” on page 234 show a DAD for an XML collection that uses RDB\_node mapping.

## Sample DAD file: XML column

This DAD file contains the mapping for an XML column, and it defines the table, side tables, and columns that are to contain the XML data.

```
<?xml version="1.0"?>
<!DOCTYPE Order SYSTEM "dxsamples/dtd/dad.dtd">
<DAD>
 <dtdid>
 "dxsamples/dtd/getstart.dtd"</dtdid>
 <validation>YES</validation>

 <Xcolumn>
 <table name="order_side_tab">
 <column name="order_key"
 type="integer"
 path="/Order/@Key"
 multi_occurrence="NO"/>
 <column name="customer"
 type="varchar(50)"
 path="/Order/Customer/Name"
 multi_occurrence="NO"/>
 </table>
 <table name="part_side_tab">
 <column name="price"
 type="decimal(10,2)"
 path="/Order/Part/ExtendedPrice"
 multi_occurrence="YES"/>
 </table>
 <table name="ship_side_tab">
 <column name="date"
 type="DATE"
 path="/Order/Part/Shipment/ShipDate"
 multi_occurrence="YES"/>
 </table>
 </Xcolumn>
</DAD>
```

Figure 18. Sample DAD file for an XML column: *getstart\_xcolumn.dad*

## Sample DAD file: XML collection: SQL mapping

This DAD file contains an SQL statement that specifies the DB2 UDB tables, columns, and conditions that are to contain the XML data.

```

<?xml version="1.0"?>
<!DOCTYPE DAD SYSTEM "/dxxsamples/dtd/dad.dtd">
<DAD>
<validation>NO</validation>
<Xcollection>
<SQL_stmt>SELECT o.order_key, customer_name, customer_email, p.part_key, color,
quantity, price, tax, ship_id, date, mode from order_tab o, part_tab p,
(select db2xml.generate_unique()
as ship_id, date, mode, part_key from ship_tab) ass
p.price > 20000 and
p.order_key = o.order_key and
s.part_key = p.part_key
ORDER BY order_key, part_key, ship_id</SQL_stmt>
<prolog>?xml version="1.0"?</prolog>
<doctype>!DOCTYPE Order SYSTEM "
/dxxsamples/dtd/getstart.dtd"</doctype>

```

Figure 19. Sample DAD file for an XML collection using SQL mapping: order\_sql.dad (Part 1 of 2)

```

<root_node>
<element_node name="Order">
<attribute_node name="key">
<column name="order_key"/>
</attribute_node>
<element_node name="Customer">
<element_node name="Name">
<text_node><column name="customer_name"/></text_node>
</element_node>
<element_node name="Email">
<text_node><column name="customer_email"/></text_node>
</element_node>
</element_node>
<element_node name="Part">
<attribute_node name="color">
<column name="color"/>
</attribute_node>
<element_node name="key">
<text_node><column name="part_key"/></text_node>
</element_node>
<element_node name="Quantity">
<text_node><column name="quantity"/></text_node>
</element_node>
<element_node name="ExtendedPrice">
<text_node><column name="price"/></text_node>
</element_node>
<element_node name="Tax">
<text_node><column name="tax"/></text_node>
</element_node>
<element_node name="Shipment" multi_occurrence="YES">
<element_node name="ShipDate">
<text_node><column name="date"/></text_node>
</element_node>
<element_node name="ShipMode">
<text_node><column name="mode"/></text_node>
</element_node>
</element_node>
</element_node>
</root_node>
</Xcollection>
</DAD>

```

Figure 19. Sample DAD file for an XML collection using SQL mapping: order\_sql.dad (Part 2 of 2)

## Sample DAD file: XML: RDB\_node mapping

This DAD file uses <RDB\_node> elements to define the DB2 UDB tables, columns, and conditions that are to contain XML data.

```
<?xml version="1.0"?>
<!DOCTYPE DAD SYSTEM "SQLLIB/samples/db2xml/dtd/dad.dtd">
<DAD>
 <dtdid>E:\dtd\lineItem.dtd</dtdid>
 <validation>YES</validation>
 <Xcollection>
 <prolog>?xml version="1.0"?</prolog>
 <doctype>!DOCTYPE Order SYSTEM
 "SQLLIB/samples/db2xml/dtd/getstart.dtd"</doctype>

 <root_node>
 <element_node name="Order">
 <RDB_node>
 <table name="order_tab"/>
 <table name="part_tab"/>
 <table name="ship_tab"/>
 <condition>order_tab.order_key=part_tab.order_key AND
 part_tab.part_key=ship_tab.part_key </condition>
 </RDB_node>
 <attribute_node name="Key">
 <RDB_node>
 <table name="order_tab"/>
 <column name="order_key"/>
 </RDB_node>
 </attribute_node>
 <element_node name="Customer">
 <element_node name="Name">
 <text_node>
 <RDB_node>
 <table name="order_tab"/>
 <column name="customer_name"/>
 </RDB_node>
 </text_node>
 </element_node>
 <element_node name="Email">
 <text_node>
 <RDB_node>
 <table name="order_tab"/>
 <column name="customer_email"/>
 </RDB_node>
 </text_node>
 </element_node>
 </element_node>
 <element_node name="Part">
 <attribute_node name="Key">
 <RDB_node>
 <table name="part_tab"/>
 <column name="part_key"/>
 </RDB_node>
 </attribute_node>
 <element_node name="ExtendedPrice">
 <text_node>
 <RDB_node>
 <table name="part_tab"/>
 <column name="price"/>
 <condition>price > 2500.00</condition>
 </RDB_node>
 </text_node>
 </element_node>
 <element_node name="Tax">
 <text_node>
 <RDB_node>
 <table name="part_tab"/>

```



```

 <column name="tax"/>
 </RDB_node>
 </text_node>
 </element_node>

 <element_node name="Quantity">
 <text_node>
 <RDB_node>
 <table name="part_tab"/>
 <column name="qty"/>
 </RDB_node>
 </text_node>
 </element_node>
 <element_node name="Shipment" multi_occurrence="YES">
 <element_node name="ShipDate">
 <text_node>
 <RDB_node>
 <table name="ship_tab"/>
 <column name="date"/>
 <condition>date > '1966-01-01'</condition>
 </RDB_node>
 </text_node>
 </element_node>
 <element_node name="ShipMode">
 <text_node>
 <RDB_node>
 <table name="ship_tab"/>
 <column name="mode"/>
 </RDB_node>
 </text_node>
 </element_node>
 <element_node name="Comment">
 <text_node>
 <RDB_node>
 <table name="ship_tab"/>
 <column name="comment"/>
 </RDB_node>
 </text_node>
 </element_node>
 </element_node> <!-- end of element Shipment-->
</element_node> <!-- end of element Part -->
</element_node> <!-- end of element Order -->
</root_node>

</Xcollection>

</DAD>

```



---

## Appendix B. Code page considerations

XML documents and other related files must be encoded properly for each client or server that accesses the files. The XML Extender makes some assumptions when processing a file, you need to understand how it handles code page conversions. The primary considerations are:

- Ensuring that the actual code page of the client retrieving an XML document from DB2 UDB matches the encoding of the document.
- Ensuring that, when the document is processed by an XML parser, the encoding declaration of the XML document is also consistent with the document's actual encoding.
- Ensuring that the locales are configured properly.

For i5/OS, the job, DB2 UDB, and the XML document must all have the same CCSID. The following section describes methods for ensuring that the CCSIDs are consistent.

---

### Configuring locale settings

The XML Extender selects completion and error messages from a message catalog based on your locale settings. To receive the messages in your language, you must install the XML Extender message catalog, and have the locale set up correctly. XML Extender installs the message catalog for your language in the IFS directory, /QIBM/ProdData/DB2Extenders/XML/MRIxxxx, where xxxx is the language code.

For example, the message catalog for English, 2924, is installed in the directory: /QIBM/ProdData/DB2Extenders/XML/MRI2924/dxx.cat. To have the English 2924 message catalog selected by XML Extender, set up the user profile, using the **WRKUSRPRF** command:

```
Language ID LANGID ENU
Country/Region ID CNTRYID US
Coded character set ID CCSID 037
```

All instances of XML Extender running under this user profile will use the MRI2924 message catalog.

---

### Encoding declaration considerations for XML Extender

The *encoding declaration* specifies the code page of the XML document's encoding and appears on the XML declaration statement. When using XML Extender, it is important to ensure that the encoding of the document matches the job and DB2.

### Consistent encodings and encoding declarations

When an XML document is processed or exchanged with another system, it is important that the encoding declaration corresponds to the actual encoding of the document. Ensuring that the encoding of a document is consistent with the client is important because XML tools, like parsers, generate an error for an entity that includes an encoding declaration other than that named in the declaration.

The consequences of having different code pages are the following possible situations:

- A conversion in which data is lost might occur.

- The declared encoding of the XML document might no longer be consistent with the actual document encoding, if the document is retrieved by a client with a different code page than the declared encoding of the document.

## Declaring an encoding

The default value of the encoding declaration is UTF-8, and the absence of an encoding declaration means the document is in UTF-8.

### To declare an encoding value:

In the XML document declaration specify the encoding declaration with the name of the code page of the client. For example:

```
<?xml version="1.0" encoding="UTF-8" ?>
```

---

## Recommendations for preventing inconsistent XML documents

Use one of the following recommendations for ensuring that the XML document encoding is consistent with the client code page, before handing the document to an XML processor, such as a parser:

- When exporting a document from the database using the XML Extender UDFs, try one of the following techniques (assuming XML Extender has exported the file, in the server code page, to the file system on the server):
  - Convert the document to the declared encoding code page
  - Override the declared encoding, if the tool has an override facility
  - Manually change the encoding declaration of the exported document to the document's actual encoding (that is, the server code page)
- When exporting a document from the database using the XML Extender stored procedures, try one of the following techniques (assuming the client is querying the result table, in which the composed document is stored):
  - Convert the document to the declared encoding code page
  - Override the declared encoding, if the tool has an override facility
  - Before running the stored procedure, have the client set the CCSID variable to force the client code page to a code page that is compatible with the encoding declaration of the XML document.
  - Manually change the encoding declaration of the exported document to the document's actual encoding (that is, the client code page)

---

## Appendix C. XML Extender limits

This topic describes the limits for:

- XML Extender objects
- Values returned by user-defined functions
- Stored procedures parameters
- Administration support table columns
- Composition and decomposition
- The DB2DXX\_MIN\_TMPFILE\_SIZE environment variable

The following table describes the limits for XML Extender objects.

*Table 68. Limits for XML Extender objects*

Object	Limit
Maximum number of rows in a table in a decomposition XML collection	10240 rows from each decomposed XML document
Maximum characters in a column name specified in a default view	10 characters
Maximum bytes in XML file path name specified as a parameter value	512 bytes
Length of the sql_stmt element in a DAD file for SQL composition	Windows and UNIX operating systems: 32,765 bytes. OS/390 and iSeries operating systems: 16,380 bytes.
Maximum number of columns for one table that are specified for one table in the DAD file for RDB_node decomposition	500 columns (columns for a table) are specified by text_node and attribute_node elements in a DAD file.
Maximum number of columns in a table that can be mapped in a DAD Xcollection	Each table that is mapped in a Xcollection in the DAD file can have a maximum of 500 columns mapped to either text or attribute nodes. If you map to more than 500 columns in a table, DB2 issues message DXXQ039E, "Too many columns specified for a table in the DAD file."

The following table describes the limits values returned by XML Extender user-defined functions.

*Table 69. Limits for user-defined function value*

User-defined functions returned values	Limit
Maximum bytes returned by an extractCHAR UDF	254 bytes
Maximum bytes returned by an extractCLOB UDF	2 gigabytes
Maximum bytes returned by an extractVARCHAR UDF	4 kilobytes

The following table describes the limits for parameters of XML Extender stored procedures.

*Table 70. Limits for stored procedure parameters*

Stored procedure parameters	Limit
Maximum size of an XML document CLOB <sup>1</sup>	1 MB
Maximum size of a Document Access Definition (DAD) CLOB <sup>1</sup>	100 KB
Maximum size of <i>collectionName</i>	30 bytes
Maximum size of <i>colName</i>	30 bytes
Maximum size of <i>dbName</i>	8 bytes
Maximum size of <i>defaultView</i>	128 bytes
Maximum size of <i>rootID</i>	30 bytes
Maximum size of <i>resultTabName</i>	18 bytes
Maximum size of <i>tablespace</i>	8 bytes
Maximum size of <i>tbName</i> <sup>2</sup>	18 bytes
Maximum size of <i>resultColumn</i>	30 bytes
Maximum size of <i>validColumn</i>	30 bytes
Maximum size of <i>varchar_value</i>	16366 bytes

**Notes:**

1. This size can be changed for `dxxGenXMLClob` and `dxxRetrieveXMLCLOB`.
2. If the value of the `tbName` parameter is qualified by a schema name, the entire name (including the separator character) must be no longer than 128 bytes.

The following table describes the limits for the DB2XML.DTD\_REF table.

*Table 71. XML Extender limits*

DB2XML.DTD_REF table columns	Limit
Size of AUTHOR column	128 bytes
Size of CREATOR column	128 bytes
Size of UPDATOR column	128 bytes
Size of DTDID column	128 bytes
Size of CLOB column	100 KB

Names can undergo expansion when DB2 UDB converts them from the client code page to the database code page. A name might fit within the size limit at the client, but exceed the limit when the stored procedure gets the converted name.

The following table describes limits for composition and decomposition.

*Table 72. Limits for XML Extender composition and decomposition*

Object	Limit
Maximum number of rows inserted into a table in a decomposition XML collection	500736 rows from each decomposed XML document
Maximum length of the name attribute in <code>elements_node</code> or <code>attribute_node</code> within a DAD	63 bytes

Table 72. Limits for XML Extender composition and decomposition (continued)

Object	Limit
Maximum characters in a column name specified in a default view	10 characters
Maximum bytes in XMLFile path name specified as a parameter value	512 bytes
Maximum number of columns in a key	16 columns

### The DB2DXX\_MIN\_TMPFILE\_SIZE environment variable

XML Extender places large documents in temporary files to avoid using too much memory during processing. On systems with large amounts of physical memory, it is possible to avoid moving documents to temporary files, reducing the amount of input/output activity. The environment variable DB2DXX\_MIN\_TMPFILE\_SIZE instructs XML Extender to use memory buffers, rather than temporary files, for processing documents smaller than the specified value. The variable is applicable only on the server, not on a client. If multiple physical nodes participate in a multi-node partition, you can set the variable differently for each node, accurately reflecting the amount of memory that is installed on each system. If you do not set this variable, documents that exceed 128 KB are automatically placed into temporary files during processing, while documents smaller than 128 KB are processed in memory.





---

## XML Extender glossary

**absolute location path.** The full path name of an object. The absolute path name begins at the highest level, or "root" element, which is identified by the forward slash (/) or back slash (\) character.

**access and storage method.** Associates XML documents to a DB2 UDB database through two major access and storage methods: XML columns and XML collections. See also *XML column* and *XML collection*.

**access function.** A user-provided function that converts the data type of text stored in a column to a type that can be processed by Net Search Extender.

**administration.** The task of preparing text documents for searching, maintaining indexes, and getting status information.

**administrative support table.** One of the tables that are used by a DB2 UDB extender to process user requests on image, audio, and video objects. Some administrative support tables identify user tables and columns that are enabled for an extender. Other administrative support tables contain attribute information about objects in enabled columns. Also called a *metadata table*.

**administrative support tables.** A tables used by a DB2 UDB extender to process user requests on XML objects. Some administrative support tables identify user tables and columns that are enabled for an extender. Other administrative support tables contain attribute information about objects in enabled columns. Synonymous with metadata table.

**analyze.** To calculate numeric values for the features of an image and add the values to a QBIC catalog.

**API.** See *application programming interface*.

**application programming interface (API).**

- (1) A functional interface supplied by the operating system or by a separately orderable licensed program. An API allows an application program that is written in a high-level language to use specific data or functions of the operating system or the licensed programs.
- (2) In DB2, a function within the interface, for example, the get error message API.
- (3) The DB2 UDB extenders provide APIs for requesting user-defined functions, administrative operations, display operations, and video scene change detection. The DB2 Net Search Extender provides APIs for requesting user-defined functions, administrative operations, and information retrieval services. In DB2, a function within the interface. For example, the get error message API.

**attribute.** See *XML attribute*.

**attribute\_node.** A representation of an attribute of an element.

**binary large object (BLOB).** A binary string whose length can be up to 2 GB. Image, audio, and video objects are stored in a DB2 database as BLOBs.

**Boolean search.** A search in which one or more search terms are combined using Boolean operators.

**bound search.** A search in Korean documents that respects word boundaries.

**browse.** To view text displayed on a computer monitor.

**browser.** A Net Search Extender function that enables you to display text on a computer monitor. See *Web browser*.

**B-tree indexing.** The native index scheme provided by the DB2 UDB engine. It builds index entries in the B-tree structure. Supports DB2 base data types.

**cast function.** A function that is used to convert instances of a (source) data type into instances of a different (target) data type. In general, a cast function has the name of the target data type. It has one single argument whose type is the source data type; its return type is the target data type.

**catalog view.** A view of a system table created by Net Search Extender for administration purposes. A catalog view contains information about the tables and columns that have been enabled for use by Net Search Extender.

**CCSID.** Coded Character Set Identifier.

**character large object (CLOB).** A character string of single-byte characters, where the string can be up to 2 GB. CLOBs have an associated code page. Text objects that contain single-byte characters are stored in a DB2 UDB database as CLOBs.

**CLOB.** Character large object.

**code page.** An assignment of graphic characters and control function meanings to all code points. For example, assignment of characters and meanings to 256 code points for an 8-bit code.

**column data.** The data stored inside of a DB2 UDB column. The type of data can be any data type supported by DB2.

**command line processor.** A program called DB2TX that:

- Allows you to enter Net Search Extender commands
- Processes the commands
- Displays the result.

**compose.** To generate XML documents from relational data in an XML collection.

**condition.** A specification of either the criteria for selecting XML data or the way to join the XML collection tables.

**DAD.** See *Document access definition*.

**data interchange.** The sharing of data between applications. XML supports data interchange without needing to go through the process of first transforming data from a proprietary format.

**data source.** A local or remote relational or nonrelational data manager that is capable of supporting data access via an ODBC driver that supports the ODBC APIs.

**data stream.** Information returned by an API function, comprising text (at least one paragraph) containing the term searched for, and information for highlighting the found term in that text.

**data type.** An attribute of columns and literals.

**database partition.** A part of the database that consists of its own user data, indexes, configuration files, and transaction logs. Sometimes called a node or database node.

**database partition server.** Manages a *database partition*. A database partition server is composed of a database manager and the collection of data and system resources that it manages. Typically, one database partition server is assigned to each system.

**DBCLOB.** Double-byte character large object.

**DBCS.** Double-byte character support.

**decompose.** Separates XML documents into a collection of relational tables in an XML collection.

**default casting function.** Casts the SQL base type to a UDT.

**default view.** A representation of data in which an XML table and all of its related side tables are joined.

**disable.** To restore a database, a text table, or a text column, to its condition before it was enabled for XML Extender by removing the items created during the enabling process.

**distinct type.** See *user-defined type*.

**document.** See *text document*.

**Document Access Definition (DAD).** Used to define the indexing scheme for an XML column or mapping scheme of an XML collection. It can be used to enable an XML Extender column of an XML collection, which is XML formatted.

**Document type definition (DTD).** A set of declarations for XML elements and attributes. The DTD defines what elements are used in the XML document, in what order they can be used, and which elements can contain other elements. You can associate a DTD with a document access definition (DAD) file to validate XML documents.

**double-byte character large object (DBCLOB).** A character string of double-byte characters, or a combination of single-byte and double-byte characters, where the string can be up to 2 GB. DBCLOBs have an associated code page. Text objects that include double-byte characters are stored in a DB2 UDB database as DBCLOBs.

**DTD.** (1) . (2) See *Document type definition*.

**DTD reference table (DTD\_REF table).** A table that contains DTDs, which are used to validate XML documents and to help applications to define a DAD. Users can insert their own DTDs into the DTD\_REF table. This table is created when a database is enabled for XML.

**DTD\_REF table.** DTD reference table.

**DTD repository.** A DB2 UDB table, called DTD\_REF, where each row of the table represents a DTD with additional metadata information.

**EDI.** Electronic Data Interchange.

**Electronic Data Interchange (EDI).** A standard for electronic data interchange for business-to-business (B2B) applications.

**element.** See *XML element*.

**element\_node.** A representation of an element. An element\_node can be the root element or a child element.

**embedded SQL.** SQL statements coded within an application program. See *static SQL*.

**enable.** To prepare a database, a text table, or a text column, for use by XML Extender.

**escape character.** A character indicating that the subsequent character is not to be interpreted as a *masking character*.

**expand.** The action of adding to a search term additional terms derived from a thesaurus.

**Extensible Stylesheet language (XSL).** A language used to express stylesheets. XSL consists of two parts: a language for transforming XML documents, and an XML vocabulary for specifying formatting semantics.

**Extensible Stylesheet Language Transformation (XSLT).** A language used to transform XML documents into other XML documents. XSLT is designed for use as part of XSL, which is a stylesheet language for XML.

**external file.** A text document in the form of a file stored in the operating system's file system, rather than in the form of a cell in a table under the control of DB2. A file that exists in a file system external to DB2.

**file reference variable.** A programming variable that is useful for moving a LOB to and from a file on a client workstation.

**foreign key.** A key that is part of the definition of a referential constraint and that consists of one or more columns of a dependent table.

**function.** See *access function*.

**gigabyte (GB).** One billion (10<sup>9</sup>) bytes. When referring to memory capacity, 1 073 741 824 bytes.

**host variable.** A variable in an application program that can be referred to in embedded SQL statements. Host variables are the primary mechanism for transmitting data between a database and application program work areas.

**image.** An electronic representation of a picture.

**index.** To extract significant terms from text, and store them in a *text index*. A set of pointers that are logically ordered by the values of a key. Indexes provide quick access to data and can enforce uniqueness on the rows in the table.

**Java Database Connectivity (JDBC).** An application programming interface (API) that has the same characteristics as Open Database Connectivity (ODBC) but is specifically designed for use by Java database applications. Also, for databases that do not have a JDBC driver, JDBC includes a JDBC to ODBC bridge, which is a mechanism for converting JDBC to ODBC; JDBC presents the JDBC API to Java database applications and converts this to ODBC. JDBC was developed by Sun Microsystems, Inc. and various partners and vendors.

**JDBC.** Java Database Connectivity.

**join.** A relational operation that allows for retrieval of data from two or more tables based on matching column values.

**joined view.** A DB2 UDB view created by the "CREATE VIEW" statement which join one more tables together.

**kilobyte (KB).** One thousand ( $10^3$ ) bytes. When referring to memory capacity, 1024 bytes.

**large object (LOB).** A sequence of bytes, where the length can be up to 2 GB. A LOB can be of three types: *binary large object (BLOB)*, *character large object (CLOB)*, or *double-byte character large object (DBCLOB)*.

**linguistic index.** A *text index* containing terms that have been reduced to their base form by linguistic processing. "Mice", for example, would be indexed as "mouse". See also *precise index*, *Ngram index*, and *dual index*.

**LOB.** Large object.

**LOB locator.** A small (4-byte) value stored in a host variable that can be used in a program to refer to a much larger LOB in a DB2 UDB database. Using a LOB locator, a user can manipulate the LOB as if it was stored in a regular host variable, and without the need to transport the LOB between the application on the client system and the database server.

**local file system.** A file system that exists in DB2

**location path.** Location path is a sequence of XML tags that identify an XML element or attribute. The location path identifies the structure of the XML document, indicating the context for the element or attribute. A single slash (/) path indicates that the context is the whole document. The location path is used in the extracting UDFs to identify the elements and attributes to be extracted. The location path is also used in the DAD file to specify the mapping between an XML element, or attribute, and a DB2 UDB column when defining the indexing scheme for XML column. Additionally, the location path is used by the Net Search Extender for structural-text search.

**locator.** A pointer which can be used to locate an object. In DB2, the large object block (LOB) locator is the data type which locates LOBs.

**mapping scheme.** A definition of how XML data is represented in a relational database. The mapping scheme is specified in the DAD. The XML Extender provides two types of mapping schemes: *SQL mapping* and *relational database node (RDB\_node) mapping*.

**megabyte (MB).** One million ( $10^6$ ) bytes. When referring to memory capacity, 1 048 576 bytes.

**metadata table.** See *administrative support table*.

**multiple occurrence.** An indication of whether a column element or attribute can be used more than once in a document. Multiple occurrence is specified in the DAD.

**object.** In object-oriented programming, an abstraction consisting of data and the operations associated with that data.

**ODBC.** Open Database Connectivity.

**Open Database Connectivity.** A standard application programming interface (API) for accessing data in both relational and nonrelational database management systems. Using this API, database applications can access data stored in database management systems on a variety of computers even if each database management system uses a

different data storage format and programming interface. ODBC is based on the call level interface (CLI) specification of the X/Open SQL Access Group and was developed by Digital Equipment Corporation (DEC), Lotus, Microsoft, and Sybase. Contrast with *Java Database Connectivity*.

**overloaded function.** A function name for which multiple function instances exist.

**path expression.** See *location path*.

**predicate.** An element of a search condition that expresses or implies a comparison operation.

**primary key.** A unique key that is part of the definition of a table. A primary key is the default parent key of a referential constraint definition.

**procedure.** See *stored procedure*.

**QBIC catalog.** A repository that holds data about the visual features of images.

**query object.** An object that specifies the features, feature, values, and feature weights for a QBIC query. The object can be named and saved for subsequent use in a QBIC query. Contrast with query string

**RDB\_node.** Relational database node.

**RDB\_node mapping.** The location of the content of an XML element, or the value of an XML attribute, which are defined by the RDB\_node. The XML Extender uses this mapping to determine where to store or retrieve the XML data.

**relational database node (RDB\_node).** A node that contains one or more element definitions for tables, optional columns, and optional conditions. The tables and columns are used to define how the XML data is stored in the database. The condition specifies either the criteria for selecting XML data or the way to join the XML collection tables.

**result set.** A set of rows returned by a stored procedure.

**result table.** A table which contains rows as the result of an SQL query or an execution of a stored procedure.

**root element.** The top element of an XML document.

**root ID.** A unique identifier that associates all side tables with the application table.

**SBCS.** Single-byte character support.

**scalar function.** An SQL operation that produces a single value from another value and is expressed as a function name, followed by a list of arguments enclosed in parentheses.

**schema.** A collection of database objects such as tables, views, indexes, or triggers. It provides a logical classification of database objects.

**search argument.** The conditions specified when making a search, consisting of one or several search terms, and search parameters.

**section search.** Provides the text search within a section which can be defined by the application. To support the structural text search, a section can be defined by the Xpath's abbreviated location path.

**shot catalog.** A database table or file that is used to store data about shots, such as the starting and ending frame number for a shot, in a video clip. A user can access a view of the table through an SQL query, or access the data in the file.

**side table.** Additional tables created by the XML Extender to improve performance when searching elements or attributes in an XML column.

**simple location path.** A sequence of element type names connected by a single slash (/).

**SQL mapping.** A definition of the relationship of the content of an XML element or value of an XML attribute with relational data, using one or more SQL statements and the XSLT data model. The XML Extender uses the definition to determine where to store or retrieve the XML data. SQL mapping is defined with the `SQL_stmt` element in the DAD.

**static SQL.** SQL statements that are embedded within a program, and are prepared during the program preparation process before the program is executed. After being prepared, a static SQL statement does not change, although values of host variables specified by the statement might change.

**stored procedure.** A block of procedural constructs and embedded SQL statements that is stored in a database and can be called by name. Stored procedures allow an application program to be run in two parts. One part runs on the client and the other part runs on the server. This allows one call to produce several accesses to the database.

**structural text index.** To index text keys based on the tree structure of the XML document, using the DB2 UDB Net Search Extender.

**subquery.** A full SELECT statement that is used within a search condition of an SQL statement.

**table space.** An abstraction of a collection of containers into which database objects are stored. A table space provides a level of indirection between a database and the tables stored within the database. A table space:

- Has space on media storage devices assigned to it.
- Has tables created within it. These tables will consume space in the containers that belong to the table space. The data, index, long field, and LOB portions of a table can be stored in the same table space, or can be individually broken out into separate table spaces.

**terabyte.** A trillion ( $10^{12}$ ) bytes. Ten to the twelfth power bytes. When referring to memory capacity, 1 099 511 627 776 bytes.

**text\_node.** A representation of the CDATA text of an element.

**text table.** A DB2 UDB table containing *text columns*.

**top element\_node.** A representation of the root element of the XML document in the DAD.

**tracing.** The action of storing information in a file that can later be used in finding the cause of an error.

**trigger.** The definition of a set of actions to be taken when a table is changed. Triggers can be used to perform actions such as validating input data, automatically generating a value for a newly inserted row, reading from other tables for cross-referencing purposes, or writing to other tables for auditing purposes. Triggers are often used for integrity checking or to enforce business rules.

**trigger.** A mechanism that automatically adds information about documents that need to be indexed to a *log table* whenever a document is added, changed, or deleted from a text column.

**UDF.** See *user-defined function*.

**UDT.** See *user-defined type*.

**uniform resource locator (URL).** An address that names an HTTP server and optionally a directory and file name, for example: `http://www.ibm.com/software /data/db2/extenders`.

**UNION.** An SQL operation that combines the results of two select statements. UNION is often used to merge lists of values that are obtained from several tables.

**URL.** Uniform resource locator.

**user-defined distinct type (UDT).** A data type created by a user of DB2, in contrast to a data type provided by DB2 UDB such as LONG VARCHAR.

**user-defined function (UDF).** A function that is defined by a user to DB2. Once defined, the function can be used in SQL queries. and video objects. For example, UDFs can be created to get the compression format of a video or return the sampling rate of an audio. This provides a way of defining the behavior of objects of a particular type.

**user-defined function (UDF).** An SQL function created by a user of DB2, in contrast to an SQL function provided by DB2. Net Search Extender provides search functions, such as CONTAINS, in the form of UDFs.

**user-defined type (UDT).** A data type that is defined by a user to DB2. UDTs are used to differentiate one LOB from another. For example, one UDT can be created for image objects and another for audio objects. Though stored as BLOBs, the image and audio objects are treated as types distinct from BLOBs and distinct from each other.

**user-defined function (UDF).** A function that is defined to the database management system and can be referenced thereafter in SQL queries. It can be one of the following functions:

- An external function, in which the body of the function is written in a programming language whose arguments are scalar values, and a scalar result is produced for each invocation.
- A sourced function, implemented by another built-in or user-defined function that is already known to the DBMS. This function can be either a scalar function or column (aggregating) function, and returns a single value from a set of values (for example, MAX or AVG).

**user-defined type (UDT).** A data type that is not native to the database manager and was created by a user. See *distinct type*.

**user table.** A table that is created for and used by an application.

**validation.** The process of using a DTD to ensure that the XML document is valid and to allow structured searches on XML data. The DTD is stored in the DTD repository.

**valid document.** An XML document that has an associated DTD. To be valid, the XML document cannot violate the syntactic rules specified in its DTD.

**video.** Pertaining to the portion of recorded information that can be seen.

**video clip.** A section of filmed or videotaped material.

**video index.** A file that the Video Extender uses to find a specific *shot* or frame in a video clip.

**Web browser.** A client program that initiates requests to a Web server and displays the information that the server returns.

**well-formed document.** An XML document that does not contain a DTD. Although in the XML specification, a document with a valid DTD must also be well-formed.

**wildcard character.** See *masking character*.

**XML.** eXtensible Markup Language.

**XML attribute.** Any attribute specified by the ATTLIST under the XML element in the DTD. The XML Extender uses the location path to identify an attribute.

**XML collection.** A collection of relation tables which presents the data to compose XML documents, or to be decomposed from XML documents.

**XML column.** A column in the application table that has been enabled for the XML Extender UDTs.

**XML element.** Any XML tag or ELEMENT as specified in the XML DTD. The XML Extender uses the location path to identify an element.

**XML object.** Equivalent to an XML document.

**XML Path Language.** A language for addressing parts of an XML document. XML Path Language is designed to be used by XSLT. Every location path can be expressed using the syntax defined for XPath.

**XML table.** An application table which includes one or more XML Extender columns.

**XML tag.** Any valid XML markup language tag, mainly the XML element. The terms tag and element are used interchangeably.

**XML UDF.** A DB2 UDB user-defined function provided by the XML Extender.

**XML UDT.** A DB2 UDB user-defined type provided by the XML Extender.

**XPath.** A language for addressing parts of an XML document.

**XPath data model.** The tree structure used to model and navigate an XML document using nodes.

**XSL.** XML Stylesheet Language.

**XSLT.** XML Stylesheet Language Transformation.



# Index

## A

- access and storage method
  - choosing an 39
  - planning 39
  - XML collections 42, 43, 161
  - XML columns 42, 43, 161
- access method
  - choosing an 39
  - introduction 5
  - planning an 39
  - XML collections 89
  - XML column 73
- adding
  - nodes 66
- administration
  - dxxadm command 121
  - in iSeries environment 31, 35
  - support tables
    - DTD\_REF 203
    - XML\_USAGE 203
  - tools 38
- administration stored procedures
  - dxxDisableCollection() 182
  - dxxDisableColumn() 181
  - dxxDisableDB() 179
  - dxxEnableCollection() 182
  - dxxEnableColumn() 180
  - dxxEnableDB() 178
- administrative support tables
  - DTD\_REF 203
  - XML\_USAGE 203
- attribute\_node 43, 51, 106, 161

## B

- B-tree indexing 75
- binding
  - stored procedures 177

## C

- c header files 31
- casting function
  - retrieval 78, 137
  - storage 76, 134
  - update 82, 152
- CCSID (coded character set identifier)
  - declare in USS 90, 94, 237
- client code page 237
- code pages
  - client 237
  - configuring locale settings 237
  - consistent encoding in USS 237
  - consistent encodings and declarations 237
  - conversion
    - scenarios 237
  - data loss 237
  - database 237
  - DB2 assumptions 237

- code pages (*continued*)
  - DB2CODEPAGE registry variable 237
  - declaring an encoding 237
  - document encoding consistency 237
  - encoding declaration 237
  - exporting documents 237
  - importing documents 237
  - legal encoding declarations 237
  - line endings 237
  - preventing inconsistent documents 237
  - server 237
  - supported encoding declarations 237
  - terminology 237
  - UDFs and stored procedures 237
  - Windows NT UTF-8 limitation 237
  - XML Extender assumptions 237
- column data
  - available UDTs 41
- column type, for decomposition 50
- column types
  - decomposition 106
- command options
  - disable\_collection 126
  - disable\_column 124
  - disable\_db 122
  - enable\_collection 125
  - enable\_column 123
  - enable\_db 122
- complexType element 115
- composing XML documents 17
- composite key
  - for decomposition 49
  - XML collections 49
- composite keys
  - for decomposition 106
  - XML collections 106
- composition
  - dxxGenXML() 90
  - dxxRetrieveXML() 90
  - overriding the DAD file 169
  - stored procedures
    - dxxGenXML() 17, 183, 190
    - dxxRetrieveXML() 187, 192
  - XML collection 90
- conditions
  - optional 48
  - RDB\_node mapping 48, 106
  - SQL mapping 45, 47, 102, 105
- consistent documents 237
- Content() function
  - for retrieval 78
  - retrieval functions using 137
  - XMLFile to a CLOB 137
- conversions
  - code pages 237
- creating
  - nodes 66
  - XML tables 52

## D

- DAD
  - node definitions
    - RDB\_node 48
- DAD (Document Access Definition) file
  - attribute\_node 161
  - bind step for USS encodings 237
  - CCSIDs in USS 90, 94, 237
  - creating for XML collections 62
  - declaring the encoding 237
  - DTD for the 164
  - editing for XML collections 62
  - element\_node 106, 161
  - examples 229
  - for XML columns 159, 161
  - introduction 5
  - node definitions 161
  - overriding 169
  - RDB\_node 106
  - root element\_node 106
  - root\_node 161
  - samples 229
  - size limit 161, 239
  - text\_node 161
- DAD file
  - attribute\_node 43
  - element\_node 43, 48
  - for XML columns 41, 42
  - node definitions
    - attribute\_node 43
    - element\_node 43
    - root\_node 43
    - text\_node 43
  - planning for the 41, 42
    - XML collections 42
    - XML column 42
  - RDB\_node 48
  - root element\_node 48
  - root\_node 43
  - size limit 41, 42
  - text\_node 43
- data loss, inconsistent encodings 237
- database
  - relational 44
- databases
  - code page 237
  - enabling for XML 51
  - relational 102
- DB2CODEPAGE
  - registry variable 237
- DB2XML 203
  - DTD\_REF table schema 203
  - schema for stored procedures 89
  - schema for UDFs and UDTs 134
  - XML\_USAGE table schema 203
- decomposing an XML collection
  - collection table limit 239
  - composite key 106
  - DB2 table sizes 94
  - dxxInsertXML() 94

- decomposing an XML collection
  - (*continued*)
  - dxxShredXML() 94
  - of XML collections 94
  - specifying the column type for 106
  - specifying the orderBy attribute 106
  - specifying the primary key for 106
  - stored procedures
    - dxxInsertXML() 197
    - dxxShredXML() 194
  - using RDB\_node mapping 66
- decomposition
  - composite key 49
  - specifying the column type for 50
  - specifying the orderBy attribute 49
  - specifying the primary key for 49
- deleting
  - nodes 66
  - XML collections 99
- disable\_collection command 126
- disable\_column command 124
- disable\_db command 122
- disabling
  - administration command 121
  - databases for XML, stored procedure 179
  - disable\_collection command 126
  - disable\_column command 124
  - disable\_db command 122
  - stored procedure 179, 181, 182
  - XML collections 113
  - stored procedure 182
  - XML columns
    - stored procedure 181
- document encoding declaration 237
- document structure, maintaining 73
- document type definition 53
- DTD
  - availability 4
  - for getting started lessons 17
  - for the DAD 164
  - planning 17
  - publication 4
  - repository
    - DTD\_REF 5, 203
    - storing in 53
  - using multiple 42, 51
- DTD\_REF table 53
  - column limits 239
  - inserting a DTD 53
  - schema 203
- DTDID 203
- DVALIDATE 155
- DXX\_SEQNO for multiple occurrence 57
- dxxadm command
  - disable\_collection command 126
  - disable\_column command 124
  - disable\_db command 122
  - enable\_collection command 125
  - enable\_column command 123
  - enable\_db command 122
  - introduction to 121
  - syntax 121
- dxxDisableCollection() stored procedure 182
- dxxDisableColumn() stored procedure 181

- dxxDisableDB() stored procedure 179
- dxxEnableCollection() stored procedure 182
- dxxEnableColumn() stored procedure 180
- dxxEnableDB() stored procedure 178
- dxxGenXML() 17
- dxxGenXML() stored procedure 90, 183, 190
- dxxInsertXML() stored procedure 94, 197
- dxxRetrieveXML() stored procedure 90, 187, 192
- DXXROOT\_ID 75
- dxxsamples 36
- dxxShredXML() stored procedure 94, 194
- dxxtrc command 205, 206
- dynamically overriding the DAD file, composition 169

## E

- element\_node 43, 49, 106, 161
- enable\_collection keyword 125
- enable\_column keyword 123
- enable\_db keyword
  - creating XML\_USAGE table 203
  - option 122
- enabling
  - XML collections 112
- encoding
  - CCSID declarations in USS 90, 94, 237
  - XML documents 237
- existing DB2 data 89
- Extensible Markup Language (XML)
  - in XML documents 3
- extractChar() function 146
- extractChars() function 146
- extractCLOB() function 148
- extractCLOBs() function 148
- extractDate() function 149
- extractDates() function 149
- extractDouble() function 144
- extractDoubles() function 144
- extracting functions
  - description 133
  - extractChar() 146
  - extractChars() 146
  - extractCLOB() 148
  - extractCLOBs() 148
  - extractDate() 149
  - extractDates() 149
  - extractDouble() 144
  - extractDoubles() 144
  - extractReal() 145
  - extractReals() 145
  - extractSmallint() 143
  - extractSmallints() 143
  - extractTime() 150
  - extractTimes() 150
  - extractTimestamp() 151
  - extractTimestamps() 151
  - extractVarchar() 146
  - extractVarchars() 146
  - introduction to 141

- extracting functions (*continued*)
  - table of 78
- extractReal() function 145
- extractReals() function 145
- extractSmallint() function 143
- extractSmallints() function 143
- extractTime() function 150
- extractTimes() function 150
- extractTimestamp() function 151
- extractTimestamps() function 151
- extractVarchar() function 146
- extractVarchars() function 146

## F

- FROM clause 47
  - SQL mapping 105
- function path
  - adding DB2XML schema 134
- functions
  - casting 76, 78, 82
  - Content(): from XMLFILE to CLOB 137
  - extractChar() 146
  - extractChars() 146
  - extractCLOB() 148
  - extractCLOBs() 148
  - extractDate() 149
  - extractDates() 149
  - extractDouble() 144
  - extractDoubles() 144
  - extracting 141
  - extractReal() 145
  - extractReals() 145
  - extractSmallint() 143
  - extractSmallints() 143
  - extractTime() 150
  - extractTimes() 150
  - extractTimestamp() 151
  - extractTimestamps() 151
  - extractVarchar() 146
  - extractVarchars() 146
  - generate\_unique 133, 154
  - limitations when invoking from JDBC 86
  - limits 239
  - retrieval
    - description 133
    - from external storage to memory pointer 137
    - from internal storage to external server file 137
    - introduction 137
    - XML data 78
    - storage 76, 133, 134
    - update 82, 133, 152
  - XML columns 133
  - XMLCLOBFromFile() 134
  - XMLFile to a CLOB 137
  - XMLFileFromCLOB() 134, 135
  - XMLFileFromVarchar() 134, 135
  - XMLVarcharFromFile() 134, 136

## G

GENERATE\_UNIQUE function  
introduction 154

## H

header files 31  
highlighting conventions ix

## I

importing  
  DTD 53  
include files  
  for stored procedures 177  
inconsistent  
  document 237  
indexing 75  
  side tables 58, 75  
  structural-text 75  
  XML columns 75  
  XML documents 75  
Information Center, including this book  
  in ix  
installing  
  the 32  
iSeries Navigator  
  running SQL scripts 37  
  setting up 37

## J

Java database connectivity (JDBC)  
  limitations when invoking UDFs 86  
JDBC (Java database connectivity)  
  limitations when invoking UDFs 86  
join conditions  
  RDB\_node mapping 48, 106  
  SQL mapping 47, 105

## L

limits  
  stored procedure parameters 90, 203  
  XML Extender 239  
line  
  endings, code page  
  considerations 237  
locales  
  settings 237  
location path  
  introduction 110  
  syntax 110  
  XPath 5  
  XSL 5

## M

maintaining  
  document structure 73  
mapping scheme  
  determining RDB\_node mapping 46,  
  102  
  determining SQL mapping 45, 102

mapping scheme (*continued*)  
  figure of DAD file 39  
  figure of DAD for the 40  
  for XML collections 39, 40  
  for XML columns 39, 40  
  FROM clause 47, 105  
  introduction 89  
  ORDER BY clause 48, 105  
  RDB\_node mapping  
  requirements 48, 49, 106  
  requirements 47  
  SELECT clause 47, 105  
  SQL mapping requirements 47, 105  
  SQL mapping scheme 46, 102  
  SQL\_stmt 44, 102  
  WHERE clause 48, 105

messages

  XML 212

migrating

  data from SYSBAS to IASP for  
  iSeries 33  
  IASP considerations for iSeries 33  
  XML Extender to Version 8 33

multiple DTDs

  XML collections 42  
  XML columns 51

multiple occurrence

  affecting table size 94  
  deleting elements and attributes 99  
  DXX\_SEQNO 57  
  one column per side table 57  
  order of elements and attributes 94  
  orderBy attribute 49, 106  
  preserving the order of elements and  
  attributes 99  
  recomposing documents with 49, 106  
  searching elements and attributes 84  
  updating collections 99  
  updating elements and attributes 82,  
  99, 152  
  updating XML documents 82, 152  
multiple-occurrence attribute 17

## N

nodes

  adding 66  
  attribute\_node 43, 161  
  creating 66  
  DAD file configuration 17, 59, 62, 66  
  deleting 66  
  element\_node 43, 161  
  RDB\_node 48, 106  
  removing 66  
  root\_node 43, 161  
  text\_node 43, 161

## O

operating environment, iSeries 31  
operating systems  
  supported by DB2 3  
Operations Navigator  
  starting the trace 205  
  stopping the trace 206  
ORDER BY clause 48

ORDER BY clause (*continued*)

  SQL mapping 105  
orderBy attribute  
  for decomposition 49, 106  
  for multiple occurrence 49, 106  
  XML collections 49, 106  
overloaded function  
  Content() 137  
overrideType  
  No override 169  
  SQL override 169  
  XML override 169  
overriding  
  DAD file 169

## P

parameter markers in functions 86

performance

  indexing side tables 75  
  searching XML documents 75  
  stopping the trace 206

planning

  a mapping scheme 44  
  access methods 39  
  choosing to validate XML data 42  
  DAD 161  
  determining column UDT 41  
  DTD 17  
  for the DAD 41, 42  
  for XML collections 42  
  for XML columns 40, 41  
  how to search XML column data 41  
  indexing XML columns 75  
  mapping schemes 102  
  mapping XML document and  
  database 17  
  side tables 57  
  storage methods 39  
  the XML collections mapping  
  scheme 44  
  validating with multiple DTDs 42, 51  
  XML collections 161  
  XML collections mapping  
  scheme 102  
primary key for decomposition 49  
primary keys  
  decomposition 106  
  side tables 75  
problem determination 205  
processing instructions 109, 161

## R

RDB\_node mapping  
  composite key for decomposition 49  
  conditions 48  
  decomposition requirements 49  
  determining for XML collections 46  
  requirements 48, 106  
  specifying column type for  
  decomposition 50  
registry variables  
  DB2CODEPAGE 237  
removing  
  nodes 66

- repository, DTD 53
- retrieval functions
  - Content() 137
  - description of 133
  - from external storage to memory pointer 137
  - from internal storage to external server file 137
  - introduction to 137
  - XMLFile to a CLOB 137
- retrieving data
  - attribute values 78
- return codes
  - stored procedures 207
  - UDF 207
- ROOT ID
  - indexing considerations 75
- root\_node 43, 161

## S

- samples
  - creating
    - XML 17
  - document access definition (DAD) files 229
  - getstart.xml sample XML document 229
- samples files, unpack and restore 35
- schema names
  - for stored procedures 89
- schema, creating 36
- schemas
  - attributes 116
  - DB2XML 51, 134
  - declaring data types in 116
  - declaring elements in 116
  - DTD\_REF table 53, 203
  - validating using 51
  - XML\_USAGE table 203
- searching
  - XML documents
    - by structure 84
    - using DB2 Text Extender 84
- SELECT clause 47, 105
- server code page 237
- side tables
  - indexing 58, 75
  - planning 57
  - searching 84
  - updating 82
- size limits
  - stored procedures 90, 203
  - XML Extender 239
- software requirements
  - XML Extender 32
- SQL mapping 59
  - creating a DAD file 17
  - determining for XML collections 45, 102
  - FROM clause 47
  - ORDER BY clause 48
  - requirements 47, 105
  - SELECT clause 47
  - SQL mapping scheme 46
  - WHERE clause 48
- SQL override 169

- SQL\_stmt
  - FROM clause 47, 105
  - ORDER BY clause 48, 105
  - SELECT clause 47, 105
  - WHERE clause 48, 105
- starting
  - XML Extender 32
- storage
  - functions
    - description 133
    - introduction 134
    - storage UDF table 76
    - XMLCLOBFromFile() 134
    - XMLFileFromCLOB() 134, 135
    - XMLFileFromVarchar() 134, 135
    - XMLVarcharFromFile() 134, 136
  - methods
    - choosing 39
    - introduction 5
    - planning 39
    - XML collections 89
    - XML column 73
- storage UDFs 76, 82
- stored procedures
  - administration
    - dxxDisableCollection() 182
    - dxxDisableColumn() 181
    - dxxDisableDB() 179
    - dxxEnableCollection() 182
    - dxxEnableColumn() 180
    - dxxEnableDB() 178
    - XML Extender, list 178
  - binding 177
  - calling
    - XML Extender 177
  - code page considerations 237
  - composition
    - dxxGenXML() 183, 190
    - dxxRetrieveXML() 187, 192
    - XML Extenders 183
  - decomposition
    - dxxInsertXML() 197
    - dxxShredXML() 194
    - XML Extenders 194
  - dxxDisableCollection() 182
  - dxxDisableColumn() 181
  - dxxDisableDB() 179
  - dxxEnableCollection() 182
  - dxxEnableColumn() 180
  - dxxEnableDB() 178
  - dxxGenXML() 17, 90, 183, 190
  - dxxInsertXML() 94, 197
  - dxxRetrieveXML() 90, 187, 192
  - dxxShredXML() 94, 194
  - include files 177
  - initializing
    - DXXGPREP 177
  - return codes 207
  - XML Extender 177
- storing the DTD 53
- storing XML data 76
- structure
  - DTD 17
  - hierarchical 17
  - mapping 17
  - relational tables 17
  - XML document 17

- stylesheets 109, 161
- SVALIDATE 155
- syntax
  - disable\_collection command 126
  - disable\_column command 124
  - disable\_db command 122
  - dxxadm 121
  - enable\_collection command 125
  - enable\_column command 123
  - enable\_db command 122
  - extractChar() function 146
  - extractChars() function 146
  - extractCLOB() function 148
  - extractCLOBs() function 148
  - extractDate() function 149
  - extractDates() function 149
  - extractDouble() function 144
  - extractDoubles() function 144
  - extractInteger() function 141
  - extractIntegers() function 141
  - extractReal() function 145
  - extractReals() function 145
  - extractSmallint() function 143
  - extractSmallints() function 143
  - extractTime() function 150
  - extractTimes() function 150
  - extractTimestamp() function 151
  - extractTimestamps() function 151
  - extractVarchar() function 146
  - extractVarchars() function 146
  - generate\_unique() function 154
  - how to read xi
  - location path 110
  - Update() function 152
  - XMLCLOBFromFile() function 134
  - XMLFile to a CLOB Content() function 137
  - XMLFileFromCLOB() function 134, 135
  - XMLFileFromVarchar() function 134, 135
  - XMLVarcharFromFile() function 136

## T

- tables 94
- text\_node 43, 51, 106, 161
- traces
  - starting 205
  - stopping 206
- transfer of documents between client and server, considerations 237
- transforming XML to HTML
  - XSLTransformToCLOB 200
  - XSLTransformToFile 201
- troubleshooting
  - stored procedure return codes 207
  - strategies 205
  - UDF return codes 207

## U

- UDFs (user-defined functions)
  - code page considerations 237
  - DVALIDATE() 155
  - extractChar() 146

- UDFs (user-defined functions) *(continued)*
  - extractChars() 146
  - extractCLOB() 148
  - extractCLOBs() 148
  - extractDate() 149
  - extractDates() 149
  - extractDouble() 144
  - extractDoubles() 144
  - extracting functions 141
  - extractReal() 145
  - extractReals() 145
  - extractSmallint() 143
  - extractSmallints() 143
  - extractTime() 150
  - extractTimes() 150
  - extractTimestamp() 151
  - extractTimestamps() 151
  - extractVarchar() 146
  - extractVarchars() 146
  - for XML columns 133
  - from external storage to memory pointer 137
  - from internal storage to external server file 137
  - generate\_unique() 154
  - retrieval functions 137
  - return codes 207
  - searching with 84
  - storage 82
  - SVALIDATE() 155
  - Update() 82, 152
  - XMLCLOBFromFile() 134
  - XMLFile to a CLOB 137
  - XMLFileFromCLOB() 134, 135
  - XMLFileFromVarchar() 134, 135
  - XMLVarcharFromFile() 134, 136
- UDTs
  - summary table of 41
  - XMLCLOB 41
  - XMLFILE 41
  - XMLVARCHAR 41
- unique key column, generating 154
- unpack and restore sample files 35
- Update() function
  - document replacement behavior 152
  - introduction 152
  - XML 82, 133
- updates
  - side tables 82
  - XML collection 99
  - XML column data
    - attributes 82
    - description 82
    - entire document 82
    - multiple occurrence 152
    - specific elements 82
  - XML document replacement by Update() UDF 152
- user-defined functions (UDFs)
  - for XML columns 133
  - generate\_unique() 154
  - searching with 84
  - Update() 82, 152
- user-defined types (UDTs)
  - for XML columns 73
  - XML 131
  - XMLCLOB 73
- user-defined types (UDTs) *(continued)*
  - XMLFILE 73
  - XMLVARCHAR 73
- V**
  - validate XML data
    - considerations 42
    - deciding to 42
    - DTD requirements 42
  - validating
    - performance impact 42
    - using schemas 51
    - XML DTDs 53
- W**
  - WHERE clause 48
    - requirements for SQL mapping 105
  - Windows
    - UTF-8 limitation, code pages Windows NT 237
- X**
  - XML
    - data, storing 76
    - override 169
    - repository 39
    - tables, creating 52
  - XML collections
    - composition 90
    - creating the DAD (command line) 62
    - DAD file, planning for 42
    - decomposing using RDB\_node mapping 66
    - decomposition 94
    - definition 5
    - determining a mapping scheme 102
    - determining a mapping scheme for 44
    - disabling 113
    - DTD for validation 53
    - editing the DAD (command line) 62
    - enabling 112
    - introduction 89
    - mapping scheme 44
    - mapping schemes 45, 102
    - RDB\_node mapping 46, 102
    - scenarios 40
    - SQL mapping 45, 102
    - storage and access methods 5, 89
    - validation 53
    - when to use 40
  - XML columns
    - creating a DAD file for 159
    - DAD file, planning for 42
    - defining and enabling 74
    - definition 5
    - determining column UDT 41
    - elements and attributes to be searched 41
    - figure of side tables 57
    - indexing 75
    - introduction 73
    - location path 110
- XML columns *(continued)*
  - maintaining document structure 73
  - planning 40
  - retrieving data
    - attribute values 78
    - element contents 78
    - entire document 78
  - retrieving XML data 78
  - sample DAD file 229
  - scenarios 40
  - storage and access methods 5, 73
  - the DAD for 41
  - UDFs 133
  - updating XML data
    - attributes 82
    - entire document 82
    - specific elements 82
  - when to use 40
  - with side tables 75
- XML documents
  - B-tree indexing 75
  - code page assumptions 237
  - code page consistency 237
  - code page conversion, exporting 237
  - code page conversion, importing 237
  - composing 17, 90
  - decomposition 94
  - deleting 86
  - encoding declarations 237
  - indexing 75
  - introduction 3
  - legal encoding declarations 237
  - mapping to tables 17
  - searching
    - direct query on side tables 84
    - document structure 84
    - from a joined view 84
    - multiple occurrence 84
    - structural text 84
    - with extracting UDFs 84
  - stored in DB2 3
  - supported encoding declarations 237
- XML DTD repository
  - description 5
  - DTD Reference Table (DTD\_REF) 5
- XML Extender
  - available operating systems 3
  - functions 133
  - introduction 3
  - stored procedures 177
- XML operating environment on iSeries 31
- XML Path Language 5
- XML schemas
  - advantages 115
  - example 117
  - validating 155
- XML Toolkit for OS/390 and z/OS 7
- XML\_USAGE table 203
- XMLClobFromFile() function 134
- XMLFile to a CLOB function 137
- XMLFileFromCLOB() function 134, 135
- XMLFileFromVarchar() function 134, 135
- XMLVarcharFromFile() function 134, 136
- XPath 5
- XSLT 45, 102
  - using 17

XSLTransformTOClob() 200  
XSLTransformToFile 201

---

## Notices

IBM may not offer the products, services, or features discussed in this document in all countries. Consult your local IBM representative for information on the products and services currently available in your area. Any reference to an IBM product, program, or service is not intended to state or imply that only that IBM product, program, or service may be used. Any functionally equivalent product, program, or service that does not infringe any IBM intellectual property right may be used instead. However, it is the user's responsibility to evaluate and verify the operation of any non-IBM product, program, or service.

IBM may have patents or pending patent applications covering subject matter described in this document. The furnishing of this document does not give you any license to these patents. You can send license inquiries, in writing, to:

IBM Director of Licensing  
IBM Corporation  
North Castle Drive  
Armonk, NY 10504-1785  
U.S.A.

For license inquiries regarding double-byte (DBCS) information, contact the IBM Intellectual Property Department in your country/region or send inquiries, in writing, to:

IBM World Trade Asia Corporation  
Licensing  
2-31 Roppongi 3-chome, Minato-ku  
Tokyo 106, Japan

**The following paragraph does not apply to the United Kingdom or any other country/region where such provisions are inconsistent with local law:**  
INTERNATIONAL BUSINESS MACHINES CORPORATION PROVIDES THIS PUBLICATION "AS IS" WITHOUT WARRANTY OF ANY KIND, EITHER EXPRESS OR IMPLIED, INCLUDING, BUT NOT LIMITED TO, THE IMPLIED WARRANTIES OF NON-INFRINGEMENT, MERCHANTABILITY, OR FITNESS FOR A PARTICULAR PURPOSE. Some states do not allow disclaimer of express or implied warranties in certain transactions; therefore, this statement may not apply to you.

This information could include technical inaccuracies or typographical errors. Changes are periodically made to the information herein; these changes will be incorporated in new editions of the publication. IBM may make improvements and/or changes in the product(s) and/or the program(s) described in this publication at any time without notice.

Any references in this information to non-IBM Web sites are provided for convenience only and do not in any manner serve as an endorsement of those Web sites. The materials at those Web sites are not part of the materials for this IBM product, and use of those Web sites is at your own risk.

IBM may use or distribute any of the information you supply in any way it believes appropriate without incurring any obligation to you.

Licensees of this program who wish to have information about it for the purpose of enabling: (i) the exchange of information between independently created programs and other programs (including this one) and (ii) the mutual use of the information that has been exchanged, should contact:

IBM Canada Limited  
Office of the Lab Director  
8200 Warden Avenue  
Markham, Ontario  
L6G 1C7  
CANADA

Such information may be available, subject to appropriate terms and conditions, including in some cases payment of a fee.

The licensed program described in this document and all licensed material available for it are provided by IBM under terms of the IBM Customer Agreement, IBM International Program License Agreement, or any equivalent agreement between us.

Any performance data contained herein was determined in a controlled environment. Therefore, the results obtained in other operating environments may vary significantly. Some measurements may have been made on development-level systems, and there is no guarantee that these measurements will be the same on generally available systems. Furthermore, some measurements may have been estimated through extrapolation. Actual results may vary. Users of this document should verify the applicable data for their specific environment.

Information concerning non-IBM products was obtained from the suppliers of those products, their published announcements, or other publicly available sources. IBM has not tested those products and cannot confirm the accuracy of performance, compatibility, or any other claims related to non-IBM products. Questions on the capabilities of non-IBM products should be addressed to the suppliers of those products.

All statements regarding IBM's future direction or intent are subject to change or withdrawal without notice, and represent goals and objectives only.

This information may contain examples of data and reports used in daily business operations. To illustrate them as completely as possible, the examples include the names of individuals, companies, brands, and products. All of these names are fictitious, and any similarity to the names and addresses used by an actual business enterprise is entirely coincidental.

#### COPYRIGHT LICENSE:

This information may contain sample application programs, in source language, which illustrate programming techniques on various operating platforms. You may copy, modify, and distribute these sample programs in any form without payment to IBM for the purposes of developing, using, marketing, or distributing application programs conforming to the application programming interface for the operating platform for which the sample programs are written. These examples have not been thoroughly tested under all conditions. IBM, therefore, cannot guarantee or imply reliability, serviceability, or function of these programs.

Each copy or any portion of these sample programs or any derivative work must include a copyright notice as follows:



© (your company name) (year). Portions of this code are derived from IBM Corp. Sample Programs. © Copyright IBM Corp. *\_enter the year or years\_*. All rights reserved.

---

## Trademarks

The following terms are trademarks of International Business Machines Corporation in the United States, other countries, or both, and have been used in at least one of the documents in the DB2 UDB documentation library.

ACF/VTAM	iSeries
AISPO	LAN Distance
AIX	MVS
AIXwindows	MVS/ESA
AnyNet	MVS/XA
APPN	Net.Data
AS/400	NetView
BookManager	OS/390
C Set++	OS/400
C/370	PowerPC
CICS	pSeries
Database 2	QBIC
DataHub	QMF
DataJoiner	RACF
DataPropagator	RISC System/6000
DataRefresher	RS/6000
DB2	S/370
DB2 Connect	SP
DB2 Extenders	SQL/400
DB2 OLAP Server	SQL/DS
DB2 Information Integrator	System/370
DB2 Query Patroller	System/390
DB2 Universal Database	SystemView
Distributed Relational Database Architecture	Tivoli
DRDA	VisualAge
eServer	VM/ESA
Extended Services	VSE/ESA
FFST	VTAM
First Failure Support Technology	WebExplorer
IBM	WebSphere
IMS	WIN-OS/2
IMS/ESA	z/OS
	zSeries

The following terms are trademarks or registered trademarks of other companies and have been used in at least one of the documents in the DB2 UDB documentation library:

Microsoft, Windows, Windows NT, and the Windows logo are trademarks of Microsoft Corporation in the United States, other countries, or both.

Intel and Pentium are trademarks of Intel Corporation in the United States, other countries, or both.

Java and all Java-based trademarks are trademarks of Sun Microsystems, Inc. in the United States, other countries, or both.

UNIX is a registered trademark of The Open Group in the United States and other countries.

Other company, product, or service names may be trademarks or service marks of others.





Program Number: 5722-DE1

Printed in USA

SC18-9179-01

