



IBM Systems - iSeries

Backup Recovery and Media Services for iSeries

Version 5

SC41-5345-05





IBM Systems - iSeries

Backup Recovery and Media Services for iSeries

Version 5

SC41-5345-05

Note

Before using this information and the product it supports, be sure to read the information in Appendix D, "Notices," on page 349.

Sixth Edition (February 2006)

This edition applies to version 5, release 4, modification 0 of Backup, Recovery and Media Services (product number 5722-BR1) and to all subsequent releases and modifications until otherwise indicated in new editions. This version does not run on all reduced instruction set computer (RISC) models nor does it run on CISC models.

| This edition replaces SC41-5345-04.

© Copyright International Business Machines Corporation 1998, 2006. All rights reserved.

US Government Users Restricted Rights – Use, duplication or disclosure restricted by GSA ADP Schedule Contract with IBM Corp.

Contents

About Backup, Recovery and Media Services for iSeries (SC41-5345-05) . . . ix

Who should read this book	ix
Prerequisite and related information	ix
How to send your comments	x

Summary of Changes xi

Software Enhancements	xi
Command Changes	xi
Changes to Policies	xiii
Display Changes	xiv
Menu Changes	xv
BRMS iSeries Navigator Client Enhancements	xv
Compatibility	xvii
Performance	xvii
Book Enhancements	xvii
Information Center Enhancements	xviii

Part 1. Getting Started with BRMS . . . 1

Chapter 1. Introduction to IBM Backup Recovery and Media Services for i5/OS (BRMS) 3

BRMS Standard	3
BRMS Network Feature.	3
BRMS Advanced Functions Feature.	3
Overview of Standard BRMS Product Functionality	4
How BRMS Policies Work	5
Types of Policies	5
How BRMS Control Groups Work	6
How Policies and Control Groups Work Together	6
The BRMS Media Management Components	7
How the BRMS Functional Components Work Together	8

Chapter 2. Installing and Initializing BRMS. 9

Hardware Considerations	9
Software Considerations	9
Installing Media and Storage Extensions (MSE).	9
Planning for the Install	10
Installing BRMS	12
After the Installation	12
Updating License Information	13
Installing the BRMS iSeries Navigator Client On Your Workstation	14
Removing BRMS From Your System	14
Remove BRMS iSeries Navigator Client From Your Workstation	15

Chapter 3. Backing Up Your Entire System 17

Enrolling Media	17
---------------------------	----

Determining Media Classes	18
Enrolling Media into BRMS for use by a Stand-Alone Tape Device.	19
Enrolling Media into BRMS for use by a Media Library	19
Performing the Backups	19
Backing Up System with *SYSTEM	20
Backing Up System Data with *SYSGRP.	20
Backing Up User Data with *BKUGRP	20
Backup and Recovery Log	21
Removing Log Messages	23
Excluding Log Messages	23
Sending Log Messages.	23
Printing Your Recovery Reports	24

Chapter 4. Recovering Your Entire System 27

An Overview of the Recovery Reports	27
Recovering Your Entire System Report (also called the Recovery Analysis Report).	27
Recovery Volume Summary Report	28
Display ASP Information Report	28
Printing the Recovery Reports	28
User Customized Recovery Step Information	29
Using the STRRCYBRM command.	31
Resume a Recovery.	31
Concurrent Recovery	33
Using the Recovering Your Entire System Report	35
Prolog	36
STEP 001 : Recover Licensed Internal Code.	38
STEP 002 : Recover Operating System	39
STEP 003 : Set Up Standalone or Media Library Devices for Recovery	40
STEP 004 : Recover the BRMS Product and Associated Libraries	41
STEP 005 : Recover BRMS Related Media Information	43
STEP 006 : Initialize BRMS Functional Authority Information	44
STEP 007 : Update System Name in BRMS Media Information	44
STEP 008 : Initialize BRMS Device and Media Library Information	45
STEP 009 : Recover User Profiles	46
STEP 010 : Change QSECOFR User Profile Password	47
STEP 011 : Recover Configuration Data	48
STEP 012 : Recover Required System Libraries.	48
STEP 013 : Reset BRMS Device and Media Library Information	49
STEP 014 : Recover All Remaining System and User Data	50
STEP 015 : Recover IBM Product Libraries	51
STEP 016 : Recover User Libraries	52
STEP 017 : Recover Document Library Objects.	54

STEP 018 : Recover Directories and Files	54
STEP 019 : Recover Spooled Files for all ASPs	55
STEP 020 : Special Recovery Processing — IBM iSeries Integration for Windows Server	56
STEP 021 : Special Recovery Processing — Recovering Linux servers in a logical partition.	57
STEP 022 : Special Recovery Processing — IBM Content Manager onDemand for iSeries	57
STEP 023 : Update Program Temporary Fix Information	58
STEP 024 : Apply Journal Changes	58
STEP 025 : Recover Additional Saved System Information	59
STEP 026 : Recover Authorization Information.	60
STEP 027 : Verify System Information	61
STEP 028 : Apply PTFs	62
STEP 029 : Reset System Values.	62
STEP 030 : Print Job Log	62
STEP 031 : Perform IPL	63
STEP 032 : Special Recovery Processing — IBM iSeries Integration for Windows Server	63
Recovery Tips	64

Part 2. Tailoring Your BRMS Operations 67

Chapter 5. Working with Devices in BRMS 69

Adding New Devices	69
Adding a New Device Automatically.	69
Adding a New Device Manually	69
Changing an Existing Device	70
Changing Device Information for Stand-Alone Devices.	70
Changing Device Information for Media Library Devices.	72
Changing Device Information for Virtual Tape Devices.	73
Working with Third Party Media Libraries	74
Last Active Device	75

Chapter 6. Setting Up Your Media Management Operation 77

Preparing Your Media	78
Working with Media Classes	78
Enrolling Media	80
Initializing Volumes	83
Setting Up Your Media Inventory System	84
Storing Your Media.	86
Media Policies	86
Storage Locations	88
Containers and Container Classes	90
Media Slotting	92
Moving Your Media	93
Move Policies.	93
Initiating Movement	98
Verifying Movement	99
Tracking Your Media	101
Working with the BRMS Media Inventory	101

Printing Media Status Reports.	102
Duplicating Media.	102
Copying Volumes with DUPMEDBRM	103
Saving Media Information for Duplicate Volumes	104
Remote Duplication of Media	104
Duplicating Saved Items.	105
Resuming Duplication	105
Reclaiming Media	106
Expiring media set volumes	107
Reclaiming fragmented media.	107
External Label Printing	107
How to Specify Label Printing.	107
Customizing Label Printing	108

Chapter 7. Tailoring Your Backup 109

Planning Considerations.	109
The BRMS System Policy	110
Understanding the System Policy.	110
The BRMS Backup Policy	112
Changing the Backup Policy	112
Backup Control Groups	115
Content of Control Groups	116
Using the *SAVSYS Special Value.	118
Contents of the Default Control Groups	120
How to Work with Backup Control Groups	121
Control Group Processing Order	128
Creating Backup Lists in a Control Group	130
Processing User Exits in a Control Group	139
Backing Up Your Control Group	140
Additional Options for Processing Control Groups	140
Using the Save-While-Active Feature	140
Console Monitoring	145
Submitting a Backup to the Controlling Subsystem	147
Using Missed Object Policies	148
Performing Serial, Concurrent, and Parallel Backups	149
Concurrent Backups	149
Parallel Backups	149
Parallel Support Restrictions	149
When to Use Parallel and Concurrent Saves	149
How to Set Up a Parallel Backup.	150
Sample Backup Scenarios: Working with Multiple Control Groups and Shared Devices.	151
Scenario 1: Using Multiple Control Groups in a Serial Backup	151
Scenario 2: Using Multiple Control Groups in Parallel and Concurrent Backups	154
Scenario 3: Performing a Backup Across a Network with Shared Devices	156
Scenario 4: Performing Parallel and Serial Backups in the Same Control Group.	159
Additional BRMS Save Commands	160

Chapter 8. Performing Selected Recoveries 163

Recovery Policy	163
Working with the STRRCYBRM Command	165
Understanding the STRRCYBRM Parameters	166

Recovering Control Groups with STRRCYBRM	167
Recovering Multiple Control Groups	170
Recovering Libraries with STRRCYBRM	172
Recovery of Individual Integrated File System Objects	173
Recovering User Profiles	175
Additional Restore Options in BRMS	175
Recovering Objects with Object Detail	175
Recovering Objects without Object Detail	177
Recovery with Apply Journal Changes	178
Recovering Individual Folders	181
Recovering Spooled Files Saved with Output Queues	183
Recovering Individual Spooled Files	184
How to Perform Parallel and Concurrent Recoveries	187
Recovering Multiple Control Groups with Concurrent Support	187
Performing Parallel Recoveries	188
Performing a Recovery without the Recovery Analysis Report	189
Identifying the Tapes you Need	189
Generating a Recovery Analysis Report after a Failure	189
Using the Recovery Planning and Activity Displays	190
Creating a Recovery Contact List	190
Creating a Recovery Activities List	191
Additional BRMS Restore Commands	193

Chapter 9. Daily Maintenance in BRMS 195

What the STRMNTBRM Command Does	195
Scheduling the STRMNTBRM Command	197
Processing the STRMNTBRM Command in a Backup Control Group	198
Notification of Failure to Process STRMNTBRM	199

Chapter 10. Scheduling Backup and Recovery Jobs. 201

Scheduling Backup and Recovery Jobs	201
Scheduling Control Group Backups	201
Scheduling Selected Recovery Items	204
Working with Scheduled Jobs	204
Keeping Job Log Information	205
Changing the Job Scheduler	205
Some Notes on Substitution Variables	207

Part 3. Advanced Topics in BRMS 209

Chapter 11. The Functional Usage Model and BRMS Security

Considerations.	211
How the Functional Usage Model Works	211
Backup Function	212
Recovery Function	212
Media Management Components	212
System-Related Functions	213
Implementing the Functional Usage Model	213
Registering New BRMS Activities with the Functional Usage Model	214

Working with the SETUSRBRM Command	215
Securing the Console Monitor	216
Working with i5/OS Security Controls	217
BRMS Media Security	217

Chapter 12. Saving to Save Files . . . 219

Specifying Use of Save Files in the Media Policy	219
Specifying use of Save Files in Control Groups	220
Managing Save Files using BRMS	221
Work with Save Files	222
Libraries Containing BRMS Save Files	222

Chapter 13. BRMS and Tivoli Storage Manager (TSM). 223

Using BRMS as a TSM Client	223
Benefits	223
Restrictions	223
Performance	224
TSM Data Retention Protection	225
Setting Up Your BRMS Client	226
Using TSM Automatic Password Management	233
Setup using the BRMS iSeries Navigator Client	233
Setup using a File/Member in Library QUSRBRM	234
TSM Automatic Password Management Operation	234
Using BRMS to Manage Tivoli Storage Manager/PASE Media	235
Benefits	235
Set up in BRMS	235
Set up in TSM/PASE	235

Chapter 14. Networking with BRMS 237

An Overview of BRMS Network Functionality	237
How Shared Media Inventory Synchronization Works	238
How BRMS Networks Communicate	240
Network Configuration	241
TCP/IP Network configuration	241
Configure TCP/IP for Restricted State	242
Relational Database Configuration	243
APPN Network configuration	243
APPC Network configuration	244
Disable APPC Operations	244
How to Set Up a BRMS Network	245
A Step-by-Step Guide to Setting Up Your BRMS Network	245
Manage Your BRMS Network Using the BRMS iSeries Navigator Client	249
Changing the System Name	249
Joining Two BRMS Networks	251
Copying Control Groups Between Networked iSeries Servers	253
Checking BRMS Network Synchronization	254
Removing a System From a Network	255
Removing the Network Feature from a Previously Networked System	257
Seasonal Time Changes of BRMS	257
Setting Clocks Back	257
Setting Clocks Ahead	259

Chapter 15. Online Lotus Server

Backups 261

How Lotus Server Online Backup Works 261

Initialize BRMS For Lotus Server Backups 261

Performing An Online Lotus Server Backup 264

 Determine the device and media class to use 264

 Add media to the media class scratch pool 264

 Start the backup 265

 Recommendations 265

 Restrictions 265

 Lotus Server Backup Performance Tuning 266

 Preprocessing and Postprocessing *EXITs in

 Control Groups 266

 Copying Lotus Server Control Groups 267

 BRMS Incremental Online Lotus Server Backup 268

 View the Catalog of Lotus Server Saved Items 269

Lotus Server Recovery 270

 Recovering a Single Lotus Server Database

 Using the Command Interface 270

 Recovering a Single Lotus Server Database

 Using the BRMS iSeries Navigator Client 271

 Restrictions 271

 Restoring Online and Online Incremental

 Backups 272

 Incremental Recovery to a Different Lotus

 Server or Different Directory 273

Chapter 16. Backup and Recovery of Auxiliary Storage Pool Devices. 279

Backup of Auxiliary Storage Pool Devices 279

 Backing Up User Libraries on Auxiliary Storage

 Pools Devices 280

 Backing Up the System and Basic User

 Auxiliary Storage Pools 281

 Backing Up Multiple Switched Auxiliary

 Storage Pool Devices 281

 Using *SETASPGRP to Back Up Auxiliary

 Storage Pool Devices 282

 Backing Up Spooled Files on Auxiliary Storage

 Pool Devices 283

Recovery of Auxiliary Storage Pool Devices 283

Chapter 17. Using Tape Automation with BRMS 291

Adjustments to BRMS When Using Tape

Automation 291

Setting up Tape Automation with BRMS 291

 Creating Tape Automation on Your System 291

 Basic Setup of a Media Library with BRMS 291

 Enrolling Tape Automation Media (volume) into

 BRMS 292

Save and Restore Tasks 292

 Performing a Normal Save Operation 293

 Save Storage and BRMS 293

 Using the Save Licensed Program Command 293

Recovery Process Using Tape Automation 293

 Recovering an Entire System (Starting with

 Licensed Internal Code) 293

 Completing the Recovery 293

Tasks for Archiving 294

 Archiving When Using Tape Automation 294

 Using Dynamic Retrieval 294

Moving Volumes with BRMS 294

Chapter 18. Tape I/O From A Program 297

Using BRMS for Tape File Processing 299

 Recovery 301

Using BRMS for Input Processing 301

Input/Output Processing with Multiple Devices 303

 1. Create Tape File Objects 303

 2. Compile The Program. 304

 3. Use OVRTAPF to Indicate Which Tape Drives

 to Use 305

 4. Use SETMEDBRM to Involve BRMS in

 Managing the Tape 306

 Call the Program 306

 Results 307

Other Processing Techniques 309

Messages 309

Part 4. Appendixes 311

Appendix A. Merging BRMS Data and Consolidating Systems 313

Merge Consolidation Planning. 313

Merging BRMS data 314

Prerequisites for merging BRMS data 314

Merge BRMS data to Target System with no BRMS 315

Merge BRMS data to Target System with Existing

BRMS 316

Appendix B. A Summary of BRMS Reports 321

ASP Information Report (QP1AASP, QP1AXS) 321

Backup Folder List Report (QP1AFL) 321

Backup Link List Report (QP1AFS) 321

Backup Object List Report (QP1AOB) 321

Backup Plan Report (QP1ABP) 321

Backup Policy Report (QP1ABX) 321

Backup Spooled File List Report (QP1ALQ) 322

Calendar Report (QP1ACA) 322

Centralized Media Audit Report (QP1ASYN) 322

Container Report (QP1ACN) 322

Container Class Report (QP1ACT) 323

Device Report (QP1ADV) 323

Library Backup Analysis Report (QP1ALA) 323

Link Information Report (QP1ADI) 324

Location Analysis Report (QP1A2SL) 324

Log Report (QP1ALG) 324

Media Report (QP1AMM) 325

Media Class Report (QP1AMT) 325

Media Expiration Report (QP1AEP) 325

Media Information Report (QP1AHS) 326

Media Library Report (QP1AMD) 326

Media Library Media Report (QP1A1MD) 326

Media Merge Report (QP1AEN) 327

Media Movement Report (QP1APVMS) 327

Media Policy Report (QP1AME) 327

Media Volume Statistics Report (QP1AVU) 327

Media Volume Threshold Report (QP1AVOL)	328
Move Policy Report (QP1AMP)	328
Recovery Activities Report (QP1ARW)	328
Recovery Analysis Report (QP1ARCY)	329
Recovery Policy Report (QP1ARX)	329
Recovery Volume Summary Report (QP1A2RCY)	329
Save Files Report (QP1ASF)	329
Save Strategy Exceptions Report (QP1ALE)	330
Saved Folders Report (QP1AFD)	330
Saved Objects Report (QP1AOD)	330
Saved Spooled Files by Date Report (QP1AOQ)	330
Storage Location Report (QP1ASL)	330
System Policy Report (QP1ASP)	331
TSM Performance Analysis Report (QP1ATSMRPT)	331
Version Control Report (QP1AVER)	331
Volume Movement Report (QP1AVMS)	332

Appendix C. APIs and Exit Programs 333

Control Group Exit Program	333
Restrictions	334
Authorities and Locks	334
Usage notes	334
Required Parameter Group	334
Control Information	335
Control Group Entry Information	336
Tape Information Exit Program	337
Required Parameter Group	337
Format of Operational Information	337
Field Descriptions	338
Tape Movement Exit Program	338
Required Parameter Group	338
Format of Operational Information	339

Field Descriptions	339
BRMS Object Retrieval Exit Program	340
Required Parameter Group	341
Format of Object Description Information	341
Field Descriptions	341
Format of Media Information	342
Field Descriptions	342
Format of Control Value Information	342
Field Descriptions	343
BRMS Retrieve Media Information (Q1ARTVMED)	
API	343
Required Parameter Group	343
Format of the Generated Information	344
Field Descriptions	344
Format of Control Value Information	345
Field Descriptions	345
Error Messages	346
BRMS Select Device (Q1ASLTDEV) API	346
Required Parameter Group	347
Format of Generated Information	347
Field Descriptions	347
Format of Control Value Information	347
Field Descriptions	348
Error Messages	348

Appendix D. Notices 349

Trademarks	350
Terms and conditions	351

Index 353

About Backup, Recovery and Media Services for iSeries (SC41-5345-05)

This book provides information on how to install and use Backup, Recovery and Media Services (BRMS) for iSeries™ product. This information includes instructions on how to design and implement a comprehensive backup, recovery, and media management strategy for your company. Following is a list of the topics that are discussed in this book:

- Installing and initializing BRMS.
- Installing the BRMS iSeries Navigator client.
- An immediate backup of your entire system.
- Use BRMS recovery reports to assist you in recovering your entire system.
- Tailor a backup strategy that best suits the specific needs of your company.
- Perform recoveries of selected libraries and objects.
- Design an effective, automated media tracking system using BRMS.
- Perform daily and weekly maintenance tasks in BRMS.
- Secure your backup, recovery, and media operations.
- Saving to save files.
- Establish BRMS as a client to Tivoli® Storage Manager (TSM).
- Create a network of BRMS systems.
- Setup for online backup of Lotus® servers.
- Backup and recovery of auxiliary storage pool devices.
- Using tape automation with BRMS.

This book provides step-by-step instruction on how to perform each of these tasks, and provides detailed examples whenever possible.

Many BRMS functions are available through the BRMS iSeries Navigator client. For more information on the BRMS functions that are available in iSeries Navigator. Follow these links to locate the BRMS topics in the Information Center:

<http://www.ibm.com/eserver/iseries/infocenter>
Systems Management⇒Backup and Recovery⇒Backup, Recovery and Media Services

Who should read this book

This book is designed for system administrators and operators who work with BRMS on a regular basis, and for those responsible for designing backup, recovery, and media management strategies.

This book assumes familiarity with standard usage and terminology. It also assumes familiarity with the *Backup and Recovery*, SC41-5304-08 book.

Prerequisite and related information

Use the iSeries Information Center as your starting point for iSeries technical information.

You can access the Information Center two ways:

- From the following Web site:
<http://www.ibm.com/eserver/iseries/infocenter>

- From the *iSeries Information Center*, SK3T-4091-04 CD-ROM. This CD-ROM ships with your new iSeries hardware or IBM i5/OS software upgrade order. You can also order the CD-ROM from the IBM® Publications Center:

<http://www.ibm.com/shop/publications/order>

The iSeries Information Center contains new and updated iSeries information such as software and hardware installation, Linux®, WebSphere®, Java™, high availability, database, logical partitions, CL commands, and system application programming interfaces (APIs). In addition, it provides advisors and finders to assist in planning, troubleshooting, and configuring your iSeries hardware and software.

With every new hardware order, you receive the *iSeries Setup and Operations CD-ROM*, SK3T-4098-02. This CD-ROM contains IBM @server IBM eServer iSeries Access for Windows and the EZ-Setup wizard. iSeries Access Family offers a powerful set of client and server capabilities for connecting workstations to iSeries servers. The EZ-Setup wizard automates many of the iSeries setup tasks.

How to send your comments

Your feedback is important in helping to provide the most accurate and high-quality information. If you have any comments about this book or any other iSeries documentation, fill out the readers' comment form at the back of this book.

- If you prefer to send comments by mail, use the readers' comment form with the address that is printed on the back. If you are mailing a readers' comment form from a country or region other than the United States, you can give the form to the local IBM branch office or IBM representative for postage-paid mailing.
- If you prefer to send comments by FAX, use either of the following numbers:
 - United States, Canada, and Puerto Rico: 1-800-937-3430
 - Other regions: 1-507-253-5192
- If you prefer to send comments electronically, use one of these e-mail addresses:
 - Comments on books:
RCHCLERK@us.ibm.com
 - Comments on the iSeries Information Center:
RCHINFOC@us.ibm.com

Be sure to include the following:

- The name of the book or iSeries Information Center topic.
- The publication number of a book.
- The page number or topic of a book to which your comment applies.

Summary of Changes

| The following is a comprehensive summary of the enhancements to Backup, Recovery and Media Services (BRMS) for iSeries for V5R4M0.

BRMS functionality is always being enhanced. Enhancements between regularly scheduled software releases are provided by PTF. You should periodically review the BRMS web site at: <http://www.ibm.com/servers/eserver/iseries/service/brms/> to learn of any new functions that might improve your backup and recovery strategy.

Another good source of operational information about BRMS is Informational APAR II09772 — Index of BRMS Informational APARs. It is good practice to review this APAR periodically for new Informational APARs that might be of interest to your implementation of BRMS.

For detailed information on the BRMS client to iSeries Navigator, see the iSeries Information Center, or download and review the BRMS Graphical User Interface Student Guides which can be found on the BRMS web site at: <http://www.ibm.com/servers/eserver/iseries/service/brms/plugginguide.htm>.

Software Enhancements

| The following sections describe the software enhancements to the BRMS commands, policies, displays, menus and iSeries Navigator client.

| Command Changes

| This section describes the new command parameters or new special values added to existing parameters. See the command help for additional information about these special values or parameters, and any restrictions which may apply to their use.

- | • Add Media to BRM (ADDMEDBRM) command

| The *Image catalog (IMGCLG)* parameter was added to allow you to add virtual tape volumes to the BRMS media inventory. This parameter defines the image catalog containing the virtual tape volume.

- | • Change Media using BRM (CHGMEDBRM) command

| The *Image catalog (IMGCLG)* parameter was added to allow you to change the name of the image catalog name containing the virtual tape volume.

- | • Duplicate Media using BRMS (DUPMEDBRM) command

| Special value *SCHHST was added to the *Volume (VOL)* parameter to enable duplication of marked saved items in the history information.

| Special value *RESUME was added to the *Volume (VOL)* parameter to allow you to resume a pending duplication operation that ended abnormally. This special value is used in conjunction with the new *Resume key (RSMKEY)* parameter to identify the specific duplication operation to be resumed.

| Special value *LEAVE was added to the list of special values for the *From end option (FROMENDOPT)* and *To end option (TOENDOPT)* parameters for consistency with other commands.

| The *Mark history for duplication (MARKHST)* parameter was added to allow you to remark duplicated saved items for a subsequent duplication.

| The *Save Media Information (SAVMEDI)* parameter was added to allow you to save the BRMS media information after the duplication operation has successfully completed.

- | • Initialize BRMS (INZBRM) command

| Special value *ESTPRDUPD was added to the *Option (OPTION)* parameter. You can use this option to help you plan for a BRMS product upgrade to a later release. This option returns an estimate of the amount of time required to convert the BRMS database records in the current release to the new record format of the target release.

| The *Target release (TGTRLS)* parameter was added to allow you to specify the release of a planned product update. This parameter must be specified when *ESTPRDUPD is specified for the OPTION parameter.

- Restore Object using BRM (RSTBRM) command

| The *Parallel resources (PRLRSC)* parameter was added to allow you to restore Integrated File System (IFS) objects saved using parallel devices.

| The *Create parent directories (CRTPRNDIR)* and *Parent directories owner (PRNDIROWN)* parameters were added to allow you to better manage the restoration of Integrated File System (IFS) objects when the parent directory does not exist on the system.

- Restore Library using BRM (RSTLIBBRM) command

| Special value *SAVDATE was added to the *Save level (SAVLVL)* parameter and is used in conjunction with the new *Save date (SAVDATE)* parameter to specify by date the level of the library to be restored.

| The *Spool file data (SPLFDTA)* parameter was added to allow you to restore spooled files that were saved concurrently with saved output queues.

- Restore Object using BRM (RSTOBJBRM) command

| Special value *SAVDATE was added to the *Save level (SAVLVL)* parameter and is used in conjunction with the new *Save date (SAVDATE)* parameter to specify by date the level of the objects to be restored.

| The *Spool file data (SPLFDTA)* parameter was added to allow you to restore spooled files that were saved concurrently with saved output queues.

- Save Object using BRM (SAVBRM) command

| The *Parallel resources (PRLRSC)* parameter was added to allow you to save Integrated File System (IFS) objects using parallel devices.

| The *Mark history for duplication (MARKHST)* parameter was added to allow you to mark the history items saved by this command for duplication.

- Save DLO using BRM (SAVDLOBRM) command

| The *Mark history for duplication (MARKHST)* parameter was added to allow you to mark the history items saved by this command for duplication.

- Save Folder List using BRM (SAVFLRLBRM) command

| The *Mark history for duplication (MARKHST)* parameter was added to allow you to mark the history items saved by this command for duplication.

- Save Library using BRM (SAVLIBBRM) command

| The *Spool file data (SPLFDTA)* parameter was added to allow you to save spooled files concurrently with saved output queues.

| The *Mark history for duplication (MARKHST)* parameter was added to allow you to mark the history items saved by this command for duplication.

- Save Media Info using BRM (SAVMEDIBRM) command

| The *Mark history for duplication (MARKHST)* parameter was added to allow you to mark the history items saved by this command for duplication.

- Save Object using BRM (SAVOBJBRM) command

| The *Spool file data (SPLFDTA)* parameter was added to allow you to save spooled files concurrently with saved output queues.

| The *Mark history for duplication (MARKHST)* parameter was added to allow you to mark the history items saved by this command for duplication.

- Save Object List using BRM (SAVOBJLBRM) command

- | The *Spool file data (SPLFDTA)* parameter was added to allow you to save spooled files concurrently with saved output queues.
- | The *Mark history for duplication (MARKHST)* parameter was added to allow you to mark the history items saved by this command for duplication.
- | • Save System using BRM (SAVSYSBRM) command
 - | The *Mark history for duplication (MARKHST)* parameter was added to allow you to mark the history items saved by this command for duplication.
- | • Set Media Controls using BRM (SETMEDBRM) command
 - | The *Mark history for duplication (MARKHST)* parameter was added to allow you to set the current BRMS environment so that saved items added to history are marked for duplication .
- | • Start Maintenance using BRMS (STRMNTBRM) command
 - | The Audit system media function was removed and the value of the Audit system media (AUDSYSMED) parameter is ignored beginning with V5R4M0.
- | • Start Recovery using BRMS (STRRCYBRM) command
 - | BRMS continues to enhance the Recovering the Entire System (QP1ARCY) report. The report detail has been improved with new steps. New attention notices help identify problems that could affect a successful recovery. Among the notices are an analysis of libraries not saved and libraries excluded from the report.
 - | The **RESUME* option was enhanced to allow you to run concurrent recoveries by sharing the saved items across jobs.
 - | The *Use duplicate media (USEDUPMED)* parameter was added to allow you to specify whether duplicate media should be used for selecting the recovery items. You might want to consider using this parameter if you send the original media off-site after media duplication.
 - | The *User recovery information (USRRCYINF)* parameter was added to allow you to specify that you have created special recovery instructions for recovery and that you want these included in the recovery report. See “User Customized Recovery Step Information” on page 29 for additional information.
- | • Work with Devices (WRKDEVBRM) command
 - | WRKDEVBRM command has been enhanced so you can add virtual tape devices and TSM devices enabled for data retention protection.
- | • Work with Saved Objects (WRKOBJBRM) command
 - | The *Auxiliary storage pool (ASP)* parameter was added to allow you to filter the view of saved objects by auxiliary storage pool name or number.

Changes to Policies

- | This section describes new displays or prompts added to control groups and policies . See the display and prompt help for additional details.
- | • Archive Control Groups
 - | Archive items restrictions were removed from archive control groups using parallel devices. Archive control groups using parallel devices can now contain any archive item. Archive items that support parallel will be saved using parallel, those that do not will be saved using serial.
 - | In addition, the following prompts were added to the *Change Archive Control Group Attributes* display:
 - | – *Automatically backup media information* prompt for specifying whether media information should be saved after the archive operation and the level of media information to be saved.
 - | – *IPL restart type* for specifying the type of restarts to be performed.
- | • Archive Policy
 - | The following prompts were added to the *Change Archive Policy* display:
 - | – *Automatically backup media information* prompt for specifying whether media information should be saved after the archive operation and the level of media information to be saved.
 - | – *IPL restart type* for specifying the type of restarts to be performed.

- | • Backup Control Groups
 - | Backup items restrictions were removed from backup control groups using parallel devices. Backup control groups using parallel devices can now contain any backup item. Backup items that support parallel will be saved using parallel, those that do not will be saved using serial.
 - | Special value *SAVSYSINF was added as *Backup Item* on the *Edit Backup Control Group Entries* display to allow for the backup of selected system information when not in restricted state.
 - | The following prompts were added to the *Change Backup Control Group Attributes* display:
 - | – *Force full backup days* for specifying when a full backup should occur relative to the last backup during saves of changed objects in libraries.
 - | – *Save spooled file data* for specifying whether spooled files should be saved concurrently with saved output queues.
 - | – *IPL restart type* for specifying the type of restarts to be performed.
 - | – *Backup item exit program* for specifying a user exit program which can be called after each backup item or group of items is processed. See “Control Group Exit Program” on page 333 for additional information.
 - | – *Missed object policy* for specifying whether should track objects missed during the backup and the name of the policy to stored the missed objects.
- | • Backup Policy
 - | The following prompts were added to the *Change Backup Policy* display:
 - | – *Force full backup days* for specifying when a full backup should occur relative to the last backup during incremental saves.
 - | – *Save spooled file data* for specifying whether spooled files should be saved for saved output queues.
 - | – *IPL restart type* for specifying the type of restarts to be performed.
 - | – *Backup item exit program* for specifying whether BRMS should call a user exit program after each backup item (or group of items) is processed.
 - | – *Missed object policy* for specifying whether should track objects missed during the backup and the name of the policy to stored the missed objects.
- | • System Policy
 - | The following was added to the *Change Network Group* display:
 - | – A new *System Status* column indicates the *Online* or *Offline* status of each network system relative to the current system which can be used to help you easily determine whether the current system is or is not communicating with other systems in the network.
 - | – A new *Notify period* prompt lets you specify how often you want to be notified of systems which are currently *Offline*.
 - | – A new parameter *Allow alternate input media* on the *Change System Policy* screen has been added. This new parameter enables the use of an alternate media when the requested input media is not available.
- | • Recovery Policy
 - | The following prompts were added to the *Change Recovery Policy* and *Restore Command Defaults* displays:
 - | – *Restore spooled file data* for specifying whether spooled files are restored with restored output queues.
 - | – *Create parent directories* and *Parent directories owner* prompts for specifying how to manage the restoration of Integrated File System (IFS) objects when the parent directory does not exist on the system.

| Display Changes

- | This section describes changes to other displays. See the display and prompt help for additional details.
- | • Enhancements to the *Change Media Policy* display include the following:

- | A *Mark history for duplication* prompt was added for specifying in the media policy whether items saved using this policy should be marked for duplication.
- | • Enhancements to the *Display Media Information* display include the following:
 - | *Parallel Devices* prompt to show the number of parallel devices used to save the item.
 - | *Saved spooled file data* prompt to show whether the saved item includes saved spooled files.
 - | *Duplicate save item* prompt to show whether the saved item is a duplicate of another saved item.
 - | *Mark for duplication* prompt to show whether the saved item is marked for duplication.
 - | *Duplication resume key* prompt to show the resume key assigned to the saved item for a pending duplication operation.
- | • Enhancements to the *Select Recovery Items* display include the following:
 - | New object view was added to facilitate displaying of *Parallel Devices* and *Objects Not Saved*.
 - | Special values *LTSONL and *LTSINC were added to *Save Type* to easily identify Lotus server saves from other saved links. In addition, the Lotus server subsystem name appears for *Saved Item* instead of *LINK to further distinguish Lotus server saves from other *LINK saves.
 - | New functions on the F16 key allow you to select saved items by volume, set of volumes, all save file, or all TSM saves.
- | • Enhancements to the *Work with Devices* display include the following:
 - | Special value *VRTTAP added to *Category* for identifying and adding virtual tape devices.
 - | A new *Retention Protection* prompt was added for *NET devices to identify TSM servers which use data retention protection like the IBM Data Retention (DR) 450 and DR550 servers.
- | • Enhancements to the *Work with Lists* display include the following:
 - | The function of backup object lists was changed to be used as backup library lists.
 - | A new *Expiration view* was added to Backup spooled file lists. Use this view to specify an expiration date for spooled files saved by the list.
- | • Enhancements to the *Work with Media Information* display include the following:
 - | New *Duplication status* view was added to facilitate displaying of duplicate saved items, saved items marked for duplication, and the duplication resume key.
 - | Special values *LTSONL and *LTSINC were added to *Save Type* to easily identify Lotus server saves from other saved links. In addition, the Lotus server subsystem name appears for *Saved Item* instead of *LINK to further distinguish Lotus server saves from other *LINK saves.
- | • Enhancements to the *Work with Media Library Media* and *Display Media Attributes* displays include the following:
 - | A new *Media Type* field is provided to identify the cartridge type for removable media volumes that report this information. The field is blank if the media library is not equipped with bar code readers.

Menu Changes

- | This section describes changes to BRMS menus. .
- | • The Option 53: Print TSM Performance Analysis was added to the BRMRPT menu to assist in analyzing the performance of recent save and restore activity with TSM servers. This option generates report QP1ATSMRPT.

BRMS iSeries Navigator Client Enhancements

- | BRMS continues to move character-based interface functions into the graphical user interface provided by the BRMS iSeries Navigator and to improve the existing BRMS client functions. Enhancements to the BRMS client for V5R4 include the following:
 - | • There is more help and it provides better detail.
 - | • The performance when displaying many of the panels and dialogs has been improved.
 - | • The *Add Media Wizard* was updated to enable adding virtual volumes to the media inventory.

- | • Archive control groups and archive lists have been ported to the BRMS client and can now be managed using the tasks and functions provided in the new *Archive Policies* folder, or *Archive Tasks* from the BRMS Task Pad.
- | • Backup policy properties have been updated to include the following new attributes:
 - | – New *Backup item exit program* and *Backup policy and list for missed objects* group boxes on the *Advanced Properties - What to Back Up* panel.
 - | – New *Mark saved items for duplication* property on the *Advanced Properties - Where to Back Up* panel.
 - | – New *Force a full backup if the last full is maximum days old or older* property on the *Activity* panel.
- | • *Global Policy Properties* has several new features. Among these are:
 - | – **Logging**
The *Logging* tab on *Global Policy Properties* has two new functions relating to logged messages.
 - | 1. *Messages to exclude from the log*
You can add log message identifiers to a list of messages which you do not want recorded in the BRMS log. Use this function to filter messages of little importance to your daily operations.
 - | 2. *Messages to distribute*
You can add log message identifiers to a list of messages you want distributed as email. This function is useful for sending key messages electronically to a cellular telephone, pager, or internet mailbox. The destination address for the distributions is specified in the *Distribution* group box on the *Network* tab, where you specify the BRMS network system you want to use to distribute the messages, and any byte restriction you want to place on the messages. Message distribution requires a license to the BRMS Networking feature.
 - | – **Network**
The *Network* tab on *Global Policy Properties* includes several new functions available with the network feature.
 - | - Use the *Offline notification period* property to establish how often you want the current system to notify you when it cannot communicate with another system in the network. In prior releases, this notification occurred using the *System update interval* and could result in a noisy message queue. The new function helps you minimize the noise for network systems that regularly go offline for fixed periods of time.
 - | - BRMS network systems require communication with other network systems to maintain the shared media information. This becomes problematic when the system needs to be in restricted state. The properties of *Network restricted state interfaces to start* allows you to define specific interfaces which you want BRMS to start while in restricted state to perform these network operations.
 - | - *System Status* has been added to *Systems in network* to provide the online or offline status of the networked systems relative to the current system. This is different from *Network Status* which only indicates whether the networked systems have been activated on the network.
- | • A new *Manage Disk Pools* task lets you update the properties of disk pools, or to create and manage disk pools groups.
- | • The *Manage Devices* task has been enhanced to provide these new functions:
 - | – Add, update and display user-defined media libraries.
 - | – Delete obsolete TSM connection names.
 - | – Add virtual tape devices if the description objects exist on the server.
 - | – Add or change a TSM device that is enabled for data retention protection.
- | • You can now specify on *Move* policy properties whether the policy should use containers. A new *Manage Containers* task helps you to manage containers and container groups.
- | • The *Tape volume Include* panel has been a new field so you can filter the media view by *Image catalog*. This is useful for retrieving all virtual volumes or virtual volumes in specific image catalogs. Also, *Containers* has been added as an optional column on the *Tape Volumes* panels.

- The *Verify moves* task has been enhanced to include an option to create a HTML report of the volumes selected for the verify move operation.

Compatibility

The following changes have been made to BRMS functions which may affect your operations.

- Physical files

Many BRMS physical files are required to be converted to a new record format after installation. A job to complete this conversion is submitted to the batch job queue upon successful completion of install.

The BRMS menu and command interfaces cannot be used until the conversion job completes. If the system is in restricted state during install, the conversion job will remain on the job queue. The record format conversion is required only once each release. See “Planning for the Install” on page 10 for additional information.

- Printer files

The header records of all BRMS printed reports were changed. The header fields are now consistent across all reports and have the same fields and starting positions.

Position	Header field description
002-034	Product/Version
035-083	Report title
084-094	System name
095-119	Date/Time
120-132	Page number

- Start Maintenance using BRMS (STRMNTBRM) command

The Audit system media function was removed and the value of the Audit system media (AUDSYSMED) parameter is ignored.

- Section “BRMS Retrieve Media Information (Q1ARTVMED) API” on page 343 was updated to correct the length of required parameter 4 from 27 bytes to 33 bytes reflecting the true length of all fields in the control information.

Performance

BRMS changed to use native i5/OS™ support for saving and restore spooled files. This should result in a performance improvement if you save spooled files as part of your regular backup operations.

There is no performance gain when saving spooled file to a target release prior to V5R4M0 since this cannot use the native function.

Book Enhancements

This section outlines the major additions and updates made to this book for V5R4.

- The following section was added to Chapter 3, “Backing Up Your Entire System,” on page 17.
 - “Backup and Recovery Log” on page 21
- The following sections were added to Chapter 4, “Recovering Your Entire System,” on page 27.
 - “User Customized Recovery Step Information” on page 29
 - “Using the STRRCYBRM command” on page 31
 - “Resume a Recovery” on page 31
 - “Concurrent Recovery” on page 33
 - “Prolog” on page 36
- Chapter 5, “Working with Devices in BRMS,” on page 69 was updated to include information on creating and using virtual tape devices.
- The following sections were added to Chapter 6, “Setting Up Your Media Management Operation,” on page 77.

- | – “Enrolling Virtual Tape Volumes” on page 81
- | – “Duplicating Saved Items” on page 105
- | – “Resuming Duplication” on page 105
- | – “Reclaiming Media” on page 106
- | • The following sections were added to Chapter 7, “Tailoring Your Backup,” on page 109.
 - | – “Using Missed Object Policies” on page 148
 - | – “Using an Object List as a Library List” on page 132
 - | – “Expiring Saved Spooled Files” on page 135
 - | – “Using Missed Object Policies” on page 148
 - | – “Scenario 4: Performing Parallel and Serial Backups in the Same Control Group” on page 159
- | • The following section was added to Chapter 8, “Performing Selected Recoveries,” on page 163.
 - | – “Recovering Spooled Files Saved with Output Queues” on page 183
- | • The following sections were added to Chapter 13, “BRMS and Tivoli Storage Manager (TSM),” on page 223.
 - | – “Performance” on page 224
 - | – “TSM Data Retention Protection” on page 225
- | • Section “Control Group Exit Program” on page 333 was added to Appendix C, “APIs and Exit Programs,” on page 333.

Information Center Enhancements

The BRMS topics in the Information Center were updated to include the new functions in the BRMS iSeries Navigator client. Follow these links to locate the BRMS topics in the Information Center:

<http://www.ibm.com/eserver/iseriess/infocenter>
Systems Management⇒Backup and Recovery⇒Backup, Recovery and Media Services

Part 1. Getting Started with BRMS

Chapter 1. Introduction to IBM Backup Recovery and Media Services for i5/OS (BRMS)

The Backup Recovery and Media Services (BRMS) product provides separately priced, separately installed components. These components consist of a standard product and two additional features. You can find the latest information about BRMS on the Internet at this location:

<http://www.ibm.com/servers/eserver/iseriesservice/brms/brms.htm>.

Note: If you have not purchased the BRMS product, you can install and use the standard product and the additional features without a license for a 70 day trial period. Contact your IBM representative if you want to purchase a license for BRMS.

The following is a summary description of the base product and the additional features.

BRMS Standard

The standard product provides you with the capability to implement a fully automated backup, recovery, and media management strategy for your iSeries system. Use BRMS with shared or stand-alone tape devices, automated tape libraries, Tivoli Storage Manager(TSM) servers, and an unlimited number of volumes.

Notes:

1. The standard BRMS product does not provide support for archive, dynamic retrieval, automated migration operations or shared media. You must purchase and install the features in order to use these functions.
2. BRMS does not support diskette, optical, unlabeled or nonstandard label tape.

Many of the features in the BRMS standard product are available as a client to iSeries Navigator. For detailed information on the BRMS iSeries Navigator client, see the iSeries Information Center.

BRMS Network Feature

The BRMS Network feature enables a BRMS system to interconnect via a network to other BRMS networked systems. A networked BRMS system can share the inventory and policies that are associated with media that is managed by a central BRMS system.

A BRMS networked system can be another iSeries system or iSeries logical partition.

You can also use the network feature to distribute messages sent to the Backup and Recovery Log. You can send up to 5000 bytes of any message electronically to a cellular telephone, pager, or mailbox which uses an internet address. See "Sending Log Messages" on page 23 for additional information.

BRMS Advanced Functions Feature

The BRMS Advanced Functions feature provides hierarchical storage management (HSM) capability which includes archive, dynamic retrieval, and automatic auxiliary storage pool (ASP) migration. This book provides information on how to use the three primary functions (backup, recovery, and media management) of the standard BRMS product. It also includes information on how to use the Network feature. You can find information on the Advanced Functions components, such as archive, retrieve, and migration, in *Hierarchical Storage Management*, SC41-5351-01. You can order a copy of *Hierarchical Storage Management*, SC41-5351-01, when you purchase the Advanced Functions feature.

Overview of Standard BRMS Product Functionality



Figure 1. The Standard BRMS Functions

The standard BRMS product assists you in defining and processing your backup, recovery, and media management operations. Through user-defined controls, BRMS works in conjunction with your iSeries system to manage your most critical and complex backups while simplifying day-to-day operational tasks. The standard BRMS product provides three basic functions.

- **Backup:** BRMS backup assists you in establishing a disciplined approach to designing and managing your backup operations. It helps you to define, process, monitor and report your backup activities. Use BRMS to back up all of the data on your iSeries system including objects in libraries, folders, directories, spooled files, security information, system configurations, and the operating system itself. To do this, you can use the default backup control groups, already set up in BRMS, or you can design your own backup operation to suit more specific needs.
- **Recovery:** BRMS recovery provides for the orderly retrieval of lost or damaged data. Its most important feature is a series of recovery reports that take you, step-by-step, through the recovery of your system. These reports not only contain restore instructions, but also indicate which tapes the system requires for the recovery. With BRMS, you can restore your entire system, or selected items such as control groups, libraries, objects, folders, auxiliary storage pools (ASPs), spooled files, or Integrated File System links.
- **Media Management:** BRMS media management tracks all of your tapes and save files. Media is tracked through all cycles from tape creation to expiration. The tracking process includes active use, storage location, and return to scratch pool availability. BRMS tracks your media until you remove it from the media inventory or until it is otherwise disabled due to usage threshold or poor quality rating. BRMS also records and updates changes to the media inventory.

Figure 2 on page 5 illustrates how BRMS processes backups and recoveries through the media management system. Policies, control groups, and devices link the backup and recovery processes.

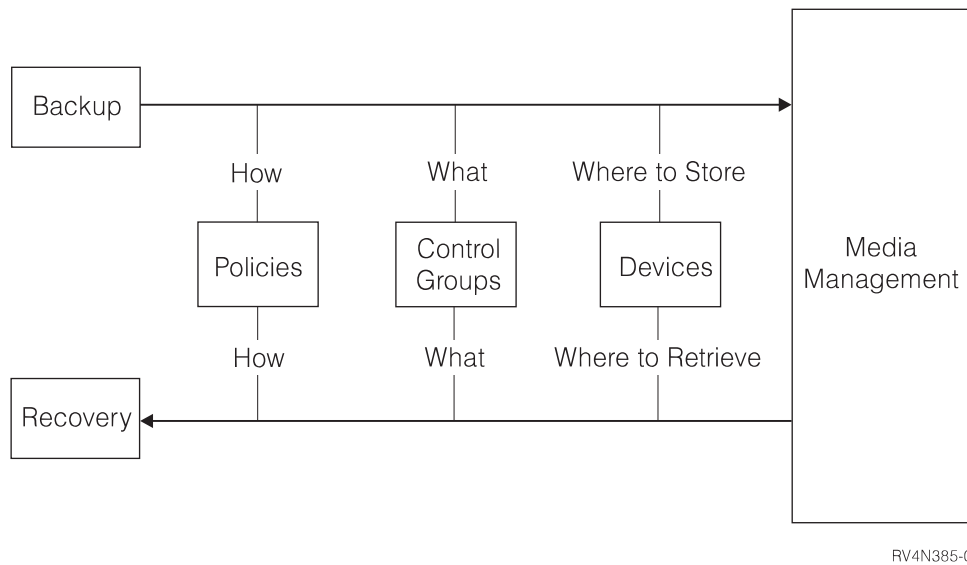

Figure 2. How the standard functions work together

Policies and control groups tell BRMS how and what to back up or recover. The media management system tells BRMS where to store the data and where to retrieve it.

How BRMS Policies Work

Policies define how BRMS operations are generally to be done, similar to the ways in which system values control how your iSeries operates. They establish actions and assumptions that are used during processing. They also provide a single point of control for administering broad changes in operating principles. Each policy provides a template for managing backup and media management strategies at high levels.

Types of Policies

The standard BRMS package provides the following policies:

- The **System Policy** is very similar to a set of system values. Unless other policies or controls are in place, system policy parameters determine the policy defaults for many of your BRMS operations.
- The **Backup Policy** specifies how to perform backups. You can define weekly backup activities, types of incremental backup, and the level at which you want to save media information. One backup policy governs all backup operations. You can define or change these operations at the control group level.
- The **Recovery Policy** defines how recovery operations are generally to be performed. One recovery policy governs all recovery operations. You can redefine or change recovery command values to allow for single or phased recoveries.
- The **Media Policies** govern the handling of media by media type. Media policies determine retention periods and instruct BRMS where to find the appropriate tapes to perform your backup. They also determine if backup operations will create and use save files. Unlike system, backup, and recovery policies, multiple media policies can exist.
- The **Move Policy** determines the movement of media from creation through expiration, and through various on and off site storage locations. Multiple move policies can also exist.

How BRMS Control Groups Work

Control groups consist of groups of libraries, objects, folders, spooled files, and other types of data that share common characteristics or that you want grouped together for backup purposes. Whereas policies determine *how* data is processed, control groups determine, by their content, *which* data to process. They also specify what kind of backup you want BRMS to perform, such as full, incremental, or cumulative-incremental. In addition, control groups specify which days the data will be processed, and the order in which the processing occurs. Control groups usually refer to, and work with, related policies. You can set control group attributes to override policy decisions.

Though you cannot create control groups specifically for a recovery job, BRMS does efficiently recover data by control groups.

How Policies and Control Groups Work Together

The media, move, backup, and recovery policies are sometimes called function policies because they pertain to specific, core BRMS functional activities. The system policy is called a global policy because BRMS applies many of its values to the core functional activities.

Figure 3 illustrates the hierarchical relationship between policies and control groups.

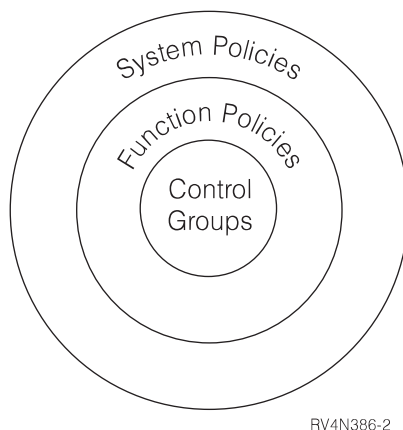

Figure 3. The policy and control group hierarchy

As you can see, the system policy is global and encompasses the function policies and the control groups. Unless otherwise altered, the information contained in system policy parameters overrides information that is contained in function policy parameters. By the same token, function policy information, unless otherwise altered, overrides control group information.

However, because save and restore needs vary depending on customer needs, policies and control groups that share the same parameters and values can override one another. In this way, a function policy value can override a shared system policy value, and a control group value can override a shared function or system policy value. The following examples illustrate override capability:

- The system policy uses a default media policy that is called FULL, which indicates that, among other things, media must be kept for 35 days. Suppose, however, that you want to retain media for a longer period. In this case, you could specify the name of a different media policy in the backup policy at the *Media policies for full backups* field. In this way, a function policy can override a system policy value.
- A system policy default value instructs BRMS **not** to send a message to sign off interactive users before a save operation begins. There may, however, be occasions when the contents of a particular control group require that users be off the system during save processing. In that case, you would change the value in the *Sign off interactive users* field on the Change Backup Control Group Attributes display from

*NO to *YES. *YES, in this instance, means that users cannot access that control group during save processing. In this way, a control group value can override a policy value.

BRMS comes with several predefined values (called defaults) so that you can immediately begin carrying out your backup, recovery, and media management operations. You can change all or any of the default values at any time to better reflect the needs of your company. If you have modified the default values, you can reset these back to the default values by running the INZBRM OPTION(*DATA) command.

BRMS also comes with predefined backup control groups that allow you to perform an immediate and comprehensive backup of your entire system. You can find more information on the default backup control groups in Chapter 3, "Backing Up Your Entire System," on page 17. You can find additional information on BRMS policies in Part 2, "Tailoring Your BRMS Operations," on page 67.

The BRMS Media Management Components

Use the BRMS Media Management to create an automated tracking system for all of your media activities. BRMS provides a variety of components with which you can track, protect, and store your media. Because BRMS Media Management is large and diverse, we have arranged its components into groups. Placing the media management components into groups gives you an easy understanding of the components available and the ways in which you can use them.

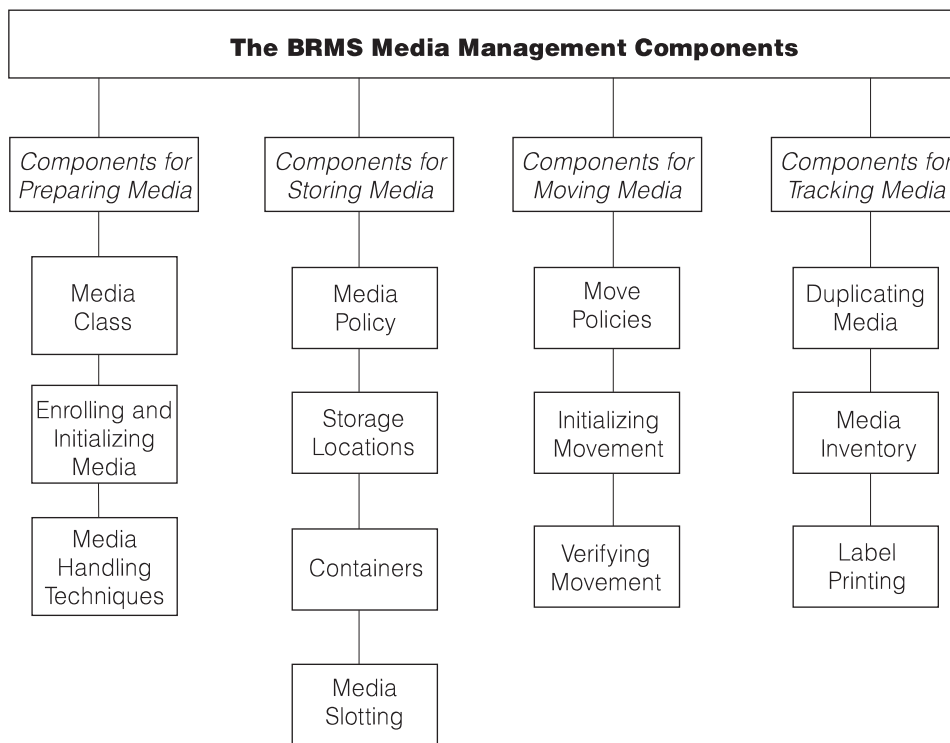

RV4N387-2

Figure 4. The BRMS Media Management Components

Components for Preparing Media

Use these components to prepare your media for backup or recovery processing. These components include media classes, and techniques for enrolling, initializing, and handling media.

Components for Storing Media

Use these components to define and track storage location and media retention information.

Components for Moving Media

Use these components to coordinate and track media movement from one storage location to another and to verify scheduled movement. These components include move policies, move commands, and move monitoring techniques.

Components for Tracking Media

Use these components to assist you in tracking media through various stages of your backup, recovery, and media management operations. These components include the BRMS media inventory database, and techniques for duplicating media and printing media labels.

You can design your media management operation to use all of these components, or to use only those desired for specific purposes. You may use some of these components frequently and some not at all. See Chapter 6, “Setting Up Your Media Management Operation,” on page 77 for information and instruction on how to use the media management components.

How the BRMS Functional Components Work Together

Figure 5 illustrates the ways in which the backup and recovery policies and control groups work with the various media management components to provide comprehensive backup, recovery, and media management support.

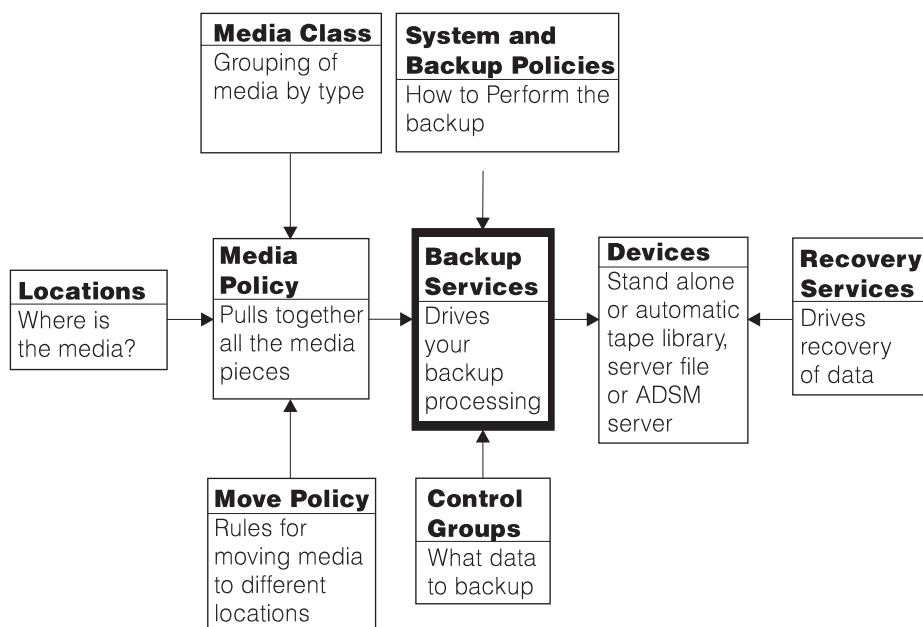

RV4N392-4

Figure 5. How the BRMS functional components come together

Chapter 2. Installing and Initializing BRMS

This chapter provides information on how to install or remove BRMS on your iSeries server. It also discusses the types of hardware that are compatible with BRMS, and the kind of software that you need to install prior to installing BRMS. In addition, this chapter provides a list of things for you to consider before and after installation to help ensure your effective use of BRMS.

This chapter also describes how to install or remove the BRMS iSeries Navigator client on your workstations. It does not describe how to install iSeries Access for Windows[®], see the iSeries Information Center.

Before installing BRMS, carefully review the next section to ensure that you can meet BRMS hardware and software requirements.

Hardware Considerations

BRMS is compatible with all iSeries RISC system models. The following types of media and tape library devices are compatible with BRMS:

- All types of iSeries tape media.
- All iSeries standalone tape devices.
- All iSeries media libraries (MLBs).
- Use of save files.
- Use of TSM servers.

BRMS **does not** support diskette, optical, unlabeled or nonstandard label tape.

During installation, BRMS automatically registers and initializes the devices attached to your iSeries and creates corresponding device information entries. **It is very important that you attach the devices that you plan to use before installing BRMS.** If you add devices after the installation, you must run the initializing process again to register the new devices with BRMS. Use the Initialize BRMS (INZBRM) command with the parameter OPTION(*DATA).

Note: See Chapter 5, “Working with Devices in BRMS,” on page 69 for more information on how to use BRMS to add or change devices and device information.

Software Considerations

You must install the Media and Storage Extensions (MSE) feature on your iSeries *before* you install BRMS. If MSE is not installed, BRMS cannot register the exit points and your saves will not complete.

- | You must have library QUSRBRM on the system before installing 5722BR1 if you are upgrading from a prior version/release BRMS or changing the primary language of BRMS.

Installing Media and Storage Extensions (MSE)

Take the following steps to install MSE on your machine:

1. Enter GO LICPGM from a command line.
2. At the Work with Licensed Programs display, select option 11 (Install Licensed Programs).
3. Select licensed program 5722SS1, option 18, Media and Storage Extensions (MSE), and press Enter.
4. Press Enter at the next display to confirm your selection.

5. At the Install Options display, type in the name of your installation device as requested. Press Enter to start the installation.
6. Review the job log to ensure that the installation completed successfully. Use the Display Job Log (DSPJOBLOG) command to review the job log.

You also need to ensure that the QSYS2 library is in your system library list. Use the Display System Values command (DSPSYSVAL QSYSLIBL) to check. If required, be sure to add the library to your system library list. You can use the Change System Library List (CHGSYSLIBL) command to do so.

Planning for the Install

BRMS uses library QUSRBRM to store information about your backup and archive operations, the policies you use to perform these operations and all the media being managed by BRMS. Depending on the number of policies and the level of saved detail you keep and how long you retain this information, the size of the files in the QUSRBRM library can be significantly large. Whenever, you upgrade to a new release, BRMS must convert the information in changed physical files to the new record format so that the data is compatible with the programs. This file conversion typically is required only once for any given release. In releases prior to V5R3M0, the file conversions were performed during installation.

| **Note:** The file conversion consists of replicating the data from the file record format of a previous release
| to the file record format of the current release. If you have programs which interface to the BRMS
| logical or physical files in library QUSRBRM, you are responsible for verifying the function of
| these programs using the new file record format. The format of these files are subject to change
| without notice. If you have created your own logical files based on the physical files in library
| QUSRBRM, you must delete these logical files before you install the product update.

| If you are planning an upgrade to a later version/release of BRMS, you can run the following commands
| on the current version/release to estimate the conversion time for the product update.

| **For V5R4M0:**
| INZBRM OPTION(*ESTPRDUPD) TGTRLS(target-release)
| **For V5R1M0, V5R2M0 and V5R3M0:**
| CALL QBRM/Q1ARMLT PARM('ESTCONVTIM' 'target-release')

| where: target-release is the future version/release/modification level,
| in VnRnMn format, of the planned upgrade.

| The estimated update time is returned in message BRM402C. The estimated time can vary significantly if
| the update and initialization are not run on the current system, or run in different system environments.
| The minimum time estimate returned is 10 minutes.

With V5R3M0 and follow on releases, the BRMS file conversion was removed from the install path and a new post-install product initialization step was created. Post installation product initialization must be performed before you can use BRMS. If an attempt is made to use any BRMS command prior to product initialization you will see the following exception:

BRM40A2 – BRMS product initialization required.

In addition, all functions on BRMS menus are disabled as shown in the following panel. Any attempt to use a menu option will also result in the BRM40A2 exception. Deferring the BRMS product initialization allows you to minimize the time your system is not available for the software upgrade. It allows you to load all the software and PTFs in a more timely manner and to get the system online sooner. You can then perform the BRMS initialization after all system resources become available.

```

BRMS                Backup Recovery and Media Services for iSeries
                        System:  RCHAS400
Select one of the following:

    *. Media management
    *. Backup
    *. Archive
    *. Recovery
    *. Migration

    **. Scheduling
    **. Policy administration
    **. Reports

    **. Start console monitor

Selection or command
====>

F3=Exit  F4=Prompt  F9=Retrieve  F10=Commands  F12=Cancel  F13=Functions
BRMS product initialization required.

```

BRMS automatically initiates the product initialization process for you by submitting a job named BRMSPRDINZ to the batch queue defined in job description QGPL/QDFTJOBDD. Message BRM40A8 is added to the job log after successful completion of the install. This message identifies the job and the batch job queue that will run the BRMS product initialization. If you installed while in restricted state, the product initialization job will not run until after the system IPL.

In most cases, the initialization may have already been completed by the time you want to use BRMS. If you can use the BRMS commands, menus and the iSeries Navigator client, no further action is required, the product has been successfully initialized. If these functions are locked, you will want to locate and monitor for the job completion message in the QSYSOPR message queue. If the job is still running, you can run the following command to retrieve an approximation of the time required to complete the initialization.

```
INZBRM OPTION(*ESTPRDINZ)
```

If you cannot find job BRMSPRDINZ in the batch queues and BRMS commands and menus are still locked, you can run the following command to complete BRMS product initialization.

```
INZBRM OPTION(*RUNPRDINZ)
```

Only one job can perform product initialization. The following messages are generated by the *RUNPRDINZ option to inform you of the initialization process status.

- BRM40A3**
BRMS product initialization started.
- BRM40A4**
BRMS product initialization successful.
- BRM40A5**
BRMS product initialization ended abnormally.
- BRM40A6**
BRMS product initialization already started.
- BRM40A7**
BRMS initialization not required.

Installing BRMS

There are no special actions you need to take when installing BRMS on a system for the first time or if you are installing a new version of BRMS on the same system which has a previous version currently installed. In either case, follow the steps below to install BRMS on your iSeries or use the normal iSeries processes for installing the new software from the distribution media.

Note: If you are consolidating BRMS operations on one or more systems to another system, or moving BRMS operations to a new system having a new name, refer to Appendix A, "Merging BRMS Data and Consolidating Systems," on page 313 for guidance in completing the migration task.

1. Quiesce all BRMS operations if BRMS is already installed.
2. Enter GO LICPGM from a command line.
3. At the Work with Licensed Programs display, select option 11 (Install Licensed Programs).
4. Select Product 5722BR1, option *BASE, to install the standard Backup, Recovery, and Media Services for the iSeries product. Then press Enter.
5. Press Enter at the next display to confirm your selection.
6. At the Install Options display, type in the name of your installation device as requested. Then press Enter to start the installation.
7. Press F14 to accept the Software Agreements.
8. After you have successfully installed the *BASE BRMS product, you can install the additional features. To do so, repeat steps 1-7 for each feature. At step 3, take option 1 for the Network feature or option 2 for the Advanced Functions (HSM) feature.

After the Installation

Do the following after the successful installation of BRMS:

- Reload the latest cumulative program temporary fix (PTF) compact disk to ensure that all of the BRMS-related fixes are in place. If you recently loaded and applied the latest cumulative (CUM) PTF prior to installing BRMS, you will need to load and apply the BRMS-related PTFs after BRMS is installed.
- You may also want to load the latest Save and Restore Group PTFs. You can access the latest PTFs through the iSeries Internet home page at <http://www-1.ibm.com/servers/eserver/iseries/service/brms/group.htm>.
- Verify that the *Allow user domain objects in user libraries* (QALWUSRDMN) system value is set to *ALL, which is the default shipped value. This value allows user domain objects in libraries. It also determines which libraries on the system may contain the user domain objects *USRSPC (user space), *USRIDX (user index), and *USRQ (user queue). If you do not set the system value to *ALL, you must add the QBRM and QUSRBRM libraries to the list of libraries that are shown on the QALWUSRDMN display. You can use the Work with System Values (WRKSYSVAL) command to verify the QALWUSRDMN system value.
- Review the job log to ensure that the installation completed successfully. Use the Display Job Log (DSPJOBLOG) command to review the job log.
- Verify the BRMS post installation product initialization job completed successfully by looking for this message in the QSYSOPR job log:
CPF1241 - Job nnnnnn/userid/BRMSPRDINZ completed normally on date at time.

When you install the BRMS product, message BRM40A8 is added to the job log to help you identify the job and the batch job queue which will run the BRMS product initialization. If the job is still running or the job is still being held, you can run the following command to retrieve an approximation of the time required to complete the initialization.

```
INZBRM OPTION(*ESTPRDINZ)
```

Note: BRMS will not be available to monitor media operations or be able to track native save operations until BRMS product initialization is complete. It is important to minimize these activities on the system until BRMS product initialization has completed. It is also recommended you perform a full system save including a save of the BRMS media information after product initialization.

If the BRMS product initialization job could not be submitted to the batch queue for any reason, message BRM40AA is added to the install job log. However, this message will not terminate the install process and the install should still complete successfully. If you receive this message, then you need to run BRMS product initialization using the following command:

```
INZBRM OPTION(*RUNPRDINZ)
```

The following are some of the tasks completed during product initialization.

- Creates the QBRM and QUSRBRM libraries, which contain all BRMS-related objects and information.
- Creates or updates tape drive and media class entries based on the installed tape devices.
- Creates or updates default BRMS objects.
- Converts all BRMS database files to the current format.
- Registers BRMS with the MSE feature of i5/OS.

If you cannot find job BRMSPRDINZ in the job queues and BRMS commands and menus are still locked, you can run the following command to complete BRMS product initialization.

```
INZBRM OPTION(*RUNPRDINZ)
```

- If you installed the BRMS Network feature, follow the instructions to add this system to the network as documented in the section “A Step-by-Step Guide to Setting Up Your BRMS Network” on page 245.
- Re-register any programs you may have registered to the following BRMS exits.

```
QIBM_A1A_TAPE_INF  
QIBM_A1A_TAPE_MOVE  
QIBM_A1A_RETR_INF
```

Updating License Information

If you purchased BRMS, you need to update the BRMS license information to disable the automatic product locking function. If you do not, you cannot use most of the BRMS functions and functional components beyond the 70-day trial period. If you have the license keys, we recommend that you update the BRMS license information now. To do so, take the following steps:

1. Type the Work with Licensed Information (WRKLCINF) command at a command line and press Enter.
2. At the Work with License Information display, locate product 5722BR1, feature 5050.
3. Type a 1 in the *Opt* field next to 5722BR1 feature 5050, and press Enter. You see the prompt display for the Add License Key Information (ADDLICENSE) command.
4. Use the default value of *ANY in the *Processor group* field.
5. In the *License key* field, type in the 18 character license key that is provided with your BRMS license agreement.
6. In the *Usage limit* field, specify a value of *NOMAX.
7. Use the default value of *NO in both the *Expiration date* and *Vendor data* fields.
8. Press Enter. You see message CPC9E66 (1 license key information records added to the repository).
9. Repeat steps 2 through 8 for BRMS features 5101 and 5102 if your license agreement includes these features.

| You should store the license key in a secure place in case you have to do an unexpected (and unlikely) scratch install of i5/OS.

Installing the BRMS iSeries Navigator Client On Your Workstation

After you install BRMS on your iSeries and have applied the latest PTFs, you can additionally install the BRMS iSeries Navigator client to workstations which are also using iSeries Navigator. To do so, follow these steps:

1. Right-click the **Network Neighborhood** or **My Network Places** icon on your desktop.
2. Select **Map Network Drive**.
3. Specify `\\system-name\qibm` for **Path** or **Folder**, where *system-name* is the name of the system on which the BRMS product (5722-BR1) is installed.
4. Click **OK**.
5. Open the **IBM iSeries Access for Windows** icon.
6. Open the **Selective Setup** icon in the **IBM iSeries Access for Windows** folder.
7. Click **Next** on the **Selective Setup** panel.
8. Click **Browse** on the **Selective Setup Options** panel.
9. On the **Choose Folder** panel select the **Drive** mapped to `drive:\\system-name\qibm`.
10. Click **OK**.
11. Click **Next** on the **Selective Setup Options** panel.
12. Click **Next** on the **Components Cannot Be Installed** panel.
13. Find **Backup, Recovery and Media Services** under **Components** on the **Component Selection** panel.
14. Click the **Backup, Recovery and Media Services** check box.
15. Click **Next** on the **Component Selection** panel.
16. **Backup, Recovery and Media Services** should be listed under **Add components** on the **Start Copying Files** panel.
17. Click **Next** on the **Start Copying Files** panel.
18. Deselect the **View the README file** and **Add program folder to desktop** check boxes on the **Install Completed** panel.
19. Click **Next** on the **Install Completed** panel.
20. Click **Finish** on the **Setup Complete** panel.

Removing BRMS From Your System

To remove BRMS from your system, take the following steps:

1. Enter `GO LICPGM` from a command line.
2. At the **Work with Licensed Programs** display, select option 12 (Delete licensed programs).
3. Type option 4 (Delete) next to the BRMS (5722BR1) products you want to remove and press **Enter**.
4. Press **Enter** again at the next display to confirm the products you want to remove, and to proceed with the licensed program removal.

You can remove the Advanced Function and Network features independently of the standard product if required. However, before you can remove the Network feature, you must first remove the system from the network. You can find instruction on how to remove systems from a network and how to remove the Network feature itself in Chapter 14, "Networking with BRMS," on page 237.

Deleting the BRMS product from your system will remove the QBRM library from your system. If you used BRMS to save objects to save files, BRMS would have also created one or more libraries named `Q1ABRMSnn`, where `nn` is the number of the auxiliary storage pool containing the library. Deleting the BRMS product does not remove these save file libraries or the QUSRBRM library containing the save history information. If you intend to remove BRMS permanently from your system, you can also remove these libraries.

Note: The QBRMS user profile is not automatically deleted from the system when BRMS is deleted. Before deleting the QBRMS user profile, review the objects owned by this profile to determine whether you want to keep or remove these objects. If you have no intention of reinstalling BRMS or do not require the objects currently owned by the QBRMS user profile, then delete the QBRMS user profile using the following command:

```
DLTUSRPRF USRPRF(QBRMS) OWNBJOPT(*DLT)
```

Remove BRMS iSeries Navigator Client From Your Workstation

To remove the BRMS iSeries Navigator client from your workstation, take the following steps:

1. Open the **IBM iSeries Access for Windows** icon.
2. Open the **Selective Setup** icon in the **IBM iSeries Access for Windows** folder.
3. Click **Next** on the **Selective Setup** panel.
4. Select **Ignore, I'm going to uninstall components** on the **Selective Setup Options** panel.
5. Click **Next** on the **Selective Setup Options** panel.
6. Click the plus sign (+) next to **iSeries Navigator** to expand the installed components on the **Component Selection** panel.
7. Find **Backup, Recovery and Media Services**.
8. Deselect the **Backup, Recovery and Media Services** check box.
9. Click **Next** on the **Component Selection** panel. **Backup, Recovery and Media Services** should be listed under **Remove components** on the **Start Copying Files** panel.
10. Click **Next** on the **Start Copying Files** panel.
11. Click **Finish** on the **Setup Complete** panel.

Chapter 3. Backing Up Your Entire System

You can use BRMS to perform a variety of backups. You can, for example, use BRMS-configured defaults to perform a straight forward backup of your entire system. Or you can use a variety of other BRMS tools and techniques to tailor a backup and recovery operation that suits the specific needs of your company. This chapter provides instruction on how to use BRMS-configured defaults to back up all of your system and BRMS data.

Many of the functions described in this chapter are available in the BRMS iSeries Navigator client. For detailed information on the BRMS iSeries Navigator client, see the iSeries Information Center.

BRMS generally processes backups by using control groups. You can also use commands to process backups. In this chapter, however, the focus is on performing backups with control groups. **Control groups** consist of groups of libraries, objects, folders, spooled files, and other types of data that share similar characteristics or that you want grouped together for a particular purpose. BRMS comes with three default backup control groups, ***SYSTEM**, ***SYSGRP** and ***BKUGRP**.

- | You can use the ***SYSTEM** control group to backup your entire system in restricted state.
- | Use the ***SYSGRP** control group to back up only the IBM supplied objects of the system in restricted state.
- | The objects include the Licensed Internal code, the i5/OS objects in library QSYS, the security and configuration data, the IBM libraries (primarily the Q libraries), and the IBM directories and files stored in the Integrated File System (IFS).
- | Use the ***BKUGRP** control group to run a non-restricted state backup of all user data. The user data includes the security and configuration data, all user libraries, folders and documents, and user directories and files stored in IFS.

This chapter shows you how to use the ***SYSGRP**, ***BKUGRP** and ***SYSTEM** control groups to perform backups of your entire system.

- | We recommend that you run the ***SYSTEM** control group as soon as possible after installing BRMS. After the initial backup is complete, you should backup your user and system data as frequently as your business requires. Thus, you might schedule daily backups using the ***SYSTEM** group. If your backup window is not long enough, you might schedule daily backups of the user data using the ***BKUGRP** control group, and defer the entire system backups until the end of the week, end of the month, or whenever maintenance is applied to the system. The information contained in this book can assist you in developing and implementing the backup and recovery strategy that best suits your business needs.
- | Chapter 7, "Tailoring Your Backup," on page 109 and Chapter 8, "Performing Selected Recoveries," on page 163 provide information on backup and recovery planning and instruction on how to tailor your backup and recovery operations. You will find these chapters particularly helpful when designing your backup and recovery strategy.

Before you can perform any backups, however, you need to enroll the media for BRMS to use. To do that, read the instructions below and enroll your media as applicable.

Enrolling Media

The process of enrolling media has two steps, each of which is discussed in this section:

1. Determining the media class by which BRMS identifies and tracks your media.
2. Enrolling the media volumes into BRMS.

Determining Media Classes

It is important to have sufficient volumes enrolled in the BRMS scratch pool before performing a save operation. A media scratch pool is a group of available (expired and unused) media that share the same media class. BRMS draws the media it uses for backup and recovery operations from this pool. You are likely to need at least four volumes to perform the backups that are discussed in this chapter. Use two to back up your system data with the *SYSGRP control group, and two to back up your non-system data with the *BKUGRP control group, or use all four to backup your entire system using the *SYSTEM control group. You may need more or fewer tapes depending on the capacity of your media and the size of your system.

BRMS groups each tape into a media class, which allows BRMS to track and protect the active data on your media by type. A **media class** refers to the grouping of media by similar characteristics, for example, tape density and tape capacity.

During installation, BRMS creates default device information based on the type of device attached to your system at that time. If more than one tape device is attached, BRMS takes as its default device the fastest and most automated device that is attached. BRMS bases the default media class on the default device type. For example, if you have a 6380 tape device attached to your system, the media class might be QICxxx. In this case, the class prefix (QIC) signifies a 1/4" tape and the x's indicate different densities.

To perform the backups that are discussed in this chapter, you must use two different media classes:

- To perform the *SYSTEM backup of the entire system or the *SYSGRP backup of the system data, specify SAVSYS (Save System) as the media class when enrolling the volumes that are used for this backup.
- To perform the *BKUGRP backup of non-system data, specify the default media class name that is assigned by BRMS during installation.

You can find the default media class name assigned by BRMS in the system policy. To get there, perform the following steps:

1. Type GO BRMSYSPCY at a command line.
2. At the System Policy menu, select option 1 (Display or Change system policy).
3. At the Change System Policy display, note the media class name that is specified in the *Media class* field.
4. Use this media class name when you enroll the media for the *BKUGRP backup.

Change System Policy		RCHAS400
Type choices, press Enter.		
Media policy	FULL	Name, F4 for list
Devices	TAP01	Name, F4 for list
Home location for media	*HOME	Name, F4 for list
Media class	QIC2GB	Name, F4 for list
Sign off interactive users	*NO	*YES, *NO
Sign off limit	30	0-999 minutes
Output queue	*PRTF	Name, *PRTF
Library		Name, *LIBL
Day start time	0:00:00	Time
Media monitor	*YES	*YES, *NO
Shared inventory delay	60	30-9999 seconds
Auto enroll media	*NO	*NO, *YES
Default usage	*YES	*NO, *YES
More...		
F3=Exit F4=Prompt F5=Refresh F12=Cancel		

Enrolling Media into BRMS for use by a Stand-Alone Tape Device

Use the following procedure to enroll media for use by the standalone tape device that is attached to your system:

1. Insert the pre-initialized volume into your tape device. If your volumes are not initialized, see Chapter 6, "Setting Up Your Media Management Operation," on page 77 for instruction on how to do so before enrolling the volumes into BRMS.
2. Type WRKMEDBRM at a command line to get to the Work with Media display.
3. At the Work with Media display, type a 1 in the *Option* column and then type the name of your volume in the *Volume Serial* column. Press Enter. This takes you to the Add Media to BRM (ADDMEDBRM) display.

Note: If you encounter a message saying *Cannot allocate device TAPxx*, then you need to vary on the device. You can do that by taking option 8 (Work with status) from the Work with Devices (WRKDEVBRM) display.

4. Type the name of the appropriate media class in the *Media Class* field and press Enter. Be sure to enroll four volumes in the SAVSYS media class for the *SYSTEM backup, or two volumes into the SAVSYS media class for the *SYSGRP backup, and two into the media class assigned by your system policy for the *BKUGRP backup.
5. You have now returned to the Add Media to BRM display. Press F9 to prompt the additional parameters. Then press Enter again to enroll the media.
6. Repeat steps 4 through 6 for each volume.

Enrolling Media into BRMS for use by a Media Library

Use the following procedure to enroll media for use by the media library that is attached to your system:

1. Ensure that four pre-initialized volumes are available in your tape library. If your volumes are not initialized, see Chapter 6, "Setting Up Your Media Management Operation," on page 77 for instruction on how to do so before enrolling the volumes into BRMS.
2. Type WRKMLBBRM at a command line to get to the Work with Media Libraries display.
3. Type an 8 (Work with MLB media) next to the name of the media library device you want to work with and press Enter. This takes you to the Work with Media Library Media display.
4. At this display, press Enter three times to work with current inventory of the media library. Place a 1 (Add MLB media) next to the volume you want to enroll and press Enter. This takes you to the Add MLB media to BRM display.

Note: If you encounter a message saying *Cannot allocate device TAPMLBxx*, then you need to vary on the device. You can do that by using the Work with Media Library Status (WRKMLBSTS) command.

5. At the Add MLB media to BRM display, type in the name of the appropriate media class. Be sure to enroll two volumes into the SAVSYS media class for the *SYSGRP backup, and two into the media class assigned by your system policy for the *BKUGRP backup. Then press Enter. This returns you to the Add Media Library Media to BRM display.
6. At the Add Media Library Media to BRM display, press Enter twice.
7. Repeat steps 5 through 7 for each volume.

Note: When volumes are physically inserted into the tape library, they must already have a volume identifier assigned to the volume. This is a requirement of the media library, not BRMS.

Performing the Backups

Use the following procedures to perform a full save of your entire system.

Notes:

1. Processing time for each backup depends on the size of your system processor, device capability, and the amount of data that you want to save.
2. You cannot perform other activities during these backups because your system will be in a restricted state.

Backing Up System with *SYSTEM

1. Sign on to your system console workstation.
2. Make sure that the device you want to use to perform the backup is varied on. Take option 8 (Work with status) from the Work with Devices (WRKDEVBRM) command to check the status of your device.
3. Be sure that the media you use for this backup is enrolled in the SAVSYS media class.
4. To begin the backup, type STRBKUBRM CTLGRP(*SYSTEM) SBMJOB(*NO) at any command line and press Enter.
5. Once the *SYSTEM backup completes, review the job log to ensure that the save completed successfully. To display the job log, enter DSPJOBLOG at a command line, and then press F10 to see the details.

Backing Up System Data with *SYSGRP

1. Sign on to your system console workstation.
2. Make sure that the device you want to use to perform the backup is varied on. Take option 8 (Work with status) from the Work with Devices (WRKDEVBRM) command to check the status of your device.
3. Be sure that the media you use for this backup is in the appropriate media class. Use the class name that is identified in the *Media class* field in the system policy.
4. To begin the backup, type STRBKUBRM CTLGRP(*SYSGRP) SBMJOB(*NO) at any command line and press Enter.
5. Once the *SYSGRP backup completes, review the job log to ensure that the save completed successfully. To display the job log, enter DSPJOBLOG at a command line, and then press F10 to see the details.

Backing Up User Data with *BKUGRP

1. Make sure that the device you want to use to perform the backup is varied on. Take option 8 (Work with configuration status) from the Work with Devices (WRKDEVBRM) command to check the status of your device.
2. Be sure that the media you use for this backup is in the appropriate media class. Use the class name that is identified in the *Media class* field in the system policy.
3. End all subsystems to enable the *BKUGRP control group to save. You did not need to do this before the *SYSTEM or *SYSGRP save because BRMS performed this function for you. Before you end the subsystems, go to the Work with Subsystems display and write down the subsystem names that are listed there. After the *BKUGRP save, you will need to restart each subsystem by name. To get to the Work with Subsystems (WRKSBS) display, type WRKSBS from any command line.
4. To end all subsystems, type ENDSBS SBS(*ALL) OPTION(*IMMED) at a command line and press Enter. All subsystems end (except the subsystem that operates the system console workstation, usually called QCTL) when the *System ended to restricted state* message appears. You may need to refresh the display. To view the message, enter DSPMSG QSYSOPR at a command line.

Note: A message from QSYSOPR that asserts *System ending abnormally* will not affect your backup, though you may want to investigate the problem for other reasons.

5. Once all of the subsystems have ended, you can perform the *BKUGRP backup. At any command line, type STRBKUBRM CTLGRP(*BKUGRP) SBMJOB(*NO) and press Enter.

6. Once the *BKUGRP backup completes, review the job log to ensure that the save completed successfully. To display the job log, enter DSPJOBLOG at a command line, then press F10 to see the details.
7. To restart your subsystems, type STRSBS (Start Subsystem) on a command line and press F4 to prompt the Start Subsystems display. Type the name of a subsystem in the *Subsystem description* field and press Enter. Do this for each of the subsystems.

Backup and Recovery Log

A useful tool for analyzing success or failure of daily BRMS operations is the Backup and Recovery Log (BRMS log). The BRMS log provides a running summary of all save, restore and media related messages received during BRMS operations. You can view the messages in the log using the Display Log for BRM (DSPLOGBRM) command. The default behavior of the DSPLOGBRM command is to only show the messages for the current day, with the display positioned to the most recent entry. You can use the *Time period for log output (PERIOD)* parameter on the command to specify a date and time window for log messages you want to display. The information provided on the *Message View* of the *Display BRM Log Information* display includes the date, time and first level text for the messages.

```

                                Display BRM Log Information                RCHAS400
Current date/time . . . . . : 12/23/05 10:27:53
Position to date . . . . . : 12/20/05

Date sent Time sent Message
12/20/05 14:46:22 Devices TAP07 will be used for control group *N type *BKU
12/20/05 14:46:23 Starting save of library KLD to devices TAP07.
12/20/05 14:47:26 Save or restore operation ended unsuccessfully.
12/20/05 15:22:20 Devices TAP07 will be used for control group *N type *BKU
12/20/05 15:25:34 Save operation canceled.
12/20/05 15:34:26 Devices TAP07 will be used for control group *N type *BKU
12/20/05 15:34:41 Save operation canceled.
12/21/05 10:03:37 Devices TAP07 will be used for control group *N type *BKU
12/21/05 10:14:51 Save operation canceled.
12/21/05 10:29:16 Devices TAP07 will be used for control group *N type *BKU
12/21/05 10:38:43 Save operation canceled.
12/21/05 11:01:09 Estimated update time is 0 hours and 11 minutes.
                                                                Bottom

Press Enter to continue.

F3=Exit      F4=Message details    F5=Refresh    F11=Alternate view
F12=Cancel   F17=Top               F18=Bottom

```

The *Alternate View* of the *Display BRM Log Information* display shows the message identifier, a BRMS assigned severity and area, and the job information.

The *Current date/time prompt* displays the current system date and time and is updated each time the screen is refreshed.

Use the *Position to date* to quickly position the display to messages starting on a specific date. You can only position within the date range you specified on the PERIOD parameter.

Display BRM Log Information

RCHAS400

Current date/time : 12/22/05 13:47:12
 Position to date : 12/20/05

Date sent	Time sent	Msg ID	Sev	Area	Job	User	Job Nbr
12/20/05	14:46:22	BRM1669	10	*BKU	QPADEV0008	MARILIN	055318
12/20/05	14:46:23	BRM1058	00	*BKU	QPADEV0008	MARILIN	055318
12/20/05	14:47:26	CPF3794	70	*BKU	QPADEV0008	MARILIN	055318
12/20/05	15:22:20	BRM1669	10	*BKU	QPADEV0008	MARILIN	055318
12/20/05	15:25:34	BRM1646	40	*BKU	QPADEV0008	MARILIN	055318
12/20/05	15:34:26	BRM1669	10	*BKU	QPADEV0008	MARILIN	055318
12/20/05	15:34:41	BRM1646	40	*BKU	QPADEV0008	MARILIN	055318
12/21/05	10:03:37	BRM1669	10	*BKU	QPADEV0005	MARILIN	055426
12/21/05	10:14:51	BRM1646	40	*BKU	QPADEV0005	MARILIN	055426
12/21/05	10:29:16	BRM1669	10	*BKU	QPADEV0005	MARILIN	055426
12/21/05	10:38:43	BRM1646	40	*BKU	QPADEV0005	MARILIN	055426
12/21/05	11:01:09	BRM402C	00	*MAINT	QPADEV000F	SPHANK	055409

Bottom

Press Enter to continue.

F3=Exit F4=Message details F5=Refresh F11=Message view
 F12=Cancel F17=Top F18=Bottom

You can place the cursor over any message, in either view, then press F4 to see the detailed text of the message.

Additional BRM Log Information

RCHAS400

Message ID : BRM1646 Severity : 40
 Job . . . : QPADEV0008 User . . : MARILIN Number : 055318
 Date sent : 12/20/05 Time sent : 15:25:34
 Program : Q1AC0DV Area : *BKU

Message : Save operation canceled.
 Cause : Operation was canceled because devices TAP07 were not ready.

Bottom

Press Enter to continue

F3=Exit F12=Cancel

If you use the BRMS iSeries Navigator client, the **Display BRMS Log** task can be used to display the messages in the BRMS log. One advantage for doing so is the added flexibility the task provides for searching the BRM log using any number of the following message attributes:

- Message type
- Minimum message severity
- Message identifier or generic message identifier
- Program name or generic program name
- User name or generic user name
- Job name or generic job name
- Job number or generic job number

You can print the BRMS Log messages by specifying *PRINT for the *Output (OUTPUT)* parameter of the DSPLOGBRM command. The report that is produced is the BRMS Log Report . The printer file for this report is QP1ALG. You can also print the report using option 52 from the BRMRPT menu (GO BRMRPT).

Removing Log Messages

Messages in the BRMS log become less useful as they age. BRMS provides two methods for removing aged messages for the BRMS log.

The first method uses the *Remove log entries (RMVLOGE)* parameter on the Start Maintenance for BRM (STRMNTBRM) command to specify the type and date range of messages to be removed. The default behavior of this parameter is to remove all messages older than 90 days. The STRMNTBRM command provides the easiest method to maintain the BRMS log since this is a command that you should be running frequently.

```
Start Maintenance for BRM (STRMNTBRM)

Type choices, press Enter.

Expire media . . . . . *YES          *YES, *NO
Expire media set volumes . . . . *NO          *NO, *YES
Remove media information:
  Media contents . . . . . *EXP          *EXP, *NONE, *REUSE
  Object level detail . . . . . *MEDCON    1-9999, *MEDCON
Remove migration information . . 180          1-9999, *NONE
Run media movement . . . . . *NO          *NO, *YES
Remove log entries:
  Type . . . . . *ALL          *ALL, *NONE, *ARC, *BKU, *M...
  From date . . . . . *BEGIN       Date, *BEGIN, *CURRENT, nnnnn
  To date . . . . . 90            Date, *END, *CURRENT, nnnnn
Run cleanup operations . . . . *YES          *YES, *NO
Retrieve volume statistics . . . *YES          *YES, *NO
Audit system media . . . . . *NONE
      + for more values
Change BRM journal receivers . . *YES          *YES, *NO
                                          More...
F3=Exit  F4=Prompt  F5=Refresh  F12=Cancel  F13=How to use this display
F24=More keys
```

The alternative method for removing BRMS log messages is to regularly schedule the Remove Log Entries from BRM (RMVLOGEBRM) command. You might consider using this command if you want to run BRMS log maintenance independently from BRMS maintenance, or on a different schedule. In this case, you would specify *NONE for the RMVLOGE parameter on the STRMNTBRM command.

Excluding Log Messages

Another means of managing the BRMS log is to prevent messages of little value from being added to the log. You can define messages to be excluded from the BRMS log using the BRMS iSeries Navigator client. To do so, follow these simple steps using iSeries Navigator:

1. Click on the **Backup, Recovery and Media Services** folder to view the BRMS tasks.
2. Click the **View or edit global policy properties** task.
3. Click the **Logging** tab.
4. Use the functions provided in the **Message IDs to exclude for the log** group box to:
 - Add a known message to the exclusion list.
 - Browse and select one or more message to add to the exclusion list.
 - Remove messages from the exclusion list.

Note: Adding a message to the exclusion list does not remove those messages from the BRMS log. It only prevents future messages from being added to the log.

Sending Log Messages

If you use the BRMS iSeries Navigator and have a license to the BRMS Network feature, you can set up BRMS to send specific BRMS Log messages to a cellular telephone, pager or mailbox or any other

| electronic media that uses an internet email address. Setting up BRMS to provide remote notification of
| critical operation status is as simple as adding the message identifiers to a distribution list and specifying
| the email address.

| Messages will be distributed each time they are added to the log, so choose the message carefully. For
| example, you wouldn't want to add message BRM1058 because it will occur frequently.

| BRM1058 - Starting save of library * to devices *.

| But you might want to distribute message BRM1820 to be notified when a critical backup ends
| abnormally.

| BRM1820 - Control group * type * ended abnormally.

| Follow these simple steps using iSeries Navigator to set up the message distribution:

- | 1. Click on the **Backup, Recovery and Media Services** folder to view the BRMS tasks.
- | 2. Click the **View or edit global policy properties** task.
- | 3. Click the **Logging** tab.
- | 4. Use the functions provided in the **Message IDs to distribute** group box to:
 - | • Add a known message to the distribution list.
 - | • Browse and select one or more messages to add to the distribution list.
 - | • Remove messages from the distribution list.
- | 5. Click the **Network** tab.
- | 6. Use the functions provided in the **Distribution** group box to:
 - | • Specify the primary distribution server.
 - | • Specify the secondary distribution server.
 - | • Specify the email address.
 - | • Specify the maximum length of the message if the destination has any message length restrictions.

| The system that you select as the primary server will distribute the messages. If the primary server
| cannot complete the distribution, it sends the message to the secondary server for distribution. For
| example, you could select a local primary server and a remote secondary server. When the local system is
| in restricted state, BRMS sends the email through the remote secondary system. If a secondary server is
| not specified and the primary server is in restricted state, the message will be queued and distributed
| when BRMS networking is restarted. Attempts are made periodically to re-send pending messages. The
| retry period is established by the current value of the *Shared inventory delay* prompt in the System Policy.

| Before you can use this function, you must have set up the primary, and optionally the secondary server,
| for internet access. You would designate a system other than the local system as the primary or
| secondary server if the local system does not have internet access.

Printing Your Recovery Reports

After completing your backups, BRMS can generate a series of comprehensive recovery reports for use in recovering your entire system. If BRMS is offline due to system failure or other disaster, the recovery reports provide instruction on how to perform the first few steps manually. For example, the recovery reports tell you where to locate the volumes necessary to restore your system. In addition, they identify the manual steps you must take to install the Licensed Internal Code and perform a restore of the operating system and the BRMS product. After completing the manual steps, you can use BRMS to assist you in recovering the remainder of your system.

Perform the following steps to print the recovery reports you will need to recover your system:

1. Type STRRCYBRM at any command line and press F4 to prompt the Start Recovery using BRM display.
2. Press Enter to get a complete list of fields.
3. Set the value in the *Option* field to *SYSTEM and the value in the *Action* field to *REPORT.
4. Press Enter to generate the spooled files from which to print the following reports:

- QP1ARCY: Recovering Your Entire System (features the actual recovery steps)
 - QP1A2RCY: Recovery Volume Summary Report (tells you where to find the necessary volumes)
 - QP1AASP: Display ASP Information
5. Use the Work with Spooled Files (WRKSPLF) command to print the reports.

To use BRMS to perform a recovery, you must have a copy of these reports available. Each time you complete a backup, print a new series of recovery reports. Be sure to keep a copy of these reports with each set of tapes at all locations where media is stored.

Chapter 4. Recovering Your Entire System

After the completion of each save, BRMS can generate a series of up-to-date reports that guide you, in a step-by-step manner, through the process of recovering your entire system. You can also use these reports to guide you through the recovery of selected aspects of your system. In the case of total system failure, the reports guide you through the first manual steps of the recovery process. These initial, manual steps include recovery of the Licensed Internal Code and the operating system. After completing the manual steps, you can use BRMS and these reports to help you restore the rest of your system.

While this chapter provides information on how to recover your *entire* system, there are a variety of other ways by which to recover data. For example, you can restore information by control group, object, library, and document library objects (DLOs). You can find information on how to perform selected recoveries in Chapter 8, “Performing Selected Recoveries,” on page 163.

Because the success of your recovery depends in large part on the kind and quality of your backup operation, you should design your backup plan carefully. Chapter 7, “Tailoring Your Backup,” on page 109 and Chapter 16, “Backup and Recovery of Auxiliary Storage Pool Devices,” on page 279, provide more information on how to plan and implement an effective, viable backup strategy for your system.

Key to good system recovery is running BRMS maintenance regularly. You should run maintenance after each backup to assure BRMS detects and records new and deleted libraries. By default, deleted libraries are not included in the *Recovering Your Entire System Report*. This is important if you are saving libraries on auxiliary storage pool devices. The auxiliary storage pool devices must be available when you run maintenance; otherwise, BRMS will not be able to locate the libraries and will consider the libraries on unavailable auxiliary storage pool devices as having been deleted from the system. You can specify OMITLIB(*NONE) on the STRRCYBRM command to include deleted libraries in the report, but this will also include libraries that were saved and then subsequently deleted which may not be your intention.

Many of the functions described in this chapter are available using the BRMS iSeries Navigator client. For detailed information on the BRMS iSeries Navigator client see the iSeries Information Center.

An Overview of the Recovery Reports

Following are brief summaries of the main reports BRMS can generate after the completion of your saves:

Recovering Your Entire System Report (also called the Recovery Analysis Report)

The *Recovering Your Entire System Report* is the primary recovery report generated by BRMS and is also some times referred to as the *Recovery Analysis Report*, and is often times simply referred as the *System Recovery Report*. Use this report to guide you in a step-by-step manner through the restoration of your entire system. This report includes instruction on how to recover your Licensed Internal Code, your operating system, user libraries, spooled files, and other parts of your system. This report also identifies media volumes (by volume ID) you need for recovery.

Note: The name of this report becomes Recovery Analysis when you use it to guide you through selected recoveries rather than complete recoveries.

In addition to the following three required reports, there are other reports which assist or pertain to various aspects of the data recovery process. For more information on the additional reports, see Appendix B, “A Summary of BRMS Reports,” on page 321.

Recovery Volume Summary Report

The *Recovery Volume Summary Report* is used in conjunction with the *Recovering Your Entire System Report* to identify the volumes necessary to perform your recovery. This report also identifies the locations where you can find the necessary media.

Display ASP Information Report

The *Display ASP Information Report* provides information which can assist you during reconfiguration or verification of your ASP configuration.

Printing the Recovery Reports

To print the reports, perform the following steps:

1. Type STRRCYBRM at any command line and press F4 to prompt the Start Recovery using BRM display.

```
Start Recovery using BRM (STRRCYBRM)

Type choices, press Enter.

Option . . . . . *SYSTEM      *SYSTEM, *ALLDLO, *ALLUSR...
Action . . . . . *REPORT      *REPORT, *RESTORE
Time period for recovery:
  Start time and date:
  Beginning time . . . . . *AVAIL      Time, *AVAIL
  Beginning date . . . . . *BEGIN      Date, *CURRENT, *BEGIN
  End time and date:
  Ending time . . . . . *AVAIL      Time, *AVAIL
  Ending date . . . . . *END          Date, *CURRENT, *END
Use save files . . . . . *YES        *YES, *NO
Use TSM . . . . . *YES            *YES, *NO
ASP device:
  From system . . . . . *LCL
  Auxiliary storage pool . . . . *ALL      Name, *ALL
  Objects . . . . . *ALL          *ALL, *LIB, *LNK
      + for more values

F3=Exit  F4=Prompt  F5=Refresh  F10=Additional parameters  F12=Cancel
F13=How to use this display  F24=More keys
```

2. Press F9 to get a complete list of fields. Make sure that the value *Option* field is *SYSTEM, and that the value in the *Action* field is *REPORT.
3. Press Enter to generate the reports.
4. Print the reports from the output queue. If desired, you can use the Work with Spooled Files (WRKSPLF) command to view the reports prior to printing them. The reports generate three corresponding spooled files, from which you can print the reports:
 - QP1ARCY: Recovering Your Entire System
 - QP1A2RCY: Recovery Volume Summary Report
 - QP1AASP: Display ASP Information

These reports are very important to a successful recovery. To ensure that the tapes and reports you need are available at **all times, it is critical that you perform the following steps:**

- Print an updated series of reports after the completion of each save (or at least once per day).
- You should make duplicate copies of each backup volume and attach copies of the latest reports to them.
- Distribute copies of the tapes and reports to each iSeries location that participates in the saves.
- You should always store at least one copy of the tapes and reports at an off site location.

Note: Though this chapter only mentions the Start Recovery using BRM (STRRCYBRM) command in terms of its report capability, this command performs several other important recovery functions. You can find more information about this command in Chapter 8, “Performing Selected Recoveries,” on page 163.

User Customized Recovery Step Information

You can add your own customized (user recovery) information to either the PROLOG or any STEP in the System Recovery Report. You might want to add user recovery information to your system recovery reports to convey additional guidance, special instructions, or site procedures to the recovery team. Since this is user recovery information which you control, there is no limit to the content and how it is used.

To add user recovery information to the recovery report, you create the records containing the information in members of file QO1AUSRRCY in library QUSRBRM. For example, you would add records to member PROLOG to add user recovery information to the prolog information in the report. Likewise, you would add records to member STEP004 to add user recovery information specific to STEP 004 in the report. The file members are automatically created during product initialization.

The following example illustrates how easy it is to add user recovery information to the recovery report:

1. Use the Work with Members Using PDM (WRKMBRPDM) or Work with Members Using SEU (STRSEU) command specifying QUSRBRM/QO1AUSRRCY for the File (FILE) or Source file (SRCFIL) parameter respectively.
2. Specify 2=Edit for the Option next to the PROLOG member, then press Enter key.
3. Enter the text shown in lines 1–9 below or enter your own user recovery information.

Note: Use F13=Change session defaults to change upper case/lower case options as necessary.

```

Columns . . . :   1  71           Edit           QUSRBRM/QO1AUSRRCY
SEU=>                                     PROLOG
FMT **   ...+... 1 ...+... 2 ...+... 3 ...+... 4 ...+... 5 ...+... 6 ...+... 7
          ***** Beginning of data *****
0001.00
0002.00 ***** Special instructions for the system recovery team *****
0003.00
0004.00 Steps 2, 4, 9, 11 and 12 contain special instructions for system
0005.00 recovery. Prior to implementing the recovery actions in these steps,
0006.00 first review the User Recovery Information block for additional
0007.00 instructions.
0008.00
0009.00 *****
          ***** End of data *****

F3=Exit   F4=Prompt   F5=Refresh   F9=Retrieve   F10=Cursor   F11=Toggle
F16=Repeat find   F17=Repeat change   F24=More keys

```

4. Verify the user recovery information for correctness then press F3=Exit.
5. Press the Enter key on the Exit panel to save the changes.
6. Run the Start Recovery using BRM (STRRCYBRM) command and specify *ADD for the User recovery information (USRRCYINF) parameter.
STRRCYBRM USRRCYINF(*ADD)
7. Use the Work with All Spooled Files (WRKSPLF) command and page down to the most recent version of file System Recovery Report (QP1ARCY).
8. Specify 5=Display for the Option next to the QP1ARCY file, then press Enter key.

9. Page down to the bottom of the prolog information on the report (just prior to STEP 001) and review the user recovery information.

```

.
.
.
If the recovery includes saved items saved to TSM servers or saved
from auxiliary disk pool devices, these saved items will be recovered
after the IPL when these resources become available.

----- User Recovery Information -----

***** Special instructions for the system recovery team *****

Steps 2, 4, 9, 11 and 12 contain special instructions for system
recovery. Prior to implementing the recovery actions in these steps,
first review the User Recovery Information block for additional
instructions.

*****

-----
*****
STEP 001 : Recover Licensed Internal Code
.
.
.

```

The following provides some additional usage information about user recovery information.

- User recovery information is added to the report following the BRMS information and before any saved items in the step. This information is clearly highlighted on the report as *User Recovery Information*.
- Each record in the file member is read sequentially, starting from the first record and ending with the last record, and is added to the report in the same order as read. BRMS performs no national language or CCSID conversions on the records.
- Each user recovery information record is placed on the report starting in column 8 and ending in column 99.
- The user is responsible for all spacing, positioning, content and accuracy of the recovery information in the records.
- Up to 92 bytes of user recovery information can be added to each record.
- There is no limit to the number of records you can add for a member.
- The member can contain double byte characters as long as these characters and the corresponding shift-out and shift-in brackets are contained within the same record.
- No user recovery information is shown for members in file QO1AUSRRCY which have no records.
- File QO1AUSRRCY is saved with each save of the BRMS media information.
- The step numbers in the report are dynamic and could vary depending on the value of the Option (OPTION) parameter and the content of the recovery. If the OPTION or content is changed, the names of the members in file QO1AUSRRCY may need to be renamed accordingly. The step numbers in the report for version/release should be consistent if the report type and saved item content are consistent.

Using the STRRCYBRM command

Using the OPTION(*SYSTEM) and ACTION(*RESTORE) on the Start Recovery using BRM (STRRCYBRM) command initializes the recovery candidate file with all items to be recovered. The recovery candidates are presented to you on the Select Recovery Items display. As saved items are recovered, these are removed from the recovery candidate file and from the saved Select Recovery Items display.

Note: If the recovery includes more than 9,999 items only the first 9,999 are available for recovery. This is a permanent restriction.

```
                Select Recovery Items                RCHAS400
                Select action . . . . . : *ALL
                Select volume . . . . . :
Type options, press Enter.
 1=Select  4=Remove  5=Display  7=Specify object

Opt  Saved      Save   Save   Save   Volume  File   Expire  Objects
     Item       Date   Time   Type   Serial  Sequence Date    Saved
*SAVSECDTA  7/25/05 14:43:38 *FULL  VOL003    1  4/15/05  102
QSYS2      7/25/05 14:43:38 *FULL  VOL003   184 4/15/05  126
QGPL       7/25/05 14:43:38 *FULL  VOL003   178 4/15/05  146
QUSRSYS    7/25/05 14:43:38 *FULL  VOL003   191 4/15/05 1569
*SAVCFG    7/25/05 14:43:38 *FULL  VOL003    36 4/15/05   74
#CGULIB    7/25/05 14:43:38 *FULL  VOL003    38 4/15/05    4
#COBLIB    7/25/05 14:43:38 *FULL  VOL003    39 4/15/05   82
#DFULIB    7/25/05 14:43:38 *FULL  VOL003    40 4/15/05    6
#DSULIB    7/25/05 14:43:38 *FULL  VOL003    41 4/15/05    7
#RPLIB     7/25/05 14:43:38 *FULL  VOL003    42 4/15/05   55
#SDALIB    7/25/05 14:43:38 *FULL  VOL003    43 4/15/05    4
#SEULIB    7/25/05 14:43:38 *FULL  VOL003    44 4/15/05    6
                                                More...
F3=Exit  F5=Refresh  F9=Recovery defaults  F11=ASP View  F12=Cancel
F14=Submit to batch  F16=Select all
```

See “Working with the STRRCYBRM Command” on page 165 for additional information.

Resume a Recovery

Through the course of a recovery, as you recover saved items, the number of saved items decreases from step to step. During the recovery, you may need to leave the Select Recovery Items display, signoff the current session, or IPL the system. If you had already recovered many of the saved items in the recovery, you will want to resume the recovery with the remaining saved items. To resume a recovery, take the following steps:

1. Type STRRCYBRM at a command line and press F4 to prompt the display.
2. In the *Option* field, type *RESUME and press Enter to prompt the next parameter.

```

Start Recovery using BRM (STRRCYBRM)

Type choices, press Enter.

Option . . . . . *RESUME      *SYSTEM, *ALLDLO, *ALLUSR...

F3=Exit  F4=Prompt  F5=Refresh  F10=Additional parameters  F12=Cancel
F13=How to use this display  F24=More keys
Bottom

```

3. Press Enter to resume the recovery.

Using OPTION(*RESUME) on the Start Recovery using BRM (STRRCYBRM) command retrieves only those saved items remaining in the recovery. If this is the first time you have used the STRRCYBRM command in the current job, BRMS will present you with the Select Recovery Job display.

```

Select Recovery Job                                RCHAS400

No recovery items exist for the current job. Either
cancel the request, select a previous recovery job,
or request concurrent recovery with another job.

Type option, press Enter.
1=Select  4=Remove  6=Concurrent

Opt  User      Job      Job      Date      Time
    1  QSECOFR   DSP01   004883   8/27/05   7:48:13

F3=Exit  F5=Refresh  F12=Cancel
Bottom

```

From this display you can identify and select the recovery job containing the recovery candidates you had previously been working with and you can continue with the recovery using those candidates.

You will not be able to select a recovery job if that job is still active.

You also will not be able to select the recovery job if you are not the user, unless you have *SECADM special authority.

See "Concurrent Recovery" on page 33 for additional information about using option 6 to initiate a concurrent recovery using the same recovery candidates selected by another active job. You can use this option to assist in the recovery of object saved using parallel devices or objects saved on different media sets.

Concurrent Recovery

Concurrent recovery facilitates the recovery of multiple media sets using concurrent recovery sessions. Multiple media sets are typically created when you perform backups using parallel device resources. The saved objects on one media set can be restored concurrently on one session, while the objects on another media set are recovered using another session, provided you have sufficient device resources.

The following step is added to the recovery report if there is more than one media set used in the recovery. Information in the step includes:

- the beginning volume of each of the media sets
- how to establish a concurrent recovery session
- how to select the primary recovery job running on the system console for concurrent recovery,
- how to select recovery items

```
*****
```

```
__ STEP nnn : Recover Media Sets Concurrently
```

```
Start date/time _____ Stop date/time _____ Duration _____
```

```
The recovery includes objects saved on multiple media sets having the
following beginning volume identifiers:
```

```
ANYVOL BIGVOL MYVOL
```

```
You can recover these objects using concurrent sessions as long as
each session uses dedicated device resources, and the selected saved
items on the volumes or the media set are not selected by other jobs.
```

```
Otherwise, skip to the next recovery step.
```

```
Start the concurrent session. To do so:
```

```
a) Type the following command and press "Enter":
```

```
STRSBS QSYS/QINTER
```

```
b) Signon to another interactive session.
```

```
c) Type the following command and press "Enter":
```

```
STRRCYBRM OPTION(*RESUME)
```

```
d) Specify option 6=Concurrent next to the job running on the system
console which was used to retrieve all recovery items for the system.
```

```
e) Use the "Select action" and "Select volume" prompts and press F16
to select subsets of the available recovery items on the volumes
or the media sets not selected by other recovery jobs.
```

```

----- Attention -----
Press F9 on the Select Recovery Items display to go to the Restore
Command Defaults display.
  _ Ensure the tape device name or media library device name is
    correct for the Device prompt.
  _ Ensure *SAVLIB is specified for the Restore to library prompt.
  _ Ensure *SAVASP is specified for the Auxiliary storage pool prompt.
If you are recovering to a different system or a different logical
partition, you must specify the following:
  _ *ALL for the Data base member option prompt.
  _ *ALL for the Allow object differences prompt.
  _ *NONE for the System resource management prompt.
  _ Select *NEW for Restore spooled file data to recover saved
    spooled files concurrently with restored output queues.
Press "Enter" to return to the Select Recovery Items display.
-----

```

f) Press "Enter" to recover the selected saved items.

g) Repeat steps d) through f) after the selections are restored.

To run concurrent recovery:

1. Establish another session on the recovery system.
2. Issue the STRRCYBRM *RESUME command.
3. On the *Select Recovery Job* display, use option 6 to start concurrent recovery with the main recovery session.

```

                                Select Recovery Job                                RCHAS400

No recovery items exist for the current job. Either
cancel the request, select a previous recovery job,
or request concurrent recovery with another job.

Type option, press Enter.
  1=Select  4=Remove  6=Concurrent

Opt  User      Job      Job      Date      Time
   6  QSECOFR   DSP01   004883   8/27/05   7:48:13

                                Bottom

F3=Exit  F5=Refresh  F12=Cancel

```

The *Select Recovery Items* display shows the remaining recovery items for the system not yet selected for recovery.

4. Select recovery items you intend to recover from this session. You can use F16 to select by volume or volume set. The select recovery items will be reassigned to the current job and make them ineligible for recovery by the other job. When all the selected items are recovered, you are returned to the *Select Recovery Job* display where you can once again select the concurrent recovery job and select additional recovery items.

Using the Recovering Your Entire System Report

The successful completion of nearly every step in the Recovering Your Entire System Report relies on information in the *Backup and Recovery* book. After you obtain a copy of the *Backup and Recovery* book, you can review and test the steps that are outlined in this section.

Attention: If you are recovering a system that included data saved from auxiliary storage pool devices, then refer to BRMS Information APAR II12662 for additional guidance on how to configure and vary on auxiliary storage pool devices. The auxiliary storage pool devices must be varied on to successfully recover the data saved from these storage pools.

This chapter shows you how to use the steps in the Recovering Your Entire System Report to recover your entire system in the event of a total system failure. *You should not base an actual recovery on the steps that are outlined in this chapter. For assistance during an actual recovery, you must use the recovery reports that are generated by your own system.* Those reports contain recovery information particular to your own system. BRMS uses a pre-configured template as the basis for its recovery procedures, but also notes any steps that are uniquely yours. Such steps can include restoring from save files or from TSM servers.

It is very important that the QUSRBRM and QUSRSYS libraries be saved on a regular basis.

- The QUSRBRM library contains control group information, location information, media information and other customized information.
- The QUSRSYS library contains important information about your media volumes if you are using a media library device.
- The QUSRBRM and QUSRSYS libraries need to be recovered from the most current saved level for your BRMS recovery to be successful.

If you are using a 3494 tape library that is attached to a local area network (LAN), you must vary on the LAN line description. Use the WRKCFGSTS *LIN command to vary on the LAN line description. If you attach your 3494 through an RS-232 connection, you do not need to vary on the RS-232 line description.

The Recovering Your Entire System Report presents the steps in the order required for recovery. To perform a system recovery, you begin with the first step at the top of the system recovery report and follow the flow down through the report to the last step at the bottom of the report.

The information in the sections that follow show accurate reflections of the instructions that appear for each step in the actual report. As you read through the recovery steps, be sure to read the information inside the step as well the text that may precede or follow it.

The following are a few general things to keep in mind as you review the steps:

- Use the *Start time* and *Stop time* fields to record the time it takes to test or perform the recovery step.
- The *Saved item* column indicates the name of the items you need to restore to perform the recovery step.
- The *Control group* column identifies the name of the control group that contains the saved item (if you saved the item in a control group).
- The *Volume identifier* column lists the name of the volume that contains the latest backup of the saved item that you need to recover. (The Volume Summary Report provides the name of the location where you can find the volume).
- The information in the remaining columns pertain to the backup of the saved item.

Prolog

The prolog portion of the system recovery report provides general guidance for the recovery operation. The prolog begins with a listing of the selection criteria based on the parameters specified with the Start Recovery using BRM (STRRCYBRM) command parameters.

```
Selection Criteria
Option . . . . . : *SYSTEM
Start date and time . . . . . : *BEGIN    *AVAIL
Ending date and time . . . . . : *END      *AVAIL
Use save files . . . . . : *YES
Use TSM . . . . . : *YES
Use duplicate media . . . . . : *NO
User recovery information . . . . . : *NO
Libraries to omit . . . . . : *DELETE    QCS*
System name . . . . . : RCHAS400
Volume location . . . . . : *ALL
```

More importantly, this section identifies through the use of *Attention* blocks, possible problems that could prevent a successful recovery. Always review these attention blocks to determine if you need to modify your backup strategy to improve your chances of a complete recovery. The sections that follow discuss the attention blocks that could appear in the prolog.

Attention — Unsaved Objects

After all recovery items have been selected, BRMS will total the *Objects not saved* fields for all recovery items, then add the *Unsaved Objects* attention block to the prolog if the total is not zero. This helps you easily identify whether the recovery includes unsaved objects.

```
----- Attention -----
The recovery includes 000000000000005 objects that were not saved.
Review the "Objects Not Saved" column for the saved items on this report
and determine if recovery is possible with these missing objects.
If these missing objects are required for recovery, review the job log
of the backup to determine why these objects were not saved.
Consider using Save While Active, ending subsystems or applications
holding locks against the objects, or saving in a restricted state by
ending all subsystems to include these objects in the backup.
-----
```

Attention — Unsaved BRMS Media Information

The *Unsaved BRMS Media Information* attention block is added to the prolog if the recovery includes saved items which were saved after the last save of the BRMS media information. The BRMS media information is a selected subset of files in the QUSRBRM library which contain the latest information about the most recent saves. You must always save the BRMS media information after each backup or media duplication before running the recovery report.

```

----- Attention -----
Saves of objects occurred after the last save of changes to the
BRMS media information.

Without this information BRMS cannot accurately guide you through the
remaining recovery steps.

To improve recoverability run the following command routinely.

    SAVMEDIBRM MEDPCY(media-policy-name) DEVICE(device-name)

Otherwise, change the "Automatically backup media information"
attribute to a value other than *NONE on a backup control group which
is routinely used to save data.
-----

```

Attention — Excluded Save File or TSM Objects

If you specified *NO for the *Use save files (USESAVF)* or the *Use TSM (USEADSM)* parameters of the Start Recovery using BRM (STRRCYBRM), and the recovery would normally have included objects saved to these media types, then the *Excluded Save File or TSM Objects* attention block is added to the prolog to alert you to the fact that recovery items exist for these media types. If a library was saved a month ago to tape media and a week ago to save file or TSM, and the save file and/or TSM saves were excluded, the recovery would select the month old save of the library rather than the later save. If you regularly save to save files or TSM servers, you should probably specify *YES for the above mentioned parameters to assure the recovery includes the most recent saves.

```

----- Attention -----
This report excludes objects saved to either save files or TSM servers.
Media information is available for either one or both of these media
types. The report may not show the latest level of saved items.
Verify whether you should run the report again including this media.
-----

```

Attention — Omitted Libraries

The *Libraries to omit (OMITLIB)* parameter of the Start Recovery using BRM (STRRCYBRM) command allows you to name specific libraries or generic libraries you want omitted from recovery. You may want to specify libraries on this parameter that are not needed for system recovery. The *Omitted Libraries* attention block identifies the libraries which have been omitted from the recovery. This is not necessarily a problem for the recovery. The attention block is added so you can verify what libraries have been omitted. This may be important if you specify a generic library name and inadvertently omit a library which is critical to your recovery.

```

----- Attention -----
The following libraries have been excluded from recovery using the
Libraries to omit (OMITLIB) parameter.

    QSC6823793  QSC6823819  QSC6823820  QSC6823859  QSC8365985

No additional action is required if these libraries are not required
for system recovery.

Otherwise, change the Omit libraries (OMITLIB) parameter so these
libraries are not excluded, or use the following command to recover
these libraries after all other saved items have been restored.

    STRRCYBRM OPTION(*LIB) ACTION(*RESTORE) LIB(library-name)
-----

```

Attention — Excluded Deleted Libraries

The *DELETE special value for the *Libraries to omit (OMITLIB)* parameter on the Start Recovery using BRM (STRRCYBRM) command allows you to omit from recovery, those libraries which have been saved and subsequently deleted off the system, such as might be the case with archived libraries. The *Excluded Deleted Libraries* attention block identifies these deleted libraries. This is not a problem for the recovery. The attention blocked is added so you can verify the names of the deleted libraries. This may be important if you decide a deleted library is critical to the recovery.

```
----- Attention -----
The following deleted libraries have been excluded from recovery by
using *DELETE on the Libraries to omit (OMITLIB) parameter. These are
libraries which have been saved and subsequently removed from the
system.

      $TSTLIBOLD

No additional action is required if these libraries are not required
for system recovery.

Otherwise, change the Omit libraries (OMITLIB) parameter so these
libraries are not excluded, or use the following command to recover
these libraries after all other saved items have been restored.

      STRRCYBRM OPTION(*LIB) ACTION(*RESTORE) LIB(library-name)
-----
```

Attention — Unsaved Libraries

When you run the Start Recovery using BRM (STRRCYBRM) command, BRMS will retrieve the names of all available libraries on the system and check these libraries against those included in the system recovery report. The *Unsaved Libraries* attention block identifies libraries on the system which are not included in the report and not explicitly omitted. You should verify whether these libraries are required for system recovery and if required, modify your save strategy to include the unsaved libraries.

Note: BRMS cannot retrieve the names of libraries on unavailable auxiliary storagepool devices.

```
----- Attention -----
The following unsaved libraries are not included in the report.

----- Attention -----
Libraries on unavailable auxiliary storage pools are not listed.
-----

      $TSTLIB

No additional action is required if these libraries are not
required for system recovery.

Otherwise to improve recoverability, add the unsaved libraries to a
backup control group which is routinely saved using STRBKUBRM.
-----
```

STEP 001 : Recover Licensed Internal Code

Before you can recover the operating system and user data, you must first recover the Licensed Internal Code. The Licensed Internal Code is the layer of iSeries architecture just above the hardware. To recover the Licensed Internal Code, follow the "Recovering the Licensed Internal Code" steps in the *Backup and Recovery* book.

If you are using a media library device, you will need to set the device to either standalone, automatic or manual mode in order to load the *SAVSYS saved item. See the device documentation on how to properly change the mode for your media library device.

If your alternate installation device is connected to a bus other than the system bus, the alternate installation device will need to be configured using Dedicated Service Tools (DST) and will require the use of the Licensed Internal Code distribution media.

STEP 001 : Recover Licensed Internal Code

Start date/time _____ Stop date/time _____ Duration _____

You must recover the Licensed Internal Code.

To do so, use the media shown below and the procedure for "Recovering the Licensed Internal Code" in the "Backup and Recovery" book.

Use the media listed for the *SAVSYS saved item to recover the Licensed Internal Code.

An alternate installation device must be configured using Dedicated Service Tools (DST) when the device is connected to a bus other than the system bus, or the device is attached using a fiber channel. The Licensed Internal Code distribution media will be required in addition to the *SAVSYS saved item to recover the system.

----- Attention -----
 ___ Use option 2 when recovering to a different system, or recovering a system with user auxiliary storage pools, or recovering to the same system with a different release.

___ Use option 3 when recovering to the same system at the same release, or recovering a logical partition to another logical partition.

--- Attention -----
 If you are using a media library device, you will need to use either standalone, automatic or manual mode, or use the device move media function to load the media volume containing the *SAVSYS saved item. Refer to the device documentation if you are not familiar with these device modes or functions.

--- Objects ---										
Saved Item	Save Type	---- ASP Name	----- Number	Save Date	Save Time	Not Saved	Not Saved	Sequence Number	Control Group	Volume Identi
___ *SAVSYS	*FULL	*SYSBAS	00001	7/25/02	8:03:03	0	0	1	*SYSGRP	VOL003

STEP 002 : Recover Operating System

Next you must recover the operating system. As a part of this step, you will need to change some system values to optimize the recovery. Use the WRKSYSVAL command to display and record the current settings, and to change these to the recommended setting. If you are recovering from distribution media, record the current settings using the printed system information.

STEP 002 : Recover Operating System

Start date/time _____ Stop date/time _____ Duration _____

You must recover the Operating System.

To do so, you must follow the procedures for "Restoring the Operating System" as detailed in the "Backup and Recovery" book.

Use the media listed for the *SAVSYS saved item to recover the Operating System.

----- Attention -----
To prevent the recovery from failing, change the following system values to the new settings when you reach the "Define and Change the System at IPL" menu during operating system recovery.

Record the current setting for use after the recovery is complete.

System value	Current setting	New setting
QALWOBJRST	_____	*ALL
QFRCCVNRST	_____	0
QINACTIV	_____	*NONE
QIPLTYPE	_____	2
QJOBMSGQFL	_____	*PRTWRAP
QJOBMSGQMX	_____	30 (minimum, 64 recommended)
QLMTDEVSSN	_____	0
QLMTSECOFR	_____	0
QMAXSIGN	_____	*NOMAX
QPFRAJ	_____	2
QPWDEXPITV	_____	*NOMAX
QSCANFSCTL	_____	*NOPOSTRST
QVFOBJRST	_____	1

Saved Item	Save Type	----- ASP Name	----- Number	Save Date	Save Time	--- Objects ---		Sequence Number	Control Group	Volume Identi
						Saved	Not Saved			
*SAVSYS	*FULL	*SYSBAS	00001	7/25/05	8:03:03	0	0	1	*SYSGRP	VOL003

STEP 003 : Set Up Standalone or Media Library Devices for Recovery

To allow for automated recovery, you must now setup the devices to be used for the recovery. Your recovery action will be different depending on whether you are using a standalone device or a media library.

STEP 003 : Set Up Standalone or Media Library Devices for Recovery

Start date/time _____ Stop date/time _____ Duration _____

If you are using a media library device and automatic configuration was enabled, you can now use the media library device to automate recovery.

--- Attention -----
If you are using a 3494 Media Library with TCP/IP communications for recovery, continue to use the media library as a standalone device.

--- Attention -----
If you are using a 3494 Media Library with APPC communications for recovery, you need to configure and set up the communications necessary to control the cartridge loader.

For recovery using the device as a media library (TAPMLBxx):

- __ A. Unload the media volume containing the *SAVSYS saved item from the device.
- __ B. Load all the volumes needed for the recovery (including the *SAVSYS volume) in the media library.
- __ C. Set the media library device for library operations. Refer to the device documentation if you are not familiar with enabling the device for library operations.
- __ D. Verify the status of the media library device is VARIED ON.

To do so, type the following command then press "Enter".

WRKMLBSTS

- __ E. Use Option 4=Allocate resource to set the current allocation of the media library resources to ALLOCATED.

For recovery using the device as a stand alone device (TAPxx):

- __ A. Retrieve all volumes needed for recovery. If you are using an automatic cartridge loader, insert the volumes in the loader in the required sequence.

- __ B. Type the following command then press "Enter":

WRKDEVD DEVD(*TAP)

- __ C. Use Option 8=Work with status to verify the status of the device you are using is VARIED ON.

STEP 004 : Recover the BRMS Product and Associated Libraries

To allow BRMS to aid you through the recovery process, you must now recover the BRMS product and associated libraries. The commands you use to recover these saved libraries will be different depending on whether the save type for the library was full (*FULL), incremental (*INCR), or cumulative (*CUMUL).

STEP 004 : Recover the BRMS Product and Associated Libraries

Start date/time _____ Stop date/time _____ Duration _____

The BRMS product and associated libraries must be recovered before you can use the product to perform other recovery operations.

Change the QSYSOPR message queue to prevent messages not related to the recovery from interrupting the recovery process.

To do so, type the following command then press "Enter".

```
CHGMSGQ MSGQ(QSYSOPR) DLVRY(*NOTIFY) SEV(99)
```

Review and select from the devices configured on the system, the tape or media library devices you intend to use for the recoveries to follow.

For tape devices, run the following command.

```
WRKCFGSTS CFGTYPE(*DEV) CFGD(*TAP)
```

For media library devices, run the following command.

```
WRKCFGSTS CFGTYPE(*DEV) CFGD(*TAPMLB)
```

Type your command choice then press "Enter".

Recover the libraries listed below specifying the saved-item, the device name of the standalone drive or media library you are using, and the volume identifiers and sequence numbers listed.

For type *FULL, run the following command.

```
RSTLIB SAVLIB(saved-item) DEV(device-name)  
VOL(volume-identifier) SEQNBR(sequence-number)
```

For type *CUML or *INCR, run the following command.

```
RSTOBJ OBJ(*ALL) SAVLIB(saved-item) DEV(device-name)  
VOL(volume-identifier) SEQNBR(sequence-number)  
MBROPT(*ALL)
```

Type your command choice then press "Enter".

--- Attention -----
 If you did not save access paths when you saved the QUSRBRM library,
 these access paths will be rebuilt when the library is restored.

Verify rebuild of the access paths for files in library QUSRBRM is
 complete before proceeding to the next recovery step.

To do so, type the following command then press "Enter".

```
EDTRBDAP
```

After recovering the saved items, verify the BRMS product is installed
 correctly and the BRMS commands are available.

To do so, type the following command then press "Enter".

```
CHKPRDOPT PRDID(5722BR1)
```

Saved Item	Save Type	----- ASP Name	----- Number	Save Date	Save Time	--- Objects ---		Sequence Number	Control Group	Volume Identi
						Saved	Not Saved			
___ QUSRBRM	*FULL	*SYSBAS	00001	7/25/05	11:35:30	181	0	56	*BKUGRP	VOL002
___ QBRM	*FULL	*SYSBAS	00001	7/25/05	14:43:38	1,007	0	15	*SYSGRP	VOL003
___ QMSE	*FULL	*SYSBAS	00001	7/25/05	14:43:38	7	0	52	*SYSGRP	VOL003
___ Q1ABRMSF01	*FULL	*SYSBAS	00001	7/25/05	14:43:38	1	0	106	*SYSGRP	VOL003
___ Q1ABRMSF02	*FULL	*SYSBAS	00002	7/25/05	14:43:38	1	0	107	*SYSGRP	VOL003

STEP 005 : Recover BRMS Related Media Information

Now you need to recover the BRMS media information which contains updates to the BRMS database files that contain the latest media information about your last save. The media information in the QUSRBRM library assists BRMS in recovering the remainder of your data. When you perform this step, use the file sequence numbers to ensure that you restore the correct objects; there may be more than one QUSRBRM item on that tape. Using the sequence number also improves the performance of the restore.

```
*****
STEP 005 : Recover BRMS Related Media Information
```

Start date/time _____ Stop date/time _____ Duration _____

You must recover this information for the BRMS product to accurately guide you through the remaining recovery steps.

Recover the libraries listed below specifying the saved-item, the device name of the standalone drive or media library you are using, and the volume identifiers and sequence numbers listed.

To do so, type the following command then press "Enter".

```
RSTOBJ OBJ(*ALL) SAVLIB(saved-item) DEV(device-name)
VOL(volume-identifier) SEQNBR(sequence-number)
MBROPT(*ALL)
```

Saved Item	Save Type	----- ASP Name	----- Number	Save Date	Save Time	--- Objects ---		Sequence Number	Control Group	Volume Identi
						Saved	Not Saved			
___ QUSRBRM	*QBRM	*SYSBAS	00001	7/25/05	15:58:26	11	0	108	*SYSGRP	VOL003

STEP 006 : Initialize BRMS Functional Authority Information

BRMS uses functional authority to manage use of its functions and policies. These functions and policies need to be registered with the operating system and QSECOFR must be authorized to use all functions before recovery can continue. BRMS functional authorities will not be fully operational until after completion of STEP 026 : Recover Authorization Information.

```
*****
STEP 006 : Initialize BRMS Functional Authority Information
```

Start date/time _____ Stop date/time _____ Duration _____

You must perform this step to initialize BRMS functional authorities.

Register all BRMS resources that use functional authority.

To do so, type the following command then press "Enter".

```
INZBRM OPTION(*SETAUT)
```

Assign the QSECOFR user profile administrative functional authority to the BRMS resources.

To do so, type the following command then press "Enter".

```
SETUSRBRM USER(QSECOFR) USAGE(*ADMIN)
```

```
*****
```

STEP 007 : Update System Name in BRMS Media Information

When you save objects on a system to media, BRMS assigns the system name to the saved objects and to the media. If you are recovering to a system or logical partition that has a system name different from the saved system name, you must change the "owning" system name in the BRMS database in order for you to view the saved history when using the STRRCYBRM command. If you use this command and see no

items in the list, you probably need to change the name of the system in the media and history information to the current system name. You can view the current system name using the DSPNETA command.

```
*****
STEP 007 : Update System Name in BRMS Media Information
```

```
Start date/time _____ Stop date/time _____ Duration _____
```

```
BRMS uses the network identifier and default local location name from
the system network attributes to assign a system owner to saved items
and the media containing those saved items.
```

```
The network attributes for the saved system are:
Local network ID . . . . .: APPN
Default local location . . . . .: RCHASPIG
```

```
Display the network attributes of the recovery system.

To do so, type the following command then press "Enter".
```

```
DSPNETA
```

```
Record the network attributes of the recovery system:
```

```
Local network ID . . . . .: _____
Default local location . . . . .: _____
```

```
If the local network identifier or default local location for the
saved system are different from the recovery system and the recovery
system is correct, you must change the system owner of the saved
items and media in the BRMS history to match the network attributes.
```

```
To do so, type the following command then press "Enter".
```

```
INZBRM OPTION(*CHGSYSNAM) PRVSYSDNAM(APPN.RCHAS400 ) NEWSYSNAM(*LCL)
```

```
----- Attention -----
Be sure to specify a fully qualified name for the saved system
using "local-network-id.default-local-location" format.
-----
```

```
If the local network identifier or default local location for the
saved system are different from the recovery system and the saved
system is correct, you must change the network attributes of the
recovery system to match the system owner of the saved items and
media in the BRMS history.
```

```
To do so, type the following command then press "Enter".
```

```
CHGNETA LCLNETID(APPN ) SYSNAME(RCHASPIG)
```

```
*****
```

STEP 008 : Initialize BRMS Device and Media Library Information

If you used values other than default values on the BRMS device and media library information displays, you should verify that your changes are still in effect. You can do this using the Work with Devices (WRKDEVBRM) command.

Note: In some full system recovery scenarios, the WRKMLBBRM command will not run successfully because of dependencies on files saved in library QUSRSYS. You should defer using the WRKMLBBRM command until STEP 013 : Reset BRMS Device and Media Library Information.

```

*****
STEP 008 : Initialize BRMS Device and Media Library Information

Start date/time _____ Stop date/time _____ Duration _____

You must initialize the BRMS device and media library information.

Clear and initialize the BRMS device and media library information with
the tape and media library devices currently configured on the system.

To do so, type the following command then press "Enter".

    INZBRM OPTION(*DEVICE)

--- Attention -----
INZBRM OPTION(*DEVICE) resets some device information to the BRMS
supplied defaults.
-----

Review the BRMS device information.

To do so, type the following command then press "Enter".

    WRKDEVBRM

Update the BRMS device information with any changes necessary before
continuing with the recovery.
*****

```

STEP 009 : Recover User Profiles

It is time to recover the user profiles. When you restore the user profiles, you restore all the attributes of the profile and the system builds a working table that holds the private authorities to objects. Later in the recovery process, you will restore the private authorities to the restored objects.

Before recovering the user profiles, review the implications of setting the *Allow object differences* parameter (ALWOBJDIF) to *ALL in the *Backup and Recovery* book. If there is no data on the system, you can use *ALL when performing a full system recovery. Specifying *ALL when recovering to a different system automatically links the restored information to the authorization lists associated with the object.

| If you are restoring to the same system on which BRMS performed the backup, ensure the *System resource management* (SRM) prompt is set to *ALL . However, if you are restoring to a different system, you should | set the parameter to *NONE .

| **Note:** The *System resource management* prompt applies to the Recover Configuration Data step and is set | here with other recovery defaults for convenience.

STEP 009 : Recover User Profiles

Start date/time _____ Stop date/time _____ Duration _____

You should restore a current version of your user profiles.

To do so, type the following command then press "Enter".

STRRCYBRM OPTION(*SYSBAS) ACTION(*RESTORE)

--- Attention -----
Press F9 on the Select Recovery Items display to go to the Restore Command Defaults display.

- ___ Ensure the tape device name or media library device name is correct for the Device prompt.
 - ___ Ensure *SAVLIB is specified for the Restore to library prompt.
 - ___ Ensure *SAVASP is specified for the Auxiliary storage pool prompt.
- If recovering to a different system or recovering a logical partition to another logical partition, you must specify the following:
- ___ *ALL for the Allow object differences prompt.
 - ___ *ALL for the Data base member option prompt.
 - ___ *NONE for the System resource management prompt.
- Press "Enter" to return to the Select Recovery Items display.

Select the saved item(s) listed below from the "Select Recovery Items" display then press "Enter" to recover these saved items. Recovery of these saved items will require the volumes listed on the report or duplicate volumes.

						--- Objects ---				
Saved Item	Save Type	---- ASP Name	----- Number	Save Date	Save Time	Not Saved	Sequence Number	Control Group	Volume	Identi
___	*SAVSECDTA	*FULL	*SYSBAS	00001	7/25/05 14:43:38	102	0	1	*SYSGRP	VOL003

STEP 010 : Change QSECOFR User Profile Password

Having just restored saved user profiles, you may not know the current password for the QSECOFR user profile which you just recovered in the previous step. It is a good idea to change that password now in the event you need to IPL or signoff.

STEP 010 Change QSECOFR User Profile Password

Start date/time _____ Stop date/time _____ Duration _____

If you do not know the password for the restored QSECOFR user profile, change the password now.

To do so, press F12 to return to a command prompt, then type the following command and press "Enter".

CHGUSRPRF USRPRF(QSECOFR) PASSWORD (new-password)

STEP 011 : Recover Configuration Data

Now you will recover the saved configuration data.

If you restored the SRM database using *ALL (not recommended) as the *System resource management* recovery default and the hardware configuration does not match, review the section dealing with SRM database problems in the *Backup and Recovery* book.

Note: The *System resource management* recovery default is set in the Recover User Profile step along with other recovery defaults.

```
*****
STEP 011 : Recover Configuration Data

Start date/time _____ Stop date/time _____ Duration _____

You should restore a current version of your system configuration.

If the "Select Recovery Items" display is not shown and you are
performing a complete system restore, run the following command.

STRRCYBRM OPTION(*RESUME)

Otherwise, run the following command.

STRRCYBRM OPTION(*SYSBAS) ACTION(*RESTORE)

Type your command choice then press "Enter".

Select the saved item(s) listed below from the "Select Recovery Items"
display then press "Enter" to recover these saved items. Recovery of
these saved items will require the volumes listed on the report or
duplicate volumes.

          --- Objects ---
Saved   Save   ---- ASP   ----- Save   Save   Not   Sequence   Control   Volume
Item    Type   Name      Number  Date   Time   Saved  Saved   Number   Group    Identi
-----
_ *SAVCFG *FULL *SYSBAS  00001  7/25/05 14:43:21  82    0      2   *SYSGRP  VOL003
*****
```

STEP 012 : Recover Required System Libraries

You must recover three key libraries on the system because BRMS has dependencies on these libraries.

The QUSRSYS library is important to BRMS because it contains the tape exit registration information. The QSYS2 library contains the LAN code for the 3494 media library. You must recover the QGPL library prior to the QUSRSYS library because QGPL contains dependencies that QUSRSYS needs.

STEP 012 : Recover Required System Libraries

Start date/time _____ Stop date/time _____ Duration _____

You must restore specific system libraries before you can use BRMS to perform other recovery steps.

If the "Select Recovery Items" display is not shown and you are performing a complete system restore, run the following command:

STRRCYBRM OPTION(*RESUME)

Otherwise, run the following command.

STRRCYBRM OPTION(*SYSBAS) ACTION(*RESTORE)

Type your command choice then press "Enter".

Select the saved item(s) listed below from the "Select Recovery Items" display then press "Enter" to recover these saved items. Recovery of these saved items will require the volumes listed on the report or duplicate volumes.

Saved Item	Save Type	---- ASP Name	----- Number	Save Date	Save Time	--- Objects ---		Sequence Number	Control Group	Volume Identi
						Saved	Not Saved			
— QSYS2	*FULL	*SYSBAS	00001	7/25/05	14:43:38	115	0	99	*SYSGRP	VOL003
— QGPL	*FULL	*SYSBAS	00001	7/25/05	10:06:15	443	0	39	*BKUGRP	VOL002
— QUSRSYS	*FULL	*SYSBAS	00001	7/25/05	10:06:15	1,520	0	45	*BKUGRP	VOL002

STEP 013 : Reset BRMS Device and Media Library Information

If you are using a 3494 tape library that is attached to a local area network (LAN), you must vary on the LAN line description. Use the WRKCFGSTS *LIN command to vary on the LAN line description. If you attach your 3494 through an RS-232 connection, you do not need to vary on the RS232 line description.

If you used values other than default values on the BRMS device and media library information displays, you should verify that your changes are still in effect. You can do this using the Work with Devices (WRKDEVBRM) command. Some of the values revert to the defaults when you use the INZBRM OPTION(*DEVICE) command.

STEP 013 : Reset BRMS Device and Media Library Information

Start date/time _____ Stop date/time _____ Duration _____

You must reset the BRMS device and media library information.

--- Attention -----
If you are using a 3494 Media Library with TCP/IP communications for recovery, you can now configure the media library for automated cartridge loading. Configure the 3494 Media Library before you reset the BRMS device and media library information.

Clear and initialize the BRMS device and media library information with the tape and media library devices currently configured on the system.

To do so, type the following command then press "Enter".

INZBRM OPTION(*DEVICE)

--- Attention -----
INZBRM OPTION(*DEVICE) resets some device information to the BRMS supplied defaults.

Review the BRMS device information.

To do so, type the following command then press "Enter".

WRKDEVBRM

Update the BRMS device information with any changes necessary before continuing with the recovery.

STEP 014 : Recover All Remaining System and User Data

If you are using a media library device in random mode to perform automated recovery, you may now select to recover all of your data. An easy way to do this is to use F16 to select all recovery items. After all items are restored, continue with STEP 019 : Recover Spooled Files for all ASPs

Note: If the recovery includes objects saved from auxiliary storage pool devices or objects saved to TSM servers, these objects cannot be selected for recovery until after the IPL step. Using F16 to select all recovery items is not recommended. Use F11=ASP View and Option 1=Select to select only those objects in auxiliary storage pool *SYSBAS

STEP 014 : Recover All Remaining System and User Data

Start date/time _____ Stop date/time _____ Duration _____

You may now select to recover all of the data on your system.
Otherwise, continue with the following step.

To do so, type the following command then press "Enter".

```
STRRCYBRM OPTION(*RESUME)
```

--- Attention -----

Press F9 on the Select Recovery Items display to go to the Restore Command Defaults display.

- ___ Ensure the tape device name or media library device name is correct for the Device prompt.
 - ___ Ensure *SAVLIB is specified for the Restore to library prompt.
 - ___ Ensure *SAVASP is specified for the Auxiliary storage pool prompt.
 - ___ Select *NEW for Restore spooled file data to recover saved spooled files concurrently with restored output queues.
 - ___ Ensure *CURRENT is specified for the Lotus point-in-time prompt.
- Press "Enter" to return to the Select Recovery Items display.

Press F16 to select all recovery items then press "Enter".

After the saved items are recovered, continue with the step following "Recover Directories and Files".

Depending on your recovery strategy, you may choose to restore the remainder of your system by control groups. Recovery by control group requires knowledge of the objects saved by each control group and sequence these objects must be restored. For instance, control group GROUP_A may have saved some objects also saved by control group GROUP_B. Selecting all saved items from both control groups will result in redundant recovery of the duplicate saved items.

Note: If you are recovering the entire system, only use control group recovery after the base operating system has been recovered.

You might choose to use recovery by control group to recover critical business applications, or to restore multiple control groups concurrently using additional sessions to improve the performance of the recovery.

To perform recovery by control group, use the following command to select and sequence the control groups to be recovered.

```
STRRCYBRM OPTION(*CTLGRP) ACTION(*RESTORE) CTLGRP(*SELECT)
```

Note: If you use different control groups for full saves than for incremental saves, you must select both control groups and sequence the incremental control groups after the full control groups.

STEP 015 : Recover IBM Product Libraries

This example shows a short list of the IBM libraries you need to recover. Your list may be much longer. Your recovery report will list all of the IBM libraries that you need to restore.

You select the libraries to recover from the Select Recovery Items display, which you access from the STRRCYBRM display.

STEP 015 : Recover IBM Product Libraries

Start date/time _____ Stop date/time _____ Duration _____

You should restore the current version of your IBM libraries.

If you are performing a complete system restore, run the following command to continue:

STRRCYBRM OPTION(*RESUME)

Otherwise, run the following command.

STRRCYBRM OPTION(*IBM) ACTION(*RESTORE)

Type your command choice then press "Enter".

Select the saved item(s) listed below from the "Select Recovery Items" display then press "Enter" to recover these saved items. Recovery of these saved items will require the volumes listed on the report or duplicate volumes.

Saved Item	Save Type	---- ASP Name	----- Number	Save Date	Save Time	--- Objects ---		Sequence Number	Control Group	Volume Identi
						Not Saved	Saved			
— QUSRDIRDB	*FULL	*SYSBAS	00001	7/25/05	10:06:15	113	0	42	*BKUGRP	VOL002
— #COBLIB	*FULL	*SYSBAS	00001	7/25/05	14:43:38	84	0	4	*SYSGRP	VOL003
— QADM	*FULL	*SYSBAS	00001	7/25/05	14:43:38	175	0	5	*SYSGRP	VOL003
— QADMDISTP	*FULL	*SYSBAS	00001	7/25/05	14:43:38	8	0	6	*SYSGRP	VOL003
— QANE	*FULL	*SYSBAS	00001	7/25/05	14:43:38	10	0	7	*SYSGRP	VOL003
.										
.										
.										

STEP 016 : Recover User Libraries

Depending on how you saved the libraries, you can choose STRRCYBRM OPTION (*ALLUSR) or STRRCYBRM OPTION(*CTLGRP) to restore them. The STRRCYBRM OPTION(*CTLGRP) command gives you more control and permits you to start concurrent restores. During complete recovery, BRMS restores both full and incremental saves.

STEP 016 : Recover User Libraries

Start date/time _____ Stop date/time _____ Duration _____

You should restore the current version of your user libraries.

If you are performing a complete system restore, run the following command to continue:

STRRCYBRM OPTION(*RESUME)

Otherwise, run the following command.

STRRCYBRM OPTION(*ALLUSR) ACTION(*RESTORE)

Type your command choice then press "Enter".

--- Attention -----
If you have logical files in libraries whose based-on physical files are in different libraries, you must recover the libraries containing the physical files before you recover the libraries containing the logical files.

--- Attention -----
If you use journaling, the libraries containing the journals must be restored before restoring the libraries containing the journaled files.

Select the saved item(s) listed below from the "Select Recovery Items" display then press "Enter" to recover these saved items. Recovery of these saved items will require the volumes listed on the report or duplicate volumes.

Table with columns: Saved Item, Save Type, ASP Name, ASP Number, Save Date, Save Time, Objects (Saved, Not Saved), Sequence Number, Control Group, Volume Identifier. Rows include \$D2BSYSCF, \$\$PROD, \$BLDBR1, \$BLDKKA, \$BLDSHIP.

STEP 017 : Recover Document Library Objects

This step recovers any saved document library objects.

```
*****
STEP 017 : Recover Document Library Objects
```

```
Start date/time _____ Stop date/time _____ Duration _____
```

You should restore the current version of your documents, folders and mail.

If you are performing a complete system restore, run the following command to continue:

```
STRRCYBRM OPTION(*RESUME)
```

Otherwise, run the following command.

```
STRRCYBRM OPTION(*ALLDLO) ACTION(*RESTORE)
```

Type your command choice then press "Enter".

Select the saved item(s) listed below from the "Select Recovery Items" display then press "Enter" to recover these saved items. Recovery of these saved items will require the volumes listed on the report or duplicate volumes.

```
--- Attention -----
When you recovery Document Library Objects (DLOs), the system updates the search index database information for these DLOs. If the recovery fails, the error message may instruct you to run reclaim on the DLOs.
```

To do so, type the following command then press "Enter".

```
RCLDLO DLO(*ALL)
```

After the reclaim, try the DLO recovery again.

```
-----
--- Objects ---
Saved      Save      ----- ASP ----- Save      Save      Not      Sequence  Control  Volume
Item       Type     Name      Number   Date      Time     Saved   Saved     Number   Group    Identi
-----
_ *ALLDLO  *FULL   *SYSBAS   00001   7/25/05  11:36:05  119    0         57 *BKUGRP  VOL002
*****
```

STEP 018 : Recover Directories and Files

This step recovers any saved directory objects. If the backup included online or incremental online backups of Lotus servers, the recovery of these objects is deferred until after the IPL because these cannot be recovered while in restricted state.

STEP 018 : Recover Directories and Files

Start date/time _____ Stop date/time _____ Duration _____

You should restore the current version of your objects in directories.

If you are performing a complete system restore, run the following command to continue:

STRRCYBRM OPTION(*RESUME)

Otherwise, run the following command.

STRRCYBRM OPTION(*LNKLIST) ACTION(*RESTORE)

Type your command choice then press "Enter".

Select the saved item(s) listed below from the "Select Recovery Items" display then press "Enter" to recover these saved items. Recovery of these saved items will require the volumes listed on the report or duplicate volumes.

--- Objects ---										
Saved Item	Save Type	---- ASP Name	----- Number	Save Date	Save Time	Not Saved	Sequence Number	Control Group	Volume	Identi
__ *LINK	*FULL	*SYSBAS	00001	7/25/05	11:36:33	11,788	0	58	*BKUGRP	VOL002

STEP 019 : Recover Spooled Files for all ASPs

- | To recover individual spooled files, you need to use the WRKSPLFBRM command. Whether you need to recover individual spooled files depends on how the spooled files were saved, and whether the saved spooled files were recovered with restored output queues.
- | If your backup strategy was to save spooled file data with saved output queues and you specified *NEW for the *Restore spooled file data* recovery default, then you probably do not need to restore individual spooled files since the spool files were restored with the restored output queues.
- | If *NONE was specified for the *Restore spooled file data* recovery default when libraries were restored and you want to restore individual spooled files, then you can restore the individuals spool files with this step.

```

*****
STEP 019 : Recover Spooled Files for all ASPs

Start date/time _____ Stop date/time _____ Duration _____

If spooled files were saved, restore your saved spooled files.

To do so, type the following command then press "Enter".

    WRKSPLFBRM

Press F16 to select all recovery items then press "Enter".

Otherwise, select the saved items you need to recover then press "Enter".

Use the media listed on the "Select Recovery Items" display.
*****

```

STEP 020 : Special Recovery Processing — IBM iSeries Integration for Windows Server

You will need to perform the following special recovery action if your system had iSeries Integration for Windows Server installed and the Integrated Windows Servers were VARIED OFF when the system was last saved.

| **Note:** This step is not shown if IBM iSeries Integration for Windows Server (5722-WSV) is not installed
| when the report is created.

```

*****
STEP 020 : Special Recovery Processing

Start date/time _____ Stop date/time _____ Duration _____

IBM iSeries Integration for Windows Server (5722-WSV)

If iSeries Integration for Windows Server was installed when your
system was saved and has been restored to the system, perform the
following steps:

If the Windows servers were VARIED OFF during the save, perform these
recovery steps:

__ a. Add the links for each server description.

    To do so, type the following command then press "Enter".

        ADDNWSSTGL NWSSTG(server-storage-name)
                NWS(server-description-name)

__ b. Vary on your Windows servers.

    To do so, type the following command then press "Enter".

        WRKCFGSTS CFGTYPE(*NWS)

    Select option 1 to vary on each server.
*****

```

STEP 021 : Special Recovery Processing — Recovering Linux servers in a logical partition

You will need to perform the following special recovery step if your system was running Linux servers in a logical partition when the system was saved.

```
*****
STEP 021 : Special Recovery Processing

Start date/time _____ Stop date/time _____ Duration _____

Recovering Linux servers in a logical partition.

If Linux servers were running in a logical partition and were VARIED
OFF when the system was saved, perform these recovery steps:

__ a. Add the links for each server description.

    To do so, type the following command then press "Enter".

        ADDNWSSTGL NWSSTG(server-storage-name)
                NWSM(server-description-name)

__ b. Vary on each Linux server.

    To do so, type the following command then press "Enter".

        WRKCFGSTS CFGTYPE(*NWS)

    Select option 1 to vary on each server.
*****
```

STEP 022 : Special Recovery Processing — IBM Content Manager onDemand for iSeries

You will need to perform the following special recovery step if your system had IBM Content Manager onDemand for iSeries installed when the system was last saved.

| **Note:** This step is not shown if IBM Content Manager OnDemand for iSeries (5722-RD1) is not installed
| when the report is created.

```
*****
STEP 022 : Special Recovery Processing

Start date/time _____ Stop date/time _____ Duration _____

IBM Content Manager OnDemand for iSeries (5722-RD1)

If Content Manager OnDemand for iSeries was installed when your
system was saved and has been restored to the system, you must enable
journaling.

To do so, type the following commands then press "Enter".

__ a. CALL QRDARS/QLRCSTRJ PARM('RLC')
__ b. CALL QRDARS/QLRCSTRJ PARM('RLR')
__ c. CALL QRDARS/QLRCSTRJ PARM('RLO')
*****
```

STEP 023 : Update Program Temporary Fix Information

You will need to perform this step, to update your PTF information in QGPL.

```
*****
STEP 023 : Update Program Temporary Fix Information

Start date/time _____ Stop date/time _____ Duration _____

You must update Program Temporary Fix Information fo all PTF save
files in library QGPL.
To do so, type the following command then press "Enter".
      UPDPTFINF
*****
```

STEP 024 : Apply Journal Changes

When you restore the entire system, the i5/OS correctly establishes the receiver chains when the journals and journal receivers are the restored. You can use the OPTION(*APYJRNCHG) on the Start Recovery using BRM (STRRCYBRM) command to assist you in apply changes to the journaled objects in user libraries. See "Recovery with Apply Journal Changes" on page 178 for additional information about using BRMS to assist you in applying journaled changes.

STEP 023 : Apply Journal Changes

Start date/time _____ Stop date/time _____ Duration _____

To determine if you need to apply journal changes, refer to the section "Determining Whether You Need to Apply Journal Changes" under chapter "Restoring Changed Objects and Applying Journal Changes" as detailed in the "Backup and Recovery" book.

--- Attention -----
The recovery includes objects saved with pending changes.
You must apply journal changes for these objects to be usable.

Use one of the following commands to specify journals for applying journal changes.

```
STRRCYBRM OPTION(*APYJRNCHG) JRN(*JRNLSST)
STRRCYBRM OPTION(*APYJRNCHG) JRN((library-name/journal-name)
                                (library-name/journal-name) ... )
```

Type your command choice then press "Enter".

__ Select Option 1=Apply journal changes on the Work with Journals using BRMS display for those journals you want to apply changes.

__ Select F16=Apply changes on the Apply Journal Changes using BRMS display to confirm your decision to apply the journal changes.

--- Attention -----
Changes will be applied to the journaled objects of the selected journals for the journal receivers currently on the system.

--- Attention -----
If you are applying changes to journals on auxiliary storage pool devices, you must set the auxiliary storage pool device to the current job before applying changes.

To do so, type the following command then press "Enter".

```
SETASPGRP ASPGRP(primary-auxiliariystorage-pool)
```

STEP 025 : Recover Additional Saved System Information

- | This step recovers any additional system information saved using the *SAVSYSINF backup item in a control group. This step is not shown if the recovery items does not include a full system save, or the full system save occurs after the *SAVSYSINF.

STEP 024 : Recover Additional Saved System Information

Start date/time _____ Stop date/time _____ Duration _____

You must recover additional system information that was saved since the last full save of the Licensed Internal Code and Operating System.

Select the saved item(s) listed below from the "Select Recovery Items" display then press "Enter" to recover these saved items. Recovery of these saved items will require the volumes listed on the report or duplicate volumes.

Saved Item		Save Type	ASP Name	ASP Number	Save Date	Save Time	--- Objects ---		Sequence Number	Control Group	Volume Identi
__	*SAVSYSINF	*FULL	*SYSBAS	00001	8/01/05	01:36:33	139	5	1	SAVSYINF	VOL005

STEP 026 : Recover Authorization Information

To restore authorities to the restored objects, use the RSTAUTBRM command.

Note: The attention block at the end of the step is generated if BRMS detects private authority information for basic user auxiliary storage pools has not been saved.

STEP 025 : Recover Authorization Information

Start date/time _____ Stop date/time _____ Duration _____

You should recover authorization information if user profiles were recovered in an earlier step.

----- Attention -----
Some authorities may not be restored if the system is not running in restricted state.
Restoring authorities can be a long running process.

Review the joblog or output from your recovery processing to ensure all recovery steps completed successfully.

Restore authorities to objects.

To do so, type the following command and press "Enter".

```
RSTAUT USRPRF(*ALL)
```

To restore authority information saved by BRMS for basic user auxiliary pools (2-32), run the following command.

```
RSTAUTBRM USRASP(*ALLUSR)
```

Type the command choice and press "Enter".

----- Attention -----
BRMS has no history of saved private authorities for basic user auxiliary storage pools (2-32).
If you want to save the private authorities assigned to objects in basic user auxiliary storage pools and improve recoverability, do not use *USRASPAUT when specifying omit items.

STEP 027 : Verify System Information

Retrieve the saved system information reports and compare to the current system information to verify the successful recovery of your system information. Change the system information as required

STEP 026 : Verify System Information

Start date/time _____ Stop date/time _____ Duration _____

You should verify your system information.

If you ran either of the following commands after the save, additional reports were created that enable you to verify your system information:

STRRCYBRM PRSYSINF(*YES)
STRMNTBRM PRSYSINF(*YES)

If you are using distribution media to restore your system, then you should use these reports to re-create the system information as detailed in the "Backup and Recovery" book.

STEP 028 : Apply PTFs

This is a good point in the recovery process to apply any PTFs that had been applied since the last save of system data, or any PTFs not yet applied.

STEP 027 : Apply PTFs

Start date/time _____ Stop date/time _____ Duration _____

Re-apply PTFs that were applied since your last save of system data.

STEP 029 : Reset System Values

Before you signoff or IPL, you should change the system values which we modified in step "Recover Operating System" to the original values or to values which reflect your desired policies.

STEP 028 : Reset System Values

Start date/time _____ Stop date/time _____ Duration _____

Use the commands and recorded values in step "Recover Operating System" to change the system values to the original setting or to a new value that meets your desired policy.

STEP 030 : Print Job Log

After completing the recovery of your entire system, use the job log to identify any items that BRMS did not successfully restore. Check the job log for all error messages, then correct the errors, and restore any missing objects from the media. To print the job log, use the DSPJOBLOG command. BRMS sends a message (CPF3773) to tell you how many objects BRMS restored.

```

*****
STEP 029 : Print Job Log

Start date/time _____ Stop date/time _____ Duration _____

You should print the joblog.

To do so, type the following command then press "Enter".

    DSPJOBLOG JOB(*) OUTPUT(*PRINT)

Review the job logs or output from your recovery processing
to ensure that all recovery steps completed successfully.
*****

```

STEP 031 : Perform IPL

Your system recovery is complete. It's is time to IPL the system.

```

*****
STEP 030 : Perform IPL

Start date/time _____ Stop date/time _____ Duration _____

Return system to normal mode and IPL.

To do so, type the following command then press "Enter".

    PWRDWNSYS OPTION(*IMMED) RESTART(*YES)
*****

```

STEP 032 : Special Recovery Processing — IBM iSeries Integration for Windows Server

You will need to perform the following special recovery action if your system had iSeries Integration for Windows Server installed and the Integrated Windows Servers were VARIED ON when the system was last saved.

- | **Note:** This step is not shown if IBM iSeries Integration for Windows Server (5722-WSV) is not installed
- | when the report is created.

STEP 031 : Special Recovery Processing

Start date/time _____ Stop date/time _____ Duration _____

IBM iSeries Integration for Windows Server (5722-WSV)

If iSeries Integration for Windows Server was installed when your system was saved and has been restored to the system, perform the following steps:

If the Windows servers were VARIED ON during the save, perform these recovery steps:

__ a. Vary off any Windows servers that are VARIED ON.

To do so, type the following command then press "Enter".

```
WRKCFGSTS CFGTYPE(*NWS)
```

Select option 2 to vary off each server.

__ b. Create any needed Network Storages.

To do so, type the following command then press "Enter".

```
CRTNWSSTG NWSSTG(server-storage-name)
```

__ c. Add the links for each server description.

To do so, type the following command then press "Enter".

```
ADDNWSSTGL NWSSTG(server-storage-name)  
NWSL(server-description-name)
```

__ d. Vary on your Windows servers .

To do so, type the following command then press "Enter".

```
WRKCFGSTS CFGTYPE(*NWS)
```

Select option 1 to vary on each server.

__ e. Restore the Windows server data using the volumes listed in "Recover Directories and Files".

To do so, type the following command then press "Enter".

```
RST OBJ('/QNTC')
```

| Additional steps could be add to the report if the recovery included objects saved from auxiliary storage
| pool devices. See "Recovery of Auxiliary Storage Pool Devices" on page 283 for additional information
| about these steps.

Recovery Tips

When preparing for either a selected or a total recovery, keep the following tips in mind:

- If BRMS cancels or ends the recovery in error, you can restart the recovery by using the STRRCYBRM *RESUME command.

- You can use the i5/OS to assist with selected restores. Before you do so, however, keep the following information in mind:
 - If you save with the option 21 (Save) you must restore with option 21 (Restore).
 - If you save with BRMS, you must restore with BRMS.
 - You cannot mix the two different types of saves and restores.
- It is possible to use BRMS to recover objects saved using the native save commands, or to use the native restore commands to recover BRMS saved objects.
- After designing and implementing your backup operation, you should test your recovery procedures using your own reports. Try to test your recovery reports on a non-production system. If do not have one available, contact your IBM representative to set up a practice recovery at an IBM Business Continuity and Recovery Services "hotsite." You can use your own recovery reports at the recovery site.
- To ensure that the recovery reports you need are up-to-date, print a new recovery report after each backup, or at least once per day.
- Always follow the steps in the Recovering Your Entire System report as they appear.
- Always keep copies of the reports in easily retrievable locations in case of disaster. Be sure to keep an updated copy of the recovery reports at all of the off site locations that contain active media.

Part 2. Tailoring Your BRMS Operations

Chapter 5. Working with Devices in BRMS

This chapter provides information on how to add, change, remove, and review standalone and media library tape devices in BRMS. During installation, BRMS automatically registers and initializes the devices attached to your iSeries and creates corresponding device information entries. BRMS creates a default device based on the fastest and most automated device attached at that time (if more than one device is attached or registered. Otherwise BRMS uses the sole attachment as the default device). Unless you change it, BRMS sends all of your backup and recovery requests to the default device. In this chapter, you learn how to change or remove device information for existing devices, and also how to add new devices to the system.

BRMS works with all standard iSeries tape devices. IBM continually enhances BRMS to work with new and improved devices. BRMS does not support diskette, optical, unlabeled or nonstandard label tape.

Adding New Devices

There are two ways you can register devices with BRMS. You can use the Initialize BRM (INZBRM) command to perform the registration and initialization tasks for you automatically. Or you can perform these tasks yourself using other BRMS commands.

Whenever you add a device, be it manually or through the INZBRM command, you must create new media classes to match. BRMS only creates media classes for you during the installation process. For information on how to create media classes, see Chapter 6, "Setting Up Your Media Management Operation," on page 77.

Adding a New Device Automatically

Procedures for adding a new device are the same for both stand-alone devices and library devices. To add a new device to your iSeries, take the following steps:

1. Attach the device to your system.
2. Type INZBRM OPTION(*DATA) at a command line and press Enter. In addition to creating policy, control group, and other defaults, this command registers and creates new device information entries for the devices currently attached to your system. Device information entries include:
 - Device name (for example, TAP01 or TAPMLB01). This is the device that BRMS uses as the default device.
 - Device type (for example, a 3570 or a 6340).
 - Model type.
3. If your device is a standalone that is not shared with other systems, or if it is a media library, **you must vary it on before using it**. You can vary on both standalone and media library devices by taking option 8 (Work with status) from the Work with Devices (WRKDEVBRM) display. Alternatively, you can vary on a media library by using the Work with MLB Status (WRKMLBSTS) command. When sharing the device between multiple systems, BRMS varies it on and off for you, by the jobs that are lined up in the work queue.

The INZBRM command initializes your device automatically.

Note: Should you have difficulty varying on a device, see the *Backup and Recovery* book for assistance.

Adding a New Device Manually

To manually add a device to BRMS, take the following steps:

1. Attach the device to your system. Ensure that the device is configured to the system, either by an I/O processor reset or by an IPL with autoconfiguration.
2. Type `WRKCFGSTS CFGTYPE(*DEV) CFGD(TAP*)` at a command line to view the list of standalone devices and media libraries on the Work with Configuration Status display.
3. At this display find the name of the device you want to add to BRMS.
4. Type `WRKDEVBRM` at a command line and press Enter.
5. At the Work with Devices display, type a 1 (Add) in the *Opt* field.
6. Type the name of the device you want to add in the *Device* column.
7. Enter the device type (`*TAP` for standalone devices, `*VRTTAP` for a virtual tape device, or `*TAPMLB` for tape libraries) in the *Category* column. Then press Enter.
8. At the Add Tape Devices display, fill out the additional parameters as needed. Press Enter to add the device entry to BRMS.
9. If your device is a standalone not shared with other systems, or if it is a media library, **you must vary it on before using it to process jobs**. You can vary on both stand-alone and media library devices by taking option 8 (Work with status) from the Work with Devices (`WRKDEVBRM`) display. Alternatively, you can use the Work with MLB Status (`WRKMLBSTS`) command. When sharing the device between multiple systems, BRMS varies it on and off for you, by the jobs that are lined up in the work queue.

Note: If you added a media library to BRMS, use the Work with Media Libraries (`WRKMLBBRM`) command to release the library when it is ready for use.

Changing an Existing Device

There are slightly different options available when you want to change existing device information, depending on whether the device is a stand-alone, virtual or a tape library. This section provides information on how to change device information for both types of devices.

Changing Device Information for Stand-Alone Devices

To change device information for an existing stand-alone device, take the following steps:

1. Type `WRKDEVBRM` at a command line and press Enter.
2. At the Work with Devices display, locate the name of the device you want to work with and type a 2 (Change) in the *Opt* column. This takes you to the Change Tape Device display.

```

Change Tape Device

Tape device . . . . . : TAP01
Device type/model . . . . . : 6386/001

Type changes, press Enter.

Text . . . . . Entry created by BRM configuration

Location . . . . . *HOME          Name, F4 for list

Use optimum block size . . . . . *YES          *NO, *YES
Next volume message . . . . . *YES          *YES, *NO
Tape mount delay . . . . . *IMMED         *IMMED, 1-999
Auto enroll media . . . . . *SYSPCY       *SYSPCY, *NO, *YES

Shared device . . . . . *NO            *YES, *NO
  Shared device wait . . . . .      30        Seconds

F3=Exit  F4=Prompt  F12=Cancel

More...
```

3. Change the parameters as needed. Following are brief summaries of the key parameters on this display:

- The default value in the *Use optimum block size* field is *YES. If you want to use this default value, keep the following restrictions in mind:
 - i5/OS cannot duplicate media volumes if the output device uses a block size that is smaller than the blocks being read by the input device.
 - If you use the optimum block size, the system does not compress the data.
 If these restrictions concern you, set the value to *NO . In that case, BRMS uses the default block size that is supported by your device. It is recommended, however, that you use the default value, *YES , whenever possible because the device performs better when writing larger blocks of data at once.
- The default value in the *Auto enroll media* field is *NO and is established in the system policy (*SYSPCY). If you want BRMS to automatically enroll media into the tape device you want to use, you can specify *YES at this display.
- The default value in the *Shared device* field is *NO. If you want to share a device between multiple systems, change this parameter to *YES , and keep the following information in mind:
 - BRMS manages device availability for shared devices. This means that BRMS varies off the device after use so that it is readily available for use by another system. BRMS varies on all of the devices it needs prior to a save operation. The *Shared device wait* field specifies how long BRMS should wait for a device to become available if it cannot locate any usable devices.
 - **Device pooling** happens when several iSeries servers share a single tape drive or set of tape drives. In this case, i5/OS or BRMS picks an eligible device from a pool of devices that supports the read and write densities you need. This permits several iSeries servers to access the pool at the same time for any eligible device. In this way, you do not have to wait for a specific device to become available or fail the operation due to a busy device. If you are using a tape library, i5/OS manages device pooling for you. If you are using a stand-alone device, BRMS manages device pooling for you.
- In the *Allow densities* field you can indicate the density at which your device can read and write to media. BRMS separates densities into the read and write densities that are allowed by your device. This separation recognizes that some devices can read media to a device but cannot write to it and vice versa. Other devices can read and write the same densities. The ability to specify the densities that a device can read or write is particularly useful when using device pooling. For example, if you are backing up media with a density of 1600 BPI, you can use a 2400-A12 or a 9348-0001 for this operation. BRMS can do this because both devices can write to media at 1600 BPI. You can have multiple devices assigned to a location.
- After you have changed and reviewed these and other parameters as needed, press Enter to return to the Work with Devices display.

Changing the Device Name

You can also use the Work with Devices display to change the name of your device. To change the name of a stand-alone device, take the following steps:

1. At the Work with Devices display, type an 8 (Work with status) in the *Opt* field next to the device you want to rename. Press Enter.
2. At the Work with Configuration Status display, again type an 8 (Work with description) in front of the device you want to rename. Press Enter.
3. At the Work with Device Descriptions display, type a 9 (Rename) in front of the device you want to rename and press Enter.
4. Rename the device at the Rename Object (RNMOBJ) display.
5. Press Enter twice to return to the Work with Devices display.

To change the name of a media library device, take steps 1-5 from the Work with Media Library Status (WRKMLBSTS) command.

Changing Device Configuration Information

There are several types of device configuration information that you can change from the Work with Devices (WRKDEVBRM) display. To do so, type an 8 (Work with Devices) in front of the device you want to work with and press Enter. This takes you to the Work with Configuration Status (WRKCFGSTS) display. Alternatively, you can go directly to the Work with Configuration Status display by entering WRKCFGSTS from a command line. On the WRKCFGSTS command, you can change or review the following items:

- Vary on and vary off status (if your device is not shared).
- Device description information.
- Status of the jobs you want the device to process.
- Mode status.
- Recovery requests pertaining to the device.
- LAN adapters and APPN status (when applicable).

The WRKDEVBRM command is the primary command for working with device information for stand-alone devices. Use it to change and remove media information as needed.

Changing Device Information for Media Library Devices

BRMS supports all IBM media libraries (MLB) and has the capability to support third-party library devices. An MLB is an automated tape library. You can store a large number of tapes in an MLB unit and access a specified tape or tapes for read and write operations. BRMS determines which volumes reside in the MLB, and when needed, issues the proper command to mount the volume.

Tape libraries enable BRMS to provide the following support:

- Perform save and restore operations automatically.
- Perform file retrieve automatically.
- Can migrate infrequently used data from DASD to less expensive storage media while maintaining the ability to access it automatically.
- Can archive massive amounts of data, such as in image or spooled archive applications.
- Provide hardware that new applications can use to manage offline storage.
- Manage scratch tapes and tape usage.

Using the WRKMLBBRM Command

While you can make some changes to media library information from the WRKDEVBRM command, the Work with Media Libraries (WRKMLBBRM) command provides more options at a greater level of detail. To get there, take the following steps:

1. Type WRKMLBBRM at a command line and press Enter.

```

Work with Media Libraries                                RCHAS400
Position to . . . . . Starting characters
Type options, press Enter.
 2=Change  3=Hold   5=Display  6=Release  8=Work with MLB media
 9=Display MLB media 10=Display MLB status 11=Add MLB media

Opt  Library  Status  Location  Text
-   MLB01    Released  VAULT     Entry created by BRM configuration
-   TAPMLB03 Released  TAPMLB03 Entry created by BRM configuration

Bottom

F3=Exit  F5=Refresh  F9=System command  F12=Cancel

```

2. From this display, you can access a variety of MLB-related displays and perform the following tasks:
 - Change location, optimum block size, compaction, read and write densities, and other device-related information.
 - Change or review device description information, including renaming the device.
 - Hold and release a library for specified purposes.
 - Work with media library media, including adding, initializing, removing, mounting, and dismounting.
 - Display library status information.
 - Display media library media status information.
3. After completing your changes, press Enter to return to the Work with Media Libraries display.

Setting Up an MLB as a Shared Device

To set up an MLB as a shared device, take the following steps:

1. Type WRKMLBSTS at a command line and press Enter.
2. Type a 5 (Allocate unprotected) in front of the MLB you want to use as a shared device, and press Enter. A message appears at the bottom of the display that indicates that you changed the status of this device.
3. To remove an MLB from shared status, type a 6 (Deallocate resource) in front of the device you want to deallocate and press Enter. A message appears that indicates that you have changed the status of this device.

i5/OS determines how best to utilize the drives within the tape library. When finished with the volume, BRMS issues the corresponding command to remove the volume. For instance, when an output operation calls for a scratch volume mount, BRMS determines an eligible scratch volume and mounts the volume. After the operation completes, the MLB unloads the volume (if specified in the command), and returns the volume to its correct media inventory location.

Changing Device Information for Virtual Tape Devices

Virtual tape devices are managed by BRMS similarly to standalone tape devices with the exception that virtual volumes can be mounted automatically. You can change the attributes of virtual devices using option 2=Change from the *Work with Devices* panel. However, some device attributes cannot be changed for virtual devices. These attributes are:

| **Tape mount delay**

| The tape mount delay for virtual tape devices is always *IMMED since these volumes can be mounted without delay.

| **Auto enroll media**

| Virtual tape media cannot be auto enrolled because this media requires an image catalog and image catalog entry to use the volume. Virtual media must be added to BRMS using the **Add Media to BRM (ADDMEDBRM)** command and specifying the image catalog containing the volume on the *Image catalog (IMGCLG)* parameter. The image catalog and image catalog entry must exist for the volume to be added. See “Enrolling Virtual Tape Volumes” on page 81 for additional information about adding virtual media to the BRMS media inventory.

| **Shared device**

| Virtual tape devices cannot be shared with other systems.

| **Device uses compaction**

| Virtual tape devices do not use compaction.

| **Transfer rate per second**

| The transfer rate of virtual tape devices is dependent on processor and memory features installed on the system.

Working with Third Party Media Libraries

BRMS can support some third party (non-IBM) media libraries. To add third-party media libraries to BRMS, take the following steps:

1. Attach the device to your system.
2. Type `WRKCFGSTS CFGTYPE(*DEV) CFGD(TAP*)` at a command line to view the list of standalone devices and media libraries on the Work with Configuration Status display.
3. At this display find the name of the third-party device you want to add to BRMS.
4. Type `WRKDEVBRM` at a command line and press Enter.
5. At the Work with Devices display, type a 1 (Add) in the *Opt* field.
6. Type the name of the device you want to add in the *Device* column.
7. Enter the device type *USRMLB (for user-defined MLB) in the *Category* column. Then press Enter.
8. At the Add User Media Device display, type in the third-party commands responsible for the following activities:
 - Location (this must be the same location as the *USRMLB devices)
 - Text description
 - Mount or eject media
 - Insert and add media
 - Work with and display media
 - Work with and display status
 - Allocate and deallocate media
 - Start and End media movement
 - Work with and display status

The customer or media library manufacturer must provide commands and the program interface to BRMS and the MLB.

9. Fill out the additional parameters as needed.
10. Press Enter to add the device entry to BRMS.

Customers or manufacturers can use the following variables with each of the MLB commands. The tape exit supplies the values for these variables.

- DEVICE: the tape device name.
- VOLUME: the volume identifier.
- MLBNAME: the BRMS name of the third party MLB.

BRMS supplies the following messages for users of third-party media libraries. You can find them in message file Q1AMSGF in library QBRM.

- BRM1990: User exit retry operation message.
- BRM1991: User exit failure operation message.

If BRMS issues these messages as escape messages, then BRMS retries (BRM1990) or fails (BRM1991) the job as appropriate. Use the Work with Registration Information (WRKREGINF) command to add and register a program to an exit point.

Last Active Device

BRMS always continues any subsequent saves within a control group on the device that was last active. This allows you to completely fill all volumes and allows for better utilization of available devices. You can use the *LOAD special value for a backup item entry in a backup control group to force subsequent saves (saves following the *LOAD entry) to a different volume which may be mounted on a different standalone device or resource in a media library.

Chapter 6. Setting Up Your Media Management Operation

Use the BRMS Media Management service to set up an automated system that tracks your media through its entire life cycle from tape creation through expiration and return to scratch pool availability.

The BRMS media management service consists of a variety of components that can assist you in performing the following tasks:

- Preparing your media for use.
- Setting up storage locations for your media.
- Tracking the movement of your media to and from the storage locations.
- Tracking the enrollment, use, and expiration of your media.

Figure 6 illustrates the components that can assist you in these tasks.

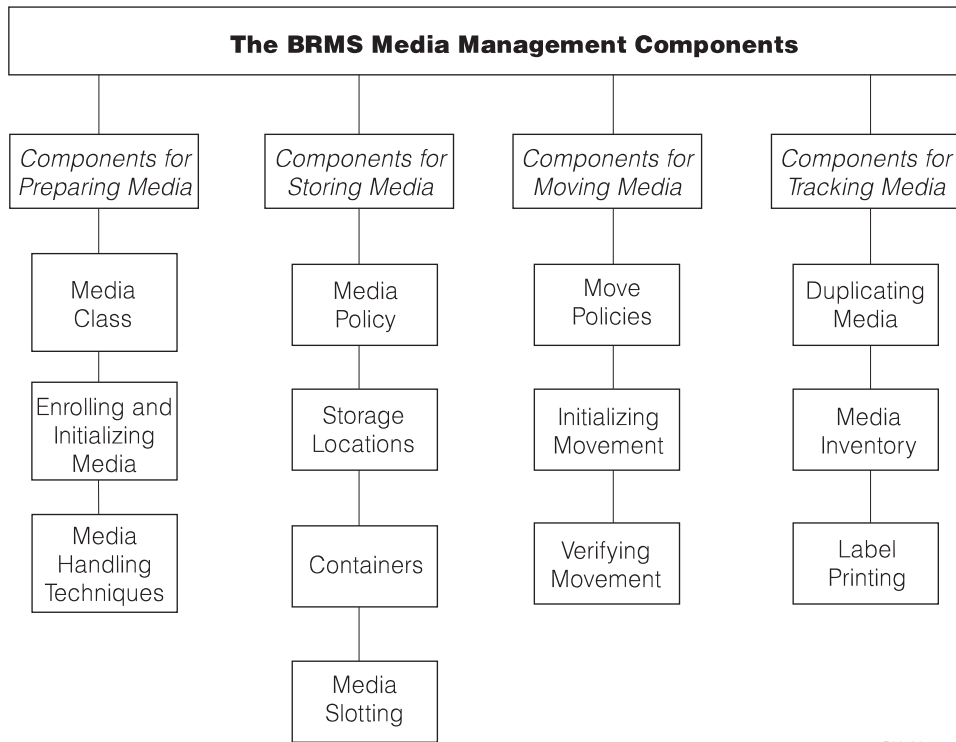

RV4N387-2

Figure 6. The BRMS Media Management Components

For convenience and ease of use and understanding, the BRMS media management components have been grouped into the work sets that are shown in Figure 6. You can set up your media management system by following the structure of this chapter from preparation through tracking. Or you can select the components that are most useful for managing your specific operation. Though you do not have to use all of the components that are discussed in this chapter, your media does need to be properly prepared before you can use it for backup purposes.

You can access all of the components that BRMS provides through commands or through the Media Management menu. The sections that follow provide CL commands for each component that is discussed. To get to the Media Management menu, do the following:

1. Type GO BRMMED at a command line and press Enter. Alternatively, you can select option 1 (Media Management) from the main BRMS menu.

```
BRMMED                               Media Management                               System:  RCHAS400
Select one of the following:
    1. Work with media classes
    2. Work with media
    3. Move management
    4. Work with storage locations
    5. Container management
    6. Media activity
    7. Confirm media label print
    8. Work with devices
    9. Work with media libraries

Selection or command
===> _____
F3=Exit  F4=Prompt  F9=Retrieve  F10=Commands  F12=Cancel  F13=Functions
```

You can access all of the primary media management components through the Media Management menu or by using the commands that are associated with each component.

Many of the functions described in this chapter are also available with the BRMS iSeries Navigator client. For detailed information on the BRMS iSeries Navigator client see the iSeries Information Center.

Preparing Your Media

This section provides information on the steps you need to take to prepare your media for BRMS to use in performing backups. Before BRMS can use media, it needs to be correctly classed by type, initialized, and enrolled into BRMS. You should also design a media inventory system that can assist you and BRMS in tracking the availability and use of your media. This section provides instruction on how you can perform all of these tasks.

Working with Media Classes

Media classes define the types of physical media that are enrolled in BRMS. The characteristics of a media class include tape density, capacity, label information, number of errors allowed, and shared status. During installation, BRMS automatically creates media classes that are based on the types of devices attached to your system. As you enroll media, BRMS assigns it to the appropriate media class. For example, if you have a 3490 tape device attached to your system, the media class might be CART3490E. In this case, the class prefix (CART) signifies a half-inch tape cartridge that is read by a 3490 device. BRMS creates media classes for all media types that are supported by your tape device.

Though BRMS does a thorough job of creating the media classes you need, there may be times when you want to create a unique media class. For example, whenever you add a new device type, you must create new media classes that are compatible with the tape device you are adding. For example, you may want to create a unique media class when you back up data that belongs to user X, Y, or Z. Or, you might create a new media class for use by developers.

To add a new media class, take the following steps:

1. Type WRKCLSBRM from a command line. Press Enter.

- At the Work with Media Classes display, type a 1 (Add) in the *Opt* column. In the *Class* column, type a unique name for the media class you want to create. For example, CART3490 or USERDOE. Press Enter.

```

                                Add Media Class

Type choices, press Enter.

Media class . . . . . USERDOE      Name
Density . . . . . F4 for list
Media capacity . . . . . *DENSITY   *DENSITY, Number nnnnn.nn
Unit of measure . . . . . 1=KB, 2=MB, 3=GB
Mark for label print . . . . . *NONE *NONE, *MOVE, *WRITE
Label size . . . . . 1             1=6 LPI, 2=8 LPI, 3=9 LPI
Label output queue . . . . . *SYSPCY Name, *SYSPCY, *PRTF
Library . . . . . Name, *LIBL
Shared media . . . . . *YES        *YES, *NO
Write once media . . . . . *YES, *NO
Text . . . . .

                                More...

F3=Exit   F4=Prompt   F12=Cancel

```

- At the Add Media Class display, review and change the parameters as needed. Following are brief summaries of the key fields on this display:
 - The default *Shared media* value of *YES instructs BRMS to share media as applicable with all systems in a network. However, you need to change this value to *NO before performing a SAVSYS backup, even if your system is not in a network. This means that you need to use a separate, unshared media class to save your operating system and licensed internal code.

Because only one system needs to use these tapes, overwriting by another system is acceptable. BRMS immediately registers volume activity on all systems in the network so you can easily track volume activity.
 - The *Write once media* prompt identifies whether the media in this class should be treated as if the volumes can be written only once. You would set this value to *YES if the type of media being used with this class is Write Once Read Many (WORM). The following identifies the operating characteristics of WORM media.
 - File sequences on WORM media cannot be reused.
 - Only new file sequences can be added to WORM media until the volume is filled.
 - WORM media cannot be re-initialized once used.
 - BRMS flags labels for printing at the *Label output queue* parameter. You can mark specific volumes for label printing by selecting option 11 on the Work with Media display. You can activate the label print request by selecting option 7 (Confirm Media Label Print) from the Media Management menu.
 - Make the class description in the *Text* field a meaningful one. This allows you to view and identify the media class entry at a glance when you get to the Work with Media Classes display.
- Press Enter to save your changes and to return to the Work with Media Classes display.

Use the Work with Media Classes (WRKCLSBRM) display any time you want to add, change or remove a media class. You can also access the Work with Media (WRKMEDBRM) display from the Work with Media Classes display to review volume information that is associated with media of a particular class. Use the Print Media Exceptions for BRM (PRTMEDBRM) display to review or print media usage statistics. BRMS bases these statistics on the characteristics you specify on the WRKCLSBRM command.

Enrolling Media

This section provides information on how to enroll and initialize volumes under a variety of circumstances. You can find instruction on how to enroll *individual* volumes into BRMS for use by stand-alone and tape library devices in "Chapter 3. Backing Up Your Entire System."

Note: i5/OS uses certain volume identifiers for special purposes. You should avoid using these volume identifiers in your volume labeling. Volume identifiers to avoid are:

- TAPxxx
- NLTxxx
- BLKxxx
- CLNxxx
- ERRxxx
- SLTxxx
- IMPxxx

Enrolling Multiple Volumes for Use by Standalone Devices

You can enroll multiple volumes into BRMS for use by a stand-alone device by using a single command. To do so, take the following steps:

1. Type ADDMEDBRM at a command line and press Enter.

```

                                Add Media to BRM (ADDMEDBRM)

Type choices, press Enter.

Volume identifier . . . . . VOL01      Character value
Media class . . . . . FMT3570E      FMT3570, FMT3570E, FMT3590,...
Number to add . . . . . 1           1-999
Initialize tape . . . . . *NO       *NO, *YES

                                Bottom
F3=Exit  F4=Prompt  F5=Refresh  F10=Additional parameters  F12=Cancel
F13=How to use this display  F24=More keys
```

2. At the Add Media to BRM display, enter a unique six-character name into the *Volume Identifier* field. To add multiples, the last characters of the volumes that you specify must be numeric (for example, TAP01).
3. At the *Media Class* field, enter the media class name of the volume you want to enroll. To select from a list of available media classes, press F4.
4. Enter the total number of volumes you want to add in the *Number to add* field. Though the *Number to add* field is large enough to contain five digits, you can only enroll a maximum of 999 volumes at one time.
5. Press F10 to review and change additional parameters as needed.
6. Press Enter to enroll the volumes.

BRMS provides the capability to automatically enroll media detected by BRMS but not found in the media inventory. You can specify the use of this capability at the *Auto enroll media* parameter on the Change System Policy display. You can specify automatic enrollment for individual, stand-alone devices on the WRKDEVBRM command.

Enrolling Multiple Volumes for Use by Media Libraries

You can enroll multiple volumes into BRMS for use by media libraries by using a single command. To do so, take the following steps:

1. Type ADDMLMBRM at a command line and press Enter.
2. At the Add Media Library Media display, type the name of the media library into which you want to enroll the media in the *Media Library* field.
3. The default value for the *Volume identifier* field is *INSERT. Use this default value to instruct BRMS to add all of the tapes that are physically in the library to the appropriate media class.
4. Press Enter twice to prompt, review, and change the other parameters as necessary.
5. Press Enter to save and exit.

Enrolling Existing Volumes

If you want to add active volumes to the BRMS media inventory, use the default value of *NO at the *Initialize Tape* field on the ADDMEDBRM display. This allows you to add volume serial information and a future expiration date without initializing the volume. If you change the value to *YES, you risk deleting existing data.

Enrolling Virtual Tape Volumes

BRMS does not auto-enroll or automatically create virtual tape media for you. Virtual tape media must be manually enrolled to the BRMS media inventory using the Add Media to BRM (ADDMEDBRM) command. You will need the image catalog name when adding the virtual volumes to BRMS.

Before the virtual tape media can be enrolled in the BRMS media inventory, you must create the image catalog, and the image catalog entries for the virtual volumes. These must be created on the same system where the volumes will be used. After the virtual tape volumes are created, add the volumes to an appropriate media class and specify the image catalog name on the *Image catalog (IMGCLG)* parameter of the ADDMEDBRM command. BRMS must know the image catalog name for a virtual volume so that it can mount the image catalog whenever the volume is used.

Use the Create Image Catalog (CRTIMGCLG) command to create the image catalog. Example:

```
CRTIMGCLG IMGCLG(MYIMGCLG) DIR('/myimgclg') TYPE(*TAP)
          TEXT('Virtual tape image catalog')
```

Use the Add Image Catalog Entry (ADDIMGCLGE) command to create the image catalog entry representing the virtual volume. Example:

```
ADDIMGCLGE IMGCLG(MYIMGCLG) FROMFILE(*NEW) TOFILE(virt01)
          VOLNAM(VIRT01)
```

The following provide additional information about virtual volume usage.

Notes:

1. The ADDMEDBRM command must be run once for each virtual media volume added.
2. Virtual tape volumes must be initialized before these can be used.
3. Virtual tape volumes use Integrated File System (IFS) storage on the current system. The file containing the virtual tape volume cannot be saved when the volume is mounted.
4. Virtual tape media can be duplicated to other tape media as long as the density of the target media is equal to or greater than the density of the source media.
5. Virtual tape media can be logically moved but not physically moved.
6. BRMS does not monitor the storage used by your virtual media.

- | 7. i5/OS does not provide volume statistics for virtual volumes.
- | 8. BRMS does not manage image catalog or image catalog entries. This is a user responsibility.

Adding Media Contents to the History File from an Enrolled Volume

BRMS uses the volume information it saves in its media history files to recover data lost due to accident or disaster. You can review or change media history information from the Work with Media Information (WRKMEDIBRM) display. See “Working with the BRMS Media Inventory” on page 101 for more information on how to use the WRKMEDIBRM display.

BRMS records content information only for media that is already part of the BRMS media inventory.

You can use the Add Media Information (ADDMEDIBRM) command to add media content information to the BRMS database. You might add this information for saves performed prior to installation of BRMS, or to add information about saves performed on other systems which you want to move to the current system which is managed by BRMS. You would use the ADDMEDIBRM command if there are only a few number of entries to add to the database. For more information about the ADDMEDIBRM command, see the online help. The advantage of ADDMEDIBRM over EXTMEDIBRM is the degree of information that can be specified about the saved items.

You can also use the Extract Media Information (EXTMEDIBRM) command to add media information to the BRMS database using information retrieved from the actual save media. You would use the EXTMEDIBRM command if you have many entries to add to the database. The information added to the database using EXTMEDIBRM contains less information than can be added using ADDMEDIBRM because the media does not provide some of this information. The advantage of EXTMEDIBRM over ADDMEDIBRM is the automation.

Notes:

1. When doing EXTMEDIBRM on a volume containing heterogeneous file sequences (a volume with both SAVLIB and SAVOBJ file sequences on it), EXTMEDIBRM can only account for one type. It is possible to load a SAVLIB database entry for objects saved using SAVOBJ causing these entries to be incorrect and not restorable. For example, if you specify *SAVLIB on the FILE parameter on the EXTMEDIBRM command, a non-SAVLIB file sequence will cause incorrect SAVLIB entry to be added to the database and any attempts to restore from this entry will fail because BRMS will try to use a RSTLIB command to restore the objects.
2. When using ADDMEDIBRM or EXTMEDIBRM, the *Licensed Internal Code* and *Operating System* are not included in the recovery report . This is because BRMS cannot verify the release.

To use the Extract Media Information display, take the following steps:

1. Type EXTMEDIBRM at a command line and press Enter.

```

Extract Media Information (EXTMEDBRM)

Type choices, press Enter.

Device . . . . . TAP01      Name
Volume identifier . . . . . *MOUNTED  Character value, *MOUNTED
File origin . . . . . *FILE      *FILE, *SAV, *SAVCFG...
End of tape option . . . . . *UNLOAD  *UNLOAD, *LEAVE, *REWIND

Bottom
F3=Exit  F4=Prompt  F5=Refresh  F12=Cancel  F13=How to use this display
F24=More keys

```

2. The key parameters on this command are:
 - In the *Device* field, specify the name of the device on which the tape is mounted.
 - In the *Volume ID* field, you can enter a specific volume name, or you can use the default value of *MOUNTED. If you use *MOUNTED, BRMS attempts to add content information for the volume that is currently in the tape device. When a volume is part of a multivolume set, BRMS adds content information for each of the volumes in the set. You must mount the media set in the same order in which BRMS performed the save. That is, the first volume of the set must be the volume that you initially mount on the specified tape device.
 - You must use the default value of *UNLOAD in the *End of tape option* field. BRMS prompts you to mount the subsequent volumes when needed and in set order.

Note: You cannot use the *MOUNTED value for a tape existing in a tape library device. Instead you need to enter the specific volume name.

3. Review and change the remaining parameter as needed.
4. Press Enter to issue the command.

Initializing Volumes

In BRMS you usually need to initialize a volume only once in its lifetime. BRMS keeps track of whether the volume has active data on it, and prevents you from overwriting the active data. In addition, it allows you to overwrite expired data. This single initialize concept means that volume error statistics can be kept for the life of the tape. BRMS associates these statistics with the volume ID. If you were to re-initialize a volume and give it a different volume serial, the statistics would be lost. Keeping lifetime statistics for volumes is effective media management. When the error rate for a particular volume is too high, remove the volume from service.

You can use either the ADDMEDBRM or the INZMEDBRM (Initialize Media using BRM) command to initialize your media. Using the ADDMEDBRM command allows you to initialize the media and also to add the initialized media to the BRMS media inventory at the same time. The ADDMEDBRM command also allows you to specify additional BRMS media management information such as location and media statistics, whereas the INZMEDBRM command only initializes media.

Note: Use the ADDMLMBRM command to initialize media for use by media libraries.

To initialize a volume from the ADDMEDBRM display, simply change the *Initialize tape* field from *NO to *YES and press Enter. Then type a valid device name into the *Device* field and press Enter (you can access the *Device* field by pressing F10, Additional Parameters).

Note: BRMS cannot initialize the volumes unless the tape device is varied on.

| If you do not initialize volumes through the ADDMEDBRM display, use the BRMS INZMEDBRM
| command instead of the i5/OS INZTAP command. To use the INZMEDBRM command to initialize your
| media, take the following steps:

- | 1. Ensure that your tape device is varied on.
- | 2. Type INZMEDBRM at a command line and press Enter.
- | 3. The key fields on this command are:
 - | • In the *Device* field, specify the name of the device that you want to use to initialize the tape, for
| example, TAP01.
 - | • In the *New volume ID* field, type in the name of the volume you want to initialize, for example,
| VOL02.
 - | • In the *Media class* field, indicate the media class you need to use for this volume, for example
| CART3490E.
 - | • To assure the protection of media on an iSeries that is using BRMS media, BRMS disables the
| CHECK(*NO) value on the INZTAP command. This affects users without *SAVSYS, *SERVICE, or
| *ALLOBJ authority. Users do not need any specific authority to use this parameter on the BRMS
| INZMEDBRM command.
- | 4. Review and change the remaining parameters as needed.
- | 5. Press Enter to apply your changes.

How Many Volumes to Initialize

| *It is important that you have sufficient volumes initialized in the scratch pool before performing a save
| operation.* If, during a save operation, you require more volumes than are available in your media scratch
| pool, a potential exposure can occur. After using your last enrolled volume, i5/OS prompts you to insert
| the next volume into the media device. If you insert an unenrolled or uninitialized volume, i5/OS issues
| an inquiry message with an option to initialize that volume. If you do not take this option and instead
| take C (for cancel) then BRMS cannot complete the save. If you take the initialize option, i5/OS assigns a
| unique volume ID that is not already in the BRMS media inventory. After the save completes, enroll this
| volume by using BRMS. Otherwise, BRMS cannot protect the data on this volume, and may overwrite it.

To support the single initialize concept, the tape file labels belonging to volumes show the date of
*PERM. This assures that you cannot write over a tape on any iSeries without receiving a message. BRMS
keeps track of whether the data on the tape has actually expired, and does not overwrite the data with
other BRMS save operations.

Setting Up Your Media Inventory System

Before you begin using media for backups, you need to set up a media inventory from which BRMS can
draw available media. There are primarily two ways to set up your media inventory: you can create sets
of media and rotate the sets, or you can use a media pool.

This section provides information on the media set rotation method primarily because it is currently in
use by some IBM customers. Because BRMS provides greater automation for tracking your media, it is
recommended that you use the more flexible media pooling method.

Media Set Rotation

Media set rotation works by grouping and rotating sets of volumes by color or another identifying code.
For example, if you want to rotate three sets of media, you might code the first one blue, the second red,
and the third, green. You might use the blue set to back up your data one week, and the red set to back

up the same data the next week. Then you might use the third (green) set to back up the same data during the third week. Once you create the coding method and the rotation time period, the set begins rotating. Media sets allow you to view the volume sequence, expiration dates, current storage location, current container, and last move dates for each volume in the set.

If you want to use the media rotation method, you need to create media classes that match your code. For example, if you use a code system with the colors red, green, and blue as identifiers, you need to set up media classes to match. In this case, you need to set up a media class for each of the colors: red, blue, and green. You would then assign each color class to a different save period, for example, week 1 for red, week 2 for blue, and so on.

Before you implement the media set rotation method, however, consider the following limitations:

- BRMS may not need all of the media in each set, which can be both wasteful and expensive.
- Unused volumes can move from location to location, which wastes time, space, and often money.
- This method requires more operator intervention. Operators must ensure that BRMS uses the correct set for each backup in the cycle.
- It limits your ability to specify different media retention periods.

Media sets are active in the media inventory as long as they contain active data.

The Media Scratch Pool Method

In a media pool, all of the media share the same media class. To create a media pool, simply create a unique media class name for the pool (such as SMPOOL). Then add each volume you want to include in the scratch pool to this media class.

The benefits of using the media pooling method are:

- A group needs fewer volumes and so fewer are wasted.
- You need less operator intervention because the media pool contains fewer volumes to track.

BRMS includes all expired media in the media pool. A media mount request initiates the use of any available volumes, regardless of the volume serial number. BRMS tracks all media, including media currently in use and media available for use.

To change from the rotation to the pooling method, change the media class names. Then make sure that you enroll the volumes into the media class or classes that are allowed in the pool.

Setting Up the Next Volume Message Prompt

BRMS can send the operator a message to mount a volume when the device needs one. This message provides the operator with a list of available media in the required media class. BRMS calls this procedure *Next volume message*, and it comes ready to use with the standard BRMS product. You can find the *Next volume message* prompt on the add and change options on the WRKDEVBRM command.

During the backup process, BRMS checks all volumes that it uses for save operations to ensure that you enrolled them into the media inventory. If they are not, BRMS issues a message that informs the operator and continues the operation. However, if you try to use a mix of enrolled and unenrolled media to perform a save, then BRMS stops the operation. BRMS then sends an error message and waits for instruction to continue or cancel the job. BRMS cannot update the media information records with information on this save because the volumes are not enrolled in BRMS. Consequently, BRMS cannot protect the data against overwriting. BRMS does not automatically enroll the volume unless you change the *Auto enroll media* field in the system policy to *YES. Good media management relies on specific enrollment of media volumes to the media inventory.

You can find the *Next volume message* prompt on the Change Tape Device display, which you can access from the Work with Devices display. If you do not want BRMS to send a message to insert the next volume, change the value in this field to *NO.

Note: You can use the *Next volume message* prompt only with stand-alone devices, not media libraries. Media libraries automatically do this for you.

Storing Your Media

This section provides information on the steps you need to take to store your media. In it, you can find instruction on how to use and design the media policies that define the retention periods for your media. You can also find instruction on how to set up storage locations for your media. In addition, you can find information on a couple of other techniques you may want to use to store your media.

Media Policies

Media policies are essential for the successful implementation of BRMS. The media policy defines the type and length of media retention. It also defines the media class and move policy you want to use for the save. In this way, the media policy ties together many of the most important media management and save elements in BRMS.

The standard BRMS product provides these predefined media policies:

1. The FULL media policy instructs BRMS to retain media for 35 days. You can use this policy for full backups.
2. The INCR media policy instructs BRMS to retain media for 14 days. You can use this policy for incremental backups.
3. The SAVSYS media policy instructs BRMS to retain media that is used for system saves for 1725 days (five years).
4. The SYSTEM media policy instructs BRMS to retain media that is used for system saves for 90 days (3 months).
5. The SAVF media policy instructs BRMS to use save files instead of media and to retain the save files for 35 days.

You can use the BRMS-configured media policies, or you can create your own media policies to suit specific purposes. You can also use a combination of BRMS-configured policies and ones you create. Unless you change them, BRMS uses the default media policies when performing backups.

You can create, change, copy, display, or delete a media policy from the Work with Media Policies display. To get there, take the following steps:

1. Type WRKPCYBRM *MED at a command line and press Enter.

```
Work with Media Policies                                RCHAS400

Position to . . . . .      Starting characters

Type options, press Enter
1=Create  2=Change  3=Copy  4=Delete  5=Display

Opt Policy      Text
1  SAMPLE
   ARCHIVAL     Entry created by BRM configuration
   FULL         Entry created by BRM configuration
   INCR         Entry created by BRM configuration
   QLTSSVR      Entry created by BRM configuration
   SAVSYS       Entry created by BRM configuration
   SYSTEM       Entry created by BRM configuration

Bottom

F3=Exit  F5=Refresh  F9=System policy  F12=Cancel
```

- Type a 1 (Create) in the *Opt* column and the name of the media policy you want to create in the *Policy* field. Press Enter. This takes you to the Create Media Policy display.

```

Create Media Policy

Type choices, press Enter.

Media policy . . . . . SAMPLE      Name
Retention type . . . . . 2          1=Date, 2=Days,
                                     3=Versions, 4=Permanent
Retain media . . . . . 35          Date, Number
Move policy . . . . . *NONE        Name, *NONE, *ADSM, F4
Media class . . . . . *SYSPCY      Name, *SYSPCY, *ADSM, F4
Storage location . . . . . *ANY     Name, *ANY, F4 for list
Save to save file . . . . . *NO     *YES, *NO
ASP for save files . . . . . *SYSTEM Name, *SYSTEM, 1-32
Save file retention type . . . . . 4 1=Date, 2=Days,
                                     3=Permanent, 4=None
Retain save files . . . . . *NONE   Date, Number, *NONE
ASP storage limit . . . . . *SYS    *SYS, 1-99
Secure media . . . . . *NO         *YES, *NO, *ADSM
Text . . . . . *NONE

F3=Exit  F4=Prompt  F5=Refresh  F12=Cancel

More...

```

Specifying Retention Periods in the Media Policy

The primary purpose of a media policy is to specify retention periods for your media. A retention period consists of the length of time that BRMS protects media from rewrite before expiring and returning it to the scratch pool. BRMS protects media from rewrite through the end of the specified retention period.

There are multiple prompts on the media policy display that pertain specifically to retention:

- The *Retention type* field specifies the type of retention method you want to use. For example, BRMS can hold media until a specified date or for a specified number of days. BRMS can also hold media through different save versions or on a permanent basis.
- The *Retain media* field specifies the time period through which you want media protected from rewrite.

BRMS designed these elements to work together. For example, when you specify a value of 2 (days) in the *Retention type* field, you must specify an actual *number* of days in the *Retain media* field, for example, 25. BRMS expires the media after the date or number of days has passed, or the number of versions exceeded.

Overlapping Retention Periods: When defining retention periods, you should leave an overlap in the retention periods you assign to media. The length of time you enter should be long enough to assure that BRMS holds a copy until or beyond the next save. There should be no time gaps in the retention cycles.

Full and Incremental Retention Periods: Retention periods can be different for full (all object) and incremental (changed objects) backups. During a recovery, BRMS uses the latest full backup and any subsequent incremental backups to restore that control group or backup item to its most current status.

BRMS allows you to specify the type of incremental backup that you want to use. A cumulative (*CUML) type of incremental backup specifies a backup that includes all changed objects and new objects since the last full backup. An incremental (*INCR) backup type specifies that incremental backups include all changed objects and new objects since the last incremental or full backup. You can specify the type of incremental backup (*CUML or *INCR) in the backup policy. You also can specify the type individually in each backup control group.

Note: Although incremental backups can reduce your backup window, they can also increase your recovery time. Because BRMS first restores the entire library, then restores the changed objects, some objects may be restored multiple times.

It is important that the retention period for incremental backups be synchronized between each other as well as with full backups. This assures full system recovery in case of system failure. BRMS uses its media content information, and media inventory, to determine the most important information to recover. BRMS bases its recovery process on the media and media information that you keep.

Storage Locations

Storage locations define where media resides during its life cycle. Common locations include computer room tape racks, fireproof vaults, and off site storage locations. You are likely to store media at several locations during its life cycle.

BRMS provides two default storage locations:

- *HOME is the default on site storage location
- VAULT is the default off site storage location

You should leave these default locations unchanged and create additional storage location entries as needed. In addition, you should store at least one copy of your backups off site in case of fire, flood, or other site disaster.

The Uses of Storage Locations in BRMS

Generally speaking, BRMS refers to locations in two ways. First, BRMS uses a **home location** from which to draw and return available media. Then BRMS uses a **storage location** as a place where media is kept when not at home. Definitions of each are as follows:

Home location

The home location is where you store media available for backup use. The home location exists as a pool from which BRMS can draw and return media. After completing a move sequence, you should return media to the home location. After expiring media, you should return it to a home location. The physical location of your home location might be a computer room or an office or any location you define. If you use a single tape device, that can be your home location. However, if you use multiple tape libraries, you **must** create a unique home location name for each library. You can base these unique names on media class or another attribute.

Storage locations

Storage locations are where you keep media that contains active data. Typically, you would keep media that contains active data in a vault or other safe storage location for a specified period of time. You do this so that copies of your system and user data are available in case of accident or disaster. You may have numerous storage locations depending on your needs. You should have at least one safe off site storage location, but you may want more. Or you might want a temporary storage location for certain tapes at certain points in their life cycles.

There are several BRMS displays that refer to locations. Following are brief summaries of how BRMS uses location information.

The *system policy* sets the default **home location** for your media. If you are using a stand-alone device, the default name for your home location is *HOME. You can use this default name or create your own home location name. **If you are using a media library, you must rename the home location. You cannot use *HOME as a home location name for media that is stored in a media library. When establishing home location names for media libraries, consider using the same name as the device name.** The names must be unique. If you use *HOME as the location name for an MLB, BRMS will try to reinsert ejected tapes.

The *move policy* has different location parameters: a home location parameter and multiple storage location parameters that you specify. The primary purpose of the move policy is to establish the move pattern of media from one location to another. For example, during a typical save cycle, media moves from its home location to the location where BRMS performs the save, and then to a vault or other safe location. After the move sequence completes, BRMS expires the media and tracks its return to the home

location for future use. You define the move sequence in the move policy. The default value in the home location field in the move policy refers to the home location that is defined in the system policy, which is *HOME. You can find information on how to use the move policies later in this chapter.

The default value in the *Storage location* field on the *media policy* is *ANY. This instructs BRMS to draw media for backups from any location at which media is available. Generally speaking, this is likely to be the scratch pool if you are using a stand-alone device. If you specify *ANY while using an MLB device, BRMS may try to mount a volume that is not in library. To avoid this, do not use the *ANY value with media library devices. In addition, you should review this parameter occasionally, especially if you permit media to expire in other than the home location. Otherwise, BRMS might request the mount of a tape that is not at the home site.

The default value in the *Location* field on the Work with Devices display is *HOME. This location name signifies **the location of the device** that is specified in the *Tape device* field (the *Media library* field if the device is an MLB). For example, the location name for a stand-alone device would typically be COMPROOM. The location name for a library device is likely to be the same as the name of the device (for example, TAPMLB01).

Note: If you want to use more than one tape device, you need to ensure that neither uses media that belongs to another system. You should also update the device description field for each device to make sure that the correct locations are specified. You can get to the device description display by entering Work with Device Descriptions (WRKDEVD) from a command line.

Using the Work with Storage Locations Display

Use the Work with Storage Locations (WRKLOCBRM) display to add, change, display, or remove storage locations (including home locations). To add a storage location, take the following steps:

1. Type WRKLOCBRM at a command line and press Enter.
2. Type a 1 (Add) in the *Opt* column and a location name in the *Location* column. Press Enter.

Add Storage Location

Type choices, press Enter.

Storage location	COMPROOM	Name
Address line 1	Lab 3, parent locaton	
Address line 2		
Address line 3		
Address line 4		
Address line 5		
Contact name	Jennie Doe	
Contact telephone number		
Retrieval time0	Hours
Allow volumes to expire	*NO	*YES, *NO
Media slotting	*NO	*YES, *NO
Text	New storage location for user data.	

More...

F3=Exit F12=Cancel

3. Use the *Address* fields to describe the location you are creating. For example, Computer lab, Building XYZ.
4. Review and change the other parameters as needed, paying particular attention to the following fields:
 - Change the value in the *Allow volumes to expire* field to *NO for off site locations. This instructs BRMS not to expire media at this location. Use the default value of *YES if you store the media nearby, for example, in a computer lab or a tape library.

- The default value for the *Media slotting* field is *NO. If you want to use the media slotting technique, you need to change this value to *YES. You can find more information on this topic later in this chapter.

5. Press Enter to save your changes and exit.

Following is a list of sample location names you can use when creating a new location:

- COMPROOM: A tape rack in your computer room (if you do not store your media in a tape library).
- TAPMLB01: Media in a tape library.
- TAPMLB02: Media in another tape library.
- VAULT: Secure off site storage.
- DONOTUSE: At this location you can store damaged tapes or tapes you no longer want available for use.

Containers and Container Classes

Container use is optional and adds an additional level of complexity to your storage management system. The container option specifies that you want to store media in physical containers at specified locations, and to use the containers to move the media.

A **container class** refers to the type of container used to store or move media, for example, a box or a bin. You must create container classes if you intend to use containers. You can base your class definition on the storage capacity of the container. For example, you might create a container class that is called CONT8MM20 to house 20 8mm tapes.

Creating a Container Class

Before you can add a container, you must create a container class. To get to the Work with Container Classes display, take the following steps:

1. Type GO BRMCNR at a command line and press Enter.
2. At the Container Management menu, select option 1 (Work with container classes). This takes you to the Work with Container Classes display.
3. Type a 1 (Add) in the *Opt* column and the name of the new container class in the *Class* column. Press Enter.

Add Container Class

Type choices, press Enter.

Container class	QICCASE	Name
Container capacity	20	Number
Media classes	QIC4GB	Class, *ANY, F4 for list
Different expiration dates	*NO	*YES, *NO
Automatic unpack	*NO	*YES, *NO
Text	Quarter inch tape capacity	

F3=Exit F4=Prompt F12=Cancel

4. Review and change the parameters as needed, paying particular attention to the following fields:

- In the *Media class* field, specify the name of the media class that you want to store in the container. You can keep volumes with different media classes in the container, or you can keep volumes of only one media class in the container. You can also specify *ANY to indicate that the container can hold volumes of any media class in the container.
 - The value in the *Different expiration dates* field specifies whether media held in the container can have different expiration dates. The default value for this parameter is *NO.
 - The default value in the *Automatically unpack* field is *YES. *YES instructs BRMS to remove information about the association between media and container after the media expires. If you change the value to *NO, BRMS holds this association information in the media information inventory. In this case, the volumes remain assigned to the container, even though BRMS cannot use them because they have expired.
5. Press Enter to save your changes and exit.

Working with Containers

After creating the container class, you can use the Work with Containers display to add a container and to perform a number of container-related tasks. To get there, take the following steps:

1. Type WRKCNRB RM at a command line and press Enter.
2. From the Work with Containers (WRKCNRB RM) display you can perform the following tasks:
 - Add a new container.
 - Change an existing container.
 - Remove a container.
 - Move a container.
 - Unpack a container.
 - Work with the media that is associated with the container.
3. After completing your work at an associated container display, press Enter to save your changes and exit. This returns you to the main Work with Containers display.

Managing Container Movement

You must assign move policies to containers. Use the move policy display to specify container use and container movement. After creating a container, go to the move policy that you want to use for that container, and change the *Use container* parameter to *YES. To review or change a move policy, take the following steps:

1. Type WRKPCYBRM at a command line and press Enter. This takes you to the Work with Move Policy display.
2. Type a 1 (Change) in front of the policy you want to work with and press Enter.

```

Change Move Policy                                RCHAS400
Move policy . . . . . : OFFSITE
Home location . . . . . *SYSPCY      Name, *SYSPCY, *ORIGIN, F4 list
Use container . . . . . *YES         *YES, *NO
Verify moves . . . . . *YES         *YES, *NO
Calendar for working days . . . *ALLDAYS Name, *ALLDAYS, F4 for list
Calendar for move days . . . . *ALLDAYS Name, *ALLDAYS, F4 for list
Text . . . . . Entry created by BRM configuration

Type choices, press Enter.

Seq      Location      Duration
  10     VAULT         *EXP

Bottom

F3=Exit   F4=Prompt   F5=Refresh   F12=Cancel

```

3. To instruct BRMS to track container use and movement, change the value in the *Use container* field to *YES.
4. Make any additional changes as needed.
5. Press Enter to save and exit.

All of the volumes in a container must have the same move policy. BRMS will not process a request to hold volumes with different move policies in the same container.

If you indicated *YES in the *Verify moves* field in the move policy, BRMS links the volume to the container at verification time. For non-verified moves, the link between volumes and container is automatic when you issue the Move Media using BRM (MOVMEDBRM) command. You can find more information on the MOVMEDBRM command later in this chapter.

When tracking media movement to containers, BRMS selects the next available container. This container supports the appropriate media class. It also selects the container with the ID that is next in ascending alphabetical sequence. Whenever possible, BRMS uses the container that is already at the location from which the media is moving.

For example, suppose that you have two containers that are members of the QIC120 container class and contain 10 QIC120 format tapes. The container labels are QICAA and QICAB. BRMS selects QICAA over QICAB if both are available. However, assume that you have another container class that holds 20 QIC120 cartridges (QIC120BIG), and that a container (QICAC) in this class is available. Even if the save uses 20 cartridges, BRMS still selects QICAA first even though QICAC seems more appropriate.

Media Slotting

Use the media slotting technique when you want to file and track media by slot number. You can use this technique at all of your storage locations, at selected ones, or not at all. You can indicate media slotting use on the Add or Change Storage Location displays using the **Work with Locations using BRM (WRKLOCBRM)** command.

The default value in the *Media slotting* field is *NO. If you want BRMS to track volumes in a media slotting system, you must change the value in the *Media slotting* field to *YES.

BRMS automatically updates the slot number at storage locations that use the media slotting technique. When BRMS moves media to that location, it assigns it a slot number. You must ensure that you move the volumes to the allocated slot.

BRMS automatically updates the slot numbers for containers that are processed through a move command. If you want to use the media slotting technique for volumes in a container, BRMS assigns the media in the container and the container itself the same slot number.

Note: A volume and a container take one slot each.

Moving Your Media

This section provides information on how you can use BRMS to track the movement of your media from one location to another. You can use move policies to create move patterns for selected media. You can then set move-related commands to issue the move patterns that you specify in the move policy. BRMS can also help you to verify that the move patterns took place as scheduled.

To view the move management options available in BRMS, take the following steps:

1. Type `GO BRMMEDMOV` at a command line and press Enter. This takes you to the Move Management menu.

```
BRMMEDMOV                Move Management                System:  RCHAS400
Select one of the following:
    1. Run media movement
    2. Verify media to be moved
    3. Print media movement report
    4. Work with move policies
    5. Work with calendars

Selection or command
====> _____

F3=Exit  F4=Prompt  F9=Retrieve  F10=Commands  F12=Cancel  F13=Functions
```

You can find information on each of these options in this section.

Move Policies

The move policy determines the sequence and duration of storage retention and movement for media and containers. Move policies also indicate how you want BRMS to verify media movement activities.

Use move policies to create move patterns for volumes that contain active media. Each move policy is tied to a media policy which, in its turn, is tied to a save item such as a library or control group. You can initiate the move pattern by using either the Move Media using BRM (`MOVMEDBRM`) or the Start Maintenance using BRM (`STRMNTBRM`) command. You can process both of these commands automatically by using a job scheduler.

BRMS comes with a default move policy called `OFFSITE`. The `OFFSITE` policy tracks the movement of media to the `VAULT` location, where it remains until expiration (`*EXP`). You can change the `OFFSITE` move policy and can also create additional move policies to track a variety of move patterns.

To create, change or delete a move policy, take the following steps:

1. Type `WRKPCYBRM` at a command line and press Enter. This takes you to the Work with Move Policy display.

2. To create a move policy, type a 1 (Create) in the *Opt* field and a name for the new policy in the *Policy* field. Then press Enter.

```

Work with Move Policies                                RCHAS400
Position to . . . . . Starting characters
Type options, press Enter.
  1=Create  2=Change  3=Copy  4=Delete  5=Display
Opt  Policy      Text
  1  PAYROLL
     OFFSITE      Entry created by BRM configuration

Bottom

F3=Exit  F5=Refresh  F12=Cancel

```

3. This example creates a move policy that is called PAYROLL. This move policy governs the movement of your volume used to save payroll information.

```

Create Move Policy                                    RCHAS400
Move policy . . . . . PAYROLL
Home location . . . . . *SYSPCY      Name, *SYSPCY, *ORIGIN, F4 list
Use container . . . . . *NO          *YES, *NO
Verify moves . . . . . *YES         *YES, *NO
Calendar for working days . . . *ALLDAYS Name, *ALLDAYS, F4 for list
Calendar for move days . . . . *ALLDAYS Name, *ALLDAYS, F4 for list
Text . . . . . Payroll move policy

Type choices, press Enter.

Seq  Location      Duration
  10  COMPROOM      5
  20  VAULT          *EXP

Bottom

F3=Exit  F4=Prompt  F5=Refresh  F12=Cancel

```

4. To set up a move pattern for this volume, take the following steps:
 - a. In the *Seq* field, specify the order in which you want BRMS to move the media to this location.
 - b. In the *Location* field, indicate the name of the location to which you want BRMS to move the media.
 - c. In the *Duration* field, indicate the length of time you want to store the media in that location. Possible values for this field include number of days, a specific date, *EXP (until expiration), *PERM (permanent), and file groups. You can find more information on file groups later in this section.

The PAYROLL move policy instructs BRMS to move the media from home location to the COMPROOM, where resides it for 5 days; then move it to the VAULT, where it remains until it expires. After the media expires, the volumes are returned to the home location.

d. After you design the move pattern, you need to attend to the remaining parameters on the move policy. Following are brief summaries of the key fields that remain on the Create Move Policy display:

- The *Home location* parameter specifies the location where BRMS returns media after its move cycle completes. Typically, this is your on site media inventory location. The default value for this parameter is *SYSPCY, which instructs BRMS to look at the system policy for the home location. The default home location in the system policy is *HOME, which you can change if needed.

In addition, you can now use a new value (*ORIGIN) that was created especially for the move process. *ORIGIN instructs BRMS to return expired volumes backup to the location at which the backup occurred. You can also press F4 to select from a list of different locations.

- In the *Verify moves* field, specify whether you want BRMS to verify media movement activities or whether you want to perform this task yourself. The default value for this field is *YES, which means that you want to verify media movement yourself. BRMS supplies you with the Verify Media Movement display, which assists you in determining whether the move schedule created in the move policy completed successfully. You can access the Verify Media Moves display from the Move Management menu. *NO means that BRMS bypasses move verification and updates location information immediately. It is recommended that you use the default value (*YES), especially if you use media libraries.
- Use the *Calendar for working days* parameter to specify which days you want to use to calculate the amount of time that media stays at each location.
- Use the *Calendar for move days* parameter to specify the days of week that you can move media from one location to another.

e. After you review and change the remaining parameters as needed, press Enter to store the move policy with BRMS.

f. Then press Enter to apply your changes.

Note: If you specify APPEND(*YES) in your backup policy, be sure that the move policy keeps the tape on site for a sufficient number of days.

Movement by File Groups

The previous example shows duration that is specified in days. Another method of utilizing move policies is by using file groups.

A file group consists of all of the volumes that belong to a control group. For example, suppose that BRMS processes a control group that is called MAINBKU on Monday and uses 10 tapes. The media policy associated with the control group contains a move policy that is called VERSION. This move policy uses file group version support. BRMS considers the 10 tapes a file group and moves them together as specified by the move policy VERSION. Each time you process the MAINBKU group, BRMS creates a new file group.

Control Group	File Group Relative Number	Creation Date	
MAINBKU	1	5/1/05	(newest)
MAINBKU	2	4/1/05	
MAINBKU	3	3/1/05	
MAINBKU	4	2/1/05	
MAINBKU	5	1/1/05	(oldest)

As you can see, the lowest numbered file group corresponds to the most recent creation date. The highest numbered file group corresponds to oldest creation date.

BRMS cannot predict when a volume that exists as a file group will move next. File group movement depends on when BRMS creates the next file group, not on a specific date. For this reason, you cannot use file group movement with specific date, or days type of duration in the same move policy.

The following display shows a sample move policy that is called VERSION.

```
Display Move Policy

Move policy . . . . . : VERSION
Home location . . . . . : TAPELIBR
Use container . . . . . : *NO
Verify moves . . . . . : *NO
Calendar for working days . . . : *ALLDAYS
Calendar for move days . . . . : *ALLDAYS
Text . . . . . : User created move policy using file groups

      Seq   Location   Duration
      10   REMOTE_A   *GRP 001
      20   REMOTE_B   *GRP 002
      30   REMOTE_C   *GRP 003

Bottom

Press Enter to continue.

F3=Exit   F12=Cancel
```

This move policy tracks the file group by file through a number of storage locations.

Movement by Control Group

You can also move media by control group. Control groups consist of groups of libraries, objects, folders, spooled files, and other types of data that share common characteristics. You can create move patterns for control groups in the move policy that is associated with the media policy for that control group. You can find more detailed information on control groups in Chapter 7, "Tailoring Your Backup."

To use a move policy with a control group, take the following steps:

1. Create the move policy, including the move pattern, that you want to use with the control group.
2. Go to the Change Backup Control Group Attributes display that is associated with the control group you want to move. Note the name of the media policy you use in the control group.
3. Use the WRKPCYBRM *MED command to get to the Work with Media Policies display.
4. Type a 2 (Change) in front of the media policy that is associated with the control group you want to move and press Enter.
5. Put your cursor in the field next to the *Move policy* parameter. Press F4 for a list of available move policies.
6. Select the move policy you just created for the control group you want to move.
7. Press Enter to save your changes and to return to the Work with Media Policies display.

BRMS tracks the movement of the media on which it saved the control group through the move pattern you created in the move policy.

Working with the Move Management Calendars

Use calendars to define groups of days or dates to use in conjunction with the move pattern that is established in your move policy. There are two calendar parameters on the move policy display: the *Calendar for working days* and the *Calendar for move days*. Together, these calendars determine the days of week that you allow media to move.

You can add, change, remove, display, or copy a calendar from the Work with Calendars display. To get there, take the following steps:

1. Type GO BRMMEDMOV at a command line and press Enter.
2. Select option 5 (Work with Calendars).

```
Work with Calendars                                RCHAS400
Position to . . . . . Starting characters
Type options, press Enter.
 1=Add  2=Change  3=Copy  4=Remove  5=Display
Opt  Calendar  Text
      HOLIDAY   Holiday calendar
      WORKING   Working day calendar

Bottom

F3=Exit  F5=Refresh  F12=Cancel
```

Establishing a Calendar for Working Days: Working days might be Monday through Friday or any specific day designation you want to make. Suppose that, on a move policy, you indicate M-F as working days, and that you indicate 10 days as the duration period for the move. In this case, the media actually stays in that location for 14 days. That is because BRMS does not include the weekend days as working days.

Establishing a Calendar for Move Days: Once you establish the working days, you can then establish a calendar for move days. Move days are days on which you allow media to move. For example, suppose that the calendar for working days is Monday through Friday. A tape arrives in a location on Wednesday and will remain there for 9 days. You scheduled the tape to move to its next location on a Tuesday. However, if the move calendar allows for media movement only on Monday, Wednesday, and Friday, then BRMS indicates that the move happened on the second Wednesday. This process assumes that the Wednesday scheduled for media movement is not an exception day in a reference calendar. It also assumes that BRMS processes the STRMNTBRM command on that Wednesday. You can find more information on how to use the STRMNTBRM command in the following section.

Defining Exceptions to Another Calendar: You can use also calendars to define exceptions to another calendar, which BRMS calls a reference calendar. For example, you could define a holiday calendar as a reference calendar to a working day calendar. The holiday calendar defines holidays on which media movement would not occur, even if the day of the week is a working day.

Specifying Calendar Dates: When you add a calendar, you can specify dates in the following manner:

- A specific date such as 12/25/05 (or 122505).
- A generic date such as 12/25 (or 1225).
- A special value such as *MON, *TUE, and so on.

For each date or day entry that you make, you must select whether to include or exclude this entry from a calendar. BRMS excludes entries unless you specifically include them. For instance, if you set up a calendar with entries *MON, *TUE, *WED, *THU, and *FRI, with each entry included (*INC), then any

day is a candidate move day for this calendar. You would exclude Saturday and Sunday. Conversely, if you set up a calendar with entries *SAT and *SUN, specifying *EXC for these entries, you will exclude all of the other days of the week.

Note: Calendar names are user-defined, can be up to 10 characters in length, and must adhere to iSeries naming conventions.

Initiating Movement

There are several ways to initiate movement in BRMS. To process media movement automatically, and as specified in the move policy, use Move Media using BRM (MOVMEDBRM) command or Start Maintenance for BRM (STRMNTBRM) command. If you want to move an individual volume, take option 8 (Move) from the WRKMEDBRM display.

Initiating Movement with the MOVMEDBRM Command

The MOVMEDBRM command processes the move patterns that you set up in the move policy. You can place the MOVMEDBRM command on a job scheduler to process scheduled movement automatically, or you can process the command manually, on an individual or as needed basis. To process media movement by using the MOVMEDBRM command, take the following steps:

1. Type MOVMEDBRM at a command line and press Enter.

```

Move Media using BRM (MOVMEDBRM)

Type choices, press Enter.

Move policy . . . . . PAYROLL      *ALL, OFFSITE, PAYROLL, VER..
From location . . . . . *ALL        *ALL, *HOME, BRMSTSM, COMPR..
Container . . . . . *ALL           Name, *ALL
Media class . . . . . *ALL         *ALL, FMT3570, FMT3570E, FM..
System name . . . . . *ALL
File group . . . . . *ALL          *ALL, *NONE, *SYSTEM, *BKUG..
File group type . . . . . *ALL      *ALL, *NONE, *BKU, *ARC
Output . . . . . *PRINT            *PRINT, *OUTFILE

Bottom
F3=Exit  F4=Prompt  F5=Refresh  F12=Cancel  F13=How to use this display
F24=More keys

```

2. Indicate the move policy whose pattern you want to process through this command. If you do not know the name of the policy you want to process, press F4 to prompt a list of available move policies.
3. Review and change the other parameters as needed.
4. Press Enter to process the command.

Initiating Movement with the STRMNTBRM Command

Another way you can process media movement automatically is by using the Start Maintenance for BRM (STRMNTBRM) command. The STRMNTBRM command performs a variety of cleanup tasks that enable your operations to run more efficiently. You should schedule this command to run daily after all of your backups have completed. If you change the *Run media movement* parameter on the STRMNTBRM command to *YES, the STRMNTBRM command processes the MOVMEDBRM command after it completes its cleanup tasks. By running the MOVMEDBRM command through the STRMNTBRM command you save yourself an extra scheduling task.

To process media movement through the STRMNTBRM command, take the following steps:

1. Type STRMNTBRM at a command line and press Enter.

```

Start Maintenance for BRM (STRMNTBRM)

Type choices, press Enter.

Expire media . . . . . *YES          *YES, *NO
Expire media set volumes . . . . *NO          *NO, *YES
Media contents . . . . . *EXP          *EXP, *REUSE, *NONE
  Object level detail . . . . . *MEDCON      1-9999, *MEDCON
Remove migration information . . . 180          1-9999, *NONE
Run media movement . . . . . *YES          *NO, *YES
Remove log entries:
  Type . . . . . *ALL          *ALL, *NONE, *ARC, *BKU, *M...
  From date . . . . . *BEGIN       Date, *CURRENT, *BEGIN, nnnnn
  To date . . . . . 90            Date, *CURRENT, *END, nnnnn
Run cleanup operations . . . . . *YES          *YES, *NO
Retrieve volume statistics . . . . *YES          *YES, *NO
Audit system media . . . . . *NONE
  + for more values
Change BRM journal receivers . . . *YES          *YES, *NO
More...

F3=Exit  F4=Prompt  F5=Refresh  F12=Cancel  F13=How to use this display
F24=More keys

```

2. At the *Run media movement* parameter, change the value to *YES. This instructs BRMS to run the Move Media using BRM (MOVMEDEBRM) command.
3. Review and change the other parameters as needed.
4. Press Enter to process the command.

For more information on how to use the STRMNTBRM command, see Chapter 9, “Daily Maintenance in BRMS,” on page 195.

Verifying Movement

BRMS can verify media movement automatically, or you can verify it manually. You can specify the option you choose at the *Verify Moves* parameter on the Change Move Policy display:

- Specifying *YES at this parameter means that you intend to verify the media movement yourself, using the BRMS Verify Media Moves display to assist you.
- Specifying *NO at this parameter means that BRMS bypasses the verification step. Since BRMS cannot actually see that the media is in the correct location, it instead assumes that the move took place and updates the location information accordingly.

To get to the Verify Media Moves display, from which you can manually verify media movement, take the following steps:

1. Type VFYMOVBRM at a command line and press Enter.

```

Verify Media Moves                                RCHAS400

Type options, press Enter. Press F16 to verify all.
  1=Verify  4=Cancel move  9=Verify and work with media

Opt  Volume  Creation  Expiration  Move  Container
   Serial  Date      Date      Location  Date
  -  -  -  -  -  -  -
  1  T00001  7/06/05  7/30/05  *HOME  7/14/05  CONTBLUE
  -  BRMST1  7/06/05  7/30/05  *HOME  7/14/05  CONTBLUE
  -  T00003  7/06/05  7/30/05  *HOME  7/14/05  CONTGREEN
  -  T00004  7/06/05  7/30/05  *HOME  7/14/05  CONTGREEN
  -  T00005  7/06/05  7/08/05  *HOME  7/14/05  CONTGREEN

Bottom

F3=Exit  F5=Refresh  F12=Cancel  F16=Verify all

```

2. Type a 1 (verify) in front of the volume whose movement you want to verify and press Enter. This takes you to the next Verify Media Moves display.

```

Verify Media Moves                                RCHAS400

Type options, press Enter. Press F16 to verify all.
  1=Verify  4=Cancel move  9=Verify and work with media

Opt  Volume  Creation  Expiration  Move  Container
   Serial  Date      Date      Location  Date
  1  BRMST1  11/03/05  *VER 002  MLD02  11/05/05  *NONE

Bottom

F3=Exit  F5=Refresh  F12=Cancel  F16=Verify all

```

3. Review the information on this display that pertains to the media whose movement you want to verify. If the location and move date information are correct, type a 1 (Verify) next to the volume.
4. Press Enter to process the verification information.
5. Press F3 to exit and save your changes.

You should verify media movement manually until you are certain that the move patterns are completing successfully.

Printing Movement-related Reports

Following are brief summaries of the movement-related reports you can run through BRMS. You can access these reports by entering the command name at a command line, or through the Move Management menu.

- *Option 1: Run Media Movement (MOVMEDBRM)* creates a Volume Movement Report that lists all media volumes currently eligible for movement. This report also displays the current move schedule for these volumes.

- *Option 3: Print Media Movement (PRTMOVBRM)* creates the Media Movement Report, which serves as a picking list for volumes to be moved from one storage location to another. PRTMOVBRM allows you to print the Media Movement Report based on a specified date range. You can also print the reports by verification status and storage location. The report shows all volumes that have moved, the "to" and "from" locations, the move policy for each volume, and the move date. Although this report is optional, it is recommended because it provides additional detail.

Tracking Your Media

BRMS provides several methods for tracking the status of your media. The most comprehensive of these is an online media inventory that manages and tracks volumes and volume information. You can also generate status reports based on the media inventory contents. Another way is to duplicate the volumes that contain your most critical saves and store them in a safe place. You can also track media by volume label.

Working with the BRMS Media Inventory

The Work with Media (WRKMEDBRM) display is the primary display for viewing and changing your up-to-date media inventory. From this display, you can view media class, move status, location, duplication status, and volume creation and expiration dates by volume. You can also use this display to add, change or remove media from the media inventory.

BRMS tracks all operations to tape, except Save Storage (SAVSTG). If BRMS uses a volume that is not in the BRMS media inventory, it logs the event, and the tape operation continues. BRMS does not record volume content information for those volumes not in the media inventory.

BRMS can track volume content at the user-specified level of detail. BRMS can track volume content at the library level, object level, or member level for any enrolled volume.

To get to the Work with Media display, take the following steps:

1. Type WRKMEDBRM at a command line and press Enter.
2. The WRKMEDBRM display shows the status of your media by volume ID and includes information such as upcoming move dates and current location information.

```

                                Work With Media
                                System:  RCHAS400
Position to . . . . .           Starting characters

Type options, press Enter.
  1=Add  2=Change  4=Remove  5=Display  6=Work with serial set  7=Expire
  8=Move 10=Reinitialize ...

  Volume      Creation Expiration      Move      Media      Dup
Opt  Serial   Expired   Date      Date      Location  Date      Class     Sts
-----
  5  DRB001   *YES    12/01/05 *NONE    VAULT     12/01/05 FMT3570
     DRB002   *YES    12/01/05 *NONE    VAULT     12/01/05 FMT3570
     DRB003   *NO     12/15/05 01/01/06 VAULT     12/19/05 FMT3570
     DRB004   *NO     12/15/05 01/01/06 COMPR00M 12/20/05 FMT3570

                                                                Bottom

Parameters or command:
====>
F3=Exit  F4=Prompt  F5=Refresh  F11=Volume system  F12=Cancel  F17=Top
F18=Bottom  F23=More options

```

3. In this example, you want to see a more detailed view of volume DRB002. To do that, type a 5 (Display) in front of the volume you want to review and press Enter.

```

                                Display Media Attributes

Volume serial . . . . . : DRB002
Media type . . . . . :
Image catalog . . . . . :
Media class . . . . . : FMT3570
Expiration date . . . . . : *NONE
Previous location . . . . . : *NONE
Previous slot number . . . . . : 0
Current location . . . . . : VAULT
Last moved date . . . . . : 12/01/05
Scheduled location . . . . . : *NONE
Scheduled move date . . . . . : *NONE
Container ID . . . . . : *NONE
Move policy . . . . . : *NONE
Creation date . . . . . : 12/01/05
Secure volume . . . . . : *NO
Beginning volume . . . . . : DRB002
Slot number . . . . . : 000001

                                More...

Press Enter to continue.

F3=Exit  F12=Cancel

```

4. After completing your review, press Enter to return to the Work with Media display. From that display, you can review and change other volumes as needed.

Printing Media Status Reports

To print a report based on the information contained on the Work with Media display, take the following steps:

1. Type WRKMEDBRM at a command line and press F4 to prompt the display.
2. Change the *Output* parameter to *PRINT and press Enter. This generates a comprehensive media inventory report.

Use the Print Media using BRM (PRTMEDBRM) command to print either of two inventory-related reports that contain information not found in the WRKMEDBRM report.

- The *Media Threshold* report identifies volumes that have equaled or exceeded the usage limits.
- The *Media Statistics* report contains all other volume statistics, such as the create and expiration dates of the current files on the volume. You can specify that the report show all of the volumes including exceptions, or just exceptions.

Duplicating Media

Use the Duplicate Media using BRM (DUPMEDBRM) command to copy the contents of a volume or set of volumes. You can copy a single volume, a list of volumes, or a media set.

Note: The OBJDTL parameter of the DUPMEDBRM command is ignored. Duplicated media will always result in duplicated object detail, if object detail information is available for the duplicated items on the input media. The object detail of the duplicated media is not actually copied, but is "keyed" to the original saved object detail to minimize the storage BRMS requires to maintain the duplicated detail information.

Before you use the DUPMEDBRM command, however, keep the following information in mind:

- You must have two devices to use this command. If the devices are shared non-MLB devices, BRMS varies the devices on for you. If your device is not a shared device, you must vary it on.
- The media or media set that you are copying must be members of the media inventory.

- When you duplicate volumes using the DUPMEDBRM command, BRMS does not automatically save the media information updates associated with the duplicated volumes. Follow the steps outlined in “Saving Media Information for Duplicate Volumes” on page 104 after duplicating volumes to assure the media information updates are saved and the recovery reports reflect the most current information.
- When supplying volume serial numbers to the DUPMEDBRM commands as values for the *To volume identifier* field, you must provide more expired volume serial numbers to receive output copies. This is in case of any length variations between physical volumes.
- You cannot duplicate saved items saved to TSM servers using the DUPMEDBRM command. Duplication of TSM server media is managed by the TSM administrator using TSM operations.

Notes:

1. The tape devices do not have to support the same media classes. You specify the media policy in the DUPMEDBRM command.
2. To use DUPMEDBRM to copy a file group, the output media assumes the group number of the input media. An exception to this is a SETMEDBRM command that overrides the value for file group and type for the output volumes.
3. The easiest approach to duplicate volumes of a parallel set is to mark the volumes for duplication then use VOL(*SEARCH) on the DUPMEDBRM command.

Copying Volumes with DUPMEDBRM

To use the DUPMEDBRM command, take the following steps:

1. Type DUPMEDBRM at a command line and press F4 to prompt the display.
2. At the Duplicate Media using BRMS (DUPMEDBRM) display, press F9 to prompt the remaining parameters.

```

Duplicate Media using BRM (DUPMEDBRM)

Type choices, press Enter.

From volume identifier . . . . . VOL001      Character value, *LIST...
Resume key . . . . .                    1-999999, *ALL
File group . . . . . *ALL                 *ALL, *BKUGRP, *ARCGRP, *SY...
File group type . . . . . *ALL            *ALL, *BKU, *ARC
From media class . . . . . *ALL           *ALL, FMT3570, FMT3570E...
From device . . . . .                    TAPMLBRRM, TAPMLB01, TAPMLB02.
To device . . . . .                      TAPMLBRRM, TAPMLB01, TAPMLB02.
From sequence number:
  Starting file sequence number *FIRST    1-16777215, *ALL, *FIRST
  Ending file sequence number . *LAST    1-16777215, *ONLY, *LAST
To sequence number . . . . . 1           1, *END
To media policy . . . . . *SYSPCY        *SYSPCY, *NONE, ARCHIVAL...
Input volume list . . . . . *VOL         Character value, *VOL, *SET
      + for more values
From device end option . . . . . *REWIND  *REWIND, *LEAVE, *UNLOAD
To device end option . . . . . *UNLOAD  *UNLOAD, *LEAVE, *REWIND
                                          More...
F3=Exit  F4=Prompt  F5=Refresh  F12=Cancel  F13=How to use this display
F24=More keys

```

3. The *From volume identifier* parameter works in conjunction with the *Input volume list* parameter to identify the volumes to be duplicated.
 - To duplicate a single volume, even if it is a member of a set, specify *LIST for the *From volume identifier* prompt, and the volume to be duplicated for the *Input volume list* prompt.
 - To duplicate a volume set, specify a volume identifier of any volume in the set for the *From volume identifier* prompt, and either *SET or *VOL for the *Input volume list* prompt.

Note: You must use this method when duplicating the volumes of a media set in a batch job. An alternative method would be to type the name of any volume in the media set in the *From*

volume identifier parameter, then press the Enter key. BRMS will find all other volumes in the set and list these in these in the *Input volume list parameter*.

- To duplicate a list of volumes, specify *LIST for the *From volume identifier* prompt, and the volumes to be duplicated for the *Input volume list* prompt using the + field to provide the additional fields in which to list the volumes you want BRMS to duplicate.
 - To duplicate all volumes marked for duplication, specify *SEARCH for the *From volume identifier* prompt, and either *SET or *VOL for the *Input volume list* prompt.
4. In the *From device* field, specify the name of the device from which BRMS will make the duplicate. This device contains the original volume.
 5. In the *To device* field, specify the name of the device that contains the volume that will receive the duplicated information.
 6. Review the other parameters carefully and change as needed.
 7. Press Enter to process the command.

Saving Media Information for Duplicate Volumes

Take the following steps to save media information for duplicate volumes:

1. Run the BRMS backup on the original volume and specify that you want to save the media information.
2. Create the duplicate volumes with the DUPMEDBRM command.
3. Run media movement by using the Move Media using BRM (MOVMEDBRM) command so that the two sets of volumes (original and duplicate) go to different locations.
4. Perform another save of the media information by using the Save Media Information using BRM (SAVMEDIBRM) command.
5. Move the volumes that SAVMEDIBRM command creates in the previous step to the same location as the duplicate volumes.
6. Create the recovery report by specifying the location of the duplicate volumes in the STRRCYBRM LOC(duplicate-volume-location).

Remote Duplication of Media

Beginning with V5R3M0, you can use the *From system (FROMSYS)* parameter on the Duplicate Media using BRM (DUPMEDBRM) command to specify a remote system in the BRMS network that owns the volumes to be duplicated by another system in the network.

Suppose you have SYSTEM_A and SYSTEM_B both in the same BRMS network and both sharing the same tape library and media. SYSTEM_A uses a media policy which specifies that volumes are to be marked for duplication. After the backups complete on SYSTEM_A, you can run the following command from SYSTEM_B to offload the media duplication task from SYSTEM_A:

```
DUPMEDBRM VOL(*SEARCH) FROMDEV(library-device-name)
                TODEV(library-device-name)
                FROMSYS(SYSTEM_A)
```

The above command will search for all volumes owned by SYSTEM_A that are marked for duplication. SYSTEM_B performs the duplication on behalf of SYSTEM_A.

There are a few simple rules that must be followed when performing remote duplication of media.

- The value of the *Shared media* attribute of the media class used for input and output volumes must be *YES so these volumes can be shared between the two systems.
- The value of the *Receive media information* network attribute for the system performing the remote duplication must be *LIB.
- Assure all backup activity on the system specified in the *From system (FROMSYS)* parameter has ended before initiating the remote duplication operation.

Duplicating Saved Items

Beginning with V5R4M0, BRMS allows you to mark saved items for duplication as an alternative to marking volumes. If your daily saves are appended to active volumes and then duplicated, this allows you to only duplicate the appended data to the output volume rather than having to reduplicate the entire volume.

You can mark saved items for duplication by specifying *YES for the *Mark history for duplication* (MARKHST) parameter on any of the BRMS save commands, or using a media policy for the save which has *YES specified for the *Mark history for duplication* prompt.

You can have BRMS search for marked history items when running duplication by specifying *SCHHST for the *From volume identifier (VOL)* parameter of the Duplicate Media using BRM (DUPMEDBRM) command. Optionally, you can use the *Mark history for duplication (MARKHST)* parameter on the DUPMEDBRM command to specify whether the duplicated history items are to be remarked for a subsequent duplication.

You can use the Work with Media Information (WRKMEDIBRM) command and the *Duplication view* of the *Work with Media Information* display to view the marked saved items, or use options 18 and 19 to mark and unmark specific saved items. To do so:

1. Run the WRKMEDIBRM command from a command line.
2. Press F11 twice to get to the *Duplication view* of the *Work with Media Information* display.

```
Work with Media Information                                RCHAS400

Position to Date . . . . .

Type options, press Enter.
18=Mark for duplication
19=Remove mark for duplication ...

  Saved      Save      Save  Item      Duplicate  Marked for  Duplication
Opt Item     Date       Time  Type      Save Item  Duplication Resume Key
LIB06      11/23/05  14:21:11 *FULL      *NO        *YES
LIB07      11/23/05  14:27:54 *FULL      *NO        *YES
LIB08      11/23/05  14:31:42 *FULL      *NO        *YES
LIB09      11/23/05  14:59:01 *FULL      *NO        *YES
LIB10      11/23/05  15:07:05 *FULL      *NO        *YES
LIB11      11/23/05  15:10:38 *FULL      *NO        *YES

                                                                 Bottom

F3=Exit  F5=Refresh  F11=Volume information  F12=Cancel
F23=More options
```

Saved items marked for duplication will have *YES displayed in the *Marked for Duplication* field.

3. Specify option 19 for a saved item to remove mark and set the *Marked for Duplication* field to *NO.
4. Specify option 18 for a saved item to add mark and set the *Marked for Duplication* field to *YES.

Resuming Duplication

Restarting a duplication operation which has failed because of media or device errors becomes much easier with V5R4M0. Beginning with this release, each saved item selected for duplication is assigned a resume key. If the duplication operation ends prematurely, the associated resume key is provided by BRMS in diagnostic message BRM4137. You can easily restart the failed duplication operation by re-running the DUPMEDBRM command using the command parameters provided in the *Recovery* information of the BRM4137 message.

| The following illustrates how easy it is to restart duplication operations after the media or device error is corrected.

- | 1. Suppose you run the following command to duplicate VOL001 to VOL002:
| DUPMEDBRM VOL(VOL001) FROMDEV(TAPMLB01) TODEV(TAPMLB01)
| MEDPCY(FMT3570E) FROMVOL(VOL001) TOVOL(VOL002)
- | 2. The command fails after duplicating some file sequences with the following messages in the job log:
| Media duplication restart recovery.
| :
| (Media or device diagnostic messages)
| :
| Media duplication completed with errors.
- | 3. You correct the device or media error which caused the duplication to fail.
- | 4. You prompt for the extended help on the *Media duplication restart recovery* message and retrieve the restart command parameters from the *Recovery* information.
| VOL(*RESUME) RSMKEY(669190)
- | 5. You re-run the DUPMEDBRM command using the restart parameters.
| DUPMEDBRM VOL(*RESUME) RSMKEY(669190)

| You can use the Work with Media Information (WRKMEDIBRM) command and the *Duplication view* of the *Work with Media Information* display to view the saved items remaining to be duplicated. To do so:

- | 1. Run the WRKMEDIBRM command specifying the volume to be duplicated.
| WRKMEDIBRM VOL(VOL001)
- | 2. Press F11 twice to get to the *Duplication view* of the *Work with Media Information* display.

Work with Media Information							RCHAS400
Position to Date							
Type options, press Enter.							
2=Change 4=Remove 5=Display 6=Work with media 7=Restore							
9=Work with saved objects ...							
Opt	Saved Item	Save Date	Save Time	Item Type	Duplicate Save Item	Marked for Duplication	Duplication Resume Key
	LIB06	11/23/05	14:21:11	*FULL	*NO	*NO	
	LIB07	11/23/05	14:27:54	*FULL	*NO	*NO	
	LIB08	11/23/05	14:31:42	*FULL	*NO	*NO	
	LIB09	11/23/05	14:59:01	*FULL	*NO	*NO	669190
	LIB10	11/23/05	15:07:05	*FULL	*NO	*NO	669190
	LIB11	11/23/05	15:10:38	*FULL	*NO	*NO	669190

Bottom

F3=Exit F5=Refresh F11=Volume information F12=Cancel
F23=More options

| From the displayed example, you can see there are three saved items with a duplication resume key. These are the saved items remaining on the volume which have not been duplicated. Restarting duplication using resume key 669190 will complete the duplication operation for these three saved items.

| Reclaiming Media

| BRMS provides two methods for reclaiming expired media. The first method allows you to remove expired volumes from media sets if there are no active file sequences on the volume. The other method allows you to reclaim fragmented media by copying the active files sequences to another volume.

Expiring media set volumes

A media set is two or more volumes where the active files sequence on one volume spans to another volume. A second volume could span onto a third volume, and the third volume could span onto a fourth. This group of volumes is referred to as a media set. If you append your backups to the end of an existing media set, the entire set could grow over time to consist of a significant number of volumes. It is also possible that the volumes at the beginning of the set have no active data, but since these are part of the set, these volumes are not usable.

BRMS provides a means for expired media volumes in a set to be removed from the set so that the expired volumes can be returned to the scratch pool for reuse. Expiring inactive volumes in media sets could help to minimize the number of volumes you need to maintain and track.

You can have BRMS expire volumes in your media set using the Expire media set volumes (parameter of the Start Maintenance for BRM (STRMNTBRM) command. The default value for this parameter is *NO, because it is not necessary to run this function as part of your daily maintenance. If you append your daily backups to active media, it is recommended that you specify *YES for the EXPSETMED parameter periodically.

Note: Using EXPSETMED(*YES) could increase the time required to complete BRMS maintenance.

Reclaiming fragmented media

Depending on the media policies you use, it is possible for the older volumes to become fragmented, especially if you append saves to active volumes and use different retention periods for those saves. The fragmentation occurs when some file sequences expire on the volume before other file sequences. If the fragmented volumes are filled, the volumes are not usable until all file sequences have expired.

Reclamation is a process in which the active file sequences are copied to a new volume so the old fragmented volume can be expired and returned to the scratch pool. For example, assume volume VOL001 has four active file sequences 5, 167, 452, and 511, and VOL002 has three active file sequences 10, 17, and 53. If you could reclaim these two volumes to a third volume, VOL00A at file sequences 1 through 7, then volumes VOL001 and VOL002 would become available for reuse.

Using media reclamation can help you reduce media purchases by allowing you to reuse the media you have, or enable you to move the active data onto media of higher density.

The BRMS iSeries Navigator client can assist you with your reclamation task. To start the Reclaim Wizard:

1. Open the **Backup Recovery and Media Services** folder.
2. Open the **Media** folder.
3. Right-click on the **Volumes** folder.
4. Click **Reclaim**.

External Label Printing

BRMS provides the following options for printing and customizing media labels.

How to Specify Label Printing

There are two ways to print external labels:

1. For all media in a media class
 - a. From a command line run the Work with Classes using BRM (WRKCLSBRM) command.
 - b. From the *Work with Media Classes* display, position to the media class you want to label.
 - c. Specify option 2 next to any media class and press Enter.

- | d. From the *Mark for label print* prompt on the *Change Media Class* display, you can instruct BRMS to mark a volume for label printing when a write operation occurs (*WRITE) or when media movement occurs (*MOVE). Use the *Label size* prompt to specify any one of three label sizes in the media class.

| **Note:** The *Text* field uses the current information in the media information for that volume. The text information in the field reflects the text information from the most recent control group that was processed to create media information for that volume.

- | 2. For specific media volumes
 - | a. From a command line run the Work with Classes using BRM (WRKCLSBRM) command.
 - | b. From the *Work with Media* display position to the volume you want to label.
 - | c. Specify option 11 next to volume or volumes you want to mark for label printing, then press Enter.
 - | d. To create label output for all marked volumes:
 - | • Type GO BRMMED on the command line and press Enter.
 - | • Select option 7 (Confirm media label print).
 - | • Use option 1 or press F16 to confirm.
 - | • Press Enter.

Customizing Label Printing

The source for the three printer files that BRMS uses to create the media labels exists on your system after you install BRMS. The QA1ASRC file in the QUSRBRM library contains the source. There are three members: QP1A1LP, QP1A2LP, and QP1A3LP. These three members can print 6 lines per inch (lpi), 8 lpi, and 9 lpi, respectively.

To change the format of your printer labels, edit the source member that corresponds to the labels that you selected for the media. For example, you can edit with SEU (source entry utility), RLU (report layout utility), or PDM (programming development manager). First you must give the members the correct member type of printer file (PTRF). You can do this within PDM when you are working with members.

When changing the source, do not change the record name, any of the field names, or the order of each field. The print programs depend on these named items being present. You can change the position.

You must add QUSRBRM to your library list and then compile the printer file to the library QBRM. Be sure to specify level check (*NO) on the Create Printer File (CRTPRTF) command.

```

| Volume serial . . . . . : ZZZ003
| Creation date . . . . . : 3/08/05
| Expiration date . . . . . : 4/07/05
| Location . . . . . : *HOME
| Container . . . . . : *NONE
| Text . . . . . : Monthly general ledger summary
|

```

Your customized labels should now print successfully.

Chapter 7. Tailoring Your Backup

In Chapter 3, you learned how to use BRMS-configured defaults to perform an immediate backup of your entire system. This chapter provides detailed information on how to use a variety of BRMS tools and techniques to design and implement a customized backup strategy your company.

The kind of backup operation you implement has a significant impact on the quality and success of your recovery operations. Therefore, it is important that you plan your backup strategy well. This chapter begins with a section on things to consider when you design your backup strategy. You should also be familiar with the more comprehensive planning recommendations that are presented in the *Backup and Recovery*.

Many of the functions described in this chapter are available with the BRMS iSeries Navigator client. For detailed information on the BRMS iSeries Navigator client see the iSeries Information Center.

Planning Considerations

There are several factors to keep in mind when planning your backup strategy. You need, for example, to have an accurate understanding of the user skill levels at your site. You must also be familiar with the kinds of physical resources that are available. The two most critical factors you need to consider, however, are data and timing: what to save, and when and how to save it. The following questions can assist you in designing an effective backup plan:

- How much data do I need to save on a daily basis? A weekly basis? Monthly?
- What kinds of data do I need to save at these times?
- Given the amount and kinds of data I need to save, what do my save windows look like? How much time do I have available each day and week to perform the necessary backups? At what times of the day and week are those save windows available?
- What kind of saves can I perform that will allow users to continue using the system while the saves process?
- What are my most critical applications, the ones that need to be operational as soon as possible during disaster recovery? How can we save our most critical data and applications in such a way as to be able to recover them quickly and easily?

Think about the questions above as you read through this chapter. Consider the different options available to you and the ways in which you can use them. For example, can you put some of your most critical data in a backup list, thereby effectively separating it from less critical data? When can you effectively use the save-while-active feature, which shortens your save window and allows users back on the system sooner? Does your company have the resources to perform parallel saves, which shorten your save window by processing large objects on multiple devices at the same time? You may want to write down your thoughts on these and other questions as you read through this chapter.

BRMS supports backup and recovery of objects on auxiliary storage pool devices (auxiliary storage pools 33–255). You should review Chapter 16, “Backup and Recovery of Auxiliary Storage Pool Devices,” on page 279 if you are using auxiliary storage pool devices to assure you are getting a complete backup of your user data on these devices.

When saving directory and files, you should unmount any mounted user-defined file systems (UDFSs) prior to the save to assure the objects in the mounted over directories are saved. UDFSs are automatically unmounted on auxiliary storage pool devices when the system is in restricted state. UDFSs on the system (1) or basic user auxiliary storage pools (2–32) need to be explicitly unmounted. Any unmounted UDFSs need to be remounted after the save.

The BRMS System Policy

While the backup policy contains numerous instructions on how to perform your backups, the system policy also contains several values that bear directly on your backups. The system policy provides process information to BRMS at the highest level of the policy structure that is described in Chapter 1, "Introduction to IBM Backup Recovery and Media Services for i5/OS (BRMS)," on page 3. System policy values are particularly important because they establish the default values in several functional areas. Thus, unless you change them in another policy or in a control group, BRMS applies these values to your backup activities. Following is a list of the backup-related fields for which the system policy provides default values:

- Media policy type
- Devices
- Media location
- Media class
- Interactive user status.
- Presentation controls designating backup type (full or incremental) and first day of the week.

Understanding the System Policy

To review system policy parameters, take the following steps:

1. Type WRKPCYBRM *SYS at a command line and press Enter.
2. Select option 1 (Display or change system policy) from the System Policy menu.

```
V5R4M0          Change System Policy          RCHAS400

Type choices, press Enter.

Media policy . . . . . FULL          Name, F4 for list
Devices . . . . . TAPMLB01         Name, F4 for list

Home location for media . . . . . TAPMLB01   Name, F4 for list
Media class . . . . . FMT3570       Name, F4 for list
Sign off interactive users . . . . . *NO     *YES, *NO
Sign off limit . . . . . 30         0-999 minutes
Output queue . . . . . *PRTF       Name, *PRTF
Library . . . . .                   Name, *LIBL
Day start time . . . . . 0:00:00     Time
Media monitor . . . . . *YES       *YES, *NO
Shared inventory delay . . . . . 60   30-9999 seconds
Auto enroll media . . . . . *NO     *NO, *YES
Default usage. . . . . *YES       *NO, *YES

F3=Exit  F4=Prompt  F5=Refresh  F12=Cancel          More...
```

Following are brief summaries of the key parameters on the system policy display. These are the parameters that you are most likely to change.

The default *Media policy* that is configured at installation time and used by the system policy is called FULL. The FULL media policy instructs BRMS to use full backups with a 35 day retention period. Another BRMS-configured option is INCR, which instructs BRMS to use incremental backups with a 14 day retention period. You can also use the Save System (SAVSYS) special value, which instructs BRMS to retain media for 1725 days (5 years) after a system save. You can change the default media policy to another BRMS-configured policy or to one that you created. To do so, press F4 from the *Media policy* field and select from the available list.

change the first day of the week designation in the Change Presentation Controls display. To get there, select option 5 (Change presentation controls) from the System Policy menu.

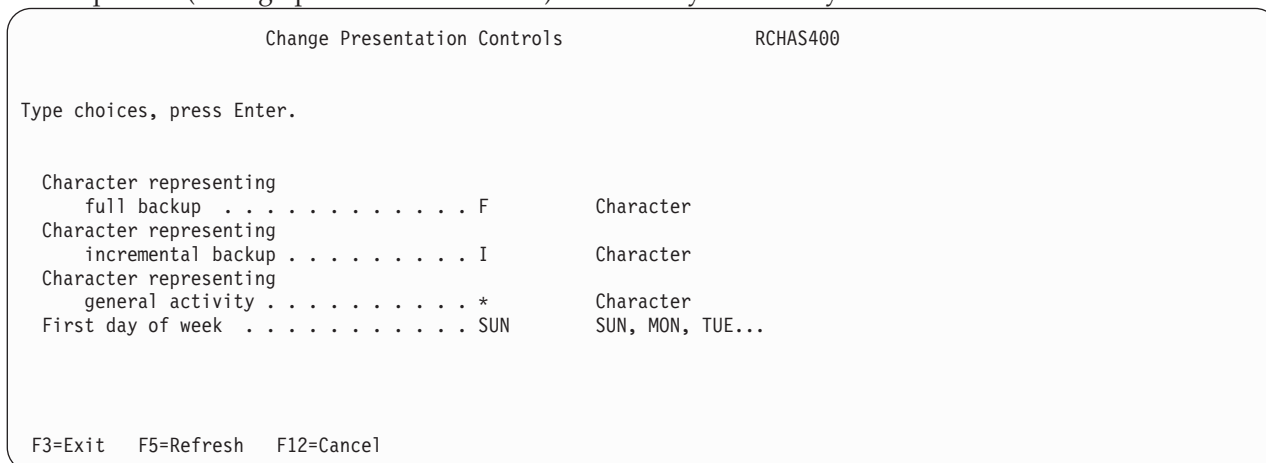

The default value for the *First day of week* parameter is SUN. You may want to change this value to MON, or to another value that better reflects the start of your work week.

The BRMS Backup Policy

The backup policy contains the most numerous and important instructions on how BRMS will perform your backups. The key parameters on this display provide BRMS with the following information:

- Type of backup (full or incremental).
- Days on which to perform full or incremental backups.
- Type of incremental backup (cumulative or noncumulative).
- Whether BRMS should save your access paths during save processing.
- Ability to append data to the end of existing files or begin a new volume as needed.

Changing the Backup Policy

Perform the following steps to get to the Backup Policy display:

1. Type GO WRKPCYBRM *BKU at a command line and press Enter.
2. Take option 1 (Display or change backup policy) from the Backup Policy menu.

```

Change Backup Policy                                RCHAS400

Type choices, press Enter.

Media policy for full backups . . . . . *SYSPCY      Name, F4 for list
Media policy for
  incremental backups . . . . . *SYSPCY      Name, F4 for list
Backup devices . . . . . *SYSPCY      Name, F4 for list

Default weekly activity . . . . . FFFFFFFF      SMTWTF(S/F/I)
Incremental type . . . . . *CUML          *CUML, *INCR
Force full backup days . . . . . *NOMAX      0-365, *NOMAX
Sign off interactive users . . . . . *SYSPCY  *YES, *NO, *SYSPCY
Sign off limit . . . . . *SYSPCY          0-999 minutes, *SYSPCY
Save journal files when saving
  changed objects . . . . . *NO           *YES, *NO

F3=Exit   F4=Prompt   F5=Refresh   F9=System policy
F12=Cancel

More...

```

As you can see, the backup policy shares several parameters with the system policy. You can override the shared prompts on an as-needed basis or to customize your backups as desired.

Following are brief descriptions of the parameters you are most likely to change:

The *Default weekly activity* value specifies the type of backup you want to perform each day of a seven-day week. For example, you might want BRMS to perform a full backup (F) on a Friday, and an incremental backup (I) on the other nights of the week. Or BRMS could perform a full backup every night. Leaving one of the days blank indicates that you do not want any backups performed on that day.

The *Incremental type* field allows you to specify the type of incremental backup you want BRMS to perform. To save all changes since the last full backup, specify *CUML in this field. To save changes since the last time BRMS performed an incremental save, specify *INCR. CUML saves make recovery activities easier and shorter, while INCR saves can make your save windows shorter. IBM recommends that you keep the default (*CUML) to provide better protection for important data.

The *Force full backup days* field allows you to force full saves rather than a save of changed objects if no save has occurred within the specified number of days.

The *Save journal files while saving changed objects* field specifies whether to save changes to objects that you entered in a journal. The default for this value is *NO, which indicates reliance on journaled receivers to retrieve changes during the recovery. IBM recommends that you change this default to *YES for ease of use, and to reduce the number of recovery steps. You should be aware, however, that using *YES increases your save time. If *YES is specified, all journaled objects are saved, not just journaled files.

3. Page down to see additional attributes.

```

Change Backup Policy                                RCHAS400

Type choices, press Enter.

Automatically backup
  media information . . . . . *LIBE      *LIB, *OBJ, *NONE
Save access paths . . . . . *YES        *YES, *NO
Save contents of save files . . . . . *YES        *YES, *NO
Save spooled file data . . . . . *NONE    *NONE, *ALL
Data compression . . . . . *DEV         *DEV, *YES, *NO
Data compaction . . . . . *DEV         *DEV, *NO
Target release . . . . . *CURRENT      *CURRENT, *PRV
Clear . . . . . *NONE                 *NONE, *ALL, *AFTER
Object pre-check . . . . . *NO         *YES, *NO
Append to media . . . . . *NO          *YES, *NO
End of tape option . . . . . *UNLOAD    *UNLOAD, *REWIND, *LEAVE
Use optimum block size . . . . . *DEV    *DEV, *YES, *NO

F3=Exit   F5=Refresh   F9=System policy   F12=Cancel

More...
```

The *Automatically backup media information* parameter specifies the level at which you want BRMS to save media information. BRMS uses the media information to assist in the restore process. The default level is *LIB. Other options are *OBJ and *NONE. To retain media information at the object level, you should indicate that preference at this field, and also at the *Retain Object Detail* parameter (change value to *YES). The *Retain Object Detail* parameter is on the Edit Control Group Entries display. If you do not specify *OBJ in the *Automatically backup media information* field, and *YES in the *Retain object detail* field, BRMS may not save the information at *OBJ level for that job.

Note: Retaining object level detail can considerably increase your disk space, and your save and restore times. Keep in mind that you can restore an individual object without object level information if you know the name of the object. You can search your save history for the library using the Work with Media Information (WRKMEDIBRM) command. Normally, the default value, *LIB, is satisfactory for most customers.

The *Save access paths* field allows you to save the access paths associated with your logical and physical files. The value in this field indicates whether to save the logical file access paths that are dependent on the physical files BRMS saves. BRMS saves access paths only if you also save all of the members on which the access paths are built. BRMS sends informational messages that indicate the number of logical access paths that were saved with each physical file. All physical files on which the access paths are built must be in the same library. This parameter does not save logical objects; it only controls the saving of the access paths.

The default value established for the *Save access paths* field in the backup policy is *YES. You can use the save access paths default that is established here for a backup control group. Or you can override the value at the Change Backup Control Group Attributes display. IBM recommends that you save the access paths, even when it time-consuming. If you do not, you run the risk of lost system availability if you need to recover the file or the system after a disaster. Saving the access paths increases the save time, but decreases your recovery time, thereby increasing system availability. See the *Backup and Recovery* book for more information on the restoration of saved paths.

Note: If BRMS performs both full and incremental saves, it restores the full saves first, then the incremental. If you do not save your access paths, they will likely be rebuilt twice, once during the restore from the full backup and then again during the restore of the incremental saves. Use the Edit Rebuild Access Path command (EDTRBDAP) to perform the rebuild right after the restoration of the full save has completed. You can then restore the incremental saves and use the EDTRBDAP command to change the sequence number.

- | The *Save spooled file data* field allows you to save the spooled files and the attributes of these files
- | concurrently when saving output queues.

The *Append to media* value specifies whether to add files on current media with active files or to begin a new volume. If you specify *YES, BRMS writes the files to the volume that immediately follows the last active file. This allows you to maximize media usage. However, if you want to separate data on separate tapes, you should specify *NO.

When you select *YES at the *Append to media* prompt, BRMS takes the following steps to select the volumes to append:

- When selecting volumes for media libraries, BRMS determines if the last volume that is used can also be used for the append operation. The media class is the determining factor. When selecting volumes for stand-alone drives, BRMS issues message BRM1472, which nominates suitable candidate volumes.
- BRMS selects an active volume with attributes that match those in the appropriate media policy. BRMS uses the following to check if the volume is available for appending:
 - Same media class
 - Same storage location
 - Same expiration date
 - Owned by the requesting system
 - Same move policy
 - Same secure attribute
- If BRMS cannot find a volume that meets the criteria above, it selects a volume with an earlier expiration date, starting with the earliest.
- If BRMS cannot select a volume with an earlier expiration date, it selects an expired volume from the system.
- If BRMS fails to find a volume up to this point, it will try to select an expired volume from another system.
- BRMS will never select a volume that has been flagged in error (expiration of volume is *ERR).

While these are the parameters you are most likely to use, you should also be familiar with the other parameters and values on the backup policy display.

Note: In addition to the backup policy itself, you can also access the Work with items to omit from backup display from the Backup Policy menu. Because the items you are likely to omit are in control groups, you can find information on how to use this display in the following section.

Backup Control Groups

Control groups consist of groups of libraries, objects, folders, spooled files, and other types of data that share common characteristics. They also specify what kind of backup you want BRMS to perform, such as full, incremental, or cumulative-incremental. In addition, control groups specify the days on which the data will be processed, and the order in which the processing occurs. As such, control groups are the most important and useful element in the BRMS tailoring process.

Control groups can also provide flexibility in starting and stopping subsystems and holding job queues. Perhaps most importantly, control groups allow you to separate and save your most critical applications, which, in turn, allows you to more easily recover them. After you recover your most critical applications and data, you can recover the rest of your system. Your save strategy is likely to consist of multiple backup control groups. “Sample Backup Scenarios: Working with Multiple Control Groups and Shared Devices” on page 151 provides specific information on how to design a backup strategy that uses multiple control groups.

The default control groups described in Chapter 3, “Backing Up Your Entire System,” on page 17 do an excellent job of backing up your entire system. IBM recommends that you use these default backup groups, called *SYSTEM, or *SYSGRP and *BKUGRP, to perform your first backup and that, afterward, you leave them unchanged and use them on an as-needed basis. In addition, you can create some of your own control groups to better control related types of data.

Control groups often refer to, and work with, information contained in the function policies, for example, in the system and backup policies. Later in this section, you learn how to set control group attributes to override policy decisions.

Content of Control Groups

Consider grouping the following items together in a control group:

- All of the libraries that belong to a particular application.
- Selected objects, such as those that change on a regular basis (instead of using an *INCR save for the objects, which must identify the changed objects).
- Libraries that comprise a database network.
- Byte stream files that form part of the application data.
- Spooled files that you may need later (for example, invoices or pay slips).
- Items with similar retention periods.
- Critical applications that you need to restore before others.
- Noncritical applications or libraries that you can restore at a later time.

A backup control group can contain just one item or a group of items. Figure 7 provides an overview of the items you can place in a control group:

Named Items	Special Values	Special Operations
<ul style="list-style-type: none"> • Library names • Generic library names • Backup list names <ul style="list-style-type: none"> – Object list – Folder list – Link list – Spooled file list 	<ul style="list-style-type: none"> • *ALLDLO • *ALLPROD • *ALLTEST • *ALLUSR • *ASPnn • *DLOnn • *IBM • *LINK • *LNKOMTLTS • *LNKOMTONL • *LTSOMTONL • *QHST • *SAVCFG • *SAVSECDTA • *SAVSYS • *SAVSYSINF 	<ul style="list-style-type: none"> • *EXIT • *LOAD • *SETASPGRP

Figure 7. Backup control group backup items

A control group might contain one library or several; one special value or several; configuration and security data; or special operations such as *LOAD or *EXIT. In short, you can save any of the items that are listed in Figure 7 in a control group. Grouped items may be of the same type (all libraries or all special values), or they may be of different types (for example, libraries, special values, and special operations).

Use special operations and special values as backup items to call system functions. They direct BRMS to perform predefined actions or to assume predefined values in a field. You can also use a backup list as an

entry in a control group. Backup lists are particularly useful for separating critical data and applications for easier recovery. They also make it easier to manage groups of data. You can find detailed information on designing backup lists in a later section of this chapter.

The following list provides a short description of the special operations and special values that can be used as Backup Item entries in control groups. Please refer to the online help information for more information about these items.

Special Operations

***EXIT** Perform user command processing

***LOAD**

Begin a new tape

***SETASPGRP**

Sets an auxiliary storage pool group to the job running the backup. Any previously set auxiliary storage pool group is automatically unset. The name of a primary auxiliary storage pool defining the auxiliary storage pool group must be specified in Auxiliary Storage Pool Device prompt.

Special Values

***ALLDLO**

Saves all folders, documents, and mail in all ASPs

Note: *MAIL data is backed up as a separate item whenever a cumulative or incremental save of *ALLDLO is performed. BRMS issues a SAVDLO DLO(*MAIL) SAVTYPE(*FULL) for the *ALLDLO.

***DLOnn**

Saves all folders, documents, and mail in a specified ASP

***ALLUSR**

Save all user libraries

***ALLPROD**

Save all *PROD type libraries

***ALLTEST**

Save all *TEST type libraries

***ASPnn**

Save a specified ASP (library type objects only)

***IBM** Save all IBM libraries

***LINK**

Save all objects not in /QSYS.LIB and /QDLS directories

***LNKOMTLTS**

Saves all IFS directories and files except all Lotus server files and files in /QSYS.LIB and /QDLS directories.

***LNKOMTONL**

Saves all IFS directories and files except online Lotus server backup files and files in /QSYS.LIB and /QDLS directories.

***LTSOMTONL**

Saves all Lotus server files except online Lotus server files.

***QHST**

Save history information

***SAVCFG**

Save configuration

***SAVSECDTA**

Save security data

***SAVSYS**

Save the operating system

***SAVSYSINF**

Saves a subset of operating system data and object information saved by the *SAVSYS backup item.

Notes:

1. This backup item does not require restricted state and is not to be used for system upgrades or migrations.
2. This backup item does not replace the *SAVSYS backup item.
3. A *SAVSYS must have been performed on the system in order to use this backup item.

Using the *SAVSYS Special Value

To use *SAVSYS in a control group, you must first set up a media class using the Add Media Class display. Specify a value of *NO in the **Shared media** field. You must then add this media class to a new media policy. You can then change the attributes of the control group to use the new media policy that does not allow shared volumes. You must enroll media by using this media class so that you can perform the *SAVSYS operation. These considerations are important for the single system environment as well as the networked environment.

Note: The *SAVSYS special value processes the SAVSYS command. You should check the parameters that are set in BRMS as well as the default parameters in the SAVSYS command to assure that you save the proper information.

Special Considerations for Using *SAVSYS as a Backup Item

When the *SAVSYS (Save System) special value is included in the backup items list of a backup control group, a copy of the QSYS library is saved in a format compatible with the installation process. It does not save objects from any other library. The *SAVSYS special value saves all object types that are shown on the **Object types** field (OBJTYPE parameter) in the Save Object (SAVOBJ) command. In addition, it saves security and configuration objects.

Note: You can perform a save of the operating system by processing the SAVSYSBRM command from the console. Refer to the online help for more information about the SAVSYSBRM command.

Performing a backup which includes a *SAVSYS and using a media library device, such as the 3494, requires no special processing. The backup is performed the same as when using a standalone tape device.

Restrictions

- You must perform a *SAVSYS backup interactively from the system console. You must exclude the user profile from signoff using the Work with Sign off Exceptions display (option 2 in the System Policy). BRMS will end all active subsystems before performing the system save function. Refer to “Scheduling a Backup with *SAVSYS” on page 119 for a complete system save.
- You must have *SAVSYS special authority to perform a backup with *SAVSYS special value.
- Tapes created using this command that are used for installation should be initialized with a density that is supported by the current alternate IPL device. If this is not done, the current alternate IPL device has to be changed to a media device that supports the density of the created *SAVSYS tapes before installation begins during a recovery.
- You cannot use tapes created by using the *SAVSYS special value for automatic installation.

- A backup control group with the *SAVSYS special value must specify *NO in the **Shared media** field of the media class.

Scheduling a Backup with *SAVSYS

To schedule a backup control group that uses the special value *SAVSYS, use the Start Backup using BRM (STRBKUBRM) command. Specify a schedule time you want the backup to begin on the SCDTIME parameter, and specify *NO on the SBMJOB parameter. You should be aware that after submitting the STRBKUBRM from the console, the console will be unavailable until the backup has completed. It is also very important to ensure that messages being sent to the console do not interrupt the STRBKUBRM command that has been submitted. To prevent the interruption by messages to the console, specify the following Change Message Queue (CHGMSGQ) command prior to submitting the STRBKUBRM command or in the backup control group that you are using:

```
CHGMSGQ MSGQ(QSYSOPR) DLVRY(*NOTIFY) SEV(99)
```

Ending and Starting Subsystems with *SAVSYS

Note: If you need to reply to messages on a nonprogrammable workstation, press Shift, System Attention, and Enter. You see the System Request display where you can select Option 6 (Display system operator messages).

If a backup control group contains a *SAVSYS special value or you issue the SAVSYSBRM command, BRMS will end all subsystems before the save commences. This ensures that no other activity can occur on the system during the save. The controlling subsystem is started after processing the last backup item in the backup control group. If you specify in your backup control group attributes that an IPL is to occur after the control group has finished processing, the controlling subsystem is not started as this is done as part of the IPL process.

By default, BRMS will restart the controlling subsystem. It is possible to prevent the controlling subsystem from starting after a *SAVSYS has been run. If you are using the SAVSYSBRM command, use STRCTL SBS(*NO). If you are using *SAVSYS in a backup control group, select option 9 from the Work with Backup Control Groups menu (WRKCTLGBRM) to work with Subsystems to process and enter the following entry.

Subsystems to Process RCHAS400

Use : *BKU
Control group : *SYSGRP

Type choices, press Enter.

Seq	Subsystem	Library	End Option	Delay	Restart
10	*ALL	*ALL	*IMMED	*NOLIMIT	*NO

Bottom

F3=Exit F5=Refresh F12=Cancel

Using Console Monitoring to Schedule an *SAVSYS

Use the console monitoring function in BRMS to enhance your ability to schedule a system save. Console monitoring allows you to put the system console in a monitored state. Refer to Console Monitoring for

more information on this topic. Also see "Submitting a Backup to the Controlling Subsystem" on page 147 for information about scheduling an unmonitored system save to the controlling subsystem.

Contents of the Default Control Groups

This section shows the entries provided in the default control groups which BRMS provides for you. It is recommended that you do not modify the entries in these control groups should you need to tailor what is backed up. You should copy the default control group into a new control group which you would use to perform the customized backup.

Note: None of the default control groups back up spooled file data.

*SYSTEM Default Control Group

The purpose of this control group is to back up your entire system. Using this control group to backup your system may increase your backup time (because you are backing up all system and user data), but it provides the simplest recovery scenario.

```

Display Backup Control Group Entries                                RCHAS400
Group . . . . . : *SYSTEM
Default activity . . . . . : *BKUPCY
Text . . . . . : Backs up the entire system

Seq  Backup  List  Auxiliary  Weekly  Retain  Save  SWA
     Items  Type  Storage  Activity Object  While  Message
     10 *EXIT          *DFTACT
     20 *SAVSYS      *DFTACT
     30 *IBM          *DFTACT  *NO    *NO
     40 *ALLUSR      *SYSBAS  *DFTACT  *ERR  *NO
     50 *ALLDLO      *DFTACT  *NO    *NO
     60 *LINK        *ALLAVL  *DFTACT  *YES  *NO
     70 *EXIT          *DFTACT

                                                Bottom

Press Enter to continue.

F3=Exit  F11=Display exits  F12=Cancel  F14=Display client omit status

```

*SYSGRP Default Control Group

The purpose of this control group is to back up only the system data on the system. The system data backed up by this control group includes:

- Licensed Internal Code
- Operating System
- Configuration Data
- Security Data
- IBM supplied libraries

This control group is used in conjunction with the *BKUGRP to assure you have backed up your entire system. However, because the system data does not change often, this control group might be run less frequently than the *BKUGRP. You should always make sure you have backed up all system and user data to ensure complete recovery of the system in the event of a disaster. Schedule this control group to run periodically as determined by your backup strategy.

```

Display Backup Control Group Entries                                RCHAS400
Group . . . . . : *SYSGRP
Default activity . . . . : *BKUPCY
Text . . . . . : Backs up all system data

Seq  Backup      List  Auxiliary  Weekly  Retain  Save   SWA
    Items      Type  Storage   Activity Object  While  Message
    10 *EXIT          *DFTACT
    20 *SAVSYS          *DFTACT
    30 *IBM          *DFTACT  *NO   *NO
    40 QIBMLINK  *LNK  *ALLAVL  *DFTACT  *NO   *NO
    50 *EXIT          *DFTACT

Bottom

Press Enter to continue.

F3=Exit  F11=Display exits  F12=Cancel  F14=Display client omit status

```

***BKUGRP Default Control Group**

The purpose of this control group is to back up only the user data on the system. Backing up only the user data reduces the time it takes to backup your system. You would consider backing up only the user data if the system data does not change often. If neither your configuration nor security data changes frequently and you are running regular full system backups, you could consider removing the *SAVSECDTA and *SAVCFG special value entries. These entries are included in this control group because the data is considered user data which is apt to change frequently.

```

Display Backup Control Group Entries                                RCHAS400
Group . . . . . : *BKUGRP
Default activity . . . . : *BKUPCY
Text . . . . . : Backs up all user data

Seq  Backup      List  Auxiliary  Weekly  Retain  Save   SWA
    Items      Type  Storage   Activity Object  While  Message
    10 *EXIT          *DFTACT
    20 *SAVSECDTA  *DFTACT  *NO
    30 *SAVCFG      *DFTACT  *NO
    40 *ALLUSR      *SYSBAS *DFTACT  *ERR  *NO
    50 *ALLDLO      *DFTACT  *NO   *NO
    60 *LINK        *ALLAVL *DFTACT  *YES  *NO
    70 *EXIT          *DFTACT

Bottom

Press Enter to continue.

F3=Exit  F11=Display exits  F12=Cancel  F14=Display client omit status

```

How to Work with Backup Control Groups

The BRMS backup control group feature consists of several displays that contain numerous parameters that you can use to create and edit control groups. This section describes the displays and parameters that you can use to set up a basic control group strategy.

- The **Work with Backup Control Groups** (WRKCTLGBRM) display is the central control group display. From this display, you can create, edit, change, delete, or display a control group. You can also select subsystems and job queues to process when a control group runs. In addition, you can place a control group on a job scheduler from this display.

- The **Edit Backup Control Group Entries** display shares the same parameters as the Create Backup Control Group Entries display. At this display, you can edit the values on an existing control group.
- The **Change Backup Control Group Attributes** display shares several parameters with the system and function policies. This display allows you to tailor each control group to meet the specific backup requirements of each save.

Creating a Control Group

In the example that follows, you learn how to create a SAMPLE control group that contains three libraries: LIBA, LIBB, and LIBC.

To create a control group, take the following steps:

1. Type WRKCTLGBRM at a command line and press Enter. This takes you to the Work with Backup Control Groups display.

```

Work with Backup Control Groups                                RCHAS400
Position to . . . . . Starting characters
Type options, press Enter
  1=Create   2=Edit entries   3=Copy   4=Delete   5=Display
  6=Add to schedule  8=Change attributes  9=Subsystems to process ...

Control      Full      Incr      Weekly
Opt Group    Media     Media     Activity
              Policy    Policy    SMTWTFS  Text
1 SAMPLE
*BKUGRP      *BKUPCY   *BKUPCY   *BKUPCY   Entry created by BRM configuration
*SYSGRP      SAVSYS    SAVSYS    *BKUPCY   Entry created by BRM configuration
*SYSTEM      SYSTEM    SYSTEM    *BKUPCY   Entry created by BRM configuration

Bottom

F3=Exit      F5=Refresh  F7=Work with BRM scheduled jobs
F9=Change backup policy  F23=More options  F24=More keys

```

2. To create a control group, type a 1 (Create) in the *Opt* column and a name for the control group in the *Control Group* field. In this case, the name of the control group is SAMPLE.
3. Press Enter. This takes you to the Create Backup Control Group Entries display.

```

Create Backup Control Group Entries                            RCHAS400
Group . . . . . : SAMPLE
Default activity . . . . . *BKUPCY
Text . . . . . Create sample backup control group

Type information, press Enter.

Seq      Backup      List      Auxiliary      Weekly      Retain      Save      SWA
Items    Type        Storage   Pool Device    Activity    Object      While     Message
              Type        Pool Device    SMTWTFS    Detail      Active     Queue

10 *EXIT
20 LIBA      *SYSBAS    *DFTACT
30 LIBB      *SYSBAS    *DFTACT   *ERR   *NO
40 LIBC      *SYSBAS    *DFTACT   *ERR   *NO
50 *EXIT      *DFTACT

Bottom

F3=Exit      F5=Refresh  F10=Change item  F11=Display exits
F12=Cancel   F14=Display client omit status  F24=More keys

```

4. At the Create Backup Control Group Entries display, type the name of the first library you want to save in the *Backup Items* field. Press Enter. Because BRMS numbers the save sequence for you, you need to enter the library or object name in the order in which you want them to process. However, you can change the order by specifying a sequence number in between the two entries. BRMS notifies you if the library does not exist. If you do not know the name of the library you want to save, use F19 to get to the Select Libraries display. Press Enter at the Select Libraries display to get a list of libraries.

Note: You can still create a control group with a library that does not exist. Pressing Enter a second time overrides the *Library does not exist* warning message. Press F3 to exit and take option 1 to save at the Create Backup Control Group Entries display.

5. Following are brief summaries of the other key parameters on this display.
 - The *Weekly Activities* field has seven single character fields available to designate the seven days of the week. You can use the default value for this field, which is *DFTACT, or you can set your own weekly activity schedule. *DFTACT specifies a full save (FFFFFFF) on all seven days. You can also tailor a daily mix of full (F) and incremental saves (I) to better suit your business needs, for example: IIFFIIF.
 - In the *Retain Object Detail* field, you can specify whether you want BRMS to save historical information about the control group item at the object level. In this example, we did not specify anything in the *Retain Object Detail* field, which subsequently resorts to the default *ERR (for error). Other values for this field are *YES, *NO, *OBJ, and *MBR. If you want to specify *OBJ at this prompt, you should also specify *OBJ at the *Automatically backup media information* parameter. BRMS establishes the default value for the *Automatically backup media information* field on the backup policy. You can change it at either the backup policy display or at the Change Backup Control Group Attributes display.
 - The value in the *Save-while-active* field specifies whether users can change an object during save processing. More specifically, the *Save-while-active* (SWA) feature allows users to change an object after BRMS reaches a certain checkpoint during the save process. SWA performs the save on a transaction boundary. By using the SWA feature, you can decrease your save window. You can find more detailed information on how to use the Save-while-active feature later in this chapter.
6. Review and change the remaining parameters as needed.
7. When you have finished, press Enter to save your new control group.

| **Note:** BRMS will group or bundle objects into a single save command if the objects are of the same type
| and have similar auxiliary storage pool, object detail and save-while-active attributes. The bundling
| continues until the save command maximum limits are reached or the list of backup items is
| exhausted. In the preceding example, BRMS would issue one SAVLIB command to save all three
| libraries.

Editing a Control Group

Use the Edit Backup Control Group Entries option to revise any existing control group, including BRMS-configured control groups, and those you create. To get there from the Work with Backup Control Groups display, take the following steps:

1. Place a 2 (Edit entries) next to the control group you want to edit.
2. Press Enter.

```

                                Edit Backup Control Group Entries                                RCHAS400
Group . . . . . : SAMPLE
Default activity . . . . . *BKUPCY
Text . . . . . Create sample backup control group

Type information, press Enter.

Seq   Backup   List   Auxiliary   Weekly   Retain   Save   SWA
      Items   Type  Storage    Activity Object   While  Message
      :      :      :      :      :      :      :      :
10  *EXIT
20  LIBA      *SYSBAS *DFTACT *ERR *NO
30  LIBB      *SYSBAS *DFTACT *ERR *NO
40  LIBC      *SYSBAS *DFTACT *ERR *NO
50  *EXIT

                                Bottom
F3=Exit   F5=Refresh   F10=Change item   F11=Display exits
F12=Cancel F14=Display client omit status   F24=More keys

```

At this display, you can delete a backup item from an existing control group by spacing over the sequence number of the entry that you want to delete. You can also change the weekly activity schedule, or any of the other values on this display as needed.

Changing Control Group Attributes

You can use the Change Backup Control Group Attributes option to tailor each control group to suit the specific needs of each job. To get there from the Work with Backup Control Groups display, take the following steps:

1. Place an 8 (Change attributes) next to the control group you want to change.
2. Press Enter.

```

                                Change Backup Control Group Attributes
Group . . . . . : SAMPLE

Type information, press Enter.

Media policy for:
  Full backups . . . . . *BKUPCY      Name, F4 for list
  Incremental backups . . . . . *BKUPCY Name, F4 for list
  Backup devices . . . . . *BKUPCY     Name, F4 for list

Parallel device resources:
  Minimum resources . . . . . *NONE     1-32, *NONE, *AVAIL
  Maximum resources . . . . .          1-32, *AVAIL, *MIN
  Sign off interactive users . . . . . *BKUPCY *YES, *NO, *BKUPCY
  Sign off limit . . . . . *BKUPCY     0-999 minutes, *BKUPCY
  Default weekly activity . . . . . *BKUPCY SMTWTFS (F/I), *BKUPCY
  Incremental type . . . . . *BKUPCY   *CUML, *INCR, *BKUPCY
  Force full backup days . . . . . *BKUPCY 0-365, *NOMAX, *BKUPCY
                                More...

F3=Exit   F4=Prompt   F12=Cancel

```

All of the attributes on the Change Backup Control Group Attributes display default to values that BRMS establishes in the backup policy (*BKUPCY) except one. You can override any of the shared default values by changing the shared parameters on this display.

The *Parallel device resources* parameter on the Change Backup Control Group Attributes display is the only parameter that is not shared by the backup policy. Parallel device resource capability allows you to save data to multiple devices from the same job at the same time, thereby shortening your save window. To use the parallel device resource feature you need to have multiple tape devices attached to your system. You can find more detailed information on parallel processing in the Additional Options for Processing Control Groups section of this chapter.

Special Considerations When Saving Selected Libraries in a Control Group

The QUSRSYS library contains three important files that are used during a save operation:

- QATADEV contains a list of MLBs.
- QATAMID contains a list of volume identifiers that are used during a save operation.
- QATACGY contains a list of tape library device categories.

| When planning to save the QUSRSYS library, you need to understand the end of volume implications
| when saving in a nonrestricted state. For example, if the system is unable to save all of QUSRSYS on the
| current tape, BRMS requests that you mount another volume. When locked, i5/OS cannot ready and
| update the required QUSRSYS files. The save fails with a message identifier of CPA37A0.

To minimize the chance of spanning QUSRSYS across multiple volumes and to create a separate control group to save QUSRSYS. Save this control group before saving the *ALLUSR control groups. If you do not omit this library through the backup policy, BRMS saves it twice. These recommendations assume that you are performing the save in a restricted state and that the QUSRSYS library can fit on the mounted volume.

When performing saves using *ALLUSR, or *ALLPROD, ensure that you understand which Q libraries are saved and which are not saved. Refer to table *Special Values* table for the Save Library (SAVLIB) Command in the *Saving Libraries* section of the *Backup and Recovery* book to determine what libraries are considered user libraries. User libraries QGPL, QUSRSYS and QUSRBRM can never be saved to TSM servers.

Omitting Libraries from Backup: It is also important to understand the recovery implications for saving user data. For example, suppose that you plan to perform an *ALLUSR save in your control group. Before you perform this *ALLUSR save, you need to save libraries QGPL and QUSRSYS ahead of other libraries. When you set up your control group, be sure to define the libraries to omit in your backup policy. You may also want to omit libraries from control groups by using the *IBM, *SAVSYS, *ALLDLO, and ASPnn special values.

Take the following steps to get to the Work with Items to Omit from Backup display:

1. Type WRKPCYBRM *BKU at a command line and press Enter.
2. Take option 2 (Work with Items to Omit from Backup) from the Backup Policy menu.

```

Work with Items to Omit from Backup                                RCHAS400

Type options, press Enter.
 1=Add  4=Remove

Opt Type      Backup item

*ALLUSR  TEMP*
*IBM     Q1ABRMSF*

Bottom

F3=Exit  F5=Refresh  F12=Cancel

```

3. Review or change the following parameters on this display.
 - In the *Opt* field, type a 1 (Add) to add the item to a list of items to omit.
 - In the *Type* field, specify the type of backup you want to perform, which in this case will be *ALLUSR.
 - In the *Backup item* field, type the name of the item you want to omit, which in this case is a TEMP library.
4. Press Enter to process the request.

In this example, BRMS omits all libraries that begin with TEMP from the *ALLUSR backups. To save data to save files, BRMS places the files in a library that is called Q1ABRMSFxx. The xx indicates the ASP number into which the library is placed. Typically, you would use the Save Save File with BRM (SAVSAVFBRM) command to save the save files, which can be quite large and time-consuming to save.

In addition to the special values *IBM, *ALLUSR, *SAVSYS, *ALLDLO, and *ASPnn, you can also specify *ALL in the *Type* field. *ALL instructs BRMS not to save a library when you specify a special or generic value in a control group or a SAVLIBBRM command. Other things to consider when using the Work with Items to Omit option are:

- You cannot include the special values *ALLPROD and *ALLTEST in a list of items to omit. If you omit a library from an *ALLUSR group, then BRMS automatically omits it from an *ALLPROD group if it uses a PROD type. Similarly, BRMS also omits the library from an *ALLTEST group if it uses a TEST type.
- The *SYSTEM backup control group ignores any *Items to omit from backup* that may be specified in the backup policy. If you need to omit libraries from your backup you need to use an alternate backup control group.
- You can specify the *SECDATA, *USRASPAUT, and *CFG special values as items to omit with the *SAVSYS special value in the *Type* field.
- You can specify the *USRASPAUT special value as an item to omit with the *SECDATA special value in the *Type* field.
- If your backup device is an TSM server, you should omit the QUSRADSM library from an *ALLUSR backup.
- You can omit up to a maximum of 300 items.
- Be aware that if you omit a library from a control group, BRMS will omit that library from all control groups with the same name until you reenter it into the control group. For example, if you omit a library from the *ALLUSR control group, BRMS will omit that library from all saves of that control

group, even from the *BKUGRP control group, until you reenter it. To avoid this situation, you may want to save the library in a different control group.

Note: If you perform a restore operation exclusive of BRMS (for example, with the i5/OS RSTLIB command), BRMS cannot recover the QGPL and QUSRSYS libraries. In this case, you must restore them separately.

Using the Subsystems to Process Display

You can specify subsystem information by control group from the Work with Backup Control Groups display. Use the Subsystems to Process display to add or remove subsystems that you want to start or end automatically before and after control group processing. In the following example, BRMS ends the subsystems at the start of one control group (SAMPLE) and restarts them after saving another control group (SAMPLE2).

To get to the Subsystems to process display, take the following steps:

1. On the Work with Backup Control Groups display, place a 9 (Subsystems to process) next to the control group you want to work with. Press Enter.

```

Subsystems to Process                                RCHAS400
Use . . . . . : *BKU
Control group . . . . : SAMPLE2

Type choices, press Enter.

Seq   Subsystem   Library   End      Delay   Restart
      Subsystem   Library   Option   Delay   Restart
10    QBATCH       *LIBL    *NONE    *NOLIMIT *YES
20    QCMN        *LIBL    *CNTRLD  300      *YES

Bottom

F3=Exit  F5=Refresh  F12=Cancel

```

2. Type a number that reflects the order in which you want the subsystem job processed in the *Seq* field.
3. Type the name of the subsystem you want to process in the *Subsystem* field.
4. Type the name of the library that contains the subsystem in the *Library* field.
5. Specify whether you want BRMS to automatically restart the subsystem after control group processing in the *Restart* field.

Note: If you do not specify an IPL, BRMS automatically restarts the subsystems after save processing completes. If you do specify an IPL, BRMS restarts subsystems after the IPL. You can specify an IPL on the Change Backup Control Group Attributes display.

6. Review and change the other parameters as needed.
7. Press Enter to save and return to the Work with Backup Control Groups display (if you press F3, you exit without saving).

To delete an entry from the Subsystems to Process display, position the cursor on the item you want to delete. Then space through the sequence number, and press Enter.

Before processing your subsystem requests, you need to ensure that the media policy for the control groups you want to process is appropriate for this request.

Notes:

1. You can run multiple control groups serially (one after another) when using the subsystems to process feature. The first control group ends the subsystems, and the last one restarts them.
2. If you specify *ALL as the subsystem to process, and also request a restart (*YES), BRMS restarts the controlling subsystem that is defined by system value QCTLSBS. To verify the system value, go to the Work with System Values (WRKSYSVAL) display.

Using the Job Queues to Process Display

Use the Job Queues to Process display to add or remove job queue items from a list of job queues. These are job queues you want to hold or release before and after control group processing. Take the following steps to get to the Job Queues to Process display:

1. Select F23 (More options) from the Work with Backup Control Groups display.
2. Place an option 10 (Job queues to process) next to the control group you want to work with and press Enter.

In this example, the *SAMPLE control group specifies one job queue to process.

```
Job Queues to Process                                RCHAS400
Use . . . . . : *BKU
Control group . . . . : SAMPLE

Type choices, press Enter.

Seq   Job queue   Library   Hold   Release
 10   QBATCH     *LIBL    *YES   *YES

                                           Bottom

F3=Exit   F5=Refresh   F12=Cancel
```

3. In the *Seq* field list the order in which you want BRMS to hold or release the job queues.
4. Type the job queue name in the *Job queue* field.
5. At the *Library* field, you can specify the library in which the job queue resides or use the default library, *LIBL.
6. Specify whether you want BRMS to hold or release the job. In this case, BRMS holds the QBATCH job queue during backups. BRMS automatically releases the job queue after the backup or IPL (if you specify IPL in the control group) completes.
7. Press Enter to save and return to the Work with Backup Control Groups display.

To delete a job queue, position the cursor on that entry, space through the sequence number, and press Enter. Press Enter again to return to the Work with Backup Control Groups display.

Control Group Processing Order

BRMS performs actions before processing the control group entries, process control group entries sequentially, and process additional actions after the control group entries are processed. In general, BRMS will process each control group entry sequential and make every effort to process all entries. However, if a failure occurs on an save entry the control group may end without further processing depending on the type of error.

If the error is an unrecoverable device or media error, the control group will be ended.

If the error encountered is less severe, such as an object is locked and the object cannot be saved, the backup will continue but the process will end with exception *BRM1820 — Control group &1 type &2 ended abnormally..*

The following outlines the general order in which backup control group actions are performed.

Processing Before the Save

BRMS performs the following operations in the indicated order when you run a backup control group.

1. Process the first control group entry if it is *EXIT.
2. Sign off interactive users if requested.
3. Hold job queues if requested.
4. End Lotus servers if requested.
5. End TCP/IP servers if requested.
6. Wait for end server wait time to expire if Lotus or TCP/IP servers ended.
7. End subsystems if requested.
8. Vary off Windows Integrated servers if requested.
9. Vary off hosted logical partitions if requested.
10. Process each control group backup item in sequence.

Processing After the Save (without IPL and *SAVSYS)

BRMS performs the following operations in the indicated order after processing the backup control group when the entries do not include a *SAVSYS and when an IPL has not been requested.

1. Save the media information if requested.
2. Release job queues if requested.
3. Start subsystems if requested.
4. Process the last control group entry if it is *EXIT.
5. Vary on Windows Integrated servers if requested and subsystems are started.
6. Vary on hosted logical partitions if requested and subsystems are started.
7. Start Lotus servers if requested and subsystems are started.
8. Start TCP/IP servers if requested and subsystems are started.
9. Run BRMS maintenance if requested.

Processing After the Save (with IPL)

BRMS performs the following operations in the indicated order after processing the backup control group items when an IPL has not been requested.

1. Save the media information if requested.
2. Process the last control group entry if it is *EXIT.
3. Run BRMS maintenance if requested.
4. Perform the IPL if requested and subsystems to check not started.

Processing After the Save (with *SAVSYS and no IPL)

BRMS performs the following operations in the indicated order after processing the backup control group items when the entries included a *SAVSYS and an IPL has not been requested.

1. Save the media information if requested.
2. Start the controlling subsystem. (if no inhibited by Subsystems to Process)
3. Release job queues if requested.
4. Process the last control group entry if it is *EXIT.

5. Vary on Windows Integrated servers if requested and subsystems are started.
6. Vary on hosted logical partitions if requested and subsystems are started.
7. Start Lotus servers if requested and subsystems are started.
8. Start TCP/IP servers if requested and subsystems are started.
9. Run BRMS maintenance if requested.

Creating Backup Lists in a Control Group

Backup lists consist of items that are grouped together for processing in a backup control group. The primary benefit of using a backup list is the flexibility it provides when restoring selected items during a recovery. There are four types of backup lists you can create:

- Folder lists (*FLR)
- Object lists (*OBJ)
- Spooled file lists (*SPL)
- Integrated File System objects (*LNK)

You can create backup lists and add them to a control group by using the Edit Control Group Entries display.

Creating a Folder List

A folder list is used to identify specific folders you want to include in a backup.

To create a folder list for an existing control group, take the following steps from the Work with Backup Control Groups display:

1. Place a 2 (Edit entries) next to the control group to which you want to add the list, and press Enter.
2. At the Edit Control Group Entries display, type a sequence number at the top of the *Opt* column and press F23. This takes you to the Work with Backup Lists display.

```

Work with Lists                                RCHAS400
Position to . . . . . Starting characters
Type options, press Enter.
  1=Add  2=Change  3=Copy  4=Remove  5=Display  6=Print

Opt List Name  Use  Type  Text
  1  SAMPFLR   *BKU *FLR
     QALLSPLF  *BKU *SPL All printed output
     QIBMLINK  *BKU *LNK All IBM directories
     QLNKOMET  *BKU *LNK Associated user omit list for *LINK.
     QLNKOMTLTS *BKU *LNK Associated user list for *LNKOMTLTS.
     QLNKOMTONL *BKU *LNK Associated user list for *LNKOMTONL.
     QLTSOMTONL *BKU *LNK Associated user list for *LTSOMTONL.

Bottom

F3=Exit  F5=Refresh  F12=Cancel

```

3. Type a 1 (Add) in the *Opt* column.
4. Type the name of the folder you want to create in the *List name* field.
5. Type *BKU in the *Use* column.
6. Name the list type, *FLR, in the *Type* column.
7. Then press Enter. This takes you to the Add Folder List display.

Add Folder List		RCHAS400
Use	: *BKU	
List name	SAMPFLR	
Text	Create folder list.	
Type choices, press Enter.		Se1
Seq Folder		*INC/
		*EXC
10 SAMPFLR		*INC
		Bottom
F3=Exit	F5=Refresh	F12=Cancel

8. Following are brief summaries of the key parameters on this display:
 - In the *Seq* field, place a number that reflects the order in which you want to save the item.
 - In the *Folder* field, specify the name of the folder or subfolder that you want to save in the list. You can specify actual or generic folder names.
 - In the **INC/*EXC* field, specify **INC* to include the folder or subfolder during backup processing, or **EXC* to exclude the folder or subfolder. .
9. After changing the parameters as needed, **press Enter twice** to save and to return to the Work with Backup Lists display. You can now see the name of your folder list in list of backup items.
10. Press Enter again to return to the Edit Backup Control Group Entries display. Type the name of the list in the *Backup items* column, the list type in the *List type* column, and press Enter. BRMS saves the new list in the control group you specified, in this case, the SAMPLE control group.

Note: When doing incremental saves of folder lists, if there are multiple folders listed, BRMS will always do a full save of the folder list. This is a restriction on the SAVDLO command which BRMS uses.

1. Press Enter to return to the Work with Control Groups display.

Creating an Object List

An object list is used to identify specific objects in libraries you want to include in a backup. It can be used in conjunction with the *Save spooled file data* backup control group attribute to save spooled files for any output queues that might be included in the list entries. In general, entries in the object list are processed sequentially, one entry at a time.

To create an object list for an existing control group, take the following steps from the Work with Backup Control Groups display:

1. Place a 2 (Edit entries) next to the control group to which you want to add the list.
2. At the Edit Control Group Entries display, type a sequence number at the top of the *Opt* column and press F23. This takes you to the Work with Backup lists display.
3. At the Work with Backup Lists display, type in the name of the list you want to create, in this case, an object list called TESTOBJ.
4. Type a 1 (Add) in the *Opt* column.
5. Type the name of the object you want to create in the *List name* field.
6. Type *BKU in the *Use* column.

7. Name the list type, *OBJ, in the *Type* column.
8. Then press Enter. This takes you to the Add Object List display.

Add Object List RCHAS400

Use : *BKU
List name TESTOBJ
Text Create object list

Type choices, press Enter.

Seq	Library	Object	Type	Member
10	LIB3	*ALL	*ALL	*ALL
20	LIB4	P*	*ALL	*ALL

Bottom

F3=Exit F4=Prompt F5=Refresh F12=Cancel

9. Following are brief summaries of the key parameters on this display:
 - In the *Seq* field, place a number which reflects the order in which you want to save the item.
 - In the *Library* field, specify the name of the library that contains the objects you want to save in the list.
 - In the *Object* field type the name of the object you want to save in the list. The possible values include:
 - The actual name of the object.
 - A generic name.
 - *ALL.
 - The *Type* field specifies the type of object you want to save in the list. You can use the name of any permitted system object type. Or you can use *ALL to indicate that all objects apply to the object type specified in the list you want to save.
 - The *Member* field identifies the name of the database member you want to save in the object list. You cannot designate a member name if you use *ALL or generic as the object name. Otherwise, you can name specific member names, generic ones, or indicate *ALL to include all available members.
10. After changing the parameters as needed, **press Enter twice** to save and to return to the Work with Backup Lists display. You can now see the name of your list in the list of backup items.
11. Press Enter again to return to the Edit Backup Control Group Entries display. Type the name of the list in the *Backup items* field, the name of the list type in the *List type* column and press Enter. BRMS saves the new list in the control group you specified, in this case, the SAMPLE control group.
12. Press Enter to return to the Work with Control Groups display.

You can also save the objects in the list using the **Save Object List using BRM (SAVOBJLBRM)** command.

Using an Object List as a Library List

Backup object lists can be used as library lists. Library lists can be useful to assure the libraries in the list are being saved using the same save while active attributes.

You can create a library list by first creating a backup object list as described in “Creating an Object List” on page 131. For each library or generic library name you enter for *Library* , also specify *ALL for *Object*, *Type* and *Member*.

When the list is run as part of a backup, BRMS will start with the first entry in the list and group subsequent entries which specify *ALL for *Object*, *Type* and *Member* into a single save command until it reaches an entry where *ALL is not specified for *Object*, *Type* and *Member*, or until the number of libraries exceeds limit of the *Library (LIB)* parameter of the Save Library (SAVLIB) command. Normal backup object list processing occurs for entries where *ALL is not specified for *Object*, *Type* and *Member*. Library list processing resumes with the next subsequent entry where *ALL is specified for *Object*, *Type* and *Member*.

Note: Normal backup object list processing occurs when saving to save files or TSM servers since these media types only support saving one library at a time.

Creating a Spooled File List

With a single spooled file list, you can add multiple output queues that you want to save by selecting multiple sequence numbers. When you add the output queues, you can select the type of spooled file names, job names, or user names that you want to save.

To create a spooled file list for an existing control group, take the following steps from the Work with Backup Control Groups display:

1. Place a 2 (Edit entries) next to the control group to which you want to add the list.
2. At the Edit Control Group Entries display, type a sequence number at the top of the *Opt* column and press F23. This takes you to the Work with Backup lists display.
3. At the Work with Backup Lists display, type in the name of the list you want to create, in this case, a spooled file list called SAVESPOOL.
4. Type a 1 (Add) in the *Opt* column.
5. Type the name of the spooled file you want to create in the *List name* field.
6. Type *BKU in the *Use* column.
7. Name the list type, *SPL, in the *Type* column.
8. Then press Enter. This takes you to the Add Spooled File List display.

Add Spooled File List RCHAS400

Use : *BKU
 List name SAVESPOOL
 Text Sample to save spooled files

Type choices, press Enter.

Seq	Library	Outq	File	Job	User	User data	*INC/ *EXC
10	QGPL	QPRINT*	*ALL	*ALL	*ALL	*ALL	*INC
20	QUSRSYS	*ALL	*ALL	*ALL	*ALL	*ALL	*INC
30	QUSRSYS	QEZDEBUG	*ALL	*ALL	*ALL	*ALL	*EXC
40	*ALL	BILLINGS	*ALL	*ALL	*ALL	*ALL	*INC

Bottom

F3=Exit F5=Refresh F11=Expiration view F12=Cancel

9. Review and change the additional parameters on this display as needed.

10. Press **Enter twice** to save and to return to the Work with Backup Lists display. You can now see the name of your list in the list of backup items.
11. Press **Enter** again to return to the Edit Backup Control Group Entries display. Type the name of the list in the *Backup items* field, the name of the list type in the *List type* column and press **Enter**. BRMS saves the new list in the control group you specified, in this case, the SAMPLE control group.
12. Press **Enter** to return to the Work with Control Groups display.

| When saving to target release V5R4M0 or later, BRMS saves and restores spooled files using the native operating system support. The list items will be saved starting from the lowest sequence to the highest sequence. List items will be grouped for the save by the following rules to minimize the number of save operations performed:

- | • Multiple *INC items will be grouped.
- | • Any *EXC items will be grouped with any preceding *INC items.
- | • Any *INC items following preceding *EXC items will start a new save.
- | • Any *EXC items not preceded by *INC items will be ignored.

| In spooled file list SAVESPOOL above, two saves will be performed. The first save will include sequences 10, 20 and 30. Sequence 40 will be the last save.

BRMS does not support the incremental saves of spooled files. If you specify an incremental save of spooled files, BRMS saves all of the spooled files.

| BRMS does not clear output queues after the save. You must manage the expiration and deletion of spooled files from your output queues. See “Expiring Saved Spooled Files” on page 135 for more information.

IBM recommends that you obtain a hardcopy of your output queue immediately after the save has completed for audit purposes. To print the output queue, use the Work with Output Queue (WRKOUTQ) command with the OUTPUT(*PRINT) option specified.

| **Note:** When saving to target release prior to V5R4M0, BRMS saves the spooled files as a single folder, with multiple documents within that folder. During the restore, it reads the tape label for the folder and restores all of the documents. If your spooled file save spans multiple volumes, BRMS prompts you to read the label information before restoring the documents on subsequent tapes. To avoid possible confusion, you can save your spooled files on a separate tape by using the *LOAD exit in the control group or you can split your spooled file saves so that you use only one tape at a time. Either approach can make the recovery easier for you.

| **Note:** When saving spooled files to target releases prior to V5R4M0, BRMS first retrieves the names of the spooled files using a system API which stores the spooled file names in a user space. User spaces are restricted to a limited size. If you have a lot of spooled files, the returned names may exceed the size of the user space. In this case, the backup of the spooled files will fail with a CPF34C4 exception. You can correct the problem by breaking up the current spooled file list entries into more granular entries.

BRMS provides a spooled file list named QALLSPLF which you can use to save all spooled files on your system. If you want to save spooled files using this list, simply added the list to your current backup control group.

```

                                Display Spooled File List                                RCHAS400
Use . . . . . : *BKU
List name . . . . . : QALLSPLF
Text . . . . . : All printed output

```

```

Seq Library   Outq      File      Job      User      User data  *INC/
10 *ALL       *ALL      *ALL      *ALL     *ALL      *ALL      *EXC
                                                *INC

```

Press Enter to continue.

Bottom

F3=Exit F11=Expiration view F12=Cancel

Expiring Saved Spooled Files

Beginning with V5R4M0, BRMS provides a new Expiration view on the Add/Change/Display Spooled File List displays. You can use this view to tell BRMS to set an expiration date on the saved spooled files. Each entry in the list can have a unique expiration value. The default value for existing lists or new entries added to a list is *SPLF.

Note: The *Expiration* attribute sets the expiration date of the saved spooled files on the system and has no affect on the retention of the saved spooled file information in BRMS history.

Additional authorities are required to change the expiration of saved spooled files. You can change the expiration date of saved spooled files if any of the following conditions are met, otherwise, the expiration will remain unchanged.

- You own the spooled files.
- You have spool control (*SPLCTL) special authority.
- You have job control (*JOBCTL) special authority, and the output queue on which the spooled file resides is specified as OPRCTL(*YES).
- You own the output queue on which the spooled file resides, and the output queue is specified as AUTCHK(*OWNER).
- You have read, add, and delete authorities to the output queue on which the spooled file resides, and the output queue is specified as AUTCHK(*DTAAUT).

```

                                Add Spooled File List                                RCHAS400
Use . . . . . : *BKU
List name . . . . . : SAVESPOOL
Text . . . . . : Sample to save spooled files

Type choices, press Enter.

  Seq Expiration

0010 *SPLF

                                                                 Bottom

F3=Exit   F5=Refresh   F11=Selection view   F12=Cancel

```

The following are the possible values for *Expiration*:

- *EXPIRED**
The expiration date for saved spooled files will be set so the files are expired.
- *NONE**
The expiration date for saved spooled files will be set to not expire.
- *SPLF** The expiration date for saved spooled files will be left unchanged.
- 1-366** The expiration date for saved spooled files will be set to a date that is the specified number of days past the date of the save. The valid range is 1-366 days.

You can remove any expired spooled files from the system after the save by running the Delete Expired Spooled files (DLTEXPSPLF) command as a user exit in the control group. See “Processing User Exits in a Control Group” on page 139 for more information.

Note: If you specify a value in the range of 1-366 days for the expiration of spooled files, you must delete the expired spooled files before the next save; otherwise, the spooled file expiration will continue to be set to a future date with each subsequent save and consequently never expire.

Creating a Link List

A link list is used to identify specific directories and files in the Integrated File System (IFS) folders you want to include in a backup.

To create a list link for an existing control group, take the following steps from the Work with Backup Control Groups display:

1. Place a 2 (Edit entries) next to the control group to which you want to add the list.
2. At the Edit Control Group Entries display, type a sequence number at the top of the *Opt* column and press F23. This takes you to the Work with Backup lists display.
3. At the Work with Backup Lists display, type in the name of the list you want to create, in this case, a link list called LNKLIST.
4. Type a 1 (Add) in the *Opt* column.
5. Type the name of the link list you want to create in the *List name* field.
6. Type *BKU in the *Use* column.
7. Name the list type, *LNK, in the *Type* column.

8. Then press Enter. This takes you to the Add Link List display.

```

                                Add Link List                                RCHAS400

Use . . . . . : *BKU

Type choices, press Enter.

List name . . . . . LNKLIST
Text . . . . . Test link list

F3=Exit   F12=Cancel
  
```

9. At the Add Link List display, type in a short sentence describing the items in the list on the *Text* line and press Enter. This returns you to the Work with Backup Lists display, where the name of the new link list appears.

```

                                Work with Lists                                RCHAS400

Position to . . . . . Starting characters

Type options, press Enter.
  1=Add  2=Change  3=Copy  4=Remove  5=Display  6=Print

Opt List Name  Use  Type  Text
-----
LNKLIST  *BKU *LNK  Test link list
QALLSPLF *BKU *SPL  All printed output
QIBMLINK *BKU *LNK  All IBM directories
QLNKOMT  *BKU *LNK  Associated user omit list for *LINK.
QLNKOMTLTS *BKU *LNK  Associated user list for *LNKOMTLTS.
QLNKOMTONL *BKU *LNK  Associated user list for *LNKOMTONL.
QLTSOMTONL *BKU *LNK  Associated user list for *LTSOMTONL.

Bottom

F3=Exit   F5=Refresh   F12=Cancel
List LNKLIST of type *LNK is added.
  
```

10. To list the Integrated File System objects you want to save, place a 2 (Change item) next to the new list and press Enter. This takes you to the Change Link List display.

```

Change Link List (CHGLNKLRM)

Type choices, press Enter.

List . . . . . > LNKLIST      Character value
Usage type . . . . . > *BKU      *BKU, *ARC
Objects:
  Name . . . . . '/'*'

  Include or omit . . . . . *INCLUDE  *INCLUDE, *OMIT
    + for more values
Directory subtree . . . . . *ALL      *ALL, *DIR, *NONE, *OBJ
Text . . . . . > 'Test link list'

Bottom
F3=Exit  F4=Prompt  F5=Refresh  F12=Cancel  F13=How to use this display
F24=More keys

```

11. Type the name of the object you want to save in the *Name* field. If you want to add more objects, type a + on the short line next to the *+ for more values field*, and press Enter. This takes you to the Specify More Values for Parameter OBJ display. Type the names of the additional objects you want to add to the list.
12. In the *Include or omit* field, specify whether you want to include an item in the list or omit it from the save. You can also use a */** symbol in this field to instruct BRMS to save all available Integrated File System objects.

```

Specify More Values for Parameter OBJ

Type choices, press Enter.

Objects:
  Name . . . . . > '/'*'

  Include or omit . . . . . *INCLUDE  *INCLUDE, *OMIT

  Name . . . . . '/QSYS.LIB'

  Include or omit . . . . . *OMIT      *INCLUDE, *OMIT

  Name . . . . . '/QDLS.LIB'

  Include or omit . . . . . *INCLUDE  *INCLUDE, *OMIT

  Name . . . . .

  Include or omit . . . . . *INCLUDE  *INCLUDE, *OMIT

More...
F3=Exit  F4=Prompt  F5=Refresh  F12=Cancel  F13=How to use this display
F24=More keys

```

13. After completing your additions to the link list, press Enter to return to the Change Link List display. This display shows the changes you made to the link list.
14. Press Enter to return to the Work with Backup Lists display, and then again to return to the Edit Backup Control Entries display. BRMS saves the new link list in the control group you specified earlier, in this case, the SAMPLE control group.

Processing User Exits in a Control Group

A **user exit** (the *EXIT special value) is a user-defined CL command that permits automatic processing of predefined user routines. Users place an *EXIT special value inside a control group in the sequence order in which they want BRMS to process the request. Use the *EXIT value to send messages or to call applications.

To create a user exit command, take the following steps:

1. At the Create/Edit Backup Control Group Entries display, treat the *EXIT special value as a backup item and place it in the order in which you want BRMS to process it. Then press Enter. In this example, we use the *EXIT special value to call an application in between the processing of two libraries.

Note: It is recommended that you never run a BRMS or native save command from a *EXIT entry in a backup control group.

```

                                Create Backup Control Group Entries                                RCHAS400
Group . . . . . : ETEST2
Default activity . . . . . : *BKUPCY
Text . . . . . : *NONE

Type information, press Enter.

Seq      Backup      List  Auxiliary  Weekly  Retain  Save   SWA
Items    Type   Storage Activity Object  While  Message
                               SMTWTFS Detail Active Queue

 10 *EXIT
 20 LIBA                *SYSBAS  *DFTACT  *ERR  *NO
 30 *EXIT
 40 LIBB                *SYSBAS  *DFTACT  *ERR  *NO
 50 *EXIT                *DFTACT

                                Bottom

F3=Exit   F5=Refresh   F10=Change item   F11=Display exits
F12=Cancel F14=Display client omit status   F24=More keys
  
```

2. Place your cursor on the *EXIT special value and press F10. This takes you to the User Exit Maintenance display.

```

                                User Exit Maintenance                                RCHAS400

Type command, press Enter.

Sequence number . . . . . : 20
Where used . . . . . : *EXIT
Weekly activity . . . . . : *DFTACT SMTWTFS
Command . . . . . : CALL QGPL/STARTAPP

                                ...

F3=Exit   F4=Prompt   F12=Cancel
  
```

3. Type the command you want BRMS to process in the *Command* field. To call the STARTAPP application, type the CALL QGPL/STARTAPP command in the *Command* field.
4. Press Enter to return to the Create Backup Control Group Entries display. Then press F3 to exit the display and save the control group. BRMS calls STARTAPP application after the first backup item completes processing and before the second control group begins processing.

If the first entry in a control group is *EXIT, BRMS processes it before performing any **preprocessing** activities (such as ending subsystems or holding job queues). If the last entry in the control group is *EXIT, BRMS processes this exit after performing any **postprocessing** activities (such as starting subsystems and releasing job queues).

Backing Up Your Control Group

Use the Start Backup using BRM (STRBKUBRM) command to backup your control group.

1. Type STRBKUBRM at a command line and press Enter. This takes you to the Start Backup using BRM display.
2. At the STRBKUBRM display, place your cursor in the *Control group* field and type in the name of the control group you want to process. If you do not know the name of the control group, press F4 to prompt a list of control groups. Type in the name of the control group you want to save.
3. Review and change the other parameters on this command as needed, then press Enter to see the remaining parameters:
 - The text in the *Job description* field describes the job you want to submit. You can base the job description on the user profile or you can create your own description.
 - The value in the *Job queue name* field specifies the location of the job in the queue.
4. Press Enter to begin processing the backup.

After your backup completes, you should check the job log to make sure that it completed successfully. You can use the Backup Analysis display to review your save history. You can access the backup analysis displays from the Backup Planning menu. After you have designed your backup strategy, you can review the contents of your control groups at the Display Backup Plan display. You can also access this display from the Backup Planning menu.

How to Resume a Backup

If you canceled the backup of a control group, you can restart it using the STRBKUBRM command. Type the name of the control group (for example, *MYLIBS) that contains the user profiles in the *Control group* field. Use the Display BRM Log Information (DSPLOGBRM) command to see which items were saved. If BRMS saved items 10, 20, and 30, but not items 40, 50, and 60, you can restart *MYLIBS by typing 40 in the *Starting sequence* field. Then BRMS can save the rest of the items in the control group.

Additional Options for Processing Control Groups

Using the Save-While-Active Feature

- | The save-while-active (SWA) feature allows users to resume activity after save processing reaches a certain point. i5/OS refers to this point as the synchronization checkpoint. By using the SWA feature, you can reduce application downtime and increase user access to selected data or applications.

To use the SWA feature with a save that does not use journaling or commitment control, you need to prevent user access until BRMS reaches the synchronization point. Once the system reaches the checkpoint, the system releases the exclusive locks on the library, and users can resume normal activity. Meanwhile, BRMS continues to save the data.

If you have large libraries with single member physical files, it may take less time to reach the checkpoint than it takes to save the data to tape. For example, suppose you have a library that contains single member physical files and that it takes an hour to save. During regular save processing, the system locks

the library, which prevents user access to any file in that library until the save completes. By using the save-while-active feature, users can access library files after BRMS reaches the checkpoint. Suppose, in this example, that BRMS reaches the checkpoint in 20 minutes. In this example, the SWA feature increased your application availability by nearly 40 minutes. IBM cannot determine the exact time at which BRMS reaches the checkpoint. The exact time depends on the size of the library or application to which you are applying SWA. Under most circumstances, however, the time it takes to reach the checkpoint is notably shorter than the time it takes to save the entire library or application.

This section provides several examples of how you can apply SWA to your save strategy. However, this section does not cover every topic associated with SWA. Therefore, you should review Backing up your system topic in the iSeries Information Center for more information before implementing SWA.

Activating Save-while-active in BRMS

To activate the SWA feature, take the following steps:

1. Go to Edit Backup Control Group Entries display. In this example, we use the SWA feature while processing the LIBB and LINKLIST backup items.

```

                                Edit Backup Control Group Entries                                RCHAS400
Group . . . . . : SAMPLE
Default activity . . . . . *BKUPCY
Text . . . . . Create sample backup control group

Type information, press Enter.

Seq      Backup      List      Auxiliary      Weekly      Retain      Save      SWA
Items    Type      Storage   Pool Device   Activity   Object      While     Message
                                SMTWTF5   Detail      Active     Queue

10 *EXIT
20 LIBA      *SYSBAS   *DFTACT
30 LIBB      *SYSBAS   *DFTACT   *ERR      *NO
40 LNKLIST   *LNK      *ALLAVL   *DFTACT   *YES     *YES     *LIB
50 *EXIT

                                                                Bottom

F3=Exit   F5=Refresh   F10=Change item   F11=Display exits
F12=Cancel F14=Display client omit status   F24=More keys

```

2. To activate SWA, type *YES in the *Save-while-active* field. Additional values for this field are:

***LIB** This value indicates that library objects can be saved while in use by another job. Because all of the library objects reach checkpoint together, BRMS saves them in a consistent state in relationship to each other. If you specify multiple libraries in the control group, BRMS performs the checkpoint processing individually for the objects within each specified library. For example, to save LIBA and LIBB, the system performs two separate SAVLIB commands and establishes two checkpoints.

Note: Physical files with members have the same save active date and time stamp. Libraries with thousands of objects may be too large for this option.

***SYNCLIB**

This value also specifies that objects in a library can be saved while in use by another job. However, in this case, all of the objects *and* all of the libraries reach a checkpoint together. BRMS saves them in a consistent state in relationship to one another. Before you use the *SYNCLIB value to save data to a save file, keep the following in mind:

- i5/OS restricts you to save single libraries to save files. BRMS adopts the same restriction.
- The control group must use the *LIB level synchronization instead of *SYNCLIB.
- If you specify a message queue in the *SWA Message Queue* field in the Edit Control Group Entries display, BRMS sends the synchronization message for every library.

- BRMS completes the save processing without any warning or error messages. BRMS does not warn you if it adopts *LIB level of synchronization.

Note: Different items (including libraries, backup lists, and special values) have different effects on save-while-active processing. See “Using the Monitor Save While Active for BRM (MONSWABRM) Command” for more information.

***SYSDFN**

This value also indicates that library objects can be saved while in use by another job. In this case, however, library objects can reach checkpoints at different times and may not exist in a consistent state in relationship to one another. You should not specify the *SYSDFN value if you plan to use the Monitor Save While Active for BRM (MONSWABRM) command. Nor should you use it to perform operations when a checkpoint has been reached. In these situations, the *SYSDFN values makes it more difficult to release the library.

If you specify a value other than *NO in the Save-while-active field, an entry appears next to it in the *SWA Message Queue* field. The default value for this field is *LIB, which instructs BRMS to use the message queue that matches the name of the library you want to save. You can also specify the name of the message queue that contains the checkpoint messages.

3. Press Enter to save. This returns you to the Work with Backup Control Groups display. BRMS uses the SWA feature as instructed during the next save of that control group.

Using the Monitor Save While Active for BRM (MONSWABRM) Command

The Monitor Save While Active for BRM command (MONSWABRM) monitors BRMS for system messages CPI3710 and CPI3712, which indicate that the synchronization checkpoint has been reached. You can process the MONSWABRM command through an *EXIT operation in your backup control group or by entering the MONSWABRM command from a command line. Use the MONSWABRM command inside an *EXIT for better control over the monitoring function. *EXIT entries that contain the MONSWABRM command must precede the control group entry for the item you want to monitor or the command fails.

To use the MONSWABRM command in an *EXIT, take the following steps:

1. Follow the steps listed in the Processing User Exits in a Control Group section of this chapter to create an *EXIT that contains the MONSWABRM command.
2. In the following example, we use the MONSWABRM command to monitor the SWA status of LIBB and LNKLIST. If the control group entry types differ, which in this case they do, then a MONSWABRM *EXIT must proceed each entry. Therefore, you need to create two separate exits containing the MONSWABRM command. Place each *EXIT before each control group entry you want the MONSWABRM command to monitor for synchronization.

```

Edit Backup Control Group Entries                                RCHAS400

Group . . . . . : SAMPLE
Default activity . . . . . *BKUPCY
Text . . . . . Create sample backup control group

Type information, press Enter.

Seq      Backup      List      Auxiliary   Weekly   Retain   Save   SWA
Items    Type    Storage  Pool Device Activity Object While Message
                               SMTWTF5 Detail Active Queue

 10 *EXIT
 20 LIBA                *SYSBAS   *DFTACT   *ERR   *NO
 30 *EXIT
 40 LIBB                *SYSBAS   *DFTACT   *YES   *YES   *LIB
 50 *EXIT
 60 LNKLIST  *LNK *ALLAVL  *DFTACT   *NO    *YES   *LIB
 70 *EXIT

                                                    Bottom

F3=Exit   F5=Refresh   F10=Change item   F11=Display exits
F12=Cancel F14=Display client omit status   F24=More keys

```

3. Press Enter to return to the Work with Backup Control Groups display.
4. Press F3 to exit and save the control group.

If the control group entries are of the same type, you can use one *EXIT special value to monitor messages for all entries. If all of the entries are the same type (all libraries, for example, or lists of the same type), place the exit before the first entry.

To synchronize libraries by set rather than by entry, list the libraries in sequence without interruption by special operations such as *EXIT. In this example, LIBA monitors synchronization point messages for the first set, while LIBC monitors them for the second set.

```

Edit Backup Control Group Entries                                RCHAS400

Group . . . . . : SAMPLE
Default activity . . . . . *BKUPCY
Text . . . . . Create sample backup control group

Type information, press Enter.

Seq      Backup      List      Auxiliary   Weekly   Retain   Save   SWA
Items    Type    Storage  Pool Device Activity Object While Message
                               SMTWTF5 Detail Active Queue

 10 *EXIT
 20 LIBA                *SYSBAS   *DFTACT   *NO    *SYNCLIB *LIB
 30 LIBB                *SYSBAS   *DFTACT   *NO    *SYNCLIB *LIB
 40 *EXIT
 50 LIBC                *SYSBAS   *DFTACT   *YES   *SYNCLIB *LIB
 60 LIBD                *SYSBAS   *DFTACT   *YES   *SYNCLIB *LIB
 70 *EXIT
 80 LNKLIST  *LNK *ALLAVL  *DFTACT   *NO    *YES    *LIB

                                                    More...

F3=Exit   F5=Refresh   F10=Change item   F11=Display exits
F12=Cancel F14=Display client omit status   F24=More keys

```

You must ensure that the values for *Retain object detail*, *Weekly activity*, and the *Save-while-active* fields are the same for each library in each set. However, you can specify different weekly activity and object detail information for each set. If you use generic names for the libraries such as A*, B*, C*, and specify *SYNCLIB, BRMS groups all of the libraries together. Then BRMS performs a single save operation and

you receive a single synchronization message. A single save command supports up to 300 libraries in a list. This is an i5/OS restriction. If you have more than 300 libraries, BRMS issues another save command to process the remaining libraries.

In this example, the SWA message queue value in the control group defaults to *LIB. The SWA message queue name specified in the control group entry **must** match the message queue name in the LIB parameter of the MONSWABRM command. The MONSWABRM automatically creates and deletes the message queue in library QUSRBRM. You cannot place it in a different queue. If you use a name other than the first library name, the MONSWABRM command cannot monitor for the SWA synchronization message. Instead, it continues to run for a default of one hour before it ends. In the meantime, your control group finishes processing without any benefit from the SWA message queue function.

Note: By default, the system issues the synchronization message after 3600 seconds (one hour). Therefore, if your libraries require over an hour to reach synchronization, you need to increase the SWA wait time in the MONSWABRM command.

To use the Monitor Save While Active (MONSWABRM) display to set up a SWA monitoring job, take the following steps:

1. Type MONSWABRM at a command line and press Enter.

```

Monitor Save While Active (MONSWABRM)

Type choices, press Enter.

Saved library . . . . . LIB3      Name, *MSGQ
Command to run . . . . . STRSBSBRM

Job description . . . . . *USRPRF   Name, *USRPRF
Library . . . . .                Name, *LIBL, *CURLIB
Job queue . . . . . *JOBDB        Name, *JOBDB
Library . . . . .                Name, *LIBL, *CURLIB
Time limit in seconds . . . . . 3600  1-999999, *NOMAX

Bottom
F3=Exit  F4=Prompt  F5=Refresh  F12=Cancel  F13=How to use this display
F24=More keys

```

2. At the Monitor Save While Active display, change the following fields as required:
 - Use the *Saved library* parameter to specify the library or message queue that you want to review for synchronization during the SWA process.
 - Use the *Command to run* parameter to issue a command after the synchronization message arrives. In this example, we ran the Start Subsystem using BRM command (STRSBSBRM) after the libraries reached synchronization. BRMS can quiesce an application only prior to synchronization.
3. Review and change the other parameters as needed.
4. Press F3 to save and exit.

Note: By default, BRMS submits control group jobs and MONSWABRM jobs to the QBATCH subsystem. You must ensure that you have enough activity levels to perform all of your control group saves **and** all of the MONSWABRM commands. You can use another subsystem by specifying the job queue name or the job description name in the STRBKUBRM or the MONSWABRM commands.

Working with the Save-While-Active Message Queue

Instead of using the MONSWABRM command to monitor SWA activity, you can instruct the SWA message queue to send a message when the libraries reach synchronization. It is recommended that you use this approach rather than letting BRMS default to *LIB. This allows better control by monitoring a specific message queue rather than one created by the name of the first library that BRMS saves. For example, if you want BRMS to save the first entry in the control group on certain days, the message queue would vary from day-to-day.

```

Edit Backup Control Group Entries                                RCHAS400

Group . . . . . : SAMPLE
Default activity . . . . . *BKUPCY
Text . . . . . Create sample backup control group

Type information, press Enter.

   Seq   Backup   List   Auxiliary   Weekly   Retain   Save   SWA
        Items   Type  Storage   Activity Object   While  Message
                                   Pool Device SMTWTFS Detail Active Queue

   10 *EXIT
   20 LIBA          *SYSBAS *DFTACT *NO    *SYNCLIB OPER01
   30 LIBB          *SYSBAS *DFTACT *NO    *SYNCLIB *LIB
   40 LIBC          *SYSBAS *DFTACT *NO    *SYNCLIB *LIB
   50 LIBD          *SYSBAS *DFTACT *NO    *SYNCLIB *LIB
   60 LNKLIST *LNK *ALLAVL *DFTACT *NO    *YES    *LIB
   70 *EXIT

                                                Bottom

F3=Exit   F5=Refresh   F10=Change item   F11=Display exits
F12=Cancel F14=Display client omit status   F24=More keys

```

In this example, the system uses the OPER01 message queue to log the following messages:

- 0 of 4 libraries processed. Started LIBA at 02/03/05 10:20:06.
- 1 of 4 libraries processed. Started LIBB at 02/03/05 10:20:07.
- 2 of 4 libraries processed. Started LIBC at 02/03/05 10:20:078.
- 3 of 4 libraries processed. Started LIBD at 02/03/05 10:20:09.

BRMS uses the first message queue (at LIBA) to monitor for the synchronization. Even if you specify different message queues for each of the other libraries, the SWA synchronization message still goes to message queue OPER01.

If you require synchronization messages to go to different message queues, you must separate the control group entries for libraries with values such as *EXIT or *LOAD. BRMS also separates the library groups if it detects a change of value in the *Retain object detail*, *Weekly activity*, and *Save-while-active* fields.

For more detailed information on the SWA feature, see *Backup and Recovery*.

Console Monitoring

- | Use the console monitor to perform an unattended save, process a SAVSYS save, or perform a function in a restricted state. Use the *SAVSYS value with the STRBKUBRM command when you want BRMS to save the operating system and related libraries. You can also use the console monitor to monitor selected activities. You can temporarily suspend the monitoring function to enter i5/OS commands and then return the console to a monitored state.

Console monitoring allows users to submit the SAVSYS job to the job scheduler instead of starting the job in an interactive session. Previously, the SAVSYS, SAVSYSBRM, or STRBKUBRM with *SAVSYS command required interactive processing. When you use *CONSOLE as the value for the *Submit to batch* (SBMJOB) parameter on the STRBKUBRM command, you are submitting a job to the BRMS console monitor, an

interactive job in the controlling subsystem. When you schedule a job to run on the console monitor, you do not have to be nearby when the system save process starts. You **must** start the console monitor job from the system console. Once you start the console monitor, the console waits for a BRMS command to process. You can suspend the console to process commands. However, if you do so, you must return the console to monitoring status so BRMS can monitor for the STRBKUBRM commands issued to the console monitor.

Starting the Console Monitor

To start the console monitor, take the following steps from your system console:

1. To get to the BRMS Console Monitor display, select option 20 (Start console monitor) from the BRMS main menu at the system console. You will get message *BRM1947 — Not in correct environment to start console monitor.* if you are not at the system console when you start this function.

```

BRMS Console Monitor

Press F12 to cancel the monitor operation.
Press F9 to access command line. Control must return to this display
for BRMS activity to be monitored.
```

2. This starts the console monitor. You need to take no further action at the console monitor at this time.
3. On the job scheduler, submit a job that performs the STRBKUBRM command. Following is an example of an STRBKUBRM job you can submit to the job scheduler.

```

Start Backup using BRM (STRBKUBRM)

Type choices, press Enter.

Control group . . . . . *SYSGRP      *BKUGRP, *SYSGRP, SAVSYS...
Schedule time . . . . . *IMMED       hhmm, *IMMED
Submit to batch . . . . . *CONSOLE    *CONSOLE, *YES, *NO
Starting sequence:
Number . . . . . *FIRST             1-9999, *FIRST
Library . . . . . *FIRST            Name, *FIRST
Append to media . . . . . *CTLGRPATR  *CTLGRPATR, *BKUPCY, *YES...
Job description . . . . . *USRPRF     Name, *USRPRF
Library . . . . .                  Name, *LIBL, *CURLIB
Job queue . . . . . *JOBID           Name, *JOBID
Library . . . . .                  Name, *LIBL, *CURLIB

Submit a System Save to Batch Using Console Monitor
```

4. Type the name of the control group you want the console monitor to process in the *Control group* field.
5. Ensure that the *Schedule time* is *IMMED.
6. Type *CONSOLE in the *Submit to batch* field.
7. Review and change the other parameters as needed.
8. Press Enter to process the request.

Interrupting the BRMS Console Monitor

To interrupt the BRMS Console Monitor from the system console, take the following steps:

1. Press F9 from the BRMS Console Monitor display.
2. At the prompt, type the correct pass phrase and press Enter.
3. A pop up window appears. Type the i5/OS commands you want the system to process and press Enter. The BRMS Console Monitor is now interrupted.

If you interrupt the BRMS Console Monitor, BRMS queues any requests submitted through the console monitor. BRMS does not process the requests until you complete the command and return the system console to console monitoring status.

Monitoring the Console Monitor

BRMS logs the following messages to help you oversee the BRMS Console Monitor usage:

- BRM1948 — 'BRMS Console monitoring is now started' when you start the console monitoring.
- BRM1950 — 'BRMS Console monitoring is inactive' when you use the command line entry (F9).
- BRM1954 — 'BRMS Console monitoring is now ending' when you quit the console monitoring (F3).

Canceling the Console Monitor

To cancel the console monitor, take the following steps from your system console:

1. Take F3 (Exit) or F12 (Cancel) from the BRMS Console Monitor display. This takes you to the BRMS Console Monitor Exit display.
2. Type the correct pass phase at the BRMS Console Monitor Exit display and press Enter to end BRMS Console Monitoring.

Submitting a Backup to the Controlling Subsystem

The BRMS console monitor is an interactive process that emulates batch processing. If you IPL your system quite often, you will have to sign on to the system console and start the console monitor to be prepared for the next backup scheduled for the console monitor. This can be a cumbersome task if you IPL nightly and your backups are otherwise fully automated.

| Beginning with V5R3M0, BRMS offers a new alternative which allows for true batch processing of
| restricted state back ups in the controlling subsystem and does not require you to sign on to the system
| console or start the console monitor. To select this option, you specify the special value *CTLSBS on the
| *Submit to batch* (SBMJOB) parameter on the STRBKUBRM command. When you use this special value,
| BRMS creates the QBRM/Q1ACTLSBS job queue if it does not exist, adds the job queue as a job queue
| entry in the subsystem description of the controlling subsystem, then submits the backup job directly to
| this job queue.

The controlling subsystem cannot run more than one job when in restricted state. If you are running a backup in either the batch job or in the interactive job, any attempt to end all subsystems from one job will end the other job. This is important because it implies that if you are running a backup in batch and that backup requires all subsystems to be ended, the interactive session on the system console will be ended. Therefore, any backups submitted to batch in the controlling subsystem must be **fully** automated. You will not be able to respond to inquiry messages such as tape mount requests when running in batch mode. Always perform a test back up using *CONSOLE for the SBJOB parameter of the STRBKUBRM command to assure automation before making the transition to the *CTLSBS special value.

System reference code **A900 3C70** is displayed on the system operator panel while running in batch restricted state. Normal system operations will resume and the interactive session on the system console is restarted when subsystems are started following the backup. Should a problem occur and the subsystem cannot be started by BRMS, there are two methods by which you can terminate the batch backup job and restart the interactive session on the system console.

1. Select option 21 from the operator panel to start DST then select Option 14 — End batch restricted state
2. Change the time limit for the *Restricted state time limit* prompt on the BRMS System Policy to a value which is comparable to your backup window. If the backup hangs and subsystems are not restarted in this time limit. The backup job will be ended and the controlling subsystem restarted.

Note: Because of the implications of using batch restricted state, this function is not automatically enabled. You must set the *Allow backups in batch* prompt on the BRMS System Policy to *YES to enable this function.

Note: Due to the nature of batch restricted state processing, which ends the system console session, BRMS ignores Signoff Exception processing when running in this mode.

Note: If you submit a backup job to the controlling subsystem which ends all subsystems, the controlling subsystem will be automatically restarted by i5/OS when the backup job ends.

Using Missed Object Policies

You can have BRMS record library objects and members that could not be saved when running backup control groups. BRMS records the unsaved objects in a missed object policy which is nothing more than another backup control group containing one or more backup object lists containing the missed objects. You can then use the missed object policy to review which objects did not get saved, or to run the missed object policy in an attempt to re-save the missed objects.

Note: Missed object policies do not support folder and documents, directories and files, or spooled files.

You specify whether you want BRMS to record unsaved library objects for all backup control groups by specifying a missed object policy name on the *Missed object policy* prompt of the Backup policy, or for individual backup control groups by specifying a missed object policy name on the *Missed object policy* prompt on specific backup control groups.

```

Change Backup Control Group Attributes

Group . . . . . : *BKUGRP

Type information, press Enter.

IPL after backup . . . . . *BKUPCY      *YES, *NO, *BKUPCY
How to end . . . . . *BKUPCY          *CNTRLD, *IMMED, *BKUPCY
Delay time, if *CNTRLD . . . . . *BKUPCY      Seconds, *NOLIMIT
Restart after power down . . . . . *BKUPCY    *YES, *NO, *BKUPCY
IPL source . . . . . *BKUPCY          *PANEL, A, B, *BKUPCY
IPL restart type . . . . . *IPLA        *FULL, *IPLA, *SYS ...

Save active wait time:
Object locks . . . . . 120             0-99999, *NOMAX
Pending record changes . . . . . 120    0-99999, *NOCMTBDY, *NOMAX
Other pending changes . . . . . 120    0-99999, *NOMAX
Backup item exit program . . . . . *NONE   Name, *NONE, *BKUPCY
Exit program library . . . . .          Name
Exit program format . . . . .          BKUI0100
Missed object policy . . . . . NOTSAVED  Name, *NONE, *BKUPCY
Clear missed objects . . . . . *YES      *NO, *YES

```

If the missed object policy does not exist when the backup control group runs, it will be created using the same attributes as the current backup control group. If the missed policy exists, you can also specify whether it is cleared of any existing missed objects using the *Clear missed objects* prompt.

Missed objects are recorded in backup object lists, and these lists are added to the missed object policy as backup items. The format of the backup object list name is Znnnnnnaaa where nnnnnn is the current job number and aaa is unique sequence identifier. These backup object lists are created as needed depending on the auxiliary storage pool, object detail, and save-while active attributes of the current backup items. These lists are deleted when a missed object policy is cleared. If you do not clear a missed object policy and use it for a subsequent backup, new lists are created and added as backup items to the missed object policy.

Performing Serial, Concurrent, and Parallel Backups

If you use a single tape device, all of your saves are **serial saves**. In a serial save, BRMS processes your saves sequentially, one at a time, one after another. If, however, you have multiple tape devices, BRMS can perform concurrent and parallel saves. Concurrent and parallel saves can considerably reduce your backup window and streamline your backup operations. Following are brief descriptions of each.

Concurrent Backups

If running concurrent backups, it is strongly suggested not to save media information with either backup. It is recommended you run the Save Media Information (SAVMEDIBRM) command after the concurrent backup control groups have completed.

In a concurrent save operation, you send multiple save jobs to multiple tapes devices to process at the same time (concurrently). For example, using a concurrent backup strategy, you might send one library or group of libraries to one tape device, and another set of libraries to a different tape device. Concurrent backup support also allows multiple SAVDLO operations from the same auxiliary storage pool (ASP). Anything that you can save concurrently, you can restore concurrently, thereby reducing your down time after a system failure by recovering multiple libraries or objects at the same time.

You set up the concurrent operation by specifying different device names inside the individual control groups or save commands that you want BRMS to process concurrently. You must try to evenly balance the contents of each job so that each tape device completes at about the same time. This results in more efficient use of your tape resources. If you want to use *INCR or *CUMML saves, keep in mind that processing time for each varies by content size.

Parallel Backups

| BRMS implements parallel support by utilizing two methods provided by the i5/OS. The first method,
| **parallel save/restore** support, spreads each object across multiple resources. The second method,
| **multiple-library parallel** support, spreads libraries across multiple resources, such that each library is
| backed up to a single resource. Using these methods, BRMS will attempt to optimize performance and
| balance resources. Items saved with the second method will have a sequential restore behavior.

Notes:

1. Full backups of *ALLUSR , *IBM, generic library names and other special values will be saved using only multiple-library parallel support.
2. See Chapter 8, "Performing Selected Recoveries" for information on how to perform recoveries using parallel support.

Parallel Support Restrictions

Before you set up a backup strategy using parallel support, review the following restrictions:

- i5/OS does not support parallel saves of system data, security data, configuration data, or folder and documents.
- BRMS does not support parallel backup of the QUSRBRM library. See "Sample Backup Scenarios: Working with Multiple Control Groups and Shared Devices" on page 151 for information on how to save media information when using parallel support.
- BRMS does not restricted library QUSRSYS from a parallel backup. However, i5/OS limitations related to spanned volumes when saving this library could result in the library not being recoverable if saved using parallel. Refer to "Special Considerations When Saving Selected Libraries in a Control Group" on page 125 for additional information.

When to Use Parallel and Concurrent Saves

| Due to i5/OS restrictions, you can gain the greatest benefit by designing a strategy that combines
| concurrent and parallel backup support. You should, if possible, use concurrent backups to reduce

backup windows for objects which can only be saved using serial mode; such as, system data, security data, configuration data, or folders and documents. Use parallel support when you want to reduce your backup window for large libraries and objects, large directories and files, large spooled files, or large numbers of these objects. You can find more information on performing concurrent and parallel backups in “Sample Backup Scenarios: Working with Multiple Control Groups and Shared Devices” on page 151.

How to Set Up a Parallel Backup

To use parallel support to process an existing control group, take the following steps:

1. At the Work with Backup Control Groups display, type option 8 (Change attributes) in front of the control group you want to work with, and press Enter. This takes you to the Change Backup Control Group Attributes display.

```

Change Backup Control Group Attributes

Group . . . . . : SAMPLE

Type information, press Enter.

Media policy for:
  Full backups . . . . . *BKUPCY      Name, F4 for list
  Incremental backups . . . . . *BKUPCY  Name, F4 for list
  Backup devices . . . . . *BKUPCY      Name, F4 for list

Parallel device resources:
  Minimum resources . . . . . 2          1-32, *NONE, *AVAIL
  Maximum resources . . . . . 4          1-32, *AVAIL, *MIN
  Sign off interactive users . . . . . *BKUPCY *YES, *NO, *BKUPCY
  Sign off limit . . . . . *BKUPCY      0-999 minutes, *BKUPCY
  Default weekly activity . . . . . *BKUPCY SMTWTF5(F/I), *BKUPCY
  Incremental type . . . . . *BKUPCY     *CUMUL, *INCR, *BKUPCY
  Force full backup days . . . . . *BKUPCY 0-365, *NOMAX, *BKUPCY

F3=Exit  F4=Prompt  F12=Cancel

```

2. At the *Parallel device resources* parameter, indicate the minimum and maximum number of device resources you want to allocate to the processing of this control group. In this example, we instructed BRMS to save the contents of the SAMPLE control group to a minimum of 2 devices and a maximum of 4 devices.
3. Press Enter to save and return to the Work with Backup Control Groups display.

You can find a more complex example involving the use of parallel and concurrent saves in “Sample Backup Scenarios: Working with Multiple Control Groups and Shared Devices” on page 151.

Note: You can also specify a parallel save when using the following commands:

- Save Library using BRM (SAVLIBBRM)
- Save Object using BRM (SAVOBJBRM)
- Save Object List using BRM (SAVOBJLBRM)

Use a job scheduler to assist you in scheduling parallel saves. You can find more information on job scheduling in Chapter 10, “Scheduling Backup and Recovery Jobs,” on page 201.

Sample Backup Scenarios: Working with Multiple Control Groups and Shared Devices

As you grow more familiar and comfortable with BRMS, you may decide to create additional control groups or to split larger control groups into smaller ones. This section provides information on the uses and benefits of a multiple control group operation in several different environments. Each scenario assumes a daily backup schedule.

Use multiple control groups to save applications or subsets of applications, and user libraries or subsets of user libraries. A backup strategy that uses multiple control groups can shorten your save window, and make the restore of selected data easier. In Scenario 1, you learn the benefits of using your own control groups rather than BRMS-configured ones such as *ALLUSR. In Scenario 2, you learn how to shorten your save window still further by processing multiple control groups through concurrent and parallel backups. In Scenario 3, you learn how process a network backup by using shared devices. Scenario 4 shows how you might optimize serial and parallel operations to save your entire system within a single backup control group.

Scenario 1: Using Multiple Control Groups in a Serial Backup

In this example, suppose you have only one tape device available, TAP01, available for backup operations. You can use a tape library, such as a 3570, 358x or 3590 device. For the purposes of this example, however, you are using the device as a stand-alone. You must decide how to save two packaged business applications (one for payroll, the other for inventory), a few company-designed programs, and several user libraries.

In this situation, you could use either of the following strategies to back up your data:

- You could perform an *ALLUSR save on a weekly (*FULL) and daily (*INCR) basis
- You could create multiple control groups containing applications, libraries, or related subsets, again with weekly (*FULL) and daily (*INCR) backups.

Utilizing an *ALLUSR strategy saves all user libraries, but it does not allow specialized recoveries. An *ALLUSR save may also require that you rebuild access paths when restoring the libraries.

Splitting your application and user data into multiple control groups provides the following benefits:

- Makes recovery easier by allowing you to separate and prioritize critical applications for a speedier, more business-efficient recovery. For example, if you use certain applications only on specific days (such as payroll), you might not need to restore that application immediately after a failure on a non-payroll day. Conversely, if the system fails on a heavy payroll day, you want to get the payroll application back on the system as soon as possible. Similarly, some user-specific libraries may be less critical than others or than the day-to-day business applications. If you use the simple *ALLUSR approach, then selective or prioritized recovery is very difficult.

By splitting user libraries and business applications into separate control groups, you can prioritize the order in which BRMS restores your libraries and applications. In addition, a single control group has only one media policy, and one schedule for all the libraries and applications it contains. Multiple control groups, on the other hand, allow you to run different control groups on different days. And, because they use more than one media policy, multiple control groups allow for more flexible retention periods.

- Avoids access path rebuilds by grouping based-on physical files with their dependent logical files. In some instances, the system holds logical views of data in different libraries than their based-on physical files (this is called a Database Network). The system organizes library files alphabetically, by save time, which can cause a problem if the logical files appear earlier in the list than their counterpart physical files. This problem makes recovery much more difficult. If you use an *ALLUSR save, the system saves access paths for the logical files along with the physical files. However, you might need to perform lengthy access path rebuilds after a restore operation because the system cannot restore the based-on physical file.

To avoid lengthy rebuilds, design your backups so that you do not include database networks in an *ALLUSR or a generic* backup. Separate control groups can save the based-on physical files before their dependent logical files. This way, BRMS can restore the objects in the correct sequence, thereby avoiding lengthy access path rebuilds. However, you need to make sure that you save the physical and logical files with the same underlying system save command. If you save the logical and physical files with different save commands, BRMS cannot save the access paths , even if you specify ACCPTH(*YES).

You can also consider a compromise between these two strategies, especially if you have smaller systems with fewer libraries. Under these circumstances, you can use a combination of *ALLUSR and your own control groups. Use one or more control groups for specific libraries, and another control group containing the *ALLUSR libraries. If you choose this strategy, you need to omit the libraries in your own control groups. This way, you can restore the items in your control groups selectively, on an as-needed basis. You can save less critical libraries on a less frequent basis.

If you save multiple control groups to single device, BRMS processes them serially, one after another. Figure 8 on page 153 illustrates how you can design a number of control groups to run in sequence.

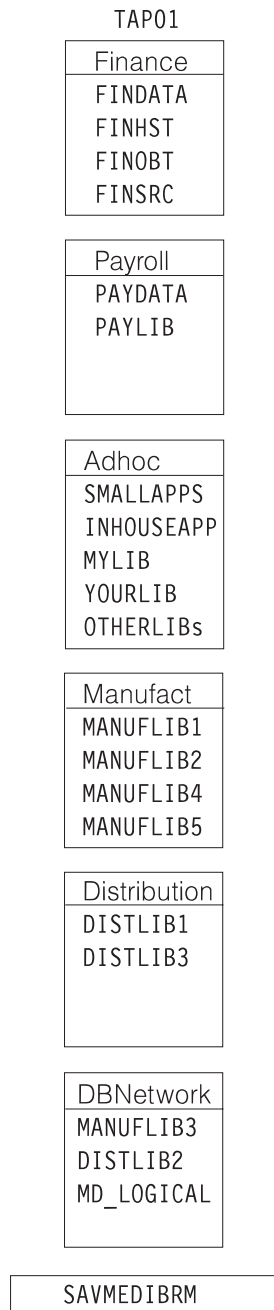

RV4N405-0

Figure 8. Multiple Control Groups in a Serial Save

The manufacturing application (MANUFACT) consists of libraries MANUFLIB1 through MANUFLIB5, and DISTLIB1 through DISTLIB3. These libraries now exist in three separate control groups. You can find the logical files in library MD_LOGICAL. The logical files were built over physical files in libraries MANUFLIB3 and DISTLIB2. To avoid rebuilding the access paths for these logical files after restore, MANUFLIB3 and DISTLIB2 were omitted from the MANUFACT and DISTRIBUTION control groups. Instead, they were included with library MD_LOGICAL in a separate control group called DBNETWORK. The ADHOC control group contains a few user libraries and a few of the smaller applications. The FINANCE and PAYROLL control groups contain the more critical payroll and finance data.

When you process multiple control groups serially, keep the following considerations in mind:

- **Saving Media Information:** BRMS usually saves media information at the end of each control group. However, if you are running the control groups serially, BRMS saves the media information files at the end of each control group. While this is not a problem, it can extend the runtime for the control groups. In addition, because BRMS saves the same media information in the last file in each control group, you really need only the last group of media information files. You may find it beneficial, then, not to save the media information at the end of each control group. Instead, you can save it separately by using the SAVMEDIBRM command. Whichever method you choose, you must save this information on a regular basis as BRMS uses it to restore your data. In Figure 9 BRMS processes the SAVMEDIBRM command in a separate job.
- **Appending to Media:** By default, BRMS uses an expired tape for each control group. Therefore, during serial operations, BRMS unloads the volume from the previous group and uses a new volume for each subsequent control group. However, you can add the later control groups to the end of the previous tape. To do that, specify ENDOPT(*LEAVE) and APPEND(*NO) on the Change Backup Control Group Attributes display for the first control group. Then specify ENDOPT(*LEAVE) and APPEND(*YES) for the second and subsequent control groups.

Scenario 2: Using Multiple Control Groups in Parallel and Concurrent Backups

In this example, assume that you are using the multiple control group backup strategy discussed in Scenario 1. In this case, however, you want use two tape devices for your backup operation, TAP01 and TAP02.

Figure 9 shows how you can organize the control groups to run concurrently to two tape devices.

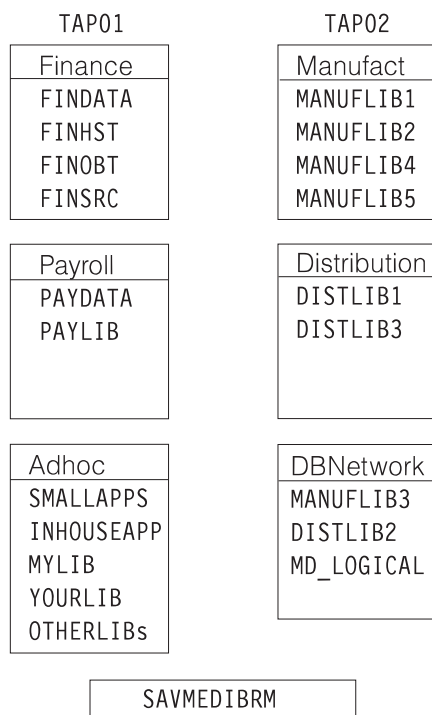

RV4N406-0

Figure 9. Multiple control groups in a concurrent save

Suppose that the FINHST library in the FINANCE group contains 50 small objects and 4 very large objects. At this point, you want to save the FINANCE group to TAP01. Your main concern at this point is to balance the backup window for both tape drives. For example, the size of the objects in the FINHST library might force TAP01 to process longer than TAP02. Thus, the control group processing would not

end concurrently. To remedy this, you can split the FINHST library into two control groups of approximately 25 small objects and 2 large objects each, as shown in Figure 10. By doing so, you can better balance the save window for both devices.

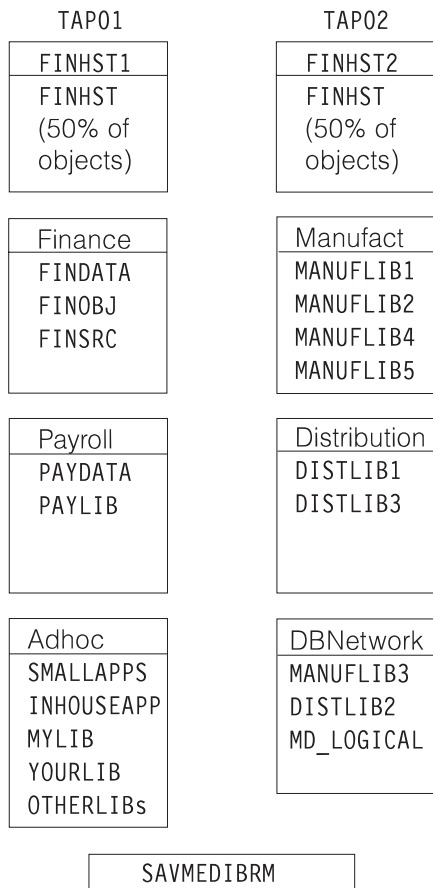

RV4N407-0

Figure 10. Differently weighted control groups in a concurrent save

Next suppose that the two FINHST libraries grow to contain 35 small and 3 large objects each. In this case, you need to change your backup strategy, and continually work to keep these jobs ending at the same time. Alternatively, however, you could return all of the FINHST objects to one control group and process it using a parallel backup. Figure 12 shows how BRMS can do this. The parallel backup support feature makes this job easier because it balances the work load for you, and sends the job to process at all available devices. By using the parallel support feature, you do not need to revise your backup strategy if libraries and objects grow, or if you add another tape drive to your system.

In this case, then, you can run the smaller jobs concurrently to TAP01 and TAP02, while using parallel support to process FINSHT across both devices. Figure 11 on page 156 shows how BRMS can perform concurrently and parallel saves simultaneously.

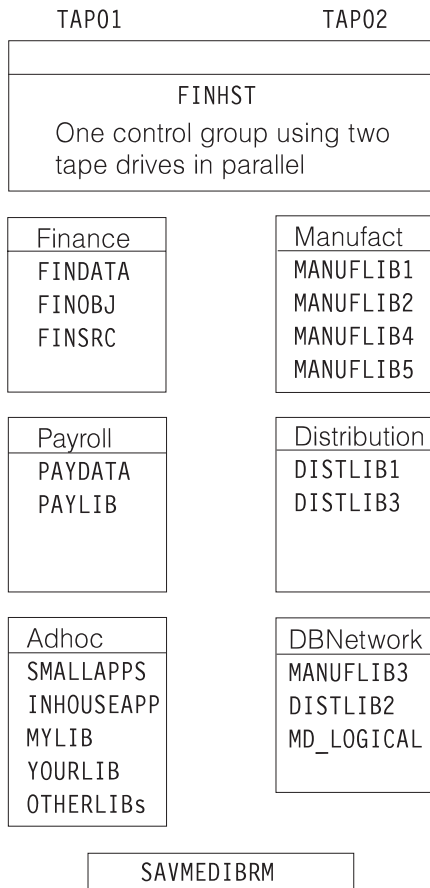

RV4N408-2

Figure 11. Multiple control groups in concurrent and parallel saves

In this case, the FINHST control group runs first to both TAP01 and TAP02 groups in parallel. Then the FINANCE, PAYROLL, and ADHOC control groups run to TAP01, while the MANUFACT, DISTRIBUTION, and DBNETWORK control groups run concurrently to TAP02.

In addition, if you share tape devices with other systems, sometimes you may have more or less resources available, depending on availability. Parallel backup support makes the best use of available devices when you want to save a large library.

To process multiple control groups by using concurrent and parallel support, keep the following in mind:

- **Control job running time:** In an environment such as described here, the timing of some jobs might be dependent on the outcome of others. For example, to save the media information, you need to run SAVMEDIBRM at the end of control group processing. You do not want this command to run concurrent with the control groups. To achieve this, consider using an advanced job scheduler such as the IBM Advanced Job Scheduler for i5/OS which allows you to define job dependencies.

Scenario 3: Performing a Backup Across a Network with Shared Devices

This example shows you how to use tape automation to perform backups across a network. IBM manufactures several automated tape libraries (ATLs) that you can attach to your iSeries to provide tape automation. An automated tape library is both a resource to iSeries and a device. A tape library contains one or more tape drives. ATL models available from IBM are:

- Magstar[®] MP Tape Library (IBM 3570 B and C models)
- 9427 8mm Tape Library

- 3575 Tape Library Dataserver
- 3494 Tape Library Dataserver
- 3582/3583 Ultrium Scalable Tape Library
- 3584 UltraScalable Tape Library

You can share any of the IBM tape libraries across multiple iSeries servers. However, due to drive connectivity limitations, you cannot attach individual drives to more than two systems at once unless these are attached using a Fiber Channel. ATLS with more than two drives (3575 and 3494) can attach to more than two systems. When i5/OS uses a tape library, it allocates a drive resource to the job. If a library has more than one drive, i5/OS selects one or more depending on the type of save operation (serial, concurrent or parallel). If a resource is unavailable, i5/OS queues the request until one becomes available or until the device timeout period elapses. You can find more information on how to use devices in Chapter 8 of this manual. You can find more information on ATLS in Automated Tape Library Planning and Management book (SC41-5309).

In this example, assume the use of a 3494 ATL with two 3590 devices shared between two iSeries servers. You have connected the two tape drives to two iSeries servers, SYSTEMA and SYSTEMB. These two systems exist in a BRMS network, and share a common tape pool. When working with tape libraries, you should have the stand-alone device description varied off, and the library device varied on. The tape drives appear as resources under the library device. With a 3494, although each tape subsystem appears to the i5/OS as a library device, all library devices can access the resources for that library type. The i5/OS command Work with Media Library Status (WRKMLBSTS) display illustrates this.

```

Work with Media Library Status
System: RCHAS400
Type options, press Enter.
  1=Vary on   2=Vary off   3=Reset resource   4=Allocate resource
  5=Allocate unprotected   6=Deallocate resource   8=Work with description

  Opt   Device/Resource   Status           Allocation       Job name
  TAPMLB01   VARIED ON
  TAP01     OPERATIONAL       UNPROTECTED
  TAP02     OPERATIONAL       UNPROTECTED
  TAPMLB02   VARIED OFF

Bottom

Parameters or command
===>
F3=Exit   F4=Prompt   F5=Refresh   F9=Retrieve   F12=Cancel   F17=Position to
F23=More options

```

This example shows the preferred way to run, which is with one library device varied on and the other varied off. This way, both SYSTEMA and SYSTEMB can run jobs simultaneously. Both would be using library device TAPMLB01. Although only two tape resources (TAP01 and TAP02) are available, each system can run more than two jobs at the same time. The i5/OS resource manager queues requests for resources by allocating them as needed and as they become available. To use one of the resources specifically (as you might in a more complex library setup), you can change the allocation of the non-required resource to DEALLOCATED. This makes the resource unavailable to that system. You can also change the resource allocation manually by using the WRKMLBSTS display. However, if you want to change the allocation dynamically, type the VRYCFG command in an *EXIT command in your control group. For example, if we want i5/OS to select TAPMLB02 to save the PAYROLL application, we could create the following control group items:

Edit Backup Control Group Entries

RCHAS400

Group : SAMPLE
 Default activity : *BKUPCY
 Text : Create sample backup control group

Type information, press Enter.

Seq	Backup Items	List Type	Auxiliary Storage Pool Device	Weekly Activity SMTWTFS	Retain Object Detail	Save While Active	SWA Message Queue
10	*EXIT			*DFTACT			
20	PAYDATA		*SYSBAS	*DFTACT	*ERR	*NO	
30	PAYLIB		*SYSBAS	*DFTACT	*ERR	*NO	
40	*EXIT			*DFTACT			

Bottom

F3=Exit F5=Refresh F10=Change item F11=Display exits
 F12=Cancel F14=Display client omit status F24=More keys

Code the *EXIT at sequence number 10 as follows:

User Exit Maintenance

KITKAT

Type command, press Enter.

Sequence number : 10
 Where used : *EXIT
 Weekly activity : *DFTACT SMTWTFS
 Command : VRYCFG CFGOBJ(TAPMLB01) STATUS(*DEALLOCATE)
 RSRNAME(TAP02) CFGTYPE(*MLBRSC)

...

F3=Exit F4=Prompt F12=Cancel

Code the *EXIT at sequence number 40 as follows:

```

User Exit Maintenance                                KITKAT

Type command, press Enter.

Sequence number . . . . . : 40
Where used . . . . . : *EXIT
Weekly activity . . . . . : *DFTACT SMTWTFS
Command . . . . . : VRYCFG CFGOBJ(TAPMLB01) CFGTYPE(*MLBRSC) STA
TUS(*UNPROTECTED) RSRNAME(TAP02)

...

F3=Exit  F4=Prompt  F12=Cancel

```

Note: You should not use *MEDCLS as the device for a save or restore operation with multiple tape library devices. Instead, you should specifically name the library devices for each save and restore.

Scenario 4: Performing Parallel and Serial Backups in the Same Control Group

Backup and archive control groups which use parallel resources are no longer restricted to the type of backup or archive items these can include. If the control group uses parallel resources and also contains items which cannot be saved using parallel devices, the non-parallel items will automatically be backed up using serial operations. This helps to reduce the number of control groups you need to manage.

Suppose you want to backup your entire system, including spooled files using devices TAP01 and TAP02 in parallel mode. Not all backup items can be backed up in parallel. The system data, configuration data, security data and folder can only be backed up using serial mode. Beginning with V5R4M0, the non-parallel backup items can be included in the same control group with the parallel items, and BRMS will switch in and out of parallel mode as required. Setting this up is simple to do and only requires that you edit a couple of the control group attributes.

1. From a command line, enter WRKCTLGBRM and press Enter.
2. Enter option 8 next to the *SYSTEM control group or next to the control group you use to save your system, then press Enter.
3. Specify TAP01 and TAP02 for the *Backup devices* prompt.
4. Specify 2 for the *Minimum resources* prompt.
5. If you want to save spooled files and the control group entries do not include a spooled file list, then specify *ALL for the *Save contents of save files* prompt.
6. Press Enter to save the changed attributes.

Table 1 shows which backup items are processed serially and which are processed using parallel.

Table 1. Mixed parallel/serial control group processing

Mixed Parallel and Serial Operations	
Backup Item	Serial/Parallel Mode
*SAVSYS	Serial
*IBM	Parallel

Table 1. Mixed parallel/serial control group processing (continued)

*ALLUSR	Parallel
*ALLDLO	Serial
*LINK	Parallel
BRMS Media Information	Serial

The following named backup or archive items will be backed up using a single resource if included in a control group using multiple parallel resources.

- Library QBRM with no other libraries
- Library QUSRBRM with no other libraries
- Library QMSE with no other libraries
- Library Q1ABRMSFnn with no other libraries
- Folder lists
- Spooled file lists if target release is prior to V5R4M0
- Link lists if target release is prior to V5R4M0.
- Saves of BRMS media information.

The following special value backup items will be backed up using a single resource if included in a control group using multiple parallel resources.

- *ALLDLO
- *ASPnn
- *DLOnn
- *EXIT containing a SAVDOMBRM command saving to a target release prior to V5R4M0.
- *LINK if target release is prior to V5R4M0.
- *LNKOMTONL if target release is prior to V5R4M0.
- *LNKOMTLTS if target release is prior to V5R4M0.
- *LTSOMTONL if target release is prior to V5R4M0.
- *SAVCFG
- *SAVSECDTA
- *SAVSYS
- *SAVSYSINF

Additional BRMS Save Commands

In addition to the control groups that process backups, BRMS provides a variety of commands that allow you to save particular groups of information while using BRMS. These save commands are sometimes similar to the i5/OS save commands. You should, however, use BRMS rather than i5/OS commands because BRMS saves the media content, and library and object detail information that is essential for recovery.

Following is a summary of the other BRMS save commands you can use:

SAVBRM

The Save BRMS command allows you to save BRMS libraries and Integrated File System objects.

SAVDLOBRM

The Save DLO using BRM command allows you to save documents in the document library (QDOC).

SAVFLRLBRM

The Save Folder List command using BRM command allows you to save backup folder lists.

SAVLIBBRM

The Save Library using BRM command allows you to save a copy of one or more libraries.

SAVMEDIBRM

The Save Media Information using BRM command saves a copy of the information compiled by BRMS on each saved item.

SAVOBJBRM

The Save Object using BRM command saves a copy of one or more objects.

SAVOBJLBRM

The Save Object List using BRMS command saves backup object lists.

SAVSAVFBRM

The Save Save Files using BRM command saves save files that were created during BRMS processing to tape.

SAVSYSBRM

The Save System using BRM command allows you to save a copy of the operating system library in a format compatible with the installation process. It does not save objects from any other library.

When used to perform backup functions, these commands do not automatically save the recovery data or media information in the QUSRBRM library. After completing one of these commands, you need to save media information with the Save Media Information using BRM (SAVMEDIBRM) command.

Notes:

1. Do not use these commands with an *EXIT in a control group as the results may be unpredictable.
2. If you have processed any backups to save files, you must run the Save Save Files using BRM (SAVSAVFBRM) command with the appropriate control group. Run the SAVMEDIBRM command after the SAVSAVFBRM command and then print new recovery reports.

Chapter 8. Performing Selected Recoveries

In Chapter 4, “Recovering Your Entire System” you learned how to generate and use the Recovering Your Entire System report to recover your entire system. This chapter provides information on how to selectively restore single objects or groups of objects. With BRMS, you can selectively restore system information, libraries, control groups, Integrated File System objects, and other items. In case of disaster, a selective restore strategy allows you to recover critically needed applications and information prior to restoring the rest of your system.

There are several ways you can selectively recover items by using BRMS. The primary recovery command is the Start Recovery using BRM (STRRCYBRM) command. You can use other commands to facilitate the recovery of user profiles, objects, folders, and spooled files.

Many of the functions described in this chapter are available with the BRMS iSeries Navigator client. For detailed information on the BRMS iSeries Navigator client, see the iSeries Information Center.

Recovery Policy

Use the recovery policy to instruct BRMS on how to implement your recovery plan. For example, you can use the recovery policy to select the types of media and devices you want to use for the recovery. You can also use the recovery policy to instruct BRMS to restore objects and libraries in specific ways.

To get to the recovery policy display, take the following steps:

1. Type WRKPCYBRM *RCY at a command line. Press Enter.

```
Change Recovery Policy                                RCHAS400
Type choices, press Enter.
Recovery device. . . . . *MEDCLS      Name, F4 for list

Parallel device resources:
  Minimum resources. . . . . *SAV      1-32, *NONE, *AVAIL
  Maximum resources. . . . .          1-32, *AVAIL, *MIN
  End of tape option . . . . . *REWIND  *REWIND, *LEAVE, *UNLOAD
  Option . . . . . *ALL                *ALL, *NEW, *OLD, *FREE
  Data base member option . . . . *ALL  *MATCH, *ALL, *NEW, *OLD
  Restore spooled file data . . . *NONE *NONE, *NEW
  Allow object differences . . . . *NONE *NONE, *ALL, *AUTL,
                                     *FILELVL, *OWNER, *PGP

More...

F3=Exit   F4=Prompt   F5=Refresh   F9=System policy
F12=Cancel
```

The following are brief summaries of the key parameters on this display.

- In the *Recovery devices* field, specify the device or devices that you want to perform the recovery. You can specify a specific device name or *MEDCLS, which instructs BRMS to select any available device that matches the media class you plan to use.

Notes:

- a. If you did not notify BRMS that you recently moved media from an off site to an on site location, the *MEDCLS device search may fail. For this reason, it is better to explicitly name the device you want BRMS to use for the recovery.
- b. If BRMS cannot find the media in it's specified location and *MEDCLS was specified, BRMS will try to locate the media in the available devices.
- In the *Parallel device resources* field, specify whether you want to perform parallel recoveries. In a parallel recovery, BRMS allocates multiple devices to process one large job. You need multiple devices (at least two) to use this option. BRMS can only perform parallel restores on information that was saved with the parallel process. You can find more information about parallel and concurrent (multiple jobs to multiple devices) recoveries later in this chapter.
- Use the *Database member option* field to specify which members of database files you want to restore to the database.
- Use the *Restore spooled file data* field to specify whether spooled files saved concurrently with saved output queues are to be restored when the output queues are restored.
- In the *Allow object differences* field, you can instruct BRMS to allow differences between saved and restored objects.

Note: If restoring objects that BRMS saved with SAVOBJ or SAVCHGOBJ, BRMS will change the parameter to ALWOBJDIF(*FILELVL *AUTL *OWNER *PGP) for these objects to prevent the renaming.

2. Page to the next display to see additional recovery policy options.

Change Recovery Policy RCHAS400

Type choices, press Enter.

Restore to library	*SAVLIB	Name, *SAVLIB
Auxiliary storage pool	*SAVASP	Name, *SAVASP, 1-32 ...
Document name generation	*SAME	*SAME, *NEW
System resource management	*ALL	*ALL, *NONE, *HDW, *TRA
Restore into folder	*SAME	
Apply journaled changes:		
Restore journal receivers	*YES	*YES, *NO
Apply option	*NONE	*NONE, *APPLY, *REMOVE
Ending date	*CURRENT	Date, *CURRENT
Ending time	*CURRENT	Time, *CURRENT
Lotus point-in-time:		
Ending date	*CURRENT	Date, *CURRENT, *FULL
Ending time	*CURRENT	Time, *CURRENT, *FULL
Create parent directories	*NO	*NO, *YES
Parent directories owner	*PARENT	Name, *PARENT

Bottom

F3=Exit F4=Prompt F5=Refresh F9=System policy
F12=Cancel

The following are brief summaries of the key parameters on the second page.

- In the *Restore to library* field, indicate whether to restore library contents to a library different from the one in which they were saved. You should not leave this as *SAVLIB. Instead, either name a specific default library (for example, RESTORES) or use the system-provided QTEMP library. If you leave the value at *SAVLIB, you run the risk of overwriting a production library. To avoid this, you should change the default. If you want to restore the original library at a later time, you can override the name you specify here when you want to perform the recovery operation.
- In the *Auxiliary storage pool ID* field, indicate whether to restore libraries and objects to the same auxiliary storage pool (ASP) in which they originated.
- In the *Restore into folder* field, specify the name of the folder in which the restored folders and documents to be restored will be placed.

- In the *Restore journal receivers* field, specify whether you want journal receivers for journaled objects to be restored when the journaled objects are restored.
- Use the *Apply option* field to specify whether the journal changes are applied to journaled objects after the objects are restored.
- In the *Ending date/Ending time* field, specify the date and time of the last journal entry that is applied. See “Recovery with Apply Journal Changes” on page 178 for additional information about recovery of journaled objects.
- In the *Lotus point-in-time Ending date/Ending time* field, you can instruct BRMS how Lotus server objects are restored. You can specify whether only the full save is recovered, or the full save and all current incremental saves are recovered, or the full save and incremental saves up to a specific point in time are recovered. See “Lotus Server Recovery” on page 270 for additional information about recovery of Lotus server objects.
- Use the *Create parent directories* field to specify whether parent directories are to be created automatically if the directories do not exist before the object is restored.

Note: This parameter only applies to “root” (/), QOpenSys, and user-defined file systems.

The *Parent directories owner* field specifies the name of the owner to be used for the parent directory when creating parent directories which do not exist.

3. After reviewing and changing the parameters as needed, press Enter to save and exit.

BRMS uses only one recovery policy to cover all of your recovery needs. You should only need to set recovery policy parameters once. However, it is possible to change recovery policy values on an item by item basis by using the Restore Command Defaults display. Later in this chapter, you learn how to access and use this display.

```

Select Recovery Items                                RCHAS400
                                                    Select action . . . . . : *ALL
                                                    Select volume . . . . . :
Type options, press Enter.
1=Select  4=Remove  5=Display  7=Specify object

  Saved      Save   Save   Save   Parallel Volume   File   Expire
Opt Item     Date   Time  Type  Devices Serial  Sequence Date
LIB1        10/15/05 15:12:36 *FULL          000C0D          1  5/19/06

                                                    Bottom

F3=Exit  F5=Refresh  F9=Recovery defaults  F11=Object View
F12=Cancel  F14=Submit to batch  F16=Select

```

Working with the STRRCYBRM Command

The Start Recovery using BRM (STRRCYBRM) command performs two critical recovery functions:

- Generates the reports that guide your recovery.
- Initiates and processes the restore commands.

This chapter provides instruction on how to use the parameters on the STRRCYBRM command to recover selected saved items. You can use the STRRCYBRM command to selectively recover the following items:

- Control Groups

- Libraries
- Integrated File System data and other LINKLIST items

Understanding the STRRCYBRM Parameters

On the STRRCYBRM display, you can select the items you want to recover and the saves from which you want them restored. The STRRCYBRM command bases its restores on the save date and time entries in the media content information that best match your restore specifications. The STRRCYBRM command always restores from the most recent full save of the specified item that precedes the date and time parameters you specify.

To get to the Start Recovery using BRM display, take the following steps:

1. Type STRRCYBRM from a command line and press F4 to prompt the display. This takes you to the initial STRRCYBRM display.

```

Start Recovery using BRM (STRRCYBRM)

Type choices, press Enter.

Option . . . . . *SYSTEM      *SYSTEM, *ALLDLO, *ALLUSR...

                                                                    Bottom
F3=Exit  F4=Prompt  F5=Refresh  F10=Additional parameters  F12=Cancel
F13=How to use this display  F24=More keys

```

2. Press F9 to prompt the remaining parameters.

```

Start Recovery using BRM (STRRCYBRM)

Type choices, press Enter.

Option . . . . . *SYSTEM      *SYSTEM, *ALLDLO, *ALLUSR...
Action . . . . . *REPORT      *REPORT, *RESTORE
Time period for recovery:
Start time and date:
Beginning time . . . . . *AVAIL      Time, *AVAIL
Beginning date . . . . . *BEGIN      Date, *CURRENT, *BEGIN
End time and date:
Ending time . . . . . *AVAIL      Time, *AVAIL
Ending date . . . . . *END        Date, *CURRENT, *END
Use save files . . . . . *YES      *YES, *NO
Use TSM . . . . . *YES          *YES, *NO
Auxiliary storage pool . . . . . *SYSTEM      Name, 1-32, *SYSTEM
Library . . . . .                Name, generic*
List . . . . . *ALL              Name, *ALL

                                                                    More....
F3=Exit  F4=Prompt  F5=Refresh  F12=Cancel  F13=How to use this display
F24=More keys

```

Following are brief summaries of the key parameters on this display:

- At the *Option* parameter, you need to specify the kind of recovery you want BRMS to perform. The default value for this parameter is *SYSTEM, which instructs BRMS to recover your entire system. You can change this value to specify a number of saved items to recover, including product and user libraries, control groups, and Integrated File System data. Press F1 (Help) to prompt a list of the items you can recover from this parameter.
 - At the *Action* parameter, you need to specify whether you want BRMS to generate recovery reports (*REPORT) or perform a restore (*RESTORE). The default value for this parameter is *REPORT, so when you want BRMS to perform a recovery, you need to change this value to *RESTORE.
 - At the *Time period for recovery* parameters, specify a range of save dates and times between which BRMS should perform the restore. For example, when you select beginning and ending dates and times, you instruct BRMS to restore items that were saved only during those periods.
 - If you are using the BRMS Network feature, you can use the *From system* parameter to create recovery reports for other networked systems, or to view and recover one or more of the saved items from a networked system to the local system. Refer to Chapter 14, “Networking with BRMS,” on page 237 for additional information about setting up and using the BRMS Network feature. If you are recovering the local system, use the default value for this field, *LCL, which instructs BRMS to use the system currently in use.
3. Become familiar with the remaining parameters on this command and change them as needed to suit the type of recovery you want to perform.
 4. Press Enter to begin the recovery.

Note: This command allows the user to manually select duplicate media to restore from, therefore the automatic selection of alternate input media as specified on the system policy will not affect restore operations initiated from this command.

Recovering Control Groups with STRRCYBRM

While you cannot use the STRRCYBRM command to recover individual spooled files, document library objects (DLO), or folders, you can use it to recover the control group in which they were saved. To recover a control group with the STRRCYBRM command, take the following steps:

1. Type STRRCYBRM at a command line and press F4 to prompt the display.
2. Press F9 to prompt the remaining parameters.

```

Start Recovery using BRM (STRRCYBRM)

Type choices, press Enter.

Option . . . . . *CTLGRP      *SYSTEM, *ALLDLO, *ALLUSR...
Action . . . . . *RESTORE     *REPORT, *RESTORE
Time period for recovery:
Start time and date:
Beginning time . . . . . *AVAIL      Time, *AVAIL
Beginning date . . . . . *BEGIN      Date, *CURRENT, *BEGIN
End time and date:
Ending time . . . . . *AVAIL      Time, *AVAIL
Ending date . . . . . *END         Date, *CURRENT, *END
Use save files . . . . . *YES       *YES, *NO
Use TSM . . . . . *YES           *YES, *NO
Auxiliary storage pool . . . . *SYSTEM   Name, 1-32, *SYSTEM
Library . . . . .                Name, generic*
List . . . . . *ALL              Name, *ALL

More....

F3=Exit  F4=Prompt  F5=Refresh  F12=Cancel  F13=How to use this display
F24=More keys

```

3. Type *CTLGRP in the *Option* field.
4. Type *RESTORE in the *Action* field.
5. Change the *Time period for recovery* parameters as needed.

```

Start Recovery using BRM (STRRCYBRM)

Type choices, press Enter.

Journal . . . . . *JRNLST      Name, *JRNLST
Library . . . . .           Name
      + for more values

ASP device:
From system . . . . . *LCL
Auxiliary storage pool . . . . *ALL      Name, *ALL
Objects . . . . . *ALL      *ALL, *LIB, *LNK
      + for more values

Control group selection:
Control group . . . . . *SELECT     Name, *SELECT, *NONE...
Sequence number . . . . .           1-99
      + for more values

Libraries to omit . . . . . *DELETE   Name, generic*, *DELETE...
      + for more values

Allow duplicate entries . . . . *NO      *NO, *YES
                                          More...

F3=Exit  F4=Prompt  F5=Refresh  F12=Cancel  F13=How to use this display
F24=More keys

```

- If you want to restore only one control group and know its name, type it into the *Control group* field. Or you can use the *SELECT value to select from a list of control groups. Since the *SELECT value is the default value for this parameter, simply press Enter once to prompt the list.

```

Select and Sequence Control Groups                RCHAS400

Type sequence number (1-99), press Enter.

Seq      Control Group      Text
--      -
1_      *BKUGRP      Entry created by BRM configuration
2_      *SYSGRP      Entry created by BRM configuration
1_      PAYROLL      Pay schedule for week of 05/05/05.
2_      INVENTORY    Warehouse content week of 05/05/05.
--      MYLIB        Library belonging to Jane Doe.
--      YOURLIB       Library belonging to John Smith

Bottom

F3=Exit  F9=Review backup plan  F12=Cancel

```

- Place a number in the *Seq* column next to the control groups you want to restore in the order in which you want BRMS to restore them.
- Press Enter twice to get to the Select Recovery Items display.

```

Select Recovery Items                                RCHAS400

Select action . . . . . : *ALL
Select volume . . . . . :

Type options, press Enter.
1=Select  4=Remove  5=Display  7=Specify object

  Saved      Save      Save      Save      Parallel Volume      File      Expire
Opt Item    Date      Time      Type      Devices  Serial      Sequence  Date
1  A/PAYABLE 5/27/05 16:51:56 *FULL          172534          1  6/10/05
1  A/REC     5/27/05 13:20:26 *FULL          172534          1  6/10/05
1  INV/DISKS 5/30/05 17:00:27 *FULL          1727C0          1  6/10/05
1  INV/DRIVES 5/30/05 17:15:10 *FULL          1727C0          1  6/10/05

Bottom

F3=Exit  F5=Refresh  F9=Recovery defaults  F11=Object View
F12=Cancel  F14=Submit to batch  F16=Select

```

9. A list of the items contained in the control groups you specified appears on this display. Type a 1 (Select) next to the items you want BRMS to recover and press Enter. Press F16 to instruct BRMS to restore all of the items on the display.
10. Press Enter to confirm your selections at the Confirm Recovery Items display. This returns you to the STRRCYBRM display.
11. Review and change the other parameters on the STRRCYBRM display as needed.
12. To override any recovery policy values for this (or any other) specific job, press F9 from this display. This takes you to the Restore Command Default display, which contains most of the parameters and values from the recovery policy display.

```

Restore Command Defaults

Type information, press Enter.
Device . . . . . *MEDCLS      Name, *MEDCLS

Parallel device resources:
  Minimum resources. . . . . *SAV      1-32, *NONE, *AVAIL
  Maximum resources. . . . .          1-32, *AVAIL, *MIN
  End of tape option . . . . . *REWIND *REWIND, *LEAVE, *UNLOAD
  Option . . . . . *ALL          *ALL, *NEW, *OLD, *FREE
  Data base member option . . . . . *ALL *MATCH, *ALL, *NEW, *OLD
  Restore spooled file data . . . . . *NONE *NONE, *NEW
  Allow object differences . . . . . *NONE *NONE, *ALL, *AUTL,
                                     *FILELVL, *OWNER, *PGP

More...

F12=Cancel

```

- At this display, you can override recovery policy values to, for example, specify a particular device or type of restore (for example, a parallel restore). Change the parameters as needed and press Enter to return to the Select Recovery Items display.
13. After reviewing and changing the parameters as needed, press Enter to begin the restore. As STRRCYBRM processes your request, the Display Recovery Items display keeps you informed of status of the recovery.

the incremental control group so that it is positioned after the full control group. This will cause the full and incremental saves to be processed together and assure correct selection of the saved items.

If you prefer using the displays to create the command, you can set up the command specifications as follows:

1. Change the value in the Option field to *CTLGRP.
2. Change the value in the Action field to *RESTORE.

```

Start Recovery using BRM (STRRCYBRM)

Type choices, press Enter.

Option . . . . . > *CTLGRP      *SYSTEM, *ALLDLO, *ALLUSR...
Action . . . . . *RESTORE      *REPORT, *RESTORE
Time period for recovery:
  Start time and date:
  Beginning time . . . . . *AVAIL      Time, *AVAIL
  Beginning date . . . . . *BEGIN      Date, *CURRENT, *BEGIN
  End time and date:
  Ending time . . . . . *AVAIL      Time, *AVAIL
  Ending date . . . . . *END          Date, *CURRENT, *END
Use save files . . . . . *YES        *YES, *NO
Use TSM . . . . . *YES            *YES, *NO
Control group selection:
  Control group . . . . . *SELECT      Name, *SELECT, *NONE...
  Sequence number . . . . .          1-99
      + for more values

More...
F3=Exit  F4=Prompt  F5=Refresh  F10=Additional parameters  F12=Cancel
F13=How to use this display  F24=More keys

```

3. Enter + for the *Control group selection* field, then press Enter to get to the *Specify More Values for Parameter CTLGRP* display.
4. Enter PAYROLL for the first control group sequence, MANUFACT for the second, and INVENTORY for the third.

```

Specify More Values for Parameter CTLGRP

Type choices, press Enter.

Control group selection:
  Control group . . . . . PAYROLL      Name, *SELECT, *NONE...
  Sequence number . . . . . 1          1-99

  Control group . . . . . MANUFACT     Name, *NONE, *BKUGRP...
  Sequence number . . . . . 2          1-99

  Control group . . . . . INVENTORY    Name, *NONE, *BKUGRP...
  Sequence number . . . . . 3          1-99

  Control group . . . . .              Name, *NONE, *BKUGRP...
  Sequence number . . . . . 1          1-99

  Control group . . . . .              Name, *NONE, *BKUGRP...
  Sequence number . . . . . 1          1-99

More...
F3=Exit  F4=Prompt  F5=Refresh  F12=Cancel  F13=How to use this display
F24=More keys

```

5. Review and change the other parameters as needed, then press Enter to process the command.

Recovering Libraries with STRRCYBRM

To recover a library with the STRRCYBRM command, take the following steps:

1. Type *LIB at the *Option* parameter and *RESTORE at the *Action* parameter.

```

Start Recovery using BRM (STRRCYBRM)

Type choices, press Enter.

Option . . . . . > *LIB          *SYSTEM, *ALLDLO, *ALLUSR...
Action . . . . . > *RESTORE      *REPORT, *RESTORE
Time period for recovery:
  Start time and date:
  Beginning time . . . . . *AVAIL   Time, *AVAIL
  Beginning date . . . . . *BEGIN   Date, *CURRENT, *BEGIN
  End time and date:
  Ending time . . . . . *AVAIL     Time, *AVAIL
  Ending date . . . . . *END       Date, *CURRENT, *END
  Use save files . . . . . *YES     *YES, *NO
  Use TSM . . . . . *YES          *YES, *NO
  Library . . . . .                Name, generic*

Bottom
F3=Exit  F4=Prompt  F5=Refresh  F10=Additional parameters  F12=Cancel
F13=How to use this display  F24=More keys

```

2. Type the name of the library you want BRMS to restore in the *Library* field. You can also recover a string of libraries by using a generic library name. For example, you can restore all libraries that begin with P by specifying P* at the *Library* parameter. After you have specified the library you want to restore, press Enter. This takes you to the Select Recovery Items display.

```

Select Recovery Items                                RCHAS400

Select action . . . . . : *ALL
Select volume . . . . . :

Type options, press Enter.
  1=Select  4=Remove  5=Display  7=Specify object

  Saved      Save   Save   Save   Parallel Volume   File   Expire
Opt Item    Date   Time  Type  Devices Serial  Sequence Date
  1 LIB10    5/28/05 18:39:05 *FULL   172534      4     7/01/05
  1 LIB20    5/28/05 18:55:21 *INCR   172535      5     7/01/05

Bottom
F3=Exit  F5=Refresh  F9=Recovery defaults  F11=Object View
F12=Cancel  F14=Submit to batch  F16=Select

```

3. Select the items you want to recover and press Enter.
4. Press Enter at the Confirm Recovery Items display to confirm your selections.
5. If you want to override any of the recovery policy parameters for this specific job, press F9 to take you to the Restore Command Default display. If you do not want to change any recovery policy parameters, press Enter to begin processing the restore.
6. The Display Recovery Items display appears to inform you of the status of your restore.
7. When the recovery completes, a message appears at the bottom of the Select Recovery Items display. This message tells you the number of objects BRMS restored (for example, 1 object) and from which library (LIBA).

8. Check the job log to ensure that the restore completed successfully.

In addition to recovering selected individual libraries, you can use the STRRCYBRM command to restore all of your IBM libraries or all of your user libraries. To restore all of the *IBM or *ALLUSR libraries, specify *IBM or *ALLUSR at the *Option* parameter. Leave the *Library* field blank.

Recovery of Individual Integrated File System Objects

In Chapter 7, you learned how to save your Integrated File System data in a control group by using a link list. The word link in the word link list in this case refers to the connection between Integrated File System directories. You can use the STRRCYBRM command to restore an individual link list, rather than the entire control group that contains the link list. To do so, take the following steps:

1. At the STRRCYBRM display, type *LNKLIST in the *Option* field.

```

Start Recovery using BRM (STRRCYBRM)

Type choices, press Enter.

Option . . . . . > *LNKLIST      *SYSTEM, *ALLDLO, *ALLUSR...
Action . . . . . > *RESTORE      *REPORT, *RESTORE
Time period for recovery:
  Start time and date:
    Beginning time . . . . . *AVAIL      Time, *AVAIL
    Beginning date . . . . . *BEGIN      Date, *CURRENT, *BEGIN
  End time and date:
    Ending time . . . . . *AVAIL      Time, *AVAIL
    Ending date . . . . . *END        Date, *CURRENT, *END
  Use save files . . . . . *YES        *YES, *NO
  Use TSM . . . . . *YES            *YES, *NO
  List . . . . . *ALL              Name, *ALL

Bottom
F3=Exit  F4=Prompt  F5=Refresh  F10=Additional parameters  F12=Cancel
F13=How to use this display  F24=More keys

```

The *LNKLIST special value restores all of the Integrated File System objects that BRMS saved in the list between the start and end times you specify on this display.

2. Change the other parameters as needed.
3. Override recovery policy parameters if needed by pressing F9, which takes you to the Restore Command Defaults display. Or press Enter to process the recovery.
4. Check the job log to make sure that the job completed successfully.

Restoring a Storage Space with BRMS

You can use either the Work with Link Information (WRKLNKBRM) or the Work with Media Information in BRM (WRKMEDIBRM) command to restore Integrated File System storage space. Before beginning the restore operation, vary off your Integrated PC server. This example uses the WRKLNKBRM command to restore two storage spaces, DRIVEK and DRIVEL, from the /QFPNWSSTG directory. To restore the storage space by using the WRKLNKBRM display, take the following steps:

1. Type WRKLNKBRM at a command line and press Enter.

Note: In V5R3M0, the path name order will begin with the uppercase path names and be followed then by the lowercase path names.

2. Type a 9 (Work with directory information) in front of the directory you want to work with and press Enter. This takes you to the Work with objects display.
3. Type a 7 (Restore) in front of the objects you want to restore and press Enter.

```

Work with Objects                                RCHAS400
                                                06/30/04 14.53.21
Directory . . . . : /QFPNWSSTG
Saved date/time . : 05/12/05 10:37:41

Type options, press Enter.
4=Remove 5=Display 7=Restore

Opt Object                                Volume
7 DRIVEK                                Serial
7 DRIVEL                                ABC592
                                           Size
                                           ABC592
                                           34816
                                           29184

Bottom

Command
====>
F3=Exit F4=Prompt F5=Refresh F9=Retrieve F12=Cancel F17=Position to
F22=Display entire field

```

```

Select Recovery Items                            RCHAS400

Select action . . . . . : *ALL
Select volume . . . . . :

Type options, press Enter.
1=Select 4=Remove 5=Display 7=Specify object

Saved      Save      Save      Save      Parallel Volume  File      Expire
Opt Item   Date      Time     Type     Devices  Serial   Sequence  Date
1 LANSTGS  6/12/05  10:37:41 *FULL    ABC592   1       7/17/05
1 LANSTGS  6/12/05  10:37:41 *FULL    ABC592   1       7/17/05

Bottom

F3=Exit F5=Refresh F9=Recovery defaults F11=Object View
F12=Cancel F14=Submit to batch F16=Select

```

4. Select the items you want to recover from the Select Recovery Items display and press Enter.
5. Confirm the items you want to recover at the Confirm Recovery Items display.
6. Type a 9 (Work with objects) in front of the items you want to restore and press Enter. The recovery process begins.
7. After the restore completes, you can vary on the Integrated PC server. This can take several minutes. Once you activate the Integrated PC server, you should also try out a few options from the Network Server Administration (NWSADM) menu to ensure that everything is working correctly.
8. To verify that BRMS successfully completed the restore, use the Work with Network Server Storage Spaces (WRKNWSSTG) command.
9. Link the storage names with the appropriate drive letters by using the Add Server Storage Link (ADDNWSSTGL) command. You can also use option 10 from the Work with Network Storage Space (WRKNWSSTG) display to perform the same task.

Recovering User Profiles

This example assumes that you saved your user profiles in a control group, for example, in the *SECDATA control group or in a control group created by you. To restore your user profiles, take the following steps:

1. Use the INZBRM *DEVICE command to clear device information. This also initializes the files for the devices currently attached to your system.
2. Type STRRCYBRM at a command line and press F4.
3. Type *CTLGRP in the Option field and press Enter.
4. Change the value in the *Action* field to *RESTORE.
5. Type the name of the control group that contains the user profiles into the *Control group selection* field.
6. Make sure that the value in the *Library to omit* field is *DELETE. Press Enter.
7. Press F9 (Recovery defaults) at the Select Recovery Items display.
8. On the Restore Command Defaults display, change the value in the *Allow object differences* field to *ALL or to the specific differences you want to allow for the restore.

Restore Command Defaults

Type information, press Enter.

Device	*MEDCLS	Name, *MEDCLS
------------------	---------	---------------

Parallel device resources:

Minimum resources.	*SAV	1-32, *NONE, *AVAIL
Maximum resources.		1-32, *AVAIL, *MIN
End of tape option	*REWIND	*REWIND, *LEAVE, *UNLOAD
Option	*ALL	*ALL, *NEW, *OLD, *FREE
Data base member option	*ALL	*MATCH, *ALL, *NEW, *OLD
Restore spooled file data	*NONE	*NONE, *NEW
Allow object differences	*ALL	*NONE, *ALL, *AUTL, *FILELVL, *OWNER, *PGP

More...

F12=Cancel

9. Select the items you want to restore at the Select Recovery Items display and press Enter.
10. Press Enter once to return to the Select Recovery Items display and again to process the restore.

You can use the i5/OS command Restore User Profiles (RSTUSRPRF) to restore individual user profiles.

Additional Restore Options in BRMS

This section provides information on how you can restore objects, folders, and spooled files by using other BRMS recovery commands.

Recovering Objects with Object Detail

Use the Work with Media Information (WRKMEDIBRM) command to restore individual objects for which BRMS saved object detail.

Note: This command allows the user to manually select duplicate media to restore from, therefore the automatic selection of alternate input media as specified on the system policy will not affect restore operations initiated from this command.

To get there, take the following steps:

1. Type WRKMEDIBRM at a command line and press Enter.

```

Work with Media Information                                RCHAS400

Position to Date . . . . .

Type options, press Enter.
 2=Change  4=Remove  5=Display  6=Work with media  7=Restore
 9=Work with saved objects  ...

  Saved      Save      Save      Save      Parallel Volume  File      Expire
Opt Item     Date      Time      Type      Devices  Serial   Sequence  Date
VETTEASP32  6/23/05  11:01:56 *FULL          SAM190    196  7/28/05
VETTE2      6/23/05  11:01:56 *FULL          SAM190    197  7/28/05
ZDRH001     6/23/05  11:01:56 *FULL          SAM190    198  7/28/05
ZDRH002     6/23/05  11:01:56 *FULL          SAM190    199  7/28/05
ZDRH003     6/23/05  11:01:56 *FULL          SAM190    200  7/28/05
QFILE       6/23/05  11:02:10 *FILE          SAM190    142  7/28/05
QUSRBRM     6/23/05  11:09:23 *FULL          SAM190    201  7/28/05
*ALLDLO    6/23/05  11:09:59 *FULL          SAM190    202  7/28/05
*LINK       6/23/05  11:10:28 *FULL          SAM190    203  7/28/05
9 QUSRBRM   6/23/05  11:28:00 *QBRM          SAM190    204  7/28/05
                                                More...

F3=Exit  F5=Refresh  F11=Object detail  F12=Cancel
F23=More options

```

2. Type a 9 (Work with Saved Objects) in front of the saved item from which you want BRMS to perform the restore. If object level detail does not exist for that item, BRMS sends a message stating that object level detail does not exist for that entry.
3. Press Enter. This takes you to the Work with Saved Items display.

```

Work with Saved Objects                                RCHAS400

Position to Object . . .

Type options, press Enter.
 4=Remove  5=Display  6=Work with media  7=Restore object
 9=Work with saved members

Opt Object      Library      Type      Save      Save      Volume  Message
              Date      Time      Date      Time      ID
7 QA1ACN        QUSRBRM     *FILE     6/23/05  11:28:00  SAM190
7 QA1ADV        QUSRBRM     *FILE     6/23/05  11:28:00  SAM190
QA1ADXR        QUSRBRM     *FILE     6/23/05  11:28:00  SAM190
7 QA1AHS        QUSRBRM     *FILE     6/23/05  11:28:00  SAM190
QA1ALR         QUSRBRM     *FILE     6/23/05  11:28:00  SAM190
QA1AMD         QUSRBRM     *FILE     6/23/05  11:28:00  SAM190
QA1AMM         QUSRBRM     *FILE     6/23/05  11:28:00  SAM190
QA1AMT         QUSRBRM     *FILE     6/23/05  11:28:00  SAM190
QA1ANET2       QUSRBRM     *FILE     6/23/05  11:28:00  SAM190
QA1A0Q         QUSRBRM     *FILE     6/23/05  11:28:00  SAM190
                                                More...

F3=Exit  F12=Cancel

```

4. Type a 7 (Restore object) in front of the object you want to restore and press Enter.

```

Select Recovery Items                                RCHAS400

Type options, press Enter.  Press F16 to select all.
  1=Select  4=Remove  5=Display

Opt Object      Library      Type      Save      Expiration      Volume      Message
 1 QA1ACN      QUSRBRM    *FILE     6/23/05    7/28/05    SAM190
 1 QA1ADV      QUSRBRM    *FILE     6/23/05    7/28/05    SAM190
 1 QA1AHS      QUSRBRM    *FILE     6/23/05    7/28/05    SAM190

F3=Exit  F5=Refresh  F9=Recovery defaults  F12=Cancel
F14=Submit to batch  F16=Select all

Bottom

```

5. At the Select Recovery Items display, type a 1 (Select) in front of the objects you want to restore. To restore all of the objects that are listed on the display, press F16, which selects all of them for you.
6. Press Enter to confirm your selections at the Confirm Recovery Items display.
7. Press Enter to begin processing the restore. At the completion of the recovery, BRMS sends a message that tells you how many objects it restored.
8. Check the job log to ensure that the job completed successfully.

Recovering Objects without Object Detail

Even if you have not instructed BRMS to retain object detail, you can still restore individual or groups of objects. To do so, use the Work with Media Information (WRKMEDIBRM) command to restore the library that contains the object or objects that you want to restore. To get there, take the following steps:

1. Type WRKMEDIBRM at a command line and press Enter.
2. Type a 7 (Restore) next to the item that contains the object you want to restore. Press Enter.

```

Work with Media Information                            RCHAS400

Position to Date . . . . .

Type options, press Enter.
  2=Change  4=Remove  5=Display  6=Work with media  7=Restore
  9=Work with saved objects  ...

  Saved      Save      Save      Save      Parallel Volume      File      Expire
Opt Item     Date      Time      Type      Devices   Serial    Sequence  Date
VETTEASP32  6/23/05  11:01:56 *FULL    SAM190    196      7/28/05
VETTE2      6/23/05  11:01:56 *FULL    SAM190    197      7/28/05
ZDRH001     6/23/05  11:01:56 *FULL    SAM190    198      7/28/05
ZDRH002     6/23/05  11:01:56 *FULL    SAM190    199      7/28/05
ZDRH003     6/23/05  11:01:56 *FULL    SAM190    200      7/28/05
QFILE       6/23/05  11:02:10 *FILE    SAM190    142      7/28/05
QUSRBRM     6/23/05  11:09:23 *FULL    SAM190    201      7/28/05
*ALLDLO     6/23/05  11:09:59 *FULL    SAM190    202      7/28/05
*LINK       6/23/05  11:10:28 *FULL    SAM190    203      7/28/05
7 QUSRBRM    6/23/05  11:28:00 *QBRM    SAM190    204      7/28/05
More...

F3=Exit  F5=Refresh  F11=Object detail  F12=Cancel
F23=More options

```

3. This takes you to the *Select Recovery Items* display. At this display, type a 7 (Specify object) in front of the item that contains the item you want to restore. Press Enter.

```

Select Recovery Items                                RCHAS400

Select action . . . . . : *ALL
Select volume . . . . . :

Type options, press Enter.
1=Select  4=Remove  5=Display  7=Specify object

  Saved      Save      Save      Save      Parallel Volume   File      Expire
Opt Item    Date      Time      Type      Devices  Serial    Sequence  Date
7 QUSRBRM   6/23/04  11:28:00 *QBRM          SAM190      204      7/28/04

Bottom

F3=Exit  F5=Refresh  F9=Recovery defaults  F11=Object View
F12=Cancel  F14=Submit to batch  F16=Select

```

This takes you to the *Restore Object (RSTOBJ)* command display.

```

Restore Object (RSTOBJ)

Type choices, press Enter.

Objects . . . . . Q01AUSRRCY  Name, generic*, *ALL
+ for more values
Saved library . . . . . > QUSRBRM  Name, generic*, *ANY
Device . . . . . TAPMLB01  Name, *SAVF, *MEDDFN
+ for more values
Object types . . . . . > *ALL  *ALL, *ALRTBL, *BNDDIR...
+ for more values
Volume identifier . . . . . > SAM190  Character value, *MOUNTED...
Sequence number . . . . . > 0000000204  1-16777215, *SEARCH

Bottom

F3=Exit  F4=Prompt  F5=Refresh  F10=Additional parameters  F12=Cancel
F13=How to use this display  F24=More keys

```

4. At the *Object* parameter, type in the name of the object you want to restore.
5. At the *Device* parameter, type in the name of the device where the volume is mounted.
6. Press Enter to process the restore.

Note: You can restore multiple objects from the Restore Objects display.

Recovery with Apply Journal Changes

Beginning with V5R3M0, BRMS keeps track of the files and members in user libraries which are journaled at the time of the save to provide you with additional assistance when recovering these objects.

Note: If the recovery includes objects saved with pending transactions, you must either apply or remove the journal changes for these objects to be usable.

Note: If you re-save objects with pending transactions without specifying *NOCMTBDY for *Pending record changes*, you need to also specify *YES for *Retain object detail* if you want to use BRMS for applying or removing journal changes for the most recent save. BRMS cannot assist with applying or removing journal changes for objects for which there is no object detail.

When you select 5=*Display* from the BRMS *Work with Saved Objects* display, the last panel of the *Display Object Save Information* display shows you whether the object was saved with pending transactions, the associated journal and starting journal receiver. The journal and journal receiver information will always be filled in if the object was journaled at the time of the save.

```
Display Object Save Information

Pending transactions . . . . . : *YES
Journal . . . . . : JRN1
Journal library . . . . . : JRNLIB
Journal receiver . . . . . : RCV005
Journal receiver library . . . . . : JRNLIB

Press Enter to continue.                                Bottom
F3=Exit  F12=Cancel
```

System Recovery

When you restore the entire system, the i5/OS operating system correctly establishes the receiver chains when the journals and journal receivers are restored to the system. You can then use one of the following commands to have BRMS assist you in applying journaled changes:

```
STRRCYBRM OPTION(*APYJRNCHG) JRN(*JRNLST)
or
STRRCYBRM OPTION(*APYJRNCHG) JRN((library-name/journal-name))
```

The first form of the command retrieves a list of journals in user libraries which BRMS has saved.

Note: In order for BRMS to store information about saved journaled objects, journals and journal receivers, you must specify *MBR for *Retain object detail* on the BRMS save command or backup control group attributes.

Note: BRMS does not save journal information for objects in libraries which begin with the letter Q or the # character. These are considered system libraries supplied by IBM program products.

The second form of the command allows you to specify up to 25 qualified names of journals to which you want to apply changes.

Either command takes you to the *Work with Journals using BRMS* display where you can view the status of the specified journals. From this panel you can select options to view the journal attributes and apply the journal changes. The *Status* column on the display indicates whether the journal exists on the system and can help you easily identify a missing journal.

```

Work with Journals using BRMS
System: RCHAS400
Type options, press Enter.
1=Apply journal changes 5=Work with journal attributes

Opt  Journal      Library      Save      Save      Status
     Date      Time
-   JRN1      JRNLIB      06/12/05  10:21:53  *FOUND
1   JRN2      JRNLIB      06/12/05  10:21:53  *FOUND
-   JRN3      JRNLIB      / /      : :      *NOTFOUND
-   JRN4      JRNLIB      06/12/05  10:21:53  *FOUND

Bottom

Type command, press Enter.
===>
F4=Prompt  F5=Refresh  F9=Retrieve  F11=Show ASP view  F12=Cancel

```

When you specify *1=Apply journal changes* next to a journal in the list, you are taken to the *Apply Journal Changes using BRMS* display which lists the journal receiver chain for the selected journal. The *Status* column on the display indicates the journal receiver status and can help you easily identify missing journal receivers.

```

Apply Journal Changes using BRMS
System: RCHAS400
Journal . . . . . : JRN2
Library . . . . . : JRNLIB
Auxiliary storage pool . . . : *SYSBAS

Press F16 to apply changes.
Press F3 or F12 to cancel.

Journal
Receiver  Library  Sequence  Status      Save      Save
          Date   Time
RCV001   JRNLIB   1         *SAVED      06/12/05  10:21:53
RCV002   JRNLIB   2         *SAVED      06/12/05  10:21:53
RCV003   JRNLIB   3         *SAVED      06/12/05  10:21:53
RCV004   JRNLIB   4         *SAVED      06/12/05  10:21:53
RCV005   JRNLIB   5         *ATTACHED

Bottom

Type command, press Enter.
===>
F4=Prompt  F5=Refresh  F9=Retrieve  F11=Show attach date/time  F12=Cancel
F16=Apply changes

```

Press F16 to apply the journaled changes.

Journaled File and Member Recovery

BRMS can assist you in the recovery of journaled libraries, files and members by recovering the associated journal if it does not exist on the system, recovering the corresponding journal receivers, and applying the journaled changes.

Note: BRMS will use *Recovery device *MEDCLS* when recovering journals and journal receivers during journaled object recovery.

This additional support is provided when recovering journaled files or members in user libraries using the Restore Object using BRM (RSTOBJBRM) command or the *Work with Saved Objects* display, or when recovering user libraries containing journaled files or members using the Restore Library using BRM (RSTLIBBRM) or the *Work with Media Information* display.

Note: In order for BRMS to store information about saved journals and journal receivers, you must specify *MBR for *Retain object detail* on the BRMS save command or backup control group attributes.

The extent to which BRMS performs this additional recovery when restoring a journaled object is dependent on the current attributes of the Recovery Policy or Restore Command Defaults. The default is for BRMS to take no action. You must explicitly indicate through the attributes of the Recovery Policy or Restore Command Defaults what additional recovery actions you want BRMS to take (see the *Apply journaled changes* prompt in section “Recovery Policy” on page 163).

The following outlines some restrictions on the BRMS capabilities regarding this additional recovery:

- BRMS will only apply/remove journaled changes to objects saved and restored on the local system (no FROMSYS support).
- BRMS will only apply/remove journaled changes to physical files and file members.
- BRMS will only apply/remove journaled changes for journals on the local system (no remote journal support).
- BRMS cannot apply/remove journal changes for objects restored to a different library than the saved library or to different object names.
- BRMS cannot apply/remove journal changes if journaling has not been started for the object.
- BRMS cannot restore journals and/or journal receivers, and apply/remove journal changes if the necessary object detail is not available. Saved journals and journal receivers must remain on the system until the backup job completes. In addition, if saved journals or journal receivers are removed from the system during the backup job, BRMS will not be able to retrieve information about these saved objects required to assist with applying/removing journal changes.

Recovering Individual Folders

You can restore folders that BRMS saved in documents by using the *ALLDLO special value on the STRRCYBRM command. However, you can only restore individual folders by using the Work with Saved Folders (WRKFLRBRM) command. Also, you can restore *individual folders* only if BRMS saved them with the *Retain Object Detail* parameter set to *YES, *OBJ, or *MBR.

Note: This command allows the user to manually select duplicate media to restore from, therefore the automatic selection of alternate input media as specified on the system policy will not affect restore operations initiated from this command.

To restore an individual folder by using BRMS, take the following steps:

1. Type WRKFLRBRM at a command line and press Enter.

```

Work with Saved Folders (WRKFLRBRM)

Type choices, press Enter.

Folder . . . . . *ALL

Select dates:
  From date . . . . . *BEGIN      Date, *BEGIN, *CURRENT, nnnnn
  To date . . . . . *END        Date, *END, *CURRENT, nnnnn
Save status . . . . . *ALL      *ALL, *ERROR, *NOERROR
Sequence option . . . . . *DATE  *DATE, *FLR
From system . . . . . *LCL
Output . . . . . *             *, *PRINT

Bottom
F3=Exit  F4=Prompt  F5=Refresh  F12=Cancel  F13=How to use this display
F24=More keys

```

2. Following are brief summaries of the key parameters on this display:
 - At the *Folder* parameter, indicate the name of the folder or subfolder that you want BRMS to restore. The default for this field is *ALL. You can also specify the name of an individual folder or a generic name, which indicates a range. You can also prompt a list of saved folders to choose from by pressing F4.
 - At the *Select date* parameter, specify a range of save dates from which BRMS should pull the folders that you want to restore. This instructs BRMS to restore items that were saved during a particular period.
3. Change the other parameters as necessary. Then press Enter to prompt a list of folders from which you can select the items you want to restore.

```

Work with Saved Folders                                RCHAS400

Position to save date . .

Type options, press Enter.
  4=Remove  5=Display  6=Work with media  7=Restore folder
  9=Work with saved objects

Opt  Folder                Save      Save      DLO      Not      Volume
     Date                 Time      Saved     Saved
7    QDIADOCs              6/23/05  11:09:59  4         0        SAM190
     QFOSDIA                6/23/05  11:09:59  0         0        SAM190
     QFOSDIA/MRI2924        6/23/05  11:09:59  4         0        SAM190
     QFPNTWE                6/23/05  11:09:59  3         0        SAM190
     QFPNTWE/NLS           6/23/05  11:09:59  0         0        SAM190
     QFPNTWE/NLS/0         6/23/05  11:09:59  1         0        SAM190
     QFPNTWE/NLS/1         6/23/05  11:09:59  1         0        SAM190
     QFPNTWE/NLS/10        6/23/05  11:09:59  1         0        SAM190
     QFPNTWE/NLS/11        6/23/05  11:09:59  1         0        SAM190
     QFPNTWE/NLS/12        6/23/05  11:09:59  1         0        SAM190
                                     More...

F3=Exit  F12=Cancel

```

4. Type a 7 (Restore folders) in front of the folders you want to restore and press Enter. This takes you to the Select Recovery Items display.

Select Recovery Items						RCHAS400
Type options, press Enter. Press F16 to select all.						
1=Select 4=Remove 5=Display 7=Specify document						
Opt	Folder	Save Date	Expiration Date	DLO Saved	Not Saved	Volume
1	QDIADOC	6/23/05	7/28/05	4	0	SAM190
						Bottom
F3=Exit F5=Refresh F9=Recovery defaults F12=Cancel						
F14=Submit to batch F16=Select all						

5. Type a 1 (Select) in front of the folders you want to restore and press Enter.
6. Press Enter to confirm the items you want to recover at the Confirm Recovery Items display.
7. Press Enter again to begin processing the command.
8. After the command completes, review the job log to make sure that your restore completed successfully.

Note: You can also use the Work with Saved Folders display to remove folder information from the media content information inventory. In addition, you can review folder detail from this display.

Recovering Spooled Files Saved with Output Queues

Beginning with V5R4M0, you can back up spooled files concurrently when saving output queues. Likewise, you can also restore these saved spooled files when restoring the output queue. BRMS does not automatically restore the saved spooled files when restoring output queues, you must specify this recovery option on the Restore Command Defaults display before you restore the output queue or the library containing the output queue.

Note: If your backup strategy is to always save spooled files with saved output queues and you always want to restore these spooled files when restoring the output queues, run the WRKPCYBRM TYPE(*RCY) command and change the *Restore spooled file data* prompt on the Change Recovery Policy display to *NEW.

If you want spooled files recovered with restored output queue, specify *NEW for the *Restore spooled file data* prompt on the Restore Command Default display before you restore the libraries or output queues.

Restore Command Defaults

Type information, press Enter.

```
Device . . . . . *MEDCLS      Name, *MEDCLS

Parallel device resources:
  Minimum resources. . . . . *SAV      1-32, *NONE, *AVAIL
  Maximum resources. . . . .          1-32, *AVAIL, *MIN
  End of tape option . . . . . *REWIND  *REWIND, *LEAVE, *UNLOAD
  Option . . . . . *ALL           *ALL, *NEW, *OLD, *FREE
  Data base member option . . . . . *ALL  *MATCH, *ALL, *NEW, *OLD
  Restore spooled file data . . . . . *NEW  *NONE, *NEW
  Allow object differences . . . . . *NONE

                                     *NONE, *ALL, *AUTL,
                                     *FILELVL, *OWNER, *PGP
```

More...

F12=Cancel

You can determine whether a saved library contains saved spooled file data by viewing the save information for the library. Use option 5 (display) to view the save information for the library. A value of *YES will be set for the *Saved spooled file data* prompt on the Display Save Information display if spooled files were saved with saved output queues.

Display Save Information

```
Auxiliary storage pool . . . . . : 01
Saved release . . . . . : V5R4M0
Target release . . . . . : V5R4M0
Save access paths . . . . . : *YES
Save contents of save files . . . . . : *YES
Saved spooled file data . . . . . : *YES
Compressed . . . . . : *NO
Compacted . . . . . : *NO
Reference date . . . . . :
Reference time . . . . . :
Object detail retained . . . . . : *YES
Successfully saved offline . . . . . : *NO
Save file name . . . . . : Q500653906
Save file library . . . . . : Q1ABRMSF01
Save file expiration date . . . . . : *PERM
Control group . . . . . : MYLISTSPCY
```

Press Enter to continue.

More...

F3=Exit F12=Cancel

Recovering Individual Spooled Files

You can use either the Work with Saved Spooled Files using BRM (WRKSPLFBRM) display or the WRKMEDIBRM command to restore spooled files. Though both commands work effectively, the WRKSPLFBRM command allows you a little more flexibility when you set up the restore.

To restore a spooled file by using the WRKSPLFBRM command, take the following steps:

1. Type WRKSPLFBRM at a command line and press F4.

```

Work with Saved Spooled Files (WRKSPLFBRM)

Type choices, press Enter.

Output queue . . . . . QPRINT      Name, *ALL
Library . . . . . QGPL          Name, *ALL
Auxiliary storage pool . . . . . *ALL      Name, 1-255, *ALL, *SYSTEM
File . . . . . *ALL          Name, *ALL
Job name . . . . . STRMNTBRM     Name, *ALL
User . . . . . *ALL          Name, *ALL
User data . . . . . *ALL       Character value, *ALL
Select dates:
  From date . . . . . *BEGIN     Date, *BEGIN, *CURRENT, nnnnn
  To date . . . . . *END       Date, *END, *CURRENT, nnnnn
Save status . . . . . *ALL      *ALL, *ERROR, *NOERROR
Sequence option . . . . . *DATE   *DATE, *FILE, *JOB
From system . . . . . *LCL
Output . . . . . *             *, *PRINT

Bottom
F3=Exit  F4=Prompt  F5=Refresh  F12=Cancel  F13=How to use this display
F24=More keys

```

2. Following are brief summaries of the key parameters on this display:
 - The *Output queue* has two elements, the *Output queue* field, and the *Library* field. In the *Output queue* field, specify the output queue that you want BRMS to display in the list. In the *Library* field, specify the name of the library that contains the spooled files that you want to review. The default value for each field is *ALL, though you can also indicate specific or generic names.
 - In the *Auxiliary storage pool* field, indicate the name of the ASP in which you placed the spooled files. The default value is *ALL, though specific or generic ASPs can be named.
 - In the *File* field, indicate the name of the printer file that contained the spooled file when BRMS saved it. You can use the default value of *ALL, or you can indicate a specific file name.
 - At the *Job name* parameter, specify the name of the job that created the spooled file you want to list. The default for this field is *ALL. You can also indicate the name of a specific job.
 - At the *Select date* fields, indicate a range of dates for the saved spooled files you want to review.
3. Change the other parameters as needed. Press Enter to prompt a list of spooled files from which to select the items you want to restore.

```

Work with Saved Spooled Files

Position to date . . . . 9/29/05

Type options, press Enter. Press F16 to select all for recovery.
  4=Remove  5=Display  6=Work with media  7=Restore spooled file

Opt Library  Outq   File      Job      User      Date      Time
QGPL        QPRINT  QP1AVER  STRMNTBRM BRMMAINT  9/29/05  0:00:21
QGPL        QPRINT  QP1AEAP  STRMNTBRM BRMMAINT  9/29/05  0:00:27
QGPL        QPRINT  QP1AMM   STRMNTBRM BRMMAINT  9/29/05  0:00:27
QGPL        QPRINT  QP1AHS   STRMNTBRM BRMMAINT  9/29/05  0:00:28
QGPL        QPRINT  QP1ALE   STRMNTBRM BRMMAINT  9/29/05  0:00:29
7 QGPL        QPRINT  QP1ARCY  STRMNTBRM BRMMAINT  9/29/05  0:00:38
QGPL        QPRINT  QP1A2RCY STRMNTBRM BRMMAINT  9/29/05  0:00:38
QGPL        QPRINT  QP1AASP  STRMNTBRM BRMMAINT  9/29/05  0:00:40
QGPL        QPRINT  QP1A2SL  STRMNTBRM BRMMAINT  9/29/05  0:00:41
QGPL        QPRINT  QP1AVER  STRMNTBRM BRMMAINT  9/30/05  0:00:10
QGPL        QPRINT  QP1AEAP  STRMNTBRM BRMMAINT  9/30/05  0:00:16
QGPL        QPRINT  QP1AMM   STRMNTBRM BRMMAINT  9/30/05  0:00:17
More...

F3=Exit  F12=Cancel  F16=Select all for recovery

```

4. At the Work with Saved Spooled Files display, type a 7 (Restore spooled file) in front of the spooled file you want to restore and press Enter. This takes you to the Select Recovery Items display

```

Select Recovery Items                                RCHAS400

Type options, press Enter. Press F16 to select all.
1=Select  4=Remove  5=Display

Opt Library   Outq      File      Job       User      Volume
1 QGPL        QPRINT    QP1ARCY   STRMNTBRM BRMMAINT  *ADSM

F3=Exit  F5=Refresh  F9=Recovery defaults  F12=Cancel
F14=Submit to batch    F16=Select all

Bottom

```

5. Type a 1 (Select) in front of the spooled file you want to restore. Press F16 to select all of the spooled files on the display.
6. Press Enter at the Confirm Recovery Items display to confirm the items you want to restore.
7. Press Enter to process the restore.
8. After the restore completes, review the job log to ensure that the job completed successfully.

Notes:

1. During the save/archive and restore process, prior to V5R4, BRMS keeps the spooled file attributes, file name, user name, user data field, and in most cases, the job name. i5/OS assigns a new job number, creation date, system date, and time of the restore operation. You cannot restore the original time and date. In V5R4 BRMS now saves all the spooled attributes when backed up. Once you have restored the output queue, you can use the WRKOUTQ OPTION(*PRINT) to spool the contents of the output queue. You may want to compare this report to the report you generated after the save.
2. When archiving spooled files in V5R4, BRMS still only keeps the spooled file attributes; file name, user name, user data field. The i5/OS still assigns a new job number, creation date, system date and time of the restore/retrieval option.
3. Internally, BRMS saves the spooled files as a single folder, with multiple documents (spooled members) within that folder. During the restore, it reads the tape label for the folder, and restores all of the documents. If your spooled file save spans multiple tape volumes, BRMS prompts you to load the first tape to read the label information before restoring the documents on subsequent tapes. Therefore, you should plan to save your spooled files on a separate tape by using the *LOAD exit in the control group. Or you can split your spooled files saves so that BRMS uses one tape at a time. This approach can help you during the recovery of spooled files.
4. This command allows the user to manually select duplicate media to restore from, therefore the automatic selection of alternate input media as specified on the system policy will not affect restore operations initiated from this command.

In addition to its restore capability, the Work with Saved Spooled Files display allows you to remove folder information from the media content information. You can also review save information, and work with the media that contains the saved spooled files from this display.

How to Perform Parallel and Concurrent Recoveries

You can recover data by using serial, concurrent, or parallel restore operations. If BRMS performed your saves as serial or concurrent backups, BRMS can restore them either serially or concurrently. On the other hand, however, you can perform parallel retrieves only if BRMS used a parallel operation to perform the save. Both concurrent and parallel restore operations require multiple tape drives.

Following are brief summaries of the characteristics of, and the differences between, serial, concurrent and parallel recoveries.

Serial Recovery

This straightforward recovery method is the simplest way to recover data that was saved by multiple control groups. In a serial recovery operation, BRMS issues one recovery job at a time to one tape drive. BRMS performs serial restores in a sequential manner, by restoring one tape and one control group after another. By default, BRMS considers every save and restore a serial operation unless otherwise specified by you.

Concurrent Recovery

In a concurrent recovery operation, you send multiple recovery jobs to multiple tape drives to process at the same time (concurrently). You, not BRMS, set up the concurrent recovery. To do this, try to evenly balance the size of the jobs so that they end at the same time. Concurrent recovery operations can reduce your down time after a system failure by allowing you to recover multiple libraries or objects at the same time.

Parallel Recovery

BRMS will restore a saved item sequentially. However, if the saved item was saved using **parallel save/restore** (spreading a single object), BRMS will use the number of resources you specify up to the number of resources used to save the item. A saved item cannot be restored using parallel recovery if the object was not saved using parallel.

To perform a parallel restore of a saved item from fewer resources that were used for the save, a media library is recommended because of the additional media mounts that may be required.

Recovering Multiple Control Groups with Concurrent Support

To perform a concurrent recovery, you need to run multiple jobs by using the STRRCYBRM command. Each command specifies the one or more items you want BRMS to recover. You must try to evenly balance the contents of the jobs so that they complete at about the same time. If you are using a media library with multiple drives, then BRMS will send the jobs there, as long as you specify that device in the recovery policy.

To process a concurrent restore with two or more stand-alone devices, you need to change the device name from the STRRCYBRM display before you can process the command. To make this change, take the following steps:

1. Set up the parameters on the STRRCYBRM command as needed. Then press Enter to prompt the Select Recovery Items display.

```

Select Recovery Items                                RCHAS400

Select action . . . . . : *ALL
Select volume . . . . . :

Type options, press Enter.
1=Select  4=Remove  5=Display  7=Specify object

  Saved      Save      Save      Save      Parallel Volume   File      Expire
Opt Item    Date      Time     Type     Devices  Serial   Sequence  Date
1 LIB20     7/28/05  9:30:33 *FULL
1 LIB21     7/28/05  9:30:45 *FULL          SAM192      126    9/01/05
                                     SAM192      127    9/01/05

F3=Exit  F5=Refresh  F9=Recovery defaults  F11=Object View
F12=Cancel  F14=Submit to batch  F16=Select

Bottom

```

2. From this display, press F9 (Recovery defaults) to change the device information. This takes you to the Restore Command Defaults display.

```

Restore Command Defaults

Type information, press Enter.

Device . . . . . TAP01      Name, *MEDCLS
                TAP02

Parallel device resources:
  Minimum resources. . . . . *SAV      1-32, *NONE, *AVAIL
  Maximum resources. . . . .           1-32, *AVAIL, *MIN
  End of tape option . . . . . *REWIND *REWIND, *LEAVE, *UNLOAD
  Option . . . . . *ALL          *ALL, *NEW, *OLD, *FREE
  Data base member option . . . . . *ALL  *MATCH, *ALL, *NEW, *OLD
  Restore spooled file data . . . . . *NONE *NONE, *NEW
  Allow object differences . . . . . *NONE

                *NONE, *ALL, *AUTL,
                *FILELVL, *OWNER, *PGP

F12=Cancel

More...

```

3. To concurrently process multiple jobs on different stand-alone devices, you need to type the names of each of the devices you want to use in the *Device* fields. If a stand-alone you specify is unavailable, the job fails because there is no queuing on stand-alone devices.
4. Press Enter to twice process the command.

Performing Parallel Recoveries

Though you can find the parallel support parameters on the recovery policy display, you probably do not want to select the parallel option from this display. This is because the recovery policy sets the defaults for all of your recoveries, and you cannot perform all of your recoveries with parallel support. Therefore, the best way for you to use the parallel option is to take the following steps:

1. Set the *Option* field on the STRRCYBRM command to *CTLGRP.
2. Set the *Action* field to *RESTORE.
3. Indicate the control group you want BRMS to process with parallel support in the *Control group* field.
4. Press Enter to prompt the Select Recovery Items display.

5. Select the items you want BRMS to recover and press F9 to prompt the Restore Command Defaults display.

```

Restore Command Defaults

Type information, press Enter.

Device . . . . . *MEDCLS      Name, *MEDCLS

Parallel device resources:
  Minimum resources. . . . . *SAV      1-32, *NONE, *AVAIL
  Maximum resources. . . . .          1-32, *AVAIL, *MIN
  End of tape option . . . . . *REWIND *REWIND, *LEAVE, *UNLOAD
  Option . . . . . *ALL          *ALL, *NEW, *OLD, *FREE
  Data base member option . . . . . *ALL *MATCH, *ALL, *NEW, *OLD
  Restore spooled file data . . . . . *NONE *NONE, *NEW
  Allow object differences . . . . . *NONE
                                           *NONE, *ALL, *AUTL,
                                           *FILELVL, *OWNER, *PGP

More...

F12=Cancel

```

6. Use the *Device* fields to identify specific devices you want to use.
7. Specify the maximum and minimum devices that you want to allocate to the parallel job at the *Parallel device resources* parameter. The recommended value for this parameter is *SAV. This value instructs BRMS to use the same number of resources for the parallel restore as it used to perform parallel save. You can specify *SAV at the *Minimum resources* parameter. In addition to *SAV, the possible values are:
 - *Minimum device resources* can be *AVAIL (use any available devices), or any number between 1 and 32.
 - *Maximum device resources* can be *MIN (the same value specified in the *Minimum device resource* field), *AVAIL, or any number between 1 and 32.
8. After you review and change the parameters as needed, press Enter twice to process the command.

Performing a Recovery without the Recovery Analysis Report

Though you should not try to restore your system without a recovery report to guide you, circumstances may arise that necessitate doing so. This section provides information that can assist you in performing a recovery without the reports. It also tells you how you might be able to generate a report in the event of disaster if you do not have one available. If you cannot locate a recovery report, i5/OS commands can help initiate the recovery process. You can use either BRMS or i5/OS commands to perform the restore.

Identifying the Tapes you Need

Identifying the tapes you need to make the recovery is more difficult without the reports. You can identify the data on your tapes by taking them to another iSeries and using the Display Tape (DSPTAP) command to review the contents of each tape. You can manually develop a recovery plan with the information shown on the DSPTAP command. At this point, you should consider making a list that prioritizes the items you want BRMS to restore.

Generating a Recovery Analysis Report after a Failure

If you can locate the tape containing the most up-to-date QUSRBRM data files, you can use this tape to generate a Recovering Your Entire System/Recovery Analysis report. BRMS saves the QUSRBRM recovery at the end of every save operation.

After you obtain the most up-to-date QUSRBRM tape, take the following steps to begin the restoration process:

1. Restore the Licensed Internal Code, operating system, and the required BRMS libraries from your backup tapes. The BRMS libraries you need include QBRM, QUSRBRM, QMSE, and, if applicable, information from save files.
2. Run the RSTOBJ(*ALL) SAVLIB(QUSRBRM) MBROPT(*ALL) command with the most up-to-date tapes you can find. Or you can run this command from save files that contain the QUSRBRM recovery files. This is the last QUSRBRM library on the tape. It should contain 14 files.
3. Run the STRRCYBRM command to generate an up-to-date Recovery Analysis report.
4. Run the WRKMEDBRM TYPE(*ACT) OUTPUT(*PRINT) command to generate a list of active media and their current status and location.
5. Use these reports to restore your system. You can only use the tapes that are listed on the reports to restore the licensed internal code, operating system data, and the BRMS libraries. If you used different tapes, then you need to restore these items again, this time with the tapes BRMS identifies.

Using the Recovery Planning and Activity Displays

BRMS provides a display that allows you to create a detailed list of the very specific steps your organization may need to take in case of disaster recovery. BRMS also provides a display on which to list the names of the people that are associated with the steps on the list. You must use these displays in conjunction with, rather than in place of, the recovery reports you print after each save.

Creating a Recovery Contact List

To get to the BRMS recovery planning and activity displays, take the following steps:

1. Type GO BRMRCYPLN at a command line and press Enter. This takes you to the Recovery Planning menu.

```
BRMRCYPLN                Recovery Planning                System:  RCHAS400
Select one of the following:
    1. Work with recovery policy
    2. Work with recovery contacts
    3. Work with recovery activities
    4. Print recovery activities
    5. Print recovery analysis

Selection or command
===> 2

F3=Exit  F4=Prompt  F9=Retrieve  F10=Commands  F12=Cancel  F13=Functions
```

2. Select option 2 and press Enter to go to the Work with Recovery contacts display .

```

Work with Recovery Contacts                                RCHAS400
Position to . . . . . Starting characters
Type options, press Enter.
  1=Add 2=Change 4=Remove 5=Display
Opt  Recovery contact      Telephone number
  1   Jane Doe
F3=Exit  F5=Refresh  F12=Cancel

```

3. To add a recovery contact the list, type a 1 in the *Opt* column and the contact name in the *Recovery contact* field.
4. Then press Enter to access the remaining contact information.

```

Add Recovery Contact
Type information, press Enter.
Recovery contact. . . . . Jane Doe
Telephone number. . . . . 123-4567
Contact information . . . . .
F3=Exit  F12=Cancel

```

5. In the *Contact* information field, the name of the contact you added appears. On the other fields, add additional relevant contact information such as office location, department name, phone number, and title.
6. Press Enter to add the name to the Recovery Contact list. Once you have completed the list, you can access it again at any time to add, change, remove or display contact names as needed.

Creating a Recovery Activities List

The BRMS recovery activity displays provide a point of reference when performing disaster recovery. The steps you list on the activity displays should be very specific, as in the following example.

Note: Before you can create a recovery activities list, BRMS requires that you create the contact list.

To get to the Work with Recovery Activities display, take the following steps:

1. Type GO BRMRCYPLN at a command line and press Enter. This takes you to the Recovery Planning menu.
2. Select option 3 and press Enter to go to the Work with recovery activities display.

```

Work with Recovery Activities                                RCHAS400

Position to . . . . . Starting characters

Type options, press Enter.
 1=Add  2=Change  3=Copy  4=Remove  5=Display
 9=Change recovery information

Opt  Activity      Seq  Text
 1   Hardware failure

F3=Exit  F5=Refresh  F12=Cancel  F15=Sort sequence

```

3. To create a recovery activity, place a 1 in the *Option* field, followed by an activity name in the *Activity* field. This might be the abbreviation of a department name. Then press Enter to get to the Add Recovery Activities display.

```

Add Recovery Activity

Type information, press Enter.

Activity . . . . . Hardware failure
Recovery contact one. . . . . John Hernandez          F4
Recovery contact two. . . . . Michelle Syska          F4
Recovery contact three. . . . . Kristen Taylor          F4
Recovery contact four . . . . .                          F4
Recovery contact five . . . . .                          F4
Activity sequence . . . . . 1                               1-999
Text . . . . . Resolve hardware related failures

F3=Exit  F4=Prompt  F12=Cancel

```

4. At this display, you can provide contact detail information to match each activity.

Note: By placing your cursor and pressing Enter on any *Recovery contact* field on this display, you can select a name from the list of contact names you created earlier.
5. Press Enter to return to the Work with Recovery Activities display. Complete and add contact names to the list as required.

Creating recovery contact and activity lists can be time-consuming. Only you can best assess the relationship between the time it takes to create them and the value that is gained by your organization.

You can print copies of your recovery activity lists by using the menu options available on the Recovery Planning menu.

Additional BRMS Restore Commands

In addition to the commands discussed earlier in this chapter, BRMS provides other commands that can assist you in the recovery of various items. You should use these commands instead of the i5/OS restore commands because the BRMS commands log restore information.

Note: If the media for the restore operation is not found, and the system policy allows the use of alternate input media, BRMS will attempt to locate and use a duplicate volume to complete the restore for the all the following commands except RSTAUTBRM.

BRMS Commands	Command Description
RSTBRM	The Restore Object using BRM command restores a copy of one or more objects for use in the Integrated File System. The RSTBRM command functions similarly to the i5/OS RST command.
RSTDLOBRM	The Restore DLO using BRM command allows you to restore documents, folders, and distribution objects (mail) that BRMS saved by using the SAVDLOBRM command. The RSTDLOBRM command functions similarly to the i5/OS RSTDLO command.
RSTLIBBRM	The Restore Library using BRM command allows you to restore up to 50 libraries from BRMS media content information. You can use the RSTLIBBRM command to restore any library that BRMS saved with the Save Library using BRM (SAVLIBBRM) command. You can also use the RSTLIBBRM command to restore libraries that BRMS saved in a control group. The RSTLIBBRM command functions similarly to the i5/OS RSTLIB command.
RSTOBJBRM	The Restore Object using BRM command allows you to restore a copy of up to 50 objects from a specified library. You can use the RSTOBJBRM command to restore any object that you saved with the Save Object using BRM (SAVOBJBRM) command. You can also use the RSTOBJBRM command to restore objects that BRMS saved in a control group. The RSTOBJBRM command functions similarly to the i5/OS RSTOBJ command.
RSTAUTBRM	The Restore Authority using BRM (RSTAUTBRM) command reestablishes the owner profiles, primary groups, and authorization list names for objects on basic user auxiliary storage pools (2–32) if this information was saved. This information is saved unless it was explicitly omitted from the save by specifying *USRASPAUT as the omit for either a *SAVSYS or *SECDTA entry in the backup policy omit list.

Note: The RSTAUTBRM command does not replace the i5/OS RSTAUT command. RSTAUTBRM is used in addition to the RSTAUT command when restoring the authority information of saved basic user auxiliary storage pool objects during a system recovery.

Chapter 9. Daily Maintenance in BRMS

The BRMS maintenance function regularly and automatically cleans and updates media records. Regular removal of expired records from media and media content information files allows you to make more efficient use of your media. The center point of the BRMS maintenance function is the Start Maintenance for BRM (STRMNTBRM) command, which processes the daily maintenance requirements that keep your system running effectively.

You can run maintenance as part of a backup using the BRMS iSeries Navigator client. For detailed information on the BRMS iSeries Navigator client, see the iSeries Information Center.

What the STRMNTBRM Command Does

The STRMNTBRM command provides assistance for a variety of housekeeping and maintenance tasks, and also produces useful reports that are based on your media information. IBM recommends that you run this command each day after the last save has completed. You can place this command on an automatic scheduler or in the last *EXIT entry in the last control group used to process your backup. Instructions to do this are provided later in this chapter. In either case, it is important that the STRMNTBRM command be run after the save of the BRMS media information. Failure to do so will result in an inaccurate recovery report.

The STRMNTBRM command works by processing existing commands, such as the STREXPBRM and WRKMEDBRM commands. It also performs unique tasks that are specified on the STRMNTBRM command.

```
Start Maintenance for BRM (STRMNTBRM)

Type choices, press Enter.

Expire media . . . . . *YES      *YES, *NO
Expire media set volumes . . . . *NO      *NO, *YES
Remove media information:
  Media contents . . . . . *EXP      *EXP, *NONE, *REUSE
  Object level detail . . . . . *MEDCON  1-9999, *MEDCON
Remove migration information . .  180     1-9999, *NONE
Run media movement . . . . . *NO      *NO, *YES
Remove log entries:
  Type . . . . . *ALL      *ALL, *NONE, *ARC, *BKU, *M...
  From date . . . . . *BEGIN    Date, *BEGIN, *CURRENT, nnnnn
  To date . . . . . 90        Date, *END, *CURRENT, nnnnn
Run cleanup operations . . . . . *YES     *YES, *NO
Retrieve volume statistics . . .  *YES     *YES, *NO
Audit system media . . . . . *NONE
      + for more values
Change BRM journal receivers . . *YES     *YES, *NO

More...
F3=Exit  F4=Prompt  F5=Refresh  F12=Cancel  F13=How to use this display
F24=More keys
```

Start Maintenance for BRM (STRMNTBRM)

Type choices, press Enter.

Print expired media report . . .	*YES	*YES, *NO
Print version report	*EXPMED	*EXPMED, *NO, *YES
Print media information	*YES	*YES, *NO
Print recovery reports	*ALL	*ALL, *NONE, *RCYACT...
+ for more values		
Recovery locations	*ALL	Name, *ALL, *HOME
+ for more values		
Print system information	*NO	*NO, *YES
Reorganize BRMS database	*NO	*NO, *YES
Auto-retrieved objects:		
Refree	*NO	*NO, *YES

Bottom

F3=Exit F4=Prompt F5=Refresh F12=Cancel F13=How to use this display
F24=More keys

The STRMNTBRM command can perform the following tasks and prints the following reports when processed:

- Expires media.
- Removes history records for expired media.
- Produces a report that lists expired media.
- Determines which, if any, libraries did not save.
- Produces a report on recovery activities (contact information).
- Collects volume error statistics and updates volume error logs.
- Cleans up any temporary files that are left over from prior operations.
- Cleans or changes journal receivers as needed and attaches new ones. Deletes old journal receivers that are based on the information in Q1APRM data area. The default is to keep the information for five days.
- Performs media movement (if specified).
- Optionally reorganize the BRMS databases so that the deleted records in the files are removed to minimize the BRMS storage requirements on the local system.

The key reports run by the STRMNTBRM command are:

Backup Activity Report

This report identifies libraries and objects that were not saved. Use it to look for errors in your save operation and take action as appropriate.

Save Strategy Exceptions Report

Use this report to see which libraries, if any, were not saved, and to help you devise save strategies for them. If the report indicates that BRMS did not save a library already in a control group, you need to investigate why the error occurred.

Note: You can also run the WRKMEDIBRM SAVTYPE(*NONE) command to see a list of unsaved libraries.

BRMS Recovery Reports

The STRMNTBRM command can produce any number of the three essential recovery reports (Recovery Analysis, Volume Summary, and ASP Recovery). If desired, you can make this request from the *Print recovery reports* parameter.

Centralized Media Audit Report

The STRMNTBRM command produces this report for each system in a network. BRMS does not generate this report if you have a single-system environment. See Chapter 14, “Networking with BRMS,” on page 237, for more information on this report.

Tape Volume Report, Volume Threshold Report, and Volume Statistics Report

The STRMNTBRM command generates these reports automatically. These reports show volumes that have equalled or exceeded the usage or read/write threshold limits that are set for the media class. Check these error thresholds and take appropriate action to replace volumes with errors.

Following is a summary of the commands that can be automatically processed by the STRMNTBRM command. You can also process these commands individually if desired.

- MOVMEDBRM = Runs media movement.
- RMVLOGEBRM = Removes BRMS log entries.
- RMVMEDIBRM = Removes media information from BRMS.
- STREXPBRM = Starts expiration for BRMS.
- STRRCYBRM = Runs the Recovery Analysis/Recovering Your Entire System, Volume Summary and ASP analysis reports.
- WRKMEDBRM = Runs the Expired media report.
- WRKMEDIBRM = Generates a media information summary report.
- WRKRKYBRM = Runs Recovery activities report.

Because the STRMNTBRM command processes so many commands and reports, IBM strongly recommends that you review and select each of the parameters on the STRMNTBRM command very carefully. You can review complete descriptions of all of the parameters on the STRMNTBRM command by using the online help that is available for each parameter on the command.

To review the STRMNTBRM display, type STRMNTBRM at a command line and press F4 to prompt the display.

Scheduling the STRMNTBRM Command

You can process the STRMNTBRM command manually, or you can schedule it to run automatically at selected dates and times. You can process the STRMNTBRM command through either of the IBM Advanced Job Scheduler for i5/OS, or through a user-defined scheduler.

To schedule the STRMNTBRM command on the i5/OS job scheduler, take the following steps:

1. Enter the ADDJOBSCDE command from any command line. This retrieves the Add Job Schedule Entry (ADDJOBSCDE) display.
2. Type STRMNTBRM in the *Command to run* field of the ADDJOBSCDE display.

```

Add Job Schedule Entry (ADDJOBSCDE)

Type choices, press Enter.

Job name . . . . . > BRMMAINT      Name, *JOBBD
Command to run . . . . . > STRMNTBRM

Frequency . . . . . > *WEEKLY      *ONCE, *WEEKLY, *MONTHLY
Schedule date . . . . . > *NONE     Date, *CURRENT, *MONTHSTR...
Schedule day . . . . . > *ALL       *NONE, *ALL, *MON, *TUE...
      + for more values
Schedule time . . . . . > '00:01:00' Time, *CURRENT

Bottom
F3=Exit  F4=Prompt  F5=Refresh  F10=Additional parameters  F12=Cancel
F13=How to use this display  F24=More keys

```

3. Then press F4 to prompt the STRMNTBRM display.

```

Start Maintenance for BRM (STRMNTBRM)

Type choices, press Enter.

Expire media . . . . . *YES        *YES, *NO
Expire media set volumes . . . . *NO        *NO, *YES
Remove media information:
  Media contents . . . . . *EXP        *EXP, *NONE, *REUSE
  Object level detail . . . . . *MEDCON    1-9999, *MEDCON
Remove migration information . . . 180        1-9999, *NONE
Run media movement . . . . . *NO        *NO, *YES
Remove log entries:
  Type . . . . . *ALL        *ALL, *NONE, *ARC, *BKU, *M...
  From date . . . . . *BEGIN      Date, *BEGIN, *CURRENT, nnnnn
  To date . . . . . 90          Date, *END, *CURRENT, nnnnn
Run cleanup operations . . . . . *YES        *YES, *NO
Retrieve volume statistics . . . . *YES        *YES, *NO
Audit system media . . . . . *NONE
      + for more values
Change BRM journal receivers . . . *YES        *YES, *NO

More...
F3=Exit  F4=Prompt  F5=Refresh  F12=Cancel  F13=How to use this display
F24=More keys

```

4. Review and change the remaining parameters as needed.
5. Press Enter to save and return to the Add Job Schedule Entries display.
6. At the ADDJOBSCDE display, indicate the job name, frequency, date, day, and time you want BRMS to process the STRMNTBRM command.
7. Press Enter to add the job to the scheduler.

Note: For additional information on using and setting up job scheduler with BRMS, review "Chapter 10. Scheduling Backup and Recovery Jobs."

Processing the STRMNTBRM Command in a Backup Control Group

You can also set the STRMNTBRM command to run as the last step on the last backup control group of the day. You can do that by submitting a batch job that uses an *EXIT in the backup control group. To put the command in an exit, take the following steps:

1. Type WRKCTLGBRM at a command line and press Enter.

2. You can add an *EXIT to an existing control group, or you can create an entirely new control group. As appropriate, go to either the Create Backup Control Group Entries display (option 1), or to the Edit Backup Control Group Entries display (option 2).
3. Type *EXIT in the *Backup items* field as the last entry in the control group. Place your cursor on the word *EXIT and press F11 (Display exits).
4. Then press F10 (Change item). This takes you to the User Exit Maintenance display.

```

User Exit Maintenance                                RCHAS400

Type command, press Enter.

Sequence number . . . . . : 70
Where used . . . . . : *EXIT
Weekly activity . . . . . : *DFTACT SMTWTFS
Command . . . . . : STRMNTBRM

...

F3=Exit  F4=Prompt  F12=Cancel

```

5. At this display, type STRMNTBRM in the *Command* field and press Enter. The STRMNTBRM command will now process at the end of this control group.

To ensure that the STRMNTBRM does not process until the control group has completed, you should hold the batch job queue for the duration of the control group processing. Use the Change Control Group Attributes display to hold the batch job queue.

Notification of Failure to Process STRMNTBRM

If the STRMNTBRM command fails to process, BRMS sends error messages to the following locations:

- The BRMS log. Use the DSPLOGBRM command to view the entries in this log.
- The message queue specified in the BRMS system policy.

To view the current setting:

1. Type GO BRMSYSPCY, then press Enter.
2. Select Option 6 — Change notification controls, then press Enter

To view the messages use the command WRKMSG MSGQ(library-name/message-queue-name).

If a processing error occurs, review the messages and take action as needed.

Chapter 10. Scheduling Backup and Recovery Jobs

You can run many of the functions that are performed by BRMS under the control of a job scheduler. For example, you can schedule daily backups to begin after nightly processing, and schedule the MOVMEDBRM or STRMNTBRM commands to run after the saves complete. You can also schedule jobs to run across networks. And, as discussed in Chapter 7, "Tailoring Your Backup," on page 109 you can also use the console monitor to schedule an unattended save.

While this chapter provides some information on the IBM Advanced Job Scheduler for i5/OS, it assumes primary use of the i5/OS job scheduler. For additional information about how to use the i5/OS job scheduler, refer to *Work Management*, SC41-5306-03. For additional information about how to use the IBM Advanced Job Scheduler for i5/OS, refer to *Job Scheduler for OS/400*, SC41-5324-00.

Many of the features in this chapter are available using the BRMS iSeries Navigator client. For detailed information on the BRMS iSeries Navigator client see the iSeries Information Center.

Scheduling Backup and Recovery Jobs

To access the BRMS scheduling menu, select option 10 (Scheduling) from the main BRMS menu.

```
BRMSCD                      Scheduling                      System:  RCHAS400
Select one of the following:
    1. Work with all BRM scheduled jobs
    2. Work with all scheduled jobs
    3. Change job scheduler

Selection or command
====>

F3=Exit  F4=Prompt  F9=Retrieve  F10=Commands  F12=Cancel  F13=Functions
```

You can access the BRMS scheduling commands and tasks by using the menu options or by commands. This chapter emphasizes the use of commands.

Scheduling Control Group Backups

The Work with Control Groups (WRKCTLGBRM) display makes it easy to schedule backups by providing a direct interface to the i5/OS job scheduler. To schedule a control group backup, perform the following steps:

1. Type WRKCTLGBRM at a command line and press Enter.

```

Work with Backup Control Groups                                RCHAS400
Position to . . . . . Starting characters
Type options, press Enter
1=Create 2=Edit entries 3=Copy 4=Delete 5=Display
6=Add to schedule 8=Change attributes 9=Subsystems to process ...
Control Media Media Weekly
Opt Group Policy Policy SMTWTFS Text
*BKUGRP *BKUPCY *BKUPCY *BKUPCY Backs up all user data
*SYSGRP SAVSYS SAVSYS *BKUPCY Backs up all system data
6 *SYSTEM FMT3590H FMT3590H *BKUPCY Backs up the entire system
  QLTSDOM00 QLTSSVR QLTSSVR *BKUPCY Lotus server 1
  QLTSDOM01 QLTSSVR QLTSSVR *BKUPCY Lotus server 2
  QLTSSVR QLTSSVR QLTSSVR *BKUPCY Online backup of all Lotus ser
More...
F3=Exit F5=Refresh F7=Work with BRM scheduled jobs
F9=Change backup policy F23=More options F24=More keys

```

2. At the Work with Control Groups display, place a 6 (Add to Schedule) in front of the control groups you want to schedule and press Enter. This takes you to the Add Job Schedule Entry (ADDJOBSCDE) display.

```

Add Job Schedule Entry (ADDJOBSCDE)
Type choices, press Enter.
Job name . . . . . > QBRMBKUP Name, *JOBID
Command to run . . . . . > STRBKUBRM CTLGRP(*SYSTEM) SBMJOB(*NO)

Frequency . . . . . > *WEEKLY *ONCE, *WEEKLY, *MONTHLY
Schedule date . . . . . > *NONE Date, *CURRENT, *MONTHSTR...
Schedule day . . . . . > *ALL *NONE, *ALL, *MON, *TUE...
+ for more values
Schedule time . . . . . > '00:01' Time, *CURRENT
More...
F3=Exit F4=Prompt F5=Refresh F10=Additional parameters F12=Cancel
F13=How to use this display F24=More keys

```

```

Add Job Schedule Entry (ADDJOBSCDE)

Type choices, press Enter.

Additional Parameters

Text 'description' . . . . . > 'Entry created for BRMS job.'

Bottom
F3=Exit   F4=Prompt  F5=Refresh  F10=Additional parameters  F12=Cancel
F13=How to use this display  F24=More keys

```

The *Command to run* field identifies the command that processes the control group you added to the scheduler. In this case, BRMS uses the STRBKUBRM CTLGRP(*SYSTEM) SBMJOB(*NO) command.

3. At the *Scheduled time* parameter, specify the time on the scheduled date that you want the job submitted.
4. Review or change the other parameters as needed.
5. Press Enter to apply your changes.

Precautions when Scheduling Customized Weekly Activity

If you customize control group weekly activity and also schedule backups late at night, you need to make sure the backup completes before the start of the next day. Scheduling delays could cause the backup control group to run later than scheduled resulting in missed saves. Assume the following backup control group is schedule to run nightly at 23:00.

```

Display Backup Control Group Entries                RCHAS400

Group . . . . . : SAMPLE
Default activity . . . . . : *BKUPCY
Text . . . . . : Create sample backup control group

Seq  Backup  List  Auxiliary  Weekly  Retain  Save  SWA
     Items  Type  Storage   Activity Object  While  Message
     10 *EXIT                *SYSBAS  F      *NO   *NO
     20 LIB1                *SYSBAS  F      *NO   *NO
     30 LIB2                *SYSBAS  F      *NO   *NO
     40 *EXIT                *DFTACT

Bottom

Press Enter to continue.

F3=Exit   F11=Display exits  F12=Cancel  F14=Display client omit status

```

Suppose that the job scheduler submits the control groups to the same job queue that is used by the month-end batch job such that this backup control group does not start running on Saturday night as 23:00, but on Sunday morning as 00:00:03. When the backup starts to run, BRMS will retrieve the current date and since it is Sunday instead of Saturday the following occurs:

- | • LIB1 is **Not** saved.
- | • A **full** rather than incremental LIB2.
- | You can easily avoid these problems by ensuring the batch job queue allows more than one job to process, or use different batch job queues.

Scheduling Backups of BRMS Save Commands

You can also schedule backups of individual libraries, objects, and document library objects (DLOs) through individual BRMS commands. To schedule individual items for backup, add any of the following commands to the *Command to run* parameter on the Add Job Schedule Entries display:

- Use the SAVLIBBRM command to schedule the save of a library.
- Use the SAVOBJBRM command to schedule the save of an object.
- Use the SAVDLOBRM command to schedule the save of a DLO.
- Use the SAVBRM command to schedule the save of an Integrated File System object.

Scheduling Selected Recovery Items

While you cannot run the Start Recovery using BRM (STRRCYBRM) *RESTORE command from the job scheduler, you can schedule selected recoveries. You can schedule selected recoveries in the same way that you schedule individual save items. You can also schedule the STRRCYBRM *REPORT command to generate reports.

To schedule selected recoveries, add any of the following commands to the *Command to run* parameter on the Add Job Schedule Entries display:

- Use the RSTLIBBRM command to restore selected user or system libraries.
- Use the RSTOBJBRM command to restore specify objects.
- Use the RSTDLOBRM command to restore documents and folders.
- Use the RSTBRM command to restore Integrated File System objects.

These commands can restore the latest copy of the selected items. You can schedule these commands to run in batch mode.

Working with Scheduled Jobs

To work with BRMS jobs that are already added to the scheduler, press F7 from the Work with Control Groups display. This will take you to the Work with BRM Schedule Job Entries display. You can also access the Work with BRM Schedule Job Entries by taking option 1 (Work with all BRM scheduled jobs) from the BRMS Scheduling display.

```

Work with Job Schedule Entries                                RCHAS400
                                                           10/23/05 14:47:11

Type options, press Enter.
 2=Change  3=Hold  4=Remove  5=Display details  6=Release
 8=Work with last submission  10=Submit immediately

Opt Job      Status  -----Schedule----- Frequency  Recovery  Next
      Job      SCD    Date      Time      *WEEKLY   *SBMRLS   Submit
      QBRMBKUP  SCD    *ALL      00:18:00 *WEEKLY   *SBMRLS   10/23/05
      BRMMAINT  SCD    *ALL      00:01:00 *WEEKLY   *SBMRLS   10/24/05

Parameters or command                                     Bottom
====>
F3=Exit  F4=Prompt  F5=Refresh  F6=Add  F9=Retrieve
F11=Display job queue data  F12=Cancel  F17=Top  F18=Bottom

```

The Work with BRM Job Schedule Entries display allows you to change, hold, remove, work with, or release scheduled jobs. It is similar to the i5/OS Work with Job Schedule display, but provides fewer options. You can, however, add a new job to the schedule by pressing F6, which will take you to the Add Job Schedule Entry display. Also note that if you choose option 4 (Remove) a confirmation display does not appear and the selected entries are immediately removed.

To review or work with **all** scheduled jobs, take option 2 (Work with all scheduled jobs) from the BRMS Scheduling menu.

Keeping Job Log Information

You can also review scheduled jobs through the job log display. The i5/OS job scheduler has a function that allows you to work with the last submission details of scheduled jobs, which allows you to display the job log. The job log may contain useful information regarding BRMS scheduled jobs.

When submitting jobs using the job scheduler, use the default job description for the user profile (*USRPRF). In most cases, the job scheduler deletes the job log after the job has ended. This prevents you from viewing the job log for scheduled jobs that use the work with last submission option.

If you desire or require the job log information for scheduled jobs, specify a job description that contains LOG(4 00 *SECLVL). To specify this new job description, press F10 (Additional parameters) on the Add Job Schedule Entry (ADDJOBSCDE) display and type the job description at the JOB keyword.

For scheduled jobs you plan to submit once (FRQ=*ONCE), you should also use the SAVE(*YES) keyword. This will ensure that submission details are available if you need to check at a later stage.

If you are using Job Scheduler for iSeries, change the job description to LOG(4 00 *SECLVL).

Changing the Job Scheduler

The Change Job Scheduler (CHGSCDBRM) command allows you to change the job scheduler that is used by BRMS to schedule the requested backups or recoveries. If you use the default (*SYSTEM) job scheduler (the i5/OS job scheduler), you can use the defaults that are provided on the Change Job Scheduler (CHGSCDBRM) display. On this display, you can specify whether to prompt the add, change or select command.

Change Job Scheduler (CHGSCDBRM)

Type choices, press Enter.

```
Scheduler type . . . . . TYPE          *SYSTEM
Add a job command . . . . . ADDCMD     *SYSTEM _____
_____
_____
_____
_____
```

```
Command prompt for add . . . . . ADDPMT      *NO
```

More...

F3=Exit F4=Prompt F5=Refresh F12=Cancel F13=How to use this display
F24=More keys

Several of the parameters require further definition:

- **Scheduler type:** The default value for scheduler type is *SYSTEM, which is the standard i5/OS job scheduler. If you want to specify the Job Scheduler for iSeries, select the *IJS special value that was created specifically for the Job Scheduler for iSeries. For any other scheduler, you need to specify the *USRDFN (User-defined) value.
- **Add job command:** Here you can change the command that is used to add a scheduled item to the job scheduler. BRMS uses the add command that you change to interface with the add function of the scheduler. To add a control group to the job scheduler from the Work with Backup Control Groups display, type a 6 (Add to schedule) in the *Opt* column. If you are using the *SYSTEM default values that are supplied with BRMS, you will see the ADDJOBSCDE command that is used by the i5/OS scheduler. If you are using Job Scheduler for iSeries, you will see the ADDJOBJS command. If you changed the add function at the *Add a job command* parameter, you can review it in the *Add a job command* field.

Note: If you specified *NO at the *Command prompt for add* prompt, then you will remain at the Work with Backup Control Groups display. The job scheduler will process the job.

- **List jobs command:** Use this command to list jobs that are scheduled in the job scheduler. BRMS uses the list command that you change to interface with the list function of the scheduler. For example, if you are at the Scheduling menu and you want to list all jobs in the job scheduler, take menu option 2 (Work with all scheduled jobs). If you are using the default values that are supplied with BRMS, you see the WRKJOBSCDE command that is used by the i5/OS scheduler. If you are using Job Scheduler for iSeries, you will see the WRKJOBJS command. If you have changed the list function by using the **List jobs command** parameter, you will see the list command that you specified.
- **Select jobs command:** You can change the command that is used to select jobs from the job scheduler. BRMS uses the select command that you change to interface with the select function of the scheduler. For example, if you are at the Scheduling menu and you want to select all BRMS jobs in the job scheduler, take menu option 1 (Work with all BRM scheduled jobs). If you are using the default values that are supplied by BRMS, you will see the Work with BRM Job Schedule Entries display. If you change the select function by using the **Select jobs command** parameter, the display you specified will appear.

Some Notes on Substitution Variables

You can specify substitution variables in any of the command strings that are used on the CHGSCDBRM command parameters that are described above. The information BRMS passes to the substitution variables depends on the BRMS function you are using. The variables are:

- **&JOBNAME** - BRMS assigns an identifier to every job: QBRMBKUP.
- **&REQUEST** - Submit the full BRMS command to the scheduler. Use the STRBKUBRM or STRARCBRM command with parameters (if applicable).
- **&APPL** - Always contains BRMS identifier that is assigned to every job. This can be used to assist a non-IBM scheduler locate jobs by an application code if they support this function.
- **&GROUP** - Control group name (if applicable).

Not all variables are applicable in each case. If the variable name is not relevant, place an asterisk (*) in the variable.

Note: Before you can use the &APPL variable, you need to set up the application in the i5/OS job scheduler. To do so,

1. From a command line type **GO JS**, press Enter
2. Select option **4. Job controls**
3. Select option **6. Work with applications**
4. Type **1** for *Opt* and **BRMS** for *Application*, press Enter
5. Type in contact information and text describing application if desired, press Enter

Change Job Scheduler (CHGSCDBRM)

Type choices, press Enter.

Scheduler type TYPE	*USRDFN
Add a job command ADDCMD	'ADDJOBOS JOB(&JOBNAME) _____
APP(&APPL) SCDCDE(*DAILY) TIME(2300) CMD(&REQUEST)'	_____
_____	_____
_____	_____
_____	_____

Command prompt for add ADDPMT *YES

More...

F3=Exit F4=Prompt F5=Refresh F12=Cancel F13=How to use this display
F24=More keys

Note: Although it is possible to use both the i5/OS job scheduler and a vendor scheduler for BRMS, IBM does not recommend it. You will find it easier to track and control scheduling activities when using only one scheduler.

Part 3. Advanced Topics in BRMS

Chapter 11. The Functional Usage Model and BRMS Security Considerations

As a BRMS administrator, you understand the importance of protecting user and system data from deletion, distortion, and theft. The BRMS Functional Usage Model allows you to customize user access to BRMS functions (backup, recovery, and media management) and to the different components of each function. For example, you can give one user authority to change a control group, and another the authority only to use and view it. You can also use the functional usage model to grant *all* users access to a particular function or functional component.

You need to access the BRMS functional usage model through the iSeries Navigator interface. You can find instructions on how to use iSeries Navigator with the functional usage model later in this chapter. If you do not have iSeries Navigator installed on your machine, you can find some tips on how to secure your BRMS functions in the "Working with i5/OS Security Controls" section of this chapter.

BRMS also provides another security option, the SETUSRBRM command, that allows you to reset a user or group profile by job category, *OPERATOR or *ADMINISTRATOR. Use the Set User Usage for BRM (SETUSRBRM) command as a starting point for controlling access to BRMS functions, and use the iSeries Navigator interface to tailor your security setup to better meet your requirements. You do not need to have iSeries Navigator installed to use this command.

BRMS provides effective control over user access to BRMS functionality. Use i5/OS security options to prevent users from causing accidental or intentional damage to your files or system. However, because BRMS ships its databases with *PUBLIC *USE authority (which allows use but not change), irreparable damage is unlikely to occur.

Note: If you have the Advanced Functions feature installed, you can apply the functional usage model to the archive, retrieve, and migration components. For information on how to do so, see the *Hierarchical Storage Management* book for more information.

How the Functional Usage Model Works

Use the functional usage model when you want to customize user access to certain functions or when you want to grant all users the same access to a certain function. The functional usage model provides two levels of security for each BRMS function, functional component, and specific backup and media management item (such as a policy or control group).

ACCESS or NO ACCESS

In the functional usage model, a user either has access to a BRMS function or component, or does not have access to it. If a user has access to a function or component, that user can use and view it. If a user has no access to that function or component, then that user cannot use or view it. At this basic level of access, a user can process a specific item (such as a library or control group) in a backup operation, but does not have the ability to change it.

SPECIFIC CHANGE or NO CHANGE

Another level of access allows a user to change a **specific** function, component, or item. For example, to change a backup list, a user must have access to a *specific* backup list. Similarly, to change a media policy, a user must have access to a *specific* media policy. The functional usage model provides lists of existing items (control groups, backup lists, media and move policies, and so on) for which you can grant specific access.

With the functional usage model, you can give a user both types of access (so that the user can both use and change a particular function, component, or item). Or you can give a user just one type of access, for example, access to use, but not change, a particular function, component, or item.

The following section summarizes your security options.

Backup Function

In the backup area, the following usage levels are available:

Basic Backup Activities

This is the basic level of backup usage. Those with Basic Backup Activities access can use and view the backup policy, control groups, and lists. Use access also allows these users to process backups by using control groups (through the STRBKUBRM command) or by libraries, objects, or folders (SAVLIBBRM, SAVOBJBRM, or SAVFLRLBRM). A user without access to basic backup activities cannot see backup menu options or command parameter options.

Backup Policy

Users with access to the Backup Policy can change the backup policy, in addition to using and viewing it. Users without access to the backup policy cannot change it.

Backup Control Groups

Users with access to Backup Control Groups can change specific control groups, in addition to using and viewing them. You can find a list of all of your existing control groups under the backup control groups heading in iSeries Navigator. You can grant a user access to any number of specific control groups. Users without access to the archive control groups cannot change them.

Backup Lists

Users with access to Backup Lists can change specific backup lists, in addition to using and viewing them. You can find a list of all of your existing backup lists under the backup lists heading in iSeries Navigator. You can grant a user access to any number of specific backup lists. Users without access to a backup list cannot change it.

Recovery Function

In the recovery area, the following usage levels are available:

Basic Recovery Activities

This is the basic level of recovery usage. Users with Basic Recovery Activities access can use and view the recovery policy. In addition, they can also use the WRKMEDIBRM command to process basic recoveries, and the RSTOBJBRM and RSTLIBBRM commands to perform individual restores. Users without access to basic recovery activities cannot see recovery menu options or command parameter options.

Recovery Policy

Users with access to the Recovery Policy can change the recovery policy, in addition to using and viewing it. Users without access to the recovery policy cannot change it.

Media Management Components

In the area of media management, the following usage levels are available:

Basic Media Activities

This is the basic usage level for this function. Users with access to Basic Media Activities can perform basic media-related tasks such as using and adding media to BRMS. Users with this access can also use and view, but not change, media policies, and media classes. Users without access to basic media activities cannot see related menu options or command parameter options.

Advanced Media Activities

Users with access to the Advanced Media Activities can perform media tasks such as expiring, removing, and initializing media.

Media Policies

Users with access to the Media Policies can change specific media policies, in addition to using and viewing them. You can find a list of all of your existing media policies under the media policies heading in iSeries Navigator. You can grant a user access to any number of media policies. Users without access to a media policy cannot change it.

Media Classes

Users with access to the Media Classes can change specific media classes, in addition to using and viewing them. You can find a list of all of your existing media classes under the media classes heading in iSeries Navigator. You can grant a user access to any number of media classes. Users without access to a media class cannot change it.

Media Information

Users with Media Information access can change media information from the Work with Media Information (WRKMEDIBRM) displays.

Basic Movement Activities

Users with access to Basic Movement Activities can manually process or display MOVMEDBRM commands but cannot change them.

Move Verification

Users with access to move verification can perform move verification tasks.

Move Policies

Users with access to Move Policies can change specific move policies, in addition to using and viewing them. You can find a list of all of your existing move policies under the move policies heading in iSeries Navigator. You can grant a user access to any number of move policies. Users without access to a move policy cannot change it.

System-Related Functions

In the system area, the following usage options are available:

Basic System Activities

Users with basic system-related activities can use and view device displays and commands. They can also view and display ASP information and commands. Users with this access level can also use and view the system policy.

Devices

Users with device access can change device-related information. Users without this access are unable to change device information.

Auxiliary Storage Pools

Users with access to ASP information can change information about BRMS ASP management.

Maintenance

Users with maintenance access can schedule and run maintenance operations.

System Policy

Users with access to the system policy can change system policy parameters.

Log Any user can display log information, but only those with Log access can remove log entries.

Initialize BRM

Users with this access can use the INZBRM command.

Implementing the Functional Usage Model

Use the iSeries Navigator interface to access the functional usage model feature. To get to a list of BRMS function and components, perform the following steps from your iSeries Navigator window:

1. Highlight your system name and, from the File menu, select Application Administration. If you have iSeries Navigator installed, but do not see the Application Administration feature, then you need to reinstall it.
2. When the Application Administration dialog appears, click the Host Applications tab.
3. From the Host Applications dialog select the Backup, Recovery, and Media Services for iSeries product.
4. Click the BRMS icon to expand the tree structure to see the different functions and components available.

Following is a summary of what you can see or do on the Host Applications display:

- In the **Function** column, you can see the names of the BRMS functions and functional components.
- If you highlight a box in the **Default Usage** column, you are granting all users access to that function or functional component. An X in a Default Usage box grants all users access to the function or component to the left of the box.
- If you check the **All Object Usage** column, you are indicating that a user or number of users have *ALLOBJ authority at the user level. The i5/OS operating system provides a special *ALLOBJ security value, which allows user access to all objects on the iSeries. A user with (*ALLOBJ) authority automatically has complete access to the BRMS functions and components that you mark. If you do not check this box, then BRMS ignores the users *ALLOBJ authority and requires customized access.
- To customize user access, click on the **Customize** button on the bottom right of the display. From the Customize display, you can select individual users by name and tailor their access as needed. When you customize user access to any of the functions or functional components, an X appears in the **Customize Access** column on the Host Applications display.

Registering New BRMS Activities with the Functional Usage Model

Once you establish the Functional Usage Model for BRMS users, BRMS begins registering new activities with the i5/OS security system. Each time you create a new control group, list, media policy, media class, or move policy, BRMS adds it to the usage model. When this happens, BRMS records the name of the new item in the log. You can use the DSPLOGBRM *SEC command to review the log message. BRMS registers each of the new items with the default usage level that you specified in the system policy.

To get to the Change System Policy display, take the following steps:

1. Type GO BRMSYSPCY at a command line and press Enter.
2. Select option 1 (Display or change system policy).

```

Change System Policy

Type choices, press Enter.
Media policy . . . . . FULL           Name, F4 for list
Devices . . . . . TAPMLB04          Name, F4 for list
Home location for media . . . . . *HOME      Name, F4 for list
Media class . . . . . CART3490E      Name, F4 for list
Sign off interactive users . . . . . *NO      *YES, *NO
Sign off limit . . . . . 30          0-999 minutes
Output queue . . . . . *PRTF         Name, *PRTF
Library . . . . .                   Name, *LIBL
Day start time . . . . . 0:00:00      Time
Media monitor . . . . . *YES         *YES, *NO
Shared inventory delay . . . . . 60     30-9999 seconds
Auto enroll media . . . . . *NO       *NO, *YES
Default usage. . . . . *NO           *NO, *YES
More...

F3=Exit  F4=Prompt  F5=Refresh  F12=Cancel

```

3. The value in the *Default usage* field specifies whether to give default access to the specific BRMS object that you are creating, for example, a control group, backup list, or policy.
4. Press Enter to save your changes and exit.

Working with the SETUSRBRM Command

Use the SETUSRBRM command as a starting point to grant system operators and administrators access to BRMS functions and components. Then use the functional usage model to customize access by user or when you want to grant all users access to a certain function. BRMS bases these default operator and administrator categories on the kinds of activities that are usually performed by users in these roles.

To get to the Set User Usage for BRM (SETUSRBRM) display, take the following steps:

1. Type SETUSRBRM at a command line and press F4 to prompt the display.

```
Set User Usage for BRM (SETUSRBRM)

Type choices, press Enter.

User . . . . . Character value, *DEFAULT
Usage . . . . . *OPERATOR *OPERATOR, *ADMIN

Bottom
F3=Exit F4=Prompt F5=Refresh F12=Cancel F13=How to use this display
F24=More keys
```

2. In the *User* field, type in the name of an existing group or user profile or use the *DEFAULT value. *DEFAULT means that the default user has access to the functions associated with the job category that is specified in the *Usage* field.

3. In the *Usage* field, select either the *OPERATOR or the *ADMIN value.

If you select the *ADMIN value, the user named in the *User* field has use and change access to all of the BRMS functions and functional components.

If you select the *OPERATOR value, the user named in the *User* field has use of the following BRMS functions:

- Basic backup activities
- Basic media activities
- Basic movement activities
- Basic archive activities (when Advanced feature is installed)
- Basic migration activities (when Advanced feature is installed)

but is removed access to the function components. This provides a basic set of functions to which to can grant additional function and functional component authority.

4. Press Enter to apply your changes.

Note: SETUSRBRM is a one time reset of access to functions. Information about user job categories *OPERATOR or *ADMIN is not kept.

Suppose you want to restrict user BRMSOPER to basic activities but allow this user to initialize media. You would:

1. Run the command

```
SETUSRBRM USER(BRMSOPER) USAGE(*OPERATOR)
```

to limit the user to basic activities.

2. Go to BRMS host application in the iSeries Navigator Application Administration.

- Click on the system under **My connections**.
- Click on the **Configure Application Administration** task.

- Click the on **Host Applications** tab.
3. Grant the user access to *Advanced media activities* to enable media initialization.
 - Open the **Backup Recovery and Media Services** folder.
 - Open the **Media** folder.
 - Right click on **Advanced media activities**.
 - Click **Customize**.
 - Add the BRMSOPER to the Access allowed list.
 - Click **OK**.
 4. Grant the user access to the *Media class* functional components which will be required by the initialization function.
 - Right click on a media class in the list.
 - Click **Customize**.
 - Add user BRMSOPER to the Access allowed list for this media class.
 - Click **OK**.
 - Right click on the media class again.
 - Click **Copy Access Settings**.
 - Right click on the **Media class** folder.
 - Click **Paste**.

Application Administration copies the access information from the customized media class to all media classes in the Media classes folder.

Securing the Console Monitor

You can run saves that require a restricted state, such as *SAVSYS, from the system console in a secure, unattended mode.

Enter a password to suspend the console. Once suspended, the console is again fully available. To avoid this security exposure, create a new user profile (for example, CONSOLE) that uses QBRM as the current library. The new user profile calls the console monitor program (Q1ACCON) as its initial program, and uses the *SIGNOFF menu as its initial menu.

```

                                Create User Profile (CRTUSRPRF)

Type choices, press Enter.

User profile . . . . . CONSOLE
Name User password . . . . . Name, *USRPRF, *NONE
Set password to expired . . . . *NO *NO, *YES
Status . . . . . *ENABLED *ENABLED, *DISABLED
User class . . . . . *SECOFR *USER, *SYSOPR, *PGMR...
Assistance level . . . . . *SYSVAL *SYSVAL, *BASIC, *INTERMED...
Current library . . . . . QBRM Name, *CRTDFT
Initial program to call . . . . Q1ACCON Name, *NONE
Library . . . . . QBRM Name, *LIBL, *CURLIB
Initial menu . . . . . *SIGNOFF Name, *SIGNOFF
Library . . . . . *LIBL Name, *LIBL, *CURLIB >
Limit capabilities . . . . . *NO *NO, *PARTIAL, *YES
Text 'descriptions' . . . . . BRMS Console Monitor Profile

```

Start the console monitor by signing on with this new user profile. Use F9 to enter commands at this display only if you enter the CONSOLE profile password. Any attempt to end the console monitor results in a sign off.

Working with i5/OS Security Controls

To achieve increased security, combine i5/OS security controls with on site security measures and the BRMS functional usage model. User management is responsible for the evaluation, selection, and implementation of security features, administrative procedures, and appropriate controls in application systems and communication environments.

i5/OS security features include the use of passwords, a security option to limit read/write access for files, libraries, and folders during normal operations. To better understand i5/OS security options, review the Security Reference manual.

To ensure that you are protecting your media, IBM recommends that you restrict access to the following BRMS-specific commands. Do this in addition to the other security measures that are discussed in this chapter.

- CHGMEDBRM
- CHGSCDBRM
- RMVMEDBRM
- ADDMEDIBRM
- RMVMEDBRM
- RSTAUTBRM
- RSTxxxBRM
- INZMEDBRM

IBM also recommends that you restrict access to the following i5/OS commands:

- SAVSTG
- INZTAP

Use the Grant Object Authority (GRTOBJAUT) command to grant users access to these BRMS and i5/OS commands. Use the Remove Object Authority (RMVOBJAUT) command to remove user access from these commands.

Notes:

1. IBM also recommends that you restrict user access to the QBRM library to BRMS users.
2. IBM ships a default user profile that is called QBRMS as part of the basic i5/OS package. Do not delete this profile. This profile resolves security and authority issues between BRMS and i5/OS during a recovery, thereby restoring the BRMS profile in advance of other user profiles. For more information on QBRMS and network security, see Chapter 14, "Networking with BRMS," on page 237.

BRMS Media Security

BRMS monitors and protects media operations in the following ways:

- BRMS provides media protection against overwriting by checking the media inventory before using a tape. This ensures that the volume is available for use in the media scratch pool. If the volume is unavailable, BRMS rejects it, and sends a message that suggests an available volume.
- Media output to each function requires that the media be of the correct class. If it is not, BRMS rejects it, logs the attempted use, and sends a message suggesting an available volume.

Note: BRMS performs no media inventory checking if you use the i5/OS Save Storage (SAVSTG) command to back up your system. BRMS does not log this usage. Therefore, IBM recommends that you secure the SAVSTG command and that you use volumes that are not managed by BRMS for SAVSTG operations.

At the *Secure media* parameter on the media policy, you can specify whether to apply volume security to volumes in a selected media class. If your media policy specifies a TSM server, then you must also specify *ADSM at the *Secure media* prompt. If you specify *ADSM at the *Secure media* prompt, then you must also specify *ADSM at the media class and move policy prompts. You can find more information on TSM in Chapter 13, “BRMS and Tivoli Storage Manager (TSM),” on page 223.

Note: Only users with *ALLOBJ or *SAVSYS authority can read a secured volume. BRMS logs any unauthorized attempts, and denies read access. To use the secure option, you also need *ALLOBJ or *SAVSYS authority. You can secure media by changing the value in the *Secure Media* field on the media policy that you want to use for this backup to *YES.

To prevent the accidental initialization of media, set the INZMEDBRM command to CHECK(*YES). This way, BRMS will not initialize media that contains active files. You cannot use the i5/OS INZTAP command to initialize BRMS media unless you have the appropriate user authority.

You can use the Remove Media Volumes from BRM (RMVMEDBRM) command to secure the process of removing media and media information. You can also use the Remove Media Info from BRM (RMVMEDIBRM) command. BRMS processes commands that contain the 4=Remove option (for media or media information) through the RMVMEDBRM and RMVMEDIBRM commands. For example, BRMS uses the RMVMEDBRM command to process remove requests from the Work with Media (WRKMEDBRM) command. You can process any command that allows the removal of media information, such as WRKMEDIBRM, WRKSPLFBRM, WRKOBJBRM, WRKLIBBRM, through the RMVMEDIBRM command.

Chapter 12. Saving to Save Files

Save files can be used for unattended save operations (such as backups scheduled for times when an operator will not be present to mount media volumes to receive save output). Save file can be created in the System (1) auxiliary storage pool or in a basic user (2–32) auxiliary storage pool. BRMS currently does not allow save files to be created in auxiliary storage pool devices (33–255). Please refer to the *Backup and Recovery* book for further information concerning save files and auxiliary storage pools and their use in planning your backup strategy.

Specifying Use of Save Files in the Media Policy

In the Media Policy, you specify whether you want to save items to save files or directly to removable media. If you save to save files, you can use the *Save file retention type* and *Retain save files* fields to specify the method that is used in the media policy to expire save files.

If the media policy specifies media retention in addition to the use of save files, the saved data is kept in both a save file and on removable media according to the retention specified for each.

The *Save file retention type* field specifies how save files expire. The *Save file retention type* field is used with the *Retain save files* field to define any of four different retention methods for save files. The four methods of save file retention that can be specified in the media policy are:

- Expire save file on a specific date. This method requires a date entry be specified in the *Retain save files* field. Save files saved with this media policy will expire after the specified date has passed.
- Expire save file after a specific number of days. This method requires number of days be specified in the *Retain save files* field. Save files saved with this media policy will expire after the specified number of days has passed.
- Permanent retention of save files. Save files saved with this media policy will kept permanently.
- No retention of save files. Save files saved with this media policy will be deleted after it has been successfully saved to media using the SAVSAVFBRM command.

Note: Save files created by a saves which also contains a device name will never be deleted until the save file is saved successfully to media, regardless of the save file retention specified in the media policy. The save file retention merely serves as an extension of this media retention. If save files are created by saves which do not also specify a removable media device, these save file are deleted by BRMS maintenance if the save files have expired.

```

                                Create Media Policy

Type choices, press Enter.

Media policy . . . . . BKUP5      Name
Retention type . . . . . 2        1=Date, 2=Days,
                                   3=Versions, 4=Permanent
                                   Date, Number
  Retain media . . . . . 35       Name, *NONE, *ADSM, F4
Move policy . . . . . *NONE       Name, *SYSPCY, *ADSM, F4
Media class . . . . . *SYSPCY    Name, *ANY, F4 for list
Storage location . . . . . *ANY   *YES, *NO
Save to save file . . . . . *YES  Name, *SYSTEM, 1-32
  ASP for save files . . . . . 2   1=Date, 2=Days,
  Save file retention type . . . . 3=Permanent, 4=None
                                   Date, Number, *NONE
  Retain save files . . . . . 15   *SYS, 1-99
  ASP storage limit . . . . . 90   *YES, *NO, *ADSM
Secure media . . . . . *NO
Text . . . . . Media policy for control group BKUP5
                                                More...

F3=Exit  F4=Prompt  F5=Refresh  F12=Cancel

```

The preceding Create Media Policy display for media policy BKUP5 specifies the use of save files as follows:

- Save files created by saves of control groups using this media policy are saved to basic user auxiliary storage pool 2.
- Save files are kept online for 15 days and then are eligible for deletion
- The storage limit for auxiliary storage pool 2 is 90%.

Specifying use of Save Files in Control Groups

You specify your intent to use save files for a backup or archive by specify in the control group attributes (or a BRMS save command) the media policy containing the save to save file attributes. You optionally can specify a device to be used when saving the save files to media. If you do not specify a device and instead specify *NONE, this instructs BRMS to store the saved data in save files but also indicates that these save files are intended for online use only and that BRMS is not allowed to save these save files to media.

```

                                Change Backup Control Group Attributes

Group . . . . . : WEEKLY1

Type information, press Enter.

Media policy for:
  Full backups . . . . . BKUP5      Name, F4 for list
  Incremental backups . . . . . BKUP5  Name, F4 for list
Backup devices . . . . . *NONE      Name, F4 for list

=====
Parallel device resources:
  Minimum resources . . . . . *NONE   1-32, *NONE, *AVAIL
  Maximum resources . . . . .        1-32, *AVAIL, *MIN
Sign off interactive users . . . . . *BKUPCY *YES, *NO, *BKUPCY
Sign off limit . . . . . *BKUPCY    0-999 minutes, *BKUPCY
Default weekly activity . . . . . *BKUPCY SMTWTF(S(F/I), *BKUPCY
Incremental type . . . . . *BKUPCY  *CUML, *INCR, *BKUPCY
Force full backup days . . . . . *BKUPCY 0-365, *NOMAX, *BKUPCY
                                                More...

F3=Exit  F4=Prompt  F12=Cancel

```

Managing Save Files using BRMS

Once data has been saved to a save file through either a BRMS backup or archive process, the save file data can be:

- Copied to media, or
- Deleted from the save file library.

There are situations where you may decide to only save data to a save file without ever copying it to media. In this way you are likely to keep the save file on the system for a longer period of time in case the saved data is needed for quick recovery. Most often, however, once data is copied from the save file to tape, the save file will be deleted. There may be situations where the save file is needed to be kept on the system for a period of time after the copy of the save file to tape. The following table shows the different options associated with copying save files to media and deleting save files from the system.

Table 2. Options for copying save files to media

Action	Device: *NONE	Device: device-name
<i>Copied To Media</i>	No	Yes
<i>Deleted from disk</i>	On expiration	On expiration or when copied to media (which ever happens last)

There are five commands that can be used to manage the save files. These are:

- Remove Media Information from BRM (RMVMEDIBRM)
- Save Save Files using BRM (SAVSAVFBRM)
- Start Expiration for BRM (STREXPBRM)
- Start Maintenance using BRM (STRMNTBRM)
- Work with Save Files using BRM (WRKSAVFBRM)

Notes:

1. RMVMEDIBRM and SAVSAVFBRM commands will delete only those save files that have expired. The STREXPBRM command must run prior to these commands to flag such save files as expired. The STREXPBRM and RMVMEDIBRM commands can be scheduled to run periodically or can be processed as part of the daily BRMS maintenance processing (see Chapter 9, "Daily Maintenance in BRMS," on page 195).
2. The SAVSAVFBRM and STREXPBRM commands determine those save files that need to be saved or expired and deleted from the system based on the object and retention information specified in the control group attributes.
3. The RMVMEDIBRM and STREXPBRM commands can be run independently, but are also components of the BRMS maintenance procedures. These procedures should be run nightly. As such, if you are performing regular maintenance with the STRMNTBRM command then this will ensure that no expired save files are kept on the system, thus reducing disk usage. Refer to Chapter 9, "Daily Maintenance in BRMS," on page 195 for more information about setting up daily maintenance operations.
4. The SAVSAVFBRM command should not be confused with the option to save contents of save files which is on the second screen of the control group attributes, backup, and archive policies. These options refer to the ability to save data in user save files to the media defined in your control group or policy. SAVSAVFBRM is a command to save BRMS save files to media under BRMS control. You can schedule the SAVSAVFBRM command through the system job scheduler or on demand.
5. The *Allow subsequent saves* (ALWADLSAVE) parameter of the SAVSAVFBRM command can be used to allow you to save the save files to media and not have the save file deleted from the system. Specifying *YES for this parameter indicates you intend to save the save files on subsequent save operations. The save files will not be deleted from the system when maintenance is run. If you specify this value, you must run a subsequent SAVSAVFBRM command using ALWADLSAVE(*NO) to enable removal of these save files from the system.

Work with Save Files

The *Work with Save Files* display allows you to expire save files and remove them from the system. From this display you can also use option 9=Work with saved objects to view the saved object contained in the save file and subsequently select the one or more objects for recovery from the save file, or use option 5 to display detailed information about the save file itself. You can get to the *Work with Save Files* using *Work with Save Files (WRKSAVFBRM)* command.

```
Work with Save Files                                RCHAS400
Position to Library . . .                          Starting characters
Type options, press Enter.
 4=Remove  5=Display  7=Expire  9=Work with saved objects

Opt Library      Date      Time      Save  Save file  Save file
          Date      Time      Type  Expiration ASP      Size
PATJRN  12/23/05  16:00:30 *FULL *NONE     1      544,768
PATJRN  12/23/05  16:00:50 *FULL *NONE     1      544,768
PATJRN  12/24/05  14:03:57 *FULL *NONE     1      217,088

Bottom

F3=Exit  F5=Refresh  F12=Cancel
```

Libraries Containing BRMS Save Files

The *ASP for save files* field in the media policy specifies the Auxiliary Storage Pool (ASP) number in which you want to store save files created as a result of BRMS processing. Any valid auxiliary storage pool number between the range of 1–32 is permitted for specifying the auxiliary storage pool used to store save files. BRMS creates a library on the auxiliary storage pool which it uses to store the save files. The names these libraries are Q1ABRMSF01 for the system auxiliary storage pool (1), Q1ABRMSF02 for basic user auxiliary storage pool 2, and on. These save file libraries are not deleted from the system when you delete the BRMS product from the system.

Note: BRMS does not support saves to save files in auxiliary storage pool devices (33–255). You can also specify an auxiliary storage pool storage limit in the media policy as a percent of the total available auxiliary storage pool space. For instance, ninety percent in the auxiliary storage pool storage limit field indicates that save files can be written to the auxiliary storage pool until it reaches ninety percent utilization. When the limit is reached, the message queue designated in the system policy is sent a message indicating that the auxiliary storage pool storage limit has been exceeded and gives you the opportunity to ignore, cancel or retry the save to save file operation. You can remedy the situation by using the SAVSAVFBRM command to move files from save files to media or you can increase the auxiliary storage pool storage limit percent in the media policy and then retry the save to save files.

Individual save file names are generated automatically by BRMS based on date/time stamp. BRMS manages its own save file environment. It is not important to know the save file names or the names of the libraries in which they reside.

Chapter 13. BRMS and Tivoli Storage Manager (TSM)

The Tivoli Storage Manager (TSM) is IBM's recommended solution for providing automated, centralized backup, recovery, and storage management for heterogeneous workstations and network servers to a central server. To find out more about TSM, visit the Tivoli Web site at <http://www-3.ibm.com/software/tivoli/products/storage-mgr/>.

Using BRMS as a TSM Client

You can use BRMS to save user data on distributed iSeries systems to any TSM server. You can do this by using a BRMS component that is called the BRMS TSM Client which is provided with the base BRMS product.

The BRMS TSM Client has the look and feel of BRMS and iSeries. It is not a TSM Backup or Archive client. There is little difference in the way BRMS saves objects to TSM servers and the way it saves objects to media. A TSM server is just another device that BRMS uses for your save and restore operations.

The BRMS TSM Client communicates with TSM servers through a special set of APIs that are referred to as the TSM Application Programming Interface for iSeries (TSM APIs), program product 5733197.

Note: The latest version of the TSM APIs can be downloaded from the following URL:

<ftp://ftp.software.ibm.com/storage/tivoli-storage-management/maintenance/client/v5r2/OS400/LATEST/>

Benefits

The BRMS TSM Client for TSM provides the following benefits for one or more systems at off site locations:

- You can use BRMS policies to save non-system objects across a network for storage on any server in the TSM family.
- You can reduce the amount of media that is required at the off site location, thereby increasing the level of backup automation.
- You can reduce the amount of time that is spent managing media.
- You can minimize device purchases on the off site system.

Restrictions

Any user data that you can save to a save file, you can save to a TSM server by using the BRMS TSM Client. Typically, this data is created by the user and is not required to restore i5/OS to a functional level. Therefore, security data, configuration data, and licensed programs are excluded from save operations to TSM servers.

Following is a list of additional restrictions that are placed on BRMS TSM Client operations.

- Save-while-active *SYNCLIB is not supported when saving libraries to TSM servers. When libraries are saved to TSM servers, one save command is used to save each library because i5/OS requires the save to be setup as a save to a save file. The *SYNCLIB value will be ignored if it is specified.
- You cannot save iSeries system data to a TSM server. You must store system data on local media so that it is available for system recovery.
- BRMS does not save *IBM type libraries to TSM servers.
- BRMS does not save IBM-supplied libraries that are considered user data such as QGPL, QUSRBRM or QUSRSYS libraries to TSM servers.

- You cannot schedule operations from a TSM server, though you can schedule operations by using BRMS.
- BRMS uses its own media policies to manage the retention and expiration of data that is stored on the TSM server. TSM policies are not used for this purpose.
- You cannot save BRMS media information on a TSM server. You must save this information to local media so that it is available for recovery.

Performance

Save and restore data transfer performance between the BRMS TSM client and Tivoli Storage Manager (TSM) is dependent upon several factors which include the current activity on the system, the availability of computing resources on the system, the available network bandwidth, and the TSM server. BRMS does not communicate directly with TSM servers. BRMS uses functions provided by the TSM APIs. The TSM APIs handle all communication with the TSM server.

For save operations, BRMS receives a pointer to the save data and length from the operating system. BRMS passes the pointer and length to the TSM API. The TSM API transfers the save data to the TSM server. The save performance is directly related to the ability of the operating system and BRMS to collect the blocks of save data and the TSM API to send the save data across the network to the TSM server. The slower of the save and send rates determines the performance of the save operation.

For restore operations, the BRMS receives requests for blocks of restore data from the operating system. BRMS passes the request to the TSM API. The TSM API manages the transfers of restore data from the TSM server. The restore performance is directly related to the ability of the TSM API to receive blocks of restore data from the TSM server across network, and BRMS and the operating system to restore the objects. The slower of the receive and restore rates determines the performance of the restore operation.

You can have BRMS analyze and report recent TSM performance. To do so:

1. On a command line type GO BRMRPT, then press the Enter key.
2. Run option 53. Print TSM performance analysis.
3. Specify the range of dates, job, user and minimum blocks you want to include in the TSM Performance Analysis Report.

Note: Activity between BRMS and TSM servers is recorded in file */tmp/brms/tsmapis*. The report program uses this data to produce the report.

Specify Report Criteria

Type choices, press Enter.

Select dates:		
From date	: *BEGIN	Date, *BEGIN, *CURRENT
To date	: *END	Date, *END, *CURRENT
Job number	: *ALL	1-999999, *ALL
Job user	: *ALL	Name, *ALL
Minimum blocks	: *NONE	1-999999, *NONE

F3=Exit F12=Cancel

4. Press the Enter key to create the report.

5. Use the Work with Spooled Files (WRKSPLF) command to view or print the QP1ATSMRPT report.

Notes:

- a. The performance data in the report only reflects the time required to transfer data once the operating system initiates a request to send or receive the first block of data. The performance analysis in this report does not include additional processing time required to create the save/restore command or to process the output file.
- b. Averages for transfer rates are more accurate as the number of blocks in the transfer increase. For example, an analysis of transfers consisting of 50 blocks provides a better average than an analysis of transfers consisting of only 5 blocks.

TSM Data Retention Protection

Recent government directives require critical data to be retained for fixed periods of time and to be protected from premature deletion. TSM data retention protection provides fixed retentions for archived objects and prevents the data from being deleted until the retention expires. A TSM server uses data retention protection if the TSM server *Archive retention protection* status is set to *yes*.

If a TSM server is enabled for data retention protection, it can only be used to store archive objects because archive copy groups are the only objects which provide a retention attribute. The IBM Data Retention 450 (DR450) or DR550 servers are customer set up solutions which provide a TSM server pre-configured for data retention protection.

BRMS has been enabled to allow backup or archive operations to be directed to a TSM server enabled for data retention protection. This function is available by PTF in releases prior to V5R4M0 and is integrated into the BRMS TSM device support beginning with V5R4M0.

Note: Version V5R2M2 or later of the Tivoli Storage Manager Application Programming Interface (TSM APIs), program product 5733-197, is required to use the BRMS TSM client with a DR450 and DR550 servers or a TSM server enabled for *Archive retention protection*.

It is important to understand the BRMS client saves all objects from an iSeries to the TSM server as backup objects regardless of whether the operation was a BRMS backup or BRMS archive. BRMS stores these saved objects as backup objects on the TSM server so that BRMS can delete the objects when these expire. It is the expiration date in the BRMS history information that determines when the saved objects expire. When you run BRMS maintenance, expired objects are removed from history. If the object was stored on a TSM server, it is also deleted from the TSM server when the object is deleted from BRMS history. The backup copy group in the management class used by BRMS is set up to only keep one version of the object when it is stored on the TSM server, and it is also set up to not keep any versions of deleted objects. This allows BRMS to efficiently manage the storage it uses at the TSM server.

The data retention servers require clients store objects on the server as archive objects so retention attributes of an archive copy group can be applied to the object. If a user attempts to delete the archived object before the retention has expired, the delete attempt is ended. Archived objects on data retention servers can only be deleted after the retention on the object has expired, thus providing object retention protection. In order for the BRMS client to store objects on a data retention servers, the objects need to be sent as TSM archive objects instead of TSM backup objects.

Note: The TSM object has no relevance to the type of save being performed by BRMS on the iSeries. The save can be either a backup or archive operation and the saved objects will be sent to the data retention server as archive objects.

It is important when saving objects to data retention servers to ensure the retention of the BRMS media policy matches the retention of the archive copy group in the TSM management class. This is necessary so the saved items expire in BRMS history concurrently with the expiration of the object by the server. If an object is saved to a data retention server by BRMS, changing the expiration of the object in BRMS history does not affect the retention at the data retention server.

- | If the BRMS expiration is later than the TSM expiration, the data retention server will expire and delete the object from its own storage. BRMS will delete the object from history when the history expiration occurs. If the object no longer exists at the data retention server when BRMS attempts the delete, the delete from BRMS history will complete successfully.
- | If the BRMS expiration is earlier than the data retention server expiration, any attempt by BRMS to delete the object from the server will fail with exception BRM2327 – Errors occurred removing item from TSM server. Reason code 0248 will be listed in the cause of the message. The objects will remain in BRMS history until they also expire on the data retention server.

Setting Up Your BRMS Client

To establish the connection between TSM and BRMS, take the following steps:

Steps at the TSM Server

Ask your TSM administrator to perform the following tasks:

- Register your system node name and assign it to a TSM domain that does not perform scheduled backups.
- Note:** When you register the system as a node with the TSM server, make sure you use `COMPRESSION=Client` or `COMPRESSION=No`, and `BACKDELETE=Yes` on the `REGISTER NODE` command.
- Provide the management class name if that name is different from `STANDARD`.
 - Provide the communications protocol that you will use to connect to the TSM server.
 - Provide a name that indicates the communications category (for example, `*APPC` or `*NET`) you need to use.
 - The TSM `STANDARD` management class does not provide the most efficient use of TSM server storage when used with the BRMS TSM Client. You should consider using the following TSM administrative commands to create and enable a new TSM domain and TSM management class, and registering nodes for BRMS use.

For IBM Tivoli Storage Manager servers

```
DEFINE DOMAIN BRMS DESCRIPTION="Domain for BRMS TSM
Clients" BACKRETENTION=nnnnn ARCHRETENTION=0

DEFINE POLICYSET BRMS BRMS DESCRIPTION="Policy set for BRMS
TSM Clients"

DEFINE MGMTCLASS BRMS BRMS BRMS DESCRIPTION="Management
class for BRMS TSM Clients"

DEFINE COPYGROUP BRMS BRMS BRMS STANDARD TYPE=BACKUP
DESTINATION=storage pool name
VEREXISTS=1 VERDELETED=0 RETEXTRA=0 RETONLY=0

ASSIGN DEFMGMTCLASS BRMS BRMS BRMS

ACTIVATE POLICYSET BRMS BRMS

REGISTER NODE node-name password DOMAIN=BRMS COMPRESSION=NO BACKDELETE=YES
```

For IBM Data Retention 450 (DR450) and DR550 servers

```

DEFINE DOMAIN BRMS DESCRIPTION="Domain for BRMS TSM
Clients" BACKRETENTION=0 ARCHRETENTION=nnnn

DEFINE POLICYSET BRMS BRMS DESCRIPTION="Policy set for BRMS
TSM Clients"

DEFINE MGMTCLASS BRMS BRMS BRMS DESCRIPTION="Management
class for BRMS TSM Clients"

DEFINE COPYGROUP BRMS BRMS BRMS STANDARD TYPE=ARCHIVE
RETVER=nnnnn RETINIT=CREATION

DESTINATION=storage pool name

ASSIGN DEFMGMTCLASS BRMS BRMS BRMS

ACTIVATE POLICYSET BRMS BRMS

REGISTER NODE node-name password DOMAIN=BRMS COMPRESSION=N0 ARCHDELETE=YES

```

- BRMS will be the management class name that is used by the BRMS TSM Client.
- If the management class you are using for the BRMS TSM Client uses a sequential access storage pool, you need to be aware that each library saved by the client starts and ends within a client session. If the device class used by the sequential storage pool has a mount retention of 0 minutes, the tape volume is mounted at the start of a session and dismounted at the end of a session. If you are seeing a lot of tape mounts and dismounts during the backup, review the mount retention attribute on the TSM server and change it as required to improve your response time.
- If the management class you are using for the BRMS TSM Client uses a disk storage pool, you need to be aware that TSM servers require a client to provide the size of the saved object in order to allocate storage from the disk pool for receiving the saved object. BRMS estimates the saved object size because the true size of any saved object is not available from the operating system until after the object has been saved. If you are running multiple concurrent backup jobs to a TSM server, the cumulative disk pool storage requirements due to these estimated object sizes may cause some BRMS client sessions to be ended by the TSM for insufficient storage. The following defines the estimates BRMS uses for saving objects to TSM servers.

Libraries and objects:

Use the size of each library.

Folders and documents:

Use the size of library QDOC.

Directories and files:

*LINK save or calculated size or size specified in QUSRBRM/Q1ATSMSIZE data area, then maximum of that size or 128 megabytes.

Spoiled files

Use 512 megabytes

The estimated size is then increased another 5% to allow for descriptors and check sums inserted into the save data stream by the operating system.

Using estimated saved object sizes provides better save performance than determining the actual saved object. The BRMS estimated size tends to be over estimated. Over estimating objects sizes may impact TSM client operations if the target disk storage pool is not of sufficient size. If you run multiple BRMS clients sessions to the same disk storage pool, other client sessions using the same disk storage pool could be ended due to lack of storage.

Steps at the TSM Client

1. Install the TSM Application Program Interface (TSM APIs)

If you have the TSM APIs on CD-ROM, use the following command: RSTLICPGM(5733197) DEV(device name where device-name is the name of the device for the CD-ROM that contains the Tivoli Storage Manager Client API (TSM APIs).

If you downloaded the APIs from the Internet, use the following command: RSTLICPGM LICPGM(5733197) DEV(*SAVF) SAVF (library-name/save-file-name) where the SAVF parameter specifies the library and the save file that contains the TSM APIs.

2. Install BRMS

You can find information on how to install BRMS in Chapter 2, “Installing and Initializing BRMS,” on page 9.

3. Add a location for your TSM server

If you have more than one TSM server create a unique BRMS location for each TSM server. If you also use a BRMS network, this location will automatically be sent to others systems in the network.

To get to the Work with Storage Locations display, type WRKLOCBRM at a command line and press Enter.

```

Work with Storage Locations                                RCHAS400

Position to . . . . . Starting characters

Type options, press Enter.
 1=Add  2=Change  3=Copy  4=Remove  5=Display  6=Work with media
 7=Work with containers

Opt  Location      Volumes  Containers  Text
 1   TSMSEVER
    *HOME           97         1   Entry created by BRM configuration
    VAULT           0         0   Entry created by BRM configuration

Bottom

F3=Exit  F5=Refresh  F12=Cancel

```

- a. At the Work with Storage Locations (WRKLOCBRM) display, type a 1 (Add) in the *Opt* field.
- b. Then type a name for your TSM server in the *Location field* and press Enter. This takes you to the Add Storage Location display.

```

Add Storage Location

Type choices, press Enter.

Storage location . . . . . TSMSEVER  Name
Address line 1 . . . . . Computer room, parent location.
Address line 2 . . . . .
Address line 3 . . . . .
Address line 4 . . . . .
Address line 5 . . . . .
Contact name . . . . . Jennie Doe
Contact telephone number. . . . .
Retrieval time . . . . . .0      Hours
Allow volumes to expire . . . . . *NO      *YES, *NO
Media slotting . . . . . *NO      *YES, *NO
Text . . . . . TSM server location

F3=Exit  F12=Cancel

```

- c. Use the address fields on this display to document the location of the TSM server. You can use the contact information fields to identify the TSM administrator and other important contacts.
- d. Use the default values in the *Allow volumes to expire* and the *Media slotting* fields.

- e. In the *Text* field, type a description for this TSM location.
- f. Press Enter to save the location information.

4. Create a media policy

BRMS media policies used with TSM servers determines how long the objects stored on the TSM server are maintained in BRMS history. When the retention period expires, and the object will be deleted from the TSM server and BRMS history the next time maintenance is run. It is important to always explicitly specify the location when using the media policy for TSM servers.

Take the following steps to create a media policy for your TSM server:

- a. At the Work with Media Policies display, type a 1 in the *Opt* column.
- b. Type a policy name in the *Policy* column.
- c. Press Enter to prompt the Create Media Policy display.

Create Media Policy

Type choices, press Enter.

Media policy	TSM	Name
. 2	1=Date, 2=Days,	3=Versions, 4=Permanent
Retain media	35	Date, Number
Move policy	*ADSM	Name, *NONE, *ADSM, F4
Media class	*ADSM	Name, *SYSPCY, *ADSM, F4
Storage location	TSMSEVER	Name, *ANY, F4 for list
Save to save file	*NO	*YES, *NO
ASP for save files	*SYSTEM	Name, *SYSTEM, 1-32
Save file retention type	4	1=Date, 2=Days,
		3=Permanent, 4=None
Retain save files	*NONE	Date, Number, *NONE
ASP storage limit	*SYS	*SYS, 1-99
Secure media	*ADSM	*YES, *NO, *ADSM
Text	TSM media policy.	

More....

F3=Exit F4=Prompt F5=Refresh F12=Cancel

- d. Set the *Retention type* and *Retain media* fields, to the length of time you want saved objects using this media policy to be stored on the TSM server. BRMS manages the retention of the object on the TSM server. When the object expires in BRMS history and is removed from history, BRMS deletes the object from the TSM server.

Notes:

- 1) If you are using an IBM Data Retention 450 (DR450) or DR550 servers, the retention is also managed by the data retention server. A saved object cannot be deleted from BRMS history if that object has not expired on the data retention server. If you are using a data retention server, make sure the setting for the *Retention type* and *Retain media* fields match the retention of the TSM Management Class you specify in the *TSM management class* field.
- 2) If an object is saved to a data retention server and has not expired at the data retention server, attempts to delete the object from BRMS history will result in exception *BRM2327-Errors occurred removing item from TSM server* with reason *0248-A delete of this object is not allowed*.
- e. In the *Move policy* field, specify the *ADSM value. This name indicates that a TSM policy, rather than a BRMS policy, manages media movement.
- f. Specify *ADSM in the *Media class* field. This indicates that BRMS media classes will not be associated with TSM devices.
- g. Set the *Storage location* field to the value that you specified in Step 3.

Note: BRMS does not recommend using special value *ANY for this field. Using this special value could result in saved objects being directed to the wrong TSM server if you use this media policy concurrently with *MEDCLS for the device. When *MEDCLS is used for the Device

(DEV) parameter with save commands to backup control groups, the device is chosen based on location. If *ANY is also used, any device can be selected.

- h. Specify *ADSM in the *Secure media* field. This indicates that a TSM policy, rather than a BRMS policy, secures your data.

```

                                Create Media Policy

Type choices, press Enter.

Required volumes . . . . . *NONE      *NONE, 1-9999
Mark volumes for duplication . . . *NO      *NO, *YES
Mark history for duplication . . . *NO      *NO, *YES

                                Bottom

F3=Exit  F5=Refresh  F12=Cancel

```

- i. In the *Text* field, type in a description for this TSM policy. Then page down to the next Create Media Policy display.
- j. Use the default value of *NONE in the *Required volumes* field, and *NO for the *Mark Volumes for Duplication* and *Mark History for Duplication* fields. The TSM policy, rather than the BRMS policy, manages these activities.
- k. Press Enter to review the additional fields:

```

                                Create Media Policy

Type choices, press Enter.

Required volumes . . . . . *NONE      *NONE, 1-9999
Mark volumes for duplication . . . *NO      *NO, *YES
TSM management class . . . . . BRMS
TSM security:
  TSM node . . . . . APPN.RCHAS400
  TSM password . . . . . *NONE      Name, *NONE

                                Bottom

F3=Exit  F5=Refresh  F12=Cancel

```

- l. In the *TSM management class* field, specify the BRMS management class name provided by your TSM administrator. Use the default value of STANDARD if you did not receive a management class name from the administrator.
- m. The TSM security parameter has two elements, *TSM node* and *TSM password*. Specify the node name and password that identifies this system to the TSM server. Use the *NONE value in the *TSM password* field only if the TSM server does not require authentication of client operations.
- n. Press Enter to create the media policy.

Note: Media policies are networked to all systems in a BRMS network however, the TSM password is not networked for security reasons. If you change a TSM password for a media policy on one system in the network, you must also change the password on other systems that also use the media policy. One way to avoid managing the password is to use the TSM Password Access Generate function as described in “TSM Automatic Password Management Operation” on page 234.

5. Create a TSM device

You need to create a unique BRMS device for each TSM server you intend to use. BRMS devices are not networked so you will need to create these devices on each system which will use the TSM servers. You can create a TSM device at the Work with Devices (WRKDEVBRM) display. To get there, type WRKDEVBRM at a command line and press Enter. At the Work with Devices display, take the following steps:

- a. Type a 1 in the *Opt* field.
- b. Type a name in the *Device* field. Choose a name that is representative of your TSM server.
- c. In the *Category* field, type in the name of the communications category you want to use. The values for this field are:
 - *APPC: This device will connect to the TSM server by using SNA protocol.

Note: APPC was supported by Version 3 and 4 TSM servers, and is no longer supported by Version 5 TSM servers.

Note: BRMS presents a BRM1240 – Device TSM is not allowed. If the device description does not exist, then you need to create it. Use the WRKDEVD DEVD(*CMN) command to review the available device descriptions. If you cannot find one that describes the remote location of your TSM server, then you need to create this device by using the CRTDEVAPPC command.

- *NET: This device connects to the TSM server by using TCP/IP protocol.

Work with Devices RCHAS400

Position to Starting characters

Type options, press Enter.
1=Add 2=Change 4=Remove 5=Display
8=Work with status

Opt	Device	Category	Type/Model	Text
1	TAPMLB	*TAPMLB	3575/018	Entry created by BRM configuration
	TSMSEVER	*NET		

More...

F3=Exit F5=Refresh F12=Cancel

- d. Press Enter to get to the next display. The title of the next display that you see depends on which category you chose at the Work with Devices display. For example, if you chose *NET, you will see the Add Net Device display.

```

                                Add Net Device
Net device . . . . . : TMSERVER
Type choices, press Enter.
Text . . . . .      TSM Server
Location . . . . .  TMSERVER   Name, F4 for list
TSM file space . . . . . *LCL
Buffer size . . . . . *DEVTYPE   *DEVTYPE, 1-512 KB
Retention protection . . . . . *NO       *NO, *YES
Internet address . . . . . 123.345.567.890
Internet port . . . . . 1500      1-65534

F3=Exit  F4=Prompt  F12=Cancel

```

- e. In the *Text* field, type in a description of the TSM device.
- f. In the *Location* field, type in the name of the location you created in Step 3.
- g. Use *LCL as the default name in the *TSM file space* field. Do not specify a unique file space name unless you clearly understand how TSM uses file spaces.
- h. Specify *YES for *Retention protection* if the TSM device is an IBM Data Retention 450 (DR450) or DR550 server, or any TSM server which uses *Archive retention protection*.
- i. If you specified *NET device for the device category on the WRKDEV display, you must specify an Internet address and port for the TSM server. Enter the TCP/IP address and port information that your TSM administrator provided. Then press Enter to create the device.

6. Change existing control groups to TSM devices

You can easily change an existing control group which uses local devices to use TSM devices provided that the data specified in the control group meets the criteria for user data allowed to be saved on TSM servers. Take the following steps to change an existing control group:

- a. Go to the Work with Backup Control Groups display.
- b. Place an 8 (Change attributes) in the *Opt* field in front of the control group you want to change, and press Enter.
- c. This takes you to the Change Control Group Attributes display.

```

Change Backup Control Group Attributes

Group . . . . . : SAMPLE

Type information, press Enter.

Media policy for:
  Full backups . . . . . TSM          Name, F4 for list
  Incremental backups . . . . . TSM    Name, F4 for list
  Backup devices . . . . . TMSERVER    Name, F4 for list

Parallel device resources:
  Minimum resources . . . . . *NONE    1-32, *NONE, *AVAIL
  Maximum resources . . . . .          1-32, *AVAIL, *MIN
  Sign off interactive users . . . . . *BKUPCY *YES, *NO, *BKUPCY
  Sign off limit . . . . . *BKUPCY    0-999 minutes, *BKUPCY
  Default weekly activity . . . . . *BKUPCY SMTWTF(S/F/I), *BKUPCY
  Incremental type . . . . . *BKUPCY  *CURL, *INCR, *BKUPCY
  Force full backup days . . . . . *BKUPCY 0-365, *NOMAX, *BKUPCY
                                          More...

F3=Exit  F4=Prompt  F12=Cancel

```

- d. Change the full and incremental media policy fields to reflect the name of the TSM media policy you created in Step 4. You can use F4 from the media policy fields to select from a list of media policies.
- e. Change the *Backup devices* field to reflect the name of the TSM device you created in step 5. Press F4 from the *Backup devices* field to select from a list of devices. You can specify only one TSM device on this display.

Note: BRMS does not recommend you use special value *MEDCLS for *Backup devices* which are TSM servers. BRMS recommends you specify the device name.

- f. Roll to the next page of this display and change the value *Automatically backup media information* field to *NONE. This prevents BRMS from storing the media information on the TSM server when the save of this control group completes. BRMS will need this information to print a recovery report that refers to TSM. For this reason, you need to issue a SAVMEDIBRM command after the save to the TSM server.
- g. Press Enter when you have finished with the control group updates.

You are now ready to perform saves to a TSM server while using this control group. You can use the locations, media policies, and devices you just created with other backup or archive control groups.

Using TSM Automatic Password Management

If you have installed Version 4, Release 2, Level 1 or later of the Tivoli Storage Manager Client API, you can use the PASSWORDACCESS GENERATE client option to have new TSM passwords automatically created by TSM when the current passwords expire. You can enable TSM automatic password management using the BRMS client in iSeries Navigator or by creating a special file and member in library QUSRBRM.

Setup using the BRMS iSeries Navigator Client

Take these steps to enable TSM automatic password management using the BRMS iSeries Navigator client.

1. Double-click on the **iSeries Navigator** icon on your desktop.
2. Open a connection to the system from which you want to run the BRMS TSM client.
3. Right-click the **Backup, Recovery and Media Services** folder.
4. Click **Manage Devices**.

5. Click **TSM Connection Names** on the **Manage Devices** Panel.
6. Select the connection name on the **Connection Names** panel which you want to enable for TSM password management.
7. Click **Password Management**
8. Enter the current password for the connection name on the **Password Management** panel to authenticate the password management change.
9. Select **TSM manages password**.
10. Click **OK**.
11. Repeat steps 6 through 9 for additional connections names that are to use TSM password management.
12. Click **OK** on the **Connection Names** panel.
13. Click **Close** on the **Manage Devices** panel.

Setup using a File/Member in Library QUSRBRM

Take these actions to enable TSM automatic password management using a file and member in library QUSRBRM.

- Create a source physical file named QA1AGENPWD in the QUSRBRM library with a member named NODENAMES using the following command:
`CRTSRCPF FILE(QUSRBRM/QA1AGENPWD) RCDLEN(92) MBR(NODENAMES)`
- Change the owner of file QUSRBRM/QA1AGENPWD to QBRMS using the following command:
`CHGOBJOWN OBJ(QUSRBRM/QA1AGENPWD) OBJTYPE(*FILE) NEWOWN(QBRMS)`
- Revoke current public authorities to file QUSRBRM/QA1AGENPWD using the following command:
`RVKOBJAUT OBJ(QUSRBRM/QA1AGENPWD) OBJTYPE(*FILE) USER(*PUBLIC) AUT(*ALL)`
- Grant *USE public authority to file QUSRBRM/QA1AGENPWD using the following command:
`GRTOBJAUT OBJ(QUSRBRM/QA1AGENPWD) OBJTYPE(*FILE) USER(*PUBLIC) AUT(*USE)`
- Use STRSQL and add a record for each node name which you want enabled for PASSWORDACCESS GENERATE using the following SQL command:
`INSERT INTO QUSRBRM/QA1AGENPWD (SRCDTA) VALUES('node-name')`

The inserted node names must follow these rules:

- Each node name must match the node name used in the media policy.
- Enter only one node name for each record.
- Left justify the node name in the record.
- Use upper case when entering the node name.

TSM Automatic Password Management Operation

If the TSM Automatic Password Management function is enabled, BRMS will pass the PASSWORDACCESS GENERATE client option to the TSM server whenever that connection name is used to establish a session with the TSM server. TSM automatic password management is under the control of the TSM APIs and the TSM server. BRMS does not manage the passwords when TSM Automatic Password Management is used. The TSM created passwords are stored in file `/etc/adsm/TSM.PWD` unless you have changed the DSMI_DIR environment variable to specify some other directory. To simplify recovery, make sure this file is backed up regularly to tape media.

When the BRMS TSM client requires a connection to the TSM server, BRMS will first check the *TSM manages passwords* attribute for the current connection (node) name and honor that setting if it exists. This setting will either be set to BRMS manages passwords, TSM manages passwords, or it will be blank.

If the *TSM manages passwords* attribute is blank, BRMS will check for the existence of the TSM node name in the NODENAMES member of file QUSRBRM/QA1AGENPWD. If the connection (node) name does

not exist, BRMS will manage the password. If the connection (node) name exists, BRMS will pass the PASSWORDACCESS GENERATE client option to the TSM server and allows TSM to manage the password.

Using BRMS to Manage Tivoli Storage Manager/PASE Media

The Tivoli Storage Manager for the Portable Application Solutions Environment (TSM/PASE) server provides an exit interface which allows a tape management system like BRMS to perform media operations. BRMS provides four exit programs (**BRMS TSM Exits**) which a TSM administrator can use for defining exits for TSM user-defined libraries using exit-based drive selection. These exit programs are:

QBRM/Q1AMNTTSM

BRMS exit program for allocating devices and mounting a TSM volume.

QBRM/Q1AUNLTSM

BRMS exit program for de-allocating devices and dismounting a TSM volume.

QBRM/Q1ADLTSM

BRMS exit program for deleting volumes from a TSM storage pool.

QBRM/Q1AEXPTSM

BRMS exit program for expiring volumes in a TSM storage pool.

Benefits

Using the BRMS TSM Exits provides the following benefits when using are both BRMS and TSM/PASE on the same iSeries system:

- You can share a common media scratch pool between BRMS and TSM/PASE.
- You can share device resources.
- You can use the BRMS volume reports for reporting TSM/PASE media.
- Avoid having to compile and maintain the sample programs provided by TSM/PASE.

Set up in BRMS

There is very little setup required in BRMS when using the BRMS TSM Exits as the media management system for TSM/PASE. You will need to create a media class in BRMS which will be used exclusively by the TSM/PASE server. When TSM/PASE requires a scratch volume, it will request the volume from BRMS and the volume will be automatically placed into this media class.

Note: It is important the volumes contained in the TSM/PASE media class never be used for any BRMS operations to avoid overwriting TSM data. Only the TSM administrator should add or remove volumes from this media class since the volumes contained in this class must be consistent with the volumes currently defined to the TSM/PASE server storage pools.

Set up in TSM/PASE

Setup of the TSM/PASE media management system is relatively simple.

1. Define a user-defined library specifying *exit* for the drive selection mode.

```
DEFINE LIBRARY library-device-name LIBType=USRDFN DRIVESElection=EXIT
```

where: *library-device-name* is the name of a BRMS device.

2. Define the exits for the user-defined library using the program provided by BRMS.

```
|  
| DEFINE EXIT MOUNT QBRM/Q1AMNTTSM  
| DEFINE EXIT DISMOUNT QBRM/Q1AUNLTSM  
| DEFINE EXIT DELETION QBRM/Q1ADLTTS  
| DEFINE EXIT EXPIRATION QBRM/Q1AEXPTSM
```

3. Define a TSM device class for the user-defined library defined in Step 1.

```
|  
| DEFINE DEVCLASS device-class-name DEVTYPE=device-type  
| FORMAT=device-format LIBRARY=library-device-name
```

where: *device-class-name* is the name of the BRMS media class created in “Set up in BRMS” on page 235 and *library-device-name* is the library name defined in Step 1.

Note: See the DEFINE DEVCLASS command in the **IBM Tivoli Storage Manager for iSeries PASE Administrator’s Guide** for possible values for *device-type* and *device-format* as well as additional parameters for defining the device class.

4. Define the TSM storage pool using the device class defined in Step 3.

```
|  
| DEFINE STGPOOL storage-pool-name device-class-name
```

where: *storage-pool-name* is the name of the sequential storage pool and *device-class-name* is the name device class created in Step 3.

Note: See the DEFINE STGPOOL command in the **IBM Tivoli Storage Manager for iSeries PASE Administrator’s Guide** for additional parameters required when defining the storage pool.

This completes the setup of the TSM/PASE server.

Chapter 14. Networking with BRMS

This chapter provides information on how to create and manage a network of iSeries servers that use BRMS. Before you begin reading, however, do note that **the Network feature is required to used this function.**

The primary reason for implementing a BRMS network would be to maintain a shared media inventory for the systems in the network or to share the backup history information.

In the sections that follow, the term system is used generically to refer to standalone iSeries servers or logical partitions in iSeries server. Each system in a BRMS network must have a unique system name.

Note: BRMS is limited to using 8-character system names. Typically this is the same name as the default local location name in the system network attributes. Any system name you use, whether using APPC or TCP/IP networking must be no longer than 8 characters. The first character of the system name must be alphabetic. The remaining characters of the system name must be alphanumeric or the underscore special character.

Beginning with V5R1M0, you can use TCP/IP to connect with other systems in the BRMS network. However, you must also configure the current system to use APPN/APPC networking if other systems in the BRMS network are not using TCP/IP when communicating with the current system. Go to the following web site to review the BRMS PTF requirements to use TCP/IP with BRMS networked system at releases V5R1M0 and V5R2M0. <http://www-1.ibm.com/servers/eserver/iseries/service/brms/brmstcpip.htm>

An Overview of BRMS Network Functionality

By placing multiple iSeries systems in a BRMS network, you can share BRMS policies, media information, and storage locations across the network group. This allows you to manage backups across all of your iSeries systems in a consistent manner. It also optimizes media use. BRMS shares the following information across the network:

- Container classes
- Container inventory
- Duplication references
- History information (optional)
- Media classes
- Media inventory
- Media policies
- Move policies
- Network groups
- Storage locations

Each iSeries system in a network group receives updates to the media inventory, regardless of which network member makes the change. For example, suppose you have a network of three iSeries systems, SYSTEM01, SYSTEM02, and SYSTEM03, and that you add a media volume (A001) on SYSTEM01. BRMS conveys information about this new volume to all of the systems in the network through a process called **synchronization**. The system receiving synchronization updates from other systems in the network either accepts or rejects the update based on the time stamp of the updated record compared to the time stamp

on the current record. Records with newer dates and times are accepted while records with older dates and times are rejected. So the dates and times of the systems within a BRMS network become very important.

Ideally, a BRMS network performs best if all systems in the network are in the same time zone and are running with dates and times which are consistent across all systems. However, BRMS allows for time differences up to 24 hours between these systems in the event the systems are in different time zones.

Care needs to be taken to avoid systems in a BRMS network which have a time difference that is more than 24 hours resulting in these systems having different dates. BRMS uses dates to determine expiration of media, when volumes need to be moved, and whether synchronization updates are applied.

If business reasons dictate a need to have systems in the network with a greater time difference than 24 hours, you must setup BRMS on these systems as follows:

1. No sharing of media.

The system that has a different time/date compared to the current time/date, will need to use volumes in a no shared media class. This is necessary to ensure any saves to media from this system are not overwritten by other systems or this system does not overwrite the saves on media used by the other systems.

2. No centralized movement.

Media movement on this system will have to be run by control group, move policy or system name as volumes may not move as otherwise expected.

The recommended approach is to avoid time differences between systems that exceed 24 hours.

How Shared Media Inventory Synchronization Works

Figure 12 on page 239 illustrates the process by which BRMS shares the media inventory across a BRMS network. In this example, assume that SYSTEM01, SYSTEM02, and SYSTEM03 exist in a BRMS network.

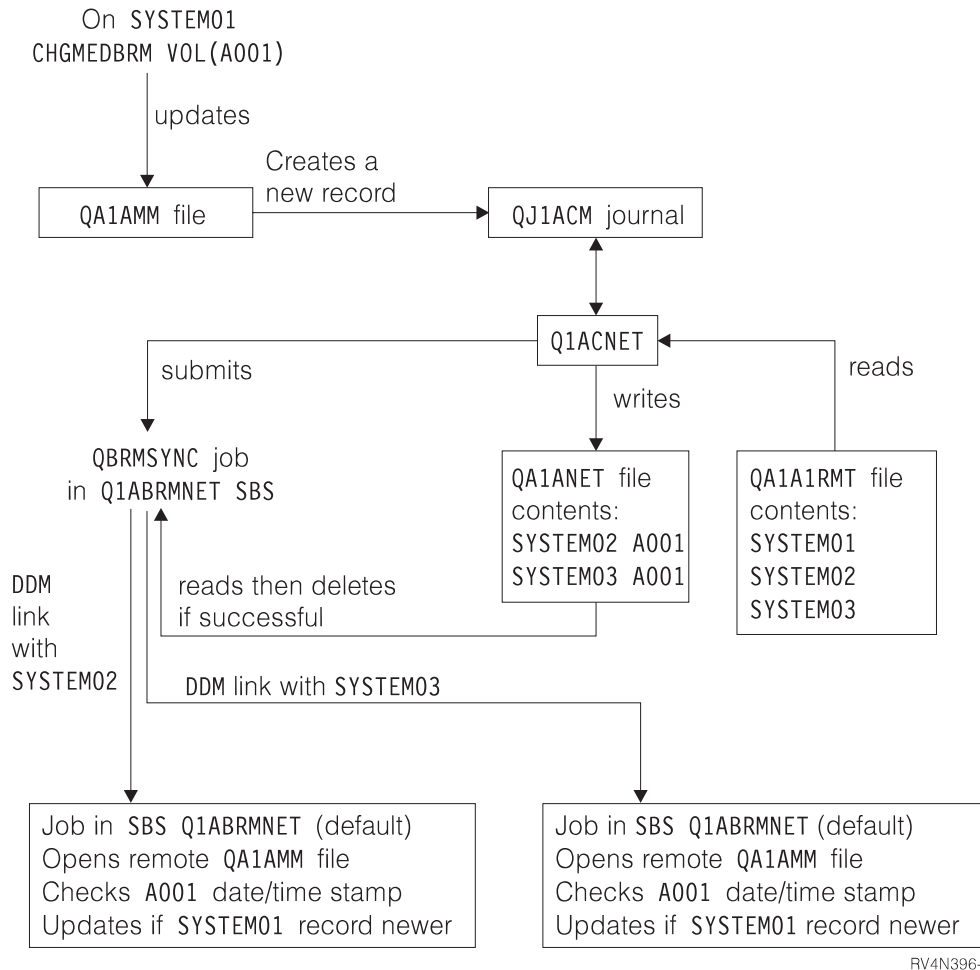

Figure 12. The network synchronization process in BRMS

In Figure 12, the Q1ABRMNET subsystem starts on all of the iSeries systems that participate in the network. BRMS establishes this shared subsystem relationship when you set up the network. BRMS stores job and subsystem descriptions, and information on the job queue it used during network processing, in the QBRM library.

To update data across a network, BRMS performs the following steps:

- BRMS journals the files that contain the shared resource information. These files are QA1AMM for the media, and QA1A1RMT for the systems in the network group. When SYSTEM01 updates media, a policy, or any shared resources, an entry is logged in the QJ1ACM journal in the QUSRBRM library. BRMS captures both before images and after images in the journal receiver for any changes that relate to the media inventory on the networked systems. However, BRMS uses only the after images to update the shared media inventory.
- The Q1ABRMNET subsystem then begins an autostart job that is called QBRMNET. This job periodically monitors the QJ1ACM journal entries and performs the following tasks:
 - Adds one record to the QA1ANET2 file for each change on each system.
 - Adds records to the QA1A2NET file for each file and system change that is reflected in QA1ANET2.

In this example, the network group consists of three systems. If you make updates to SYSTEM01, the Q1ACNET program creates two entries in the QA1ANET2 file. These entries instruct BRMS to send the updates to the remaining two systems.

 - At regular intervals, the QBRMNET job in subsystem Q1ABRMNET checks to see if BRMS should transfer any activity to other systems in the network. You can change the interval value that BRMS

uses to synchronize media information at the *Shared inventory delay* parameter in the system policy. You can set intervals between 30 and 9999 seconds.

- When there is data in file QA1ANET2, the QBRMNET job submits the QBRMSYNC job through the Q1ABRMNET job queue.

BRMS uses QA1A2NET as a key, and reads records from file QA1ANET2. BRMS establishes a distributed data management (DDM) link with the remote system to update the corresponding file on the remote system.

Before performing the update, BRMS compares the date and time stamp of the target record you want to update with the date and time stamp of the source record. BRMS does not perform the update if the source record has the older time stamp.

- Once this update completes, QBRMSYNC deletes the record from QA1ANET2 file and continues with the next record. The QBRMSYNC job ends when the QA1ANET2 file is empty.

To see if your network is working properly, display the QA1ANET2 file. When the network is running properly, the number of records in QA1ANET2 file should be none or decreasing. If the QA1ANET2 file contains any records or does not show a decrease, there may be a problem with the network. In that case, check the QSYSOPR message queue on all of the networked systems. You also need to ensure that:

- Subsystem Q1ABRMNET starts properly.
- Job queue Q1ABRMNET releases properly.
- You vary on the APPC controllers.
- You can PING and/or APING all the systems in BRMS network.
- QBRMS user profile is not in a *DISABLED state.

Note: When performing network synchronization tasks, BRMS always attempts to go through the Q1ABRMNET subsystem first. This subsystem contains a default communications entry that uses the QBRM mode. You should not create your own subsystem descriptions for synchronizing the BRMS network.

How BRMS Networks Communicate

As with many communication products, BRMS uses the default local location name (LCLLOCNAME) rather than the system name (SYSNAME). In most cases, the iSeries servers have the same value specified in LCLLOCNAME as in SYSNAME. BRMS also uses the local network identifier LCLNETID. You can change these values at the Change Network Attribute (CHGNETA) display. You can review the values at the Display Network Attribute (DSPNETA) display. Other network attributes do not affect BRMS.

When you install BRMS Networking, many of the BRMS commands like WRKMEDBRM, WRKMEDIBRM, STRRCYBRM support a FROMSYS parameter allowing you to perform the operation using the data retrieved from the networked system using DDM. If your BRMS network is configured to use TCP/IP, BRMS will attempt to create the DDM file using TCP/IP and if that fails, will attempt again using APPC. If a connection to networked system can not be made, BRMS will use data available on the local system.

The APPC connection method allows a system in restricted state to communicate with other systems in the network which are not in restricted state. This capability is possible using TCP/IP but must be configured to do so. If you need this capability and want to use TCP/IP as your primary communication method see “Configure TCP/IP for Restricted State” on page 242. You should also consider configuring APPC as well as TCP/IP if you want BRMS to use APPC as an alternate communication method when TCP/IP communications is not available. If you have enabled TCP/IP and configured this communications method for use by the BRMS network, and you want to disable APPC, refer to “Disable APPC Operations” on page 244.

Network Configuration

TCP/IP Network configuration

1. Use the following command to verify TCP/IP is running on each of the systems in the BRMS network:

```
PING RMTSYS(remote-system-name)
```

If TCP/IP is not running, then you will need to configure and/or start TCP/IP.
2. You need to determine whether you intend to use secured or non-secured DDM connections to the remote systems in the BRMS network. Non-secured DDM connections perform no password validation, but requires the user profile to exist on the remote system. Secured DDM connections perform password validation, require the user profile to exist on the remote system, and require the password to be the same on the current system as well as the remote system. You may want to review these requirements with your site security administrator before taking specific actions.
 - For Non-secured DDM connections:
 - a. Use the following command to change the TCP/IP DDM attributes for non-secured operations:

```
CHGDDMTCPA PWDRQD(*NO)
```
 - b. If you are going from a secured DDM connection to a non-secured DDM connection make sure to remove the server authentication entries. Use the following command to remove server Authentication entries for each user:

```
RMVSVRAUTE USRPRF(user-profile) SERVER(QDDMSERVER)
```
 - c. Go to step 3.
 - For Secured DDM connections:
 - a. Use the following command to change the TCP/IP DDM attributes for secured operations:

```
CHGDDMTCPA PWDRQD(*YES)
```
 - b. Automated secure TCP/IP DDM operations are not possible if authentication passwords cannot be stored. Use the following command to change the QRETSVRSEC system value so that passwords used for authentication can be stored on the system:

```
CHGSYSVAL QRETSVRSEC VALUE('1')
```
 - c. Use the following command to add server authentication entries for each user who will be authorized to perform secured TCP/IP operations to the remote systems.

```
ADDSVRAUTE USRPRF(user-profile) SERVER(QDDMSERVER)
           USRID(remote-system-userid)
           PASSWORD(remote-system-password)
```

Note: A server authorization entry can be removed using the RMVSVRAUTE command or change using the CHGSVRAUTE command. See the CL Reference manual for a complete description of these commands and command parameters.

Note: There can only be one server authorization entry for a user no matter what remote system is specified. This means that for a user to access multiple systems in the network, the userid and passwords must be the same on all BRMS networked systems.
 - d. Use the following command to add a server authentication entry for BRMS. This entry is used to perform secured TCP/IP network synchronization to the remote systems.

```
ADDSVRAUTE USRPRF(QBRMS) SERVER(QDDMSERVER)
           USRID(remote-system-userid)
           PASSWORD(remote-system-password)
```

Notes:

- 1) Do not use user profile QBRMS for the remote system userid. Create a new user profile and specify user profile **QBRMS** for the **Group profile (GRPPRF)** parameter of the remote system user profile. Use this new remote system userid for the **User ID (USRID)** parameter of the **Add Server Authentication Entry (ADDSVRAUTE)** command.

- 2) You must also have *USE authority to the **Create DDM File (CRTDDMF)** command on the current system.
3. Use the following command to change the TCP/IP DDM server attributes if you want the server automatically started when TCP/IP is started:
CHGDGMTCPA AUTOSTART(*YES)
4. Use the following commands to end and restart the TCP/IP DDM server if you changed any of the attributes:
ENDTCPSVR SERVER(*DDM)
STRTCPSVR SERVER(*DDM)
5. Enable BRMS to use TCP/IP
 - V5R1 system:
Use the following command to create a specific data area object that BRMS uses to determine whether or not to perform TCP/IP operations:
CRTDTAARA DTAARA(QUSRBRM/Q1ATCPIP) TYPE(*CHAR)
LEN(1) TEXT('TCP/IP Enabled system')

Note: Users upgrading from V5R1 also needs to follow these steps even though your TCP/IP is currently enabled.

Use following steps to enable TCP/IP.

- a. Type following command :
WRKPCYBRM TYPE(*SYS)
- b. Press Enter.
- c. Select option 4 to *Change network group*.
- d. Enter *YES for *Enable for TCP/IP*.
- e. Press Enter.

You have completed enabling this system for TCP/IP operations. You will need to indicate to BRMS that you have enabled this system for BRMS network operations when you configure the network group for this system.

Configure TCP/IP for Restricted State

If you use the BRMS Network feature and use a shared media inventory among systems in the network, BRMS may need to access another system in the network during the backup to take ownership of a scratch volume owned by another system. This usually occurs when all volumes owned by the current system have been used. If this situation occurs while you are in restricted state the backup will end with an exception due to volumes not being available. You can configure BRMS to start up a TCP/IP interface which it can use to communicate with other systems in the network while in restricted state.

Note: BRMS will not start any TCP/IP restricted state interfaces if the current system is not in restricted state. If you require BRMS restricted state network operations, and use your own programs or use exits to end the subsystems, you must assure you have achieved restricted state before continuing with the BRMS operations. Otherwise, the BRMS operations may continue before restricted state is achieved.

Restrictions

The following restrictions apply when the operating system is running in restricted state:

- Only one interface can be started for a specific line type of either Ethernet (*ELAN), Token-ring (*TRLAN) or DDI (*DDI).
- The interface cannot be attached to a network server description (*NWSD) or a network interface description (*NWID).

- This function is not available V5R1M0 due to operating system limitations.
- BRMS PTF SI08486 is required to enable this function for V5R2M0.

Configuration steps

Use the following commands to either add or remove TCP/IP interfaces to a list of interfaces that BRMS is to use during restricted state.

To add a restricted state TCP/IP interface:

```
CALL QBRM/Q1AOLD PARM('TCPPIFC' '*ADD' 'internet-address')
```

where *internet-address* is the internet address, in nnn.nnn.nnn.nnn format, of the interface that you want to add to the list.

To remove a restricted state TCP/IP interface:

```
CALL QBRM/Q1AOLD PARM('TCPPIFC' '*REMOVE' 'internet-address')
```

where *internet-address* is the internet address, in nnn.nnn.nnn.nnn format, of the interface that you want to remove from the list.

Relational Database Configuration

If you are not using the BRMS iSeries Navigator client you can skip this configuration step. However, if you intend to use the BRMS iSeries Navigator client on the current system to view the backup history from another (remote) system in the BRMS network, a Relational Database Directory entry must exist on the current system for the remote system containing the backup history. This is required so that BRMS can establish an SQL connection with the remote system and retrieve the backup history information.

1. From the green screens on the current system, use the Work with Relational Database Directory Entries (WRKRDBDIRE) command to display the current list of Relational Database Directory Entries.
2. If the entry exists, note the entry name.
3. If the entry does not exist, create the entry.

Note: BRMS is limited to using 8-character system names. Typically this is the same name as the default local location name in the system network attributes. Any system name you use, whether using APPC or TCP/IP networking must be no longer than 8 characters. The first character of the system name must be alphabetic. The remaining characters of the system name must be alphanumeric or the underscore special character.

4. Using the BRMS iSeries Navigator client on the current system, click on the Display Global Policy Properties task.
5. Click on the Network tab.
6. Click Manage Systems.
7. Find and select the remote system in the Manage Network Systems panel.
8. Click Edit.
9. Enter the Relational Database Directory Entry name for Relational database.
10. Click OK.
11. Click Close on the Manage Network Systems panel.
12. Click OK on the Global Policy Properties panel.

APPN Network configuration

If you use Advanced Peer-to-Peer Networking® (APPN) with auto configuration, communication between iSeries servers should be fairly simple. If Display Station Pass Through (STRPASTHR) works, and if you can use the SNA distribution services (SNADS) successfully, then your BRMS networking should also work.

In addition, with APPN, and auto configuration enabled, you do not need to manually recreate the APPC controller and APPC device descriptions if you decide to change your system name or your network identifier. You can simply vary off and delete the old controller and device descriptions, and allow APPN to automatically create the definitions for you.

Enter the command, DSPCFGL CFGL(QAPPNRMT), to check the secure status of the systems in your APPN network. Make note of the value in the *Secure loc* field, which appears on the Display Configuration List display. You will need to know this later when you add these system to the BRMS network. For additional information on APPN security, see the iSeries Communications topic under Networking in the iSeries Information Center.

```

Display Configuration List

Configuration list . . . . . : QAPPNRMT
Configuration list type . . . . . : *APPNRMT
Text . . . . . :

-----APPN Remote Locations-----
Remote      Remote      Local      Remote      Control
Location    Network   Location   Point       Net ID     Secure
ID          ID
SYSTEM01 APPN      SYSTEM02  SYSTEM01  APPN      *YES
SYSTEM06 APPN      SYSTEM02  SYSTEM06  APPN      *YES
SYSTEM07 APPN      SYSTEM02  SYSTEM07  APPN      *YES

```

If the value is *NO, you are using a non-secured network, you need to ensure that the QBRMS, QUSER, and QPGMR user profiles are enabled on those systems which you intend to add to the BRMS network.

If the value is *YES, you are using a secured location network.

APPC Network configuration

If you use APPC communications, you need to create your own APPC controllers and devices. You must ensure that you specify correct remote system information when creating the controller description. For example, the Remote network identifier, Remote Control point, and Remote System Name values relate to the remote system. You must use the QBRM mode for the *Mode* parameter on the APPC device description. The default for this value is *NETATR, which might use the BLANK mode description.

If you use advanced program-to-program communications (APPC), you also need to change your APPC controller device descriptions if you change the name of your network or the local location name. You must do this because you cannot delete and allow the system to automatically create your definitions, as you can in APPN.

Disable APPC Operations

If you have configured BRMS to use both the TCP/IP and APPC communications methods, BRMS will use TCP/IP as the primary communications method. BRMS will automatically attempt to use the APPC communication method, if TCP/IP operations fail. You may choose to disable BRMS from using APPC in order to simplify your configuration. However, if you disable APPC, you eliminate some of the built in network recovery provided by BRMS.

Use the following command to disable SNA operations for systems in the BRMS network.

```
QSYS/CALL QBRM/Q1AOLD PARM('ALIASNAME' '5' '*SNA' '*DISABLE' 'system-name')
```

Use the following command to re-enable SNA operations for systems in the BRMS network.

```
QSYS/CALL QBRM/Q1AOLD PARM('ALIASNAME' '5' '*SNA' '*ENABLE' 'system-name')
```

where *system-name* specifies the name of the system which is to be enabled or disabled. *System-name* is specified as *nnnnnnnnn.cccccc* or *ccccc* where *nnnnnnnnn* is the network identifier and *ccccc* is the system name. The special value *ALL can be specified for *system-name* to enable or disable SNA operations for all the systems in the BRMS network.

Notes:

1. These commands must be run on all systems in the BRMS network.
2. All parameters for these command must be entered in uppercase.
3. BRMS PTF SI08485 is required if you want to use this support on V5R1M0.
4. BRMS PTF SI08486 is required if you want to use this support on V5R2M0.

How to Set Up a BRMS Network

This section provides instruction on how to set up your network group. IBM delivers the BRMS Network feature with a predefined network group that is named *MEDINV. Currently there is no way in which you can create different network groups. You can only work with the one that is shipped. *MEDINV contains no entries for systems that participate in the network group. **Setting up the BRMS network group is simple as long as you follow these steps.**

Before you begin, be sure that you fully understand the implications of adding and removing systems to and from the BRMS network. Some of the planning issues you should consider are:

- Ensure that you have a full backup of the QUSRBRM library on all of the iSeries servers that you plan to put in the network group. The BRMS network setup changes some critical files in the QUSRBRM library. If the network fails, you need to restore the QUSRBRM libraries to their original state.
- Ensure that you have the latest BRMS PTFs installed on your systems. You should also install any dependent i5/OS PTFs) and the Licensed Internal Code.
- Ensure there is no current BRMS activity (for example, backup, recovery, or maintenance) on the systems that you plan to network.
- Ensure that your BRMS operation is error free, and that there are no outstanding issues with the normal operations. You also need to give some thought to volume names, media policies, containers, and classes. You cannot have duplicate volume names within a shared media inventory.

A Step-by-Step Guide to Setting Up Your BRMS Network

This example shows how to establish a BRMS network between two iSeries servers, SYSTEM01 and SYSTEM02. For best results, follow the steps in the order in which they appear, and complete each step before moving on to the next. Be sure that you perform all of the steps when setting up your network.

1. Save library QUSRBRM on SYSTEM01.
2. Save library QUSRBRM on SYSTEM02.
3. Ensure that the communications link on SYSTEM01 for SYSTEM02 is active.
4. Perform the following:

For TCP/IP

Use WRKTCPSTS OPTION(*IFC) to determine the status of the TCP/IP interfaces.

For APPC

Use WRKCFGSTS command to determine status for line (*LIN), controller (*CTL), and device description (*DEV).

5. Designate SYSTEM01 to be your master system.
6. Ensure there is no BRMS activity on either system.
7. On SYSTEM01, type WRKPCYBRM *SYS to get to the system policy menu. Once there, take the following steps:
 - a. Select option 4 (Change Network Group). Press Enter.

- b. Change the *Enable for TCP/IP* field from *NO to *YES if you are using TCP/IP to communicate with other systems in the network.
- c. To add SYSTEM02 to the master system to create the network, type SYSTEM02 in the *Remote location* field. Then type the name of the remote network in the *Remote Network ID* column.

```

Change Network Group                                SYSTEM01 APPN
Network group . . . . . : *MEDINV                    Position to . . . . . :
Text . . . . . : Entry created by BRM configuration
Receive media info . . : *NONE                       *NONE, *LIB
Enable for TCP/IP . . . : *YES                        *NO, *YES
Notify period . . . . . : 3600                       30-99999 seconds
Type options, press Enter.
  1=Add  4=Remove  8=Set time
      Remote Local  Remote  Receive  System  Network
Opt Location Name  Network ID Media Info Status  Status
1  SYSTEM02      APPN

```

F3=Exit F5=Refresh F12=Cancel

- d. Press Enter. BRMS searches the network for the system name that you specified. Depending on the network configuration and the number of systems in the network, this can take a few minutes. When BRMS finds the system name (in our example, SYSTEM02), BRMS adds it to *MEDINV (the BRMS network group name). SYSTEM02 is still an inactive member of the network group and does not share its media inventory with other active systems in the network. To change the inactive status to active, media inventory must be copied to the system being added to the network group. The process to copy the media inventory and media history information occurs in Step 10.
8. On SYSTEM02, use the Work with Media (WRKMEDBRM) command to see if any media information exists. If media information does not exist, go to step 9. Because BRMS is fully operational, media information exists on SYSTEM02. Perform the following steps to copy media information from one file to another:
 - a. Use the CPYMEDIBRM OPTION(*TOFILE) (Copy Media Information to file) command to copy the contents of the media inventory file. You can copy the information to a temporary file (QA1AMED) or to a file name you create. BRMS creates this temporary file in your *Current Library*. You can also copy media information from the *Copy media information* parameter on the Copy Media Information display. Use the default value of *NO unless you plan to restore media information to a non-networked system.

Notes:

- a. You do not have to perform step 8 if the system you want to add to the network does not contain media information.
 - b. The CPYMEDIBRM command copies the files for the following: media class, locations, media policy, containers, container classes, move policies, move policy rules, media, and possibly history.
 - c. If you put the *FROMFILE value in the *Type of copy* field, BRMS changes the system name for media and history records to the new system name. The *TOFILE value copies the media and history records that are on the current system.
9. Now activate SYSTEM01 in the BRMS network with SYSTEM02. Enter the following command from SYSTEM02.

```
INZBRM OPTION(*NETSYS) FROMSYS(APPN.SYSTEM01)
```

BRMS clears the media management files on the inactive system (SYSTEM02) during the copy process and replaces them with the network media management files. BRMS sends a message when it overwrites the SYSTEM02 files with files that come from SYSTEM01.

```

      Display Program Messages

Job 047122/A960103D/QPADEV0001 started on 05/31/99 at 09:15:55 in subsystem:
Entries exist for Media. (R I C)
Entries exist for Media policy. (R I C)
Entries exist for Media class. (R I C)
Entries exist for Location. (R I C)
Entries exist for Move policy. (R I C)

Type reply, press Enter.
Reply . . . _____
_____

F3=Exit  F12=Cancel

```

BRMS copies the following media management files to the inactive system:

- QA1ACN: Container status inventory
- QA1ACT: Container class
- QA1ADXR: Media duplication reference
- QA1AHS: History information

Note: This file is only copied when you specify *LIB in the *Receive media information* field on the Change Network Group display.

- QA1AMM: Media inventory
- QA1AMP: Move policies
- QA1AME: Media policy attributes
- QA1AMT: Media class attributes
- QA1ASL: Storage locations
- QA1ARMT: Network group
- QA1A1MP: Move policy entries
- QA1A1RMT: Remote system name entries

After BRMS copies the network media inventory to the inactive system (SYSTEM02), the status of the inactive system changes to active. Then its media inventory becomes part of the network media inventory.

On SYSTEM02, select the option to ignore all of the messages by replying with an "I." These messages indicate that you are about to overwrite files on SYSTEM02.

Notes:

- a. When BRMS networking is operational, the above physical files are journaled to QUSRBRM/QJ1ACM *JRN. These files should never be journaled to any other library or journal.
- b. You need to ensure that the QBRMS and QUSER user profiles are not in a *DISABLED state. Communication entries in subsystem Q1ABRMNET use the QBRMS user profile, and if it is disabled, you cannot establish a DDM connection.

| After you add the new system to the network the *Network Status* for SYSTEM01 shows active status
 | indicating that it has been activated on the network, and the *System Status* for SYSTEM01 shows
 | online status if SYSTEM02 and SYSTEM01 are communicating.

Note: *System Status* is the state of the network system the last time the current system attempted communication. The status is updated periodically as determined by the current setting of the *Shared inventory delay* prompt in the System Policy.

Because this example uses only two systems, you can only see the status for the system you are currently adding, in this case SYSTEM01. This display does not show an entry for the system you are on.

```

Change Network Group                      SYSTEM02 APPN
Network group . . . . . : *MEDINV          Position to . . . . . :
Text . . . . . :
Receive media info . . : *LIB              *NONE, *LIB
Enable for TCP/IP . . . : *YES             *NO, *YES
Notify period . . . . . : 3600             30-99999 seconds
Type options, press Enter.
  1=Add  4=Remove  8=Set time
  Remote Local  Remote  Receive  System  Network
Opt Location Name Network ID Media Info Status  Status
-----
      SYSTEM01  APPN    *NONE   Online   Active

Bottom

F3=Exit  F5=Refresh  F12=Cancel

```

In addition, the process of networking the two systems automatically starts a new subsystem that is called Q1ABRMNET. You can find a description of Q1ABRMNET in library QBRM. BRMS also adds an a autostart job entry for this subsystem to the QSYSWRK library on both systems.

```

Work with Subsystems                      SYSTEM01

Type options, press Enter.

4=End subsystem  5=Display subsystem description
8=Work with subsystem jobs

-----Subsystem Pools-----
Opt Subsystem  Total Storage (K)  1  2  3  4  5  6  7  8  9  10
---
--- QBATCH      0      2
--- QCMN        0      2
--- QCTL        0      2
--- QINTER      0      2  4
--- QSERVER     64000  2  5
--- QSNADS      0      2
--- QSPL        0      2  3
--- QSYSWRK     0      2
--- Q1ABRMNET   0      2

```

10. On SYSTEM02, check the system value QDATE and make corrections as needed.
11. On SYSTEM01, check the system value QDATE and make corrections as needed.
12. Go to SYSTEM02. Now you can merge the media inventory data that BRMS saved prior to adding the system to the network under Step 9. Enter the following command on SYSTEM02: CPYMEDIBRM OPTION(*FROMFILE).

Note: You must perform this step if the old system contained BRMS media inventory. BRMS ignores media information that is inconsistent with the new network level media information. BRMS adds all entries except duplicates to the network media inventory. If duplicate media contains

active files, you must keep track of the information. If the media does not contain active files, you should re-initialize the tape with a new volume ID.

Note: When you copy the media inventory from the temporary file (QA1AMED or a file name you created), review the common classes for inconsistencies. For example, the media class SAVSYS on one system might use a media density of *QIC120, while the same media class on another system uses *FMT3490E. All media density now belongs to the network class SAVSYS.

13. Enter the WRKMEDBRM command on SYSTEM02. There you can see the media inventory for SYSTEM01 and SYSTEM02.
14. Enter the WRKMEDBRM command on SYSTEM01. There you can see the media inventory for SYSTEM02 and SYSTEM01.

Manage Your BRMS Network Using the BRMS iSeries Navigator Client

A simpler approach to managing your BRMS network is to add and remove systems in the network using the BRMS iSeries Navigator client. The BRMS client performs many of the setup functions for you and minimizes the number of steps. To get to the BRMS network functions in the BRMS iSeries Navigator client:

- Right click on the Backup Recovery and Media Services folder.
- Click Global Policy Properties.
- Click on the Network tab.
- Click Manage Systems.
- Click Browse to get a list of systems in the network or enter a System Name and Network Identifier of the remote system.
- Add alias names, if any, used to identify the remote system on the network if it is something other than the default local location name as defined in that systems network attributes. You can specify the value *None* for *TCP/IP alias*, *APPC alias* or *Relational database*, if you want to prevent BRMS from using that particular communication method.
- Add the relational database name if any that is to be used to connect to the remote system for remote relational database operations. This name must have a matching Relational Database Directory Entries on the current system. Use the Work with Relational Database Directory Entries (WRKRDBDIRE) to view the current entries.
- Click Add.
- Click Activate.

The system will be added to the current network.

Changing the System Name

You should change a system name very carefully. Many internal definitions can depend on the system name, including PC networking definitions and the system directory. Consult your network support personnel to resolve issues that relate to configuration objects.

Inherent in a system name change is a change in the default local location name, and hence, a change for BRMS. When this happens, BRMS does the following:

- Updates the network to remove the old system name and add the new system name.
- Transfers all of the media previously owned by the old system name to the new system name.

To change your system name, take the following steps:

1. Change the system name and IPL.

Note: After you change the system name and IPL, you must change the BRMS network immediately. BRMS did not yet update the media inventory to reflect the name change. Thus, the old system name still owns the media volumes. In addition, the other systems in the network will continue

to try to contact the old system because they are not yet aware of the name change. *To avoid missing any information in the shared media inventory data, you must change the BRMS network immediately after the IPL.*

2. Ensure there is no BRMS activity occurs on the system between the IPL and adding your system name to the BRMS network. Also ensure that you have a copy of the latest save of the BRMS QUSRBRM library.
3. Enter GO BRMSYSPCY on the system for which you have just changed the name.
4. Select option 4 (Change network group) from the System Policy menu. On the top right corner of the display, you can see your new system name.

```

Change Network Group                                NEWSYS APPN
Network group . . . . . : *MEDINV                Position to . . . . .
Text . . . . . : Entry created by BRM configuration
Receive media info . . : *NONE                    *NONE, *LIB
Enable for TCP/IP . . . : *YES                    *NO, *YES
Notify period . . . . . : 600                      30-99999 seconds
Type options, press Enter.
  1=Add  4=Remove  8=Set time
  Remote Local  Remote  Receive  System  Network
Opt Location Name Network ID Media Info Status Status
-  NEWSYS      APPN      *NONE   Online  Active
4  OLDSYS      APPN      *NONE   Offline Active

Bottom

F3=Exit  F5=Refresh  F12=Cancel

```

5. Select option 4 (Remove) to remove the old name. Press Enter to confirm the name you want to remove.
6. On the Confirm Remove of Network Systems display, specify *RENAME on the *Remove media* field so that BRMS can transfer ownership of the media inventory from the old system to the new one.

How the Networked Systems Receive Media Information

Every iSeries system in a BRMS network group receives media inventory updates, regardless of which system makes the change. You can instruct BRMS to update the media content information. To do so, take the following steps:

1. Type WRKPCYBRM *SYS at a command line. Press Enter. This takes you to the System Policy menu.
2. Select option 4 (Change Network Group). This takes you to the Change Network Group display.

```

Change Network Group                                RCHAS400
Network group . . . . . : *MEDINV                Position to . . . . .
Text . . . . . : Entry created by BRM configuration
Receive media info . . : *NONE                  *NONE, *LIB
Enable for TCP/IP . . . : *YES                  *NO, *YES
Notify period . . . . . : 600                   30-99999 seconds
Type options, press Enter.
  1=Add  4=Remove  8=Set time
      Remote Local  Remote  Receive  System  Network
Opt Location Name Network ID Media Info Status  Status
-----
1  SYSTEM04  ITSCNET  *LIB  Offline  Inactive

F3=Exit  F5=Refresh  F12=Cancel
System SYSTEM04 network group ITSCNET added.

```

3. Change the value in the *Receive media information* field to *LIB. The default value for this field is *NONE, which indicates that BRMS can share only media information with this system. Thus, to review the contents of a volume belonging to another system on this system, BRMS must use DDM to retrieve the information. In this case, then, BRMS must have an active communications link to DDM.

The system **does not** require DDM to retrieve this information if you use the *LIB option. To do so, select option 13 (Display contents) from the Work with Media display. Option 13 takes you to the Work with Media Information display. If a failure occurs, you can use synchronized media information to build a recovery report for the failed system. You can use this local database to recover objects that belong to another system.

4. Press Enter to apply your changes.

You can change the *Receive media information* field at any time. The synchronization process may take longer if your network contains a large number of media information records. Therefore, you should not change the *Receive media information* field frequently.

If you want to add a previously networked system that still contains a media inventory, ensure that you do not move the media inventory from the old system to an existing one. Specifically, **do not** run the INZBRM *NETSYS command on the existing system when you add the old system to the network. Instead, run the INZBRM *NETSYS command on the new system to the existing system by using the FROMSYS parameter.

Note: If you share a 3494 tape library device with multiple iSeries servers in a BRMS network, you must use identical library names throughout the network systems.

Once the network is operational, you should regularly verify that it is working properly. For more information about how to verify your network, see “Checking BRMS Network Synchronization” on page 254.

Joining Two BRMS Networks

With careful planning and implementation, you can join two or more BRMS networks in a single network group. Figure 13 on page 252 shows the wrong way to join the networks.

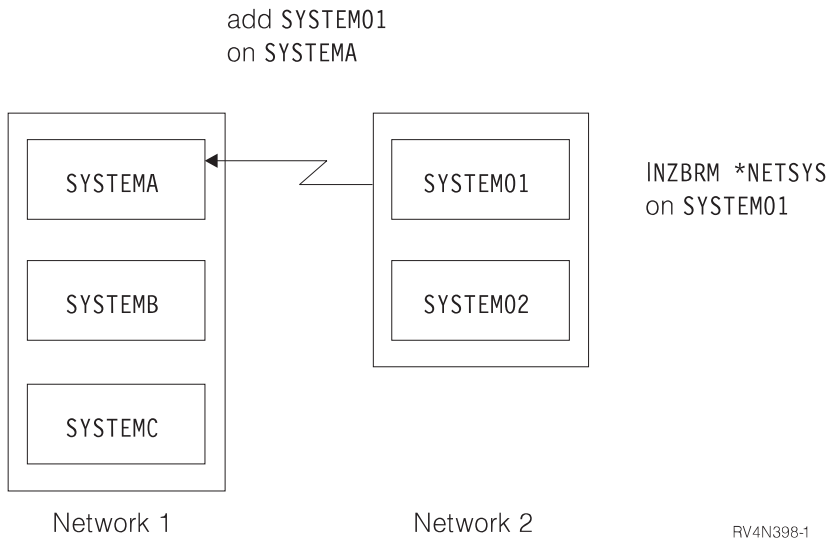
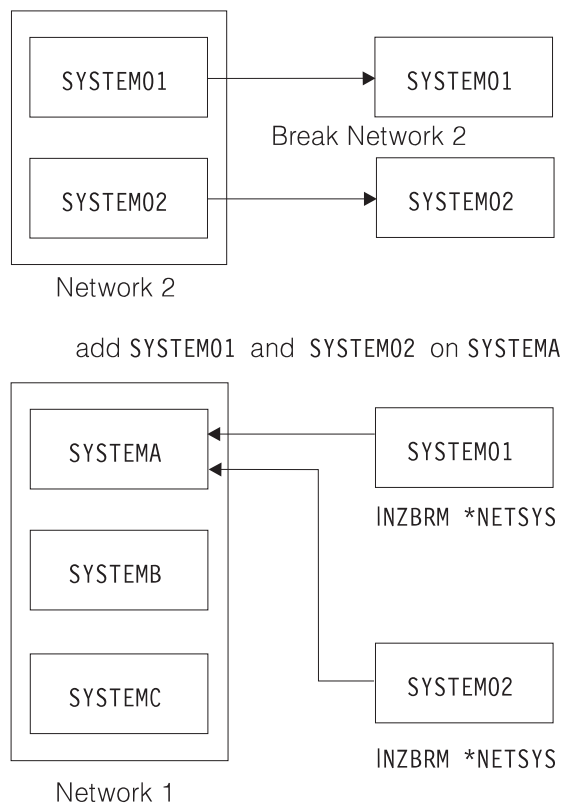

Figure 13. The wrong way to join two BRMS networks

Figure 14 on page 253 shows the correct way to join two networks. In this example, the administrator set up a network between SYSTEM01 (NETWORK2) to SYSTEMA (NETWORK1). By using this approach, SYSTEM02 remains unknown to all of the systems in NETWORK1. The INZBRM OPTION(*NETSYS) command that you ran on SYSTEM01 erased its knowledge of SYSTEM02. To avoid this, you must split one of the networks before joining them so that all of the systems in the network have knowledge of each other.



RV4N399-1

Figure 14. The correct way to join two BRMS networks

Take the following steps to successfully join two BRMS networks:

1. Remove all of the entries on the Change Network Group display on SYSTEM01 for SYSTEM02, including its media information.
2. Remove all of the entries on the Change Network Group display on SYSTEM02 for SYSTEM01, including its media information.
3. Enter the CPYMEDIBRM OPTION(*TOFILE) CPYMEDI(*YES) command on SYSTEM01 and SYSTEM02 to save the media information for both systems.
4. Add SYSTEM01 on any system in NETWORK1 by using the Change Network Group option. In this example, you used SYSTEMA to add SYSTEM01.
5. On SYSTEM01, enter INZBRM OPTION(*NETSYS) FROMSYS(SYSTEMA) to overwrite the media information files on SYSTEM01 from SYSTEMA.
6. On SYSTEM01, you need to enter CPYMEDIBRM OPTION(*FROMFILE) command to append the media information on SYSTEM01. This synchronizes the SYSTEM01 media information on all other iSeries servers within the network. You will receive several messages when BRMS overwrites the files. Reply with an "I."
7. On SYSTEM01, you can use the WRKMEDBRM command to check the media information.
8. Repeat steps 4, 5, 6, and 7 for SYSTEM02 by substituting the name of SYSTEM01 with SYSTEM02 in the steps.

Copying Control Groups Between Networked iSeries Servers

With BRMS, you can specify whether to copy control groups on your own system or send the information to other systems in the BRMS network. *LCL is the default value when you copy a control group, which means that BRMS copies the control group to another name on your local system. You can also specify a remote system name and the network identifier for the remote system. This copies the

control group to the target system that you specified. BRMS uses DDM to copy the information across to the QA1ACM file. Though this is a useful option, you should keep the following limitations in mind:

- BRMS copies control group attributes across to the target system. These attributes revert to the system defaults. However, BRMS does not copy the subsystems and job queues.
- Though you can copy entries in the control group across systems, you cannot copy backup lists. If the entry in the control group is a list, you must manually create the backup list on the target system for the control group to work successfully. Use the WRKLB RM command to create any missing backup lists.
- If your control group has data inappropriate for the new system (for example, an unknown library), BRMS does not issue a warning message at the time of the copy. If the target system does not support a backup item, you need to remove them. In such cases, you need to edit the control group to make the appropriate changes.
- BRMS does not copy the control group text across the system. You must manually add the text on the target system.

Because of these limitations, you should review the control group after the copy to ensure that BRMS copied it correctly. You may need to tailor the values to fit the operational requirements for that particular system.

Checking BRMS Network Synchronization

The *System status* field on the *Change Network Group* display should provide you with an easy means of determining whether the current system is communicating with the other networked systems. A status of *Online* indicates that synchronization is running between the two systems. A status of *Offline* may be an indication of a problem.

Note: *Network Status* only indicates whether the system has or has not been activated into the network.

You can take the following steps to run a daily check of media synchronization:

1. On one system in the BRMS network, create a dummy media class (for example, NETCHK, which stands for Network Checking). Because you will not use this media class for real backups, you can simply use the default values.
2. On each system (SYSTEMxx, where xx = name of the system), type: ADDMEDBRM VOL(SYSxx) MEDCLS(NETCHK)
3. Every morning, on each system in your BRMS network, use the job scheduler to run the CL command:
RMVMEDBRM VOL(SYSxx) MEDCLS(NETCHK)
Delay Job (DLYJOB) DLY(300)
ADDMEDBRM VOL(SYSxx) MEDCLS(NETCHK).
4. After you submit the CL command, your media should have a creation date equal to the current date. This should be true on the system that will run the command. If not, it means that you did not submit the CL command, and should check the job log for error information. The other systems in the BRMS network should also have the current date as the creation date for this media. If not, it means that system did not process the update correctly.

Assuming that the current date is July 6, 2005, the WRKMEDBRM command for each system should display the following information:

```

Work with Media                                SYSTEM01

Position to . . . . . Starting characters

Type options, press Enter.
1=Add      2=Change      4=Remove      5=Display
6=Work with media set  7=Expire       8=Move      10=Reinitialize ...

  Volume      Creation Expiration      Move      Media      Dup
Opt  Serial   Expired   Date      Date      Location  Date      Class     Sts
---  -----
xxxxxx      xx/xx/xx  *NONE     xxxxxxxx  xx/xx/xx  xxxxxxxx
xxxxxx      xx/xx/xx  *NONE     xxxxxxxx  xx/xx/xx  xxxxxxxx
SYS01      *YES     07/06/05  *NONE     *HOME     *NONE     NETCHK
SYS02      *YES     07/06/05  *NONE     *HOME     *NONE     NETCHK
SYS03      *YES     07/06/05  *NONE     *HOME     *NONE     NETCHK
SYS04      *YES     07/06/05  *NONE     *HOME     *NONE     NETCHK
xxxxxx      xx/xx/xx  *NONE     xxxxxxxx  xx/xx/xx  xxxxxxxx
More...

Parameters or command:
====>
F3=Exit  F4=Prompt  F5=Refresh  F11=Volume system  F12=Cancel  F17=Top
F18=Bottom  F23=More options

```

Press F11 to view the owning system. Reviewing the following display, you might conclude that SYSTEM01 did not receive the SYSTEM04 media update.

```

Work with Media                                SYSTEM01

Position to . . . . . Starting characters

Type options, press Enter.
1=Add      2=Change      4=Remove      5=Display
6=Work with media set  7=Expire       8=Move      10=Reinitialize ...

  Volume      Creation Expiration      Move      Media      Dup
Opt  Serial   Expired   Date      Date      Location  Date      Class     Sts
---  -----
SYS01      *YES     07/06/05  *NONE     *HOME     *NONE     NETCHK
SYS02      *YES     07/06/05  *NONE     *HOME     *NONE     NETCHK
SYS03      *YES     07/06/05  *NONE     *HOME     *NONE     NETCHK
SYS04      *YES     07/04/05  *NONE     *HOME     *NONE     NETCHK
More...

Parameters or command:
====>
F3=Exit  F4=Prompt  F5=Refresh  F11=Volume system  F12=Cancel  F17=Top
F18=Bottom  F23=More options

```

In this case, it could be that a communications problem occurred subsequent to July 4th.

Removing a System From a Network

- Take the following steps to remove an iSeries server from a network group:
 - Perform these steps from system SYSTEM02 to remove it from a network also consisting of systems SYSTEM03, SYSTEM04 and SYSTEM05. If the system SYSTEM02 no longer exists, skip to the next step.
 1. Type GO BRMSYSPCY. Press Enter.
 2. Type 4 (Change network group). Press Enter.
 3. Type 4 (Remove) next to each *Remote Local Location Name* in the network group. Press Enter.

```

Change Network Group                                SYSTEM02
Network group . . . . . : *MEDINV                Position to . . . . .
Text . . . . . : Entry created by BRM configuration
Receive media info . . : *NONE                  *NONE, *LIB
Enable for TCP/IP . . . : *YES                  *NO, *YES
Notify period . . . . . : 600                   30-99999 seconds
Type options, press Enter.
  1=Add  4=Remove  8=Set time
  Remote Local  Remote  Receive  System  Network
Opt Location Name Network ID Media Info Status Status
-----
 4  SYSTEM03    ITSCNET  *NONE  Online  Active
 4  SYSTEM04    ITSCNET  *NONE  Online  Active
 4  SYSTEM05    ITSCNET  *NONE  Online  Active

Bottom

F3=Exit  F5=Refresh  F12=Cancel

```

4. On the Confirm Remove of Network Systems display, you are given the opportunity to remove the shared media entries of the systems being removed from the media inventory of the current system. Type *NO in the *Remove media* field to retain the shared media entries. Type *YES in the *Remove media* field to remove the shared media entries.

Note: If a system is displayed as inactive, you should use caution in using the *YES parameter, since it removes all media entries for that system, *even if the system was never an active member of the network.*

```

Confirm Remove of Network Systems                SYSTEM02 ITSCNET
Press Enter to confirm your choices for 4=Remove.
Press F12 to return to change your choices.

Remove media . . . . . : *NO                    *YES, *NO, *RENAME

  Remote Local  Remote  Receive  System  Network
Opt Location Name Network ID Media Info Status Status
-----
 4  SYSTEM03    ITSCNET  *NONE  Online  Active
 4  SYSTEM04    ITSCNET  *NONE  Online  Active
 4  SYSTEM05    ITSCNET  *NONE  Online  Active

Bottom

F12=Cancel

```

- On one of the remaining systems the network group:
 1. Type GO BRMSYSPCY. Press Enter.
 2. Type 4 (Change network group). Press Enter.
 3. Type 4 (Remove) next to system SYSTEM02. Press Enter.
 4. Press Enter on the Confirm Remove of Network Systems display to remove the system from the active network group.

Alternatively you could rename (*RENAME) the media used by SYSTEM02 to the name of the system you are on. In the following example, an operator changes the names of media SYSTEM02 to SYSTEM03, which is the system currently in use.

```

Confirm Remove of Network Systems                SYSTEM03 ITSCNET

Press Enter to confirm your choices for 4=Remove.
Press F12 to return to change your choices.

Remove media . . . . . *RENAME      *YES, *NO, *RENAME

Remote Local   Remote   Receive   System   Network
Opt Location Name Network ID Media Info Status   Status
4   SYSTEM02   ITSCNET  *NONE    Offline  Active

Bottom

F12=Cancel

```

Removing the Network Feature from a Previously Networked System

To remove the Network feature from a previously networked system, take the following steps:

1. Follow the steps in the previous section (Removing a System from a Network Group).
2. After you remove all of the systems and media from the network group, Enter the GO LICPGM command from a command line.
3. At the Work with Licensed Programs display, take option 12 (Delete licensed programs).
4. Type a 4 (Delete) in front of the BRMS Network feature (5722BR1) entry and press Enter.
5. Press Enter again to confirm your deletion and return to the Work with Licensed Programs display.

Seasonal Time Changes of BRMS

BRMS has a significant reliance on the timestamp in each record synchronized between systems in a BRMS network. There are two recommended methods for adjusting the time for Fall (see “Setting Clocks Back”) and one method for adjusting the time for Spring (see “Setting Clocks Ahead” on page 259).

Note: The following methods also apply to seasonal time changes of non-networked BRMS system

Setting Clocks Back

Here are two recommended methods for adjusting the time for Fall or when the system time needs to be set earlier than it’s current setting. One method involves restarting your system while the other does not.

IPL Method

Checklist for setting clock backwards in time: Ensure that BRMS operations have halted and none are scheduled to start. DSPPFM on QA1ANET in QUSRBRM and ensure that there are no records in the file.

1. Ensure that BRMS operations have halted and none are scheduled to start.
2. DSPPFM on QA1ANET in QUSRBRM and ensure that there are no records in the file. If there are records, then updates have not been synchronized yet. Allow the records to synchronize to all systems.
3. Ensure that no BRMS operations are occurring on any system in the network, such as saves, movement or maintenance.
4. Issue the PWRDWN SYS RESTART(*NO) command and put the system into manual mode.
5. Wait almost an hour (allow for the amount of time to IPL also) and start the IPL.

6. At the Date/Time screen, change the system time 1 hour backwards, and continue the IPL.
7. When all systems have been set, resume BRMS operations.
Example: Clocks will be set at 2am and will be going back 1 hour. At 2 am, issue the PWRDWN SYS command. Wait almost one hour. Start the IPL of the system. When the system comes back up, set the clock to 2 am (and whatever minutes have passed). This will prevent the repetition of the 1 am - 2 am hour on your system, and will ensure that all system journals and BRMS have no problems with duplicated time stamps or time stamps that are out of sequence with real time.

If necessary, nightly system backups (STRBKUBRM) can be run even though not all systems have been reset as long as the following are true:

1. The target system volume record is more than 1 hour old.
Example: The last time volume X was updated was by movement this morning. Under these circumstances, an update for volume X from a system with a one hour earlier time will still be accepted on a system with a one hour later system time, and an update from a system with a later time will still be accepted on a system with an earlier system time because there is more than 1 hour difference between the time the save and the move were done. If the difference between the updates would be less than the 1 hour time difference on the systems, problems could result and the wrong update could be ignored.
2. The system owns plenty of scratch media (so it will not have to DDM to 'borrow' media from other systems). During the time period that clocks are being reset, it is best to avoid operations that involve the update of a record on another system.
3. Do not run other BRMS operations, like movement or maintenance or use WRKMEDBRM Option 2 on a volume that is not owned by the system that you are working on.
4. Resume normal BRMS operations only after all systems have been reset, and the last 1 hour of repeated time has passed on every system in the network.

Non-IPL Method

The general recommendation is to use the IPL Method as stated above. This protects all time stamp dependent operations on your system as well as BRMS. However, if this is not possible due to operation schedules you must carefully plan your BRMS activities so that only the system that owns a piece of media will try to update it during the time that system clocks are not yet all reset and the hour is being repeated.

Notes:

1. Do not perform any BRMS activities during the period that you are resetting clocks, and during the one hour of repeated time. If you must start backups during the repeated hour, ensure that the system owns enough scratch media for the backups, and that no other update operation will occur on that media during the repeated time period.
2. If you repeat a period of time by setting the clocks backwards, and during that period, you cause the same volume to be updated, those updates may not end up being synchronized correctly. BRMS relies upon time stamps on the records to order the records in the file and decide if an update should occur or not.
3. Save jobs will synchronize an update to the volume information on all network systems to show that the volume is active and owned by the saving system. If one of the other systems had a record for that volume that appeared to be more recent (because that system did not yet have its clock reset) that system would throw away the update record, and synchronize its view of the volume to the other network systems, causing an otherwise valid update to be ignored. It would be possible for BRMS to then overwrite such a tape, and the integrity of your system recovery plan would be compromised.
4. On the day that times will be changed, you should ensure that while you are doing your nightly saves, no other update activity is occurring for the same volume on another system. The best way to avoid this is to ensure that you have sufficient expired media owned by each system for the backups during this time change period (so that systems will not try to 'borrow' another system's media). Also

make sure maintenance, movement, WRKMEDBRM opt 2, and all other update activity does not occur. That way, updates to media records will only be initiated by save activities from systems which already own the volumes.

Setting Clocks Ahead

Setting clocks forward in the Spring or when the system time needs to be set later than it's current setting does not present any special problems. If the system is not networked with other BRMS system just implement Step 4 below. To change the system time on a networked system follow Steps 1–5.

1. DSPPFM on QA1ANET in QUSRBRM and ensure that there are no records in the file. If there are records, then updates have not synchronized yet. Allow the records to synchronized to all systems before changing the time.
2. Ensure that no BRMS operations are occurring on any system in the network, such as saves, movement or maintenance.
3. Hold the job queue Q1ABRMNET in the Q1ABRMNET subsystem. (Use the WRKJOBQ command). An alternative is to use option 8=Set Time from the *Change Network Group* display. To get to this display:
 - a. Type GO BRMSYSPCY (enter)
 - b. Select Option 4=Change network group (enter)
 - c. Type 8 to set the system date/time on the designated system to that of the current system. This option will cause the remote system to be synchronized to the same time as the current system.

Note: Do not use this function for remote systems in different time zones if you do not want these synchronized to the same time as the current system.

4. Change the clocks forward on all systems using the CHGSYSVAL SYSVAL(QTIME) command.
5. When all system's clocks have been set, release the Q1ABRMNET job queue and resume BRMS operations.

Chapter 15. Online Lotus Server Backups

BRMS supports an online backup of Lotus servers. Online backup implies that Lotus Server databases on the iSeries server can be saved while they are in use and requires no save while active synchronization points. This is true online backup support.

You can direct your online backups to a tape device, media library, save files, or a TSM server.

Lotus Server online backups only backup the Lotus server databases. There are other important Lotus server data objects including libraries and files in the Lotus server Integrated File System (IFS) directories, and other non-Lotus server system data that should be backed up on some regular basis. It is important that you do not replace your complete system backup with only Lotus Server online backups to assure the system is protected should full recovery be required.

How Lotus Server Online Backup Works

A *full online backup* of Lotus servers consists of two files, the *database* files, and the *changes* files which contain the updates to the databases while they were being backed up. These files must be bound together during the backup in order to properly restore the databases in the event of a recovery. An *incremental online backup* is a save of the *transaction logs* for the server.

Lotus Server backups use a BRMS concept called a *package* to bind the backup of the databases to the changes files and associated transaction logs. When a full online backup is run, the Lotus Server uses the PKGID parameter on the SAVBRM command to specify the package association between the databases and the changes files. At the time of backup, the Lotus Server also uses the RCYEXITPGM parameter to specify a Lotus Server exit program which BRMS calls after the package is recovered.

When an incremental online backup is run, BRMS will add the transaction logs to the associated package of the prior full online backup. If the Database Instance Identifier (DBIID) of a database has changed or this database is recognized as a new database, a full online backup of the database will be performed followed by an incremental online backup. The new database can now be recovered using point in time recovery. If a database is not being logged, either because it was explicitly removed from the transaction log or the database isn't at the correct level to support transaction logging, and it has changed, it will be saved when the incremental online backup request is processed.

| Online backups of Lotus servers are stored in the BRMS history information as packages. The number of
| elements in the package is determined by the type and number of online backups performed. In the case
| of full online backups, the package number is 2. For every subsequent incremental online backup, 1 is
| added to the full package number. The maximum package number is 99 which allows for a full online
| backup and 97 incremental online backups for each Lotus server.

| When you request BRMS to recover a Lotus Server database that was saved as a package, BRMS restores
| the entire package consisting of the database files, changes file and transaction logs. After these are
| restored, BRMS calls the Lotus Server exit program which in turn applies the transaction log changes to
| the restored databases.

Initialize BRMS For Lotus Server Backups

BRMS will automatically configure the backup control groups and media policies you need to perform online backup of the Lotus Server databases. The Lotus Notes[®] server databases backed up by these control groups are files that have extensions of *.ns?, *.nt? and *.box.

BRMS provides the following three new special values that can be used as backup items in a backup control group which you can use to backup additional IFS objects:

1. *LNKOMTONL (replaces list QLTSEXCL)

Note: The *LNKOMTONL in conjunction with your online backups can replace the *LINK backup item entry from the control group you use for the full system save.

2. *LNKOMTLTS (replaces list QIFSXCLLTS)
3. *LTSOMTONL (replaces list QLTSEXCLONL)

The files backed up by the above special values are dynamic in nature. When you use these special values, BRMS will figure out the correct files to save prior to running the back up.

BRMS provides the following three lists which you can modify and use to define omits for the above special values:

1. QLNKOMTONL (omit list for *LNKOMTONL)
2. QLNKOMTLTS (omit list for *LNKOMTLTS)
3. QLTSSOMTONL (omit list for *LTSOMTONL)

The above lists are managed by you to define IFS directories and files to be omitted omit from the backup item. For example, you might add directory `/tmp/* *OMIT` to the QLNKOMTONL or QLNKOMTLTS to exclude the files in the /tmp directory from the backup. You do not need to add these lists to the backup control group. The items in the list will be appended to the object list of the associated backup item.

Note: The following restrictions apply to the *Include or omit* value in the lists:

- You cannot specify *INCLUDE in the QLNKOMTONL list.
- You cannot specify *INCLUDE in the QLNKOMTLTS list.
- You can specify *INCLUDE in the QLTSSOMTLTS list as long as it is not already contained within the scope of objects saved by *LNKOMTLTS.

The following table lists the BRMS objects which are automatically created by BRMS. These objects along with the BRMS System Policy and Backup Policy determine whether your backup will be directed to a device, a save file, or a TSM server. These BRMS objects will automatically be updated to include new Lotus Servers when you run the Start Maintenance using BRM (STRMNTBRM) command, or Initialize BRMS (INZBRM) command with *DATA specified for the OPTION parameter.

Name	Object type	Description
QLTSSVR	Backup control group	Backs up all Lotus Servers on the system. The entries in this control group are dynamic; however, BRMS will attempt to preserve modifications you might make to the entries. New Lotus servers will be appended after the existing entries and before the post exit.
QLTSDOMnn	Backup control group	Backs up all databases for Lotus Server nn, where nn is 01-99
QLTSSVR	Media policy	Media policy specifying the media class and expiration to be used for Lotus Server backups

The following backup link lists are provided to help you manage your backup windows. If you wish to include "extra" user defined omits that will not be impacted by the dynamic nature of these lists, see NOTE 4 below.

Also if you are running these lists while the domino servers are active, see NOTE 5 below. If you encounter locks on objects while running the following lists, consider using Save-while-active, ending any subsystems or applications that are holding locks against the objects, or saving in a restricted state by ending all subsystems to include these objects in the backup.

*LNKOMTONL	Backup item for backup control groups	Control group backup item which includes all Integrated File System objects except the online data listed in Table 3.
*LTSOMTONL	Backup item for backup control groups	Control group backup item which includes all Lotus Server directories objects except the online data listed in Table 3.
*LNKOMTLTS	Backup item for backup control groups	Control group backup item which includes all Integrated File System objects except all Lotus Server directories and objects.
QLNKOMTONL	Backup Link List	User defined omits to be added automatically to *LNKOMTONL.
QLTSOMTONL	Backup Link List	User defined omits to be added automatically to *LTSOMTONL.
QLNKOMTLTS	Backup Link List	User defined omits to be added automatically to *LNKOMTLTS.

Notes:

1. The Lotus Server databases are IFS files that have extensions of *.ns?, *.nt? and *.box.
2. Be sure to backup your entire system immediately after you install BRMS and before you start an online Lotus Server backup. (See chapter 3, Backing up your entire system in the BRMS manual). For current BRMS users, these steps do not necessarily apply, but you should be able to apply the information to your own environment as appropriate.
3. The following files are approved by Lotus Domino® for iSeries for exclusion from the back up.

Table 3. Lotus Server Online Data

<pre> *.nt? *.ns? *.box *.dtf *.ft *.lck *.log *.mtc *.tmp *.NOTESHST S*.TXN nlogctrl.lfh pid.nbf brmschgs brms/incrsave/* brms/copiedlog/* IBM_TECHNICAL_SUPPORT/* fault_recovery.hst /tmp/QACX* </pre>
--

4. Users can now add omits to the dynamic lists QLTSEXCL, QLTSXCLONL, and QIFSXCLLTS. With SI07015(V5R1) and/or SI07016(V5R2) applied, users will be allowed to add their own omits to a new list that is combined with the old dynamic list. For example:
The new user list QLNKOMTONL will be added to the QLTSEXCL dynamic list.
The new user list QLTSOMTONL will be added to the QLTSXCLONL dynamic list.
The new user list QLNKOMTLTS will be added to the QIFSXCLLTS dynamic list.
These new lists are not dynamic and their content is controlled by the user.
Do NOT add these new user lists to your control groups as they will automatically be appended to the appropriate dynamic list (QLTSEXCL, QLTSXCLONL, or QIFSXCLLTS) when that list is processed.
5. If you run QLTSEXCL or QLTSXCLONL, while the servers are active, you will want to specify the path to the notes.ini file for each server in order to omit them. If you are running Lotus Enterprise Integrator® (LEI) version 5 and earlier, you will also want to omit /QIBM/USERDATA/LOTUS/LEI/LCCSMP. Starting at Version 6.01 of LEI, this file has moved to /tmp and the naming convention has changed (LEI server name + LCCSMP), ie.

/tmp/LEIMED02LCCSMP. You will need to backup these files when the servers are down. If the transaction logs are in a directory that isn't under the Domino data directory, then you should also add the path to the transaction log directory to this omit list.

If you use WRKDOMSVR or other domino commands during a save of the backup link lists QLTSEXCL, QIFSXCLLTS or QLTSXCLONL - the /tmp directory might be locked and interfere with the operation of the command. One symptom of this interference might be a blank screen on the WRKDOMSVR command. In this case, you will have to wait for the lock on the /tmp directory to be released before the command will work correctly. In order to avoid this situation, you may want to omit the /tmp directory by adding it to one of the user defined additional omit lists, QLNKOMTONL, QLTSONL or QLNKOMTLTS (see NOTE 4 above).

6. In order to issue a save of these dynamic lists, you must have the authority to read and traverse the domino directories.
7. After a FULL save of the IFS directories, for example, after a save using a control group with a *LINK backup item, any incremental save of an online domino server will be changed to a FULL. If you want to ensure that an incremental save is done, replace the *LINK with QLTSEXCL or an equivalent list that will exclude your online domino data in the control group that you use to save your IFS directories.

Performing An Online Lotus Server Backup

Attention: *Backing up your Lotus Servers should not replace your regular complete system backups.*

Lotus Domino for iSeries provides the Save Domino Server using BRMS (SAVDOMBRM) command which BRMS uses in *EXIT backup control group entries to back up your Lotus servers while online.

BRMS initialization has created the required setup to enable you to perform online backups of Lotus Servers using the Lotus Server backup commands. A backup control group named QLTSSVR is available for you to use to back up all the Lotus Server databases on your system.

The following steps must be performed before you can back up your Lotus servers.

Determine the device and media class to use

During the installation process, BRMS chooses a default device based on the fastest and most automated tape drive that is attached to your system. BRMS also creates media classes based upon the density/formats supported by the devices attached to your system.

Refer to "Determining Media Classes" on page 18 to determine the default device and media class configured by BRMS. Make a note of the device and media class names in the system policy.

Add media to the media class scratch pool

Adding media to a BRMS media class allows the use, tracking, and protection of active data on the media by BRMS. You should add media to the media class. Once media is added to a media class of available media, BRMS will drive backup operations and use this media, asking you to load tapes as necessary.

It is important to have sufficient media enrolled in the media class before performing a save operation. To perform the backup discussed in this chapter, we recommend that you enroll at least three pieces of media. In determining the number of media to add, you need to consider the capacity of your media and the size of your Lotus server data.

To add media, refer to either "Enrolling Media into BRMS for use by a Stand-Alone Tape Device" on page 19 or "Enrolling Media into BRMS for use by a Media Library" on page 19. If you are unsure of what kind of device you have, a media library would be an enclosed unit holding multiple media cartridges that allows access to media cartridges using a robotic loader.

Note: You do not need to add media if you are saving to a save file or to a TSM server. However, if you are saving only to save files or TSM, you need to run the Save Media Info using BRM (SAVMEDIBRM) command following the backup to assure the most recent save information is available for recovery.

Start the backup

To start the online backup of all Lotus server using the QLTSSVR backup control group in your current job , enter the following command after loading the media into the devices.

```
STRBKUBRM CTLGRP(QLTSSVR) SBMJOB(*NO)
```

During the backup processing, you may encounter messages that require user intervention such as loading a tape. A message symbol at the bottom of the screen may appear indicating that a message has been sent to the system operator for a reply. To view the system operator messages, press the SYS REQ key, enter a 6 on the line at the bottom of the screen, and then press Enter to go to the Display Messages panel for the system operator. Position the cursor over the message requiring a reply and press the F1 key to see more information on how to handle the message. Perform the corrective action, enter a reply to the message, then press the Enter key. Return to you interactive session using the F12 key.

The processing time of the backup will depend on system processor size, device capabilities, amount of data being saved, and activity associated with your Lotus Server.

After completion of the backup, review the job log to ensure that the backup completed successfully. To display the job log, enter the following command:

```
DSPJOBLOG
```

On the display, press function key F10 and page up to see the details of any messages logged during backup processing.

Note: BRMS stores the history of the objects saved during the back up into database files located in library QUSRBRM. The *Automatically backup media information* attribute in the backup control groups directs BRMS to automatically back up this information when the back up ends. This data is saved because it is necessary for BRMS to successfully recover the system.

Recommendations

BRMS recommends the following relative to performing backups of Lotus servers:

- Perform complete system backups routinely (once per week at the very least).
- Perform full online backups daily.
- Perform a save of the BRMS media information after each back up.

Restrictions

Saves of Lotus servers are restricted as follows:

- A media policy retention type of **VERSIONS** is not supported.
- Saves of Integrated File System (IFS) objects which includes the including Lotus servers files cannot be performed using parallel devices.
- Do not use the SAVDOMBRM command outside of a backup control group. This command should only be used with *EXIT entries within a BRMS backup control group

Lotus Server Backup Performance Tuning

Backing up individual Lotus Server databases does not perform well. Therefore, the Lotus Server databases are backed up in groups to improve the save performance. You can change the number of databases in the groups by changing an entry in the NOTES.INI file. Follow these steps to change the number of databases backed up in a group.

- Type WRKDOMSVR on a command line
- Choose 13=Edit NOTES.INI on the server you wish to modify.
- Position to the following entry and modify as required.

```
SAVDOMBRM_FILES_IN_GROUP=nnn
```

where nnn is the number of databases to be grouped in one BRMS package.

As you increase the number of databases in a group, your Lotus Server is backed up more quickly. However, all databases in the group will be journaled during the backup with the changes backed up separately. Because all the databases in the group are journaled until all databases in the group are backed up, the time during which changes to the databases can occur is increased and the size of the changes backed up will increase. When the databases are recovered, the changes to the database that occurred during the backup will be reapplied. The reapply process takes longer as the number of changes increases.

If your server is being backed up during heavy server usage, you will want to keep this group value relatively small, so that fewer changes occur to the database during backup operation. As a result, recovery of the database can occur in a reasonable amount of time.

If your server is being backed up during off hours when server use is low, you can set the group value higher to speed up the backup operation, while keeping the recovery time reasonable.

The maximum group value is 120.

Preprocessing and Postprocessing *EXITs in Control Groups

If the first entry in a control group is an *EXIT, it is processed before any subsystem or job queue processing prior to starting the saves. This is referred to as the preprocessing exit.

If the last entry in a control group is an *EXIT, it is processed after any subsystem or job queue processing following the end of the saves. This is referred to as the postprocessing exit.

Because SAVDOMBRM commands is an *EXIT entry, the BRMS control groups supplied for Lotus server backups contain an empty preprocessing *EXIT an empty postprocessing *EXIT to ensure that the Lotus server *EXITs occur in the correct order relative to any preprocessing and postprocessing. You can change the preprocessing and postprocessing *EXIT if you need to perform some operation around the Lotus Server backups.

Example of a good SAVDOMBRM entries in the QLTSSVR control group are illustrated below. QLTSSVR is correctly specified for the CTLGRP parameter on the SAVDOMBRM command in the *EXIT entries.

```

Display Backup Control Group Entries                                RCHAS400
Group . . . . . : QLTSSVR
Default activity . . . . : *BKUPCY
Text . . . . . : Online backup of all Lotus servers

Seq  Backup
    Items      Exit command
10  *EXIT
20  *EXIT      QNOTES/SAVDOMBRM SERVER('LTSSERV01') CTLGRP(QLTSSVR)
30  *EXIT      QNOTES/SAVDOMBRM SERVER('LTSSERV02') CTLGRP(QLTSSVR)
40  *EXIT

Press Enter to continue.

Bottom

F3=Exit  F11=Display main  F12=Cancel

```

Copying Lotus Server Control Groups

The backup control groups that are created by BRMS for online backup on Lotus Servers include one or more *EXIT entries which contain the Save Domino Server using BRMS (SAVDOMBRM) command. The control group (CTLGRP) parameter on this command needs to be changed for each entry if one of these control groups is copied to another control group. The value for the CTLGRP parameter must contain the same name as the control group it is contained in. This is required because the Domino application uses the Save Object using BRM (SAVBRM) to perform the backup of the Lotus Servers and must be able to specify the correct backup control group name on the CTLGRP parameter of the SAVBRM command.

Failure to change the CTLGRP parameter to match the backup control group name will result in an exception when the control group is run.

Assume you copied the QLTSSVR backup control group to a new backup control group named MYLTSSVR. The exits at sequence 20 and 30 below are examples of invalid SAVDOMBRM entries because the CTLGRP parameter on the command does not match the name of the MYLTSSVR backup control group. QLTSSVR must be changed to MYLTSSVR in this backup control group for the backup to complete successfully.

```

Group . . . . . : MYLTSSVR
Default activity . . . . : *BKUPCY
Text . . . . . : My online backup of all Lotus servers

```

Seq	Backup Items	Exit command
10	*EXIT	
20	*EXIT	QNOTES/SAVDOMBRM SERVER('LTSSERV01') CTLGRP(MYLTSSVR)
30	*EXIT	QNOTES/SAVDOMBRM SERVER('LTSSERV02') CTLGRP(MYLTSSVR)
40	*EXIT	

Bottom

Press Enter to continue.

F3=Exit F11=Display main F12=Cancel

BRMS Incremental Online Lotus Server Backup

Setting up your Lotus Servers for Incremental Online Backup

When setting up your Domino for iSeries servers for incremental online backup support, you must enable *archived transactional logging* for each Lotus Notes server. You must also identify BRMS as an additional server by issuing either:

```

CFGDOMSVR ADLSVR(*BRMS)
or
CHGDOMSVR ADLSVR(*BRMS)

```

Please refer to your Domino and Administrator's Guides for details on how to enable archived transactional logging.

Notes:

1. Failure to enable archived transactional logging on a database will result in that database being missed from the incremental online backup.
2. Circular transactional logging is not supported for incremental online backup or incremental restore. Therefore, under the Transactional Logging tab, Logging style needs to be changed from "Circular" to "Archived". If this is not done, back ups using BRMS will be cancelled with error LNT0950 return code 12.

Setting up BRMS for Incremental Online Backup

You must take the following actions to set up BRMS for Lotus Server incremental online backup support:

- Verify the Lotus servers and the associated databases are enabled for archived transactional logging.
- Complete a normal full online backup of your Lotus servers.

Note: You must run a backup of type *FULL of all Lotus servers that are to be backed up before using the incremental online backup support.

- Use the WRKCTLGBRM command to view the list of backup control groups.
- Use Option 2=Edit entries on each control group you use to perform online backups of your Lotus Servers that have been enabled for archived transactional logging.
- Set the Weekly Activity for the *EXIT entries which contain SAVDOMBRM to "I" for each day of the week on which you want incremental online backup to be run.

BRMS recommends that you leave one day of the week set to "F" so that a full online backup is performed at least once a week.

Restrictions:

1. Some Lotus server databases are not valid for transaction logging. This can happen if the database is defined as an older database structure or the database has been explicitly removed from the list of databases being logged. If a database is not being logged, then an incremental backup will not be able to save the changes for this database and a point in time recovery will not be valid. To determine if you have any databases which are not transaction logged, do the following:
 - Enter the WRKDOMSVR command.
 - Use Option 8=Work console next to a Domino server name where the status of the server is *STARTED.
 - Enter the command **sh directory** on the command line.
 - Page up to the top of the page and locate the Logged column.
 - Any database where the value in this column is not set to YES cannot be backed up using the incremental online backup support.

Note: When changes do occur to these non-logged databases, and an incremental backup is requested, a full online backup will be performed on the changed, non-logged databases.

2. The value of the *Incremental type* prompt on the attributes of backup control groups used for incremental online backup support is ignored. A value of *CUML or *INCR produces the same results.
3. If a backup control group is set up to run an incremental online backup and BRMS detects that no prior full backup exists, BRMS will perform an full online backup instead of a incremental online backup.
4. You must use the same type of media for the incremental online backup that you use for the full online backup. If the full online backup went to tape media, the incremental online backup cannot go to save files or to a Tivoli Storage Manager (TSM) server. BRMS recommends you use the same media policy for the *Media policy for full backups* and *Media Policy for incremental backups* attributes of the backup control groups used for incremental online backups to assure the same media types and retentions.
5. You are limited to 97 incremental online backups of a Lotus server before you must perform an full online backup. BRMS recommends that you perform an full online backup of your Lotus servers at least once a week.

View the Catalog of Lotus Server Saved Items

To see the BRMS catalog of save history (what has been saved), do the following:

- Type GO BRMBKUACTION on a command line to go to the BRMS Display Backup Activity menu.
 - Choose 3=Display backup history to review backup history.
 - Choose 7=Work with saved link information and press the Enter key twice to see the contents of your saved directories (links).
 - Choose 9=Work with directory information and press the Enter key on a particular directory to see the saved dates and times for that directory.
 - Choose 7=Restore to restore a directory saved at a specific data and time.
- or**
- Choose 9=Work with saved objects and press the Enter key to work with the individual saved objects in the saved directory.

Notes:

1. The Work with Media Information (WRKMEDIA) command can also be used from any command line to get the same view. This command also supports many filtering options you can use to limit the amount of entries on the display.

2. The Work with Link Information (WRKLNKBRM) command can also be used from any command line to get the view of the saved directories.
3. Use the BRMS iSeries Navigator client to view the backup history and search for the exact database file you wish to restore.

Lotus Server Recovery

This section discusses the methods for recovering individual Lotus Server database files using either the command line interface or the new BRMS iSeries Navigator client. For a complete recovery of your system, no special action is required because BRMS automatically includes in the System Recovery Report any Lotus Server backups you performed.

Note: Just performing a backup of your Lotus Servers does not protect you in the event a full system recovery is required. You should use BRMS to backup the remainder of your system on a regular basis. Refer to Chapter 3, “Backing Up Your Entire System,” on page 17, “Printing Your Recovery Reports” on page 24, and Chapter 4, “Recovering Your Entire System,” on page 27.

Note: The NNDILOCK.NSF file is a Lotus Notes file used for locking and is automatically created if it does not exist and is therefore never backed up by the SAVDOMBRM command.

You can perform point-in-time recovery of a Lotus server databases saved using online incremental backup. You can perform recovery of these databases using the **Restore iSeries Data** task provided by the BRMS iSeries Navigator client. For detailed information on the BRMS iSeries Navigator client, see the iSeries Information Center.

You can also use the recovery defaults (F9) on the Work with Media Information display to specify a point-in-time as shown on the following panel. Refer to the help on *Lotus point—in—time* prompt for detailed information about recovery using a point in time.

Restore Command Defaults

Type information, press Enter.

Restore to library	*SAVLIB	Name, *SAVLIB
Auxiliary storage pool	*SAVASP	Name, *SAVASP, 1-32...
Document name generation	*SAME	*SAME, *NEW
System resource management	*ALL	*ALL, *NONE, *HDW, *TRA
Apply journaled changes:		
Restore journal receivers	*YES	*YES, *NO
Apply option	*YES	*NONE, *APPLY, *REMOVE
Ending date	*CURRENT	Date, *CURRENT
Ending time	*CURRENT	Time, *CURRENT
Lotus point-in-time:		
Ending date	*CURRENT	Date, *CURRENT, *FULL
Ending time	*CURRENT	Time, *CURRENT, *FULL
Create parent directories	*NO	*NO, *YES
Parent directories owner	*PARENT	Name, *PARENT

Bottom

F12=Cancel

Recovering a Single Lotus Server Database Using the Command Interface

Use the RSTBRM command to recover a specific Lotus Server database. For example, to restore a Lotus Server database called *names* using device TAP01, you would enter the following command:

```
RSTBRM DEV(TAP01) OBJ('/notes/data/names.nsf')
```

You can also use the WRKLNKBRM (list of directories) or the WRKMEDIBRM command to narrow down selections using the available filtering options.

Note: You do not need to specify the media identifier on RSTBRM because BRMS knows what media contains the most current version of the data and will prompt the system operator to load the required media if it is not currently loaded in TAP01.

After the recovery completes, review the job log to ensure that the recovery was successful. To display the job log, enter the following command:

```
DSPJOBLOG
```

On the display, press F10 and page up to see the details of any messages that were logged during recovery processing.

Note: Multiple objects are associated with online backup of a Lotus Server database. Therefore, multiple messages are typical during recovery.

Recovering a Single Lotus Server Database Using the BRMS iSeries Navigator Client

There are several approaches to locating and restoring a single Lotus Server database file using the BRMS iSeries Navigator Client.

- If you know the path and the database file already exists, but you want to restore an earlier version:
 1. Open the File System folder in iSeries Navigator for the system.
 2. Open the Integrated File System (IFS) folder.
 3. Traverse the IFS tree until you find the path/file you want to restore.
 4. Right click on the file.
 5. Click Restore.

This will start the BRMS Restore Wizard primed with your selection.

- If you know the database file, but do not know the path or are unsure of the path:
 1. Click on the Backup Recovery and Media Services folder for the system.
 2. Click on the Restore iSeries Data task.
 3. Select *Files and directories* for the type of backup item on Backup History — Include panel
 4. Enter the path for *Directory*. If you do not know the path select *ALL to see all files saved in the directory.
 5. Enter the file name for *File*. If you do not know the file name specify *ALL to see all files saved in the directory.
 6. Click OK.
 7. Right click on the file you want to restore.
 8. Click Restore.

This will start the BRMS Restore Wizard primed with your selection.

Restrictions

- Restoring a saved Lotus server database across a BRMS network is supported only if the target system is receiving media information from other systems in the network. To determine if this system is receiving media information:
 1. Type GO BRMSYSPCY on a command line on the system.
 2. Option 4 - Change network group.
 3. Verify the *Receive media info attribute* is set to *LIB.

- Lotus Servers use subsystem descriptions. These subsystem descriptions must exist on the system prior to recovering the Lotus Servers.

Restoring Online and Online Incremental Backups

There is no special setup to recover online or online incremental Lotus server backups. If the backup was an online incremental save, BRMS automatically recovers the full online backup and any subsequent online incremental backups, plus any unsaved transactions. This allows you to recover a database past the point-in-time of the last incremental save.

For example: If you delete a database file *my.nsf* and then request it to be restored, BRMS will restore the full online backup, any saved transactions, and since the current transactions are on the system, these will also be used to bring the database back to the most current level.

If you need to recover a version of a database file earlier than the latest version, specify the required date and time on the *Lotus point in time: Ending Date/Ending Time* prompt on the *Recovery Policy* or *Restore Command Defaults* panels.

When viewing full online backups of Lotus servers using the WRKMEDIBRM command, BRMS identifies these saves using the *LTSONL special value for the *Save Type* field. In addition, the Lotus server subsystem name is listed in the *Saved Item* field. The number of saved items for a full online backup of a Lotus server will depend on the number of databases that were grouped with each save as determined by the current setting of SAVDOMBRM_FILES_IN_GROUP entry in the NOTES.INI file as discussed in “Lotus Server Backup Performance Tuning” on page 266. To recover an entire Lotus server, you would specify option 7 for each saved item entry having the same Lotus server subsystem name with similar save dates and times.

```

Work with Media Information                                RCHAS400

Position to Date . . . . .

Type options, press Enter.
 2=Change  4=Remove  5=Display  6=Work with media  7=Restore
 9=Work with saved objects  ...

  Saved      Save   Save   Save   Parallel  Volume   File      Expire
Opt Item     Date   Time  Type  Devices  Serial   Sequence  Date
-----
LTSSRV01    1/27/05 20:59:22 *LTSONL          000EA6      27  3/02/05
LTSSRV01    1/27/05 21:01:23 *LTSONL          000EA6      29  3/02/05
LTSSRV01    1/27/05 21:03:39 *LTSONL          000EA6      31  3/02/05
LTSSRV01    1/27/05 21:05:24 *LTSONL          000EA6      33  3/02/05
LTSSRV01    1/27/05 21:15:19 *LTSONL          000EA6      35  3/02/05
 7 LTSSRV02    1/27/05 21:31:36 *LTSONL          000EA6      37  3/02/05
 7 LTSSRV02    1/27/05 21:35:42 *LTSONL          000EA6      39  3/02/05
LTSSRV03    1/27/05 21:40:46 *LTSONL          000EA6      41  3/02/05
LTSSRV03    1/27/05 21:45:55 *LTSONL          000EA6      43  3/02/05
LTSSRV03    1/27/05 22:05:24 *LTSONL          000EA6      45  3/02/05
More...

F3=Exit  F5=Refresh  F11=Object detail  F12=Cancel
F23=More options

```

The *LTSINC special value for the *Save Type* field identifies incremental online saves of Lotus servers. This saved item includes the most recent full online backup and all subsequent online incremental backups for the server. Since this saved item includes the full online backup, you do not need to recover the full backup when selecting these saved items for recovery, BRMS automatically recovers the full online backup for you, as well as all online incremental backups.

```

Work with Media Information                                RCHAS400

Position to Date . . . . .

Type options, press Enter.
 2=Change  4=Remove  5=Display  6=Work with media  7=Restore
 9=Work with saved objects  ...

  Saved      Save      Save      Save      Parallel  Volume      File      Expire
Opt Item     Date      Time      Type      Devices    Serial      Sequence  Date
LTSSRV04    1/28/05   6:31:36  *LTSINC   000C11     24          3/03/05
LTSSRV04    1/28/05   6:31:38  *LTSINC   000C11     26          3/03/05
LTSSRV04    1/28/05   6:31:39  *LTSINC   000C11     28          3/03/05
LTSSRV05    1/28/05   6:31:40  *LTSINC   000C11     31          3/03/05
 7 LTSSRV06    1/28/05   6:31:41  *LTSINC   000C11     33          3/03/05
 7 LTSSRV06    1/28/05   6:31:46  *LTSINC   000C11     35          3/03/05
LTSSRV07    1/28/05   6:31:52  *LTSINC   000C11     37          3/03/05
LTSSRV08    1/28/05   6:31:54  *LTSINC   000C11     39          3/03/05
LTSSRV08    1/28/05   6:31:55  *LTSINC   000C11     41          3/03/05
LTSSRV09    1/28/05   6:31:59  *LTSINC   000C11     45          3/03/05
                                                More...

F3=Exit  F5=Refresh  F11=Object detail  F12=Cancel
F23=More options

```

Incremental Recovery to a Different Lotus Server or Different Directory

The Save Domino Server using BRMS (SAVDOMBRM) command uses the Lotus C Backup and Recovery Application Programming Interface (API) to provide backup and restore services for Domino databases. The Lotus C APIs operate on a database level. To recover a document in a database, the entire database must be restored to a point in time when the document was available. If you need to recover a document and preserve new documents created after this point in time, then you must either restore the database to a different server, or restore the database to a different directory under the data directory of the current Domino server. The desired document or documents can then be copied to the original database. This preserves the original database and allows recovery of the requested documents. The ability to restore to a point in time is available if your currently active server has been previously set up to be incrementally saved, and at least one full save has occurred.

Choosing a Database Recovery Method

Below are two different sets of instructions documenting how to restore a database so documents can be recovered from that restored database. If you choose to restore the database to a different server, then follow the set of instructions in “Recovering a Database by Restoring to a Different Domino server.” If you choose to restore the database to a different directory under the current Domino server, then follow the set of instructions “Recovering a Database by Restoring to a Different Directory under the Data Directory of an Active Server” on page 276. Both sets of instructions are designed to guide you in the recovery process of the database. Whichever set of instructions you follow you should read those instructions in their entirety prior to attempting the restore.

Restoring to a different server, while a little more time consuming to set up, may be marginally safer than restoring the database to the same server, but a different directory under the data directory. There is less of a chance of an inadvertent mistake causing you problems on the active server when restoring to a completely different Domino server. Restoring to the same server, but a different directory under that Domino server, is much quicker to set up, and if no mistakes are made, can be as safe as the option for restoring to a different server. If you are still unsure, read both sets of instructions and then choose which one you want to try.

Recovering a Database by Restoring to a Different Domino server

To clarify which Domino server is being referenced in the following instructions these terms will be used:

Recovery server

This is a newly configured, non-started server to which the database is recovered.

Active server

This is the server that has the database that needs to be recovered.

Note: Steps 1-3 used to create the recovery server need only be done once.

1. Configure a non-started recovery Domino server to be used in this recovery process using the Configure Domino Server (CFGDOMSVR) command.

Note: Make sure AUTOSTART(*NO) and STRDOMSVR(*NO) are specified on the CFGDOMSVR command.

If you have previously created a recovery server, you can use that server without having to configure another recovery server. Just follow the instructions for cleaning up data from previous recovery requests.

2. Copy the NOTES.INI database file in the recovery server to the same data directory and give it a new name.

If you have previously created and used this recovery server, and copied the original NOTES.INI, you will not have to make a new copy of the NOTES.INI. Just follow the instructions in the following steps for editing the NOTES.INI file.

3. Make QNOTES the owner of the copied NOTES.INI using the Change Owner (CHGOWN) command.
4. Edit the current NOTES.INI of the recovery server:
 - a. Run the Work with Domino Servers (WRKDOMSVR) command to get to the Work with Domino Servers display.
 - b. Select option 13 for the recovery server.
 - c. Change the NOTES.INI for the recovery server as follows:

```
[Notes]
Directory=data-directory
KeyFilename=data-base-name
Timezone=time-zone
TRANSLLOG_Status=1
TRANSLLOG_Style=1
TRANSLLOG_Path=data-directory/log-directory
TRANSLLOG_MEDIAONLY=1
```

where:

data-directory

This is the path of the data directory for the recovery server that was specified on the CFGDOMSVR command.

data-base-name

This is a database name as it existed on the active server.

time-zone

This line should match the line in the active server that contains the database you wish to restore on this recovery server. It is optional, but if you are having trouble recovering to the correct point in time, then adding this line may help correct the problem.

log-directory

A subdirectory under the recovery server data directory that will receive a copy of the transaction log from the active server.

Note: If you have previously used the recovery server, or this is the first time using this server, there will be extra lines in the NOTES.INI that need to be deleted or changed so that you only have the lines identified above in the NOTES.INI.

5. Use the Create Directory (MKDIR) command to create the *data-directory* path.
6. Use the Change Owner (CHGOWN) command to change the owner of the subdirectories in *data-directory* to QNOTES.

7. Use the Work with Object Links (WRKLNK) command to verify database file *data-base-name* does not exist in the *data-directory* of the recovery server. Use option 4=Remove to delete the file if it exists.
8. Use option 3=Copy from the Work with Object Links display to copy the database file identified by *data-base-name* from the active server data directory to the recovery server data directory.
9. Use the CHGOWN command to make QNOTES the owner of the *data-base-name* database file on the recovery server.
10. Verify that there are no files found under the directory specified by *log-directory*. Use option 4=Remove to delete any files that exist.

The first time you use the recovery server there won't be any objects in that subdirectory to be deleted. If you have used this recovery server previously there could be files in that subdirectory and they need to be deleted. Failure to delete these files may cause the recovery process to fail.

11. An Incremental save must now be done on the active server.

The active server had to previously been setup to support incremental saves. To save the active server incrementally, on a V5R1 or later system, you can issue the command STRBKUBRM and specify ACTIVITY(*INCR). If you are on a V4R5 system, you will have to change the control group appropriately to get an incremental save. This assumes you have a BRMS control group to save this particular active server. This also assumes that a full save had been done on that active server, with that control group, prior to the attempt to do this incremental save. Failure to have a prior full save will cause the recovery attempt to fail. Depending upon what release of BRMS you are using, you may also be able to do this incremental save using the BRMS iSeries Navigator client interface.

12. The current active transaction log database, from the active server that was just saved, must be copied to the transaction log subdirectory of the recovery server.

When the incremental save occurred in the prior step, the current active transaction log was copied to the following location: */data-directory/BRMS/COPIEDLOG/Sxxxxxxx.TXN*, where *xxxxxxx* is a 7 digit number. Do the following to the copy of this most current transaction log:

- Run the command WRKLNK *'/data-directory/BRMS/COPIEDLOG/*'*
- Specify option 3=Copy next to the file named *Sxxxxxxx.TXN* (there should be only one, if more than one select the largest numbered name).
- Press F4 to prompt .
- For the To Directory (TODIR) parameter specify *'/log-directory'*.
- For the Data Format (DTAFMT) parameter specify **BINARY*.
- For the Owner (OWNER) parameter specify **KEEP* so QNOTES remains the owner of the copied file.
- Press Enter to copy the file.
- Verify that the file copied successfully to the recovery servers *log-directory* path.
- Verify that QNOTES is the owner of the copied file. If QNOTES is not the owner, issue a CHGOWN command to change the owner to QNOTES.

Note: It is important to note that the transaction log must be the same name in the recovery server as the name in the active server where it was copied from.

13. If the database to be recovered needs to be restored to a specific date and time, to be able to recover a document, depending upon what release of BRMS you are using, you may need to create a data area and change the data area to contain the date and time of the recovery. If you are recovering the database to the most current time, no data area or point in time needs to be specified.
14. Use WRKMEDIBRM to select the database to be restored and specify that the database is to be placed in the data directory of the recovery server.

The name of the database to be restored to the recovery server must be the same name and case as is found on the active server. Depending upon what release of BRMS you are using, you may be able to use the BRMS iSeries Navigator client interface to do this point in time restore request.

15. Once the database has been recovered, copy (or FTP in binary mode), that newly recovered database to a Domino server that can be accessed from a client.

Because we never want to start the recovery server, it is desirable to copy this recovered database to a Domino server that is active and can be accessed by a client. Remember to use the CHGOWN command to make QNOTES the owner of the newly copied version of the database file before accessing the database. Be careful where you move the database to. You wouldn't want to move it to a server that could replicate this database file and either cause problems for the newly recovered database file or the existing database file.

16. If you are trying to recover a document from the database, then you can use cut and paste from this database to the database on the active server.
17. Having successfully recovered the database, do not forget to delete the database from the recovery server. At some point you will also want to delete the copied database from the active server that you copied the database file to.

It is important to follow the above instructions in the order they are presented. Failure to follow the steps as presented can cause failures when trying to recover a Domino database.

Having read the above steps, here are some items of interest summarizing the above or further explaining some of the details:

- You must have archival transaction logging enabled for the active server and for the databases you will wish to recover
- You must be using BRMS for iSeries to backup your active servers.
- A full online save, using the BRMS control group, has been done previously for this server so an incremental save can occur and be used in the recovery process.
- You must have enough authority to successfully run the CFGDOMSVR command.
- You must have enough authority to copy Domino database files.
- You must have enough authority to run the necessary BRMS commands to recover a Domino database.
- QNOTES must be the owner of objects that the Domino server references and you have enough authority to change the owner of a file to QNOTES if need be.
- You should copy the recovered database to a server that will not try to replicate with this recovered database.
- If a database you are recovering is being restored to the active server and you are replicating that database, you need to consider if temporarily turning off replication for this database is necessary or not. You may not need to turn off replication, but this is intended to make you consider what is happening to this database prior to actually restoring the database.
- You must have enough authority to cut and paste the identified documents from the recovered database to the active database.
- Do not try and use CHGDMSVR on the modified NOTES.INI of the recovery server. This doesn't work and could cause problems. Since the recovery server is not recommended to be started, there are no valid Domino console entries to be displayed. By never starting the recovery server you reduce the chances of problems occurring on the recovery of a database
- Until there are some additional changes made available from BRMS, the saved transaction logs that are restored, and used in the recovery process, are initially restored to the active server's directory that they were saved from and then copied to the recovery server. This means that either you have to restore to a recovery server that is located on the same system as the save occurred OR if restoring to a different system, you may have to create the directories and subdirectories of the active server as it existed when it was saved. When the BRMS changes are made available, then the saved transaction logs will be restored to the recovery server specified on the restore.

Recovering a Database by Restoring to a Different Directory under the Data Directory of an Active Server

If you have a problem restoring a database using the following steps, you may wish to try restoring the database to a different server as outlined above. As in the scenario above, you must have archival transactional logging enabled and have previously saved the database you wish to restore. You are

restoring this database to a point in time to be able to recover a document or documents (that point in time may be very recent, but you need to specify a point in time for this restore to work).

1. Create a subdirectory under the data directory of the active server where the current database file is located.
2. Make sure QNOTES is the owner of that subdirectory. You can do a: `CHGOWN '/data directory of the current server/subdirectory' QNOTES`
3. Do an incremental save of the current active server.
4. Use WRKMEDIBRM to select the database to be restored and specify that the database is to be placed in the sub directory of the active server.

The name of the database to be restored to the subdirectory of the active server must be the same name and case as is found on the active server. Depending upon what release of BRMS you are using, you may be able to use the BRMS iSeries Navigator client interface to do this point in time restore request. Otherwise follow the instructions for specifying a date and time for the point in time restore.

During the actual recovery process of the selected databases, no new saves of this particular server should occur. It could affect the recovery process adversely.

5. Verify that the restore worked. Open the new database to recover the documents. This new database will have a new DBIID associated with it. If you wish to be able to recover this version of the database, you will need to do a full save. If this is only a temporary file, and no longer needed after recovering the documents, then there is no need to do a full save.

Failure to do the steps above, and in the order presented, could adversely affect your current active server environment.

Chapter 16. Backup and Recovery of Auxiliary Storage Pool Devices

This chapter describes techniques and strategies for backup and recovery of auxiliary storage pool devices using BRMS. When you add an auxiliary storage pool device to your system configuration, you will need to plan for the backup and recovery of the user data on these devices because these devices operate differently than the system (1) or basic user (2–32) auxiliary storage pools. These differences will mean that you will have to carefully plan your backup strategy to assure you have a complete system backup.

Auxiliary disk pool devices are specified in i5/OS operations by the 10 character device description name rather than by specifying an identifying number. BRMS also uses the device name when targeting saves or restores to auxiliary storage pool devices. Refer to the system documentation if you are not familiar with auxiliary storage pool device operations or terminology.

Note: When saving directory and files, you should unmount any mounted user-defined file systems (UDFSs) prior to the save to assure the objects in the mounted over directories are saved. UDFSs are automatically unmounted on auxiliary storage pool devices when the system is in restricted state. UDFSs on the system or basic user auxiliary storage pools need to be explicitly unmounted. Any unmounted UDFSs need to be remounted after the save.

To assure a successful recovery of a system which includes auxiliary storage pool devices, you should run BRMS maintenance after each backup. The auxiliary storage pool devices must be available when you run maintenance; otherwise, BRMS will not be able to locate the libraries and will consider the libraries on unavailable auxiliary storage pool devices as having been deleted from the system. By default, deleted libraries are not included in the *Recovering Your Entire System Report*. You can specify OMITLIB(*NONE) on the STRRCYBRM command to include deleted libraries in the report, but this will also include libraries that were saved and then subsequently deleted which may not be your intention.

Backup of Auxiliary Storage Pool Devices

The Edit Backup Control Group Entries panel as shown below provides an Auxiliary Storage Pool Device field for targeting saves of backup items to auxiliary storage pool devices. This field will not appear for backup items which cannot reside on auxiliary storage pool devices. The Auxiliary Storage Pool Device prompt will automatically added a default value if you do not specify a value when you add a new backup item. You can change the default value at any time after the backup item is added to the list of entries. The *SYSBAS value on the *ALLUSR backup item saves all user libraries on the system (1) and any basic user (2–32) auxiliary storage pools. The *ALLAVL value for the *LINK backup items saves the links on the system (1) and any basic user (2–32) auxiliary storage pools as well as the links on all available auxiliary storage pool devices .

```

Edit Backup Control Group Entries                                RCHAS400

Group . . . . . : SYSTEM
Default activity . . . . . FIIIIII
Text . . . . . Backs up the entire system

Type information, press Enter.

Seq   Backup   List   Auxiliary   Weekly   Retain   Save   SWA
      Items    Type  Storage    Activity Object   While  Message
      _____  _____  _____  _____  _____  _____  _____  _____
10   *EXIT_____  _____  _____  *_____*  _____  _____  _____
20   *SAVSYS_____  _____  _____  FIIIIII  _____  _____  _____
30   *IBM_____  _____  _____  FIIIIII  *NO_   *NO_____
40   *ALLUSR_____  _____  *SYSBAS  FIIIIII  *ERR_   *NO_____
50   *ALLDLO_____  _____  _____  FIIIIII  *NO_   *NO_____
60   *LINK_____  _____  *ALLAVL  FIIIIII  *YES_   *NO_____
70   *EXIT_____  _____  _____  *_____*  _____  _____  _____

F3=Exit   F5=Refresh   F10=Change item   F11=Display exits
F12=Cancel  F14=Display client omit status   F24=More keys

Bottom

```

Backing Up User Libraries on Auxiliary Storage Pools Devices

Assume the system is configured with an auxiliary storage pool group consisting of a device named PAYROLL serving as the primary auxiliary storage pool device, and ACCOUNTS serving as the secondary auxiliary storage pool device. The following screen shows that in order to perform a save of all user libraries, three separate *ALLUSR backup items are required. One *ALLUSR with *SYSBAS is specified to save the libraries on the system and basic user auxiliary storage pools, and one *ALLUSR for each of the PAYROLL and ACCOUNTS auxiliary storage pool devices.

You might consider using this approach if the auxiliary storage pools devices have been configured as private (non-switchable) disk pools. Notice that the *ALLUSR backup items directed to the PAYROLL and ACCOUNTS auxiliary storage pool devices is after the *LINK backup item. This was done to optimize the recovery because objects saved from auxiliary storage pool devices are always recovered after the objects on the system and basic user auxiliary storage pools are recovered.

```

Edit Backup Control Group Entries                                RCHAS400

Group . . . . . : SYSTEM
Default activity . . . . . FIIIIII
Text . . . . . Backs up the entire system

Type information, press Enter.

Seq   Backup   List   Auxiliary   Weekly   Retain   Save   SWA
      Items    Type  Storage    Activity Object   While  Message
      _____  _____  _____  _____  _____  _____  _____  _____
10   *EXIT_____  _____  _____  *_____*  _____  _____  _____
20   *SAVSYS_____  _____  _____  FIIIIII  _____  _____  _____
30   *IBM_____  _____  _____  FIIIIII  *NO_   *NO_____
40   *ALLUSR_____  _____  *SYSBAS  FIIIIII  *YES_   *NO_____
50   *ALLDLO_____  _____  _____  FIIIIII  *YES_   *NO_____
60   *LINK_____  _____  *ALLAVL  FIIIIII  *YES_   *NO_____
70   *ALLUSR_____  _____  PAYROLL  FIIIIII  *YES_   *NO_____
80   *ALLUSR_____  _____  ACCOUNTS  FIIIIII  *YES_   *NO_____
90   *EXIT_____  _____  _____  *_____*  _____  _____  _____

F3=Exit   F5=Refresh   F10=Change item   F11=Display exits
F12=Cancel  F14=Display client omit status   F24=More keys

Bottom

```

Backing Up the System and Basic User Auxiliary Storage Pools

Suppose the auxiliary storage pool group is configured for use in a clustered environment where the group is automatically switched to an alternate system by the cluster management software when it detects the primary system is no longer operational. It may be useful in this environment to set up a backup strategy consisting of two backup control groups, one to backup the base system, and one to backup the switchable auxiliary storage pool group. The following screen shows the backup control group entries that would be used on primary and alternate systems to save only the objects on the system and basic user auxiliary storage pools. The *SYSBAS special value used for the Auxiliary Storage Pool Device parameter of the backup items restricts the scope of the saves to the system and basic user auxiliary storage pools. The exception to the is the *SAVSYS backup item which saves the private authorities for all objects on all available auxiliary storage pool devices.

```

Edit Backup Control Group Entries                                RCHAS400

Group . . . . . : SYSTEM
Default activity . . . . . FIIIIII
Text . . . . . Backs up entire system but not switched ASPs

Type information, press Enter.

Seq  Backup  List  Auxiliary  Weekly  Retain  Save  SWA
     Items  Type  Storage  Activity  Object  While  Message
     _____  _____  _____  _____  _____  _____  _____
10  *EXIT  _____  _____  *****
20  *SAVSYS  _____  _____  FIIIIII
30  *IBM  _____  _____  FIIIIII  *NO  *NO
40  *ALLUSR  _____  *SYSBAS  FIIIIII  *YES  *NO
50  *ALLDLO  _____  _____  FIIIIII  *NO  *NO
60  *LINK  _____  *SYSBAS  FIIIIII  *YES  *NO
70  *EXIT  _____  _____  *****

                                           Bottom

F3=Exit   F5=Refresh   F10=Change item   F11=Display exits
F12=Cancel  F14=Display client omit status   F24=More keys

```

Backing Up Multiple Switched Auxiliary Storage Pool Devices

The example backup control group in the previous section illustrated how the basic system can be backed up. If that system also had switchable auxiliary storage pool devices, you might consider backing these up separately using a different backup control group. The following backup control group could be scheduled to run on the primary system after the SYSTEM backup control group is run. It would not be scheduled to run on the alternate system unless the switch over of these auxiliary storage pool devices had occurred. As you can see from the entries, only the user libraries and links on the auxiliary storage pool devices are saved by this backup control group.

Note: When using a switched auxiliary storage pool device, you need to consider any private authorities that may be defined for objects of these types of devices. All user profiles and all private authorities for objects on auxiliary storage pool devices will be saved with the *SAVSYS or *SAVSECDTA backup items. You need to consider how to restore these private authorities if this authority has changed while the device was switched to an alternate system. This might require that as part of the recovery, you restore the associated user profiles from the alternate system to the primary system before restoring any objects to the switched auxiliary storage pool device.

When running multiple backup control groups, you need to consider the order these control groups run and which control group manage the restart of subsystems to return from restricted state.

Another not so obvious implication of switched auxiliary storage pool devices is when incremental has been specified for the Weekly Activity. When the auxiliary storage pool device switches to the alternate system, the alternate system will have no history of the switched objects. Therefore the first save of the objects on the switched auxiliary storage pool devices will be a full save rather than an incremental.

```

Edit Backup Control Group Entries                                RCHAS400

Group . . . . . : ASPS
Default activity . . . . . FIIIIII
Text . . . . . Backs up the switched ASPs

Type information, press Enter.

Seq   Backup   List   Auxiliary   Weekly   Retain   Save   SWA
      Items   Type  Storage    Activity Object   While  Message
      _____  _____  _____  _____  _____  _____  _____  _____
10   *EXIT_____  _____  _____  _____  _____  _____  _____
20   *ALLUSR_____  _____  PAYROLL_  FIIIIII  *YES   *NO_____
30   *ALLUSR_____  _____  ACCOUNTS_ FIIIIII  *YES   *NO_____
40   *LINK_____  _____  PAYROLL_  FIIIIII  *YES   *NO_____
50   *LINK_____  _____  ACCOUNTS_ FIIIIII  *YES   *NO_____
60   *EXIT_____  _____  _____  _____  _____  _____  _____

Bottom

F3=Exit   F5=Refresh   F10=Change item   F11=Display exits
F12=Cancel  F14=Display client omit status   F24=More keys

```

Using *SETASPGRP to Back Up Auxiliary Storage Pool Devices

Specifying the individual auxiliary storage pool devices in the above example can be a bit cumbersome especially if you have a large number of secondary auxiliary storage pool devices in the group. If the objects on these auxiliary storage pool devices can be saved using save while active, you can use the *SETASPGRP backup item to attach the device to the job. To do so, add a *SETASPGRP backup item and specify the primary auxiliary storage pool device name in the *Auxiliary Storage Pool Device* prompt for this backup item. Then use the *CURASPGRP special value for the *Auxiliary Storage Pool Device* prompt on all subsequent backup items to be backed up from that primary auxiliary storage pool device and any of its associated secondary auxiliary storage pool devices as shown in the following panel.

```

Edit Backup Control Group Entries                                RCHAS400

Group . . . . . : ASPS
Default activity . . . . . FIIIIII
Text . . . . . Backs up the switched ASPs using save-while-active

Type information, press Enter.

Seq   Backup   List   Auxiliary   Weekly   Retain   Save   SWA
      Items   Type  Storage    Activity Object   While  Message
      _____  _____  _____  _____  _____  _____  _____  _____
10   *EXIT_____  _____  _____  _____  _____  _____  _____
20   *SETASPGRP_____  _____  PAYROLL_  FIIIIII  _____  _____  _____
30   *ALLUSR_____  _____  *CURASPGRP FIIIIII  *YES   *YES_____ *LIB_____
40   *LINK_____  _____  *CURASPGRP FIIIIII  *YES   *YES_____ *LIB_____
50   *SETASPGRP_____  _____  *SYSBAS_  FIIIIII  _____  _____  _____
60   *EXIT_____  _____  _____  _____  _____  _____  _____

Bottom

F3=Exit   F5=Refresh   F10=Change item   F11=Display exits
F12=Cancel  F14=Display client omit status   F24=More keys

```

Notes:

1. When more than one *SETASPGRP is used as backup items, any previously attached primary auxiliary storage pool is detached from the job when the subsequent *SETASPGRP backup item is processed.
2. To explicitly remove an attached primary auxiliary storage pool from the job, use *SETASPGRP with *SYSBAS for the *Auxiliary Storage Pool Device* prompt.

- The V5R2 restriction of the operating system which prevented attaching a primary auxiliary storage pool to the current job while in restricted state is removed at V5R3. The *SETASPGRP special value for backup items can now be used while in restricted state.

Using the *SETASPGRP and *CURASPGRP special value combination is the preferred method of backing up objects on auxiliary storage pool devices. BRMS has many operations which need access to the objects during the save processing. Using these options assures the objects are available to BRMS. This may not be the case when saving the objects using named auxiliary storage pool devices.

You cannot use *SETASPGRP if you are saving to TSM servers. You must explicitly name the auxiliary storage pool device on the backup item. The restriction is due to the way the operating system has implemented these types of saves. The save command is not processed in the same job as the back up. The command is run in a server job. Hence, any SETASPGRP command run in the back up job does not affect the save processed in the server job.

Backing Up Spooled Files on Auxiliary Storage Pool Devices

If the libraries on the auxiliary storage pool device contain output queues and you want to save the spooled files associated with these output queues, you need to use the *SETASPGRP special item to assure the output queue libraries are attached to the backup job before the spooled file list is processed. The following panel illustrates the use of a spooled file list named PAYROLL that identifies the specific output queues, libraries and spooled files to be backed up. The PAYROLL primary auxiliary storage pool containing these output queues is set to the backup job just prior to the backup items being processed, and removed from the job after the save of the backup items is complete.

```

Edit Backup Control Group Entries                                RCHAS400
Group . . . . . : ASPS
Default activity . . . . . FIIIIII
Text . . . . . Backs up the switched ASPs using save-while-active

Type information, press Enter.

Seq  Backup  List  Auxiliary  Weekly  Retain  Save  SWA
     Items  Type  Storage   Activity Object  While  Message
     _____  _____  _____  _____  _____  _____  _____  _____
 10  *EXIT_____  _____  _____  *_____  _____  _____  _____
 20  *SETASPGRP_____  PAYROLL_____  FIIIIII
 30  *ALLUSR_____  *CURASPGRP  FIIIIII  *YES  *YES_____  *LIB_____
 40  *LINK_____  *CURASPGRP  FIIIIII  *YES  *YES_____  *LIB_____
 50  PAYROLL_____  *SPL_____  FFFFFFFF  *YES
 60  *SETASPGRP_____  *SYSBAS_____  FIIIIII
 70  *EXIT_____  _____  *_____  _____

Bottom

F3=Exit  F5=Refresh  F10=Change item  F11=Display exits
F12=Cancel  F14=Display client omit status  F24=More keys

```

Recovery of Auxiliary Storage Pool Devices

When the system recovery includes objects saved from auxiliary storage pools devices, the following additional steps will be added to the System Recovery Report to aid you in recovering your system. These steps will appear after Step: Perform IPL because iSeries Navigator is used to re-configure the auxiliary storage pool devices. These steps do not appear if you are recovering by ASP, the assumption is that the ASP you are recovering is already configured. The following step provides the guidance to configure the auxiliary storage pool devices during system recovery.

The following step makes sure you have the appropriate service table entry for configuring the auxiliary storage pool devices using iSeries Navigator.

__ STEP 022 : Verify Service Table Entry

Start date/time _____ Stop date/time _____ Duration _____

The recovery includes objects saved from auxiliary storage pool devices. A service table entry is required to configure auxiliary storage pool devices.

Verify entry as-sts exists in the list of service table entries.

To do so, type the following command then press "Enter".

WRKSRVTBLE

If entry as-sts does not exist, add the entry by typing 1 for Opt, as-sts for Service. Press "Enter", then press F10.

Enter the following values for the parameters of the Add Service Table Entry (ADDSRVTBLE) command.

Parameter:	Value
Service:	'as-sts'
Port:	3000
Protocol:	'tcp'
Text:	'Service Tools Server'
Alias:	'as-sts'

Press "Enter" to create the service table entry.

The following step will appear in the report to provide additional guidance for starting up the New Disk Pool Wizard in iSeries Navigator which you will use to configure the auxiliary storage pool devices.

__ STEP 024 : Configure Auxiliary Storage Pool Devices

Start date/time _____ Stop date/time _____ Duration _____

The recovery includes objects saved from auxiliary storage pool devices. The auxiliary storage pool devices must be re-configured before recovery can continue.

Use the "Display ASP Information" report (QPIAASP) to review the names of the auxiliary storage pool devices of the saved system.

--- Attention -----
If the auxiliary storage pool devices are intended to be used as switched auxiliary storage pools in a clustered environment, review the documentation provided with your cluster management product to identify any pre-configuration steps that may be required prior to configuring these auxiliary storage pool devices.

Re-configure the auxiliary storage pool devices using iSeries Navigator as follows:

- __ Open this system's folder in iSeries Navigator.
- __ Open the Configuration and Service folder.
- __ Open the Hardware folder.
- __ Open the Disk Units folder.
- __ Complete the Service Device signon.
- __ Right-click the Disk Pools folder.
- __ Click on New Disk Pools...
- __ Follow the steps of the New Disk Pool Wizard.

The following step provides the guidance to verify the names of the configured the auxiliary storage pool devices to the names of the saved auxiliary storage pool devices. When you configure the auxiliary storage pool devices using iSeries Navigator, these devices may or may not be assigned the same auxiliary storage pool number depending on the number of disk resources and the order these are configured. Since the auxiliary storage pool number may change, it is important to keep the name the same to allow for automated recovery.

If you are restoring objects to a different auxiliary storage pool device from which it was saved, you will need to change the default recovery options to specify the auxiliary storage pool where the objects are to be restored.

```

*****
__ STEP 025 : Verify Auxiliary Storage Pool Device Names
Start date/time _____ Stop date/time _____ Duration _____

Display the configured auxiliary sstorage pool device descriptions.

To do so, type the following command then press "Enter".

    WRKDEVD DEVD(*ASP)

Verify the configured auxiliary storage pool device names match the
names of the auxiliary storage pool devices listed in report QP1AASP.

Use option 8=Work with status to verify the status of each auxiliary
storage pool device status is AVAILABLE.

Display, verify and update the BRMS auxiliary storage pool information
as required.

To do so, type the following command then press "Enter".

    WRKASPBRM
*****

```

BRMS saves the history information for auxiliary storage pool devices by the auxiliary storage pool device name. This device name is displayed adjacent to the saved item name as shown in the sample report below. The step shown below will be included in the report if there are libraries saved from auxiliary storage pool devices. You would also see a similar section for recovery of any directories and files that might have been saved from auxiliary storage pool devices.

Note: You should always make sure the auxiliary storage pool devices are available when running the Start Maintenance for BRM (STRMNTBRM) or the Start Recovery using BRM (STRRCYBRM) commands.

When recovering libraries on auxiliary storage pool devices and recovering these to the same system and the same auxiliary storage pool device, you need to consider the following:

- When you vary on an auxiliary storage pool device, library QSYS200nnn (where nnn is the auxiliary storage pool number) is created on the auxiliary storage pool device as well as several objects.
- You should recover the saved QSYS200nnn library to the auxiliary storage pool device before you recovery the other libraries on that auxiliary storage pool device.
- When you recover the saved QSYS200nnn library, you should use *F9=Recovery defaults* from the *Select Recovery Items* display and set the *Allow object differences* prompt on the *Restore Command Defaults* panel to *ALL.
- When you recovery the remaining libraries, you should use *F9=Recovery defaults* from the *Select Recovery Items* display and set the *Allow object differences* prompt on the *Restore Command Defaults* panel to *FILELVL.

__ STEP 026 : Recover Additional User Libraries

Start date/time _____ Stop date/time _____ Duration _____

You should restore the current version of additional user libraries saved from auxiliary storage pool devices (33-255) or to TSM servers.

If you are performing a complete system restore, run the following command to continue:

STRRCYBRM OPTION(*RESUME)

Otherwise, run one or more of the following commands to recover these saved items.

Run the following command to recover additional libraries in the system (1) or basic user (2-32) auxiliary storage pools saved to TSM servers :

STRRCYBRM OPTION(*ALLUSR) ACTION(*RESTORE) USEADSM(*YES)

Run the following command to recover additional libraries in auxiliary storage pool devices saved from the current system:

STRRCYBRM OPTION(*ASPDEV) ACTION(*RESTORE) ASPDEV((*LCL *ALL *LIB))

Specify parameter USEADSM(*YES) if these were saved to TSM servers.

Run the following command to recover additional libraries in auxiliary storage pool devices saved from another system:

STRRCYBRM OPTION(*ASPDEV) ACTION(*RESTORE) ASPDEV((system-name auxiliary-storage-pool-name *LIB) (system-name auxiliary-storage-pool-name *LIB) ...)

Specify parameter USEADSM(*YES) if these were saved to TSM servers.

Type your command choice then press "Enter".

--- Attention -----
If you have logical files in libraries whose based-on physical files are in different libraries, you must recover the libraries containing the physical files before you recover the libraries containing the logical files.

--- Attention -----
If you use journaling, the libraries containing the journals must be restored before restoring the libraries containing the journaled files.

--- Attention -----

If you are restoring libraries to an auxiliary storage pool device with the same name but a different auxiliary storage pool number the following libraries will automatically be renamed when restored:

QSYS2nnnnn
QRCLnnnnn
SYSIBnnnnn

where nnnnn is the number of the auxiliary storage pool device.

--- Attention -----

The QSYS2nnnnn libraries must be restored before all other libraries.

To recover the QSYS2nnnnn libraries, do the following:

- ___ Press F9 to go to the Recovery Defaults Display.
- ___ Change the value of Allow object differences to *ALL.
- ___ Press "Enter" to return to the Select Recovery Items display.
- ___ Select and recovery the QSYS2nnnnn libraries.
- ___ Press F9 to go to the Recovery Defaults Display.
- ___ Change the value of Allow object differences to *NONE or *FILELVL.
- ___ Press "Enter" to return to the Select Recovery Items display.
- ___ Continue recovery of the remaining libraries.

Select the saved item(s) listed below from the "Select Recovery Items" display then press "Enter" to recover these saved items. Recovery of these saved items will require the volumes listed on the report or duplicate volumes.

Saved Item	Type	ASP Name	ASP Number	Save Date	Save Time	Objects	Omit	Sequence Number	Control Group	Volume Identifier
___ EMPLOYEES	*FULL	PAYROLL	00033	8/22/02	13:09:52	6		1	SYSTEM	SAVS2
___ AUG2002	*FULL	ACCOUNTS	00034	8/22/02	13:21:57	6		2	SYSTEM	SAVS2

__ STEP 027 : Recover Additional Directories and Files

Start date/time _____ Stop date/time _____ Duration _____

You should restore the current version of additional directories and files saved from auxiliary storage pool devices (33-255) or saved to TSM servers.

If you are performing a complete system restore, run the following command to continue:

STRRCYBRM OPTION(*RESUME)

Otherwise, run one or more of the following commands to recover these saved items.

--- Attention -----

If you are performing a complete system recovery and the user-defined file systems on auxiliary storage pool devices were saved unmounted, type the following command and press "Enter" to unmount the file systems:

UNMOUNT TYPE(*ALL) MNTOVRDIR(*ALL)

Run the following command to recover additional directories and files in the system(1) or basic user (2-32) auxiliary storage pools saved to TSM servers.

```
STRRCYBRM OPTION(*LNKLIST) ACTION(*RESTORE) USEADSM(*YES)
```

Run the following command to recover additional directories and files in auxiliary storage pool devices saved from the current system:

```
STRRCYBRM OPTION(*ASPDEV) ACTION(*RESTORE)
ASPDEV((*LCL *ALL *LNK))
```

Specify parameter USEADSM(*YES) if these were saved to TSM servers.

Run the following command to recover additional directories and files in auxiliary storage pool devices saved from another system:

```
STRRCYBRM OPTION(*ASPDEV) ACTION(*RESTORE)
ASPDEV((system-name auxiliary-storage-pool-name *LNK)
(system-name auxiliary-storage-pool-name *LNK) ... )
```

Specify parameter USEADSM(*YES) if these were saved to TSM servers.

Type your command choice then press "Enter".

Select the saved item(s) listed below from the "Select Recovery Items" display then press "Enter" to recover these saved items. Recovery of these saved items will require the volumes listed on the report or duplicate volumes.

--- Objects ---										
Saved Item	Type	----- ASP Name	----- Number	Save Date	Save Time	Not Saved	Sequence Number	Control Group	Volume Identifier	
—	*LINK	*FULL LOTUS	00035	2/07/03	11:54:06	5	4	QLTSDOM01	1959AF	
—	*LINK	*FULL LOTUS	00035	2/07/03	11:56:14	5	5	QLTSDOM01	1959AF	

Chapter 17. Using Tape Automation with BRMS

This chapter describes the methods that you can use with BRMS to use devices such as a 3494 Automated Tape Library Dataserver or a Magstar MP 3570 Tape Library. BRMS refers to this class of automated tape libraries as media libraries.

Adjustments to BRMS When Using Tape Automation

If you were using BRMS before installing a media library, you need to make a few adjustments. If you use BRMS to manage and control daily operations, you will not notice many changes when you begin to use a media library. Once the media library is set up and the media is appropriately enrolled, BRMS assumes control of the media library. You do not need to alter your BRMS control groups, scheduling, or reporting. As part of your initial setup, you may need to adjust the following:

- Locations
- Devices
- Move policies
- Media policies
- Control group attributes

You should review your backup and archive strategy, when using a media library. For example you may want to:

- Alter the size of backup groups
- Alter the frequency of backups
- Increase the size of archive groups
- Alter the frequency of archive operations
- Introduce dynamic recall

Setting up Tape Automation with BRMS

This topic describes some of the actions required in setting up a media library before you use it with BRMS. This section assumes that a media library is installed and operational. For full planning and installation of the media library, consult the publication shipped with the device.

Creating Tape Automation on Your System

BRMS requires that the device descriptions for the library and its device resources exist on the iSeries server. Refer to the Manage tape libraries topic in the iSeries Information Center for information on how to create these device descriptions. After you set up the media library and vary it on, you use the INZBRM *DEVICE command to update BRMS with all the proper defaults for the new devices.

Basic Setup of a Media Library with BRMS

Before a media library can be used, you must add media to the library and enroll the volumes into BRMS. If the media library is empty, open the door and add all available media into empty cells rather than add only a small number at a time through the convenience I/O station. When closing the door, the media library checks each cell and records the volume ID of each media cartridge (volume). This information is kept in the media library manager database for the 3494 and in i5/OS for the other media library devices. From the iSeries, you can view this information by using the Work with Media Library BRM (WRKMLBBRM) command. This command lists all media library devices on your system that are enrolled in BRMS. If you select option 8 (Work with MLB Media), the status of the volumes that are currently in the media library are displayed as shown below. The WRKMLMBRM command can also be

used to go directly to this display. When setting up a media library for the first time, the Media Class is *NONE because the volume is not enrolled in BRMS.

```

Work with Media Library Media                                RCHAS400

Media library . . . . . : TAPMLB01
Position to . . . . .           Starting characters

Type options, press Enter.
 1=Add MLB media      2=Work with media    5=Initialize
 6=Change category   7=Eject      8=Mount      9=Demount

Media          ---BRM Information---
Opt Volume Type Category Media Class Expired Status
000BE6 G *SHARE400 FMT3570E          Mounted
000B84 H *SHARE400 FMT3570E          *YES Mounted
000CB7 H *SHARE400 FMT3570E          *YES Available
000C3C G *SHARE400 FMT3570E          Available
000C90 H *SHARE400 FMT3570E          *YES Available
000DB9 G *SHARE400 FMT3570E          *YES Available
000D28 G *NOSHARE *NONE              Available
000D63 G *SHARE400 FMT3570E          *YES Available

More...

F3=Exit  F5=Refresh  F9=System command  F12=Cancel  F13=Repeat

```

Other options from this display; including mount, demount, and eject; can be used to manipulate the volumes within a media library. BRMS communicates changes in its media inventory to be reflected in the media library media inventory. For example, when you change the shared media attribute of a media class, BRMS runs the CHGTAPCTG command to change the category of all volumes of that media class in the media library.

Enrolling Tape Automation Media (volume) into BRMS

From the Work with Media Libraries display (WRKMLMBRM) command, select option 11 (Add MLB media) against the media library device that is attached to your system. The ADDMLMBRM prompt display as shown below.

```

Add MLB Media using BRM (ADDMLMBRM)

Type choices, press Enter.

Media library device . . . . . > MLB01 Name
Volume identifier . . . . . *INSERT Character value, *INSERT
+ for more values
Add volume to BRM . . . . . > *YES *NO, *YES
Initialize tape . . . . . *NO *NO, *YES
Media class . . . . . > CART3490E CART3490E, QIC120...
Last moved date . . . . . *NONE Date, *NONE
Move policy . . . . . *NONE *NONE, OFFSITE

```

You can enroll all newly-inserted volumes into the BRMS media inventory. If you use the default value for the VOL parameter (*INSERT) and change the Add volume to BRM field to *YES, all volumes that were previously in the *INSERT category (from the Work with MLB Media display) are enrolled into the BRMS media inventory and are available for use.

Save and Restore Tasks

When performing save or restore operations with a media library and BRMS, consider the following.

Performing a Normal Save Operation

Using a media library for either a control group save operation or a save operation with the SAVOBJBRM, SAVLIBBRM, SAVOBJLBRM, SAVSYSBRM, or the SAVMEDIBRM commands provides certain advantages. Specifically, the save operation and save media are easier to track than if you were to use i5/OS save commands and save to a media library. The save command or control group define the objects to be saved. The media policy specifies a media class that is defined with a drive which is found within a media library. BRMS supports the location as a media qualifier in both the media policy and the SETMEDBRM command. When coupled with *MEDCLS as a device identifier in a media policy, BRMS attempts to select a device that is at the same location as the media. An example of this would be a drive in the media library. Output operations to a device in a media library may require nonspecific (*MOUNTED) volumes when no volume is in the drive. If this occurs, BRMS refers to its inventory of available scratch media to select one that is in the media library. BRMS then requests a mount of that tape. An end option of *UNLOAD (the default for a backup control group) causes the volume to be returned to its cell when the control group has completed processing. If a BRMS save command is used, the end option default of *REWIND should be accepted. The control group attributes or backup policy may be changed to *REWIND. In either case, the volume remains in the drive after the save operation has completed.

Save Storage and BRMS

BRMS does not support the use of the Save Storage (SAVSTG) command. The SAVSTG command does not support tape automation. All operations must be done in Stand Alone mode or with a category mounted to the media library.

Using the Save Licensed Program Command

The SAVLICPGM command does not support tape automation. All operations must be done in Stand Alone mode or with a category mounted to the media library. BRMS does not support the SAVLICPGM command. For system recovery, the product libraries are saved under the *IBM grouping. You cannot restore these with the RSTLICPGM command. Consult your BRMS recovery report for further details.

Recovery Process Using Tape Automation

Using a media library is quite simple, whether the STRRCYBRM, RSTLIBBRM, RSTOBJBRM, or RSTDLOBRM commands are used, or if recovery is performed from the WRKMEDIBRM, WRKOBJBRM or WRKFLRBRM displays. As long as the required volume is in the media library, the restore operation is automatic, with no message being sent to the QSYSOPR message queue to load the volume. A message is sent to the BRMS log to notify the status of the restore operation. When the restore operation is complete, the last volume used remains in the tape drive unless otherwise specified. The end-of-tape option *UNLOAD returns the volume to its storage cell. If the required volume has been moved to another location, an inquiry message is sent to the QSYSOPR message queue. The message prompts the operator to insert the volume in the convenience I/O station or the high-capacity I/O area. If the volume is off-site, the operator can cancel the restore operation from this message. Once the volume is in either the convenience or high-capacity I/O areas, the media library places it in a storage cell, and BRMS mounts it in the drive to complete the restore operation.

Recovering an Entire System (Starting with Licensed Internal Code)

Ensure that your media library device is in stand-alone mode before starting "STEP: Recover Licensed Internal Code" during BRMS System Recovery. See the documentation on your device to learn how to properly change the mode for your media library device.

Completing the Recovery

When the restricted state portion of the recovery is complete, tape automation can be used when the following conditions are met:

- The 3494 device and communication configurations are restored or recreated.
- The media library configuration data has been restored or recreated.

Tape automation requires a minimum level of system function to be recovered before an automatic volume mounting can occur. In general, automation can begin with "STEP: Recover User Profiles" on the BRMS System Recovery Report. It is recommended that you switch the media library to random mode during "STEP: Initialize BRMS Device and Media Library Information" during BRMS System Recovery to automate the remainder of your system recovery.

Tasks for Archiving

When you use tape automation with BRMS, this opens more opportunities for archiving. Full tape automation allows archiving to be performed quickly and effortlessly while appearing seamless in its operation. The introduction of dynamic retrieval further enhances archiving potential.

Consult *Hierarchical Storage Management*, SC41-5351-01 for more information about archive, dynamic retrieval, and other storage management features of BRMS.

Archiving When Using Tape Automation

To provide the most acceptable recall performance, you must minimize the tape location and the load delays. You will probably keep a large portion of your archived data within the tape automation. This uses a large amount of capacity. When establishing a move policy, you should consider the following:

- How often will you access your data?
- How long will you need to have access to your data?

For example, you might access a monthly report only up until the time that the next month's report is created. You might have other information that you need to access at all times yet access only occasionally. Your move policy will be based on the needs of your business. If you adjust the movement delay periods, this changes the population levels of the media library.

Using Dynamic Retrieval

To further improve your archive and retrieval performance, use the dynamic retrieval function within BRMS. This function allows on-demand retrieval of the file members that have been archived and now need to be accessed again.

To accomplish this, change your archive control group such that the archiving requested keeps the object descriptions. This is known as save with storage free. To do this, change the retain object description parameter on either the archive control-group options or the archive policy to *YES.

You must set up your BRMS retrieval policy with the appropriate retrieval modes (*VERIFY, *NOTIFY, *DELAY or *SBMJOB), preferred devices, restore options, and authorities. The Hierarchical Storage Management book contains more information on these modes.

Moving Volumes with BRMS

When BRMS operations such as Add media or Confirm move required media to be moved to or from a media library, BRMS prompts operators as needed. It instructs them to place media into, or remove media from the media library and then uses CL commands to verify that the operation is successful.

For devices such as 3494 Media Library Dataserver, a move policy or manual move of media causes the library manager to eject the tape into the convenience I/O station or the high-capacity I/O area. Additional prompting and verification is done when media, ejected from one media library location, are inserted into another. When a volume is moved into the media library, the library manager shows that the volume is in *INSERT category.

If you move a volume to a media library when media movements are to be confirmed, BRMS attempts to change the category of volumes from *INSERT to *SHARE400 or *NOSHARE, as applicable to the media class. If at the time of the confirm move, the volume has not been placed in your media library, a message is logged in the BRMS log. These volumes must be changed to *SHARE400 before they can be used by BRMS.

If move verification is not enabled, BRMS attempts to change the category of volumes that move into a media library from *INSERT to *SHARE400 or *NOSHARE immediately. This can cause a problem, as common maintenance (STRMNTBRM command) is run at night after backups have completed, and volumes have not been moved off site. In this case, it may be worthwhile to use the PRTMOVBRM command during the day before the move is to take place. Use the PRTMOVBRM command to ensure that you collect the volumes and insert them into the media library before the MOVMEDEBRM is actually processed.

Chapter 18. Tape I/O From A Program

Typically, applications written in RPG or COBOL will perform data record input and output (I/O) to database files. However, in some applications these files may be so large, that you never store them on disk. You store them on tape, and process them sequentially by application programs, either for input or for output, but not both at once. On the iSeries, this is done using a tape file object.

Such applications have the same requirements for control and tracking of the media on which the operations are performed as do media used for normal save and restore operations. This chapter discusses how you can use these types of tape file I/O applications with BRMS.

The example in Figure 15 shows typical tape file processing from an application. It is a simple RPG program which writes the alphabet 100 times to a tape.

```
FTAPFIL 0 F 26 SEQ
F*****
F* Program: TAPFIL
F* Purpose: This program will write the 26 letters of the
F* alphabet to a file on tape through a tape file. The
F* alphabet is written 100 times.
F*
F*****
C DO 100 Loop 100 times
C EXCPTALPHA Write alphabet
C END End of loop
C*
C SETON LR End the program
O*****
O* Exception output defining the alphabet to be written
O*
O*****
OTAPFIL E ALPHA
O 24 'ABCDEFGHIJKLMNOPQRSTUVWXYZ'
O 26 'YZ'
```

Figure 15. Sample Program to Perform Tape File I/O

This application requires a tape file object to be created such that the program can address the tape drive. You create this with the CRTTAPF command as follows:

Create Tape File (CRTTAPF)

Type choices, press Enter.

```

File . . . . . TAPFIL      Name
Library . . . . . BRMTAPF   Name, *CURLIB
Tape device . . . . . *NONE   Name, *NONE
      + for more values
Volume identifier . . . . . *NONE   Character value, *NONE
      + for more values
Tape reels specifications:
Label processing type . . . . *SL      *SL, *NL, *NS, *BLP, *LTM
Number of reels . . . . . 1      1-255
Sequence number . . . . . 1      1-16777215, *END, *NEXT
Tape label . . . . . TAPEFILXMP
File type . . . . . *DATA     *DATA, *SRC
Text 'description' . . . . . 'Tape file example'

                                                    Bottom
F3=Exit  F4=Prompt  F5=Refresh  F10=Additional parameters  F12=Cancel
F13=How to use this display  F24=More keys

```

Once you create the tape file, you can process the program. However, for flexibility, you may have noticed that we have not specified a tape device name. So before you process the program TAPFIL, we need to perform an override of the tape file with the OVRTAPF command, as follows:

Override with Tape File (OVRTAPF)

Type choices, press Enter.

```

File being overridden . . . . . TAPFIL      Name
Overriding to tape file . . . . *FILE     Name, *FILE
Library . . . . .                Name, *LIBL, *CURLIB
Device . . . . . TAP03           Name
      + for more values
Volume identifier . . . . .                Character value, *NONE
      + for more values
Tape reels specifications:
Label processing type . . . . *SL      *SL, *NL, *NS, *BLP, *LTM
Number of reels . . . . . 1      1-255
Sequence number . . . . . 1      1-16777215, *END, *NEXT
File label . . . . .
Record length . . . . .                Number, *CALC
Block length . . . . . 1-524288, *CALC
Buffer offset . . . . .                Number, *BLKDSC
Record block format . . . . . *F, *FB, *V, *VB, *D, *DB...
                                                    More...
F3=Exit  F4=Prompt  F5=Refresh  F12=Cancel  F13=How to use this display
F24=More keys

```

This associates the tape file name to the tape device. Notice that the volume ID field is not specified.

Next we can call the program, as follows:

```
CALL BRMTAPF/TAPFIL
```

The records are written to the tape.

Using BRMS for Tape File Processing

BRMS can play a part in the processing as described above such that the tape volume created is controlled and tracked just like any other BRMS enrolled tape volume.

To do this, you must perform two actions:

1. Use a tape volume that is enrolled in the BRMS media inventory,
2. Use the SETMEDBRM command before processing the program.

The first step is as simple as inserting a tape as is done for save purposes. The second step, using SETMEDBRM, allows you to specify media management parameters to be associated with the written tape. You can specify this command as follows:

```
Set Media Controls using BRM (SETMEDBRM)

Type choices, press Enter.

Input controls:
  File label . . . . . *SAME
  Select version . . . . . *SAME      1-999, *SAME, *CURRENT
  Allow conversion . . . . . *SAME    *SAME, *NO, *YES
  Media class . . . . . QIC2GB      *NONE, *SAME, AAA, AAAA, AA...
  Move policy . . . . . TAPEFILE    *NONE, *SAME, AANANCY, AASL...
  Secure volume . . . . . *NO        *SAME, *NO, *YES

Retention:
  Retention type . . . . . *VERSION  *SAME, *DATE, *DAYS, *NONE...
  Retain media . . . . . 3          *SAME, Date, Number
  File group . . . . . *SAME        *SAME, *NONE, *SYSTEM, *BKU...
  File group type . . . . . *SAME    *SAME, *NONE, *BKU, *ARC
  Mark volumes for duplication . . *NO    *SAME, *NO, *YES
  Mark history for duplication . . *NO    *SAME, *NO, *YES
  Text . . . . . Tape File Example

Bottom
F3=Exit  F4=Prompt  F5=Refresh  F12=Cancel  F13=How to use this display
F24=More keys
```

The SETMEDBRM command for an output (write) operation, as in our example, allows you to set the following media characteristics:

- Media class
- Move policy
- Volume security
- Retention information
- File group information
- Associated Text

This command works a little like the OVRTAPF. You do not see any output. It *registers* the values you enter, and when an application writes to a tape file, these values are applied to the tape operation.

To fine the volume used by the operation, run the following command:

```
WRKMEDBRM MEDCLS(QIC2GB)
```

When the volumes lists appears on the *Work With Media* display, locate the volume with the current *Creation Date*, in this example, TFIL01 was the volume on the tape drive during the processing of the program.

```

Work With Media
System: RCHAS400
Position to . . . . . Starting characters
Type options, press Enter.
  1=Add  2=Change  4=Remove  5=Display  6=Work with serial set  7=Expire
  8=Move 10=Reinitialize ...

  Volume      Creation Expiration      Move      Media      Dup
Opt  Serial    Expired   Date      Date      Location  Date      Class     Sts
  5  TFIL01          12/14/05 *VER 003  *HOME     *NONE     QIC2GB

More...

Parameters or command:
===>
F3=Exit  F4=Prompt  F5=Refresh  F11=Volume system  F12=Cancel  F17=Top
F18=Bottom  F23=More options

```

Use option 5 to see additional media attributes for the volume.

```

Display Media Attributes

Volume serial . . . . . : TFIL01
Media type . . . . . :
Image catalog . . . . . :
Media class . . . . . : QIC2GB
Expiration date . . . . . : *VER 003
Previous location . . . . . : *NONE
Previous slot number . . . . . : 0
Current location . . . . . : *HOME
Last moved date . . . . . : *NONE
Scheduled location . . . . . : *NONE
Scheduled move date . . . . . : *NONE
Container ID . . . . . : *NONE
Move policy . . . . . : TAPEFILE
Creation date . . . . . : 12/14/05
Secure volume . . . . . : *NO
Beginning volume . . . . . : TFIL01
Slot number . . . . . : 21

Press Enter to continue.

```

WRKMEDIBRM also shows that some save operations have occurred, as follows:

```

Work with Media Information                                RCHAS400

Position to Date . . . . .

Type options, press Enter.
 2=Change  4=Remove  5=Display  6=Work with media  7=Restore
 9=Work with saved objects  ...

  Saved      Save      Save      Save      Parallel Volume  File      Expire
Opt Item    Date      Time      Type      Devices  Serial  Sequence  Date
 5 *LABEL    12/14/05  14:59:46 *FILE                                TFIL01      1 *VER003

F3=Exit  F5=Refresh  F11=Object detail  F12=Cancel  Bottom
F23=More options

```

Figure 16. WRKMEDIBRM Command Screen

Use option 5 (Display) to see the following screen that presents a record of writing the data to the tape.

```

Display Media Information

Save command . . . . . : SAVSPLF
Saved item . . . . . : *LABEL
Save type . . . . . : *FILE
Save date. . . . . : 12/14/05
Save time. . . . . : 14:59:46
Device(s) . . . . . : TAP03

Move policy . . . . . : TAPEFILE
Expiration date . . . . . : *VER 003
Volume serial(s) . . . . . : TFIL01

Parallel devices . . . . . :
File sequence . . . . . : 1
Number of objects saved . . . . . : 0
Number of objects not saved . . . . . : 0
Saved size . . . . . : 0
Label . . . . . : TAPEFILXMP
Error message . . . . . :

More...

Press Enter to continue.

```

Due to the nature of the method used to get the data on the tape, option 7 to restore will not allow you to restore this object. Similarly, there are no saved objects to work with if you use option 9.

Recovery

As the file on the tape is never intended to be restored to the iSeries server, you never see the tape file record on a Recovery Analysis Report.

Using BRMS for Input Processing

We have just seen an example of how BRMS can keep information about media written using tape file output. Input processing is very similar, with the exception of the parameters on the SETMEDBRM command.

You can use the following program to read the records that were written by the first example:

```
FTAPFIL  IF  F      26          SEQ
FTAPRPT  O   F      26          PRINTER
F*****
F*   Program: TAPFIL2
F*   Purpose: This program will read the letters of the alphabet
F*             from a file on tape through a tape file. The program
F*             will read the 100 records created with the other
F*             example and dump them to the printer
F*****
IALPHA   DS          26
I*****
C             DO  100          Loop 100 times
C             READ TAPFIL  ALPHA      99Read alphabet
C             EXCPTALFOUT          Write alphabet
C             END          End of loop
C             SETON          LR      End the program
O*****
O*   Exception output defining the alphabet to be printed
O*
O*****
OTAPRPT  E          ALFOUT
O             ALPHA      26
```

Figure 17. Program to Read Records from Tape and Print

This example also requires a printer file object such that the records are printed. Use the CRTPRTF command.

The same processing would occur, namely:

1. Use the program above
2. Use the same tape file
3. Issue OVRTAPF to specify the device name as before
4. Issue SETMEDBRM as shown in Figure 18 on page 303
5. Run the program when you specify:

```
CALL BRMTAPF/TAPFIL2
```

```

Set Media Controls using BRM (SETMEDBRM)

Type choices, press Enter.

Input controls:
File label . . . . . TAPEFILXMP
Select version . . . . . *CURRENT      1-999, *SAME, *CURRENT
Allow conversion . . . . . *NO          *SAME, *NO, *YES
Media class . . . . . *SAME           *NONE, *SAME, QIC120...
Move policy . . . . . *SAME           *NONE, *SAME, OFFSITE...
Secure volume . . . . . *SAME         *SAME, *NO, *YES

Retention:
Retention type . . . . . *SAME         *SAME, *DATE, *DAYS, *NONE...
Retain media . . . . . *SAME          *SAME, Date, Number
File group . . . . . *NONE           *SAME, *NONE, *SYSTEM, *BKU...
File group type . . . . . *NONE       *SAME, *NONE, *BKU, *ARC
Mark volumes for duplication . . . . *NO          *SAME, *NO, *YES
Mark history for duplication . . . . *NO          *SAME, *NO, *YES
Text . . . . . *SAME

Bottom
F3=Exit  F4=Prompt  F5=Refresh  F12=Cancel  F13=How to use this display
F24=More keys

```

Figure 18. SETMEDBRM Command Prompt Screen for Program Input

BRMS will look for an open of a tape file called TAPFIL, and will prompt the operator to insert the tape volume corresponding to the most recent version of this file. If this file were in ASCII format, we could specify that we do not want i5/OS to convert the record to EBCDIC automatically. Specify *Allow conversion* Yes to do this.

Input/Output Processing with Multiple Devices

This example is an extension to the ones that were provided previously. These examples had two programs that wrote, then read data to and from a tape. In this example, we will use two tape drives. We will read the data from the tape already written in the previous example, and write a new file on tape which includes the original records and some new records.

The sequence of events is this:

1. Create Tape File objects
2. Compile the program (RPG in this example)
3. Use OVRTAPF to select devices
4. Issue SETMEDBRM to influence the choice of tapes used
5. Run the program

1. Create Tape File Objects

The name of the tape file itself is quite irrelevant to the processing of the files on tape. It is the Tape Label field in the CRTTAPF command that is significant. As we are updating a file on tape, both the input file (TAPFIL) and the output file (TAPFIL2) have the same File Label (TAPEFILXMP).

Create Tape File (CRTTAPF)

Type choices, press Enter.

```
File . . . . . TAPFIL      Name
Library . . . . . BRMTAPF   Name, *CURLIB
Tape device . . . . . *NONE   Name, *NONE
                + for more values
Volume identifier . . . . . *NONE   Character value, *NONE
                + for more values
Tape reels specifications:
Label processing type . . . . *SL      *SL, *NL, *NS, *BLP, *LTM
Number of reels . . . . . 1      1-255
Sequence number . . . . . 1      1-16777215, *END, *NEXT
Tape label . . . . . TAPEFILXMP
File type . . . . . *DATA      *DATA, *SRC
Text 'description' . . . . . Tape File Example
```

Bottom

F3=Exit F4=Prompt F5=Refresh F10=Additional parameters F12=Cancel
F13=How to use this display F24=More keys

Create Tape File (CRTTAPF)

Type choices, press Enter.

```
File . . . . . TAPFIL2     Name
Library . . . . . BRMTAPF   Name, *CURLIB
Tape device . . . . . *NONE   Name, *NONE
                + for more values
Volume identifier . . . . . *NONE   Character value, *NONE
                + for more values
Tape reels specifications:
Label processing type . . . . *SL      *SL, *NL, *NS, *BLP, *LTM
Number of reels . . . . . 1      1-255
Sequence number . . . . . 1      1-16777215, *END, *NEXT
Tape label . . . . . TAPEFILXMP
File type . . . . . *DATA      *DATA, *SRC
Text 'description' . . . . . Tape File Example
```

Bottom

F3=Exit F4=Prompt F5=Refresh F10=Additional parameters F12=Cancel
F13=How to use this display F24=More keys

2. Compile The Program

You need to compile the RPG program. The following code is a simple example to demonstrate the function.

```
FTAPFIL IF F 26 SEQ
FTAPFIL2 O F 26 SEQ
ITAPFIL AA
I 1 26 ALPHA
F*****
F* Program: TAPFIL2
F* Purpose: This program will read the 26 letters of the
F* alphabet from a tap file (TAPFIL), then write them
F* with some other data to an output file TAPFIL2.
F*
F*****
C DO 100 Loop 100 times
C READ TAPFIL 01Read alphabet
C EXCPTALPHA1 WRITE ALPHA
C END End of loop
O*****
```

```

C          DO 10          Loop 10 times
C          EXCPTALPHA2   Write new rcds
C          END           End of loop
C          SETON         LR   End the program
O*****
O* Exception output defining the alphabet to be written
O*
O*****
OTAPFIL2 E          ALPHA1
O                   ALPHA   26
OTAPFIL2 E          ALPHA2
O                   24 '123456789012345678901234'
O                   26 '56'

```

3. Use OVRTAPF to Indicate Which Tape Drives to Use

After you identify two available tape drives, use the OVRTAPF command to associate each tape file with an available drive. You do not need to mount the tapes at this time.

Override with Tape File (OVRTAPF)

Type choices, press Enter.

File being overridden	TAPFIL	Name
Overriding to tape file	*FILE	Name, *FILE
Library		Name, *LIBL, *CURLIB
Device	TAP01	Name
	+ for more values	
Volume identifier		Character value, *NONE
	+ for more values	
Tape reels specifications:		
Label processing type		*SL, *NL, *NS, *BLP, *LTM
Number of reels		1-255
Sequence number		1-16777215, *END, *NEXT
File label		
Record length		Number, *CALC
Block length		1-524288, *CALC
Buffer offset		Number, *BLKDSC
Record block format		*F, *FB, *V, *VB, *D, *DB... More...
F3=Exit F4=Prompt F5=Refresh F12=Cancel F13=How to use this display		
F24=More keys		

Override with Tape File (OVRTAPF)

Type choices, press Enter.

File being overridden	TAPFIL2	Name
Overriding to tape file	*FILE	Name, *FILE
Library		Name, *LIBL, *CURLIB
Device	TAP03	Name
	+ for more values	
Volume identifier		Character value, *NONE
	+ for more values	
Tape reels specifications:		
Label processing type		*SL, *NL, *NS, *BLP, *LTM
Number of reels		1-255
Sequence number		1-16777215, *END, *NEXT
File label		
Record length		Number, *CALC
Block length		1-524288, *CALC
Buffer offset		Number, *BLKDSC
Record block format		*F, *FB, *V, *VB, *D, *DB... More...
F3=Exit F4=Prompt F5=Refresh F12=Cancel F13=How to use this display		
F24=More keys		

Volume R00009 contains the alphabet that is written 100 times by the previous example. T00009 is an expired tape of the media class we want to use.

```

Work With Media
System: RCHAS400
Position to . . . . . Starting characters
Type options, press Enter.
1=Add 2=Change 4=Remove 5=Display 6=Work with serial set 7=Expire
8=Move 10=Reinitialize ...

Volume          Creation Expiration
Opt Serial      Expired  Date      Date      Location  Move  Media  Dup
M00001          5/31/05 *PERM    VAULT    7/06/05  QIC2GB
M00002          5/31/05 *PERM    *HOME    *NONE    NOSHARE
M00003          5/31/05 *PERM    *HOME    *NONE    QIC2GB
R00009          8/01/05 8/06/05 *HOME    *NONE    QIC2GB
T00001 *YES      7/04/05 *NONE    *HOME    *NONE    QIC1GB
T00002 *YES      7/04/05 7/04/05 *HOME    *NONE    QIC1GB
T00003          7/04/05 *VER 002 *HOME    7/04/05 QIC4GB
T00009 *YES      8/01/05 8/01/05 *HOME    *NONE    QIC4GB

Bottom

Parameters or command:
===>
F3=Exit  F4=Prompt  F5=Refresh  F11=Volume system  F12=Cancel  F17=Top
F18=Bottom  F23=More options

```

4. Use SETMEDBRM to Involve BRMS in Managing the Tape

You need to use the SETMEDBRM command only once to control the input from TAPFIL and output to TAPFIL2. For input, the File Label field, TAPEFILXMP, is what controls which tape is selected. The Select Version field instructs BRMS to associate TAPEFILXMP with the correct tape, in our case T00009.

For output, the fields Media Class, Move Policy, Secure Volume, and Retention all control the tape that is selected and its media management characteristics after the tape is written.

```

Set Media Controls using BRM (SETMEDBRM)
Type choices, press Enter.
Input controls:
File label . . . . . TAPEFILXMP
Select version . . . . . *CURRENT 1-999, *SAME, *CURRENT
Allow conversion . . . . . *YES *SAME, *NO, *YES
Media class . . . . . QIC$GB *NONE, *SAME, AAA, AAAA, AA...
Move policy . . . . . OFFSITE *NONE, *SAME, AANANCY, AASL...
Secure volume . . . . . *NO *SAME, *NO, *YES
Retention:
Retention type . . . . . *DAYS *SAME, *DATE, *DAYS, *NONE...
Retain media . . . . . 30 *SAME, Date, Number
File group . . . . . *NONE *SAME, *NONE, *SYSTEM, *BKU...
File group type . . . . . *NONE *SAME, *NONE, *BKU, *ARC
Mark volumes for duplication . . *NO *SAME, *NO, *YES
Mark history for duplication . . *NO *SAME, *NO, *YES
Text . . . . . *SAME

Bottom
F3=Exit F4=Prompt F5=Refresh F12=Cancel F13=How to use this display
F24=More keys

```

Call the Program

You can then call the RPG program. If the operator is aware of which volumes are to be used for input and output, they can be placed in the appropriate tape drives. Otherwise, BRMS will send a message to QSYSOPR with instructions on volumes to use.

```

MAIN                               OS/400 Main Menu                System:  RCHAS400

Select one of the following:

    1. User tasks
    2. Office tasks
    3. General system tasks
    4. Files, libraries, and folders
    5. Programming
    6. Communications
    7. Define or change the system
    8. Problem handling
    9. Display a menu
   10. Information Assistant options
   11. iSeries Access tasks

   90. Sign off

Selection or command
===> CALL BRMTAPF/TAPFIL2

F3=Exit  F4=Prompt  F9=Retrieve  F12=Cancel  F13=Information Assistant
F23=Set initial menu

```

Results

After you run the program, the BRMS media inventory is updated to reflect that volume T00009 is now in use with expiration characteristics as specified in the SETMEDBRM command. (The volume still shows as being in the *HOME location as media movement has not yet been run.)

```

                                Work With Media                System:  RCHAS400

Position to . . . . .           Starting characters

Type options, press Enter.
  1=Add  2=Change  4=Remove  5=Display  6=Work with serial set  7=Expire
  8=Move 10=Reinitialize ...

   Volume      Creation Expiration      Move      Media      Dup
Opt Serial   Expired  Date      Date      Location  Date      Class     Sts
M00001          5/31/05  *PERM     VAULT    7/06/05  QIC2GB
M00002          5/31/05  *PERM     *HOME    *NONE    NOSHARE
M00003          5/31/05  *PERM     *HOME    *NONE    QIC2GB
R00009          8/01/05   8/06/05  *HOME    *NONE    QIC2GB
T00001  *YES      7/04/05  *NONE     *HOME    *NONE    QIC1GB
T00002  *YES      7/04/05  7/04/05  *HOME    *NONE    QIC1GB
T00003          7/04/05  *VER 002  *HOME    7/04/05  QIC4GB
5  T00009  *YES      8/01/05   8/31/05  *HOME    *NONE    QIC4GB

                                                                Bottom

Parameters or command:
===>
F3=Exit  F4=Prompt  F5=Refresh  F11=Volume system  F12=Cancel  F17=Top
F18=Bottom  F23=More options

```

Display Media Attributes

```

Volume serial . . . . . : T00009
Media type . . . . . :
Image catalog . . . . . :
Media class . . . . . : QIC4GB
Expiration date . . . . . : 8/31/05
Previous location . . . . . : *NONE
Previous slot number . . . . . : 0
Current location . . . . . : *HOME
Last moved date . . . . . : *NONE
Scheduled location . . . . . : *NONE
Scheduled move date . . . . . : *NONE
Container ID . . . . . : *NONE
Move policy . . . . . : OFFSITE
Creation date . . . . . : 8/01/05
Secure volume . . . . . : *NO
Beginning volume . . . . . : T00009
Slot number . . . . . : 0
    
```

Press Enter to continue.

More...

Option 13, work with content, shows what is on the tape.

Work With Media

System: RCHAS400

Position to Starting characters

Type options, press Enter.

1=Add 2=Change 4=Remove 5=Display 6=Work with serial set 7=Expire
8=Move 10=Reinitialize ...

Opt	Volume Serial	Expired	Creation Date	Expiration Date	Location	Move Date	Media Class	Dup Sts
	M00001		5/31/05	*PERM	VAULT	7/06/05	QIC2GB	
	M00002		5/31/05	*PERM	*HOME	*NONE	NOSHARE	
	M00003		5/31/05	*PERM	*HOME	*NONE	QIC2GB	
	R00009		8/01/05	8/06/05	*HOME	*NONE	QIC2GB	
	T00001	*YES	7/04/05	*NONE	*HOME	*NONE	QIC1GB	
	T00002	*YES	7/04/05	7/04/05	*HOME	*NONE	QIC1GB	
	T00003		7/04/05	*VER 002	*HOME	7/04/05	QIC4GB	
13	T00009	*YES	8/01/05	8/31/05	*HOME	*NONE	QIC4GB	

Bottom

Parameters or command:

====>

F3=Exit F4=Prompt F5=Refresh F11=Volume system F12=Cancel F17=Top
F18=Bottom F23=More options

```

Work with Media Information                                RCHAS400

Position to Date . . . . .

Type options, press Enter.
 2=Change  4=Remove  5=Display  6=Work with media  7=Restore
 9=Work with saved objects  ...

  Saved      Save      Save      Save      Parallel  Volume      File      Expire
Opt Item    Date      Time      Type      Devices   Serial      Sequence  Date
5 TAPEFILXMP 8/01/05 14:48:24 *FILE      T00009      1          8/31/05
5 *LABEL    12/14/05 14:59:46 *FILE      TFIL01      1          *VER0035

F3=Exit  F5=Refresh  F11=Object detail  F12=Cancel  Bottom
F23=More options

```

The save type column in the screen above shows *FILE, being direct tape file I/O, rather than a normal save, which would show *FULL, *INCR, or *CUM.

```

Display Media Information

Save command . . . . . :
Saved item . . . . . : TAPEFILXMP
Save type . . . . . : *FILE
Save date. . . . . : 8/01/05
Save time. . . . . : 14:48:24
Device(s) . . . . . : TAP03

Move policy . . . . . : OFFSITE
Expiration date . . . . . : 8/31/05
Volume serial(s) . . . . . : T00009

Parallel devices . . . . . :
File sequence . . . . . : 1
Number of objects saved . . . . . : 0
Number of objects not saved . . . . . : 0
Saved size . . . . . : 0
Label . . . . . : TAPEFILXMP
Error message . . . . . :

More...

Press Enter to continue.

```

Other Processing Techniques

Issue the SETMEDBRM command before *any* command that performs tape I/O in addition to the example above in a program. You can use it with CPYTOTAP and CPYFRMTAP, as well as any native SAVLIB, SAVOBJ, RSTDLO, RSTUSRPRF commands. However, as you will note, SETMEDBRM will only record for media management purposes the status of the tape. You will not be able to use the BRMS functions (such as WRKMEDIBRM) to restore from this tape. It is always better to use the BRMS commands for save and restore operations for this reason.

Messages

No messages are written to the BRMS log when the tape is either written to or read in this manner.

Part 4. Appendixes

Appendix A. Merging BRMS Data and Consolidating Systems

The database files and objects in library QUSRBRM are critical to successful BRMS operations. These contain all the information about all the policies used by BRMS, all the saved history for all previous backups, and all the managed media. This chapter looks at how to merge BRMS data from one system to another system. For purposes of this chapter, the following definitions are used:

Donor

The iSeries server which is the source of the BRMS data to be merged.

Target

The iSeries server that receives the merged BRMS data.

BRMS data

The libraries and files used by the Backup Recovery and Media Services licensed product.

Merge

Taking BRMS data from a donor system and adding it to the current BRMS data on a target system.

Merge Consolidation Planning

Before merging BRMS data consideration must be given to the following:

DASD utilization

BRMS data can use a fair amount of DASD when object level detail is saved as part of your backup strategy. Ensure that the target system has sufficient free storage space. The more systems merged, the greater the DASD utilization.

Job scheduler entries

BRMS related job scheduler entries are not transferred during a merge or migration of BRMS data. You will need to create new job scheduler entries on the target system if required.

Backup window

Having a single system with data from multiple systems can increase the time to do backups. Users should be aware that their backup routines may contain additional processes after merging BRMS data.

BRMS maintenance

Running BRMS maintenance take longer to run after the merge is completed if more data is involved.

Different time zones

If a donor system is in an earlier time zone than the target system, do not merge BRMS data onto the target system until the time the data was saved on the donor system has been reached. This prevents the possibility of overwriting current data on the target system.

Primary and secondary languages

BRMS data is not affected by different language codes, however it is possible that menus and reports generated within BRMS are of another language on the target system.

Auxiliary storage pools

If your donor system has more basic user auxiliary storage pools (ASPs) than the target system, be aware that BRMS has created a library for save file backups for each ASP. The libraries are named Q1ABRMSFnn, where nn is the auxiliary storage pool identifier. Make sure the Q1ABRMSFnn library that resides in an ASP that does not exist on the target system, is empty before the merge.

Note: Never restore Q1ABRMSFnn libraries to a target system where the library already exists. Restore only the objects within the library.

Spooled files

If spooled files are required from a donor system, save the spooled files on the donor system and then restore the saved spooled files to the target system. This can be done using a spool list. Create and run a backup control group containing the QALLSPLF spooled file list to back up all spooled files on the donor system or use the Work with Lists using BRM (WRKLB RM) command to create a spooled file list specifying the spooled files you want to back up.

Coexistence with other systems

If the donor system is a server, point the clients to the target system if it is to be the new server.

Same or backward releases

Merging from a higher release of BRMS to a lower release is not supported by BRMS.

Multiple systems

Do not attempt to merge multiple donor systems to a system at the same time. If multiple systems are to be merged into one or more systems, merge one system at a time.

Merging BRMS data

This section lists considerations to resolve prior to merging BRMS data. Although the following points are of importance, the user must use their own discretion as to whether any action is taken prior to the merge.

Policies in BRMS

Review all BRMS policies prior the to merge and note similarities between the donor and the target systems. Consider printing and comparing the policies of both systems. Only non-unique policies will be merged and only if all references objects exist. Delete any unused policies and rename redundant policies.

Note: The System Policy, Backup Policy, Archive Policy, Recovery Policy, Retrieve Policy and Migration Policy are never merged.

Omit lists

Compare omit lists between the donor and target systems to determine whether omitted items and the lists are still valid for the target system. Delete any unused list and rename redundant lists.

Prerequisites for merging BRMS data

This section provides a listing of prerequisites for merging BRMS data. This listing is important when considering BRMS data merge, and should be followed carefully for a successful merge. To prepare and plan for a successful consolidation, read the entire chapter before starting any BRMS data merge.

Compatible media types

Drives on the target system should be compatible with media coming from the donor system.

Print the backup plan prior to merging

Print the current backup plan for BRMS on the donor system and target systems. The report (QP1ABP) can be printed using the following command:

```
DSPBKUBRM OUTPUT(*PRINT)
```

This report lists all backup control groups on the systems and can be used to compare backup control group entries.

Review the archive groups, migration groups and lists on the display. No print option is currently available.

Media Storage Extensions (MSE 5722SS1, option 18)

Install Media Storage Extensions on the target system. Be aware of any other backup applications which may use MSE.

Network donor systems

Remove donor systems from the BRMS network. Refer to “Removing a System From a Network” on page 255.

Use BRMS to perform a full system backup of all systems

It is advised that full system backups are processed prior to any system change.

No activity on any BRMS system

To ensure a successful BRMS data merge, cease all activity on any networked BRMS system.

Merge BRMS data to Target System with no BRMS

This section describes the steps to move BRMS from donor system to a target system. At this point, the target system does not have BRMS installed. The merge operation basically consists of moving the BRMS data from the donor system to the target system and then installing the BRMS licensed program. The merge steps are:

- Ensure all prerequisites for merging BRMS data are met.
- *On the donor system:*
 1. Verify you are signed on with a user profile with *SECOFR authority.
 2. If donor system is part of a BRMS network group, use the following command to display the active records for this system in the

```
DSPPFM FILE(QUSRBRM/QA1ANET)
```

Verify the QUSRBRM/QA1ANET file is empty as shown in the Display Physical File Member panel below.

```
Display Physical File Member
File . . . . . : QA1ANET          Library . . . . . : QUSRBRM
Member . . . . . : QA1ANET
```

```
*...+...1...+...2...+...3...+...4...+...5...+...6...+...7
```

```
(Selected member contains no records)
```

This indicates that donor has no data to send across the current network. Should the QA1ANET file not be empty, refer to “Checking BRMS Network Synchronization” on page 254.

3. QUSRBRM and Q1ABRMSF* libraries on donor system using the command:

```
SAVLIB LIB(QUSRBRM Q1ABRMSF*) DEV(tape_device)
```

- *On the target system:*
 1. Verify you are signed on with a user profile with *SECOFR authority.

2. Restore QUSRBRM and Q1ABRMSF* libraries on the target system using the command:

```
RSTLIB LIB(QUSRBRM Q1ABRMSF*) DEV(tape_device)
ALWOBJDIF(*ALL) MBROPT(*ALL)
```
3. Hold the users batch job queue.
4. Install BRMS as outlined in “Installing BRMS” on page 12.
5. Load and apply all relevant PTFs.
6. Release the users batch job queue to allow the post installation product initialization to complete.
7. If the target system has a different local location name, network ID, or system name than donor, transfer ownership of all BRMS data to the target system using the command:

```
INZBRM OPTION(*CHGSYSNAM)
PRVSYSNAM(network-id.donor-system-name)
NEWSYSNAM(*LCL)
```

Merge BRMS data to Target System with Existing BRMS

This section describes the steps to move BRMS from donor system to a target system when the target system has BRMS installed. BRMS is running backup policies on the target system so there exists on this system history and media information owned by the target system. The merge operation basically consists of combining the BRMS data from the donor system with the BRMS data on the target system. Since BRMS is already installed on the target system, no installation of BRMS is required. The merge steps are:

- Ensure all prerequisites for merging BRMS data are met.
- Review the printed outputs of the data you intend to merge to assure there are no duplicates. Only unique BRMS objects and information will be merged.
- *On the donor system:*
 1. Verify you are signed on with a user profile with *SECOFR authority.
 2. If donor system is part of a BRMS network group, use the following command to display the active records for this system in the

```
DSPPFM FILE(QUSRBRM/QA1ANET)
```

Verify the QUSRBRM/QA1ANET file is empty as shown in the Display Physical File Member panel below.

```

Display Physical File Member
File . . . . . : QA1ANET          Library . . . . . : QUSRBRM
Member . . . . . : QA1ANET

*...+...1...+...2...+...3...+...4...+...5...+...6...+...7

(Selected member contains no records)
```

This indicates that donor has no data to send across the current network. Should the QA1ANET file not be empty, refer to “Checking BRMS Network Synchronization” on page 254

3. If you want to differentiate the save history of the donor system from that of the target system, you can update the history records with a unique control group using the following SQL command:

```
UPDATE QUSRBRM/QA1AHS
SET BKHGRP='new-control-group-name'
WHERE BKHGRP='old-control-group-name'
```

This step is optional and may not even be necessary if the saves on the donor system were performed using control groups which do not exist on the target system. Once you have completed the rename and merge the data to the target system, you will be able to view these older saves using the following command:

```
WRKMEDIBRM CTLGRP(new-control-group-name)
```

4. Save the QUSRBRM and Q1ABRMSF* libraries on donor system using the command:

```
SAVLIB LIB(QUSRBRM Q1ABRMSF*) DEV(tape_device)
```

Note: You do not need to save the Q1ABRMSF* libraries if you do not intend to merge the save history of the donor system to the target system.

- *On the target system:*

1. Verify you are signed on with a user profile with *SECOFR authority.
2. Save the QUSRBRM and Q1ABRMSF* libraries on target system using the command:

```
SAVLIB LIB(QUSRBRM Q1ABRMSF*) DEV(tape_device)
```

The save of these libraries will protect you in the event you need to back off the merge.

3. If you intend to merge the save history of the donor system to the target system then use the following command to restore the save files in the Q1ABRMSF* libraries to the target system.

```
RSTOBJ OBJ(*ALL) LIB(Q1ABRMSF*) DEV(tape_device)  
ALWOBJDIF(*ALL) MBROPT(*ALL)
```

4. Restore the QUSRBRM library from the donor system to a temporary library on the target system using the following command.

```
RSTLIB LIB(QUSRBRM) DEV(tape_device) RSTLIB(temp-library-name)  
ALWOBJDIF(*ALL) MBROPT(*ALL)
```

Note: Do not restore the QUSRBRM library from the donor system to the QUSRBRM library on the target system.

5. Merge the BRMS data from the temporary library to QUSRBRM on the target system using the following command:

```
INZBRM OPTION(*MERGE) FROMLIB(temp-library-name)  
TOLIB(QUSRBRM) MERGE(merge-options)
```

where merge options specifies the types of BRMS data to be merged.

Note: Because of the extensive file processing involved in the merge operation, this could be a long running process depending on the merge options you select and the size of the merged files.

6. Review the job log or the BRMS log for messages related to the merge processing. Verify the merge completed successfully. Assure that objects not merge are not required. Messages generated by the merge process include the following:

BRM13B0 C

Merge started for file &2 in library &3.

BRM13B1 C

Merge ended for file &2 in library &3.

BRM13C1 I

Archive control group &2 added.

BRM13C2 I

Archive list &2 of type &3 added.

BRM13C3 I

Backup control group &2 added.

BRM13C4 I

Backup list &2 of type &3 added.

BRM13C5 I

Migration control group &2 added.

- BRM13C6 I**
Device &2 added.
- BRM13C7 I**
Connection name &2 added.
- BRM13C8 I**
Storage location &2 added.
- BRM13C9 I**
Media class &2 added.
- BRM13CA I**
Move policy &2 added.
- BRM13CB I**
Media policy &2 added.
- BRM13CC I**
Container class &2 added.
- BRM13CD I**
Container &2 added.
- BRM13CE I**
ASP class &2 added.
- BRM13CF I**
Volume &2 added.
- BRM13D1 I**
Archive control group &2 not added. Reason &5.
- BRM13D2 I**
Archive list &2 of type &3 not added. Reason &5.
- BRM13D3 I**
Backup control group &2 not added. Reason &5.
- BRM13D4 I**
Backup list &2 of type &3 not added. Reason &5.
- BRM13D5 I**
Migration control group &2 not added. Reason &5.
- BRM13D6 I**
Device &2 not added. Reason &5.
- BRM13D7 I**
Connection name &2 not added. Reason &5.
- BRM13D8 I**
Storage location &2 not added. Reason &5.
- BRM13D9 I**
Media class &2 not added. Reason &5.
- BRM13DA I**
Move policy &2 not added. Reason &5.
- BRM13DB I**
Media policy &2 not added. Reason &5.
- BRM13DC I**
Container class &2 not added. Reason &5.

BRM13DD I

Container &2 not added. Reason &5.

BRM13DE I

ASP class &2 not added. Reason &5.

BRM13DF I

Volume &2 not added. Reason &5.

BRM13F0 D

Volume &2 not updated. Reason &5.

BRM13FE D

File &2 not merged. Reason &5

BRM13FF E

Merge operation not successful. Reason &5.

7. Verify the merged policies by editing or changing the policy using the standard BRMS interfaces. Resolve any errors that may occur during the validation processing.
8. If the target system has a different local location name, network ID, or system name than the donor system and you want to consider the saved history and media as now owned by the current system, transfer ownership of the merged BRMS data to the target system using the command:

```
INZBRM OPTION(*CHGSYSNAM) PRVSYSNAM(network-id.donor-system-name)
NEWSYSNAM(*LCL)
```

Appendix B. A Summary of BRMS Reports

Following is a list of all the reports that are available in BRMS. This list provides the title of each report, the command or commands that you can use to generate the report, and the associated printer file. The list includes source information (QUSRBRM/QA1ASRC) for printer files for the three Print Label reports, which you can change as necessary.

The following pages summarize each report itemized in the list. To see the actual layout of these reports, go to the Reports menu (GO BRMRPT), from which you can process any of these reports. The parenthesized name (QP1Axxxx) in the section titles are the names of the printer files which contain the final reports.

ASP Information Report (QP1AASP, QP1AXS)

The ASP Information report provides a summary of all auxiliary storage pools (ASPs) that are set up and various statistical information detail about the ASP's on your system. This report is printed as a result of running the command `WRKASPBRM OUTPUT(*PRINT)`

The ASP Information report is also produced as part of the maintenance (STRMNTBRM) activity or by running the STRRCYBRM command. In these cases, the printer file is named QP1AASP.

Backup Folder List Report (QP1AFL)

The Backup Folder List report lists all the folders in a backup list. This report is printed as a result of running the command `WRKLBRM TYPE(*BKU) OUTPUT(*PRINT)`.

Backup Link List Report (QP1AFS)

The Backup Link List report lists all the directories in a backup list. Print the report by running the command `WRKLBRM TYPE(*BKU) OUTPUT(*PRINT)` or by selecting Option 6 (Print) on the Work with Lists display for an integrated file system list.

Backup Object List Report (QP1AOB)

The Backup Object List report lists all the objects in a backup list. This report is printed as a result of running the command `WRKLBRM TYPE(*BKU) OUTPUT(*PRINT)`.

Backup Plan Report (QP1ABP)

The Backup Plan report lists all control groups and the entries that make up each control group. Run the report by selecting Option 3 (Print backup plan) on the Backup Planning menu (BRMBKUPLN) or use the `DSPBKUBRM OUTPUT(*PRINT)` command.

Backup Policy Report (QP1ABX)

The Backup Policy report lists the attributes defined for the Backup Policy. Print the report by running the command `WRKPCYBRM TYPE(*BKU) OUTPUT(*PRINT)`. Also included in this report are the attributes defined for the following:

- Libraries to Omit from Backups

Backup Spooled File List Report (QP1ALQ)

Running the WRKLB RM TYPE(*BKU) OUTPUT(*PRINT) produces the Backup Spooled File List report. This report lists all the spooled files in any list of spooled files that you have set up. This report lists each list item, the sequence number, and the selection criteria.

Calendar Report (QP1ACA)

Run the WRKCALBRM OUTPUT(*PRINT) command to produce the Calendar report. Calendars are user-defined grouping of days. You can define the working days of a year for a company, the days of the week that media movement is allowed, or exception days such as a holiday where normal activity does not take place. The Calendar Report lists all calendars that you have set up in BRMS, any reference calendars that you are using and the dates that you have set up for the calendar.

Note: Calendar names can be up to 10 characters in length and adhere to iSeries naming conventions.

Centralized Media Audit Report (QP1ASYN)

The Centralized Media Audit report is produced when you process the STRMNTBRM command and the system is in a BRMS network (the Network Feature is installed and configured). The report is not produced when you are in a single system environment. You should understand why you find errors and what updates BRMS has made to correct them.

The report indicates both the from system and the to system that you are auditing. The report will indicate for each volume whether the volume was found on the network system and if so was either system updated with information from the other system.

The following should be noted about this report:

- Volumes that are found in error or that were updated are listed by volume. Volumes that had neither condition are not listed.
- *Total volumes checked* is the number of volumes across all systems in the BRMS network.
- *Volumes in error* is the number of volumes that the audit has found to be in error. Volume entries that are found to be different between systems can cause errors. An example of a difference is a volume that is shown to exist on one system but not on another.
- *Volumes updated* is the number of BRMS volumes which have been changed as a result of the audit. For instance, volume entries can have a different internal time stamp. These volumes will be changed with the most recent update that is applied to the older entries.

Note: If you cannot reconcile the information that is provided in the report, contact level 2 IBM support.

Container Report (QP1ACN)

Running the WRKCNBRM OUTPUT(*PRINT) command or selecting option 6 from the BRMPRTINV menu produces the Container report. Select entries that are based on the following:

- Class
- Status
- Location

The following should be noted about this report:

- *OPEN indicates that the container status is open which allows you to add volumes to the container.
- *CLOSED indicates that the container is closed and no further volumes can be added.

- Expiration date indicates the oldest expiration date of any media volume in the container. A container can contain volumes that have the same expiration date or different expiration dates. The expiration date depends on the value in the *Different expiration date* parameter for the container class specified in Work with Container Classes display.
- Date indicates the expiration date in system date format.
- *NONE indicates that you did not assign an expiration date to the container.
- *PERM indicates that you assigned the container to a permanent retention.

Container Class Report (QP1ACT)

The Container Class report lists all container classes that are specified to BRMS. This report is produced as a result of running the command `WRKCLSBRM TYPE(*CNR) OUTPUT(*PRINT)`. Choosing option 7 from the BRMPRTINV menu can also print the report.

The following should be noted about this report:

- *Allow mixed dates* field can contain either *NO or *YES. *NO specifies that the container can contain only media volumes that have the same expiration dates. The container expiration date is the same as the expiration date of the media volumes in the container. *YES indicates that a container in this class can contain media volumes that have different expiration dates. The container assumes the expiration date of the media volume that expires last among all the volumes in the container.
- The *Unpack* field indicates whether or not this container class is automatically unpacked when volumes in the container expire or expired volumes must be manually unpacked.

If a container is automatically unpacked when media expires in the container, the association between the expired media volume serial and the container is removed. You can use the media and assign the media to another container. Likewise, you can assign the container to other volumes.

If the volume is not automatically unpacked, the relationship between expired volumes and the container that the volumes are in is left intact in the media library. The volumes are still assigned to the container, even though the volumes are expired. They will remain assigned until you manually remove them from the container.

- *Capacity* is measured in the number of media volumes that this container class can hold.
- The *Media class* field indicates the name of the media class that can be stored in this container class. You can have from one to four media classes assigned to a container class.

Device Report (QP1ADV)

The Device report provides a basic list of all tape devices defined to BRMS. This report is produced as a result of running the `WRKDEVBRM OUTPUT(*PRINT)` command. Choose the interactive version of the command to view additional detail. The *Transfer rate per second* field shows the rate which the media device transfers data to and from the storage media. *DEVTYPE indicates that you use the default transfer rate of the selected device.

Library Backup Analysis Report (QP1ALA)

The Library Backup Analysis report shows an analysis of libraries that you have backed up as well as those that you did not back up. The size of the library and the number of objects is listed for each library. The reports are produced using the ANZLIBBRM command. However, you must have first run the RTVDSKINF command. The RTVDSKINF command create files that ANZLIBBRM uses to analyze your libraries. The RTVDSKINF command defaults to an analysis of the system (1) and basic user(2-32) auxiliary storage pools. You must specify the ASPDEV parameter to initiate an analysis of any available auxiliary storage pool devices. The ANZLIBBRM will generate report QP1ALA for the system and basic user auxiliary storage pools, and report QP1ALA0nnn for each available auxiliary storage pool device, where nnn is the auxiliary storage pool number.

The following should be noted about this report:

- The capacity and transfer rate values are determined from the *Media class* and *Device name* that are specified in the system policy.
- The *Estimated volumes* column represents an approximation of the number of volumes that are required to back up a specified library.
- The *Estimated minutes* column specifies an approximation of the number of minutes that are required to back up a specified library.
- The *Control group* column specifies the control group of which the library is a member.

Link Information Report (QP1ADI)

The Link Information report is produced using the WRKLNKBRM OUTPUT(*PRINT) command. This report summarizes all directories, objects, and object types that have been saved and have media content available in BRMS. The report starts at the highest level of the path and continues through each extension of the path.

The following should be noted about this report:

1. In this example the file system root directory "/" is the first information detailed on the report.
2. Information about each saved directory is included such as save list, date and time of save and so on. Obtain this information plus additional detail by using the Option 5 (Display) on the Work with Directory Information.
3. After the root directory information is reported, each extension of the pattern is reported. For instance, the path /QIBM follows the "/" root directory.

Location Analysis Report (QP1A2SL)

The Location Analysis report shows a list of all locations that are specified to BRMS, together with details of the current and maximum volumes and containers at each location. This report is produced as part of running the STRMNTBRM command.

Log Report (QP1ALG)

The BRMS Log report shows activities that are processed through BRMS commands. This report is produced as part of running the DSPLOGBRM OUTPUT(*PRINT) command. Additional parameters on the DSPLOGBRM command allow you to filter the type and number of entries returned in the report.

You can base your filters on the following:

Date Select to and from dates

Severity

Select lowest severity code for messages to be printed

Type *ALL selects all activities

*ARC selects only archive activities.

*BKU selects only backup activities.

*MED selects only media activities.

*MGR selects only migration activities.

*RCY selects only recovery activities.

*MAINT selects only maintenance activities.

*RTV selects only retrieve activities.

*SEC selects only security log activities

Media Report (QP1AMM)

The Media report by Volume Serial is the result of running the maintenance command (STRMNTBRM) or the WRKMEDBRM OUTPUT(*PRINT) SORT (*VOL) command. Choosing options 1, 2, 3, or 4 from the BRMPRTINV menu can also produce the report, depending on selection criteria or sequence required.

The purpose of the report is to summarize status and location information for selected or all volumes in the media library.

The following should be noted about this report:

- You can create this report in volume, with creation or expiration date sequence by using the WRKMEDBRM command.
 - The WRKMEDBRM command provides multiple parameters to select volumes to include in the report. The selection criteria for the report are listed first, including the creation and expiration date ranges.
 - The *Volume list* field indicates whether all volumes in the inventory are included (*NO) or whether specific volumes requested in a list (*YES) are printed.
 - Note that some volumes can have dates earlier than the current date but have not expired. This could be because you have not run the STRMNTBRM command recently, or the volume is part of volume set with a later expiration, or because these volumes cannot expire in a remote location.
 - A summary shows the number of active, expired and the total number of volumes in the inventory.
 - The *System ID* field shows the system which wrote the **first** file to the tape. **Do not use a tape for active files from more than one system.**
-

Media Class Report (QP1AMT)

The Media Class report shows basic information for each media class that is defined to BRMS. You produce the report by running the command WRKCLSBRM TYPE(*MED) OUTPUT(*PRINT) or by choosing option 5 from the BRMPRTINV menu. Choosing the interactive version of the command can display additional information.

The following should be noted about this report:

- *Label print* shows when labels will be printed. This can be:
 - *NONE - labels are not printed
 - *MOVE - labels are printed when the MOVMEDBRM command processes media volumes that belong to this media class.
 - *WRITE - labels are printed for any tape that belongs to this media class any time a write operation occurs.
 - *Label size* indicates the size of the tape labels.
-

Media Expiration Report (QP1AEP)

Running the maintenance command (STRMNTBRM) or specifically expiring media (STREXPBRM command) produces the Media Expiration report. This report shows the media that has expired as a result of that particular run. This report also indicates the total number of volumes in the inventory which are expired.

Note: If the ACTFILCNT parameter is 0, and you specify *REPORT in the ACTION parameter, BRMS produces a report and expires media with 0 active files. If the ACTFILCNT parameter is greater than 0, only a report is produced.

The following should be noted about this report:

- The *System* field indicates the system name which wrote the first file to the tape.
- The *User* field indicates the user who owned the job that wrote the first file to the tape.
- The *Total expired count* field indicates the total number of volumes in the inventory which are expired.
- The *Use count* field indicates the number of times the volume has been used.

Media Information Report (QP1AHS)

The Media Information report shows a history of what has been backed up by BRMS. This report is printed as a result of processing the WRKMEDIBRM OUTPUT(*PRINT) command or as part of the STRMNTBRM maintenance job.

The following should be noted about this report:

- The *Expiration date* field indicates when the item will expire. For instance, an expiration date of 5/15/95 indicates that the save item will expire no sooner than 12:01 A.M. on 5/16/95.
- The *Objects saved* field indicates the total number of objects that are saved as a result of this save operation.
- The *Not saved* field indicates the number of objects that you were not able to save. You cannot save objects that are locked at the time the save operation takes place.
- The *Type save* field indicates the type of save that was specified for this save item. For instance:
 - *INCR indicates that the save was an incremental (save changed objects),
 - *CUMML indicates that the save was an incremental save (cumulative save changed objects),
 - *FULL indicates that the save was of the entire library,
 - *RCY indicates that BRMS was saved when processing a control group,
 - *ARC indicates that the media information was the result of an archive operation.

You can sequence the report using the following:

- Save Date
- Library Name
- Volume Serial Number

Media Library Report (QP1AMD)

The Media Library report lists the MLB devices that are defined to BRMS. This report is produced as a result of running the WRKMLBBRM OUTPUT(*PRINT) command.

The following should be noted about this report:

- The *Library* field indicates the name of the MLB.
- The *Status* field indicates the status of the Media Library. *Released* indicates that the media library can be used in media operations. *Held* indicates that the media library device cannot be used in media operations.
- The *Location* field indicates the location of the MLB. There is a one to one correspondence between location and device name. You cannot assign another device the same location as the MLB.

Media Library Media Report (QP1A1MD)

The Media Library Media report lists the volumes that are resident in the MLB. Running the WRKMLMBRM OUTPUT(*PRINT) produces this the report. You may choose to display all media in the MLB, only those volumes that are registered in BRMS or both.

The following should be noted about this report:

- The *Category* field indicates the category of the volume in the MLB.

- *SHARE400 indicates that an iSeries can only use the media.
- *NOSHARE indicates that the media has a value of *YES in the *Shared media* parameter in its associated media class.
- *INSERT indicates that the media is in the "insert" mode in the MLB. You must change the media to another category before you can use it in MLB operations.
- *EJECT indicates that the media is in the "eject" mode in the MLB.
- *IPL indicates that you can use the media for an alternate IPL.
- *NL indicates that you can use the media as a non-labeled tape.
- *CNV indicates that the media is convenience station media.
- *SYSGEN indicates that the media is *SYSTGEN media
- Category-name indicates that the media is in a user-defined category.

Media Merge Report (QP1AEN)

The Media Merge report lists the volumes that are merged together as a result of running the Copy Media Information using BRM (CPYMEDIBRM) command. All media entries that are not duplicates will be added to the network media inventory on the system that you are adding. You will receive messages when there are differences that need to be resolved.

Media Movement Report (QP1APVMS)

The PRTMOVBRM command produces the Media Movement report. The Media Movement report shows all volumes that are scheduled to move from one location to another location. The report page breaks for each from/to combination. The MOVMEDBRM command actually performs the media movement.

The following should be noted about this report:

- The *To slot* field indicates where the volume is placed at the "to location".
- A Move policy of *NONE implies that these volumes were moved manually. Use Option 8 (Move) on the Work with Media display to accomplish this.
- The *Container slot* field indicates where the container is placed in the "to location".
- A *From slot* field indicates where the volume was placed at the "from location".
- An *Expiration* date of *VERnnn indicates that this volume is using version control.

Check the Media Movement report for every movement of media or containers. You can use it as a control document when moving media by an outside agency.

Media Policy Report (QP1AME)

The Media Policy report lists all the media policies defined to BRMS and the associated attributes defined for each policy. Print the report by running the command WRKPCYBRM TYPE(*MED) OUTPUT(*PRINT).

Media Volume Statistics Report (QP1AVU)

The Media Volume Statistics report is produced when you run the command PRTMEDBRM TYPE(*STATISTICS). You can use it periodically to check the usage of your media and identify if any volumes are being used excessively when compared to others.

The following should be noted about this report:

- The "*" to the right of the *Expiration date* field indicates that the volume has expired.

- The *Uses* field shows the number of times to which a media volume has been read from or written. When the volume exceeds the Usage threshold value for media in its media class, you should take it out of service and replace it with a newer volume. You can review the Usage threshold value in the Work with Media Classes display.

The following fields are the sizes of the disk files that were written to or read from tape. You should use these as an approximation as they do not reflect any data compression or compaction that may have been performed.

- The *Bytes read* indicates the number of bytes that are read from the volume since its creation date.
- The *Bytes written* field indicates the number of bytes that are currently written on the media volume.
- The *Current bytes written* field indicates the number of bytes that are currently written on the media volume.
- The *Maximum bytes on volume* field indicates the maximum number of bytes that you have written to this tape.

Media Volume Threshold Report (QP1AVOL)

Use the PRTMEDBRM TYPE(*THRESHOLD) command to produce the Media Volume Threshold report. The Media Volume Threshold report compares actual volume threshold information against standard threshold information to alert you to any potential errors in your media. Each media class is evaluated separately with summary statistics at the end of each report. You have the option of printing only exceptions, or all volumes with exceptions.

The following should be noted about this report:

- Read, write and usage error thresholds are numbers that you should obtain from media manufacturers. The thresholds will vary widely between media classes.
- BRMS also keeps the last cleaning date (as specified to BRMS by option 12 on the Work with Media BRM display) and the number of uses since the volume was cleaned.
- The "*" to the right of the *Expiration date* field indicates that the volume has expired.
- The *Exception detail* field indicates the type of (if any) exception which has occurred. These are listed below the listed volumes for the media class. Possible values are:
 - *1 - No media class found for volume.
 - *2 - Media has exceeded use count.
 - *3 - Read error threshold has been exceeded.
 - *4 - Write error has been exceeded.
 - *5 - Volume has exceeded clean usage threshold.
 - *6 - Reorder point has been reached for this class.

Move Policy Report (QP1AMP)

The command WRKPCYBRM (*MOV) produces the Move Policy report. This report shows the move sequences and associated values for each move policy defined to BRMS.

Recovery Activities Report (QP1ARW)

The Recovery Activities report is printed as part of the maintenance run (STRMNTBRM) if you select *YES and the *RCYANL choice for the PRTRCYRPT parameter. The report can also be printed using the WRKRKYBRM OUTPUT(*PRINT) command. Activities may range from a full system recovery, including actions to take for implementing a full mobile recovery service, to those activities necessary to recover a failed application.

The following should be noted about this report:

- *Sequence* is a number between 1 and 999. This report is used to sequence the activities on the report, but need not be a unique number.
- *Activity* is a brief description of the recovery activity to perform.
- *Text* describes the activity. You should make this as meaningful as possible.
- These fields describe the people who may need to be contacted in order to perform the activity. You can display up to five contacts.
- *Recovery information* is a free format area of text to describe in detail the activity to be performed.

Recovery Analysis Report (QP1ARCY)

Use the Recovery Analysis report to restore all or parts of the software on your system. Run either the STRRCYBRM or STRMNTBRM commands to produce this report. The report is broken into multiple steps, with instructions and associated media volumes where applicable for each step. Chapter 4 of this book covers each of the areas in more detail.

Notes:

1. When doing an *SAVSYS, the number of objects will show as 0 since the licensed internal code is not comprised of i5/OS objects.
2. If recovering to a different system you should specify *ALL in the *Allow object differences* field and *NONE in the *System resource management* field.

Recovery Policy Report (QP1ARX)

The Recovery Policy report lists the attributes defined for the Recovery Policy. Print the report by running the command WRKPCYBRM TYPE(*RCY) OUTPUT(*PRINT).

Recovery Volume Summary Report (QP1A2RCY)

The Recovery Volume Summary report is produced as part of the maintenance (STRMNTBRM) activity or by running the STRRCYBRM command. The report provides a list of all tape volumes that are required to complete a full system recovery to the latest backup point. The report also lists all duplicate volumes for the volumes that are required for recovery. Use this report in conjunction with the Recovery Analysis report to locate all tapes or duplicate tapes that are required for recovery. Slot information is included (where used) to allow easy retrieval of the tapes.

The following should be noted about this report:

- The total number of volumes that are required for a complete system recovery is shown as a final summary.

Save Files Report (QP1ASF)

The BRM Save Files report lists all save files in the BRMS media content information. This report shows all libraries which have been saved to save files and have not yet had media content information deleted. The report is produced as a result of running the WRKSAVFBRM OUTPUT(*PRINT) command.

The following should be noted about this report:

- The name of the *Save file* is based on a date/time stamp. These save files were created when BRMS performed save or archive activity with a media policy which specified to save to a save file. Save files created outside BRMS (CRTSAVF) are **not** listed.
- The last 2 digits of the *Save file library* name reflect the ASP in which the save file was created.

Save Strategy Exceptions Report (QP1ALE)

The Save Strategy Exceptions report lists libraries that have not been saved by a BRMS control group. You can run the Media Information report by using the WRKMEDIBRM SAVTYPE(*NONE) OUTPUT(*PRINT) command which scans the media information for libraries that have not been backed up. The library name, description of the library (if any), and the total number of libraries are listed in the Save Strategy Exceptions report.

If a control group exists which includes special values such as *ALLUSR, a new user library is still listed in this report if it has not previously been saved. Once it has been saved, it will not appear on the Saved Strategies Exceptions report.

You can also use the STRMNTBRM command and specify *ALL or *SAVEXCP for the PRTRCYRPT parameter to produce the Save Strategy Exceptions report.

Saved Folders Report (QP1AFD)

The Saved Folders report lists all folders and sub-folders which have been saved by BRMS. The WRKFLRBRM OUTPUT(*PRINT) command produces this report. You can sequence the report in *Save date* or *Folder name* order.

You can select folders to appear in the report that is based on all the fields that are shown below in the report except *Volumes*.

Saved Objects Report (QP1AOD)

Running the WRKOBJBRM OUTPUT(*PRINT) command produces the Saved Objects report. This report lists all objects that are saved by BRMS with *Retain object detail* *YES, *OBJ, or *MBR. You can sequence the report by *Save date*, *Object name*, or *Library*.

Saved Spooled Files by Date Report (QP1AOQ)

Running the WRKSPLFBRM OUTPUT(*PRINT) command produces the Saved Spooled Files by Date report. This report lists all saved spooled files that are saved by BRMS. You can also sequence the report by *Job* or *File name*.

Storage Location Report (QP1ASL)

The Storage Location report is produced as a result of processing the WRKLOCBRM OUTPUT(*PRINT). The report displays all the storage locations that you have set up for your system and the current contents and maximums that you have set up.

The following should be noted about this report:

- The *Retrieval time in hours* field indicates how long it takes to move media from this location to the home location.
- The *Threshold number* fields for both containers and volumes indicate the current thresholds at this location. The threshold is the number of volumes or containers, that if equaled or exceeded, causes BRMS to issue a warning that the storage location's threshold is being approached.
- *Allow expire* indicates whether volumes are allowed to expire in this location. Volumes should always be allowed to expire at the home location.

System Policy Report (QP1ASP)

The System Policy report lists the attributes defined for the System Policy. Print the report by running the command `WRKPCYBRM TYPE(*SYS) OUTPUT(*PRINT)`. Also included in this report are the attributes defined for the following:

- Signoff Exceptions
- Subsystems to Check before IPL
- Presentation Controls
- Notification Controls
- IPL Controls

TSM Performance Analysis Report (QP1ATSMRPT)

The TSM performance analysis report lists and summarizes recent data transfer activity for save and restore operations with a Tivoli Storage Manager (TSM) server. You can print this report using option 53 from the GO BRMRPT menu. The report summarizes TSM data transfer activity recorded in file `'/tmp/brms/tsmapis'`. The default action is to create a report using all available records. You can create a report using records filtered by date, job number, job user and minimum number of blocks in the data transfers.

The following should be noted about this report:

- The *Entry* field identifies the current TSM data transfer entry.
- The *Job* field indicates the job that initiated the entry.
- The *Job user* field indicates the job user that initiated the entry.
- The *Date* field indicates the date the entry was started.
- The *Time* field indicates the time the entry was started.
- The *Number blocks* field indicates the number of blocks (transfer requests) included in the analysis for the entry.
- The *Average block size* field indicates the average length of each block transferred for the entry.
- The *Average block time* field indicates the average time required to transfer each block for the entry.
- The *Fastest block time* field indicates the fastest (shortest) time required to transfer a block for the entry.
- The *Slowest block time* field indicates the slowest (longest) time required to transfer a block for the entry.
- The *Byte save rate* field indicates the calculated instantaneous rate which the operating system and BRMS collect save data for this entry.
- The *Byte send rate* field indicates the calculated instantaneous rate which TSM sends data across the network to the TSM server for this entry.
- The *Byte restore rate* field indicates the calculated instantaneous rate which the operating system and BRMS restore data for this entry.
- The *Byte receiver rate* field indicates the calculated instantaneous rate which TSM receives data across the network from the TSM server for this entry.

Version Control Report (QP1AVER)

The Version Control report is produced as a result of processing the STRMNTBRM command. The report displays those volumes under version control for each control group.

The following should be noted about this report:

- The *Seq* field indicates the version of the save for the control group. The most recent is shown as 1.
- The *Retain* field indicates the number of versions that will be kept for the control group.
- The *Type* field indicates the type of data that was saved. Valid values are

- *LSTF - full save of object list
- *LSTI - incremental save of object list
- *LSTC - cumulative incremental save of object list
- *FULL - full save
- *INCR - incremental save
- *CUML - cumulative incremental save
- *QBRM - recovery data
- *ARCH - archive data

Volume Movement Report (QP1AVMS)

Running the MOVMEDBRM command produces the Volume Movement report. The Volume Movement report shows all volumes that were moved or not moved from one location to another location. The report shows the current location, when the volume moved to the current location, the date and location of the next move, and the current move policy controlling the volume movement.

If there are errors that are associated with a volume, an error code will be associated with that volume. The possible error codes are:

1. Error *1 No move policy or no move rules were found. Volume will move to default home location.
2. Error *2 Unable to assign a container for indicated volume.
3. Error *3 Location reached maximum number of volumes. Move operation bypassed.
4. Error *4 Location reached maximum number of containers. Move operation bypassed.
5. Error *5 Volume movement for this move policy was prevented by move calendar schedule.
6. Error *6 Reference calendar refers to a calendar previously defined.
7. Error *7 Volume marked for duplication.

Appendix C. APIs and Exit Programs

The following APIs and exit programs are provided for the user who wants to perform various utility functions while using BRMS. Each program and API are described in general and followed by detailed field descriptions and sizes.

Control Group Exit Program

Parameters:

Required Parameter Group:

1	Control group name	Input	Char(10)
2	Control group type	Input	Char(4)
3	Qualified user space name	Input	Char(20)
4	User space format	Input	Char(8)
5	Control information format	Output	Char(8)
6	Control information	Output	Char(*)

Exit Point Name:

None

Exit Point Format Name:

See "Control Group Entry Information" on page 336 for possible formats.

Use this exit to receive information about entries processed in control groups. You may want to use this exit to:

- Perform additional actions for processed entries.
- Review the messages generated by processed entries.
- Retry processed entries.
- Force termination of subsequent processing.

Information about processed control group entries is provided to the exit program in a user space. The specified exit program must be capable of receiving the required parameter group and retrieve the entry information provided in the user space. The exit program is called after an entry or group of entries is processed by the control group.

Messages generated while processing control group entries can be received by the exit program using the starting message key and ending message key fields provided in the entry information.

The exit program returns control information which indicates whether:

- subsequent calls to the exit program are ended
- processing should continue with the next subsequent entry in the control group
- whether the current entry is processed again
- control group operations are ended and how operations are to end.

The control group will terminate abnormally if the exit program returns an exception or invalid values for the control information.

Control Group Exit Program

Restrictions

- | The exit program should not call any BRMS commands or APIs using media operations or alters the current media retention attributes. Such activity could result in unpredictable behaviors.
- | The exit program must handle all exceptions from commands and programs it calls.
- | The exit program should remove only those overrides which it creates.
- | The exit program should remove only those messages created by commands and programs it calls.

Authorities and Locks

- | The exit program must have the necessary authorities to objects it uses.
- | All adopted authorities of the calling program will be dropped when the exit program is called.
- | The exit program must release locks it places on objects before returning to the caller.

Usage notes

- | The control group exit program is currently enabled only for backup control groups. To use this exit for backup control groups, specify an exit program name, library and format BKUI0100 on the *Backup item exit* prompt in the attributes for the backup control group you want enabled for backup item exit processing. Alternately, you can use one exit program for multiple backup control groups by specifying *BKUPCY for the *Backup item exit* prompt in these backup control groups, and specifying the exit program name, library and format BKUI0100 on the *Backup item exit* prompt of the *Backup Policy*.
- | Libraries in backup control groups may be grouped if the libraries have similar auxiliary storage pool, activity, object detail, and save while active attributes, and the grouping does not exceed 300 libraries.
- | The exit program is not called if there are no entries in the control group, or entries are skipped when restarting a control group (see the Starting sequence (STRSEQ) parameter on the Start Backup using BRM (STRBKUBRM) command).
- | The exit program is not called for *EXIT entries which have no command defined.
- | Program messages generated by the exit program are not removed from the job log.
- | Overrides created by the exit program are not removed until the control group processing ends.
- | All overrides are deleted and resources reclaimed for when the control group processing ends.
- | Control group processing continues normally if the exit program does not exist, but exception BRM10A1 is returned.
- | The existence of the exit program does not change the exception handling capabilities of the control group processing program.
- | Exit program processing time is additive to the control group processing time.

Required Parameter Group

- | **Control group name**
 - | INPUT; Char(10)
 - | This is the name of the control group calling the exit program.

Control group type

INPUT; Char(4)

This is the type of control group calling the exit program. Possible values are:

***BKU** This is a backup control group.

Qualified user space name

INPUT; Char(20)

This is qualified name of the user space containing the control group entry information. The format of the control group entry information is determined by the user space format.

User space format

INPUT; Char(8)

The name of the format of the control group entry information. This identifies the format of the control group entry information in the user space. Possible values are:

BKUI0100

Backup entry information. The control group entry information is provided for backup control group entries. For details see “BKUI0100–Backup Item Entry Information” on page 336.

Control information format

INPUT; Char(8)

The name of the format of the control information. This identifies the format of the control information returned by the exit program. Possible values are:

CTLO0100

Basic control information. Basic control information is returned by the exit program. For details see “CTLO0100– Basic Control Information.”

Control information

Output; Char(*)

The control information provides identifies the action which the exit program wants the caller to take relative to subsequent processing. For details see “Control Information.”

Control Information

The following defines the format of the control information returned by the exit program.

CTLO0100– Basic Control Information

The following table defines the format of the basic control information.

	Offset			
Dec	Hex		Type	Field
0		0	Binary(4)	Control group entry action

Control group entry action. The action the exit program wants the control group processing program to take relative to the current control group entries. Possible values are:

0 Continue processing entries but do not call exit program again.

1 Continue processing entries and call exit program after the next entry is processed.

2 Retry the current entry and call exit program after the entry is processed.

Note: The current entry will be retried for as many times as this value is returned in the control information. The exit program is responsible for preventing infinite loop conditions when this value is used repeatedly for the same group of entries.

14 End control group processing. Do not process subsequent entries. Perform control group post processing

Control Group Exit Program

which may include saving media information, starting subsystems, restarting the system, or other post processing operations as determined by the control group attributes.

- 15 End control group processing. Do not process subsequent entries. Do not perform control group post processing such as saving media information, starting subsystems, restarting the system, or other post processing operations.

Control Group Entry Information

The following defines the format of the control group entry information provided in the user space.

BKUI0100–Backup Item Entry Information

The following table defines the format for backup item entry information. This format is only valid for backup control groups.

Dec	Offset		Type	Field
	Hex			
0		0	Binary(4)	Number of entries
4		4	Binary(4)	Length of entry information
8		8	Binary(4)	Starting message key
12		C	Binary(4)	Ending message key
16		10	Binary(4)	Offset to first entry

The following fields repeat for each entry.

	Binary(4)	Offset to next entry
	Binary(4)	Length of entry
	Binary(4)	Offset to command
	Binary(4)	Length of Command
	Binary(4)	Sequence
	Char(10)	Backup item
	Char(6)	Backup item type
	Char(10)	Backup item auxiliary storage pool device
	Char(*)	Command

Backup item auxiliary storage pool device. The auxiliary storage pool device for the backup item. See the help on the Edit Backup Control Group Entries display for additional information and possible values returned in the field. This field may be blank for entries which do not support this field.

Backup item. The backup item just processed. See the help on the Edit Backup Control Group Entries display for additional information and possible values returned in the field.

Backup item type. The backup item type just processed. See the help on the Edit Backup Control Group Entries display for additional information and possible values returned in the field.

Command. The command just processed for *EXIT backup items. The command is returned in UNICODE CCSID 1200.

Ending message key. This is the ending message key for receiving messages generated by the processed entries. The exit program can receive messages for processed entries beginning with the starting message key through the ending message key.

Length of entry information. The length of the control group entry information.

Length of entry. The length of the current entry. This length does not include the length of the command for *EXIT entries.

- | **Length of command.** The length in bytes of the command data associated with a *EXIT backup item. The length is 0 if the backup item is not *EXIT.
- | **Number of entries.** Most control group entries are processed individually. Some entries may be grouped if these have similar auxiliary storage pools, activity, object detail and save while active attributes. This field indicates the number of entries in the group.
- | **Offset to command.** The offset of the command data associated with a *EXIT backup item. The offset is 0 if the backup item is not *EXIT. This offset is relative to the start of the backup item information.
- | **Offset to first entry.** The offset to the first entry in the control group entry information. This offset is relative to the start of the control group entry information.
- | **Offset to next entry.** The offset to the next entry in the control group entry information. The offset is 0 if this is the last entry. This offset is relative to the start of the control group entry information.
- | **Sequence.** The sequence number of the control group entry. See the help on the Edit Backup Control Group Entries display for additional information and possible values returned in the field.
- | **Starting message key.** This is the starting message key for receiving messages generated by the processed entries. The exit program can receive messages for processed entries beginning with the starting message key through the ending message key.

Tape Information Exit Program

Parameters:

Required Parameter Group:

1 Operational information Input Char(*)

Exit Point Name: QIBM_A1A_TAPE_INF

Exit Point Format Name: MEDI0100

The exit program is called each time that a file is written to a tape. The exit program must be registered to the exit point described above. For example, if a SAVLIB command saved 10 libraries to a tape, the exit would be called 10 times, passing information about each tape file resulting from the save of the libraries. To use this exit point, the customer must develop an exit program and register it to the exit point name and exit point format name shown above. After registration, BRMS will call the program and pass the information described by the parameters.

Required Parameter Group

Operation information

INPUT; Char(*)

Information about the tape operation at the time the exit program is called.

Format of Operational Information

The following table shows the format of the operational information. For a description of each field, see "Field Descriptions" on page 338.

Dec	Offset		Type	Field
	Hex			
0		0	Binary(4)	Length of operational information
4		4	Char(1)	Volume operation

Tape Information Exit Program

Dec	Offset		Type	Field
	Hex	Hex		
5		5	Char(17)	Volume label
22		16	Char(10)	Device name
32		20	Char(4)	Device type
36		24	Char(80)	Volume VOL1 label
116		74	Char(80)	Volume HDR1 label
196		C4	Char(80)	Volume HDR2 label
276		114	Char(24)	Reserved

Note: Volume header and end of volume formats can be found in the IBM standard tape labels documentation. The exit point is used when access to a tape begins.

Field Descriptions

Device name. The name of the device on which the volume is loaded.

Device type. The type of tape device.

Length of operational information. The length of the data in the structure.

Volume HDR1. The header from the standard label.

Volume HDR2. The second header from the standard label volume.

Volume label. The volume label identifier of the volume.

Volume operation. The type of operation being performed on the volume. The values are:

O An output operation is performed on the volume.

I An input operation is performed on the volume.

Volume VOL1. The standard tape label volume information.

Tape Movement Exit Program

Parameters:

Required Parameter Group:

1 Operational information Input Char(*)

Exit Point Name: QIBM_A1A_TAPE_MOVE

Exit Point Format Name: MEDM0100

The exit program is called each time a BRMS registered volume is moved. It will supply the location the volume is moving to and the previous location where the volume came from. To use this exit point the customer will have to develop an exit program and register it to the exit point name and exit point format name listed above. After registration, BRMS will call the program and pass the information described by the parameters.

Required Parameter Group

Operation information

INPUT; Char(*)

Information about the tape movement operation at the time the exit program is called.

Format of Operational Information

The following table shows the format of the operational information. For a description of each field, see "Field Descriptions."

Dec	Offset		Type	Field
		Hex		
	0	0	Binary(4)	Length of operational information
	4	4	Char(6)	Volume ID
	10	0A	Char(8)	Expiration date
	18	12	Char(1)	Expired indicator
	19	13	Char(10)	Current location
	29	1D	Char(6)	To slot
	35	23	Char(10)	Previous location
	45	29	Char(6)	From slot
	51	33	Char(10)	Volume next location
	61	3D	Char(8)	Move date/time
	69	45	Char(10)	Media class
	79	4F	Char(10)	Container ID
	89	59	Char(10)	Move policy
	99	63	Char(1)	Move verification pending

Field Descriptions

Container ID. The identifier of the container if you are using containers to move media. A special value *NONE is returned if you are not using containers.

Expiration date. The date that the volume expires. The format of the date that is returned is job date format. The values are:

*NONE

There is no expiration date. The volume is expired.

*VER EXP

The volume is under version control and has expired.

*VER nnn

The volume is under version control.

*PERM

The volume has a permanent retention date.

From slot. The slot from which the volume came.

Length of operational information. The length of the data in the structure.

Media class. The media class of the volume that is being moved. A special value *NONE is returned if a media class is not found.

Move policy. The move policy associated with the volume that you are moving. A special value *NONE is returned if you are not using a move policy.

Move verification pending. Indicates whether BRMS marked the volume for movement and based on the move policy specified above, whether the move must be verified before it can actually occur. The values are:

0 Verification of moves is not in effect and the volume has been moved when this exit point is reached. The current location is the location to which the volume was moved.

Tape Movement Exit Program

1 The volume has not moved yet, verification of moves is in effect and the location shows the current location of the volume. The next location shows where BRMS intends to move the volume.

Move date/time. The date that the volume is to move. The format of the date that is returned is job date format. The values are:

***NONE**

There is no move date. The volume does not move.

***VER EXP**

The volume is under version control and has expired.

***VER nnn**

The volume is under version control.

To slot. The slot in the location to which the volume is being moved.

Volume ID. The volume ID of the volume that is being moved.

Current location. The location to which the volume is moving. A special value *NONE is returned if the volume does not have a current location.

Previous location. The location from which the volume is being moved. A special value *NONE is returned if the volume does not have a previous location.

Volume next location. The location to which the volume will be moved after this move. A special value *NONE is returned if the volume does not have a next location.

BRMS Object Retrieval Exit Program

Parameters:

Required Parameter Group:

1	Object description information	Input	Char(*)
2	Media information	Input	Char(*)
3	Control value information	Output	Char(*)

Exit Point Name: QIBM_A1A_RETR_INF

Exit Point Format Name: RTVIO100

The BRMS Object Retrieval Exit Program provides the capability of retrieving objects saved using *FREE by BRMS. The exit program, if registered to the exit point, will only be called when the retrieve confirmation within BRMS is *VERIFY.

The user exit program is called each time a suspended object is accessed by an i5/OS operation and BRMS has determined that an archive version of the object is to be restored to the system to satisfy the i5/OS request. This exit will give the user exit program a chance to influence the decision to restore the object as well as provide a custom interface tailored to individual needs.

When the user exit program is given control, it makes the decision as to what continued action should be taken for the suspended object. The exit program returns the appropriate control value information to BRMS indicating either to follow the normal retrieval rules defined to BRMS, to recall immediately, to delay restore to a later time, to submit the restore to batch, or to cancel the restore of the object.

Required Parameter Group

Object description information

INPUT; Char(*)

Information about the object that BRMS intends to restore from storage extension. For details, see “Format of Object Description Information.”

Media information

INPUT; Char(*)

Information about the media or media set needed to restore the object. Media information may include either tape volume information or save file information. For details, see “Format of Media Information” on page 342.

Control value information

OUTPUT; Char(*)

Information about the exit program request of action to be taken by BRMS. For details, see “Format of Control Value Information” on page 342.

Format of Object Description Information

The following table shows the format of the object description information. For a description of each field, see “Field Descriptions.”

Dec	Offset		Type	Field
		Hex		
0		0	Binary(4)	Length of object description information
4		4	Binary(4)	Length of media information
8		8	Binary(4)	Length of control value information
12		0C	Char(10)	Object name
22		16	Char(10)	Object library
32		20	Char(10)	Member name
42		2A	Char(10)	Object owner
52		34	Char(7)	Saved date
59		3B	Char(6)	Saved time
65		41	Char(6)	Saved release
71		47	Char(10)	Media class
81		51	Char(4)	File sequence
85		55	Bin(4)	Member size
89		59	Bin(4)	Member size multiplier
93		5D	Char(2)	Auxiliary storage pool
95		5F	Char(50)	Member text

Field Descriptions

Length of object description information. The length, in bytes, of the object description information.

Length of media information. The length, in bytes, of the media information.

Length of control value information. The length, in bytes, of the control value information.

Object name. The name of the object.

Object library. The name of the library that contained the object.

BRMS Object Retrieval Exit Program

Member name. The name of the member associated with the object.

File sequence. The tape file sequence number assigned when the object was saved on a tape. The field contains zeros if the object was saved to a save file.

Object owner. The owner of that the object that you are retrieving.

Saved date. The date that the object was saved expressed in cyymmdd (century, year, month, day) format.

Saved time. The time that the object was saved expressed in hhmm (hour, minute) format.

Saved release. The release of i5/OS under which the object was saved.

Media class. The media class of the volume that contains the saved objects.

File sequence. The tape file sequence number assigned when the object was saved on a tape. The field contains zeros if the object was saved to a save file.

Member size. The size of the member in units of size multiplier. The member size is equal to or smaller than the member size multiplied by the number size multiplier.

Member size multiplier. The value to multiply the member size by to get the true size. The value is 1 if the member is smaller than 1 000 000 000, and 1024 if it is larger.

Auxiliary storage pool (ASP). The auxiliary storage pool ID.

Member text. Text that describes the object to be recalled.

Format of Media Information

The following table shows the format of the media information. For a description of each field, see “Field Descriptions.”

Dec	Offset		Type	Field
	Hex			
0		0	Bin(4)	Number of volumes
4		-	Char(6)	Volume ID
14		-	Char(10)	Volume location
24		-	Char(6)	Volume retrieval time

Note: The Volume ID, Volume location and Volume retrieval time fields in the previous table are repeated based on the number specified in the Number of volumes field.

Field Descriptions

Number of volumes. The number of volumes required for the object retrieval.

Volume ID. The volume identifier or identifiers of the volumes required for the object retrieval.

Volume location. The location or locations of the volumes required for the object retrieval.

Volume retrieval time. The length of time in hours to return the volume from an off site storage location to the home location. Volume retrieval time is expressed in hhhmm (hours, minutes) format.

Format of Control Value Information

The following table shows the format of the control value information. For a description of each field, see “Field Descriptions” on page 343.

		Offset			
Dec		Hex		Type	Field
	0		0	Char(1)	Return information

Field Descriptions

Return information. The return information for the object that is to be recalled. The values are:

- 0 Process the recall as if the exit program were not called. (*VERIFY)
- 1 Process the recall immediately and notify the user about the recall. (*NOTIFY)
- 2 Mark the object/member to be restored later. (*DELAY)
- 3 Submit the restore to batch. (*SBMJOB)
- 4 Do not recall the object. (*NONE)

BRMS Retrieve Media Information (Q1ARTVMED) API

Parameters:

Required Parameter Group:

	1	Receiver variable	Output	Char(*)
	2	Length of receiver	Input	Binary(4)
	3	Format name	Input	Char(8)
	4	Control value information	Input	Char(33)
	5	Error code	I/O	Char(*)

The BRMS retrieve media information API lets you retrieve BRMS media information for a specific volume or select active or expire volume in a media class and/or location.

Required Parameter Group

Receiver variable

OUTPUT; Char(*)

The receiver variable that is to receive the information requested. You can specify the size of the area to be smaller than the format requested as long as you specify the length of the receiver variable correctly. As a result the API returns only the data the area can hold.

Length of receiver variable

INPUT; Binary(4)

The length of the receiver variable. This length must be at least 6 bytes.

Format name

INPUT; Char(8)

MEDV0100 is the only format name available.

Control value information

INPUT; Char(*)

Information needed by the API to select a media volume is supplied in this structure. For more information see "Format of Control Value Information" section.

Error code

INPUT/OUTPUT; Char(*)

Retrieve Media Information API

The structure in which to return error information. For the format of the structure, see "Error Code Parameter" in the System Programmers Interface Reference.

Format of the Generated Information

The following table shows the format of the MEDV0100. The MEDV0100 format includes the information about the requested media volume. For a description of each field, see "Field Descriptions."

Dec	Offset		Type	Field
	Hex			
0		0	Char(6)	Volume serial
6		06	Char(4)	Secure volume
10		0A	Char(10)	Media group type
20		14	Char(13)	Media group identification
33		21	Char(10)	Media class
43		2B	Char(10)	Location
53		35	Char(7)	Move date
60		3C	Char(10)	Move policy
70		46	Char(7)	Expiration date
77		4D	Char(1)	Volume expired indicator
78		4E	Char(7)	Creation date
85		55	Char(4)	Volume sequence
89		59	Char(6)	Beginning volume
95		5F	Char(50)	Volume description
145		91	Char(8)	Registered system
153		99	Char(8)	System using volume
161		A1	Char(10)	Job name
171		AB	Char(6)	Job number
177		B1	Char(10)	User
187		BB	Char(10)	Next location
197		C5	Char(7)	Next move date
204		CC	Char(10)	Container ID
214		D6	Char(6)	Slot number
220		DC	Char(10)	Previous location
230		E6	Char(1)	Move verification pending

Field Descriptions

Beginning volume. The first volume of a multi-volume set.

Container ID. The container ID of the container in which the volume is stored, if you are using containers.

Creation date. The date expressed in cyymmdd (century, year, month, day) format that the most current data was written on the media.

Expiration date. The date expressed in cyymmdd (century, year, month, day) format that the media expires and can be used as scratch media.

Job name. The name of the job that created the media.

Job number. The number of the job that created the media.

Location. The location where the media is currently stored.

Media group type. A grouping factor assigned by BRMS to handle *GRPnnn moves.

Media group identification. A sub-grouping to bundle like volumes in the same group.

Media class. The media class assigned to the volume.

Move date. The date expressed in cyymmdd (century, year, month, day) format that the media is scheduled to move.

Move verification pending. Indicates whether BRMS marked the volume for movement and based on the move policy specified below, whether the move must be verified before it can actually occur. The values are:

- 0 Verification of moves is not in effect and the volume has been moved when this exit point is reached. The current location is the location to which the volume was moved.
- 1 The volume has not moved yet, verification of moves is in effect and the location shows the current location of the volume. The next location shows where BRMS intends to move the volume.

Move policy. The name of the move policy associated with the volume.

Next location. The next location to which the media will move.

Next move date. The date expressed in cyymmdd (century, year, month, day) format on which the media is scheduled to move next.

Previous location. The location the media moved from to arrive at its current location.

Registered system. The system whose License Manager was used to register the media.

Secure volume. Whether the media requires special authority for read access.

Slot number. The slot number assigned to the media.

System using volume. The system name of the system that last wrote data on the tape.

User. The identification of the user who is assigned to the volume.

Volume expired indicator. Indicates whether or not the volume is expired. The values are:

- Y The volume is expired.
- N The volume is active.

Volume serial. The volume serial of the media.

Volume sequence. The sequence number of the volume in a media set.

Volume description. A text description of the volume.

Format of Control Value Information

The following table shows the format of the control value information. For a description of each field, see "Field Descriptions."

Dec	Offset		Type	Field
	Hex			
0		0	Char(6)	Volume serial
6		06	Char(10)	Media class
16		10	Char(10)	Location
26		1A	Char(7)	Expiration date

Field Descriptions

- | **Volume serial.** The volume serial ID for the media volume to be retrieved. The values are:
- | **volume-serial**
- | A six character media volume serial.
- | ***EXP** Specify to request that an expired volume be located.
- | ***ACT** Specify to request that an active volume with space available for write operations be located.

Retrieve Media Information API

| **Media class.** A media class name that will be used to locate the media volume. This field must be specified if special values *EXP or *ACT are specified for the *Volume serial* field. The possible values are:

| *ANY Specifies the retrieved volume can be assigned to any media class.

| **media-class**

| Specifies the retrieved volume must be assigned to this media class.

| **Location.** A location name that will be used to locate the media volume. This field must be specified if special values *EXP or *ACT are specified for the *Volume serial* field. The possible values are:

| *ANY Specifies the retrieved volume can be assigned to any location.

| **location-name**

| Specifies the retrieved volume must be assigned to this location.

| **Expiration date.** The expiration date expressed in cyymmdd (century, year, month, day) format that will be used to locate an active media volume. This field must be specified if special value *ACT is specified for the *Volume serial* field, otherwise the field should be blank. The possible values are:

| *ANY Specifies any active volume can be retrieved that meets the media class and location control values.

| **expiration-date**

| Specifies the expiration date used to retrieve active volumes. If an active volume with the specified date cannot be retrieved, then the first available active volume that meets the media class and location control values is retrieved.

Error Messages

| BRM1147 E Volume not found.

| BRM1480 E No media of class &1; available.

| BRM1868 E File &1 not opened successfully.

| CPF24B4 E Severe error while addressing parameter list.

| CPF3CF1 E Error code parameter not valid.

| CPF3C19 E Error occurred with receiver variable specified.

| CPF3C1E E Required parameter omitted.

| CPF3C21 E Format name &1; is not valid.

| CPF3C24 E Length of receiver variable is not valid.

| CPF3C3B E Value for parameter &2 for API &1 not valid.

| CPF3C4B E Value not valid for field &1.

BRMS Select Device (Q1ASLTDEV) API

Parameters:

Required Parameter Group:

1 Receiver variable	Output	Char(*)
2 Length of receiver variable	Input	Binary(4)
3 Format name	Input	Char(8)
4 Control value information	Input	Char(47)
5 Error code	I/O	Char(*)

The BRMS select device API lets you select a device to allocate or deallocate, or to select search values such as location and media class to locate and allocate an available device for BRMS media input or output operations.

Required Parameter Group

Receiver variable

OUTPUT; Char(*)

The receiver variable that is to receive the information requested. You can specify the size of the area to be smaller than the format requested as long as you specify the length of the receiver variable correctly. As a result the API returns only the data the area can hold.

Length of receiver variable

INPUT; Binary(4)

The length of the receiver variable. The length must be at least 6 bytes.

Format name

INPUT; Char(8)

DEV00100 is the only format name available.

Control value information

INPUT; Char(*)

Information needed by the API to select a device is supplied in this structure. For more information see "Format of Control Value Information" section.

Error code

INPUT/OUTPUT; Char(*)

The structure in which to return error information. For the format of the structure, see "Error Code Parameter" in the System Programmers Interface Reference.

Format of Generated Information

The following table shows the format of the generated information. The DEV00100 format includes the information about the requested media volume. For a description of each field, see "Field Descriptions."

Dec	Offset		Type	Field
	Hex			
0		0	Char(10)	Device name
10		0A	Char(10)	Location
20		14	Char(10)	Media class

Field Descriptions

Device name. The name of the selected device.

Location. The location of the selected device.

Media class. The name of the media class used to select the device that supports the required density.

Format of Control Value Information

The following table shows the format of the control value information. For a description of each field, see "Field Descriptions" on page 348.

Dec	Offset		Type	Field
	Hex			
0		0	Char(10)	Device name
10		0A	Char(10)	Media class
20		14	Char(10)	Location
30		1E	Char(10)	Device action

BRMS Select Device (Q1ASLTDEV) API

Dec	Offset		Type	Field
	Hex			
40		28	Char(7)	Operation

Field Descriptions

Device name. The name of a valid tape device. A special value of *MEDCLS will instruct the API to locate an available tape device from the BRMS device information.

Location. A location name that will be used to locate an expired media volume. This value is needed only when a device special value of *MEDCLS is specified. The values are:

*ANY Any location can be used to locate an expired volume.

location-name

Specify the name of the location used to locate an expired volume.

Media class. A media class name that will be used to locate an expired media volume. This value is needed only when a device special value of *MEDCLS is specified.

Device action. Specifies the device action that you want to used for the device. The values are:

*ALCDEV

The device is allocated.

*DLCDEV

The device is not allocated. This choice is not valid for device *MEDCLS.

Note: BRMS shared device support is implied in device selection since *ALCDEV will vary on a shared device and *DLCDEV will vary it off.

Operation. Specifies the type of device operation. Since input and output densities for a particular device may be different, the type of device operation will be used to ensure that the device selected for the specified media class is compatible with the operation being requested. The values are:

*INPUT

The operation is an input operation.

*OUTPUT

The operation is an output operation.

Error Messages

- BRM1877 E Devices with density &3; are not available
- BRM1883 E Devices with density &3; are not available
- CPF1002 E Cannot allocate device
- CPF24B4 E Severe error while addressing parameter list.
- CPF3CF1 E Error code parameter not valid.
- CPF3C19 E Error occurred with receiver variable specified.
- CPF3C1E E Required parameter omitted.
- CPF3C21 E Format name &1; is not valid.
- CPF3C24 E Length of receiver variable is not valid.
- CPF3C3B E Value for parameter &2 for API &1 not valid.
- CPF3C4B E Value not valid for field &1.

Appendix D. Notices

This information was developed for products and services offered in the U.S.A.

IBM may not offer the products, services, or features discussed in this document in other countries. Consult your local IBM representative for information on the products and services currently available in your area. Any reference to an IBM product, program, or service is not intended to state or imply that only that IBM product, program, or service may be used. Any functionally equivalent product, program, or service that does not infringe any IBM intellectual property right may be used instead. However, it is the user's responsibility to evaluate and verify the operation of any non-IBM product, program, or service.

IBM may have patents or pending patent applications covering subject matter described in this document. The furnishing of this document does not grant you any license to these patents. You can send license inquiries, in writing, to:

IBM Director of Licensing
IBM Corporation
North Castle Drive
Armonk, NY 10504-1785
U.S.A.

For license inquiries regarding double-byte (DBCS) information, contact the IBM Intellectual Property Department in your country or send inquiries, in writing, to:

IBM World Trade Asia Corporation
Licensing
2-31 Roppongi 3-chome, Minato-ku
Tokyo 106-0032, Japan

The following paragraph does not apply to the United Kingdom or any other country where such provisions are inconsistent with local law: INTERNATIONAL BUSINESS MACHINES CORPORATION PROVIDES THIS PUBLICATION "AS IS" WITHOUT WARRANTY OF ANY KIND, EITHER EXPRESS OR IMPLIED, INCLUDING, BUT NOT LIMITED TO, THE IMPLIED WARRANTIES OF NON-INFRINGEMENT, MERCHANTABILITY OR FITNESS FOR A PARTICULAR PURPOSE. Some states do not allow disclaimer of express or implied warranties in certain transactions, therefore, this statement may not apply to you.

This information could include technical inaccuracies or typographical errors. Changes are periodically made to the information herein; these changes will be incorporated in new editions of the publication. IBM may make improvements and/or changes in the product(s) and/or the program(s) described in this publication at any time without notice.

Any references in this information to non-IBM Web sites are provided for convenience only and do not in any manner serve as an endorsement of those Web sites. The materials at those Web sites are not part of the materials for this IBM product and use of those Web sites is at your own risk.

IBM may use or distribute any of the information you supply in any way it believes appropriate without incurring any obligation to you.

Licensees of this program who wish to have information about it for the purpose of enabling: (i) the exchange of information between independently created programs and other programs (including this one) and (ii) the mutual use of the information which has been exchanged, should contact:

IBM Corporation

Software Interoperability Coordinator, Department YBWA
3605 Highway 52 N
Rochester, MN 55901
U.S.A.

Such information may be available, subject to appropriate terms and conditions, including in some cases, payment of a fee.

- | The licensed program described in this information and all licensed material available for it are provided
- | by IBM under terms of the IBM Customer Agreement, IBM International Program License Agreement,
- | IBM License Agreement for Machine Code, or any equivalent agreement between us.

Any performance data contained herein was determined in a controlled environment. Therefore, the results obtained in other operating environments may vary significantly. Some measurements may have been made on development-level systems and there is no guarantee that these measurements will be the same on generally available systems. Furthermore, some measurements may have been estimated through extrapolation. Actual results may vary. Users of this document should verify the applicable data for their specific environment.

Information concerning non-IBM products was obtained from the suppliers of those products, their published announcements or other publicly available sources. IBM has not tested those products and cannot confirm the accuracy of performance, compatibility or any other claims related to non-IBM products. Questions on the capabilities of non-IBM products should be addressed to the suppliers of those products.

All statements regarding IBM's future direction or intent are subject to change or withdrawal without notice, and represent goals and objectives only.

All IBM prices shown are IBM's suggested retail prices, are current and are subject to change without notice. Dealer prices may vary.

This information is for planning purposes only. The information herein is subject to change before the products described become available.

This information contains examples of data and reports used in daily business operations. To illustrate them as completely as possible, the examples include the names of individuals, companies, brands, and products. All of these names are fictitious and any similarity to the names and addresses used by an actual business enterprise is entirely coincidental.

COPYRIGHT LICENSE:

This information contains sample application programs in source language, which illustrate programming techniques on various operating platforms. You may copy, modify, and distribute these sample programs in any form without payment to IBM, for the purposes of developing, using, marketing or distributing application programs conforming to the application programming interface for the operating platform for which the sample programs are written. These examples have not been thoroughly tested under all conditions. IBM, therefore, cannot guarantee or imply reliability, serviceability, or function of these programs.

If you are viewing this information softcopy, the photographs and color illustrations may not appear.

Trademarks

The following terms are trademarks of International Business Machines Corporation in the United States, other countries, or both:

- | AIX
- | AIX 5L
- | e(logo)server
- | eServer
- | i5/OS
- | IBM
- | IBM (logo)
- | iSeries
- | pSeries
- | xSeries
- | zSeries

- | Intel[®], Intel Inside (logos), MMX[™], and Pentium[®] are trademarks of Intel Corporation in the United States, other countries, or both.

Microsoft[®], Windows, Windows NT[®], and the Windows logo are trademarks of Microsoft Corporation in the United States, other countries, or both.

Java and all Java-based trademarks are trademarks of Sun Microsystems, Inc. in the United States, other countries, or both.

- | Linux is a trademark of Linus Torvalds in the United States, other countries, or both.

UNIX[®] is a registered trademark of The Open Group in the United States and other countries.

Other company, product, and service names may be trademarks or service marks of others.

Terms and conditions

Permissions for the use of these publications is granted subject to the following terms and conditions.

Personal Use: You may reproduce these publications for your personal, noncommercial use provided that all proprietary notices are preserved. You may not distribute, display or make derivative works of these publications, or any portion thereof, without the express consent of IBM.

Commercial Use: You may reproduce, distribute and display these publications solely within your enterprise provided that all proprietary notices are preserved. You may not make derivative works of these publications, or reproduce, distribute or display these publications or any portion thereof outside your enterprise, without the express consent of IBM.

Except as expressly granted in this permission, no other permissions, licenses or rights are granted, either express or implied, to the publications or any information, data, software or other intellectual property contained therein.

IBM reserves the right to withdraw the permissions granted herein whenever, in its discretion, the use of the publications is detrimental to its interest or, as determined by IBM, the above instructions are not being properly followed.

You may not download, export or re-export this information except in full compliance with all applicable laws and regulations, including all United States export laws and regulations.

IBM MAKES NO GUARANTEE ABOUT THE CONTENT OF THESE PUBLICATIONS. THE PUBLICATIONS ARE PROVIDED "AS-IS" AND WITHOUT WARRANTY OF ANY KIND, EITHER EXPRESSED OR IMPLIED, INCLUDING BUT NOT LIMITED TO IMPLIED WARRANTIES OF MERCHANTABILITY, NON-INFRINGEMENT, AND FITNESS FOR A PARTICULAR PURPOSE.

Index

Special characters

- *BKUGRP control group 17, 121
 - backing up with 20
- *EXIT special value 139
- *LNKLIST 173
- *SAVSYS special value
 - using 118
- *SYSGRP control group 17, 120
 - backing up with 20
- *SYSTEM control group 17, 120
 - backing up with 20
- *USRMLB 74

A

- access paths 114
- Add Image Catalog Entry (ADDIMGCLGE) command 81
- Add Media Information Using BRMS (ADDMEDIBRM) command 82
- Add Media Library Media to BRMS (ADDMLMBRM) command 83
- Add Media to BRM (ADDMEDBRM) command 81
- Add Media to BRMS (ADDMEDBRM) command 19, 84
- adding
 - devices 69
 - automatically 69
 - manually 69
 - media contents to the history file
 - from an enrolled volume 82
- ADDLICENSE (Add License Key Information) command 13
- ADDMEDBRM (Add Media to BRMS) command 19, 84
- ADDMEDIBRM (Add Media Information Using BRMS) command 82
- ADDMLMBRM 81
- ADDMLMBRM (Add Media Library Media to BRMS) command 83
- advanced functions feature
 - hierarchical storage management (HSM) 3
 - HSM (hierarchical storage management) 3
 - removing 14
 - uninstalling 14
- and policies 6
- APIs
 - See application program interfaces (APIs)
- appending to media 115
- application program interfaces (APIs) 227
 - BRMS Object Retrieval Exit Program 340
 - BRMS Select Device (Q1ASLTDEV) 346
 - Control Group Exit Program 333

- application program interfaces (APIs) (*continued*)
 - Retrieve Media Information 343
 - Tape Information Exit Program 337
 - Tape Movement Exit Program 338
- applying
 - program temporary fixes (PTFs) 62
 - PTFs (program temporary fixes) 62
- applying journal changes 58, 178
- archiving 294
- ASP Information Report 321
- Attention
 - Excluded Deleted Libraries 38
 - Excluded Save File or TSM Objects 37
 - Omitted Libraries 37
 - Unsaved BRMS Media Information 36
 - Unsaved Libraries 38
 - Unsaved Objects 36
- authorities
 - *SAVSYS special authority 118
- authorization information, recovering 60
- auto enroll media 71
- automated tape library
 - See media libraries
- auxiliary storage pool devices 35, 279
 - Backup 279
 - Recovery 283
- auxiliary storage pools
 - security 213

B

- backing up
 - access paths 114
 - control groups 140
 - entire system 17
 - full system
 - with the *SYSTEM control group 20
 - journaled objects 113
 - libraries 125
 - Lotus servers 261, 268
 - media information 114
 - object level detail 114
 - resuming 140
 - retaining object level detail 114
 - save spooled file data 115
 - system data
 - with the *SYSGRP control group 20
 - user data
 - with the *BKUGRP control group 20
 - with the *SYSGRP control group 20
 - with the *SYSTEM control group 20
 - with the *BKUGRP control group 20
- backup
 - restrictions for *SAVSYS 118
- Backup and Recovery Log
 - See also Log
 - distribute messages 3
- Backup Folder List Report 321
- backup history
 - adding media contents to
 - from an enrolled volume 82
- Backup Link List Report 321
- backup lists
 - creating
 - folder 130
 - link 136
 - object 131
 - spooled file 133
 - definition 130
 - folder lists 130
 - link lists 136
 - object lists 131
 - QALLSPLF spooled file list 134
 - security 212
 - spooled file lists 133
 - types 130
- Backup Object List Report 321
- Backup Plan Report 321
- backup policy
 - changing 112
 - definition 5
 - key parameters 112
- Backup Policy Report 321
- Backup Recovery and Media Services (BRMS) 4
- backup scenarios 151
 - performing a backup across a network
 - with shared devices 156
 - performing parallel and serial backups in the same control group 159
 - using multiple control groups in a serial backup 151
 - using multiple control groups in parallel and concurrent backups 154
- Backup Spooled File List Report 322
- Backup, Recovery, and Media Services (BRMS)
 - advanced functions feature 3
 - removing 14
 - uninstalling 14
 - changing presentation controls 111
 - customizing the look 111
 - functional usage model 211
 - hardware requirements 9
 - installation instructions 12
 - installing the BRMSiSeries Navigator client 14
 - introduction 3
 - libraries
 - QGPL 48
 - QSYS2 48
 - QUSRBRM 35
 - QUSRSYS 35, 48
 - recovering 41, 48

- Backup, Recovery, and Media Services (BRMS) *(continued)*
 - network feature 3
 - overview 3
 - recovering 41
 - removing from your system 14
 - removing the BRMSiSeries Navigator client 15
 - seasonal time changes 257, 259
 - security 211
 - software requirements 9
 - standard product 3
 - backup function 4
 - media management function 4
 - overview 4
 - recovery function 4
 - tape I/O from a program 297
 - uninstalling 14, 15
 - updating license information 13
 - using in a network 237
- backups
 - Auxiliary storage pool devices 279
 - concurrent 149
 - when to use 149
 - customizing 109
 - default weekly activity 113
 - ending subsystems
 - with *SAVSYS 119
 - entire system 17
 - force full backup 113
 - full
 - retention 87
 - full system 17, 19
 - incremental
 - retention 87
 - specifying type 113
 - types 87
 - Lotus server online 261
 - Lotus server online incremental 268
 - media information 104
 - missed object policies 148
 - parallel 149
 - multiple-library parallel 149
 - parallel save/restore 149
 - restrictions 149
 - setting up 150
 - when to use 149
 - performing 19
 - planning 109
 - resuming 140
 - retention
 - full backups 87
 - incremental backups 87
 - scenarios 151
 - performing a backup across a network with shared devices 156
 - performing parallel and serial backups in the same control group 159
 - using multiple control groups in a serial backup 151
 - using multiple control groups in parallel and concurrent backups 154
 - scheduling 119, 145, 201
 - serial 149

- backups *(continued)*
 - special considerations for
 - *SAVSYS 118
 - starting subsystems
 - with *SAVSYS 119
 - strategy 109
 - system data
 - with the *SYSGRP control group 20
 - tailoring 109
 - types of 87
 - unattended 145
 - user data
 - with the *BKUGRP control group 20
 - User-defined file systems 109, 279
- block size 71
- BRMS 4
 - See* Backup, Recovery, and Media Services (BRMS)
- BRMS Log
 - See* Log
- BRMS TSM Client
 - See* Tivoli Storage Manager (TSM)
- BRMS TSM Exits 235
 - benefits 235
 - BRMS setup 235
 - TSM/PASE setup 235

C

- Calendar Report 322
- calendars, move management
 - defining exceptions 97
 - establishing 96
 - exceptions 97
 - for move days 97
 - for working days 97
 - names 98
 - reference calendar 97
 - specifying dates 97
- Centralized Media Audit Report 322
- Change Job Scheduler (CHGSCDBRM)
 - command 205
- change system values 39
- changing
 - control group attributes 124
 - control groups 123
 - device configuration 72
 - device information 70
 - auto enroll media 71
 - configuration 72
 - density 71
 - media libraries 72
 - name 71
 - optimum block size 71
 - shared device 71
 - standalone devices 70
 - device name 71
 - job scheduler 205
 - substitution variables 207
 - optimum block size 71
 - QSECOFR password 47
 - system name 249
- CHGSCDBRM (Change Job Scheduler)
 - command 205
- Commands 9

- Commands *(continued)*
 - Add Image Catalog Entry (ADDIMGCLGE) 81
 - Add License Key Information (ADDLICKEY) 13
 - Add Media Information Using BRMS (ADDMEDIBRM) 82
 - Add Media Library Media to BRMS (ADDMLMBRM) 83
 - Add Media to BRM (ADDMEDBRM) 81
 - Add Media to BRMS (ADDMEDBRM) 84
 - Add Media to BRMS (ADDMEDBRM)
 - command 19
 - ADDLICKEY (Add License Key Information) 13
 - ADDMEDBRM (Add Media to BRMS) 19, 84
 - ADDMEDIBRM (Add Media Information Using BRMS) 82
 - ADDMLMBRM 81
 - ADDMLMBRM (Add Media Library Media to BRMS) 83
 - Change Job Scheduler (CHGSCDBRM) 205
 - CHGSCDBRM (Change Job Scheduler) 205
 - CPYMEDIBRM 246
 - Create Image Catalog (CRTIMGCLG) 81
 - Display Job Log (DSPJOBLOG) 20, 62
 - Display Log for BRM (DSPLOGBRM) 21
 - DSPJOBLOG (Display Job Log) 10, 20, 62
 - DSPLOGBRM (Display Log for BRM) 21
 - DSPSYSVAL (Display System Values) 10
 - Duplicate Media using BRM (DUPMEDBRM) 105
 - Duplicate Media using BRMS (DUPMEDBRM) 102
 - DUPMEDBRM (Duplicate Media using BRMS) 102
 - End Subsystems (ENDSBS) 20
 - ENDSBS (End Subsystems) 20
 - EXTMEDIBRM (Extract Media Information Using BRMS) 82
 - Extract Media Information Using BRMS (EXTMEDIBRM) 82
 - Initialize BRMS (INZBRM) 9
 - Initialize Media Using BRMS (INZMEDBRM) 83
 - Initialize Media Using BRMS (INZMEDBRM) 84
 - INZBRM (Initialize BRMS) 9
 - INZMEDBRM (Initialize Media Using BRMS) 83, 84
 - Monitor Save While Active for BRMS (MONSWABRM) 142
 - MONSWABRM (Monitor Save While Active for BRMS) 142
 - Move Media Using BRMS (MOVMEDBRM) 92, 98

Commands (continued)

MOVMEDBRM (Move Media Using BRMS) 92, 98
 Remove Log Entries from BRM (RMVLOGEBRM) 23
 Restore Authority using BRMS (RSTAUTBRM) 193
 Restore Authority Using BRMS (RSTAUTBRM) 60
 Restore DLO using BRMS (RSTDLOBRM) 193
 Restore Library using BRMS (RSTLIBBRM) 193
 Restore Object using BRMS (RSTBRM) 193
 Restore Object using BRMS (RSTOBJBRM) 193
 RMVLOGEBRM (Remove Log Entries from BRM) 23
 RSTAUTBRM (Restore Authority using BRMS) 193
 RSTAUTBRM (Restore Authority Using BRMS) 60
 RSTBRM (Restore Object using BRMS) command 193
 RSTDLOBRM (Restore DLO using BRMS) 193
 RSTLIBBRM (Restore Library using BRMS) 193
 RSTOBJBRM (Restore Object using BRMS) 193
 Run the Delete Expired Spooled files (DLTEXPSPLF) 136
 SAVBRM (Save BRMS) 160
 SAVDLOBRM (Save DLO using BRMS) 160
 SAVDOMBRM 266
 Save BRMS (SAVBRM) 160
 Save DLO using BRMS (SAVDLOBRM) 160
 Save Folder List using BRMS (SAVFLRLBRM) 161
 Save Library using BRMS (SAVLIBBRM) 161
 Save Media Information using BRMS (SAVMEDIBRM) 161
 Save Object List using BRM (SAVOBJLBRM) 132
 Save Object List using BRMS (SAVOBJLBRM) 161
 Save Object using BRMS (SAVOBJBRM) 161
 Save Save File with BRMS (SAVSAVFBRM) command 126
 Save Save Files using BRMS (SAVSAVFBRM) 161
 Save System using BRMS (SAVSYSBRM) 161
 SAVFLRLBRM (Save Folder List using BRMS) 161
 SAVLIBBRM (Save Library using BRMS) 161
 SAVMEDIBRM (Save Media Information using BRMS) 161
 SAVOBJBRM (Save Object using BRMS) 161

Commands (continued)

SAVOBJLBRM (Save Object List using BRMS) 161
 SAVSAVFBRM (Save Save File with BRMS) command 126
 SAVSAVFBRM (Save Save Files using BRMS) 161
 SAVSYSBRM (Save System using BRMS) 161
 scheduling backups of BRMS save commands 204
 Set User Usage for BRMS (SETUSRBRM) 211
 SETUSRBRM (Set User Usage for BRMS) 211
 Start Backup using BRMS (STRBKUBRM) 20
 Start Backup Using BRMS (STRBKUBRM) 20
 Start Maintenance for BRM (STRMNTBRM) 23
 Start Maintenance for BRMS (STRMNTBRM) 98, 195
 Start Recovery using BRM (STRRCYBRM) 165
 Start Recovery using BRMS (STRRCYBRM) 28, 29, 31
 Start Recovery Using BRMS (STRRCYBRM) 24
 STRBKUBRM (Start Backup using BRMS) 20
 STRBKUBRM (Start Backup Using BRMS) 20
 STRMNTBRM (Start Maintenance for BRM) 23
 STRMNTBRM (Start Maintenance for BRMS) 98, 195
 STRRCYBRM (Start Recovery using BRM) 165
 STRRCYBRM (Start Recovery using BRMS) 28, 29, 31
 STRRCYBRM (Start Recovery Using BRMS) 24
 Work with Configuration Status (WRKCFGSTS) 69
 Work with Containers Using BRMS (WRKCNRBRM) 91
 Work with Devices using BRMS (WRKDEVBRM) 45, 49
 Work with License Information (WRKLCINF) 13
 Work with Link Information (WRKLNKBRM) 173
 Work with Media Information Using BRMS (WRKMEDIBRM) 82
 Work with Media Libraries Using BRMS (WRKMLBBERM) 72
 Work with Media Library Status (WRKMLBSTS) 40, 73
 Work with Media using BRMS (WRKMEDBRM) 19
 Work with Spooled Files (WRKSPLF) 25
 Work with Spooled Files Using BRMS (WRKSPLFBRM) 55
 Work with Storage Locations Using BRMS (WRKLOCBRM) 89

Commands (continued)

Work with Subsystems (WRKSBS) 20
 Work with System Values (WRKSYSVAL) 12
 WRKCFGSTS (Work with Configuration Status) 69
 WRKCLSBRM 78
 WRKCNRBRM (Work with Containers Using BRMS) 91
 WRKDEVBRM (Work with Devices using BRMS) 45, 49
 WRKLCINF (Work with License Information) 13
 WRKLNKBRM (Work with Link Information) 173
 WRKLOCBRM (Work with Storage Locations Using BRMS) 89
 WRKMEDBRM (Work with Media using BRMS) 19
 WRKMEDIBRM (Work with Media Information Using BRMS) 82
 WRKMLBBERM (Work with Media Libraries Using BRMS) 72
 WRKMLBSTS (Work with Media Library Status) 40, 73
 WRKSBS (Work with Subsystems) 20
 WRKSPLF (Work with Spooled Files) 25
 WRKSPLFBRM (Work with Spooled Files Using BRMS) 55
 WRKSYSVAL (Work with System Values) 12
 communications
 in a BRMS network 240
 concurrent backups 149
 when to use 149
 concurrent recoveries 187
 configuration data
 recovering 48
 console monitor 119, 145
 canceling 147
 interrupting 146
 messages 147
 monitoring 147
 securing 216
 starting 146
 Container Class Report 323
 container classes 90
 creating 90
 Work with Container Classes display 90
 Container Report 322
 containers
 adding 91
 changing 91
 classes 90
 creating 90
 managing 91
 move policies 91
 moving 91
 removing 91
 tracking in BRMS 92
 unpacking 91
 control groups
 *BKUGRP 17, 121
 *SYSGRP 17, 120
 *SYSTEM 17, 120

- control groups (*continued*)
 - additional options for processing 140
 - advantages 115
 - backing up 140
 - backups using 17
 - changing 122, 123
 - changing attributes of 124
 - contents 115, 116
 - contents of default control groups 120
 - copying between networked systems 253
 - copying Lotus server 267
 - creating 122
 - creating backup lists in 130
 - default 17, 116
 - *BKUGRP 121
 - *SYSGRP 120
 - *SYSTEM 120
 - contents of 120
 - definition 6, 17, 115
 - editing 122, 123
 - ending subsystems automatically 127
 - exit programs 116
 - file groups 95
 - holding job queues 128
 - how they work 6
 - moving media by 96
 - performing maintenance as part of 198
 - postprocessing exits in 266
 - preprocessing exits in 266
 - processing after save 129
 - processing before save 129
 - processing order 128
 - recovering 165
 - with STRRCYBRM 167
 - recovering multiple 170
 - concurrently 187
 - releasing job queues 128
 - saving selected libraries 125
 - scheduling 119
 - scheduling backups of 201
 - restrictions 203
 - security 212
 - special considerations 125
 - special operations 116
 - exit programs 117
 - tape loading 117
 - special values
 - *ALLDLO 117
 - *ALLPROD 117
 - *ALLTEST 117
 - *ALLUSR 117
 - *ASPnn 117
 - *DLOnn 117
 - *IBM 117
 - *LINK 117
 - *LNKOMTLTS 117
 - *LNKOMTONL 117
 - *LTSOMTONL 117
 - *QHST 117
 - *SAVCFG 118
 - *SAVSECDTA 118
 - *SAVSYS 118
 - *SAVSYSINF 118

- control groups (*continued*)
 - starting subsystems
 - automatically 127
 - user exits in 139
 - using the save-while-active feature 140
 - using with a move policy 96
 - working with 121
 - Controlling subsystem
 - submitting a backup 147
 - copying volumes 103
 - CPYMEDIBRM 246
 - Create Image Catalog (CRTIMGCLG)
 - command 81
 - creating
 - backup lists in a control group 130
 - container classes 90
 - control groups 122
 - folder lists 130
 - link lists 136
 - objects lists 131
 - recovery activities list 191
 - recovery contact list 190
 - spooled file lists 133
 - customizing
 - backup 109
 - planning 109
 - user access to BRMS functions 211

D

- Delete 136
 - expired spooled files 136
- device pooling 71
- Device Report 323
- devices
 - adding 69
 - automatically 69
 - manually 69
 - auto enroll media 71
 - changing configuration 72
 - changing device information
 - media libraries 72
 - changing information 70
 - auto enroll media 71
 - density 71
 - optimum block size 71
 - shared device 71
 - standalone devices 70
 - changing name 71
 - configuration 72
 - density 71
 - initializing 69
 - last active 75
 - optimum block size 71
 - pooling 71
 - security 213
 - sharing 71
 - varying on 69, 70
 - Virtual Tape 73
 - working with 69
- directory objects, recovering 54, 59
- Display ASP Information Report 28
- Display Job Log (DSPJOBLOG) 10
- Display Job Log (DSPJOBLOG)
 - command 20, 62

- Display Log for BRM (DSPLOGBRM)
 - command 21
- Display System Values (DSPSYSVAL) 10
- Distribute messages
 - BRMS Log 3
- DLOs (document library objects)
 - See document library objects (DLOs), recovering
- document library objects (DLOs),
 - recovering 54
- DSPJOBLOG (Display Job Log)
 - command 20, 62
- Duplicate Media using BRM (DUPMEDBRM) command 105
- Duplicate Media using BRMS (DUPMEDBRM) command 102
- duplicating media 102
 - duplicating saved items 105
 - limitations 102
 - remote duplication 104
 - resuming duplication 105
 - saving media information 104
 - Tivoli Storage Manager (TSM) servers 103
- DUPMEDBRM (Duplicate Media using BRMS) command 102
- dynamic retrieval 294

E

- End Subsystems (ENDSBS) command 20
- ENDSBS (End Subsystems) command 20
- enrolling media 80
 - automatically 81
 - existing 81
 - multiple volumes
 - for media libraries 81
 - for stand-alone devices 80
 - virtual volumes 81
- Expire 135
 - saved spooled files 135
- EXTMEDIBRM (Extract Media Information Using BRMS)
 - command 82
- Extract Media Information Using BRMS (EXTMEDIBRM) command 82

F

- file groups 95
- files in directories, recovering 54, 59
- folders
 - recovering 181
 - saving with object detail 181
- functional usage model 211
 - backup usage levels 212
 - backup control groups 212
 - backup lists 212
 - backup policy 212
 - basic backup activities 212
 - how it works 211
 - implementing
 - using iSeries Navigator 213
 - media management usage levels 212
 - advanced media activities 212
 - basic media activities 212

- functional usage model (*continued*)
 - media management usage levels (*continued*)
 - basic movement activities 213
 - media classes 213
 - media information 213
 - media policies 213
 - move policies 213
 - move verification 213
 - recovery usage levels 212
 - basic recovery activities 212
 - recovery policy 212
 - registering new BRMS activities 214
 - system-related usage levels 213
 - auxiliary storage pools 213
 - basic system activities 213
 - devices 213
 - initialize BRMS 213
 - log information 213
 - maintenance 213
 - system policy 213
 - using the SETUSRBRM command with 215
 - working with i5/OS security controls 217

H

- hierarchical storage management 3
- HSM
 - See* hierarchical storage management

I

- IBM Content Manager onDemand for iSeries, recovering 57
- IBM product libraries, recovering 51
- initial program load (IPL)
 - performing 63
- Initialize Media Using BRMS (INZMEDBRM) command 83
- Initialize Media Using BRMS (INZMEDBRM) command 84
- initializing
 - BRMS 9
 - BRMS for online backups 261
 - device information 45
 - devices 69
 - functional authority information 44
 - Initialize BRMS (INZBRM) command 44
 - media library information 45
 - update system name 44
 - volumes 83
 - for use by media libraries 83
 - how many 84
- installing
 - BRMS 9
 - first time 12
 - hardware requirements 9
 - instructions 12
 - over previous version 12
 - planning for 10
 - software requirements 9
- installing the BRMS iSeries Navigator client 14

- Integrated File System
 - recovering objects 166
 - with STRRCYBRM 173
- INZBRM 69
- INZMEDBRM (Initialize Media Using BRMS) command 83, 84
- IPL
 - See* initial program load (IPL)
- iSeries Integration for Windows Server, recovering 56, 63
- iSeries Navigator
 - implementing the functional usage model 213

J

- job log, printing 62
- job queues
 - holding 128
 - releasing 128
- job scheduler
 - changing 205
 - substitution variables 207
- journal changes
 - applying 58, 178
 - recovering 58, 178

L

- labels
 - customizing 108
 - external 107
 - media 107
 - printing 107
- last active device 75
- libraries
 - IBM product 51
 - omitting from a backup 125
 - QGPL 48
 - QSYS2 48
 - QUSRSYS 48, 125
 - recovering 48, 166
 - IBM product 51
 - user 52
 - with STRRCYBRM 172
 - special considerations when saving 125
 - user 52
- Library Backup Analysis Report 323
- Library lists 132
- license, BRMS 13
- Licensed Internal Code, recovering 38
- Link Information Report 324
- Linux servers in a logical partition 57
- Location Analysis Report 324
- Log 21
 - displaying messages 21
 - excluding messages 23
 - printing messages 22
 - removing messages 23
 - sending messages 23
- Log Report 22, 324
- Lotus server online backups
 - See* online backups

M

- maintenance 195
 - Backup Activity Report 196
 - Centralized Media Audit Report 197
 - messages 199
 - reports
 - Backup Activity Report 196
 - BRMS Recovery Reports 196
 - Centralized Media Audit Report 197
 - Save Strategy Exceptions Report 196
 - Tape Volume Report 197
 - Volume Statistics Report 197
 - Volume Threshold Report 197
 - running as an *EXIT 198
 - Save Strategy Exceptions Report 196
- scheduling 197
- security 213
- Start Maintenance for BRMS (STRMNTBRM) command
 - commands processed by 197
 - scheduling 197
 - what it does 195
- Tape Volume Report 197
- Volume Statistics Report 197
- Volume Threshold Report 197

media

- adding media contents to the history file
 - from an enrolled volume 82
- adding to the media scratch pool 264
- appending to 115
- automatically enrolling 71
- container classes 90
- containers 90, 91
- copying volumes 103
- duplicating 102
- enrolling 17, 80, 264
 - media library 19
 - standalone tape device 19
- enrolling existing volumes 81
- enrolling multiple volumes
 - for media libraries 81
 - for stand-alone devices 80
- enrolling virtual volumes 81
- file groups 95
- initializing volumes 83
 - how many 84
- initiating movement 98
 - with MOVMEBRM 98
 - with STRMNTBRM 98
- inventory 84, 101
- managing 7
- media class 18
- media classes 78
- media information
 - in QUSRBRM library 43
 - recovering 43
- mounting volumes 85
- move pattern 94
- moving 7, 92, 93, 98
 - by control group 96
 - by file groups 95
- next volume message prompt 85
- pools 85
 - benefits 85

- media (*continued*)
 - preparing 7, 78
 - recovering media information 43
 - retention
 - definition 87
 - full backups 87
 - incremental backups 87
 - overlapping 87
 - rotating 84
 - limitations of 85
 - scratch pools 85
 - benefits 85
 - security 217
 - sets 84
 - sharing 79
 - slotting 92
 - storage locations 88
 - creating 88
 - defaults 88
 - home location 88
 - how BRMS uses 88
 - media policy 89
 - move policy 88
 - system policy 88
 - uses of 88
 - Work with Storage Locations (WRKLOCBRM) display 89
 - storing 7, 86
 - tape I/O from a program 297
 - tracking 7, 101
 - verifying movement 99
 - write once 79
- Media and Storage Extensions, installing 9
- media class
 - adding 78
 - creating 78
 - definition 18, 78
 - description 79
 - determining 18
 - security 213
 - working with 78
- Media Class Report 325
- Media Expiration Report 325
- Media Information Report 326
- media inventory 101
- media libraries
 - adjustments to BRMS when using 291
 - advantages 72
 - archiving 294
 - automating recovery with 40
 - basic setup 291
 - changing device information 72
 - creating on your system 291
 - definition 72
 - enrolling media in 292
 - enrolling multiple volumes 81
 - how BRMS uses 72
 - initializing volumes for 83
 - model 3494
 - attaching through an RS232 connection 49
 - varying on LAN line description 35
 - varying on the LAN line description 49
- media libraries (*continued*)
 - moving volumes 294
 - non-IBM 74
 - performing a normal save operation 293
 - recovering an entire system 293
 - recovery process 293
 - releasing 70
 - resetting information 49
 - save and restore tasks 292
 - saving licensed programs 293
 - saving storage 293
 - setting up 291
 - sharing 73
 - storage locations 88
 - third party 74
 - user-defined 74
 - varying on 69, 70
 - varying on LAN line description 35
 - Work with Media Libraries Using BRMS (WRKMLBRRM) command 72
 - Work with Media Library Status (WRKMLBSTS) 73
 - Work with Media Library Status (WRKMLBSTS) command 40
 - Media Library Media Report 326
 - Media Library Report 326
- media management
 - components of 7, 77
 - determining media classes 18
 - enrolling media 17
 - media inventory
 - setting up 84
 - media pools 85
 - benefits 85
 - media scratch pools 85
 - benefits 85
 - media set rotation 84
 - limitations of 85
 - moving media 7
 - preparing media 7
 - rotating media sets 84
 - scratch pools 85
 - security 212
 - setting up 77
 - storing media 7
 - tracking media 7
 - usage levels 212
- Media Merge Report 327
- Media Movement Report 327
- media policy
 - changing 86
 - copying 86
 - creating 86
 - definition 5, 86
 - deleting 86
 - displaying 86
 - FULL 6, 86
 - INCR 86
 - predefined 86
 - retention
 - definition 87
 - full backups 87
 - incremental backups 87
 - overlapping 87
 - SAVF 86
- media policy (*continued*)
 - SAVSYS 86
 - security 213
 - storage locations 89
 - storing media 86
 - SYSTEM 86
 - Work with Media Policies display 86
 - Media Policy Report 327
 - Media Report 325
 - Media Volume Statistics Report 327
 - Media Volume Threshold Report 328
 - messages
 - BRM1948 147
 - BRM1950 147
 - BRM1954 147
 - BRM1990 75
 - BRM1991 75
 - console monitor 147
 - CPF3773 62
 - maintenance 199
 - media libraries 75
 - message file Q1AMSGF 75
 - replying to on nonprogrammable workstation 119
 - save-while-active 145
 - Monitor Save While Active for BRMS (MONSWABRM) command 142
 - MONSWABRM (Monitor Save While Active for BRMS) command 142
 - mounting volumes 85
 - Move Media Using BRMS (MOVMEDBRM) command 92, 98
 - move patterns 93
 - scheduling 96
 - move policy
 - and media policies 93
 - calendars 96
 - defining exceptions 97
 - exceptions 97
 - for move days 97
 - for working days 97
 - names 98
 - specifying dates 97
 - changing 93
 - containers 91
 - creating 93
 - default 93
 - definition 5, 93
 - deleting 93
 - move management calendars 96
 - move patterns 96
 - OFFSITE 93
 - security 213
 - storage locations 88
 - using with a control group 96
 - Move Policy Report 328
 - move reports
 - Print Media Movement 101
 - printing 100
 - Run Media Movement 100
 - moving 99
 - See also* move
 - initiating 98
 - media 93
 - security 213
 - with media libraries 294
 - verifying media moves 99

MOVMEDBRM (Move Media Using BRMS) command 92, 98
Multiple Control Groups in a Serial Backup
 appending to media 154
 saving media information 154

N

network feature
 distribute messages 3
networking 237
 APPC configuration 244
 APPN configuration 243
 changing a system name 249
 checking network
 synchronization 254
 copying control groups 253
 how networks communicate 240
 joining two BRMS networks 251
 receiving media information 250
Relational Database
 configuration 243
 removing a system from a network 255
 removing network feature 257
 seasonal time changes 257, 259
 security considerations 244
 setting up 245
 sharing media inventory 238
 synchronizing media inventory 238
 TCP/IP configuration 241
 TCP/IP in restricted state 242
 verifying the network 254
next volume message prompt, setting up 85

O

object level detail 114
omitting
 libraries from a backup 125
online backups
 adding media 264
 choosing the device 264
 choosing the media class 264
 copying Lotus server control groups 267
 disaster recovery planning 270
 enrolling media 264
 how they work 261
 initializing BRMS for 261
 Lotus online data 263
 Lotus server 261
 NNDILOCK.NSF 270
 NOTES.INI 266
 performance tuning 266
 performing 264
 recommendations 265
 restrictions 265, 271
 starting 265
 viewing saved items 269
operating system, recovering 39
optimum block size 71

P

parallel backups 149
 restrictions 149
 setting up 150
 when to use 149
parallel recoveries 187
 performing 188
policies
 and control groups 6
 backup 5, 112
 how they work 5
 media 5, 86, 89
 move 5, 88
 recovery 5, 163
 system 5
 types 5
pooling devices 71
preparing
 media 78
presentation controls 111
 defaults 112
printing
 customized labels 108
 external labels 107
 job log 62
 labels 79, 107
 media labels 107
 media status reports 102
 movement-related reports 100
 recovery reports 24, 28
profiles
 See user profiles
program temporary fixes (PTFs) 62
 applying 62
 reloading latest cumulative 12
programs
 See application program interfaces (APIs)
Prolog information
 Recovering Your Entire System Report 36
PTF
 See program temporary fixes (PTFs)

Q

QALLSPLF spooled file list 134
QALWUSRDMN system value 12
QATACGY file 125
QATADEV file 125
QATAMID file 125
QGGL library 48
QP1A2RCY spooled file 24, 28
QP1AASP spooled file 24, 28
QP1ALG 22
QP1ARCY spooled file 24, 28
QSYS2 library 48
QUSRBRM library 35, 43
 generating a Recovering Your Entire System report from 189
QUSRSYS library 35, 48
 QATACGY file 125
 QATADEV file 125
 QATAMID file 125

R

reclaiming media 106
recovering 27
 applying journaled changes 178
 authority 60
 authorization information 60
 automating your recovery 40
 auxiliary storage pool devices 35
 Auxiliary storage pool devices 283
 BRMS libraries 41
 BRMS product 41
 concurrent 33
 configuration data 48
 control groups
 multiple 170
 with STRRCYBRM 167
 creating a recovery activities list 191
 creating a recovery contact list 190
 directory objects 54, 59
 Display ASP Information Report 28
 DLOs (document library objects) 54
 document library objects (DLOs) 54
 entire system 27
 using a media library 293
 files in directories 54, 59
 folders 181
 generating a Recovering Your Entire System report from the QUSRBRM data files 189
IBM Content Manager onDemand for iSeries 57
IBM product libraries 51
IFS objects
 with STRRCYBRM 173
integrated file system objects
 with STRRCYBRM 173
iSeries Integration for Windows Server 56, 63
journal changes 58, 178
libraries
 with STRRCYBRM 172
Licensed Internal Code 38
Linux servers in a logical partition 57
Lotus server databases 270
media information 43
media sets 33
multiple control groups 170
multiple control groups
 concurrently 187
objects with object detail 175
objects without object detail 177
operating system 39
printing recovery reports 28
Recovering Your Entire System 27
recovery reports 27
Recovery Volume Summary Report 28
remaining system data 50
remaining user data 50
restarting a recovery 64
resuming 31
resuming a recovery 31
scheduling 201
selected items 163
spooled files 55, 184

- recovering (*continued*)
 - Start Recovery using BRMS (STRRCYBRM) 28
 - Start Recovery using BRMS (STRRCYBRM) command 29, 31
 - storage spaces 173
 - STRRCYBRM (Start Recovery using BRMS) 28
 - system libraries 48
 - testing 65
 - tips 64
 - recovery reports 65
 - restarting a recovery 64
 - using i5/OS 65
 - to a different system
 - allowing object differences 46
 - to the same system 46
 - update program temporary fix 58
 - user customized steps 29
 - user libraries 52
 - user profiles 46, 175
 - using i5/OS to assist 65
 - with the recovery policy 163
 - without the Recovery Analysis Report 189
 - identifying the tapes you need 189
 - Recovering Your Entire System report
 - generating from the QUSRBRM data files 189
 - Recovering Your Entire System Report 27
 - control group 35
 - prolog information 36
 - restoring from save files 35
 - restoring from Tivoli Storage Manager (TSM) servers 35
 - saved time 35
 - start time 35
 - using 35
 - volume identifier 35
 - recovery activities list 191
 - Recovery Activities Report 328
 - Recovery Analysis Report 27, 329
 - recovery contact list 190
 - recovery policy
 - definition 5
 - Recovery Policy Report 329
 - recovery reports
 - and system maintenance 196
 - Display ASP Information 24, 28
 - overview 27
 - printing 24, 28
 - Recovering Your Entire System 24, 27
 - Recovering Your Entire System Report using 35
 - Recovery Analysis Report 27
 - Recovery Volume Summary Report 24, 28
 - testing 65
 - user customized steps 29
 - Recovery Volume Summary Report 28, 329
 - reference calendar 97
 - Remove Log Entries from BRM (RMVLOGEBRM) command 23
 - removing BRMS 14
 - reports
 - ASP Information Report 321
 - Backup Activity Report 196
 - Backup Folder List 321
 - Backup Link List 321
 - Backup Object List 321
 - Backup Plan 321
 - Backup Policy 321
 - Backup Spooled File List 322
 - Calendar 322
 - Centralized Media Audit 322
 - Centralized Media Audit Report 197
 - Container 322
 - Container Class 323
 - Device 323
 - Display ASP Information 28
 - Library Backup Analysis 323
 - Link Information 324
 - Location Analysis 324
 - Log 22, 324
 - Media 325
 - Media Class 325
 - Media Expiration 325
 - Media Information 326
 - Media Library 326
 - Media Library Media 326
 - Media Merge 327
 - Media Movement 327
 - Media Policy 327
 - Media Volume Statistics 327
 - Media Volume Threshold 328
 - Move Policy 328
 - movement-related 100
 - printing 24
 - media status 102
 - movement-related 100
 - recovery 28
 - Recovering Your Entire System 27
 - Recovering Your Entire System Report using 35
 - recovery 27
 - Recovery Activities 328
 - Recovery Analysis 329
 - Recovery Analysis Report 27
 - Recovery Policy 329
 - Recovery Volume Summary 329
 - Recovery Volume Summary Report 28
 - Save Files 329
 - Save Strategy Exceptions 330
 - Save Strategy Exceptions Report 196
 - Saved Folders 330
 - Saved Objects 330
 - Saved Spooled Files by Date 330
 - Storage Location 330
 - summary of 321
 - System Policy 331
 - Tape Volume Report 197
 - TSM Performance Analysis Report 331
 - Version Control 331
 - Volume Movement 332
 - Volume Statistics Report 197
 - Volume Threshold Report 197
 - reset system values 62
 - resetting device and media library information 49
 - Restore Authority using BRMS (RSTAUTBRM) command 193
 - Restore Authority Using BRMS (RSTAUTBRM) command 60
 - Restore DLO using BRMS (RSTDLOBRM) command 193
 - Restore Library using BRMS (RSTLIBBRM) command 193
 - Restore Object using BRMS (RSTBRM) command 193
 - Restore Object using BRMS (RSTOBJBRM) command 193
 - restoring
 - See* recovering
 - retaining object level detail 114
 - retention, media 87
 - full backups 87
 - incremental backups 87
 - RSTAUTBRM (Restore Authority using BRMS) command 193
 - RSTAUTBRM (Restore Authority Using BRMS) command 60
 - RSTBRM (Restore Object using BRMS) command 193
 - RSTDLOBRM (Restore DLO using BRMS) command 193
 - RSTLIBBRM (Restore Library using BRMS) command 193
 - RSTOBJBRM (Restore Object using BRMS) command 193
 - Run the Delete Expired Spooled files (DLTEXPSPLF) command 136
- ## S
- SAVBRM (Save BRMS) command 160
 - SAVDLOBRM (Save DLO using BRMS) command 160
 - SAVDOMBRM 266
 - Save BRMS (SAVBRM) command 160
 - Save DLO using BRMS (SAVDLOBRM) command 160
 - Save Files 219
 - libraries containing 221, 222
 - overview 219
 - specifying in control groups 220
 - working with 222
 - Save Files Report 329
 - Save Folder List using BRMS (SAVFLRLBRM) command 161
 - Save Library using BRMS (SAVLIBBRM) command 161
 - Save Media Information using BRMS (SAVMEDIBRM) command 161
 - Save Object List using BRM (SAVOBJLBRM) command 132
 - Save Object List using BRMS (SAVOBJLBRM) command 161
 - Save Object using BRMS (SAVOBJBRM) command 161
 - Save Save File with BRMS (SAVSAVFBRM) command 126
 - Save Save Files using BRMS (SAVSAVFBRM) command 161
 - save spooled file data 115

- Save Strategy Exceptions Report 330
 - Save System using BRMS (SAVSYSBRM)
 - command 161
 - save-while-active feature 140
 - activating 141
 - advantages 140
 - message queue 145
 - messages 145
 - monitoring for synchronization
 - checkpoints 142
 - using without commitment control 140
 - using without journaling 140
 - Saved Folders Report 330
 - Saved Objects Report 330
 - Saved Spooled Files by Date Report 330
 - SAVFLRLBRM (Save Folder List using BRMS) command 161
 - SAVLIBBRM (Save Library using BRMS) command 161
 - SAVMEDIBRM (Save Media Information using BRMS) command 161
 - SAVOBJBRM (Save Object using BRMS) command 161
 - SAVOBJLBRM (Save Object List using BRMS) command 161
 - SAVSAVFBRM (Save Save File with BRMS) command 126
 - SAVSAVFBRM (Save Save Files using BRMS) command 161
 - SAVSYSBRM (Save System using BRMS) command 161
 - scheduling
 - *SAVSYS backups 119
 - backups 201
 - with *SAVSYS in them 119
 - BRMS save command backups 204
 - changing the job scheduler 205
 - substitution variables 207
 - control group backups 201
 - restrictions 203
 - maintenance 197
 - recoveries 201, 204
 - scheduling an *SAVSYS with console monitoring 119
 - selected recoveries 204
 - viewing scheduled jobs 205
 - working with scheduled jobs 204
 - security
 - console monitor 216
 - functional usage model 211
 - backup function 212
 - how it works 211
 - in a network 244
 - media 217
 - recommendations 217
 - working with i5/OS security controls 217
 - recommendations 217
 - serial backups 149
 - serial recoveries 187
 - Set User Usage for BRMS (SETUSRBRM) command 211
 - setting up
 - BRMS network 245
 - media inventory system 84
 - media management 77
 - setting up (*continued*)
 - next volume message prompt 85
 - SETUSRBRM (Set User Usage for BRMS) command 211
 - sharing devices 71
 - signing off interactive users 6
 - Slotting 92
 - media 92
 - special operations 116
 - exit programs 117
 - tape loading 117
 - special values 117
 - *ALLDLO 117
 - *ALLPROD 117
 - *ALLTEST 117
 - *ALLUSR 117
 - *ASPnn 117
 - *DLOnn 117
 - *EXIT 139
 - *IBM 117
 - *LINK 117
 - *LNKOMTLTS 117
 - *LNKOMTONL 117
 - *LTSOMTONL 117
 - *QHST 117
 - *SAVCFG 118
 - *SAVSECDTA 118
 - *SAVSYS 118
 - authority needed 118
 - restrictions 118
 - special considerations 118
 - using 118
 - *SAVSYSINF 118
 - spooled files
 - backing up 133
 - creating spooled file lists 133
 - expiration 135
 - QALLSPLF spooled file list 134
 - QP1A2RCY 24, 28
 - QP1AASP 24, 28
 - QP1ARCY 24, 28
 - recovering 55, 184
 - Work with Spooled Files (WRKSPLF) command 25
 - Work with Spooled Files Using BRMS (WRKSPLFBRM) command 55
 - SRM database
 - See system resource management (SRM) database
 - standard product 3
 - backup function 4
 - media management function 4
 - overview 4
 - recovery function 4
 - Start Backup using BRMS (STRBKUBRM) command 20
 - Start Backup Using BRMS (STRBKUBRM) command 20
 - Start Maintenance for BRM (STRMNTBRM) command 23
 - Start Maintenance for BRMS (STRMNTBRM) command 98, 195
 - Start Recovery using BRM (STRRCYBRM) command 165
 - parameters 166
 - what it does 165
 - Start Recovery using BRMS (STRRCYBRM) command 28, 29, 31
 - Start Recovery Using BRMS (STRRCYBRM) command 24
 - Storage Location Report 330
 - storage locations
 - creating 88
 - home location 88
 - how BRMS uses 88
 - media libraries 88
 - media policy 89
 - move policy 88
 - system policy 88
 - uses of 88
 - Work with Storage Locations (WRKLOCBRM) display 89
 - storage locations, media 88
 - STRBKUBRM (Start Backup using BRMS) command 20
 - STRBKUBRM (Start Backup Using BRMS) command 20
 - STRMNTBRM (Start Maintenance for BRMS) command 98, 195
 - STRRCYBRM (Start Recovery using BRM) command 165
 - STRRCYBRM (Start Recovery using BRMS) command 28, 29, 31
 - STRRCYBRM (Start Recovery Using BRMS) command 24
 - substitution variables 207
 - subsystems
 - ending 20
 - with *SAVSYS 119
 - ending automatically 127
 - starting
 - with *SAVSYS 119
 - starting automatically 127
 - working with 20
 - SWA feature
 - See save-while-active feature
 - system information, verify 61
 - system policy
 - customizing backups 110
 - default value 6
 - defaults 110
 - definition 5
 - key parameters 110
 - overriding 6, 113
 - security 213
 - storage locations 88
 - understanding 110
 - System Policy Report 331
 - system recovery 27
 - system resource management (SRM) database 46, 48
 - system values 12
 - QALWUSRDMN (Allow user domain objects in user libraries) 12
- T**
- tape automation
 - See media libraries
 - tape input/output 297
 - input processing 301
 - messages 309
 - processing techniques 309

tape input/output (*continued*)
 tape file processing 299
 with multiple devices 303
 calling the program 306
 compiling the program 304
 creating tape file objects 303
 indicating which drives to
 use 305
 managing the media 306
 results 307

tape library

See media libraries

third party media libraries 74

time 237

 differences 237

 seasonal changes 257, 259

Tivoli Storage Manager (TSM) 35

 adding a location 228

 benefits 223

 Create a media policy 229

 data retention protection 225

 duplicating items saved to 103

 IBM Data Retention 450 (DR450) 225,
 226, 229, 232

 IBM Data Retention 550 (DR550) 225,
 226, 229, 232

 overview 223

 performance 224

 restrictions 223

 setting up 226

 TSM (ADSM) Server 226

 TSM Client 227

 TSM application program interfaces
 (APIs) 227

 using archive retention
 protection 232

TSM

See Tivoli Storage Manager (TSM)

TSM Performance Analysis Report 331

U

uninstalling BRMS 14

uninstalling the BRMS iSeries Navigator
 client 15

update program temporary fix 58

updating

 license information 13

user exits

 definition 139

 in control groups 139

 in Lotus server backups 266
 processing 139

user libraries, recovering 52

user profiles

 allowing object differences 46
 QSECOFR

 changing 47

 recovering 46, 175

User-defined file systems 109, 279

V

varying on

 device 69

 media library 69

verifying system information 61

Version Control Report 331

Virtual volumes

 enrolling 81

Volume Movement Report 332

W

Work with Configuration Status

(WRKCFGSTS) command 69

Work with Containers Using BRMS

(WRKCNBRBM) command 91

Work with Devices using BRMS

(WRKDEVBRM) command 45, 49

Work with Link Information

(WRKLNKBRM) command 173

Work with Media Classes Using BRMS

(WRKCLSBRM) command 79

Work with Media Information Using

BRMS (WRKMEDIBRM) command 82

Work with Media Libraries Using BRMS

(WRKMLBBERM) command 72

Work with Media Library Status

(WRKMLBSTS) command 40, 73

Work with Media using BRMS

(WRKMEDBRM) command 19

Work with Spooled Files (WRKSPLF)

 command 25

Work with Spooled Files Using BRMS

(WRKSPLFBRM) command 55

Work with Storage Locations

(WRKLOCBRM) display 89

Work with Storage Locations Using

BRMS (WRKLOCBRM) command 89

Work with Subsystems (WRKSBS)

 command 20

Work with System Values

(WRKSYSVAL) 12

Work with System Values (WRKSYSVAL)

 command 39, 62

working with devices 69

WRKCFGSTS (Work with Configuration
 Status) command 69

WRKCLSBRM 78

WRKCLSBRM (Work with Media Classes
 Using BRMS) command 79

WRKCNBRBM (Work with Containers
 Using BRMS) command 91

WRKDEVBRM (Work with Devices using
 BRMS) command 45, 49

WRKLICINF (Work with License

 Information) command 13

WRKLNKBRM (Work with Link

 Information) command 173

WRKLOCBRM (Work with Storage

 Locations Using BRMS) command 89

WRKMEDBRM (Work with Media using
 BRMS) command 19

WRKMEDIBRM (Work with Media

 Information Using BRMS)

 command 82

WRKMLBBERM (Work with Media

 Libraries Using BRMS) command 72

WRKMLBSTS (Work with Media Library
 Status) command 40, 73

WRKSBS (Work with Subsystems) 20

WRKSPLF (Work with Spooled Files)

 command 25

WRKSPLFBRM (Work with Spooled Files
 Using BRMS) command 55

WRKSYSVAL (Work with System
 Values) 12

WRKSYSVAL (Work with System Values)

 command 39, 62

Readers' Comments — We'd Like to Hear from You

IBM Systems - iSeries
Backup Recovery and Media Services for iSeries
Version 5

Publication No. SC41-5345-05

Overall, how satisfied are you with the information in this book?

	Very Satisfied	Satisfied	Neutral	Dissatisfied	Very Dissatisfied
Overall satisfaction	<input type="checkbox"/>	<input type="checkbox"/>	<input type="checkbox"/>	<input type="checkbox"/>	<input type="checkbox"/>

How satisfied are you that the information in this book is:

	Very Satisfied	Satisfied	Neutral	Dissatisfied	Very Dissatisfied
Accurate	<input type="checkbox"/>	<input type="checkbox"/>	<input type="checkbox"/>	<input type="checkbox"/>	<input type="checkbox"/>
Complete	<input type="checkbox"/>	<input type="checkbox"/>	<input type="checkbox"/>	<input type="checkbox"/>	<input type="checkbox"/>
Easy to find	<input type="checkbox"/>	<input type="checkbox"/>	<input type="checkbox"/>	<input type="checkbox"/>	<input type="checkbox"/>
Easy to understand	<input type="checkbox"/>	<input type="checkbox"/>	<input type="checkbox"/>	<input type="checkbox"/>	<input type="checkbox"/>
Well organized	<input type="checkbox"/>	<input type="checkbox"/>	<input type="checkbox"/>	<input type="checkbox"/>	<input type="checkbox"/>
Applicable to your tasks	<input type="checkbox"/>	<input type="checkbox"/>	<input type="checkbox"/>	<input type="checkbox"/>	<input type="checkbox"/>

Please tell us how we can improve this book:

Thank you for your responses. May we contact you? Yes No

When you send comments to IBM, you grant IBM a nonexclusive right to use or distribute your comments in any way it believes appropriate without incurring any obligation to you.

Name

Address

Company or Organization

Phone No.



Fold and Tape

Please do not staple

Fold and Tape



NO POSTAGE
NECESSARY
IF MAILED IN THE
UNITED STATES

BUSINESS REPLY MAIL

FIRST-CLASS MAIL PERMIT NO. 40 ARMONK, NEW YORK

POSTAGE WILL BE PAID BY ADDRESSEE

IBM CORPORATION
ATTN DEPT 542 IDCLERK
3605 HWY 52 N
ROCHESTER MN 55901-7829

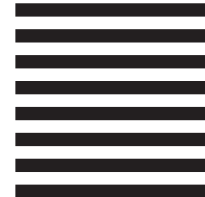

Fold and Tape

Please do not staple

Fold and Tape



Printed in USA

SC41-5345-05

