



IBM Systems - iSeries  
Backup and Recovery

*Version 5 Revision 4*

SC41-5304-08







@server

IBM Systems - iSeries  
Backup and Recovery

*Version 5 Revision 4*

SC41-5304-08

**Note**

Before using this information and the product it supports, be sure to read the information in Appendix E, "Notices," on page 491.

**Ninth Edition (February 2006)**

This edition applies to version 5, release 4, modification 0 of IBM i5/OS/ (product number 5722-SS1) and to all subsequent releases and modifications until otherwise indicated in new editions. This version does not run on all reduced instruction set computer (RISC) models nor does it run on CISC models.

This edition replaces SC41-5304-07.

© Copyright International Business Machines Corporation 1997, 2006. All rights reserved.

US Government Users Restricted Rights – Use, duplication or disclosure restricted by GSA ADP Schedule Contract with IBM Corp.

# Contents

Figures . . . . .	ix
-------------------	----

Tables . . . . .	xi
------------------	----

## About Backup and Recovery, SC41-5304-07. . . . . xiii

Who should read this book . . . . .	xiii
Prerequisite and related information . . . . .	xiii
How to send your comments . . . . .	xiv

## What's new for V5R4. . . . . xv

## Part 1. Saving Information on Your System. . . . . 1

### Chapter 1. Saving your Server . . . . . 3

Save your server with the GO SAVE command . . . . .	3
Overview of the GO SAVE command menu options . . . . .	5
Save your entire server with GO SAVE: Option 21. . . . .	6
View entire GO SAVE checklist . . . . .	7
Identify optional features that affect your backup. . . . .	12
Do you use user-defined file systems on this system? . . . . .	12
Using the character-based interface . . . . .	13
Do you use virtual storage? . . . . .	13
Do you use independent disk pools? . . . . .	13
Have you configured independent disk pools to switch between systems in a cluster . . . . .	13
Do you use WebSphere MQ, V5.3 on this system? . . . . .	13
Using the character-based interface . . . . .	14
Do you use OptiConnect controllers? . . . . .	14
Using iSeries Navigator . . . . .	14
Using the character-based interface . . . . .	14
Do you use network servers? . . . . .	14
Do you use the Hardware Management Console for eServer? . . . . .	14
Printing system information . . . . .	14
Save Considerations When Checking Out Objects. . . . .	17
Tape Write Error Recovery . . . . .	17
Using the OptiConnect Function . . . . .	18
Components of OptiConnect. . . . .	18
Setting Up Your System to Use OptiConnect . . . . .	19
How the System Runs an ObjectConnect Command. . . . .	19
Using the ObjectConnect Commands . . . . .	21
Investigating ObjectConnect Problems . . . . .	21
CPFAD84 Error Codes. . . . .	22

## Part 2. Recovering Information on Your System . . . . . 25

## Chapter 2. Restore Procedures—General Information . . . . . 29

The Relationship Between Save and Restore Commands . . . . .	31
What Happens When You Restore Objects . . . . .	32
Sequence for Restoring Related Objects . . . . .	34
Putting Your System in a Restricted State . . . . .	35
Reclaim Storage . . . . .	35
How to Reclaim Storage . . . . .	36
Reclaim Object Links . . . . .	39
Controlling Restoration of Security-Sensitive Objects . . . . .	40
Minimizing Object Scans After Restores . . . . .	43
How to Set the QPFRADJ System Value for a Different Processor or Memory . . . . .	44
Locked Objects While Restoring . . . . .	44
How to verify that objects are restored successfully . . . . .	45
Recovery from an Unsuccessful Restore Operation . . . . .	46
Recovering from an Error While Restoring Libraries . . . . .	47
Recovering from an Error While Restoring DLOs . . . . .	48
How to Perform a Normal IPL . . . . .	49
Parallel Restore Operations . . . . .	49

## Chapter 3. Selecting the Appropriate Recovery Strategy . . . . . 51

Some Common Recovery Terminology . . . . .	51
Recovery Procedure for a Power Failure. . . . .	52
Recovery Procedure for a System Failure . . . . .	53
Recovery Procedure for a Program Failure or Human Error. . . . .	53
Choosing the Recovery Procedure for a Disk Failure or Disk Errors . . . . .	53
Actions for load source disk unit failure—Checklist 1 . . . . .	55
Actions for load source disk unit failure—Checklist 2 . . . . .	56
Actions for load source disk unit failure—Checklist 3 . . . . .	57
Actions for load source disk unit failure—Checklist 4 . . . . .	58
Actions for load source disk unit failure—Checklist 5 . . . . .	62
Actions for non-load source disk unit failure or disk units in basic user ASP disk failure—Checklist 6 . . . . .	66
Actions for non-load source disk unit failure—Checklist 7 . . . . .	66
Actions for non-load source disk unit failure—Checklist 8 . . . . .	67
Actions for non-load source disk unit failure—Checklist 9 . . . . .	68
Actions for non-load source disk unit failure—Checklist 10. . . . .	72
Actions for a failure in a basic ASP disk unit—Checklist 11 . . . . .	76

Actions for a failure in a basic ASP disk unit—Checklist 12 . . . . .	76
Actions for a failure in a basic ASP disk unit—Checklist 13 . . . . .	78
Actions for non-load source disk unit failure—Checklist 14. . . . .	80
Actions for non-load source disk unit failure—Checklist 15. . . . .	81
Actions for non-load source disk unit failure—Checklist 16. . . . .	81
Actions for independent ASP disk failure—Checklist 17. . . . .	82
Actions for a failure in an independent ASP disk unit—Checklist 18 . . . . .	83
Actions for a failure in an independent ASP disk unit—Checklist 19 . . . . .	84
Recovering your entire system after a complete system loss—Checklist 20 . . . . .	85
Recovering your entire system after a complete system loss including independent ASPs—Checklist 21 . . . . .	88
Restoring a Logical Partition to Another Logical Partition—Checklist 22 . . . . .	92
Actions for a failed cache card – Checklist 23 . . . . .	94
Choosing the Procedure to Recover User Information . . . . .	95
Recovering User Information Using Commands—Checklist 24 . . . . .	97
Using Option 21 from the Restore Menu—Checklist 25 . . . . .	100
Using Options 22 and 23 from the Restore Menu—Checklist 26 . . . . .	103
Recovering User Information Using Tapes from Operational Assistant Backup—Checklist 27 . . . . .	106

## **Chapter 4. Recovering the Licensed Internal Code . . . . . 111**

How to Prepare for Loading the Licensed Internal Code . . . . .	112
Task 1—Getting Ready to Load the Licensed Internal Code . . . . .	112
Task 2—Powering Down the System . . . . .	113
Task 3a—Preparing the System to Perform an IPL from an Alternate Device . . . . .	114
Task 3b—Preparing a Logical Partition to Perform an IPL from an Alternate Device . . . . .	114
Task 4—Loading the Licensed Internal Code from Media . . . . .	115
How to Load the Licensed Internal Code . . . . .	120
How to Recover Your Logical Partition Configuration . . . . .	123
How to Set Up Your Disk Configuration After Installing the Licensed Internal Code and Initializing the System . . . . .	125
How to Recover Your Disk Configuration Using iSeries Navigator at DST . . . . .	126
How to Recover Your Disk Configuration . . . . .	130
How to Start Your System After Restoring Licensed Internal Code . . . . .	133

## **Chapter 5. Restoring the Operating System . . . . . 135**

Choosing the Right Procedure for Restoring the Operating System . . . . .	136
How to Load the Operating System Using a Manual IPL . . . . .	137
How to Restore the operating system . . . . .	137
Task 1—Starting to Restore the Operating System . . . . .	138
Task 2—Selecting the Installation Options . . . . .	142
Task 3—Selecting IPL Options . . . . .	146
Task 4—Setting Major System Options . . . . .	148
Task 5—Defining or Changing the System at IPL . . . . .	148
Task 6—Completing the IPL . . . . .	150
Recovering from SRC A900 2000 . . . . .	152
Creating a Configuration for Other Tape Units . . . . .	152

## **Chapter 6. Starting the System After It Ends Abnormally. . . . . 155**

What Happens When Your System Stops . . . . .	155
Using the Disk Configuration Error Report Display . . . . .	155
Using the Main Storage Dump Occurred Display . . . . .	156
How to Restart Your System . . . . .	157
Task 1—Performing an Attended IPL . . . . .	157
Task 2—Edit Rebuild of Access Paths. . . . .	159
Task 3—Edit Check Pending Constraints. . . . .	161
Task 4—Recovering from Damaged Objects and Unreadable Sectors . . . . .	162

## **Chapter 7. Recovering Information in a User Auxiliary Storage Pool . . . . . 169**

Describing the Contents of Your User Auxiliary Storage Pools . . . . .	169
Choosing the Procedure to Recover User ASPs . . . . .	170
How to Recover a Basic User ASP After Recovering the System ASP . . . . .	170
Task 1—Reclaiming Storage . . . . .	171
Task 2—Restoring User Profiles. . . . .	172
Task 3—Restoring the Configuration . . . . .	172
Task 4—Recovering Journals and Journal Receivers in the QRCL Library . . . . .	173
Task 5—Restoring Libraries to the System Auxiliary Storage Pool . . . . .	174
Task 6—Restoring Document Library Objects to the System Auxiliary Storage Pool . . . . .	175
Task 7—Restoring User-Defined File Systems to the User Auxiliary Storage Pool . . . . .	175
Task 8— Reclaiming Document Library Objects . . . . .	176
Task 9—Recovering Save Files from the QRCL Library . . . . .	176
Task 10—Associating Journal Receivers with Journals . . . . .	176
Task 11—Restoring Object Ownership . . . . .	178
How to Recover An Overflowed User Auxiliary Storage Pool. . . . .	179
Resetting An Overflowed User Auxiliary Storage Pool without an IPL . . . . .	179
Resetting An Overflowed User Auxiliary Storage Pool during an IPL. . . . .	180

How to Delete Overflowed Objects during Recovery . . . . .	182	Restoring Authority on a System in a Restricted State . . . . .	211
How to Recover a Damaged Basic Auxiliary Storage Pool. . . . .	183	What the System Does When You Restore Authority. . . . .	212
Task 1–Restoring User Profiles. . . . .	183	Restore authorities for independent ASP data. . . . .	214
Task 2–Determining the Contents of the Lost Auxiliary Storage Pool . . . . .	183	How to Restore Configuration Objects . . . . .	218
Task 3–Determining Tasks to Restore Objects	184	Correcting Problems with the System Resource Management Information . . . . .	219
Task 4–Restoring Libraries to a Basic Auxiliary Storage Pool. . . . .	184	Recovering When You Change the Console Type	221
Task 5–Restoring Journals to a Basic Auxiliary Storage Pool. . . . .	185	Recovering the System/36 Environment Configuration . . . . .	221
Task 6–Restoring Documents to a Basic Auxiliary Storage Pool . . . . .	186	Restoring Logical Partitions . . . . .	222
Task 7–Restoring User-Defined File Systems to a Basic Auxiliary Storage Pool . . . . .	186	Restoring Libraries . . . . .	223
Task 8–Restoring Journal Receivers to a Basic Auxiliary Storage Pool . . . . .	187	Restoring a Library From a Previous Release	223
Task 9–Restore Save Files to a Basic Auxiliary Storage Pool. . . . .	187	Restoring Multiple Libraries . . . . .	223
How to Recover an Independent ASP . . . . .	187	Considerations and Restrictions . . . . .	224
Task 1–Restoring User Profiles. . . . .	187	How to Restore All Libraries from a Single Save Operation . . . . .	224
Task 2–Determining Tasks to Restore Objects to an Independent ASP . . . . .	188	How to Restore All Libraries from Multiple Save Operations . . . . .	225
Task 3–Restoring Libraries to the Independent Auxiliary Storage Pool . . . . .	188	How to Restore Objects . . . . .	225
Task 4–Restoring User-Defined File Systems to the Independent Auxiliary Storage Pool . . . . .	189	Restoring User-Defined File Systems . . . . .	226
Task 5. Restoring Authority for an Independent ASP . . . . .	190	Restoring an unmounted UDFS . . . . .	226
How to Remove a Failed Disk Unit from the System ASP . . . . .	190	Restoring an individual object from an unmounted UDFS . . . . .	226
Task 1–Accessing Dedicated Service Tools . . . . .	191	Restoring a mounted UDFS . . . . .	226
Task 2–Deleting the Auxiliary Storage Pool Data	192	Restoring Objects That Are Journaled . . . . .	226
Task 3–Removing the Disk Unit from the Auxiliary Storage Pool Configuration . . . . .	193	What Happens When You Restore Journaled Objects to a Different Library or Directory. . . . .	227
<b>Chapter 8. The Restore Menu . . . . .</b>	<b>195</b>	Restoring Database Files. . . . .	228
What the Restore Menu Options Do. . . . .	195	Comparing File Attributes during a Restore Operation . . . . .	229
How to Use Restore Menu Options 21, 22, and 23	196	How the System Matches File Members during a Restore Operation . . . . .	231
<b>Chapter 9. How to Restore Specific Types of Information . . . . .</b>	<b>201</b>	Restoring Members to a File . . . . .	231
Recovering System Information . . . . .	201	Restoring Logical Files . . . . .	232
Sequence for Restoring Security Information . . . . .	201	How the System Restores Access Paths. . . . .	233
Restoring User Profiles . . . . .	202	How the System Restores Files with Shared Formats . . . . .	235
What Happens When You Restore User Profiles	203	How the System Restores Files with Referential Constraints . . . . .	235
What You Should Know About Restoring User Profiles . . . . .	204	How the System Restores Files with Triggers	237
How the System Establishes Ownership for Restored Objects . . . . .	206	Steps Before Deleting a Physical File . . . . .	237
How the System Establishes the Authorization List for a Restored Object . . . . .	206	Restoring Journals and Journal Receivers . . . . .	238
How the System Establishes the Primary Group for Restored Objects . . . . .	206	Restoring Journals. . . . .	238
Restoring Object Authorities . . . . .	206	Steps before Deleting a Journal . . . . .	238
Overview of Restoring Authorities . . . . .	207	Restoring Journal Receivers. . . . .	239
Restoring Authority on a System in a Non-restricted State . . . . .	207	Steps before Deleting a Journal Receiver . . . . .	240
		How the System Restores Programs . . . . .	241
		Restoring Programs to a Different Release . . . . .	242
		Restoring Save File Data. . . . .	242
		Save and restore spooled files . . . . .	243
		Restoring Licensed Programs . . . . .	244
		Restoring Documents and Folders . . . . .	244
		RSTDLO Command Options . . . . .	244
		Using Multiple Concurrent DLO commands . . . . .	245
		Output from the RSTDLO Command . . . . .	245
		Considerations and Restrictions . . . . .	245
		Restoring Folders . . . . .	246
		Renaming Documents When Restoring . . . . .	247

How the System Restores Descriptive Information for DLOs . . . . .	247
How the System Restores Authority and Ownership for DLOs . . . . .	247
When to Run the Rename Directory (RNMDIRE) Command . . . . .	248
When to Run the Rename Document Library Object (RNMDLO) Command . . . . .	248
Restoring Objects in Directories . . . . .	248
Completing Recovery for the IBM iSeries Integration for Windows Server Product . . . . .	250
Recovery for save performed with Integrated xSeries Server varied off. . . . .	250
Recovery for save performed with Integrated xSeries Server varied on. . . . .	251
Recovering Linux or AIX in a Partition . . . . .	251
Recovery Steps for i5/OS Enhanced Integration for Novell NetWare . . . . .	252
Recovering a Domino Server . . . . .	252
Recovering an entire Domino server. . . . .	252
Recovering Domino mail . . . . .	253
Recovering specific Domino databases . . . . .	253
Restoring changed objects to a Domino server . . . . .	254
Restoring a Windows server . . . . .	256
Restrictions When Using the Restore Command . . . . .	256
How to Restore Program Temporary Fixes. . . . .	259
Restore system information. . . . .	260

## Chapter 10. How to Restore Changed Objects and Apply Journalled Changes . . . . . 261

Task 1–Restoring Changed Objects . . . . .	262
Restoring Changed Objects by Library . . . . .	262
Restoring Changed Objects Individually . . . . .	262
Task 2–Restoring Changed Objects in Directories . . . . .	263
Task 3–Determining Whether You Need to Apply Journalled Changes . . . . .	263
Task 4–Determining What Journal Receivers to Use . . . . .	264
Task 5–Applying Journalled Changes for User Journals . . . . .	266
Task 6–Applying Journalled Changes for the QAOSDIAJRN Journal . . . . .	267
Task 7–Restoring Changed Documents and Folders . . . . .	268

## Chapter 11. Mirrored Protection Recovery Actions . . . . . 269

System Actions for Permanent Errors . . . . .	269
Suspending Mirrored Units. . . . .	270
Resuming Mirrored Units . . . . .	271
Replacing a Mirrored Unit . . . . .	271
Using Spare Nonconfigured Units for Replacement. . . . .	273
Mirrored Protection Recovery Actions Performed by the Service Representative . . . . .	275
Other Recovery Considerations for Mirrored Protection . . . . .	275
Mirrored Protection Disk-Error Handling . . . . .	276
Missing Disk Units . . . . .	276
Saving a Unit . . . . .	277
Restoring a Unit . . . . .	277

Active Mirrored Load Source Failure . . . . .	278
Unknown Unit 1 Status . . . . .	280
Display Incorrect Licensed Internal Code Installation . . . . .	281
Recovering remote load source mirroring . . . . .	281
Recovering After the Remote Load Source Has Failed . . . . .	281
Recovering After the Local Load Source Has Failed on an iSeries server . . . . .	282
Dedicated Recovery of Local Load Source -- Local System is Still Functional . . . . .	282
Dedicated Recovery From Remote Disk Units -- After a Local Site Disaster . . . . .	282
Using the Recover Mirrored Load Source Function . . . . .	283

## Chapter 12. How to Restore Your System Using Operational Assistant Tapes . . . . . 285

How to Restore Your Libraries. . . . .	286
How to Restore Libraries That You Saved by Using a Backup List . . . . .	287
How to Restore Changed Objects That You Saved by Using Operational Assistant . . . . .	288

## Chapter 13. How to Restore the System from the Save Storage Media . 289

Task 1–Powering Down the System and Loading the Licensed Internal Code . . . . .	289
Task 2–Restoring the Save Storage Tapes . . . . .	290
Task 3–Responding to Messages . . . . .	292
Task 4–Completing the Restore Storage Operation . . . . .	293
Task 5–Restoring Additional Information . . . . .	295
Task 6–Restoring Program Temporary Fixes (PTFs) . . . . .	295
How to Resume the Restore Storage Operation . . . . .	296

## Part 3. Release-to-Release Support 297

### Chapter 14. Release-to-Release Support . . . . . 299

Current Release-to-Previous Release Support . . . . .	299
Creating the Object for the Previous Release . . . . .	300
Saving the Object for the Previous Release . . . . .	301
Testing the Object on the Current Release . . . . .	306
Restoring and Using the Object on the Previous Release . . . . .	307
Restrictions for Current Release-to-Previous Release Support . . . . .	307
Previous Release-to-Current Release Support . . . . .	307
Considerations when Moving System Customization Information . . . . .	308
Restoring Previous Release User Data to a New System . . . . .	308
Restrictions When Going from Previous Release to Current Release. . . . .	325



<b>Chapter 15. System Synchronization-Planning and Procedures</b>	<b>327</b>
Synchronization Methods: Overview	328
Moving Changed Objects	329
Steps for Saving Changed Objects	329
Steps for Restoring Changed Objects	331
Problems When Restoring Changed Objects	332
Moving Entire Libraries	334
Considerations for Moving Entire Libraries	335
Moving Individual Objects	335
Applying Journalled Changes	336
Refreshing Your new system	338
Additional Synchronization Tips	338

---

**Part 4. Tips for Merging two or more i5/0S systems. . . . . 341**

<b>Chapter 16. Tips for merging two systems into a single system</b>	<b>343</b>
Guidelines for Restoring Information from the Development System	343

---

**Part 5. Alternate Installation Device . . . . . 345**

<b>Chapter 17. Using an Alternate Installation Device</b>	<b>347</b>
Alternate Installation Device—Overview	347
Setting up an Alternate Installation Device	347
Disabling an Alternate Installation Device	350
Verifying and selecting an alternate installation device during a manual installation	350

---

**Part 6. Disk Configuration and Protection . . . . . 353**

<b>Chapter 18. Configuring Disks and Disk Protection</b>	<b>355</b>
Choosing the Right Procedure for Configuring Disks	355
Configuring Disks on a New System—Checklist 1	355
Adding Disk Units without Device Parity Protection—Checklist 2	356
Adding Disk Units to an Existing Input/Output Adapter—Checklist 3	358
Adding a New Input/Output Adapter—Checklist 4	359
Moving Disk Units Between Non-Mirrored Auxiliary Storage Pools—Checklist 5	360
Moving Disk Units Between Mirrored Auxiliary Storage Pools—Checklist 6	361
Deleting an Auxiliary Storage Pool—Checklist 7	362
Removing Disk Units Without Device Parity Protection—Checklist 8	363

Removing Disk Units That Have Device Parity Protection from an ASP Without Mirrored Protection—Checklist 9	364
Removing Disk Units That Have Device Parity Protection from an ASP With Mirrored Protection—Checklist 10	365
Using System Service Tools and Dedicated Service Tools	366
How to Display Your Disk Configuration	368

**Chapter 19. Working with Auxiliary Storage Pools . . . . . 375**

How to Add Disk Units to an Auxiliary Storage Pool	375
How to Change the Storage Threshold for an Auxiliary Storage Pool	377
How to Change the Storage Threshold for the System Auxiliary Storage Pool.	378
How to Move a Disk Unit to a Different Auxiliary Storage Pool.	380
How to Remove a Disk Unit from an Auxiliary Storage Pool.	382
How to Delete an Auxiliary Storage Pool	384
Calculating Space Requirements for an Auxiliary Storage Pool.	385
How to Display the Objects in a User ASP	385
Balancing an Auxiliary Storage Pool.	386
Capacity Balancing	386
Usage Balancing	386
Hierarchical Storage Management (HSM) Balancing.	386
Transferring Objects between Auxiliary Storage Pools	386
How to Move Authorities to a Different ASP	387
How to Transfer a Library to a Different ASP	387
How to Transfer a Folder to a Different ASP	388
How to Transfer Journals and Objects to a Different ASP	388
How to Create Objects in a Library User ASP	389
How to Place Journal Receivers in a User ASP	390
How to Move Journal Receivers From an Overflowed Basic User ASP	391
How to Reset a Journal with a Status of Overflowed	391
How to Work with Nonlibrary User ASPs	393
Creating Objects in a Nonlibrary User ASP	393
Transferring an Object to a Nonlibrary User ASP	393
Transferring a Journal to a Nonlibrary User ASP	394

**Chapter 20. Working with Device Parity Protection . . . . . 397**

Starting Device Parity Protection	397
How to Start Device Parity Protection for an Input/Output Adapter	397
Stopping Device Parity Protection	399
How to Stop Device Parity Protection on an Input/Output Adapter	399
How to Remove Disk Units that have Device Parity Protection for an iSeries server with the system powered on	400

How to remove disk units that have device parity protection for an iSeries server with the system powered off . . . . .	402
How to remove disk units that have device parity protection for an eServer i5. . . . .	405
How to include a disk unit in device parity protection . . . . .	406
How to Exclude a Disk Unit from Device Parity Protection . . . . .	407
How to Display Device Parity Status . . . . .	408

**Chapter 21. Working with Mirrored Protection . . . . . 411**

Mirrored Protection–Configuration Rules . . . . .	411
How to Start Mirrored Protection. . . . .	411
What the System Does When You Start Mirrored Protection . . . . .	413
Mirrored Protection Configuration Errors . . . . .	413
How to Stop Mirrored Protection. . . . .	414

**Chapter 22. Working with Disk Compression . . . . . 417**

Introduction to Disk Compression . . . . .	417
Restrictions and Considerations . . . . .	417
Disk Compression and Capacity . . . . .	418
Disk Unit Full Considerations . . . . .	419
How The System Responds to Disk Unit Full 448 Reference Code A6xx 0277 . . . . .	420
SRC Code A6xx 0277 . . . . .	420
User Action 1 . . . . .	422
User Action 2 . . . . .	422
User Action 3 . . . . .	423
User Action 4 . . . . .	423
Examples of A6xx 0277 . . . . .	423
How to Start Disk Compression . . . . .	424
How to Stop Disk Compression . . . . .	426
Procedural Sequences for Configuring Disks and Protection . . . . .	428
Adding a New I/O Compression-Capable Storage Controller . . . . .	428
Adding Disk Units to an Existing Compression-Capable Storage Controller . . . . .	429
Moving Disk Units from the System ASP to a User ASP. . . . .	430
Recovering from Error Codes . . . . .	431
Recovering from SRC 6xxx 7051 . . . . .	431
Recovering from SRC 6xxx 7052 . . . . .	432

**Chapter 23. Managing Auxiliary Storage Pools . . . . . 433**

Working with ASP Trace and ASP Balance. . . . .	433
Capacity Balance . . . . .	434
Hierarchical Storage Management (HSM) Balance . . . . .	434
Usage Balance . . . . .	435
ASP Trace . . . . .	435
Determining adequate disk storage . . . . .	436

**Part 7. Backup and Recovery Tools and Techniques . . . . . 437**

**Chapter 24. Examples: Techniques and Programming for Backup and Recovery . . . . . 439**

Examples: Backup and Recovery . . . . .	439
Using the Retrieve Journal Entry (RTVJRNE) Command in a Program. . . . .	439
CL Program to Handle Escape Conditions. . . . .	439
Writing Output to Save Media Using the Receive Journal Entry Command . . . . .	441

**Appendix A. Licensed Internal Code Installation Error Displays . . . . . 445**

**Appendix B. Example Disaster Recovery Plan . . . . . 453**

Section 1. Example: Major Goals of a Disaster Recovery Plan . . . . .	453
Section 2. Example: Personnel . . . . .	453
Organization Chart . . . . .	454
Section 3. Example: Application Profile . . . . .	454
Section 4. Example: Inventory Profile . . . . .	454
Section 5. Information Services Backup Procedures . . . . .	455
Section 6. Disaster Recovery Procedures . . . . .	455
Disaster Action Checklist . . . . .	456
Recovery Start-up Procedures for Use after Actual Disaster. . . . .	456
Section 7. Recovery Plan–Mobile Site . . . . .	457
Mobile Site Setup Plan . . . . .	457
Communication Disaster Plan . . . . .	458
Electrical Service . . . . .	458
Section 8. Recovery Plan–Hot Site . . . . .	458
Hot-Site System Configuration . . . . .	458
Section 9. Restoring the Entire System . . . . .	458
Section 10. Rebuilding Process. . . . .	459
Section 11. Testing the Disaster Recovery Plan . . . . .	459
Section 12. Disaster Site Rebuilding . . . . .	461
Vendors . . . . .	462
Floor Plan . . . . .	462
Section 13. Record of Plan Changes . . . . .	462

**Appendix C. Recovering Your Server 463**

**Appendix D. Recovering Your Server to a Different Server . . . . . 477**

**Appendix E. Notices . . . . . 491**

Trademarks . . . . .	493
Terms and conditions. . . . .	493

**Bibliography. . . . . 495**

**Index . . . . . 497**

---

## Figures

1. Save commands and menu options . . . . .	4	19. Example: Restoring a Journaled Object to a Different Library . . . . .	227
2. OptiConnect Job Flow . . . . .	20	20. Example of a Database File with Two Members . . . . .	228
3. Restore Procedures . . . . .	30	21. Restoring a Copy of a File . . . . .	229
4. Save procedures and restore procedures for file systems . . . . .	31	22. Restoring Database Files with Different Creation Dates . . . . .	230
5. User ASP Configuration Before Failure	169	23. Restoring Database Files with Different Creation Dates . . . . .	230
6. Basic User ASP Configuration After Restoring Operating System . . . . .	171	24. Restoring Access Paths . . . . .	234
7. User ASP Configuration After Reclaiming Storage . . . . .	172	25. Restoring a Referential Constraint Network	236
8. User ASP Configuration After Recovering Isolated Journal Receiver. . . . .	174	26. An Object with Hard Links-Example	249
9. Restore Menu-First Display. . . . .	195	27. An Object with a Symbolic Link-Example	250
10. Sample Job Log for RSTAUT on a System in a Restricted State . . . . .	209	28. Sample Recovery Time Line. . . . .	261
11. Expanded Text for Message CPF3736	210	29. Receiver Directory-Saving Attached Receivers	264
12. Expanded Text for Message CPF3845	210	30. Receiver Directory-Saving Detached Receivers . . . . .	265
13. Sample Job Log for RSTAUT on a System in a Non-restricted State . . . . .	210	31. How the System Is Saved with Operational Assistant Backup . . . . .	286
14. Expanded Text for Message CPF3845	211	32. Recovery steps for restoring previous release user data to a new system . . . . .	309
15. Save from an independent ASP and restore it to an independent ASP with an identical name. . . . .	215	33. Overview of Synchronization Process	328
16. Save from *SYSBAS and restore it to an independent ASP. . . . .	216	34. Display Hardware Resource Listing . . . . .	369
17. Save from an independent ASP and restore it to an independent ASP with a different name.	217	35. Program for Retrieving Journal Entries	439
18. Save from an independent ASP and restore it to *SYSBAS. . . . .	218	36. Example Program Prompts for Restoring the Required Receiver For an APYJRNCHG. . . . .	440
		37. Program for writing RCVJRNE output to save media . . . . .	442



## Tables

1. Spooled Files Created by the server . . . . .	16	30. Choosing the Correct Recovery Procedure for User Information. . . . .	96
2. OptiConnect and Associated iSeries Save and Restore Commands . . . . .	18	31. Checklist for Recovering User Information Using Commands . . . . .	97
3. Relationship Between Save and Restore Commands. . . . .	31	32. Checklist for Recovering User Information Using Option 21 . . . . .	101
4. Restoring Objects with ALWOBJDIF . . . . .	33	33. Checklist for Recovering User Information Using Options 22 and 23. . . . .	103
5. Resolving Problems Detected by the RCLSTG Procedure . . . . .	38	34. Checklist for Recovering User Information Using Operational Assistant Backup Tapes. . . . .	107
6. Lock Type Needed for Restore Operation . . . . .	44	35. Options from the Install the Licensed Internal Code (LIC) Menu . . . . .	111
7. Choosing the Correct Recovery Procedure for Disk Media Failure . . . . .	54	36. SRC Codes When Loading the Licensed Internal Code . . . . .	118
8. Recovery Checklist for Disk Failure—Checklist 1 . . . . .	56	37. Configuring Disk While Installing the Operating System . . . . .	140
9. Recovery Checklist for Disk Failure—Checklist 2 . . . . .	56	38. Recovery for Damaged Objects by Object Type . . . . .	163
10. Recovery Checklist for Disk Failure—Checklist 4 . . . . .	59	39. Object Types That Require Special Procedures for Deleting . . . . .	180
11. Recovery Checklist for Disk Failure—Checklist 5 . . . . .	62	40. Tasks for Restoring basic ASP Objects . . . . .	184
12. Recovery Checklist for Disk Failure—Checklist 6 . . . . .	66	41. Example of restore order for independent ASPs saved with GO SAVE: Option 21 or 23 . . . . .	188
13. Recovery Checklist for Disk Failure—Checklist 7 . . . . .	67	42. Tasks for Restoring independent ASP Objects . . . . .	188
14. Recovery Checklist for Disk Failure—Checklist 8 . . . . .	67	43. Commands for Changing System Information . . . . .	201
15. Recovery Checklist for Disk Failure—Checklist 9 . . . . .	68	44. How User Profiles Are Restored . . . . .	202
16. Recovery Checklist for Disk Failure—Checklist 10. . . . .	72	45. Results of Restoring User Profiles. . . . .	204
17. Recovery Checklist for Disk Failure—Checklist 11. . . . .	76	46. Restoring an Object Linked to an Authorization List . . . . .	206
18. Recovery Checklist for Disk Failure—Checklist 12. . . . .	77	47. How Configuration Objects Are Restored . . . . .	219
19. Recovery Checklist for Disk Failure—Checklist 13. . . . .	79	48. Methods for Restoring All Libraries—Single Save Operation . . . . .	224
20. Recovery Checklist for Disk Failure—Checklist 14. . . . .	81	49. Methods for Restoring All Libraries—Multiple Save Operations . . . . .	225
21. Recovery Checklist for Disk Failure—Checklist 15. . . . .	81	50. Restoring a File Network . . . . .	234
22. Recovery Checklist for Disk Failure—Checklist 16. . . . .	82	51. Restoring Files That Have Trigger Programs . . . . .	237
23. Recovery Checklist for Disk Failure—Checklist 17. . . . .	83	52. Save and restore spooled files . . . . .	243
24. Recovery Checklist for Disk Failure—Checklist 18. . . . .	83	53. Restoring Objects That Have Hard Links . . . . .	250
25. Recovery Checklist for Disk Failure—Checklist 19. . . . .	84	54. Using the RST Command for QSYS.LIB Objects. . . . .	257
26. Recovery Checklist for Complete System Loss—Checklist 20 . . . . .	86	55. New Name Options on the RST Command—Examples . . . . .	258
27. Recovery Checklist for Complete System Loss—Checklist 21 . . . . .	89	56. Restore Procedures for Changed Objects . . . . .	262
28. Recovery Checklist for Complete System Loss—Checklist 22 . . . . .	92	57. Handling Messages When Restoring Storage . . . . .	293
29. Recovery Checklist for Failed Cache Card—Checklist 23 . . . . .	95	58. Values for TGTRLS Parameter . . . . .	299
		59. Language Support for the Target Release Parameter. . . . .	300
		60. Previous-Release Support by Object Type . . . . .	302
		61. Comparison of Synchronization Methods . . . . .	329
		62. Choosing the Right Disk Procedure . . . . .	355
		63. Configuring Disks on a New System—Tasks . . . . .	356
		64. Adding Disk Units without Device Parity Protection—Tasks . . . . .	357
		65. Adding Disk Units to an Existing Input/Output Adapter—Tasks . . . . .	358
		66. Adding a New input/output adapter—Tasks . . . . .	359

67. Moving Disk Units Between ASPs–Tasks	360	74. SRC code word formats in V4R4 and previous releases.	421
68. Moving Disk Units Between ASPs with mirrored protection–Tasks	361	75. Adding a New I/O Storage Controller and Disk Units	428
69. Deleting an Auxiliary Storage Pool–Tasks	362	76. Adding Compressed Disk Units to an Existing Storage Controller	429
70. Removing Disk Units That Do Not Have Device Parity Protection–Tasks	363	77. Moving Disk Units from the System ASP to a User ASP	430
71. Removing Disk Units from an IOA and a Non-Mirrored ASP–Tasks	364	78. Checklist for Testing the Disaster Recovery Plan	459
72. Removing Disk Units from an IOA and a Mirrored ASP–Tasks	365		
73. Word formats for SRC codes in V4R5.	420		

---

## About Backup and Recovery, SC41-5304-07

This book provides general information about backup and recovery options for the IBM® iSeries server. It describes the options available on the system, compares and contrasts them, and tells where to find more information about them. This book release contains minimal information about how to back up your server. Look for comprehensive information about backing up your server in the iSeries Information Center at the following Web site: <http://www.ibm.com/eserver/series/infocenter>.

This book provides information on the following topics:

- Procedures on how to save your system with the Save menu options of the GO SAVE command.
- Restoring to a different releases of i5/OS™
- Selecting the right recovery strategy
- Procedures for restoring information to your system
- Device Parity Protection procedures
- Mirrored protection procedures

---

### Who should read this book

This book is intended for someone who is assigned the responsibilities of backup and recovery planning and recovering the system after a failure. You should be familiar with the information contained in the **Systems Management** —> **Backup and Recovery** topic of the Information Center Website before using this book. If you know how to operate the system, you should be ready to use this book.

---

### Prerequisite and related information

Use the iSeries Information Center as your starting point for iSeries technical information.

You can access the Information Center two ways:

- From the following Web site:  
<http://www.ibm.com/eserver/series/infocenter>
- From the *iSeries Information Center*, SK3T-4091-04 CD-ROM. This CD-ROM ships with your new iSeries hardware or IBM i5/OS software upgrade order. You can also order the CD-ROM from the IBM Publications Center:  
<http://www.ibm.com/shop/publications/order>

The iSeries Information Center contains new and updated iSeries information such as software and hardware installation, Linux®, WebSphere®, Java™, high availability, database, logical partitions, CL commands, and system application programming interfaces (APIs). In addition, it provides advisors and finders to assist in planning, troubleshooting, and configuring your iSeries hardware and software.

With every new hardware order, you receive the *iSeries Setup and Operations CD-ROM*, SK3T-4098-02. This CD-ROM contains IBM @server IBM eServer iSeries Access for Windows and the EZ-Setup wizard. iSeries Access Family offers a powerful set of client and server capabilities for connecting PCs to iSeries™ servers. The EZ-Setup wizard automates many of the iSeries setup tasks.

For other related information, see the “Bibliography” on page 495.

---

## How to send your comments

Your feedback is important in helping to provide the most accurate and high-quality information. If you have any comments about this book or any other iSeries documentation, fill out the readers' comment form at the back of this book.

- If you prefer to send comments by mail, use the readers' comment form with the address that is printed on the back. If you are mailing a readers' comment form from a region other than the United States, you can give the form to the local IBM branch office or IBM representative for postage-paid mailing.
- If you prefer to send comments by FAX, use either of the following numbers:
  - United States, Canada, and Puerto Rico: 1-800-937-3430
  - Other countries or regions: 1-507-253-5192
- If you prefer to send comments electronically, use one of these e-mail addresses:
  - Comments on books:  
RCHCLERK@us.ibm.com
  - Comments on the iSeries Information Center:  
RCHINFOC@us.ibm.com

Be sure to include the following:

- The name of the book or iSeries Information Center topic.
- The publication number of a book.
- The page number or topic of a book to which your comment applies.



---

## What's new for V5R4

- The “Restore system information” on page 260 (RSTSYSINF) can be used to restore the data from the Save System Information (SAVSYSINF) command.
- There are several new methods to save and restore spooled files.
- Learn how to “Restore authorities for independent ASP data” on page 214 through a variety of scenarios and commands.
- There are new improvements to the “Reclaim Storage” on page 35 (RCLSTG) command. These improvements include:
  - Reclaim only IFS objects
  - Estimate duration option
  - Progress indication and time remaining estimates
- There are new concurrent reclaim commands.
  - The “Reclaim Object Links” on page 39 (RCLLNK) command concurrently reclaims an IFS directory.
  - The Reclaim Objects by Owner (RCLOBJOWN) command concurrently verifies all objects for a specific user profile are in a library. Refer to CL command finder in the iSeries Information Center <http://www.ibm.com/eserver/iseres/infocenter> for more information.
  - Reclaim Database Cross-Reference (RCLDBXREF) command concurrently recovers DB cross-reference catalog data for a library. Refer to CL command finder in the iSeries Information Center <http://www.ibm.com/eserver/iseres/infocenter> for more information.

### New parameters

- The integrated file system Restore (RST) command is enhanced to support restoring using parallel devices. There is a new parameter to create parent directories during a restore. Refer to CL command finder in the iSeries Information Center <http://www.ibm.com/eserver/iseres/infocenter> for more information.

### How to see what's new or changed

To help you see where technical changes have been made, this information uses:

- The | image to mark where new or changed information begins.
- The | image to mark where new or changed information ends.

To find other information about what's new or changed this release, see the Memo to users.

The iSeries Information Center contains comprehensive information for backing up your server. The hardcopy book contains basic information on how to use the Save menu options with the GO SAVE command. This allows you to save all or parts of your server.

Access the iSeries Information Center at the following Web site:

<http://www.ibm.com/eserver/iseres/infocenter>



---

## Part 1. Saving Information on Your System

<b>Chapter 1. Saving your Server</b> . . . . .	3
Save your server with the GO SAVE command . . . . .	3
Overview of the GO SAVE command menu options . . . . .	5
Save your entire server with GO SAVE: Option 21 . . . . .	6
View entire GO SAVE checklist . . . . .	7
Identify optional features that affect your backup. . . . .	12
Do you use user-defined file systems on this system? . . . . .	12
Using iSeries Navigator . . . . .	13
Using the character-based interface . . . . .	13
Do you use virtual storage? . . . . .	13
Do you use independent disk pools? . . . . .	13
Have you configured independent disk pools to switch between systems in a cluster . . . . .	13
Do you use WebSphere MQ, V5.3 on this system? . . . . .	13
Using iSeries Navigator . . . . .	14
Using the character-based interface . . . . .	14
Do you use OptiConnect controllers? . . . . .	14
Using iSeries Navigator . . . . .	14
Using the character-based interface . . . . .	14
Do you use network servers? . . . . .	14
Do you use the Hardware Management Console for eServer? . . . . .	14
Printing system information . . . . .	14
Save Considerations When Checking Out Objects. . . . .	17
Tape Write Error Recovery . . . . .	17
Using the OptiConnect Function . . . . .	18
Components of OptiConnect. . . . .	18
Setting Up Your System to Use OptiConnect . . . . .	19
How the System Runs an ObjectConnect Command . . . . .	19
Using the ObjectConnect Commands . . . . .	21
Save/Restore (SAVRST) Command . . . . .	21
Save/Restore Object (SAVRSTOBJ) Command . . . . .	21
Save/Restore Change Objects (SAVRSTCHG) Command . . . . .	21
Save/Restore Library (SAVRSTLIB) Command . . . . .	21
Save/Restore Document Library Object (SAVRSTDLO) Command . . . . .	21
Save/Restore Configuration (SAVRSTCFG) Command . . . . .	21
Investigating ObjectConnect Problems . . . . .	21
CPFAD84 Error Codes. . . . .	22
Source System-specific Error Codes from CPFAD84 Message . . . . .	22
Target System-specific Error Codes from CPFAD84 Message . . . . .	22
Source or Target system Error Codes from CPFAD84 Message . . . . .	23



---

## Chapter 1. Saving your Server

Look for comprehensive information about how to backup your iSeries server on the iSeries Information Center on the Internet. See “Prerequisite and related information” on page xiii for information on how to access the Information Center.

If this is your first experience with your iSeries server, use the following instructions to save all of the information on your iSeries server. Do this with the GO SAVE menu options. The instructions in the book are the same as the instructions in the Information Center.

You can browse the Information Center, or print out a copy of the information on how to backup your entire iSeries server.

---

### Save your server with the GO SAVE command

Save your entire server or parts of your server that change regularly with this simple method.

Using the GO SAVE command is a simple way to make sure that you have a good backup of your entire server. The GO SAVE command presents you with Save menus that make it easy to back up your server, no matter what backup strategy you decide to use. It is a good idea to use menu option 21 of the GO SAVE command right after you install your server.

Menu option 21 of the GO SAVE command is the basis for all save strategies. This option allows you to perform a complete save of all the data on your server. Once you have used menu option 21, you can use other menu options to save parts of the server, or to use a manual save process.

Another save method uses Backup Recovery and Media Services, which automates your save processes. BRMS provides a comprehensive and easy solution for your backup and recovery needs.

The following figure illustrates the commands and menu options you can use to save the parts of the server and the entire server.

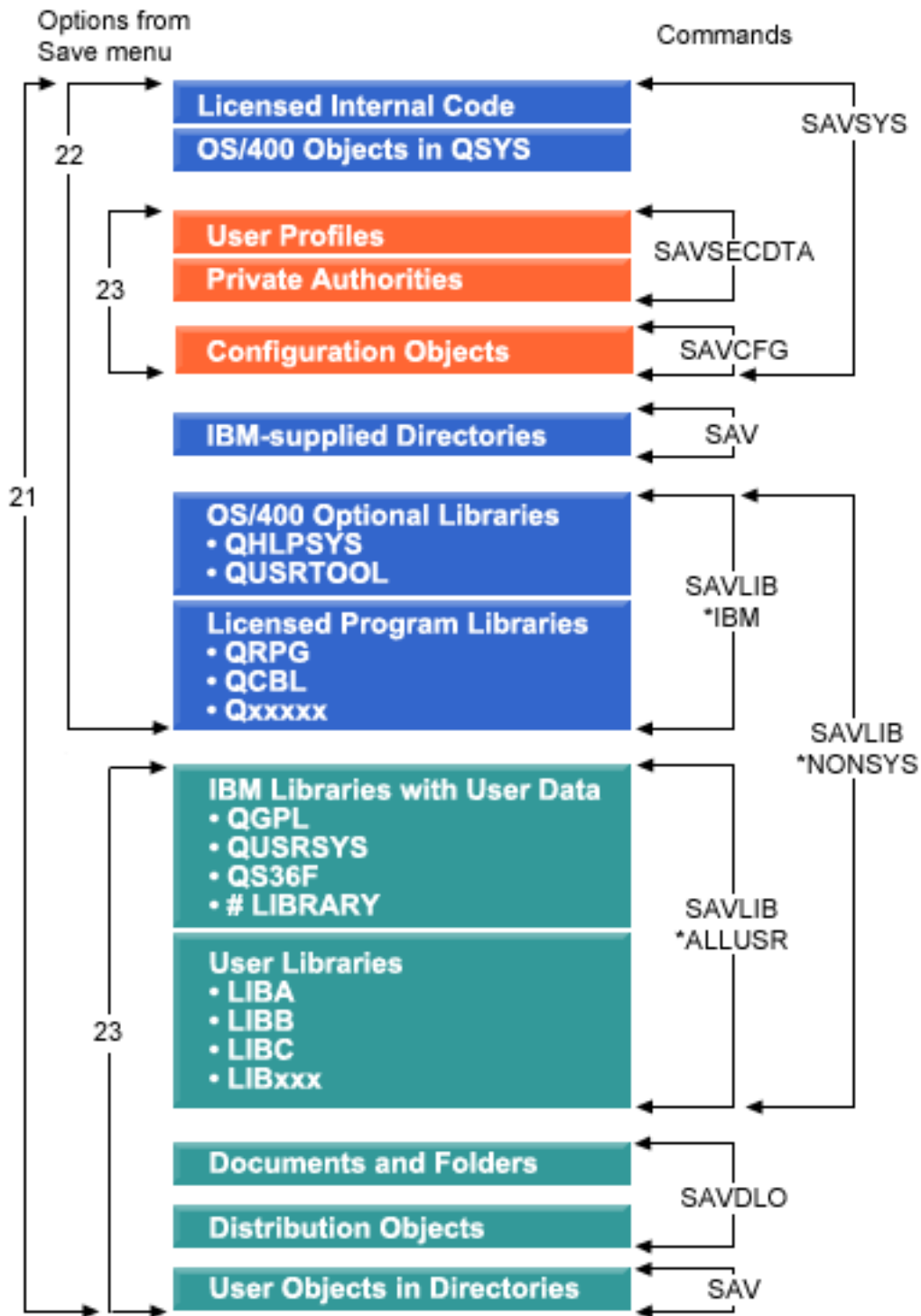

Figure 1. Save commands and menu options

The following information provides an overview and procedures on how to use menu options of the GO SAVE command:

- Overview of the GO SAVE command menu options explains how to start the GO SAVE command and provides more information on the various GO SAVE options.

- Customize your GO SAVE backup instructions allows you to create a list of GO SAVE steps tailored to your save environment.
- View entire GO SAVE checklist provides you with all of the steps for a GO SAVE operations. Some of the steps may not apply to your environment.

## Overview of the GO SAVE command menu options

Access the GO SAVE command menu by typing GO SAVE from any command line. From the Save menu, you see option 21, option 22, and option 23 along with many more save options. A single plus sign (+) indicates that the option places your server into a restricted state, which means that nothing else can be running on your system when the menu option is selected. A double plus sign (++) indicates that your server must be in a restricted state before you can run this option.

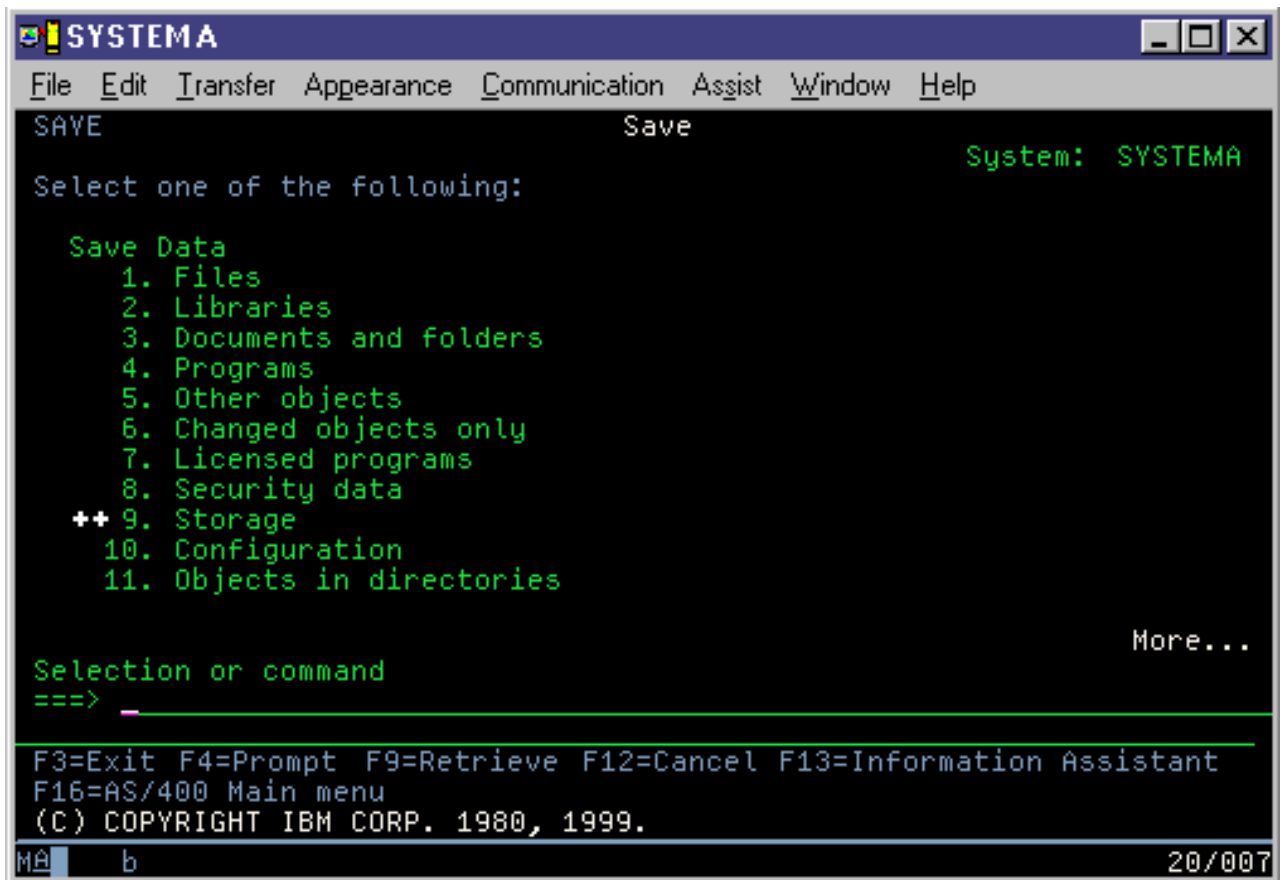

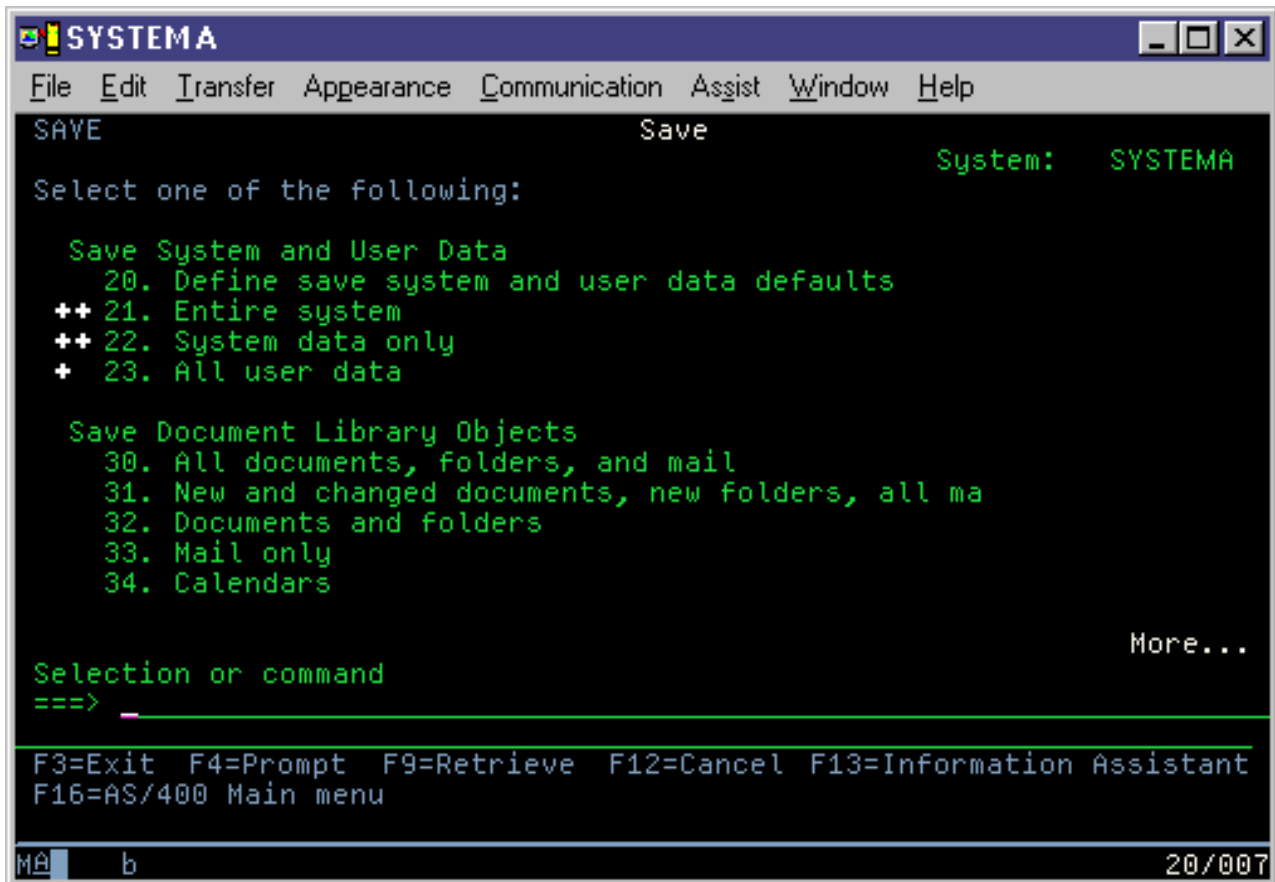

## Save your entire server with GO SAVE: Option 21

Option 21 saves everything on your server and allows you to perform the save while you are not there.

Option 21 saves all of your data for additional licensed programs, such as Domino® or iSeries Integration for Windows® Server when you select to vary off your network servers. Also, if you have Linux installed on a secondary logical partition, you can back up that partition when you select to vary off your network servers.

Option 21 puts your server into a restricted state. This means that when the save begins, no users can access your server and the backup is the only thing that is running on your server. It is best to run this option overnight for a small server or during the weekend for larger servers. If you schedule an unattended save, make sure your server is in a secure location; after you schedule the save, you will not be able to use the workstation where the backup is initiated until the save is complete.

**Note:** If you are saving information on independent ASPs (also called independent disk pools in iSeries Navigator), make sure that you have varied on the independent ASPs that you want to save before using Option 21. For more information about independent ASPs, see the iSeries Information Center at <http://www.ibm.com/eserver/series/infocenter>.



Option Number	Description	Commands
21	Entire server (QMNSAVE)	<pre> ENDSBS SBS(*ALL) OPTION(*IMMED) CHGMSGQ MSGQ(QSYSOPR) DLVRY(*BREAK or *NOTIFY) SAVSYS SAVLIB LIB(*NONSYS) ACCPTH(*YES) SAVDLO DLO(*ALL) FLR(*ANY) SAV DEV('/QSYS.LIB/media-device-name.DEVD') +       OBJ(('/*') ('/QSYS.LIB' *OMIT) +         ('/QDLS' *OMIT))<sup>1</sup> UPDHST(*YES) STRSBS SBSD(controlling-subsystem) </pre>

<sup>1</sup>The command omits QSYS.LIB file system because the SAVSYS command and the SAVLIB LIB(\*NONSYS) command both save it. The command omits the QDLS file system because the SAVDLO command saves it.

View entire GO SAVE checklist provides you with step-by-step instructions on how to save your entire server with menu option 21 of the GO SAVE command.

---

## View entire GO SAVE checklist

Use this checklist to perform a complete save.

Use the following checklist for menu options 21, 22, and 23 of the GO SAVE command. When appropriate, select the option that you require. If you choose to, you can print system information during the procedure. Otherwise, Printing system information contains detailed instructions on how to print system information if you do not want the Save menu option command to print your system information automatically.

Some of the steps in this checklist may not apply to your system configuration. See Identify optional features that affect your backup for help to determine whether you use optional features in your environment. If you are still unsure how your system is configured, contact your system administrator.

As an alternative to this checklist, use Customize your GO SAVE backup in the iSeries Information Center at <http://www.ibm.com/eserver/iseries/infocenter> to produce a set of instructions that is tailored to your save environment.

**Attention:** If you are using the Hardware Management Console for eServer™ (HMC), you must back up the HMC in addition to using the GO SAVE: Option 21 to obtain a complete save of your system. See Backing up and restoring the HMC the iSeries Information Center at <http://www.ibm.com/eserver/iseries/infocenter>.

1. Sign on with a user profile that has \*SAVSYS and \*JOBCTL special authorities, and also has sufficient authority to list different types of server resources. (The QSECOFR user profile contains all of these authorities.) This ensures that you have the authority that you need to place the server in the necessary state and to save everything.
2. Virtual images can significantly increase the time it takes to complete an Option 21 save operation, even if the image catalog entries do not contain data. If you want to exclude virtual images from a full system save, use one of the following strategies:
  - Use the Change Attribute (CHGATR) command to mark the image catalog directory as non-saveable. For example:  
CHGATR OBJ('/MYINFO') ATR(\*ALWSAV) VALUE(\*NO)
  - Use the Load Image Catalog (LODIMGCLG) command to make the image catalog ready. Image catalogs with a ready status will be omitted from the save.
  - In an attended save, you can specify to omit the image catalog directories on the Save Object (SAV) command.
3. If you have independent ASPs, make them available before ending iSeries Navigator if you want them to be included in an Option 21 or 23 save.

**Note:** If your server includes independent ASPs that are geographically mirrored, it is recommended that you eliminate them from this GO SAVE option by making them unavailable. You should save independent ASPs that are geographically mirrored separate from this GO SAVE operation. If the geographically mirrored ASPs remain available during the GO SAVE operation, geographic mirroring is suspended when the system becomes restricted. When you resume mirroring after the save, a complete synchronization is required. Synchronization can be a very lengthy process.

For more information see Independent disk pools the iSeries Information Center at <http://www.ibm.com/eserver/iseries/infocenter>.

4. If you are operating in a clustered environment and want to save independent ASPs without causing a failover, or you want to save the cluster environment for a node, you must end the device cluster resource group and end clustering before you end subsystems.

Use the End Cluster Resource Group ENDCRG command and the End Cluster Node NeENDCLUNOD command. For more information, refer to the online help in the Simple Cluster Management utility or see Clusters.

5. If you have OptiConnect controllers, vary them off prior to the save operation. You must vary off OptiConnect controllers before ending subsystems and performing a save of the entire server, or before any save that ends the QSOC subsystem. If you do not vary off OptiConnect controllers before ending subsystems, they go into a failed status, the server marks them as damaged, and the server does not save them. For more information, see Networking for logical partitions the iSeries Information Center at <http://www.ibm.com/eserver/iseries/infocenter>.
6. If you have IBM WebSphere MQ for iSeries, V5.3 (5724-B41), you need to quiesce WebSphere MQ, V5.3 before you save the server. The MQSeries® for i5/OS Administration, GC33–1356 book has instructions for quiescing WebSphere MQ, V5.3.
7. If you plan to run the save procedure immediately, make sure that no jobs are running on the server: type WRKACTJOB .

If you plan to schedule the save procedure to run later, send a message to all users informing them when the server will be unavailable.

8. Type GO SAVE at a command prompt to display the Save menu.
9. To perform an attended save of your server, go to step 11.
10. To perform an unattended save operation, continue with the following steps. An unattended save operation prevents your save operation from stopping because of unanswered messages:
  - a. Display the reply list sequence numbers to find what numbers are available for use:  
WRKRPYLE
  - b. If MSGID(CPA3708) is not already in your reply list, add it. For *xxxx*, substitute an unused sequence number from 1 through 9999:  
ADDRPYLE SEQNBR(*xxxx*) +  
MSGID(CPA3708) +  
RPY('G')
  - c. If you are using virtual media for your save media, specify automatic load in the reply list, MSGID(OPT149F), to avoid receiving a message that interrupts the unattended save. If necessary, virtual optical will use the autoloading feature to create additional images with the same capacity as the last image you loaded, provided the disk storage is available.
  - d. Change your job to use the reply list and to notify you of any break messages that are sent:  
CHGJOB INQMSGRPY(\*SYSRPYL) BRKMSG(\*NOTIFY)

**Note:** You can also set up a default so that whenever you select menu options 21, 22, or 23, the server will always use the reply list. To set up the default, select menu option 20 from the Save menu. Specify Yes on the Use system reply list option.

11. Select the option (21, 22, or 23) from the Save menu and press the Enter key.  
A prompt display describes the function of the menu option that you selected.

12. After reading the **Specify Command Defaults** prompt display, press the Enter key to continue.

```

Specify Command Defaults
Type choices, press Enter.
Devices . . . . . TAP01      Names
                _____
                _____
                _____
Prompt for commands . . . . . Y      Y=Yes, N=No
Check for active file . . . . . Y      Y=Yes, N=No
Message queue delivery . . . . *BREAK  *BREAK, *NOTIFY
Start time . . . . . *CURRENT *CURENT, time
Vary off network servers . . . *ALL    *NONE, *ALL
Unmount file systems . . . . . Y      Y=Yes, N=No

```

```

Specify Command Defaults
Type choice, press Enter.
Print system information . . . . N      Y=Yes, N=No
Use system reply list . . . . . N      Y=Yes, N=No
Spooled file data . . . . . *NONE  *NONE, *ALL

```

13. Type your choices for the *Devices* prompt. You can specify as many as four tape media device names. If you specify more than one device, the server automatically switches to the next tape device when the current tape is full. You may select only one DVD-RAM optical media device.

The first device for options 21 and 22 should be your alternate IPL device. If you are creating media to install on another server, the device must be compatible with the alternate IPL device for that server. This ensures that the server can read the SAVSYS media if you need to restore your Licensed Internal Code and the operating system.

14. Type your choice for the *Prompt for commands* prompt. Specify N (No) if you want to run an unattended save. Specify Y (Yes) if you want to change the defaults on the SAVxxx commands.

**Note:** If Y is specified to change the LABEL parameter for save commands, Y must be specified if you use this media to restore the server.

15. Type your choice for the *Check for active files* prompt. Specify Y (Yes) if you want the server to warn you if active files exist on the save media. The warning you receive gives the following choices:

- Cancel the save operation.
- Insert new media and try the command again.
- Initialize the current media and try the command again.

**Note:** If you use DVD-RAM optical media for your save, the server sends inquiry messages to the QSYSOPR message queue when it encounters identical active files. The server sends the inquiry message for each identical active file that it finds. See *Optical media* or *Storage Solutions* in *iSeries Information Center* at <http://www.ibm.com/eserver/series/infocenter>.

Specify N (No) if you want the server to write over any active files on the save media without warning you.

16. Type your choice for the *Message queue delivery* prompt. Specify \*NOTIFY if you want to do an unattended save. This prevents communications messages from stopping the save operation. If you specify \*NOTIFY, severity 99 messages that are not associated with the save operation are sent to the QSYSOPR message queue without interrupting the save process. For example, messages that request a new volume be loaded interrupt the save operation because they are associated with the job. You cannot continue until you reply to these messages.

Specify \*BREAK if you want to be interrupted for severity 99 messages that require a reply.

17. Type your choice for the *Start time* prompt. You may schedule the start of the save operation up to 24 hours later. For example, assume that the current time is 4:30 p.m. on Friday. If you specify 2:30 for the start time, the save operation begins at 2:30 a.m. on Saturday.

**Note:**

- a. The server uses the Delay Job (DLYJOB) command to schedule the save operation. Your workstation will be unavailable from the time you request the menu option until the save operation completes.
  - b. **Make sure that your workstation is in a secure location.** Your workstation remains signed on, waiting for the job to start. If the server request function is used to cancel the job, your workstation displays the Save menu. The workstation remains signed on with your user profile and your authority.
  - c. Make sure that the value for the QINACTITV system value is \*NONE. If the value for QINACTITV is other than \*NONE, the workstation will vary off in the amount of time specified. If you changed the value to \*NONE, write the old value down.
  - d. If you specify a delayed start and want your save operation to run unattended, be sure you have done the following:
    - Set up the system reply list.
    - Specified \*NONE on QINACTITV system value.
    - Specified \*NOTIFY on message queue delivery.
    - Specify \*NOTIFY for any break messages.
    - Responded N to the *Prompt for commands* prompt.
    - Responded N to *Check for active files*.
18. Type your choice for the *Vary off network servers* prompt. If you use iSeries Integration for Windows Server, you may vary off the network server descriptions before beginning the save procedure. The Information Center provides additional information about the effects of varying off the network servers. Select one of the following options to specify which network servers should be varied off before the save operation is performed:

**\*NONE**

Does not vary off network servers. The save operation will take longer since the network server data will be saved in a format that allows restoration of individual objects.

**\*ALL**

Varies off all network servers. The save operation will take less time but the network server data will not be saved in a format that allows restoration of individual objects. You will only be able to restore all of the data from the network servers.

19. Type your choice for the *Unmount file system* prompt. If you use user-defined file systems (UDFSs), you should unmount the UDFSs before beginning the save procedure. Specify Y (Yes) if you want to allow all dynamically mounted file systems to be unmounted. This allows you to save UDFSs and their associated objects. IBM recommends that you unmount your UDFSs for recovery purposes. For

more information on UDFSs, refer to  i5/OS Network File System Support, SC41-5714-03.

**Note:** After the save operation completes, the server will not attempt to remount the file systems.

Specify N (No) if you do not want all dynamically mounted file systems to be unmounted. If you specify N, and you have mounted UDFSs, you will receive a CPFA09E message for each mounted UDFS. The objects in the mounted UDFS will be saved as if they belong to the mounted over file system.

20. Type your choice for the *Print system information* prompt. Specify Y (Yes) if you want to print the system information. The system information may be useful for disaster recovery. Printing system information explains how to print your system information manually without using the automatic GO SAVE command menu option function.
21. Type your choice for the *Use system reply list* prompt. Specify Y (Yes) if you want to use the system reply list when the server sends an inquiry message.
22. Type your choice for the *Spooled file data* prompt. Specify \*NONE if you do not want to save spooled files or \*ALL to save spooled files.

**Note:** Saving spooled files may require more save media and will take additional time.

23. Press the Enter key. If you chose a later start time, your display shows message CPI3716. The message tells when the save operation was requested and when it will start. You cannot use the display until the save operation completes. The input-inhibited indicator should appear. You have completed the steps for setting up the save operation.

If you did not choose a later start time, continue with step 23. **If the value for QSYSOPR message queue delivery is \*BREAK with a severity level of 60 or lower, you must respond to the ENDSBS messages. This is true even if you plan to run an unattended save operation specifying a start time of \*CURRENT.**

24. If you responded Y to the system prompt, Prompt for commands, the End Subsystem display appears. Type any changes and press the Enter key. While the server is ending subsystems, you see the following messages. You must respond to them if the QSYSOPR message queue is set to \*BREAK with a severity level of 60 or lower. Each message appears at least twice. Press the Enter key to respond to each message.
  - a. CPF0994 ENDSBS SBS(\*ALL) command being processed
  - b. CPF0968 System ended to restricted condition

If you responded N to the *Prompt for commands* prompt, skip to step 25.

25. When the server is ready to perform each major step in the save operation, you are shown the prompt display for that step. The time between prompt displays may be quite long.

For option 21 (Entire system) these prompt displays appear:

```
ENDSBS SBS(*ALL) OPTION(*IMMED)
SAVSYS
SAVLIB LIB(*NONSYS) ACCPTH(*YES)
SAVDLO DLO(*ALL) FLR(*ANY)
SAV DEV('/QSYS.LIB/media-device-name.DEVD') +
  OBJ((/*) ('/QSYS.LIB' *OMIT) +
    ('/QDLS' *OMIT)) +
  UPDHST(*YES)
STRSBS SBSD(controlling-subsystem)
```

For option 22 (System data only) these prompt displays appear:

```
ENDSBS SBS(*ALL) OPTION(*IMMED)
SAVSYS
SAVLIB LIB(*IBM) ACCPTH(*YES)
SAV DEV('/QSYS.LIB/media-device-name.DEVD') +
  OBJ(('QIBM/ProdData') +
    ('QOpenSys/QIBM/ProdData')) +
  UPDHST(*YES)
STRSBS SBSD(controlling-subsystem)
```

For option 23 (All user data) these prompt displays appear:

```
ENDSBS SBS(*ALL) OPTION(*IMMED)
SAVSECDTA
SAVCFG
```

```

SAVLIB LIB(*ALLUSR) ACCPTH(*YES)
SAVDLO DLO(*ALL) FLR(*ANY)
SAV DEV('/QSYS.LIB/media-device-name.DEV'D') +
  OBJ('//*') ('/QSYS.LIB' *OMIT) +
  ('/QDLS' *OMIT) +
  ('/QIBM/ProdData' *OMIT) +
  ('/QOpenSys/QIBM/ProdData' *OMIT)) +
  UPDHST(*YES)
STRSBS SBSB(controlling-subsystem)

```

Type your changes at each prompt display and press the Enter key.

26. When the server sends a message that asks you to load the next volume, load the next media and respond to the message. For example, if the message is the following, load the next volume and then enter R to retry (C cancels the operation):

```

Device was not ready or next volume was
not loaded (C R)

```

**If a media error occurs**

**Note:**

If an unrecoverable media error occurs during the SAVLIB procedure, see How to recover from a media error during a SAVLIB operation in the iSeries Information Center at <http://www.ibm.com/eserver/series/infocenter>. You can find this subject under the Backing up your server topic in the Information Center.

27. You should mount all other user-defined file systems at this point if you unmounted them for the save operations.
28. Change the QINACTITV system value back to its original value. You wrote this value down in step 17 c.
29. When the save operation completes, print the job log. It contains information about the save operation. Use it to verify that the operation saved all objects. Type one of the following:  

```
DSPJOBLOG * *PRINT
```

Or

```
SIGNOFF *LIST
```

You have completed the save operation. Make sure that you mark all of your media and store it in a safe, accessible place.
30. If you ended clustering before running the save operation, restart clustering on the save node from a node where clustering is already active.  

For more information, refer to the online help in the Simple Cluster Management utility or see Clusters in the iSeries Information Center at <http://www.ibm.com/eserver/series/infocenter>.
31. Now restart the device cluster resource group to enable resiliency.
32. When your independent disk pool was saved, the Qdefault.UDFS was unmounted, if you chose to unmount file systems. In order to use the independent disk pool again, remount Qdefault.UDFS. Do this step for each independent disk pool that you saved.  

```
TYPE(*UDFS) MOUNT MFS('/dev/iasp_name/Qdefault.UDFS') MTOVRDIR('/iasp-name')
```

---

## Identify optional features that affect your backup

### Do you use user-defined file systems on this system?

A user-defined file system (UDFS) is a file system that a user creates and manages. To determine if you have any UDFS on your system, use one of the following methods:

## Using iSeries Navigator

Using **iSeries Navigator** expand your server **File Systems** → **Integrated File System** → **Root** → **dev** → **QASPxx** or select the name of an independent disk pool. If UDFS objects exist, they will appear in the right-hand pane.

## Using the character-based interface

1. At a command line, specify `wrklnk '/dev'` .
2. On the Work with Object Links screen, select option 5 to display the contents of the dev directory.
3. Locate object links beginning with QASPxx or the name of an independent disk pool, and select Option 5 to display the UDFS within the auxiliary storage pool (ASP).

## Do you use virtual storage?

Virtual media simulates tape, CD or DVD images that are stored directly on your server disk units. To determine if you store virtual images in image catalogs, do the following:

1. At a command line, specify `WRKIMGCLG`.

**Note:** The Work with Image Catalogs (WRKIMGCLG) window displays the name of the image catalog, the status, and the virtual type.

## Do you use independent disk pools?

An independent disk pool is a collection of disk units that can be brought online or taken offline independent of the rest of the storage on a system. If you have the necessary authority, you can check whether independent disk pools are configured on your system. Using **iSeries Navigator** expand your server **Configuration and Service** → **Hardware** → **Disk Units** → **Disk pools** folder. Independent disk pools are numbered 33-255.

## Have you configured independent disk pools to switch between systems in a cluster

An iSeries cluster is a collection or group of one or more servers or logical partitions that work together as a single server. If you have the required authority you can check to see if your independent disk pool is switchable between systems in a cluster.

1. Using **iSeries Navigator** expand your server **Configuration and Service** → **Hardware** → **Disk Units** → **Disk pools**
2. Independent disk pool are numbered somewhere between 33 and 255. Right-click the independent disk pool and select **Properties**.
3. On the **Disk Pool Properties** page the General tab displays the field **Switchable: Yes** if you have configured your independent disk pool to switch between systems.

## Do you use WebSphere MQ, V5.3 on this system?

The IBM WebSphere MQ for iSeries, V5.3, licensed program provides application programming services that enable you to code indirect program-to-program communications that use message queues. This allows programs to communicate with each other independently of their platforms, for example, between OS/390(R) and i5/OS(R).

To check whether you have installed WebSphere MQ, or V5.3 use one of the following methods:

## Using iSeries Navigator

Using **iSeries Navigator** expand your server **Configuration and Service** → **Software** → **Installed Products**. WebSphere MQ, V5.3, is product 5724b41, IBM WebSphere MQ for iSeries

## Using the character-based interface

1. At a command line, specify GO LICPGM.
2. Specify option 10 to display installed licensed programs.
3. If WebSphere MQ for iSeries is installed, 5724B41 appear in the Description column of one of the 5722SS1 lines.
4. If MQ is installed, the Work with Queue Managers (WRKMQM) command allows you to see if you have configured any queue managers.

## Do you use OptiConnect controllers?

OptiConnect is the iSeries system area network that provides high-speed interconnectivity between multiple iSeries systems in a local environment.

To check whether you have installed OptiConnect, use one of the following methods:

## Using iSeries Navigator

Using **iSeries Navigator** expand your server **Configuration and Service** → **Installed Products** → **Software**. OptiConnect is option 0023 of product 5722-ss1, i5/OS - OptiConnect.

## Using the character-based interface

1. At a command line, specify GO LICPGM.
2. Specify option 10 to display installed licensed programs.
3. If OptiConnect is installed, OptiConnect will appear under the Description column for Licensed Program 5722SS1.

## Do you use network servers?

Network servers enable you to run other operating systems on your iSeries server. Examples of network servers include running Windows operating systems using iSeries Integration for Windows Server, or running Linux in a guest partition.

## Do you use the Hardware Management Console for eServer?

If you have an eServer 5xxx, your server may be equipped with a Hardware Management Console (HMC). An HMC is required if you use capacity on demand or logical partitions.

---

## Printing system information

Printing the system information provides valuable information about your server that will be useful during a system recovery. It is especially useful if you cannot use your SAVSYS media to recover and must use your distribution media. Printing this information requires \*ALLOBJ, \*IOSYSCFG, and \*JOBCTL authority and produces many spooled file listings. You may not need to print this information every time you perform a backup. However, you should print it whenever important information about your server changes.



1. Print your current disk configuration. This is essential if you plan to do a model upgrade and you are using mirrored protection. This information is also vital if you need to recover an independent ASP. Do the following:
  - a. Sign on with a user profile that has \*SERVICE special authority.
  - b. Type STRSST on a command line and press the Enter key.
  - c. Specify the service tools user ID and service tools password. These are case-sensitive.
  - d. Select option 3 **Work with disk units** on the System Service Tools (SST) display.
  - e. Select option 1 **Display disk configuration** on the Work with Disk Units display.
  - f. Select option 3 **Display disk configuration protection** on the Display Disk Configuration display.
  - g. Print the displays there may be several using the PRINT key for each display.
  - h. Press F3 until you see the Exit System Service Tools display.
  - i. On the Exit System Service Tools display, press the Enter key.
2. If you are using logical partitions, print the logical partition configuration information.
  - a. From the primary partition, type STRSST on a command line and press Enter.
  - b. If you are using SST, select option 5 **Work with system partitions**, and press Enter. If you are using DST, select option 11 **Work with system partitions**, and press Enter.
  - c. From the Work With System Partitions menu, select option 1 **Display partition information**.
  - d. To display all system I/O resources from the Display Partition Information menu, select option 5.
  - e. At the Level of detail to display field, type \*ALL to set the level of detail to ALL.
  - f. Press F6 to print the system I/O configuration.
  - g. Select option 1 and press Enter to print to a spooled file.
  - h. Press F12 to return to the Display Partition Information menu.
  - i. Select option 2 **Display partition processing configuration**.
  - j. From the Display Partition Processing Configuration display, Press F6 to print the processing configuration.
  - k. Press F12 to return to Display Partition Information display.
  - l. Select option 7 **Display communications options**.
  - m. Press F6 to print communication configuration.
  - n. Select option 1 and press Enter to print to a spooled file.
  - o. Return to a command line and print these three spooled files.
3. If you are operating in a clustered environment, print the cluster configuration information. Use the following commands to print cluster information:
  - a. Display Cluster Information — DSPCLUINF DETAIL(\*FULL) OUTPUT(\*PRINT)
  - b. Display Cluster Resource Group — DSPCRGINF CLUSTER(*cluster-name*) CRG(\*LIST) OUTPUT(\*PRINT)
4. If you have independent ASPs configured, record the relationship between the independent ASP name and number. You can find this information in iSeries Navigator. In the Disk Units folder, select Disk Pools.
5. Sign on with a user profile that has \*ALLOBJ special authority, such as the security officer. The server lists information only if you have the proper authority. If you sign on as a user with less than \*ALLOBJ authority, some of the listings in these steps may not be complete. You must also be enrolled in the system directory before you can print a list of all the folders on the server.
6. If you use the history log or if you have a requirement to keep it, do the following:
  - a. Display the system log QHST. This automatically brings it up to date. Type:  
 DSPLOG LOG(QHST) OUTPUT(\*PRINT)
  - b. Display all copies of the system log:  
 WRKF FILE(QSYS/QHST\*)

Look at the list to verify that you saved all copies of the log that you may need later.

**Note:** The history (QHST) log contains information such as date created, and the last change date and time. To get more information about the history (QHST) log, select option 8 (Display file description) on the Work with Files display.

- c. To prevent confusion about the date of the log, select the Delete option on the Work with Files display. Delete all but the current copies of the system log. This step improves the performance of the SAVSYS command.
7. Print the system information. You can do this by two different methods:
- a. Using the GO SAVE command, on the Specify Command Defaults display, select Y at the *Print system information* prompt.
  - b. Use the PRTSYSINF command.

The following table describes the spooled files that the server creates. The PRTSYSINF command does not create empty spooled files. If some objects or types of information do not exist on your server, you may not have all of the files listed below.

Table 1. Spooled Files Created by the server

Spooled File Name	User Data	Description of Contents
QPEZBCKUP	DSPBCKUPL	List of all user libraries
QPEZBCKUP	DSPBCKUPL	List of all folders
QSYSPRT	DSPSYSVAL	Current settings for all system values
QDSPNET	DSPNETA	Current settings for all network attributes
QSYSPRT	DSPCFGL	Configuration lists
QSYSPRT	DSPEDTD	User-defined edit descriptions ( a separate spooled file for each)
QSYSPRT	DSPPTF	Details of all fixes that are installed on your server
QPRTRPYL	WRKRYPLE	All reply list entries
QSYSPRT	DSPRCYAP	Settings for access path recovery times
QSYSPRT	DSPSRVA	Settings for service attributes
QSYSPRT	DSPNWSSTG	Network server storage spaces information
QSYSPRT	DSPPWRS CD	Power on/off schedule
QSYSPRT	DSPHDWRSC	Hardware configuration reports (a separate spooled file for each resource type, such as *CMN or *LWS)
QSYSPRT	WRKOPTCFG	Optical device descriptions (if your server has an optical device and optical support is started when you run the command)
QSYSPRT	DSPRJECFG	Remote job entry configurations
QPDSTSRV	DSPDSTSRV	SNADS configuration
QPRTSBSD	DSPSBSD	Subsystem descriptions (a separate spooled file for each subsystem description on your server)
QSYSPRT	DSPSFWRSC	Installed licensed programs (Software Resources List)
QPRTOBJD	DSPOBJD	A list of all the journals on your server
QPDSPJNA	WRKJRNA	The journal attributes for each journal that is not in the QUSRSYS library (a separate file for each journal). Typically, journals in the QUSRSYS library are IBM-supplied journals. If you have your own journals in the QUSRSYS library, you need to manually print information about those journals.
QSYSPRT	CHGCLNUP	Settings for automatic cleanup
QPUSRPRF	DSPUSRPRF	Current values for the QSECOFR user profile

Table 1. Spooled Files Created by the server (continued)

Spooled File Name	User Data	Description of Contents
QPRTJOB	DSPJOB	Current values for the QDFTJOB job description
QPJOBLOG	PRTSYSINF	The job log for this job <sup>1</sup>
<sup>1</sup> On your server, this spooled file might be in the QEZJOBLOG output queue.		

8. Print a list of directories in the root directory.  
`DSPLNK OBJ('//*') OUTPUT(*PRINT)`
9. Print any IBM-supplied objects that you have modified, such as the QSYSPRT print file.
10. If you maintain a CL program that contains your configuration information, use the Retrieve Configuration Source (RTVCFGSRC) command to ensure that the CL program is current.  
`RTVCFGSRC CFGD(*ALL) CFGTYPE(*ALL) +  
SRCFILE(QGPL/QCLSRC) +  
SRCMBR(SYSCFG)`
11. Print these spooled files. Keep this information with your backup log or your save system media for future reference. If you choose not to print the lists, use the Copy Spooled File (CPYSPLF) command to copy them to database files. See Save spooled files for information on how to do this. Make sure that the database files are in a library that is saved when you perform the Save menu option.

---

## Save Considerations When Checking Out Objects

If you use iSeries Navigator or the Check Out Objects (CHKOUT) command to check out objects to a specific user, you should check these objects back in before performing the save. When an object is checked out to a user, other users can read the object, but they cannot update the object. If an object remains checked out during a save that specifies update history UPDHST(\*YES), message CPFA09E is sent for the object, because the update history function is unable to change the attributes for the object.

---

## Tape Write Error Recovery

Tape write error recovery refers to an attempt to recover from a write media error and continue a save on another volume. In order to rewrite the data that was sent to the tape drive but was never written to the media because it was still in the drive buffer when the media error occurred, a large amount of data needs to be tracked in main store. The amount of data that needs to be tracked can become very large and consume significant memory resource. The newer tape devices contain a large data buffer (128MB or larger) which along with data compaction on the order of 3::1 can result in over 384MB of data that needs to be tracked to be able to recover from media errors.

You may encounter performance problems if you use tape write error recovery because of the memory required to track data plus some limits for how much data can actually be tracked for each tape drive. Because of the potential save performance impacts, tape write error recovery is not enabled as a default. Tape write error recovery needs to be enabled if you want to use it.

### Enabling and Disabling Tape Write Error Recovery

Tape write error recovery can be enabled by creating a data area in either library QTEMP or QUSRSYS with the same name as the device description to be used for the save operations. The data area needs to be created as TYPE(\*CHAR) with a length of at least 128 bytes. Change the character at position 20 to a 'Y' to enable tape write error recovery or 'N' to disable write error recovery. Creating the data area in library QTEMP will cause tape write error recovery to only be used for saves done by the job creating the data area in its QTEMP library. Creating the data area in library QUSRSYS will cause the tape write error recovery setting to be used by all saves that use the device for which the data area is created. The operating system first checks for a data area in QTEMP, so tape write error recovery can still be enabled or disabled for a particular job even if a data area exists in library QUSRSYS.

Example: Enabling Tape Write Error Recovery  
 CRTDTAARA DTAARA(QTEMP/TAPMLB01) TYPE(\*CHAR) LEN(128)  
 CHGDTAARA DTAARA(QTEMP/TAPMLB01 (20 1)) VALUE('Y')

Example: Disabling Tape Write Error Recovery  
 CHGDTAARA DTAARA(QTEMP/TAPMLB01 (20 1)) VALUE('N')

## Using the OptiConnect Function

OptiConnect is a set of CL commands for moving objects between iSeries servers simply and efficiently. OptiConnect is included with the operating system. You install it by selecting it on the Install Licensed Program display.

When you use an OptiConnect command, the system moves the object directly to the target system without using save files or distribution queues. OptiConnect provides better performance than other methods for moving objects between systems, and OptiConnect does not require additional disk space to store an intermediate copy of the object that is being moved.

OptiConnect commands are closely related to the SAVxxx and RSTxxx commands. The OptiConnect commands support most of the same parameters. Table 2 shows a list of the OptiConnect commands and the associated iSeries save and restore commands. “Using the ObjectConnect Commands” on page 21 describes the functions that are performed by each command. The online command help describes the parameters for each command.

Table 2. OptiConnect and Associated iSeries Save and Restore Commands

OptiConnect Commands	iSeries Save and Restore Commands
Save/Restore Integrated File System (SAVRST)	Save (SAV), Restore (RST)
Save/Restore Object (SAVRSTOBJ)	Save Object (SAVOBJ), Restore Object (RSTOBJ)
Save/Restore Changed Object (SAVRSTCHG)	Save Changed Object (SAVCHGOBJ), Restore Object (RSTOBJ)
Save/Restore Library (SAVRSTLIB)	Save Library (SAVLIB), Restore Library (RSTLIB)
Save/Restore Document Library Object (SAVRSTDLO)	Save Document Library Object (SAVDLO), Restore Document Library Object (RSTDLO)
Save/Restore Configuration (SAVRSTCFG)	Save Configuration (SAVCFG), Restore Configuration (RSTCFG)

To use the OptiConnect functions, you must have OptiConnect installed on both the source and target systems. The systems must be connected with one of the following methods:

- Local area network (LAN) or remote communications line with APPC and APPN\*.
- Local area network (LAN) or remote communications line with TCP/IP with AnyNet\* support.
- Fiber optic bus with OptiConnect.

## Components of OptiConnect

The basic components of OptiConnect are outlined below:

Component	Description
QSR library	This library contains all OptiConnect objects.
QCMN subsystem	If the source and target systems are connected with a communications line or a LAN, OptiConnect jobs run in the QCMN subsystem.
QSOC subsystem	If the source and target systems are connected with OptiConnect, OptiConnect jobs run in the QSOC subsystem.

Component	Description
QSOCCT mode description	OptiConnect uses the IBM-supplied default mode description, QSOCCT. You must start this mode description before you use OptiConnect commands by specifying the following: STRMOD RMTLOCNAME( <i>target</i> ) MODE(QSOCCT) LCLLOCNAME(*NETATR) RMTNETID(*NETATR)
QUSER user profile	This IBM-supplied user profile is used by OptiConnect jobs.

## Setting Up Your System to Use OptiConnect

After you have installed OptiConnect, you must set up your systems to run OptiConnect. You perform some tasks only once. You perform other tasks regularly to prepare for OptiConnect commands.

**Do These Things Initially:** If your systems are connected with a communications line or a LAN, add a communications entry to the QCMN subsystem. Type the following on both systems:

```
ADDCMNE SBSD(QCMN) DEV(*ALL) DFTUSR(QUSER)
        MODE(QSOCCT)
```

If you are using a fiber-optic bus, see *OptiConnect* in the information center.

**Do These Things Before You Run OptiConnect Commands:** Whenever you start your system, you must also start the OptiConnect environment. You can include these tasks in your startup procedures, or you can perform them manually.

If your systems are connected with a communications line or a LAN, do the following:

- Ensure that the QCMN subsystem is started.
- Ensure that the connection is varied on and active.
- Start the mode description by typing the following:

```
STRMOD RMTLOCNAME(target) MODE(QSOCCT)
        LCLLOCNAME(*NETATR) RMTNETID(*NETATR)
```

## How the System Runs an ObjectConnect Command

When you issue an OptiConnect command, the system starts an OptiConnect job and establishes a conversation with the target system. Figure 2 on page 20 shows the flow of the job:

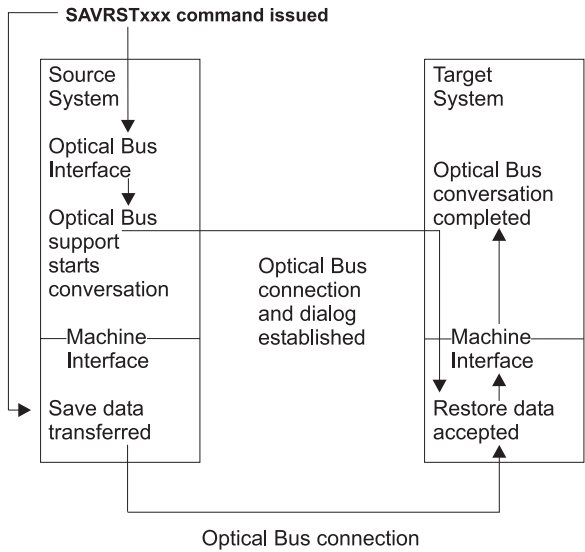

RBANS507-0

Figure 2. OptiConnect Job Flow

You can view the ObjectConnect job by working with the subsystem. Type WRKACTJOB SBS(QCMN) if your systems are linked with communications support. Type WRKACTJOB SBS(QSOC) if your systems are linked with OptiConnect. You are shown the Work with Active Jobs display:

```

Work with Active Jobs                                AS009
                                                    03/31/95
CPU % .0  Elapsed time: 00:00:00      Active Jobs 60

Type options, press Enter.
 2=Change 3=Hold 4=End 5=Work with 6=Release 7=Display messages
 8=Work with spooled files 13=Disconnect ...

Opt Subsystem/Job  User      Type  CPU %  Function      Status
-   QCMN          QSYS      SBS    .0      DEQW          DEQW
-   ENDCTL1      QCMN      BCH    .0      DEQW          DEQW
-   RCHCTL2      QCMN      ASJ    .0      PGM-QYYCMGR  DEQW

```

You can use the Work with Configuration Status (WRKCFGSTS) command to see the activity on the communications or LAN link:

```

Work with Configuration Status                      AS009
                                                    03/31/95
Position to . . . . . _____ Starting characters

Type options, press Enter.
 1=Vary on  2=Vary off  5=Work with job  8=Work with description
 9=Display mode status ...

Opt  Description      Status      -----Job-----
-   WVGLOCAL         ACTIVE
-   WVGLOC1          ACTIVE
-   QSOCCT           ACTIVE/DETACHED  QPADEV0023  GREEN
-   QSOCCT           ACTIVE/SOURCE    QPADEV0024  GREEN

```

## Using the ObjectConnect Commands

The following topic shows the specific functions that are performed by the ObjectConnect commands. You can use the Remote Location Name (RMTLOCNAME) parameter on these commands to specify where the saved objects are to be restored. The system determines the method (communications line or optical connection) for transferring data to that location. OptiConnect cannot run in restricted state.

### Save/Restore (SAVRST) Command

You can use the Save/Restore (SAVRST) command to save one or more objects in directories, send them to another system, and restore them. It can also save entire directories (not to be confused with entire systems). The SAVRST command supports the same options as the SAV command.

### Save/Restore Object (SAVRSTOBJ) Command

You can use the Save/Restore Object (SAVRSTOBJ) command to save one or more objects, send them to another system, and restore them. The SAVRSTOBJ command supports the same options as the SAVOBJ command, including the use of the OMITOBJ parameter.

### Save/Restore Change Objects (SAVRSTCHG) Command

You can use the Save/Restore Changed Objects (SAVRSTCHG) command to save one or more changed objects, send them to another system, and restore them. An example of this would be a situation where you wanted to maintain duplicate sets of files on two different systems. The SAVRSTxxx command supports most of the same options as the SAVxxx command.

### Save/Restore Library (SAVRSTLIB) Command

You can use the Save/Restore Library (SAVRSTLIB) command to save one or more libraries, send them to another system, and restore them. The SAVRSTLIB command supports the same options as the SAVLIB command, including the use of the OMITLIB and OMITOBJ parameters. You may also use generic values for the LIB parameter on this command.

### Save/Restore Document Library Object (SAVRSTDLO) Command

You can use the Save/Restore Document Library Object (SAVRSTDLO) command to save one or more document library objects, send them to another system, and restore them. The SAVRSTDLO command supports the same options as the SAVDLO command.

### Save/Restore Configuration (SAVRSTCFG) Command

You can use the Save/Restore Configuration (SAVRSTCFG) command to save one or more configuration objects, send them to another system, and restore them. The SAVRSTCFG command supports most of the options and parameters as the SAVCFG and RSTCFG commands.

When you copy your configuration by using the SAVRSTCFG command, the system saves and restores the following object types:

*CFGL	*CNNL	*CRGM	*NTBD
*CIO	*COSD	*MODD	*TRA

## Investigating ObjectConnect Problems

If all ObjectConnect commands are failing, do the following:

- Ensure the correct subsystem is active.
- Ensure the connection between systems is active.
- Ensure the correct remote location name is specified.

If you suspect a more specific problem, do the following:

1. Locate the failing job or job log on both the source and target system. An informational message may exist between the save completion message and the restore completion message. This message ID is CPFAD87. If this message exists, use F1 to display the detailed message to determine the name of the job log on the target system.
2. Display the job log information on the target system and find the following message:  
Corresponding source information from location &1;
3. Use F1 to display the detailed message. The detailed information indicates the job name and number for the source job.
4. Inspect the job log information on both systems to locate any messages. The messages each include secondary text that describes the recommended course of action if one is needed.

If problems are identified as OptiConnect/400 or communications problems, see the *OptiConnect/400 Guide* or OptiConnect in the Information Center.

## CPFAD84 Error Codes

If you receive a CPFAD84 message on either the source or target system, refer to the error codes below to identify the problem. You may also use the Analyze Problem (ANZPRB) command to report the problem.

### Source System-specific Error Codes from CPFAD84 Message

- SRC1** Unknown message type was received on the source system, sent from target system. ObjectConnect does not expect the target system to send messages other than escape, completion, diagnostic, or information type messages.
- SRC2** Zero messages sent from target system. ObjectConnect expects to get a minimum of one message that indicates success or failure. If the target system does not send any messages, then this is an error.
- SRC3** Receive response above MI sent an invalid code within the message. This indicates that something on the target system failed and could not continue. Check the spool file on the target system.
- SRC4** Cannot start save operation. Save code has sent an escape message, indicating its inability to begin the save operation. This may be a source type problem or a sink type problem. Check for vlogs and try again. The number of simultaneous save operations or restore operations may have exceeded the allowable limit.

### Target System-specific Error Codes from CPFAD84 Message

- TGT1** Spool file is invalid. This indicates that the spool file had messages in an order that are not expected. This error may also occur if ObjectConnect information message CPFAD85 is not in the spool file.
- TGT2** Received a 'terminate' message from below MI on source system. This is running over bus only. This indicates that the source has ended for some reason and that it has notified the target system that it will not send any more data. Refer to the source system job log.
- TGT3** Send Response failed after Receive Request worked. Target system received a function check while running via the bus.
- TGT4** Received a function check while running via the bus, and did not receive any information from the source system.
- TGT5** Cannot start restore operation. Restore code has sent an escape message, indicating its inability to begin the restore operation. This may be a source type problem or a sink type problem. Check for vlogs and try again. The number of simultaneous save operations or restore operations operations may have exceeded the allowable limit.



## Source or Target system Error Codes from CPFAD84 Message

- F4BE** Sent from below MI. This indicates that a valid ending of the job has occurred. For example, the source system begins the save operation by using the SAVRSTOBJ command. If it finds that there is no data to save in the library, it returns a message that indicates that no objects were saved. The source system sends a message to the target system indicating that no data is being transferred. The job on the target system ends instead of waiting for the data.
- FxBF** Received invalid error message from below MI. This can be received in the CPF389C error message. This is never an expected.error code. Check for vlogs and try the request again.
- 0000** Although this would usually indicate a valid function or return code, in this situation it indicates that something out of the ordinary has failed. If running via the bus, the bus manager has completed its operation in a valid state, but something else has failed. Try the request again.



---

## Part 2. Recovering Information on Your System

### Chapter 2. Restore Procedures—General

<b>Information</b> . . . . .	29
The Relationship Between Save and Restore Commands . . . . .	31
What Happens When You Restore Objects . . . . .	32
Sequence for Restoring Related Objects . . . . .	34
Putting Your System in a Restricted State . . . . .	35
Reclaim Storage . . . . .	35
How to Reclaim Storage . . . . .	36
Reclaim Object Links . . . . .	39
Controlling Restoration of Security-Sensitive Objects . . . . .	40
Minimizing Object Scans After Restores . . . . .	43
How to Set the QPFRADJ System Value for a Different Processor or Memory . . . . .	44
Locked Objects While Restoring . . . . .	44
How to verify that objects are restored successfully . . . . .	45
Recovery from an Unsuccessful Restore Operation . . . . .	46
Recovering from an Error While Restoring Libraries . . . . .	47
Recovering from an Error While Restoring DLOs . . . . .	48
Recovering Documents and Folders . . . . .	48
Recovering from Unsuccessful System Signon . . . . .	48
How to Perform a Normal IPL . . . . .	49
Parallel Restore Operations . . . . .	49

### Chapter 3. Selecting the Appropriate Recovery Strategy

<b>Strategy</b> . . . . .	51
Some Common Recovery Terminology . . . . .	51
Recovery Procedure for a Power Failure . . . . .	52
Recovery Procedure for a System Failure . . . . .	53
Recovery Procedure for a Program Failure or Human Error . . . . .	53
Choosing the Recovery Procedure for a Disk Failure or Disk Errors . . . . .	53
Actions for load source disk unit failure—Checklist 1 . . . . .	55
Actions for load source disk unit failure—Checklist 2 . . . . .	56
Actions for load source disk unit failure—Checklist 3 . . . . .	57
Actions for load source disk unit failure—Checklist 4 . . . . .	58
Actions for load source disk unit failure—Checklist 5 . . . . .	62
Actions for non-load source disk unit failure or disk units in basic user ASP disk failure—Checklist 6 . . . . .	66
Actions for non-load source disk unit failure—Checklist 7 . . . . .	66
Actions for non-load source disk unit failure—Checklist 8 . . . . .	67
Actions for non-load source disk unit failure—Checklist 9 . . . . .	68
Actions for non-load source disk unit failure—Checklist 10 . . . . .	72

Actions for a failure in a basic ASP disk unit—Checklist 11 . . . . .	76
Actions for a failure in a basic ASP disk unit—Checklist 12 . . . . .	76
Actions for a failure in a basic ASP disk unit—Checklist 13 . . . . .	78
Actions for non-load source disk unit failure—Checklist 14 . . . . .	80
Actions for non-load source disk unit failure—Checklist 15 . . . . .	81
Actions for non-load source disk unit failure—Checklist 16 . . . . .	81
Actions for independent ASP disk failure—Checklist 17 . . . . .	82
Actions for a failure in an independent ASP disk unit—Checklist 18 . . . . .	83
Actions for a failure in an independent ASP disk unit—Checklist 19 . . . . .	84
Recovering your entire system after a complete system loss—Checklist 20 . . . . .	85
Recovering your entire system after a complete system loss including independent ASPs—Checklist 21 . . . . .	88
Restoring a Logical Partition to Another Logical Partition—Checklist 22 . . . . .	92
Actions for a failed cache card – Checklist 23 . . . . .	94
Choosing the Procedure to Recover User Information . . . . .	95
Recovering User Information Using Commands—Checklist 24 . . . . .	97
Using Option 21 from the Restore Menu—Checklist 25 . . . . .	100
Using Options 22 and 23 from the Restore Menu—Checklist 26 . . . . .	103
Recovering User Information Using Tapes from Operational Assistant Backup—Checklist 27 . . . . .	106

### Chapter 4. Recovering the Licensed Internal Code

<b>Code</b> . . . . .	111
How to Prepare for Loading the Licensed Internal Code . . . . .	112
Task 1—Getting Ready to Load the Licensed Internal Code . . . . .	112
Task 2—Powering Down the System . . . . .	113
Task 3a—Preparing the System to Perform an IPL from an Alternate Device . . . . .	114
Task 3b—Preparing a Logical Partition to Perform an IPL from an Alternate Device . . . . .	114
Task 4—Loading the Licensed Internal Code from Media . . . . .	115
How to Load the Licensed Internal Code . . . . .	120
How to Recover Your Logical Partition Configuration . . . . .	123
How to Set Up Your Disk Configuration After Installing the Licensed Internal Code and Initializing the System . . . . .	125

How to Recover Your Disk Configuration Using iSeries Navigator at DST . . . . .	126
How to Recover Your Disk Configuration . . . . .	130
How to Start Your System After Restoring Licensed Internal Code . . . . .	133

**Chapter 5. Restoring the Operating System . . . 135**

Choosing the Right Procedure for Restoring the Operating System . . . . .	136
How to Load the Operating System Using a Manual IPL . . . . .	137
How to Restore the operating system . . . . .	137
Task 1–Starting to Restore the Operating System	138
Task 2–Selecting the Installation Options . . . . .	142
Task 3–Selecting IPL Options . . . . .	146
Task 4–Setting Major System Options . . . . .	148
Task 5–Defining or Changing the System at IPL	148
Task 6–Completing the IPL . . . . .	150
Recovering from SRC A900 2000 . . . . .	152
Creating a Configuration for Other Tape Units	152

**Chapter 6. Starting the System After It Ends Abnormally . . . . . 155**

What Happens When Your System Stops . . . . .	155
Using the Disk Configuration Error Report Display . . . . .	155
Using the Main Storage Dump Occurred Display . . . . .	156
How to Restart Your System . . . . .	157
Task 1–Performing an Attended IPL . . . . .	157
Task 2–Edit Rebuild of Access Paths . . . . .	159
Task 3–Edit Check Pending Constraints . . . . .	161
Task 4–Recovering from Damaged Objects and Unreadable Sectors . . . . .	162
Recovering Damaged Database Files . . . . .	164
Recovering a Damaged Journal . . . . .	166
Recovering a Damaged Journal Receiver . . . . .	166
Recovering a Journalled Object That Is Damaged or Not Synchronized . . . . .	167
Recovering damaged objects in the integrated file system . . . . .	167
Recovering Other Types of Damaged Objects	167

**Chapter 7. Recovering Information in a User Auxiliary Storage Pool. . . . . 169**

Describing the Contents of Your User Auxiliary Storage Pools . . . . .	169
Choosing the Procedure to Recover User ASPs . . . . .	170
How to Recover a Basic User ASP After Recovering the System ASP . . . . .	170
Task 1–Reclaiming Storage . . . . .	171
Task 2–Restoring User Profiles . . . . .	172
Task 3–Restoring the Configuration . . . . .	172
Task 4–Recovering Journals and Journal Receivers in the QRCL Library . . . . .	173
Task 5–Restoring Libraries to the System Auxiliary Storage Pool . . . . .	174
Task 6–Restoring Document Library Objects to the System Auxiliary Storage Pool . . . . .	175
Task 7–Restoring User-Defined File Systems to the User Auxiliary Storage Pool . . . . .	175

Recovery Steps for Unmounted User-Defined File Systems (UDFS) . . . . .	175
Recovery Steps for Mounted User-Defined File Systems (UDFS) if Data is not Restored . . . . .	175
Recovery Steps for Mounted User-Defined File Systems (UDFS) if Data is Restored . . . . .	175
Task 8– Reclaiming Document Library Objects	176
Task 9–Recovering Save Files from the QRCL Library . . . . .	176
Task 10–Associating Journal Receivers with Journals . . . . .	176
Task 11–Restoring Object Ownership . . . . .	178
How to Recover An Overflowed User Auxiliary Storage Pool. . . . .	179
Resetting An Overflowed User Auxiliary Storage Pool without an IPL . . . . .	179
Resetting An Overflowed User Auxiliary Storage Pool during an IPL. . . . .	180
How to Delete Overflowed Objects during Recovery . . . . .	182
How to Recover a Damaged Basic Auxiliary Storage Pool. . . . .	183
Task 1–Restoring User Profiles. . . . .	183
Task 2–Determining the Contents of the Lost Auxiliary Storage Pool . . . . .	183
Task 3–Determining Tasks to Restore Objects	184
Task 4–Restoring Libraries to a Basic Auxiliary Storage Pool. . . . .	184
Task 5–Restoring Journals to a Basic Auxiliary Storage Pool. . . . .	185
Task 6–Restoring Documents to a Basic Auxiliary Storage Pool . . . . .	186
Task 7–Restoring User-Defined File Systems to a Basic Auxiliary Storage Pool . . . . .	186
Recovery Steps for Unmounted User-Defined File Systems (UDFS) . . . . .	186
Recovery Steps for Mounted User-Defined File Systems (UDFS) if Data is not Restored . . . . .	186
Recovery Steps for Mounted User-Defined File Systems (UDFS) if Data is Restored . . . . .	186
Task 8–Restoring Journal Receivers to a Basic Auxiliary Storage Pool . . . . .	187
Task 9–Restore Save Files to a Basic Auxiliary Storage Pool. . . . .	187
How to Recover an Independent ASP . . . . .	187
Task 1–Restoring User Profiles. . . . .	187
Task 2–Determining Tasks to Restore Objects to an Independent ASP . . . . .	188
Task 3–Restoring Libraries to the Independent Auxiliary Storage Pool . . . . .	188
Task 4–Restoring User-Defined File Systems to the Independent Auxiliary Storage Pool . . . . .	189
Recovery Steps for Unmounted User-Defined File Systems (UDFS) . . . . .	189
Recovery Steps for Mounted User-Defined File Systems (UDFS) if Data is not Restored . . . . .	189
Recovery Steps for Mounted User-Defined File Systems (UDFS) if Data is Restored . . . . .	190
Task 5. Restoring Authority for an Independent ASP . . . . .	190

How to Remove a Failed Disk Unit from the System ASP . . . . .	190	Restoring Objects That Are Journaled . . . . .	226
Task 1–Accessing Dedicated Service Tools . . . . .	191	What Happens When You Restore Journaled Objects to a Different Library or Directory. . . . .	227
Task 2–Deleting the Auxiliary Storage Pool Data . . . . .	192	Restoring Database Files. . . . .	228
Task 3–Removing the Disk Unit from the Auxiliary Storage Pool Configuration . . . . .	193	Comparing File Attributes during a Restore Operation . . . . .	229
<b>Chapter 8. The Restore Menu . . . . .</b>	<b>195</b>	How the System Matches File Members during a Restore Operation . . . . .	231
What the Restore Menu Options Do. . . . .	195	Restoring Members to a File . . . . .	231
How to Use Restore Menu Options 21, 22, and 23 . . . . .	196	Restrictions on the File Member Parameter . . . . .	231
<b>Chapter 9. How to Restore Specific Types of Information. . . . .</b>	<b>201</b>	Restoring Logical Files . . . . .	232
Recovering System Information . . . . .	201	How the System Restores Access Paths. . . . .	233
Sequence for Restoring Security Information . . . . .	201	Restoring a File Network–Examples . . . . .	233
Restoring User Profiles . . . . .	202	How to Prevent the System from Rebuilding a Large Access Path . . . . .	235
What Happens When You Restore User Profiles . . . . .	203	How the System Restores Files with Shared Formats . . . . .	235
What You Should Know About Restoring User Profiles . . . . .	204	How the System Restores Files with Referential Constraints . . . . .	235
How the System Establishes Ownership for Restored Objects . . . . .	206	Referential Constraint Network–Example . . . . .	236
How the System Establishes the Authorization List for a Restored Object . . . . .	206	How the System Restores Files with Triggers . . . . .	237
How the System Establishes the Primary Group for Restored Objects . . . . .	206	Steps Before Deleting a Physical File . . . . .	237
Restoring Object Authorities . . . . .	206	Restoring Journals and Journal Receivers . . . . .	238
Overview of Restoring Authorities . . . . .	207	Restoring Journals. . . . .	238
Restoring Authority on a System in a Non-restricted State . . . . .	207	Steps before Deleting a Journal . . . . .	238
What You Should Know Before Running RSTAUT . . . . .	208	Restoring Journal Receivers. . . . .	239
Job Log Considerations . . . . .	209	How to Resolve Name Conflicts When Restoring Journal Receivers. . . . .	240
Restoring Authority on a System in a Restricted State . . . . .	211	How to Correct the Journal Receiver Directory . . . . .	240
What the System Does When You Restore Authority. . . . .	212	Steps before Deleting a Journal Receiver . . . . .	240
Restoring authorities for independent ASP data. . . . .	214	How the System Restores Programs . . . . .	241
How to Restore Configuration Objects . . . . .	218	Restoring Programs to a Different Release . . . . .	242
Correcting Problems with the System Resource Management Information . . . . .	219	Restoring Save File Data. . . . .	242
Recovering Devices That Will Not Vary On . . . . .	220	Save and restore spooled files . . . . .	243
Recovering When You Change the Console Type . . . . .	221	Restoring Licensed Programs . . . . .	244
Recovering the System/36 Environment Configuration . . . . .	221	Restoring Documents and Folders . . . . .	244
Restoring Logical Partitions . . . . .	222	RSTDLO Command Options . . . . .	244
Restoring Libraries . . . . .	223	Using Multiple Concurrent DLO commands . . . . .	245
Restoring a Library From a Previous Release . . . . .	223	Output from the RSTDLO Command . . . . .	245
Restoring Multiple Libraries . . . . .	223	Considerations and Restrictions . . . . .	245
Considerations and Restrictions . . . . .	224	Moving Documents . . . . .	245
How to Restore All Libraries from a Single Save Operation . . . . .	224	Searching Tape Files . . . . .	245
How to Restore All Libraries from Multiple Save Operations . . . . .	225	Selecting files from DVD-RAM optical media . . . . .	246
How to Restore Objects . . . . .	225	Search Index Database Errors . . . . .	246
Restoring User-Defined File Systems . . . . .	226	Authority Required to Restore DLOs . . . . .	246
Restoring an unmounted UDFS . . . . .	226	How the System Restores New DLOs . . . . .	246
Restrictions while you restore an unmounted UDFS . . . . .	226	How the System Restores Existing DLOs . . . . .	246
Restoring an individual object from an unmounted UDFS . . . . .	226	Size Limitations When Restoring Document Library Objects . . . . .	246
Restoring a mounted UDFS . . . . .	226	Restoring Folders . . . . .	246
		Renaming Documents When Restoring. . . . .	247
		How the System Restores Descriptive Information for DLOs . . . . .	247
		How the System Restores Authority and Ownership for DLOs . . . . .	247
		When to Run the Rename Directory (RNMDIRE) Command . . . . .	248
		When to Run the Rename Document Library Object (RNMDLO) Command . . . . .	248
		Restoring Objects in Directories . . . . .	248

Completing Recovery for the IBM iSeries Integration for Windows Server Product . . . . .	250
Recovery for save performed with Integrated xSeries Server varied off. . . . .	250
Recovery for save performed with Integrated xSeries Server varied on. . . . .	251
Recovering Linux or AIX in a Partition . . . . .	251
Recovery Steps for i5/OS Enhanced Integration for Novell NetWare . . . . .	252
Recovering a Domino Server . . . . .	252
Recovering an entire Domino server. . . . .	252
Recovering Domino mail . . . . .	253
Recovering specific Domino databases . . . . .	253
Restoring changed objects to a Domino server	254
Example: Restoring changed Domino objects from a cumulative backup . . . . .	254
Example: Restoring changed Domino objects from a nightly backup . . . . .	255
Example: Restoring Domino databases from an incremental backup . . . . .	255
Example: Restoring changed objects from a specific Domino subdirectory . . . . .	256
Restoring a Windows server . . . . .	256
Restrictions When Using the Restore Command	256
How to Restore Program Temporary Fixes. . . . .	259
Restore system information. . . . .	260

**Chapter 10. How to Restore Changed Objects and Apply Journaled Changes . . . . .** 261

Task 1–Restoring Changed Objects . . . . .	262
Restoring Changed Objects by Library . . . . .	262
Restoring Changed Objects Individually . . . . .	262
Task 2–Restoring Changed Objects in Directories	263
Task 3–Determining Whether You Need to Apply Journaled Changes . . . . .	263
Task 4–Determining What Journal Receivers to Use	264
Task 5–Applying Journaled Changes for User Journals . . . . .	266
Task 6–Applying Journaled Changes for the QAOSDIJRN Journal . . . . .	267
Task 7–Restoring Changed Documents and Folders	268

**Chapter 11. Mirrored Protection Recovery**

<b>Actions . . . . .</b>	269
System Actions for Permanent Errors . . . . .	269
Suspending Mirrored Units. . . . .	270
Resuming Mirrored Units . . . . .	271
Replacing a Mirrored Unit . . . . .	271
Using Spare Nonconfigured Units for Replacement. . . . .	273
Mirrored Protection Recovery Actions Performed by the Service Representative . . . . .	275
Actions When Concurrent Maintenance is Possible . . . . .	275
Actions When Concurrent Maintenance is Not Possible. . . . .	275
Other Recovery Considerations for Mirrored Protection . . . . .	275
Mirrored Protection Disk-Error Handling . . . . .	276
Missing Disk Units . . . . .	276
Saving a Unit . . . . .	277

Restoring a Unit . . . . .	277
Active Mirrored Load Source Failure . . . . .	278
System Cannot Find Active Mirrored Load Source for IPL . . . . .	278
Active Mirrored Load Source Being Used for IPL Fails . . . . .	278
Active Mirrored Load Source Fails Late in the IPL or at Runtime . . . . .	279
Cannot Read System Configuration Data from Active Mirrored Load Source . . . . .	279
Unknown Unit 1 Status . . . . .	280
To Recover the State of the Unknown Load Source. . . . .	281
Display Incorrect Licensed Internal Code Installation . . . . .	281
Recovering remote load source mirroring . . . . .	281
Recovering After the Remote Load Source Has Failed . . . . .	281
Recovering After the Local Load Source Has Failed on an iSeries server . . . . .	282
Dedicated Recovery of Local Load Source -- Local System is Still Functional . . . . .	282
Dedicated Recovery From Remote Disk Units -- After a Local Site Disaster . . . . .	282
Using the Recover Mirrored Load Source Function . . . . .	283

**Chapter 12. How to Restore Your System Using Operational Assistant Tapes. . . . .** 285

How to Restore Your Libraries. . . . .	286
How to Restore Libraries That You Saved by Using a Backup List . . . . .	287
How to Restore Changed Objects That You Saved by Using Operational Assistant . . . . .	288

**Chapter 13. How to Restore the System from the Save Storage Media . . . . .** 289

Task 1–Powering Down the System and Loading the Licensed Internal Code . . . . .	289
Task 2–Restoring the Save Storage Tapes . . . . .	290
Task 3–Responding to Messages . . . . .	292
Task 4–Completing the Restore Storage Operation	293
Task 5–Restoring Additional Information . . . . .	295
Task 6–Restoring Program Temporary Fixes (PTFs)	295
How to Resume the Restore Storage Operation . . . . .	296

---

## Chapter 2. Restore Procedures—General Information

Figure 3 on page 30 shows the menu options and commands that are available for restoring information. It also shows the normal sequence for restoring information, working from top to bottom. Figure 4 on page 31 shows what restore commands can be used for information in the different file systems.

**Note:** Look for comprehensive information about how to save your iSeries server on the Information Center. “Prerequisite and related information” on page xiii explains how to access the Information Center.

Compare these figures with the save information on the Information Center to see the relationship between how things are saved and how they are restored. Use them to gain a general understanding of what you need to restore and how you might do it. Use the information in Chapter 3, “Selecting the Appropriate Recovery Strategy” to plan the correct recovery strategy for your situation.

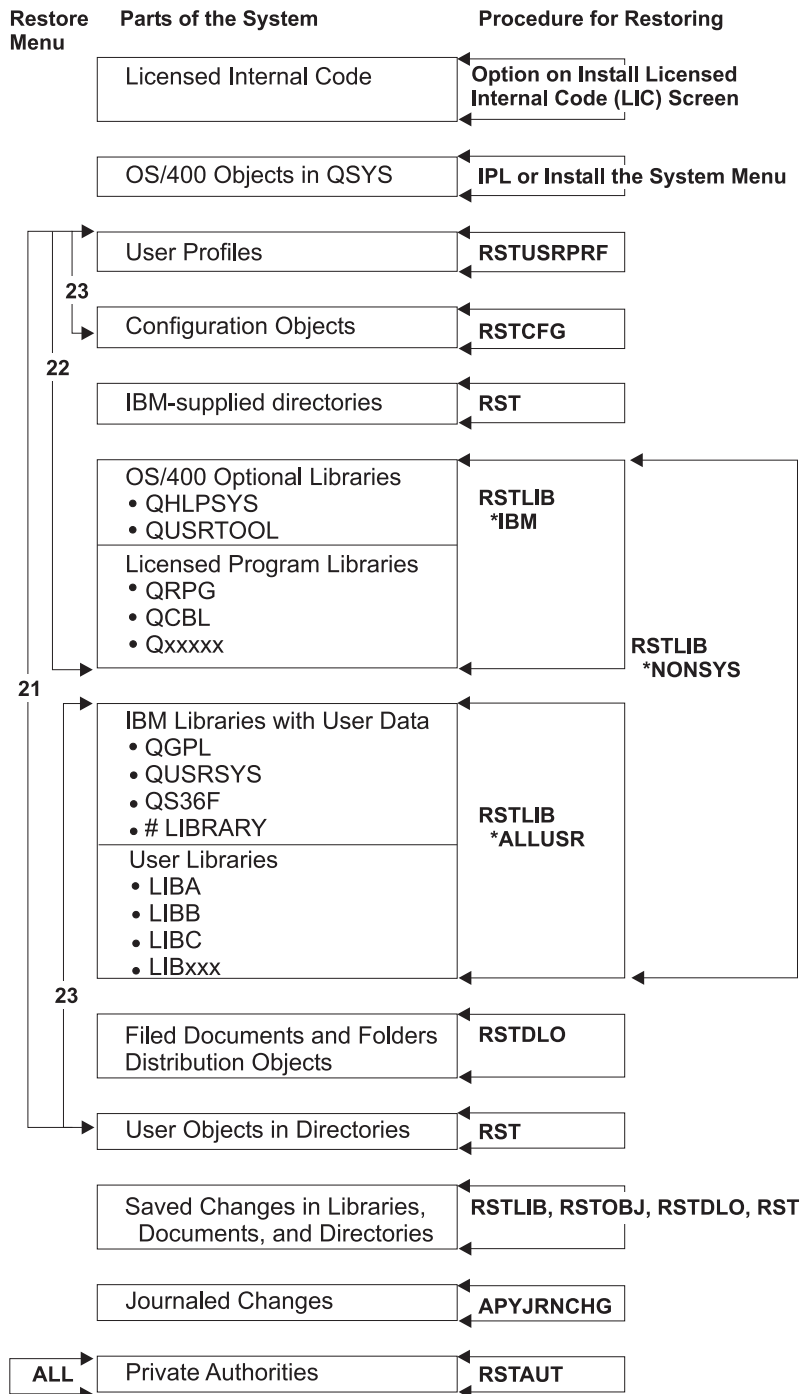

RBANS508-0

Figure 3. Restore Procedures

Note: RSTOBJ can also be used where RSTLIB is shown to restore objects.



How to save	File system	How to Restore
SAVSYS, SAVCFG, SAVSECDTA, SAVLIB, SAVOBJ, SAVCHGOBJ, SAV	QSYS.LIB (Library)	Chapters 12 and 13 RSTUSRPRF, RSTAUT RSTCFG, RSTLIB, RSTOBJ, RST
SAVDLO SAV	QDLS (Document library services)	RSTDLO RST
SAV	OOpenSys (Open systems)	RST
SAV	QNetware (OS/400 Integration for Novell Netware)	RST
SAV	Domino server data directory (Domino for iSeries)	RST
SAV	User-defined file systems (/dev/QASPxx) or (/dev/aspname/)	RST
SAV	(Other file systems)	RST
SAV	Root	RST

RBANS501-1

Figure 4. Save procedures and restore procedures for file systems

---

## The Relationship Between Save and Restore Commands

Table 3 shows which restore commands can be used, based on how the objects were saved.

**Note:** For comprehensive information on saving your server, refer to the **Backing up your system** topic on the Information Center at the following Web site:

<http://www.ibm.com/eserver/series/infocenter>

This Web site includes general information on the save commands below.

Table 3. Relationship Between Save and Restore Commands

Save Command Used	Possible Restore Command
SAVOBJ	RSTOBJ RST
SAV	RST

---

Table 3. Relationship Between Save and Restore Commands (continued)

Save Command Used	Possible Restore Command
SAVLIB LIB(*NONSYS)	RSTLIB SAVLIB(*NONSYS) RSTLIB SAVLIB(*IBM) RSTLIB SAVLIB(*ALLUSR) RSTLIB SAVLIB( <i>library-name</i> ) RST
SAVLIB LIB(*ALLUSR)	RSTLIB SAVLIB(*ALLUSR) RSTLIB SAVLIB( <i>library-name</i> ) RST
SAVLIB LIB(*IBM)	RSTLIB SAVLIB(*IBM) RSTLIB SAVLIB( <i>library-name</i> ) RST
SAVLIB LIB( <i>library-name</i> )	RSTLIB SAVLIB( <i>library-name</i> ) RST
SAVSECDTA	RSTUSRPRF RSTAUT <sup>1</sup>
SAVCFG	RSTCFG
SAVSYS	Restore Licensed Internal Code. (See Chapter 4.) Restore operating system. (See Chapter 5.) RSTUSRPRF RSTCFG RSTAUT <sup>1</sup>
SAVDLO	RSTDLO RST
SAVSYSINF	RSTSYSINF

<sup>1</sup> The RSTUSRPRF command restores authority information to temporary tables. The RSTAUT command regrants private authorities using tables that are built as a part of the RSTUSRPRF command.

## What Happens When You Restore Objects

An object on this system is like a container. The object has information about the container itself, such as the owner of the object and the last time it was saved. This is the information you see when you display the object description (DSPOBJD command). The object also has contents, such as the records in a database file or the instructions in a program.

When you restore an object, the system takes different actions depending on the following:

- Whether the object to be restored already exists.
- The allow object differences (ALWOBJDIF) parameter on the restore command.
- Whether the object was saved on a different system (serial number of the processor).

With a few exceptions that relate to security, the contents of the object are always restored. If the object exists, the system compares the object description information on the system copy and the media copy and then makes decisions. For most information, the media version of the information is restored. For security-relevant information, such as the public authority and the object owner, the system version is left unchanged. In a few cases, such as the size of the object and the date it was restored, the system determines a value when the object is restored.

The allow object differences (ALWOBJDIF) parameter on the restore commands is primarily for security protection and integrity protection. For example, if system security is important to you, you may want to take special action if someone attempts to restore an object whose owner has been changed. Or, if the member information about a database file does not match, you may have problems with the integrity of your data. You can use the ALWOBJDIF parameter to prevent this.

The default value for the ALWOBJDIF parameter is \*NONE. This means that if important differences exist between the media version and the system version of an object, you want the system to take special action. Normally, you should use the default value. However, when you are restoring your information to a different system, such as during a disaster recovery, you should specify ALWOBJDIF(\*ALL).

You can specify a combination of up to four values on the ALWOBJDIF parameter to allow specific types of differences for the restore operation: \*FILELVL, \*AUTL, \*OWNER, and \*PGP. The \*FILELVL value attempts to restore physical file data when the file level id or the member level id of the physical file on the system is different than that of the physical file on the save media. The \*AUTL value allows differences in authorization lists. The \*OWNER value allows differences in object ownership. The \*PGP value allows differences in the primary group.

The advantage that ALWOBJDIF(\*FILELVL \*AUTL \*OWNER \*PGP) has over ALWOBJDIF(\*ALL) is that in addition to allowing all object differences, it attempts to restore physical files when the file level id or member level id of the physical file on the system is different than that for the physical file on the save media.

Table 4 shows examples of the effect of the ALWOBJDIF parameter:

*Table 4. Restoring Objects with ALWOBJDIF.* Effect of ALWOBJDIF parameter when the value on the media and on the system are different.

Object Characteristic That Differs	Value for Object after Restore Operation		
	ALWOBJDIF(*NONE) Specified	ALWOBJDIF(*ALL) Specified	ALWOBJDIF(*FILELVL) Specified
Object owner	Object is not restored	Existing value <sup>1</sup>	Object is not restored <sup>5</sup>
Object primary group	Object is not restored	Existing value <sup>3</sup>	Object is not restored <sup>5</sup>
Object auditing	Existing value	Existing value	Existing value
<i>Authorization list, restore over existing object:</i>			
Object on media is secured by an authorization list and object on system is not secured by an authorization list	Object is not restored	Object is restored and is secured by authorization list of object on system <sup>2</sup>	Object is not restored <sup>5</sup>
Object on media is not secured by an authorization list and object on system is secured by an authorization list	Object is restored and is secured by authorization list of object on system	Object is restored and is secured by authorization list of object on system <sup>2</sup>	Object is restored and is secured by authorization list of object on system <sup>5</sup>
Object on media is secured by an authorization list and object on system is secured by a different authorization list	Object is not restored	Object is restored and is secured by authorization list of object on system; message is sent to user <sup>2</sup>	Object is not restored <sup>5</sup>
<i>Authorization list, new object restored:</i>			
Object is restored onto different system than it was saved from	Object is restored and is not secured by an authorization list	Object is restored and is secured by the same authorization list that secured the object when it was saved, if the authorization list exists <sup>2</sup>	Object is restored and is not secured by an authorization list <sup>5</sup>
<i>Database files:</i>			
Creation date for file	File is not restored	File is renamed on the system; copy is restored from media with media creation date; message is sent to user.	Logical file is not restored. System attempts to restore physical file data <sup>4</sup>

Table 4. Restoring Objects with ALWOBJDIF (continued). Effect of ALWOBJDIF parameter when the value on the media and on the system are different.

Object Characteristic That Differs	Value for Object after Restore Operation		
	ALWOBJDIF(*NONE) Specified	ALWOBJDIF(*ALL) Specified	ALWOBJDIF(*FILELVL) Specified
Creation date for member	Member is not restored	Member is renamed on the system; copy is restored from media with media creation date; message is sent to user.	Logical member is not restored. System attempts to restore physical member data <sup>4</sup>
<i>Physical file data</i> Level identifier for file	Physical file data is not restored	File is renamed on the system; copy is restored from media with media creation date; message is sent to user.	System attempts to restore physical file data <sup>4</sup>
Level identifier for member	Physical file data is not restored	Member is renamed on the system; copy is restored from media with media creation date; message is sent to user.	System attempts to restore physical member data <sup>4</sup>
<sup>1</sup>	Also applies to restore commands with ALWOBJDIF(*OWNER)		
<sup>2</sup>	Also applies to restore commands with ALWOBJDIF(*AUTL)		
<sup>3</sup>	Also applies to restore commands with ALWOBJDIF(*PGP)		
<sup>4</sup>	Only applies to RSTLIB and RSTOBJ commands with ALWOBJDIF(*FILELVL)		
<sup>5</sup>	If *FILELVL was specified in conjunction with the corresponding *OWNER, *AUTL, or *PGP value, the outcome would be the same as the ALWOBJDIF(*ALL) column for this object.		

The following topics provide more information about the effect of the ALWOBJDIF parameter:

- “How the System Establishes Ownership for Restored Objects” on page 206
- “How the System Establishes the Authorization List for a Restored Object” on page 206
- “Comparing File Attributes during a Restore Operation” on page 229
- “How the System Restores Programs” on page 241

## Sequence for Restoring Related Objects

Some objects depend on other objects. When related objects are in the same library or directory, the system restores them in the correct order. If related objects are in different libraries or directories, you must restore them in the correct order or perform additional recovery steps after they are restored.

If possible, restore objects in this sequence:

- Journals before journaled objects. If you restore a journaled object when the journal is not on the system, you must start journaling again after the journal is restored. Use the STRJRNPF command, the STRJRNAP command, the STRJRNOBJ command, or the STRJRN command. See “Restoring Objects That Are Journaled” on page 226 for more information.
- Journals before journal receivers. If you restore a journal receiver when the journal is not on the system, you must associate the journal receivers with the journal after it is restored. Use the WRKJRN command. See “Restoring Journals and Journal Receivers” on page 238 for more information.

- Physical files before logical files. You cannot restore a logical file if the based-on physical files are not on the system. “How the System Restores Access Paths” on page 233 describes how to restore logical files and based-on physical files that are in different libraries.

---

## Putting Your System in a Restricted State

Many recovery procedures require that your system have no other activity on it. When no subsystems except the controlling subsystem are active on your system, it is in a **restricted state**.

Use the End Subsystem (ENDSBS) command to put your system in a restricted state. You specify how you want the subsystems to end:

*Possible Values for the OPTION Parameter of the ENDSBS Command:*

<b>*CNTRLD</b>	Allow active jobs to end themselves (if they are checking to see if the job is being ended). If you specify *CNTRLD, you can use the delay parameter to set a time for the system to wait before ending subsystems immediately.
<b>*IMMED</b>	End the subsystem immediately. Use this option if there are no users on the system and no batch jobs running.

**Note:** Even if you have no activity on the system, jobs may be running under a few system-provided subsystems, such as the QSYSWRK (subsystem monitor) subsystem and the QCALSRV (calendar server) subsystem. You can end all subsystems immediately without first ending these jobs. You will receive messages that these subsystems ended abnormally.

Do the following to put your system in a restricted state:

1. Before putting your system in a restricted state, ensure that all users are signed off and all jobs are ended.
2. To receive notification that the subsystems have ended, type the following and press the Enter key:  

```
CHGMSGQ MSGQ(QSYSOPR) DLVRY(*BREAK)
      SEV(60)
```
3. To end all subsystems, type the following:  

```
ENDSBS SBS(*ALL) OPTION(*CNTRLD)
      DELAY(600)
```

**Note:** For the delay parameter, specify a number of seconds that allows your system time to bring most jobs to a normal end. On a large, busy system, you may need a longer delay.

A message is sent that indicates that the procedure for ending subsystems is in progress. A final message is sent when the system is in a restricted state.

---

## Reclaim Storage

Use the reclaim storage (RCLSTG) command to recover the addressability of lost or damaged objects. This allows you to identify and then restore those objects that were damaged. If an authorization list is found damaged during reclaim storage, the objects secured by the damaged authorization list are associated with the system authorization list QRCLAUTL. To find out how to recover from damaged authorization lists, look under the Programming topic on the Information Center at the following Web site: <http://www.ibm.com/eserver/series/infocenter>.

The RCLSTG command has four parameters. These parameters allow you to perform reclaim functions in the following ways:

- | **SELECT**
- |       Specifies all or a subset of the reclaim functions that are performed.
- | **OMIT** Specifies the subset of the reclaim functions that are omitted.

## ASPDEV

- Reclaim the system ASP and all basic ASPs. The system ASP has an ASP number of 1. Basic ASPs have ASP numbers of 2 through 32.
- Reclaim a specific independent ASP. Independent ASPs have a device name and a number greater than 32.

## | ESTIMATE

| Estimates the amount of time that a RCLSTG command will take to run.

**Note:** The RCLSTG procedure requires auxiliary storage. If you are already using a very high percentage of auxiliary storage, the RCLSTG procedure may not complete successfully.

## How to Reclaim Storage

To reclaim storage, do the following:

1. Sign on the system with a user profile that is authorized to the RCLSTG command. Either sign on at the console or use the Transfer Job (TFRJOB) command to transfer your job to the controlling subsystem.
2. Type DSPSYSVAL QALWUSRDMN. If the current value does not include the QRCL (Reclaim Storage) library or does not specify \*ALL, use the CHGSYSVAL command to add QRCL to the list of libraries for this system value. Write the current value here: \_\_\_\_\_
3. Type DSPSYSVAL QCTLSBSD to display the name of your controlling subsystem. Write the current value here: \_\_\_\_\_
4. If you are reclaiming storage for system and basic ASPs, ensure your system is in a restricted state. To obtain a restricted state, follow the procedure in “Putting Your System in a Restricted State” on page 35.

**Note:** If you use independent ASPs, you must make the independent ASPs unavailable first. You can use the VRYCFG command or the iSeries Navigator interface to make the independent disk pool unavailable. If independent ASPs remain available, SYSBAS reclaim performance is degraded because primary ASPs contain SYSBAS cross-reference files that are rebuilt by a SYSBAS reclaim.

5. Start the reclaim storage process by typing one of the following:

RCLSTG	Reclaim storage of the entire system.
RCLSTG SELECT(*DBXREF)	Reclaim storage of the database cross-reference table.
RCLSTG SELECT (*DIR)	Reclaim storage of the directory recovery portion.
RCLSTG OMIT(*DBXREF)	Reclaim storage of the entire system <b>except</b> the database cross-reference table.
RCLSTG ASPDEV(*SYSBAS)	Reclaim the system ASP and all basic ASPs.
RCLSTG OMIT(*DIR)	Reclaim storage of the entire system except the directory recovery portion.

**Note:** See “Reclaim Object Links” on page 39 for an alternative command to reclaim your integrated file system.

6. If you have independent ASPs, make them available now by using the VRYCFG command.
7. Reclaim independent ASPs one at a time by using one of the following commands:

RCLSTG ASPDEV( <i>auxiliary-storage-pool-device-name</i> )	Reclaim a UDFS ASP. Enter the name of the device description for the independent ASP. Make sure the independent ASP is available before you begin the reclaim storage process.
--	--

RCLSTG ASPDEV ( <i>auxiliary-storage-pool-group-name</i> )	Reclaim the primary ASP and all the secondary ASPs within the ASP group. The name of any ASP within the ASP group is accepted. Primary and secondary ASPs have ASP numbers greater than 32. Make sure the independent ASP group is available before you begin the reclaim storage process.
---	--

**Note:** If you prefer, you can reclaim storage for independent disk pools in parallel after you reclaim storage for SYSBAS and start the controlling subsystem. Do this by submitting a reclaim storage job for each UDFS ASP and each primary ASP.

8. Use the CHGSYSVAL command to set the QALWUSRDMN system value back to its original setting. (You wrote the setting in step 2.)
9. When the reclaim storage procedure finishes, start the controlling subsystem by typing the following:  
STRSBS SBSD(*controlling-subsystem*)

(You wrote the name of the controlling subsystem in step 3.)

**What Happens When You Reclaim Storage:** The purpose of the RCLSTG command is to ensure the following:

- Objects that reside permanently in auxiliary storage can be accessed.
- All auxiliary storage either is used properly or is available for use.

The system checks every object that resides permanently in auxiliary storage for loss or damage. It does the following:

- If an object does not address a library or directory, it is placed in an IBM-supplied library or directory based on the object type. The system may not be able to retrieve description information for the object, such as:
  - Program temporary fix (PTF) status.
  - Save and restore information.
  - Object attributes and text description.
- For objects that normally reside in libraries (the QSYS.LIB file system), the system does the following:
  - If a lost object with the same name and object type is already in the Recovery (QRCL) library, the system gives the object that it has just encountered a new name. The name has the format QRCLnnnnn, where *nnnnn* is a unique number. The original object name is placed in the text description for the object in the QRCL library.

**Note:** You cannot rename journals and journal receivers. If the system encounters two journals (or journal receivers) with the same name and they both need to be placed in the QRCL library, the system renames one of them. You cannot rename that journal or journal receiver back to its original name. You must restore a previous version with the correct name or re-create the journal or journal receiver. For this reason, you should use a naming convention for journals and journal receivers that is unique for the entire system, not just for a library.

- If data exists for a lost physical file, the system attempts to rebuild the file and place it in the QRCL library. To use the physical file, create it again in the correct library with the correct attributes. Then copy the data from the rebuilt file in the QRCL library to the new physical file. The data in the file may not be complete.
- Independent ASPs have their own unique QRCL library, QRCLnnnnn where *nnnnn* is the number of the primary ASP. The text description for the object in the QRCL library indicates that it has been rebuilt.
- A user domain object can be placed in the QRCL library only if the QALWUSRDMN system value includes QRCL or specifies \*ALL. Otherwise, a lost user domain object is deleted. Most objects are system domain objects. User domain objects have type \*USRSPC, \*USRIDX, or \*USRQ.
- If an object does not have an owner, it is assigned to an IBM-supplied user profile based on the object type. Most objects are assigned to the QDFTOWN user profile.

- If descriptions for objects in a library cannot be accessed, the library is rebuilt.
- If an object is secured by a damaged authorization list or authority holder, the system makes QRCLAUTL the authorization list for the object. You can use the Display Authorization List Objects (DSPAUTLOBJ) command to determine which objects are secured by the QRCLAUTL authorization list.
- If a lost object was in the "root" file system, the object is placed in the /QReclaim directory.
- If a lost object was in the QOpenSys file system, the object is placed in the /QOpenSys/QReclaim directory.
- If an object in a directory is damaged to the extent that it is unusable, the system deletes it. The RCLSTG command does not attempt to rebuild damaged objects.
- If a lost object was in a user-defined file system (UDFS), it is placed in the QReclaim directory located in the root directory of the UDFS.
- If a lost object that was in a directory cannot be placed in the proper QReclaim directory based on its original location, then it is placed into the "root" directory of a special file system within the Auxiliary Storage Pool (ASP) in which the object resides. This special file system is created by RCLSTG when needed. The file system is named '/dev/QASPxx/QReclaimFS.udfs' where 'xx' is the number for system and basic ASPs. The file system is named '/dev/iasp-name/QReclaimFS.udfs' where *iasp-name* is the name of the independent ASP.
- For objects in the "root", QOpenSys, or user-defined file systems, the system takes actions for duplicate names or for unidentified object owners similar to the actions taken for objects in the QSYS.LIB file system.

**What To Do After Running the RCLSTG Procedure:** Table 5 describes both where to look for problems that the RCLSTG procedure detects and how to correct the problems:

*Table 5. Resolving Problems Detected by the RCLSTG Procedure*

Where to Look for Problems	How to Fix the Problem
Type DSPMSG QSYSOPR to display the QSYSOPR message queue. Look for messages about damaged objects.	Type DSPLQG QHST to display the history log. Look for messages about either damaged objects or rebuilt files. <ol style="list-style-type: none"> <li>1. Delete unusable objects by using the appropriate DLTxxx command. Restore them by using the Restore Object (RSTOBJ) command.</li> <li>2. Copy data from rebuilt files to new files by using the Copy File (CPYF) command.</li> </ol> <p><b>Note:</b> You may see a message indicating that objects were deleted by the reclaim storage procedure. These are internal system objects that are no longer needed.</p>
Type DSPLIB QRCL to display the QRCL library. <b>Note:</b> If the reclaim storage procedure did not place any objects in the QRCL library, you may receive a message that the library is not found. Ignore the message and continue with the next step.	Move objects from the QRCL library to the correct library by using the Move Object (MOV OBJ) command. <p><b>Notes:</b></p> <ol style="list-style-type: none"> <li>1. If IBM-supplied objects are in the QRCL library, contact software support for assistance.</li> <li>2. If you are unsure what to do with objects in the QRCL library, use the SAVLIB command to save the library to save media. Mark the media volume in case you need the objects later.</li> </ol>
Display the /QReclaim directory by using the Display Link (DSPLNK) command. <b>Note:</b> If the reclaim storage procedure did not place any objects in the /QReclaim directory, you may receive a message that the object is not found. Ignore the message and continue with the next step.	Move objects from the /QReclaim directory to the correct directory by using the Move (MOV) command.



Table 5. Resolving Problems Detected by the RCLSTG Procedure (continued)

Where to Look for Problems	How to Fix the Problem
<p>Display the /QOpenSys/QReclaim directory by using the Display Link (DSPLNK) command.  <b>Note:</b> If the reclaim storage procedure did not place any objects in the /QOpenSys/QReclaim directory, you may receive a message that the object is not found. Ignore the message and continue with the next step.</p>	<p>Move objects from the /QOpenSys/QReclaim directory to the correct directory by using the Move (MOV) command.</p>
<p>Type DSPMSG QSYSOPR to display the QSYSOPR message queue. Look for CPFA0D7 messages. For each CPFA0D7 message that contains a directory name beginning with '/dev/QASPxx/' (where 'xx' is the number of a system or basic ASP) or '/dev/iasp-name' (where <i>iasp-name</i> is the name of an independent ASP), perform the action specified in the "How to Fix the Problem" column.</p>	<p>Use the Add Mounted File System (ADDMFS) command to mount the user-defined file system (UDFS) specified in the CPFA0D7 message over a directory of your choice. Then use the Display Link (DSPLNK) command to view the contents of this UDFS. You may see objects with names beginning with 'QRCL' or you may see a directory named 'QReclaim'. If you see the 'QReclaim' directory, look inside it to find the object names beginning with 'QRCL'. These objects were previously lost but have been relocated by the RCLSTG command. Use the Move (MOV) command to move these objects back to their original location. The original object names may be specified in the CPFA0D7 message. If the original names are not available, use the "Display Attributes" option in DSPLNK to view an object's attributes in order to attempt to identify it.</p>
<p>Type WRKOBJOWN QDFTOWN to display objects that are owned by the QDFTOWN user profile.</p>	<p>Use option 9 (Change owner) from the Work with Objects by owner display to transfer ownership to the correct user profile.</p>
<p>Type DSPAUTLOBJ QRCLAUTL to display objects that are secured by the QRCLAUTL authorization list.  <b>Note:</b> If the reclaim storage procedure did not assign any objects to the QRCLAUTL authorization list, you may receive a message that the authorization list is not found. Ignore the message.</p>	<p>If necessary, assign the object to the correct authorization list by using the Edit Object Authority (EDTOBJAUT) command.</p>

## Reclaim Object Links

- | The Reclaim Object Links (RCLLNK) command reclaims objects in "root" (/), QOpenSys, and mounted user-defined file systems.
- | The RCLLNK command has three parameters. These parameters allow you to perform reclaim functions in the following ways:
  - | **OBJ** Specifies the object to be reclaimed.
  - | **SUBTREE** Specifies whether or not to reclaim the objects within the subtree if the object specified by the OBJ parameter is a directory.
  - | **DMGOBJOPT** Specifies how damaged objects are handled during the reclaim.
- | Use these examples to better understand situations in which the Reclaim Object Links (RCLLNK) command can be used to reclaim objects in the "root" (/), QOpenSys, and mounted user-defined file systems.
- | Correct problems for an object in a directory subtree

| In this situation, the known problems are isolated to one object. The object is damaged and unusable, and  
| a backup version of the object cannot be restored from media. To correct the problem quickly without  
| disrupting normal file system operations, you can use this command:

```
| RCLLNK OBJ('/MyDir/MyBadObject')  
| SUBTREE(*NONE), where '/MyDir/MyBadObject'
```

| is the damaged and unusable object.

#### | **Correct problems that exist in a directory subtree**

| In this situation, the known problems are isolated to a group of objects within a directory subtree. The  
| problems need to be corrected quickly without disrupting normal file system operations. To reclaim the  
| objects within the directory subtree, you can use this command:

```
| RCLLNK OBJ('/MyApplicationInstallDirectory') SUBTREE(*ALL),  
| where '/MyApplicationInstallDirectory'
```

| is the "root" directory of the subtree containing the problems.

#### | **Find all damaged objects in the "root" (/), QOpenSys, and mounted user-defined file systems**

| In this situation, a disk failure has caused damage to a number of objects. The damaged objects need to  
| be identified before determining how to properly recover them. The solution required needs to identify  
| the damaged objects, but not take action against them and must not disrupt normal file system  
| operations. To identify the damaged objects, you can use this command:

```
| RCLLNK OBJ('/') SUBTREE(*ALL) DMGOBJOPT(*KEEP *KEEP)
```

| It will also correct problems other than damaged objects as it identifies damaged objects.

#### | **Delete all damaged objects in the "root" (/), QOpenSys, and mounted user-defined file systems**

| In this situation, a disk failure has caused a number of objects to become damaged. The damaged objects  
| need to be deleted so backup copies can be restored from media. To delete the damaged objects, you can  
| use this command:

```
| RCLLNK OBJ('/') SUBTREE(*ALL) DMGOBJOPT(*DELETE *DELETE)
```

| The damaged objects will be deleted without disruption to normal file system operations. In addition,  
| problems other than damage are corrected as the damaged objects are being deleted.

| For more information about the RCLLNK command see Integrated File System in the iSeries Information  
| Center, <http://www.ibm.com/eserver/series/infocenter>.

---

## **Controlling Restoration of Security-Sensitive Objects**

You can use two different system values to control the restoration of security-sensitive objects:

- Allow object restore operation (QALWOBJRST).
- Verify object on restore (QVfyOBJRST).

The QALWOBJRST system value determines whether objects that are security-sensitive may be restored to your system. It allows you to determine how the system restores objects with digital signatures.

You can find information about system values and managing them through iSeries Navigator in the Information Center at <http://www.ibm.com/eserver/series/infocenter>. See **Systems management** —> **System values**.

### QALWBJRST system value

You can use QALWBJRST to prevent anyone from restoring a system-state object or an object that adopts authority. The QALWBJRST system value affects programs, service programs, modules, and SQL packages.

When your system is shipped, the QALWBJRST system value is \*ALL. This value is necessary to install your system successfully.

#### **Attention!**

It is important to set the QALWBJRST value to \*ALL before performing some system activities, such as:

- Installing a new release of the i5/OS licensed program.
- Installing new licensed programs.
- Recovering your system.

These activities may fail if the QALWBJRST value is not \*ALL.

If you are applying PTFs, set the QALWBJRST value to \*ALWPTF.

To ensure system security, return the QALWBJRST value to your normal setting after completing the system activity. Make sure the entire restore operation has completed before changing the QALWBJRST system value, or some objects may not restore successfully.

You may specify multiple values for the QALWBJRST system value, unless you specify \*ALL or \*NONE.

#### *Possible Values for the QALWBJRST System Value:*

<b>*ALL</b>	Any object may be restored to your system by a user with the proper authority.
<b>*NONE</b>	Security-sensitive objects, such as system state programs or programs that adopt authority, may not be restored to the system.
<b>*ALWSYST</b>	System state objects may be restored to the system.
<b>*ALWPGMADP</b>	Objects that adopt authority may be restored to the system.
<b>*ALWPTF</b>	Security-sensitive objects may be restored only when the restore is part of a Program Temporary Fix (PTF) operation.
<b>*ALWSETGID</b>	Allows the system to restore files with the S_ISGID attribute enabled
<b>*ALWSETUID</b>	Allows the system to restore files with the S_ISUID attribute enabled
<b>*ALWVLDERR</b>	Allows the system to restore objects with validation (CRC) errors.

#### *How to Set the QALWBJRST System Value to Allow Complete Recovery*

1. Type WRKSYSVAL QALWBJRST and press the Enter key.
2. You are shown the Work with System Values display. Type 5 (Display) in the Opt column next to QALWBJRST and press the Enter key.
3. You are shown the Display System Value display. Write down the current setting for use after you complete your recovery. If the value is \*ALL, you do not need to change it for your recovery. Skip to step 6 on page 42.

4. Press F12 to return to the Work with System Values display. Type 2 (Change) in the Opt column next to QALWOBJRST and press the Enter key.
5. You are shown the Change System Value display. Type \*ALL for the value and press the Enter key.
6. Press F12 to cancel the Work with System Values display.

#### *How to Set the QALWOBJRST System Value to Restrict Restore Operations*

1. Type WRKSYSVAL QALWOBJRST and press the Enter key.
2. You are shown the Work with System Values display. Type 2 (Change) in the Opt column next to QALWOBJRST and press the Enter key.
3. You are shown the Change System Value display. Type the value you wrote down in step 3 on page 41 of **How to set the QALWOBJRST System Value to Allow Complete Recovery**. Press the Enter key.
4. Press F12 to cancel the Work with System Values display.

#### **QVIFYOBRST system value**

You can add digital signatures to objects so that users can verify the object's integrity and origin. The objects affected by the QVIFYOBRST system value are as follows:

- \*CMD
- \*PGM
- \*SRVPGM
- \*SQLPKG
- \*MODULE
- \*STMF objects with attached Java programs

You need to install Digital Certificate Manager (i5/OS option 34) before you can use the QVIFYOBRST system value to verify objects not signed by IBM. If Digital Certificate Manager is not installed, the system treats user-state objects being restored as unsigned objects even if they contain digital signatures. You do not need to restart your system for changes to this value to take effect. You can find more information about digital signatures in the Information Center at the following Web site:

<http://www.ibm.com/eserver/iseres/infocenter>

The QVIFYOBRST system value allows you to control signature verification of objects during a restore operation. The QVIFYOBRST system value has five options (option 3 is the default):

1. **Do not verify signatures on restore.**  
This is the only option that restores system-state or inherit-state objects without valid IBM-generated signatures.  
This option should not be used unless you have a large number of signed objects to restore which will fail their signature verification for some acceptable reason. Allowing a system-state or inherit-state object without a valid signature to restore represents an integrity risk to your system. If you choose to restore such an object onto your system by selecting this option, be sure to change it back to its previous value after the object has been restored.
2. **Verify: Restore unsigned objects; Restore signed object, even if signatures are not valid.**  
Restores unsigned user-state objects. Restores signed user-state objects, even if signatures are not valid. Does not restore system-state or inherit-state objects without valid IBM-generated signatures. This option should be used only if there are specific objects with signatures that are not valid which you want to restore. In general, it is dangerous to restore objects with signatures that are not valid on your system.
3. **Verify: Restore unsigned objects; Restore signed objects only if signatures are valid.**  
Restores unsigned user-state objects. Restores signed user-state objects only if signatures are valid. Does not restore system-state or inherit-state objects without valid IBM-generated signatures.

4. **Verify: Do not restore unsigned objects; Restore signed objects, even if signatures are not valid.**  
Does not restore unsigned user-state objects. Restores signed user-state objects, even if signatures are not valid. Does not restore system-state or inherit-state objects without valid IBM-generated signatures.
5. **Verify: Do not restore unsigned objects; Restore signed objects only if signatures are valid.**  
Does not restore unsigned user-state objects. Restores signed user-state objects only if signatures are valid. Does not restore system-state or inherit-state objects without valid IBM-generated signatures. This option is the most restrictive option and should be used when the only objects you want to allow to be restored are those which have been signed by trusted sources.

**Attention!**

It is important to set the QVfyOBJRST value to **1** before performing some system activities, such as:

- Installing a new release of the i5/OS licensed program.
- Recovering your system.

These activities may fail if the QVfyOBJRST value is not **1**.

#### *How to Set the QVfyOBJRST System Value to Allow Complete Recovery*

1. Type WRKSYSVAL QVfyOBJRST and press the Enter key.
2. You are shown the Work with System Values display. Type 5 (Display) in the Opt column next to QVfyOBJRST and press the Enter key.
3. You are shown the Display System Value display. Write down the current setting for use after you complete your recovery. If the value is 1, you do not need to change it for your recovery. Skip to step 6.
4. Press F12 to return to the Work with System Values display. Type 2 (Change) in the Opt column next to QVfyOBJRST and press the Enter key.
5. You are shown the Change System Value display. Type 1 for the value and press the Enter key.
6. Press F12 to cancel the Work with System Values display.

#### *How to Set the QVfyOBJRST System Value to Restrict Restore Operations*

1. Type WRKSYSVAL QVfyOBJRST and press the Enter key.
2. You are shown the Work with System Values display. Type 2 (Change) in the Opt column next to QVfyOBJRST and press the Enter key.
3. You are shown the Change System Value display. Type the value you wrote down in step 3 of **How to Set the QVfyOBJRST System Value to Allow Complete Recovery**. Press the Enter key.
4. Press F12 to cancel the Work with System Values display.

---

## **Minimizing Object Scans After Restores**

At V5R3, i5/OS provides the capability to scan objects in the integrated file system for things like viruses and file usage. As part of this support, one can specify a scan attribute for integrated file system objects so that they are never scanned, or are scanned only after the object is changed. The default scan attribute value is that the objects will be scanned if object scanning is implemented for the integrated file system. Additionally, the Scan file systems control (QSCANFCTL) system value was introduced in conjunction with this function. One of the default options for QSCANFCTL is that all objects will be scanned on first access after the object is restored even if the scan attribute for the object is to never be scanned or to scan only if the object is changed.

If you are restoring objects from trusted sources or are restoring from saves where a scan was done as part of the save, and the trusted source or you have set the scan attributes to never be scanned or to scan only if the objects are changed, you might want to take action to prevent the scans during the first access

of the objects after they are restored. To prevent the scan that occurs after the restore, you must specify \*NOPOSTRST on the QSCANFCTL system value before the restores are started. After your restore is complete, you should consider removing the \*NOPOSTRST option on the QSCANFCTL system value so that on subsequent restores objects will be scanned on first access after an object is restored, regardless of what attribute is specified.

*How to set the QSCANFCTL system value to minimize object scans after restores*

1. Type WRKSYSVAL QSCANFCTL and press the Enter key.
2. You are shown the Work with System Values display. Type 5 (Display) in the Opt column next to QSCANFCTL and press the Enter key.
3. You are shown the Display System Value display. Write down the current settings for use after you complete your recovery. If the value \*NOPOSTRST is already specified, you do not need to change it for your recovery. Skip to step 6.
4. Press F12 to return to the Work with System Values display. Type 2 (Change) in the Opt column next to QSCANFCTL and press the Enter key.
5. You are shown the Change System Value display. Type \*NOPOSTRST. If \*NONE is specified currently, replace the \*NONE value. If any other values are specified, add \*NOPOSTRST as an additional value. Press the Enter key.
6. Press F12 to cancel the Work with System Values display.

For more information on scanning support for the integrated file system, see **Files and file systems** -> **Integrated file system** -> **Concepts** -> **Scanning support** in the iSeries Information Center, <http://www.ibm.com/eserver/series/infocenter>.

## How to Set the QPFRADJ System Value for a Different Processor or Memory

1. Type WRKSYSVAL QPFRADJ and press the Enter key.
2. You are shown the Work with System Values display. Type 2 (Change) in the option column next to QPFRADJ and press the Enter key.
3. You are shown the Change System Value display. Change the value to 2 (Adjustment at IPL and automatic adjustment) and press the Enter key.
4. Press F12 to cancel the Work with System Values display.

## Locked Objects While Restoring

In general, an object is locked to prevent a read operation while it is being restored. If the system cannot obtain a lock on an object within the specified time, that object is not restored and a message is sent to the job log.

Table 6 shows the type of lock that is required to restore objects:

*Table 6. Lock Type Needed for Restore Operation*

Object Type	Lock Type Needed for Restore Operation
Most object types	*EXCL
Job queue	*SHRRD
Output queue	*SHRRD
Message queue	*EXCLRD
Library, during RSTLIB command	*SHRUPD
Library, when object is being restored to it	*SHRUPD

If you restore an Original Program Model (OPM) program that is running, the program may end abnormally.

---

## How to verify that objects are restored successfully

You can use the joblog or an output file to determine which objects are restored successfully.

**Note:** The system does not restore files to libraries QGPL and QUSRSYS if the file names begin with QAPZ. No diagnostic message is sent indicating that these files are not restored.

*Using the Job Log:* The restore commands send these messages:

- | **CPC370E**  
|       Objects restored from media.
- | **CPC370F**  
|       Objects restored from a save file.
- | **CPC3703**  
|       Sent for each library that is restored.
- | **CPF3773**  
|       Tells the number of objects that are restored and are not restored.
- | **CPF3839**  
|       Message for RST command from media, tells if it has been restored or not.
- | **CPF383E**  
|       Message for RST command from a save file, tells if it has been restored or not.
- | **CPF9003**  
|       Completion message for RSTDLO command from media.
- | **CPF909B**  
|       Completion message for RSTDLO command from a save file.

These messages tell the number of objects that are restored and the number of objects that are not restored. An object is counted only if it fits the selection values you specified. For example, assume that library LIB1 has 75 objects. The names of 74 of those objects begin with the characters ORD. You specify RSTOBJ OBJ(ORD\*) OBJTYPE(\*ALL) SAVLIB(LIB1). If all objects restored successfully, the completion message would say that 74 objects were restored to library LIB1. You would not be notified that 1 object was not restored.

A diagnostic message is sent if:

### **An object could not be restored.**

When the system cannot restore an object successfully, it is usually because:

- The object exists on the system and is being used. Restoring an object requires an exclusive lock for most object types.
- The object is being saved or restored by another job.
- The object on the media is damaged.
- The user does not have the necessary authority to restore the object.
- The object does not have a valid signature.
- The object type is not supported in an independent ASP.
- The user profile does not exist on the system.
- The system found a validation error.

### **Security information was changed.**

Under some conditions, the system may:

- Revoke public and private authority
- Change object ownership.
- Change the object's primary group.
- Not link to the authorization list.

See "Sequence for Restoring Security Information" on page 201 for more information.

#### **An integrity change occurred.**

- Journaling could not be started for an object that was being journaled at the time of the save operation or when the QDFTJRN data area indicates journaling should be started for the object.
- A logical file is restored over a deleted and re-created physical file.
- The QAUDJRN (audit) journal was created by the system. You receive message CPF7088. If you restore the operating system and the QAUDLVL system value is not \*NONE, the system creates the QAUDJRN if it does not exist. This ensures that security auditing is restarted for your system.

**Using An Output File:** Most restore commands create output that shows what was restored. You can direct this output to a printer (OUTPUT(\*PRINT)), a database file (OUTPUT(\*OUTFILE)), a stream file, or a user space. The default for restore commands is not to create output. You must request it each time you run the restore command. Or you can change the default for the OUTPUT parameter for restore commands by using the Change Command Default (CHGCMDDFT) command.

You can print the output and save it. Or you can create a program to analyze and report on the information in the output file.

You can use the OUTPUT parameter with these commands:

RST	RSTDLO	RSTOBJ
RSTCFG	RSTLIB	RSTUSRPRF

The online information for the restore commands tells the names of the model database outfiles they use for output.

#### **Notes:**

1. The output file you specify is in use throughout the restore operation. Therefore, the system cannot restore it as part of the operation. Depending on how you perform your restore operation, you may see a CPF379D message in the joblog for the output file. If you want to restore the output file after your restore operation completes, use the RSTOBJ command.
2. The RST command places output in a stream file or a user space, rather than an output file.
3. See the iSeries Information Center for more information about output from the save and restore commands. The RSTLIB, RSTOBJ, and RST commands have an information type (INFTYPE) parameter to specify how much detail you want in the output file.

---

## **Recovery from an Unsuccessful Restore Operation**

A restore operation can be unsuccessful either because an error was encountered when trying to restore an object or because the operation was interrupted. If the object existed on the system before the restore operation, it may be damaged by the unsuccessful restore operation.

An object is not restored when an error is encountered. The error is either recoverable or not.

**Restore Operation Error Is Recoverable:** If an object cannot be restored and the error is recoverable, the following occurs:



- A diagnostic message is sent to the job log for each object that is not restored. The message ID can vary, depending on why the object was not restored.
- Each object that is associated with the errors is not restored. However, other objects not associated with the errors but involved in the same restore operation are restored.
- Only the save and restore status information for the objects that were successfully restored is updated.
- A count of the number of objects successfully restored and a count of the number of objects not restored are sent to the user in a diagnostic message.

**Restore Operation Error Is Not Recoverable:** If the error is not recoverable, the following occurs:

- Diagnostic messages are sent to the job log for each object.
- The save and restore status information for each object is not updated.
- A diagnostic message that identifies the error condition is sent to the user.
- The restore command ends immediately. No other objects are restored.

## Recovering from an Error While Restoring Libraries

Some errors that occur during a restore operation stop the operation. Following are a few examples of this type of error:

- An unrecoverable media error.
- Exceeding the maximum storage specified in the user profile of the user running the restore operation or in a user profile that owns objects that are being restored.

If an error stops the restore operation, you can correct the error condition and then start the restore operation where it ended. For example, if the maximum storage is exceeded, you can increase the MAXSTG parameter in the user profile.

You can use the STRLIB parameter on the RSTLIB command to restart the restore operation. The STRLIB parameter is valid only when \*NONSYS, \*ALLUSR, or \*IBM is specified for the restore operation,

The basic recovery steps for a restore operation are:

1. Check the job log to determine the library where the previous RSTLIB SAVLIB(\*NONSYS, \*IBM, or \*ALLUSR) failed. Find the last library that is restored which is indicated by a successful restore completion message.
2. Load the media volume of the SAVLIB LIB(\*NONSYS, \*ALLUSR, or \*IBM) media.
3. Type the following and press the Enter key:
 

```
RSTLIB SAVLIB(*NONSYS, *IBM or *ALLUSR)
      DEV(media-device-name) ENDOPT(*LEAVE)
      STRLIB(library-name)
      OMITLIB(library-name)
```

  - If the restore operation stopped because of a media error that you cannot correct, the *library-name* for the STRLIB and the OMITLIB parameters should be the library where the restore operation failed. This causes the operation to start with the library after that library.
  - If the failure was not related to a media error, the *library-name* for the STRLIB and the OMITLIB parameters should be the name of the last library that was successfully restored. This causes the operation to start with the library that caused the error.
4. You will be asked to load the volume that contains the starting library.
5. After the restore operation is complete, restore the library that failed using the media from a previous save operation.

**Note:** Consider eliminating the media volume with the media error from the next save.

## Recovering from an Error While Restoring DLOs

Some errors that occur during a restore operation stop the operation. Following are a few examples of this type of error:

- An unrecoverable media error.
- Exceeding the maximum storage specified in the user profile of the user running the restore operation or in a user profile that owns objects that are being restored.

If an error occurs that stops the restore operation, you can correct the error condition and then start the restore operation where it ended. For example, if the maximum storage is exceeded, you can increase the MAXSTG parameter in the user profile.

If an unrecoverable error occurs when running the RSTDLO DLO(\*ALL) SAVFLR(\*ANY) command, you must determine where the failure occurred and continue the restore operation step-by-step. Do the following:

1. Check the job log to determine if the failure occurred on a distribution object or a folder. The job log may identify where the failure occurred.
2. If the failure occurred on a folder, go to “Recovering Documents and Folders.”

### Recovering Documents and Folders

If an unrecoverable error occurs during the RSTDLO procedure, you can restart the procedure by using the SAVFLR parameter on the RSTDLO command.

The basic recovery steps for a restore operation are:

1. Check the job log to determine where the previous RSTDLO DLO(\*ALL) command failed. The job log identifies which folder failed to restore.

**Note:** If the failure occurred during the restore of mail, you need to restore all documents and folders.

2. Find the first folder after the folder that failed to restore. Use the list that was created during the last SAVDLO OUTPUT(\*PRINT or \*OUTFILE) operation or use the DSPTAP DATA(\*SAVRST) command to determine which first-level folder is next. To find the first-level folders, find the object type \*FLR. Look at the *Document or Folder Information* column. The name of a first-level folder does not contain a forward slash (/).
3. Load the first media volume of the SAVDLO DLO(\*ALL) save media.

**Note:** You must always start with the first volume of the SAVDLO media for each set of 300 first-level folders. You must load each volume in the set of SAVDLO save media in sequence.

4. For each first-level folder, type the following and press the Enter key:

```
RSTDLO DLO(*ALL) SAVFLR(folder-name-list)  
      DEV(media-device-name)
```

Where the *folder-name-list* has the names of the first-level folders identified from the list described in step 2. You can specify a limit of 300 first-level folders.

Repeat this step for each set of 300 first-level folders.

### Recovering from Unsuccessful System Signon

If you are utilizing additional workstations to run concurrent restores after i5/OS has been recovered, but before the server has been IPLed, you may be unable to sign on to these workstations. You may have received message CPF4101, “File xxx in library xxx not found or inline data file missing.” If this library has already been restored to the system, you can resolve the problem by editing the QSYSLIBL system value. Use the CHGSYSVAL command and add the missing library to QSYSLIBL (even if it is already listed). Perform another operation to remove the library you just added.

As an alternative, you can IPL the server to resolve the signon problem, if the libraries listed in the QSYSLIBL and QUSRLIBL system values have been restored.

---

## How to Perform a Normal IPL

You should perform a normal IPL at the end of any recovery before allowing users to resume normal activity. Do the following:

1. Place the system in Normal mode.

### Using Logical Partitions?:

If you are using logical partitions, perform these steps on the console of the logical partition on which you want to perform an IPL:

- a. Type STRSST on the command line and press Enter.
- b. On the System Service Tools display, select option 5 to work with system partitions, and press Enter.
- c. On the Work with System Partitions display, select option 2 to work with system partition status, and press Enter.
- d. On the Work with System Partition Status display, select normal mode by typing a 9 in the Option field. Press Enter.
- e. Press F3 until you see the Exit System Service Tools display. On the Exit System Service Tools display, press Enter.

If you are using logical partitions with a Hardware Management Console (HMC), perform these steps on the console of the logical partition on which you want to perform an IPL:

- a. Expand your **Management Environment** in your HMC.
- b. Expand your **Server**.
- c. Expand **Server and Partition**.
- d. Click on **Server Management**.
- e. Expand **Partitions**.
- f. Select a partition.
- g. Right click on the partition and select **Properties**.
- h. In the Partition Properties window, click the **Settings** tab.
- i. Under the Boot category change the **Keylock position** to Normal.
- j. Click on the **OK** button.

2. Ensure that no users are signed on and no jobs are active.
3. If you are not using logical partitions, continue with the next step. Otherwise, if you are performing this operation from the primary partition, be sure to power down all secondary partitions.
4. Type the following on a command line and press the Enter key:  
`PWRDWN SYS OPTION(*IMMED) RESTART(*YES)`
5. When the IPL is complete, sign on the system.
6. Start any other subsystems that need to be started, such as QTCP or QSNADS.  
`STRSBS SBS(subsystem-name)`

---

## Parallel Restore Operations

You can perform restore operations while using more than one device simultaneously. The data that you restore in this manner must have been saved in parallel format. You can use the Restore Library (RSTLIB), Restore Object (RSTOBJ), and Restore (RST) commands in conjunction with a media definition to perform a parallel restore. You can use a media definition with the RSTLIB command to restore \*ALLUSR, \*IBM, and \*NONSYS libraries that were saved with a media definition.

| In general restoring from a parallel save is usually faster. This is usually true when restoring an entire  
| library or restoring any objects that were saved near the start of a given tape file than restoring from a  
| serial save.. However, there are cases where restoring individual objects from a parallel save can take  
| significantly longer than restoring from a serial save. This situation can occur if the object to be restored  
| is near the end of the tape file

It may be possible to restore from a parallel save if you are using fewer devices than the save operation used. However, IBM does not recommend this, due to the amount of volume switching that you will need to do. IBM also does not recommend this due to performance reasons. If you are restoring files with constraints, you must use the same number of devices for the restore as you used for the save. Restore operations that use fewer drives should only be used to restore individual objects. Restore operations that use fewer drives should never be used as part of a system recovery strategy, or to restore large amounts of data. Whenever possible, the same number of devices that were used during the save operation should be used during a restore operation.

A Display Tape (DSPTAP) command displays the list of objects that the system saves across all media files. You only need one media file to **display** all of the objects that the system saved during a parallel save operation. This list also displays the number of media files that you need to restore data. However, you need all of the media files to **restore** any of the objects that the system saved. This may include multiple volumes.

IBM recommends that you use the same media definition object when saving and restoring the same objects. If you use a different media definition object when restoring, make sure that the same number of media files are defined within that media definition object. If the number of media file definitions is different from the number that exists on the storage media, you will receive an error message.

Refer to the Information Center

<http://www.ibm.com/eserver/iseriess/infocenter/>

for information about the Create Media Definition API which defines the devices, media, and data format to be used in parallel save or restore operation.

---

## Chapter 3. Selecting the Appropriate Recovery Strategy

Use this chapter to determine the correct procedure for system. Before beginning your recovery, you must do the following:

- Make sure you understand what has caused the problem. Understanding the cause helps you choose the correct recovery steps.
- Plan your recovery. Use Table 7 on page 54 to find the appropriate recovery checklist for your situation.
- Make a copy of the checklist and check off each step as you complete it.
- Keep the checklist for future reference.
- Keep a record of what you have already done and what you do for the rest of your recovery. This record is important if you need help later.
- If your problem requires hardware or software service, make sure you understand what the service representative did. Do not be afraid to ask questions, such as:
  - Was a disk unit replaced? If yes, which one?
  - Was the Licensed Internal Code restored? If yes, what option from the Install Licensed Internal Code (LIC) menu was used?
  - Did the disk configuration need to be recovered? Was it successful?
  - Could the failed disk unit be pumped? How successfully?

---

### Some Common Recovery Terminology

You may need to understand these terms when discussing your situation with your service representative or software support:

Term	Definition
Abnormal end (abend)	A system failure or operator action that causes the system to end without being able to end all jobs and close all files. Your system may end abnormally because of a power failure or a problem with certain hardware or software components.
Auxiliary storage pool	A group of disk units defined from all the disk units that make up auxiliary storage. Auxiliary storage pools (ASPs), also known as disk pools in iSeries Navigator, allow you to isolate objects on one or more specific disk units. This may reduce the loss of data due to a disk media failure. In most cases, only data stored on disk units in the affected ASP is lost.
ASP group	An auxiliary storage pool (ASP) group is made up of a primary ASP and zero or more secondary ASPs. Each ASP is independent in regard to data storage, but in the ASP group they combine to act as one entity. If one ASP is made available or unavailable, the rest of the ASPs in the group are also made available or unavailable at the same time. In a clustered environment, all of the ASPs in a group switch to another node at the same time. The primary and secondary ASPs also share the same database.
Basic ASP	A user auxiliary storage pool created by grouping together a physical set of disk units and assigning them a number between 2 and 32. A basic ASP is always available for data storage and access.
Dedicated service tools (DST)	A set of tools to work with the system when the operating system is not available or not working.
Disk configuration	An internal system table that tells how the physical disk units are arranged on your system. The disk configuration is used to assign units to an auxiliary storage pool. The disk configuration is stored on the load source unit.
Disk pump	A commonly used term for the procedure used by a service representative to attempt to copy data from a disk unit that has failed.

Term	Definition
Independent ASP	A user auxiliary storage pool that can be made available (varied on) and made unavailable (varied off) without restarting the system. An independent ASP can be either switchable among multiple systems in a clustering environment or privately connected to a single system.
Library user ASP	A user ASP that contains libraries, directories, and folders and all the objects associated with them.
Licensed Internal Code	The layer of iSeries architecture just above the hardware. You must have the Licensed Internal Code on your machine before you can restore the operating system.
Load source unit	The first unit (unit 1) in the system ASP. It contains the Licensed Internal Code and the disk configuration for your system.
Nonlibrary user ASP	A user ASP that may contain journals, journal receivers, and save files. The libraries associated with these objects are in the system ASP. A nonlibrary user ASP is sometimes called an <b>old-style ASP</b> , because it was the only type of user ASP available before Version 1 Release 3 of the OS/400 <sup>®</sup> licensed program.
Primary ASP	An independent auxiliary storage pool (ASP) that defines a collection of directories and libraries and may have other secondary ASPs associated with it. A primary ASP defines a database for itself and other ASPs that may be added in its ASP group. Primary ASPs can only be implemented on V5R2 or later of i5/OS.
Secondary ASP	An independent ASP that defines a collection of directories and libraries and must be associated with a primary ASP in an ASP group. A possible use for a secondary ASP is to store journal receivers for objects being journaled in the primary ASP. Secondary ASPs can only be implemented on V5R2 or later of i5/OS.
System ASP	An auxiliary storage pool that is created by the system and always configured. The system ASP (ASP 1) contains the Licensed Internal Code, licensed programs, and system libraries. The system ASP may also contain user libraries, folders, and directories. The system ASP contains all configured disk units that are not assigned to a user ASP.
System service tools (SST)	A subset of the DST tools. The tools available through SST, such as displaying the disk configuration, can be used while the operating system is running and other users are on the system.
User ASP	A basic or independent auxiliary storage pool created by grouping together a physical set of disk units. You can assign a basic ASP a number between 2 and 32. When you create an independent ASP, you specify a name; the system then assigns the independent ASP a number between 33 and 255. ASP 1 is always reserved as the system ASP.
UDFS ASP	An independent auxiliary storage pool (ASP) that contains only user-defined file systems. It cannot be a member of an ASP group unless it is converted to a primary or secondary ASP. For conversion instructions, see iSeries Navigator online help for Disk Units, or the Independent Disk Pools topic in the iSeries Information Center at <a href="http://www.ibm.com/eserver/series/infocenter">http://www.ibm.com/eserver/series/infocenter</a> .

---

## Recovery Procedure for a Power Failure

If your system stops because power is lost, you need to follow special procedures when you start the system again. Chapter 6, “Starting the System After It Ends Abnormally,” on page 155 describes this procedure.

If you experience frequent power outages, consider using an uninterruptible power supply for your system.

If power loss to workstations causes your system to perform constant error recovery, you should modify your applications to handle losing communications to workstations. Chapter 24, “Examples: Techniques and Programming for Backup and Recovery,” on page 439 describes how to do this.

---

## Recovery Procedure for a System Failure

A system failure is a problem either with hardware (other than DASD) or with operating system software that causes your system to end abnormally. After your service representative has corrected the problem, follow the procedure to start your system after an abnormal end. Chapter 6, “Starting the System After It Ends Abnormally,” on page 155 describes the procedure.

If the service representative replaced a disk unit, use the information in “Choosing the Recovery Procedure for a Disk Failure or Disk Errors” to determine the correct recovery procedure.

---

## Recovery Procedure for a Program Failure or Human Error

You may need to recover objects because a program updated them incorrectly or because a user deleted them. Review the information in Chapter 9, “How to Restore Specific Types of Information,” on page 201 for the kind of objects you are restoring. Some objects have special considerations or need to be restored in a particular sequence.

If you are restoring an object that does not exist on the system, private authorities for the object are not restored with it. You can do one of the following:

- Reconstruct the private authorities manually, using the Edit Object Authority (EDTOBJAUT) display.
- Restore private authorities by using this procedure:
  1. Restore all user profiles from your most recent SAVSYS or SAVSECDTA tape. Type: RSTUSRPRF. Restoring user profiles requires a restricted state.
  2. Restore the objects you need to recover.
  3. Restore authorities. Type: RSTAUT. Only one RSTAUT command can run on the system at any given time.

---

## Choosing the Recovery Procedure for a Disk Failure or Disk Errors

### Attention

If you receive an SRC code that indicates a DASD problem, do not perform an IPL before your service representative arrives. If you perform an IPL, your service representative may not be able to recover data from the damaged disk unit.

This topic describes the actions that you take if you are recovering because a disk unit failed or was damaged. The steps you follow to recover from a disk failure depend on:

- What unit failed.
- Whether disk protection, such as device parity protection or mirrored protection is active.
- Whether you have user ASPs configured.
- Whether some or all of the sectors on the disk are damaged. If a disk unit must be replaced, a service representative normally tries to copy the information from the disk unit when it is replaced. This procedure is sometimes referred to as a disk pump.

Use Table 7 on page 54 to determine what recovery procedure you should follow, based on the failure that has occurred on your system. To find your situation on the chart, ask your service representative whether data was copied successfully (the results of the disk pump):

---

### Service Representative Terminology

Full pump  
Partial pump

---

### Terminology in Recovery Charts

None of the data is lost  
Some of the data is lost

## Service Representative Terminology

Could not pump

## Terminology in Recovery Charts

All of the data is lost

**Recovery for Disk Errors That Do Not Require Disk Replacement:** Some types of disk units automatically recover from errors without needing to be replaced. In some cases, however, sectors are damaged before the disk unit reassigns them and some object damage occurs. If you receive a message indicating that object damage has occurred and disk sectors have been reassigned, consider this to be the value *Some* for the column *Data Loss on the Failed Unit* in Table 7.

If you are recovering from disk errors but you did not need a service representative to replace the disk unit, you may need to perform tasks that are normally performed by a service representative. Make a copy of the appropriate checklist and mark it as follows:

1. Begin at the task immediately following “Attach the new disk unit”.
2. If the checklist contains a task called, “Restore the disk unit data”, skip that task.

*Table 7. Choosing the Correct Recovery Procedure for Disk Media Failure*

Type of Unit That Failed	Data Loss on Failed Unit	Availability Protection on Failed Unit	User ASPs Configured?	Procedure to Follow
Any	N/A	Mirrored protection	N/A <sup>1</sup>	Checklist 14 on page 80
Any	N/A	Device parity protection	N/A <sup>1</sup>	Checklist 15 on page 81
Load source unit	None	None	N/A <sup>1</sup>	Checklist 1 on page 55
Load source unit	Some <sup>2</sup>	None	N/A <sup>1</sup>	Checklist 2 on page 56
Load source unit	All	None	No	Checklist 3 on page 57
Load source unit. No basic ASPs in overflowed status <sup>3</sup>	All	None	Yes	Checklist 4 on page 58
Load source unit. One or more basic ASPs in overflowed status <sup>3</sup> .	All	None	Yes	Checklist 5 on page 62
Non-load source unit in system ASP <sup>4</sup>	None	None	N/A <sup>1</sup>	Checklist 6 on page 66
Non-load source unit in system ASP <sup>4</sup>	Some <sup>2</sup>	None	N/A <sup>1</sup>	Checklist 7 on page 66
Non-load source unit in system ASP <sup>4</sup>	All	None	No	Checklist 8 on page 67
Non-load source unit in system ASP <sup>4</sup> . No basic ASPs in overflowed status <sup>3</sup> .	All	None	Yes	Checklist 9 on page 68
Non-load source unit in system ASP <sup>4</sup> . One or more basic ASPs in overflowed status <sup>3</sup> .	All	None	Yes	Checklist 10 on page 72
Disk unit in basic ASP	None	None	Yes	Checklist 6 on page 66
Disk unit in basic ASP	Some <sup>2</sup>	None	Yes	Checklist 11 on page 76



Table 7. Choosing the Correct Recovery Procedure for Disk Media Failure (continued)

Type of Unit That Failed	Data Loss on Failed Unit	Availability Protection on Failed Unit	User ASPs Configured?	Procedure to Follow
Disk unit in basic ASP. Failed unit not in overflowed status <sup>3</sup> .	All	None	Yes	Checklist 12 on page 76
Disk unit in basic ASP. Failed unit in overflowed status <sup>3</sup> .	All	None	Yes	Checklist 13 on page 78
Disk unit in independent ASP	None	None	Yes	Checklist 17 on page 82
Disk unit in independent ASP	Some <sup>2</sup>	None	Yes	Checklist 18 on page 83
Disk unit in independent ASP	All	None	Yes	Checklist 19 on page 84
Cache storage in IOP	Some	N/A	N/A <sup>1</sup>	Checklist 23 on page 94

<sup>1</sup> The recovery procedure is the same whether or not user ASPs are configured.

<sup>2</sup> If the service representative was partially successful in saving data from a failed disk unit, you should consider treating the situation as a complete data loss on the failed unit.

<sup>3</sup> Step 4 on page 180 describes how to determine whether a user ASP is in overflowed status.

<sup>4</sup> If a unit in your system ASP fails and a replacement is not immediately available, you can use the procedure in Checklist 16 on page 81. This procedure allows you to return your system to operation. You will have less disk storage and you will need to recover all the data in the system ASP.

## Actions for load source disk unit failure—Checklist 1

This checklist should be used for the following problem situation:

### Failed Unit:

Load source unit

### Data Loss:

None

### User ASP Configured:

N/A

**Before you begin your recovery**, make a copy of this checklist. Fill in the appropriate areas as you and the service representative perform the recovery steps. This checklist provides an important record of your recovery actions. It may help you to diagnose any problems that occur after the recovery. It may also be useful in evaluating your backup strategy.

Most steps in the checklist include references to other topics in this book. Refer to these topics if you need more information about how to perform a particular step. You may not need to perform some steps, such as restoring changed objects, if they do not apply in your situation.

**Note:** When your load source unit is failed and you are recovering from distribution media with Operations Console (LAN) configured, you may be required to use another console type for your recovery. See **Connecting to iSeries --> What to connect with --> Operations Console** in the iSeries Information Center at <http://www.ibm.com/eserver/series/infocenter>.

Table 8. Recovery Checklist for Disk Failure—Checklist 1

Task	What To Do	Where To Read More About It
<i>Actions to Be Performed by the Service Representative</i>		
___ Task 1	Save the disk unit data.	
___ Task 2	Attach the new disk unit.	
___ Task 3	Install the Licensed Internal Code using option 4 (Install Licensed Internal Code and Restore Disk Unit Data).	“How to Prepare for Loading the Licensed Internal Code” on page 112 and “How to Load the Licensed Internal Code” on page 120.
___ Task 4	Restore the disk unit data.	
<i>Actions to Be Performed by the User</i>		
___ Task 5	<b>You must perform an IPL at this time.</b> Follow the procedure for starting the system after it ends abnormally.	Chapter 6, “Starting the System After It Ends Abnormally,” task 1 through task 4.

## Actions for load source disk unit failure—Checklist 2

This checklist should be used for the following problem situation:

**Failed Unit:**

Load source unit

**Data Loss:**

Some

**User ASP Configured:**

N/A

Most steps in the checklist include references to other topics in this book. Refer to these topics if you need more information about how to perform a particular step. You may not need to perform some steps, such as restoring changed objects, if they do not apply in your situation.

**Note:** When your load source unit is failed and you are recovering from distribution media with Operations Console (LAN) configured, you may be required to use another console type for your recovery. See **Connecting to iSeries --> What to connect with --> Operations Console** in the iSeries Information Center at <http://www.ibm.com/eserver/series/infocenter>.

Table 9. Recovery Checklist for Disk Failure—Checklist 2

Task	What To Do	Where To Read More About It
<i>Actions to Be Performed by the Service Representative</i>		
___ Task 1	Save the disk unit data.	
___ Task 2	Attach the new disk unit.	
___ Task 3	Install the Licensed Internal Code using option 4 (Install Licensed Internal Code and Restore Disk Unit Data).	“How to Prepare for Loading the Licensed Internal Code” on page 112 and “How to Load the Licensed Internal Code” on page 120
___ Task 4	Restore the disk unit data.	
<i>Actions to Be Performed by the User</i>		
___ Task 5	<b>You must perform an IPL at this time.</b> Follow the procedure for starting the system after it ends abnormally.	Chapter 6, “Starting the System After It Ends Abnormally,” task 1 through task 4.

Table 9. Recovery Checklist for Disk Failure—Checklist 2 (continued)

Task	What To Do	Where To Read More About It
___ Task 6	Restore the operating system. You are performing an <b>abbreviated install</b> operation. <b>Note:</b> You may have some objects that are damaged. You may be required to perform a complete restore of the operating system.	Chapter 5, “Restoring the Operating System,” task 1 through task 6.
___ Task 7	If you restored the operating system using distribution tapes, some system information, such as access path recovery times and the system reply list, <u>may</u> have been reset to default values. Verify these values and correct them if necessary.	“Recovering System Information” on page 201.
___ Task 8	Reclaim storage.	“Reclaim Storage” on page 35.
___ Task 9	Evaluate the extent of the damage. Determine whether you will attempt to recover damaged objects or restore the entire system. <b>Do not skip this step.</b>	“Task 4—Recovering from Damaged Objects and Unreadable Sectors” on page 162.
___ Task 10	If you have decided to do a complete restore operation, use Table 30 on page 96 to determine the correct procedure for restoring user information.	
___ Task 11	If you have decided to attempt to recover damaged objects, perform the tasks described in “Task 4—Recovering from Damaged Objects and Unreadable Sectors” on page 162.	

### Actions for load source disk unit failure—Checklist 3

This checklist should be used for the following problem situation:

**Failed Unit:**

Load source unit

**Data Loss:**

All

**User ASP Configured:**

No

**Before you begin your recovery**, make a copy of this checklist. Fill in the appropriate areas as you and the service representative perform the recovery steps. This checklist provides an important record of your recovery actions. It may help you to diagnose any problems that occur after the recovery. It may also be useful in evaluating your backup strategy.

Most steps in the checklist include references to other topics in this book. Refer to these topics if you need more information about how to perform a particular step. You may not need to perform some steps, such as restoring changed objects, if they do not apply in your situation.

**Note:** When your load source unit is failed and you are recovering from distribution media with Operations Console (LAN) configured, you may be required to use another console type for your recovery. See **Connecting to iSeries --> What to connect with --> Operations Console** in the iSeries Information Center at <http://www.ibm.com/eserver/series/infocenter>.

Task	What to Do	Where To Read More About It
Actions to Be Performed by the Service Representative		

Task	What to Do	Where To Read More About It
___ Task 1	Attach the new disk unit.	
___ Task 2	Prepare to load the Licensed Internal Code.	“How to Prepare for Loading the Licensed Internal Code” on page 112
___ Task 3	Install the Licensed Internal Code using option 3 (Install Licensed Internal Code and Recover Configuration).	“How to Load the Licensed Internal Code” on page 120
___ Task 4	Recover the disk configuration (assignment of disks to ASPs and protection).	“How to Recover Your Disk Configuration” on page 130
Actions to Be Performed by the User		
___ Task 5	Restore the operating system, beginning with “Task 1–Starting to Restore the Operating System” on page 138. You are performing a <b>complete restore</b> operation.	Chapter 16, “Restoring the Operating System”, task 1 through task 6.
___ Task 6	If you restored the operating system using distribution media, some system information, such as access path recovery times and the system reply list, was returned to default values. Set these values correctly.	“Recovering System Information” on page 201
___ Task 7	Use Table 30 on page 96 to determine the correct procedure for recovering user information. You will need to recover all user data.	

## Actions for load source disk unit failure–Checklist 4

This checklist should be used for the following problem situation:

**Failed Unit:**

Load source unit

**Data Loss:**

All

**User ASP Configured:**

Yes

**Basic User ASP Overflowed:**

No

**Attention!**

When you replace a disk unit in your system ASP, the system loses addressability to the objects in your basic user ASPs. Recovering object ownership for objects other than DLOs will require manually assigning ownership for every object in every basic user ASP. You may want to treat this situation as a total recovery and restore all your information from your save media if the following conditions are true:

1. You have a large number of objects in your basic user ASPs
2. You have thoroughly backed up your system

If you choose to do this, perform the steps that are described in “Recovering your entire system after a complete system loss–Checklist 20” on page 85 to recover your system.

**Before you begin your recovery**, make a copy of this checklist. Fill in the appropriate areas as you and the service representative perform the recovery steps. This checklist provides an important record of your recovery actions. It may help you to diagnose any problems that occur after the recovery. It may also be useful in evaluating your backup strategy.

Most steps in the checklist include references to other topics in this book. Refer to these topics if you need more information about how to perform a particular step. You may not need to perform some steps, such as restoring changed objects, if they do not apply in your situation.

**Note:** When your load source unit is failed and you are recovering from distribution media with Operations Console (LAN) configured, you may be required to use another console type for your recovery. See **Connecting to iSeries --> What to connect with --> Operations Console** in the iSeries Information Center at <http://www.ibm.com/eserver/series/infocenter>.

Table 10. Recovery Checklist for Disk Failure—Checklist 4

Task	What To Do	Where To Read More About It
<i>Actions to Be Performed by the Service Representative</i>		
___ <b>Task 1</b>	Attach the new disk unit.	
___ <b>Task 2</b>	Prepare to load the Licensed Internal Code.	“How to Prepare for Loading the Licensed Internal Code” on page 112.
___ <b>Task 3</b>	Install the Licensed Internal Code using option 3 (Install Licensed Internal Code and Recover Configuration).	“How to Load the Licensed Internal Code” on page 120.
___ <b>Task 4</b>	Recover the disk configuration (assignment of disks to ASPs and protection).	“How to Recover Your Disk Configuration” on page 130.
<i>Actions to Be Performed by the User</i>		
___ <b>Task 5</b>	Restore the operating system, beginning with “Task 1—Starting to Restore the Operating System” on page 138. You are performing a <b>complete restore</b> operation.	Chapter 5, “Restoring the Operating System,” on page 135, task 1 through task 6.
___ <b>Task 6</b>	If you restored the operating system using distribution media, some system information, such as access path recovery times and the system reply list, was returned to default values. Set these values correctly.	“Recovering System Information” on page 201.
___ <b>Task 7</b>	If necessary, change the QALWBJRST system value by using the WRKSYSVAL command. Write the old value here: _____	“Controlling Restoration of Security-Sensitive Objects” on page 40.
___ <b>Task 8</b>	If necessary, change the QVFOBJRST system value by using the WRKSYSVAL command. Write the old value here: _____	“Controlling Restoration of Security-Sensitive Objects” on page 40.
___ <b>Task 9</b>	If necessary, change the system value that controls whether the job log wraps when it is full. Use the Work with System Values command: WRKSYSVAL QJOBMSGQFL. Write down the current value here: _____. Then change the value to *PRTWRAP.	The System Values subtopic of the System Management topic in the iSeries Information Center.

Table 10. Recovery Checklist for Disk Failure—Checklist 4 (continued)

Task	What To Do	Where To Read More About It
___ Task 10	After changing the system values, sign off by using the command SIGNOFF *LIST. Then, using a newly created password, sign back on as QSECOFR for the new values to take effect.	“Describing the Contents of Your User Auxiliary Storage Pools” on page 169.
___ Task 11	Describe or diagram, as much as possible, the contents of your user ASPs before the failure.	“Describing the Contents of Your User Auxiliary Storage Pools” on page 169.
___ Task 12	Recover user profiles, configuration, libraries in the system ASP, and the contents of your basic user ASPs. If you choose not to restore all of your libraries at this time, ensure that you restore the QGPL and QUSRSYS libraries along with the libraries that you are restoring.	“How to Recover a Basic User ASP After Recovering the System ASP” on page 170, task 1 through task 11.
___ Task 13	Restore document library objects.	“Restoring Documents and Folders” on page 244.
___ Task 14	Restore your last complete save of directories. <sup>1</sup>	“Restoring Objects in Directories” on page 248.
___ Task 15	If you have User-Defined File Systems in User ASPs that do not restore correctly, you may need to perform additional recovery steps.	“Task 7—Restoring User-Defined File Systems to the User Auxiliary Storage Pool” on page 175.
___ Task 16	Restore changed objects and apply journaled changes.	Chapter 10, “How to Restore Changed Objects and Apply Journaled Changes,” task 1 through task 7.
___ Task 17	Update Program Temporary Fix information for all PTF save files in library QGPL by typing: UPDPTFINF.	Chapter 10, “How to Restore Changed Objects and Apply Journaled Changes.”
___ Task 18	If the Save System Information (SAVSYSINF) has been used, the run the Restore System Information (RSTSYSINF) command. The Restore System Information (RSTSYSINF) command restores a subset of the system data and objects saved by the Save System Information (SAVSYSINF) command.	“Restore system information” on page 260
___ Task 19	Restore authority. Type: RSTAUT	“Restoring Object Authorities” on page 206.
___ Task 20	Reapply any PTFs that were applied since your last SAVSYS operation.	“How to Restore Program Temporary Fixes” on page 259.
___ Task 21	If you use Windows server on iSeries and saved with the Integrated xSeries Server (NWSD) varied off, complete recovery for the Windows server on iSeries.	“Completing Recovery for the IBM iSeries Integration for Windows Server Product” on page 250.
___ Task 22	If you run Linux and saved Linux by varying off the network server description (NWSD) for Linux, complete the recovery for Linux.	“Recovering Linux or AIX in a Partition” on page 251
___ Task 23	If necessary, change the QALWOBJRST system value back to its original value by using the WRKSYSVAL command.	“Controlling Restoration of Security-Sensitive Objects” on page 40.

Table 10. Recovery Checklist for Disk Failure—Checklist 4 (continued)

Task	What To Do	Where To Read More About It
___ Task 24	If necessary, change the QVfyOjRST system value back to its original value by using the WRKSYSVAL command.	“Controlling Restoration of Security-Sensitive Objects” on page 40.
___ Task 25	If necessary, change the QJOBMSGQFL system value back to its original value by using the WRKSYSVAL command.	The System Values subtopic of the System Management topic in the iSeries Information Center.
___ Task 26	<p>Perform either a:</p> <p>SIGNOFF *LIST</p> <p>or a</p> <p>DSPJOBLOG * *PRINT</p> <p>Check the job log to ensure all objects were restored. The job log contains information about the restore operation. To verify that all objects were restored, spool the job log for printing along with the job’s remaining spooled output, if any.</p> <p>Message CPC3703 is sent to the job log for each library that was successfully restored. Message CPF3773 is sent to tell you how many objects were restored. Objects are not restored for various reasons. Check for any error messages, correct the errors, and then restore those objects from the media.</p>	
___ Task 27	<b>You must perform an IPL at this time.</b>	“How to Perform a Normal IPL” on page 49.
___ Task 28	If you use Windows server on iSeries and saved with the Integrated xSeries Server (NWSD) varied on, complete recovery for the Windows server on iSeries product.	“Completing Recovery for the IBM iSeries Integration for Windows Server Product” on page 250.
___ Task 29	<p>If IBM Content Manager OnDemand for iSeries is installed, complete journaling for IBM Content Manager OnDemand for iSeries by typing the following commands:</p> <p>CALL QRDARS/QRLCSTRJ PARM('RLC')</p> <p>CALL QRDARS/QRLCSTRJ PARM('RLR')</p> <p>CALL QRDARS/QRLCSTRJ PARM('RLO')</p>	
___ Task 30	If you have 4764 Cryptographic Coprocessor Hardware recover 5733-CY1 CCA Device Manager by typing: CALL QCCAEV/QCCAELOAD.	<p>Refer to the eServer Hardware Information Center, IBM Cryptographic Coprocessor Card Return Program, at</p> <p><a href="http://publib.boulder.ibm.com/infocenter/eserver/v1r2s/en_US/info/icmain.htm">http://publib.boulder.ibm.com/infocenter/eserver/v1r2s/en_US/info/icmain.htm</a></p>
___ Task 31	Review job logs or output from your restore operations to ensure that all objects were restored successfully.	“How to verify that objects are restored successfully” on page 45.

Table 10. Recovery Checklist for Disk Failure—Checklist 4 (continued)

Task	What To Do	Where To Read More About It
1	<p>You may receive one of the following messages:</p> <p>CPD377A: Object not restored, /QNTC.            CPD377A: Object not restored, /QNetWare.</p> <p>These objects cannot be restored until their file systems have been mounted during the IPL. You may ignore these messages. The additional recovery tasks will guide you through the steps to restore these objects.</p> <p><b>Note:</b> Since the i5/OS Enhanced Integration for Novell NetWare software resides on a remote server, you do not have to restore your Netware data when you restore your server. Previously, the i5/OS Integration for Novell NetWare product ran on a Integrated xSeries® Server and you had to restore the Novell product if you completely restored your server.</p>	

## Actions for load source disk unit failure—Checklist 5

This checklist should be used for the following problem situation:

**Failed Unit:**

Load source unit

**Data Loss:**

All

**User ASP Configured:**

Yes

**Basic User ASP Overflowed:**

Yes

**Attention!**

When you replace a disk unit in your system ASP, the system loses addressability to the objects in your basic user ASPs. Recovering object ownership for objects other than DLOs will require manually assigning ownership for every object in every basic user ASP. You may want to treat this situation as a total recovery and restore all your information from your save media if the following conditions are true:

1. You have a large number of objects in your user ASPs
2. You have thoroughly backed up your system

If you choose to do this, perform the steps that are described in “Recovering your entire system after a complete system loss—Checklist 20” on page 85 to recover your system.

**Note:** When your load source unit is failed and you are recovering from distribution media with Operations Console (LAN) configured, you may be required to use another console type for your recovery. See **Connecting to iSeries --> Operations Console** in the iSeries Information Center at <http://www.ibm.com/eserver/iserics/infocenter>.

Table 11. Recovery Checklist for Disk Failure—Checklist 5

Task	What To Do	Where To Read More About It
<i>Actions to Be Performed by the Service Representative</i>		
___ Task 1	Attach the new disk unit.	
___ Task 2	Prepare to load the Licensed Internal Code.	“How to Prepare for Loading the Licensed Internal Code” on page 112



Table 11. Recovery Checklist for Disk Failure—Checklist 5 (continued)

Task	What To Do	Where To Read More About It
___ Task 3	Install the Licensed Internal Code using option 3 (Install Licensed Internal Code and Recover Configuration).	“How to Load the Licensed Internal Code” on page 120
___ Task 4	Recover the disk configuration (assignment of disk to ASPs and protection).	“How to Recover Your Disk Configuration” on page 130.
<i>Actions to Be Performed by the User</i>		
___ Task 5	Restore the operating system, beginning with “Task 1—Starting to Restore the Operating System” on page 138. You are performing a <b>complete restore</b> operation.	Chapter 5, “Restoring the Operating System,” on page 135, task 1 through task 6.
___ Task 6	If you restored the operating system using distribution media, some system information, such as access path recovery times and the system reply list, <u>may</u> have been reset to default values. Verify these values and correct them if necessary.	“Recovering System Information” on page 201.
___ Task 7	If necessary, change the QALWOBJRST system value. Write the old value here: _____	“Controlling Restoration of Security-Sensitive Objects” on page 40.
___ Task 8	If necessary, change the QVFYOBJRST system value. Write the old value here: _____	“Controlling Restoration of Security-Sensitive Objects” on page 40.
___ Task 9	If necessary, change the system value that controls whether the job log wraps when it is full. Use the Work with System Values command: WRKSYSVAL QJOBMSGQFL. Write down the current value here: _____. Then change the value to *PRTWRAP.	The System Values subtopic of the System Management topic in the iSeries Information Center.
___ Task 10	After changing the system values, sign off by using the command SIGNOFF *LIST. Then, using a newly created password, sign back on as QSECOFR for the new values to take effect.	“Describing the Contents of Your User Auxiliary Storage Pools” on page 169.
___ Task 11	Describe or diagram, as much as possible, the contents of your user ASPs before the failure.	“Describing the Contents of Your User Auxiliary Storage Pools” on page 169.
___ Task 12	Recover user profiles, configuration, libraries in the system ASP, and the contents of the user ASPs that were not in overflowed status. If you choose not to restore all of your libraries at this time, ensure that you restore the QGPL and QUSRSYS libraries along with the libraries that you are restoring.	“How to Recover a Basic User ASP After Recovering the System ASP” on page 170, task 1 through task 11.
___ Task 13	Recover the objects in the user ASPs that were overflowed.	“How to Recover a Damaged Basic Auxiliary Storage Pool” on page 183, task 1 through task 9.
___ Task 14	Restore document library objects to the system ASP and to any overflowed user ASPs that had DLOs.	“Restoring Documents and Folders” on page 244.
___ Task 15	Restore your last complete save of directories. <sup>1</sup>	“Restoring Objects in Directories” on page 248.

Table 11. Recovery Checklist for Disk Failure—Checklist 5 (continued)

Task	What To Do	Where To Read More About It
___ Task 16	If you have User-Defined File Systems in User ASPs that do not restore correctly, you may need to perform additional recovery steps.	“Task 7—Restoring User-Defined File Systems to the User Auxiliary Storage Pool” on page 175.
___ Task 17	Restore changed objects and apply journaled changes.	Chapter 10, “How to Restore Changed Objects and Apply Journaled Changes,” on page 261.
___ Task 18	Update Program Temporary Fix information for all PTF save files in library QGPL by typing: UPDPTFINE.	Chapter 10, “How to Restore Changed Objects and Apply Journaled Changes.”
___ Task 19	If the Save System Information (SAVSYSINF) has been used, the run the Restore System Information (RSTSYSINF) command. The Restore System Information (RSTSYSINF) command restores a subset of the system data and objects saved by the Save System Information (SAVSYSINF) command.	“Restore system information” on page 260
___ Task 20	Restore authority. Type: RSTAUT	“Restoring Object Authorities” on page 206.
___ Task 21	Reapply any PTFs that were applied since your last SAVSYS operation.	“How to Restore Program Temporary Fixes” on page 259.
___ Task 22	If you use Windows server on iSeries and saved with the Integrated xSeries Server (NWSA) varied off, complete recovery for the Windows server on iSeries.	“Completing Recovery for the IBM iSeries Integration for Windows Server Product” on page 250.
___ Task 23	If you run Linux and saved Linux by varying off the network server description (NWSA) for Linux, complete the recovery for Linux.	“Recovering Linux or AIX in a Partition” on page 251
___ Task 24	If necessary, use the WRKSYSVAL command to change the QALWBJRST system value back to its original value.	“Controlling Restoration of Security-Sensitive Objects” on page 40.
___ Task 25	If necessary, use the WRKSYSVAL command to change the QVYOBJRST system value back to its original value.	“Controlling Restoration of Security-Sensitive Objects” on page 40.
___ Task 26	If necessary, change the QJOBMSGQFL system value back to its original value by using the WRKSYSVAL command.	The System Values subtopic of the System Management topic in the iSeries Information Center.

Table 11. Recovery Checklist for Disk Failure—Checklist 5 (continued)

Task	What To Do	Where To Read More About It
<p>___ <b>Task 27</b></p>	<p>Perform either a:</p> <p>SIGNOFF *LIST</p> <p>or a</p> <p>DSPJOBLOG * *PRINT</p> <p>Check the job log to ensure all objects were restored. The job log contains information about the restore operation. To verify that all objects were restored, spool the job log for printing along with the job's remaining spooled output, if any.</p> <p>Message CPC3703 is sent to the job log for each library that was successfully restored. Message CPF3773 is sent to tell you how many objects were restored. Objects are not restored for various reasons. Check for any error messages, correct the errors, and then restore those objects from the media.</p>	
<p>___ <b>Task 28</b></p>	<p><b>You must perform a normal IPL at this time.</b></p>	<p>"How to Perform a Normal IPL" on page 49.</p>
<p>___ <b>Task 29</b></p>	<p>If you use Windows server on iSeries and saved with the Integrated xSeries Server (NWS) varied on, complete recovery for the Windows server on iSeries product.</p>	<p>"Completing Recovery for the IBM iSeries Integration for Windows Server Product" on page 250.</p>
<p>___ <b>Task 30</b></p>	<p>If IBM Content Manager OnDemand for iSeries is installed, complete journaling for IBM Content Manager OnDemand for iSeries by typing the following commands:</p> <pre>CALL QRDARS/QRLCSTRJ PARM('RLC')</pre> <pre>CALL QRDARS/QRLCSTRJ PARM('RLR')</pre> <pre>CALL QRDARS/QRLCSTRJ PARM('RLO')</pre>	
<p>___ <b>Task 31</b></p>	<p>If you have 4764 Cryptographic Coprocessor Hardware recover 5733-CY1 CCA Device Manager by typing: CALL QCCAEDEV/QCCAELOAD.</p>	<p>Refer to the eServer Hardware Information Center, IBM Cryptographic Coprocessor Card Return Program, at</p> <p><a href="http://publib.boulder.ibm.com/infocenter/eserver/v1r2s/en_US/info/icmain.htm">http://publib.boulder.ibm.com/infocenter/eserver/v1r2s/en_US/info/icmain.htm</a></p>
<p>___ <b>Task 32</b></p>	<p>Review job logs or output from your restore operations to ensure that all objects were restored successfully.</p>	<p>"How to verify that objects are restored successfully" on page 45.</p>
<p><sup>1</sup></p>	<p>You may receive one of the following messages:</p> <p>CPD377A: Object not restored, /QNTC.</p> <p>CPD377A: Object not restored, /QNetWare.</p> <p>These objects cannot be restored until their file systems have been mounted during the IPL. The additional recovery tasks will guide you through the steps to restore these objects.</p> <p><b>Note:</b> Note: Since the i5/OS Enhanced Integration for Novell NetWare software resides on a remote server, you do not have to restore your Netware data when you restore your server. Previously, the i5/OS Integration for Novell NetWare product ran on a Integrated xSeries Server and you had to restore the Novell product if you completely restored your server.</p>	

## Actions for non-load source disk unit failure or disk units in basic user ASP disk failure—Checklist 6

This checklist should be used for the following problem situation:

**Failed Unit:**

Non-load source unit in system ASP or Disk unit in basic user ASP

**Data Loss:**

None

**User ASP Configured:**

N/A

**Before you begin your recovery**, make a copy of this checklist. Fill in the appropriate areas as you and the service representative perform the recovery steps. This checklist provides an important record of your recovery actions. It may help you to diagnose any problems that occur after the recovery. It may also be useful in evaluating your backup strategy.

Most steps in the checklist include references to other topics in this book. Refer to these topics if you need more information about how to perform a particular step. You may not need to perform some steps, such as restoring changed objects, if they do not apply in your situation.

Table 12. Recovery Checklist for Disk Failure—Checklist 6

Task	What To Do	Where To Read More About It
<i>Actions to Be Performed by the Service Representative</i>		
___ Task 1	Save the disk unit data.	
___ Task 2	Attach a new disk unit.	
___ Task 3	Restore data to the new disk unit.	
<i>Actions to Be Performed by the User</i>		
___ Task 4	Perform an IPL. Follow the procedure for starting the system after it ends abnormally.	Chapter 6, "Starting the System After It Ends Abnormally," task 1 through task 4.

## Actions for non-load source disk unit failure—Checklist 7

This checklist should be used for the following problem situation:

**Failed Unit:**

Non-load source unit in system ASP

**Data Loss:**

Some

**User ASP Configured:**

N/A

**Before you begin your recovery**, make a copy of this checklist. Fill in the appropriate areas as you and the service representative perform the recovery steps. This checklist provides an important record of your recovery actions. It may help you to diagnose any problems that occur after the recovery. It may also be useful in evaluating your backup strategy.

Most steps in the checklist include references to other topics in this book. Refer to these topics if you need more information about how to perform a particular step. You may not need to perform some steps, such as restoring changed objects, if they do not apply in your situation.

Table 13. Recovery Checklist for Disk Failure—Checklist 7

Task	What To Do	Where To Read More About It
<i>Actions to Be Performed by the Service Representative</i>		
___ Task 1	Save the disk unit data.	
___ Task 2	Attach the new disk unit.	
___ Task 3	Restore the disk unit data.	
<i>Actions to Be Performed by the User</i>		
___ Task 4	Restore the operating system, beginning with “Task 1—Starting to Restore the Operating System” on page 138. You are performing a complete restore operation.	Chapter 5, “Restoring the Operating System,” task 1 through task 6.
___ Task 5	If you restored the operating system using distribution media, some system information, such as access path recovery times and the system reply list, <u>may</u> have been reset to default values. Verify these values and correct them if necessary.	“Recovering System Information” on page 201.
___ Task 6	Reclaim storage.	“Reclaim Storage” on page 35.
___ Task 7	Evaluate the extent of the damage. Determine whether you will attempt to recover damaged objects or restore the entire system. <b>Do not skip this step.</b>	“Task 4—Recovering from Damaged Objects and Unreadable Sectors” on page 162.
___ Task 8	If you have decided to do a complete restore operation, use Table 30 on page 96 to determine the correct procedure for recovering user information.	
___ Task 9	If you have decided to attempt to recover damaged objects, perform the tasks in “Task 4—Recovering from Damaged Objects and Unreadable Sectors” on page 162.	

## Actions for non-load source disk unit failure—Checklist 8

This checklist should be used for the following problem situation:

**Failed Unit:**

Non-load source unit in system ASP

**Data Loss:**

All

**User ASP Configured:**

No

Most steps in the checklist include references to other topics in this book. Refer to these topics if you need more information about how to perform a particular step. You may not need to perform some steps, such as restoring changed objects, if they do not apply in your situation.

Table 14. Recovery Checklist for Disk Failure—Checklist 8

Task	What To Do	Where To Read More About It
<i>Actions to Be Performed by the Service Representative</i>		
___ Task 1	Attach the new disk unit.	
___ Task 2	Delete the ASP data.	

Table 14. Recovery Checklist for Disk Failure—Checklist 8 (continued)

Task	What To Do	Where To Read More About It
___ Task 3	Restore the Licensed Internal Code using option 1 (Restore Licensed Internal Code). If user ASPs are configured, they remain intact.	“How to Prepare for Loading the Licensed Internal Code” on page 112 and “How to Load the Licensed Internal Code” on page 120.
<i>Actions to Be Performed by the User</i>		
___ Task 4	Restore the operating system, beginning with “Task 1—Starting to Restore the Operating System” on page 138. You are performing a <b>complete restore</b> operation.	Chapter 5, “Restoring the Operating System,” task 1 through task 6.
___ Task 5	If you restored the operating system using distribution media, some system information, such as access path recovery times and the system reply list, <u>may</u> have been reset to default values. Verify these values and correct them if necessary.	“Recovering System Information” on page 201.
___ Task 6	Reclaim storage.	“Reclaim Storage” on page 35.
___ Task 7	Use Table 30 on page 96 to determine the correct procedure for recovering user information.	

## Actions for non-load source disk unit failure—Checklist 9

This checklist should be used for the following problem situation:

**Failed Unit:**

Non-load source unit in system ASP

**Data Loss:**

All

**User ASP Configured:**

Yes

**User ASP Overflowed:**

No

**Attention!**

When you replace a disk unit in your system ASP, the system loses addressability to the objects in your user ASPs. Recovering object ownership for objects other than DLOs will require manually assigning ownership for every object in every user ASP. You may want to treat this situation as a total recovery and restore all your information from your save media if the following conditions are true:

1. You have a large number of objects in your user ASPs
2. You have thoroughly backed up your system

If you choose to do this, perform the steps that are described in “Recovering your entire system after a complete system loss—Checklist 20” on page 85 to recover your system.

Table 15. Recovery Checklist for Disk Failure—Checklist 9

Task	What To Do	Where To Read More About It
<i>Actions to Be Performed by the Service Representative</i>		

Table 15. Recovery Checklist for Disk Failure—Checklist 9 (continued)

Task	What To Do	Where To Read More About It
___ Task 1	Delete the data in the ASP that contains the failed unit.	
___ Task 2	Replace the failed disk unit.	
___ Task 3	Configure the replacement disk unit by adding it to the correct ASP.	
___ Task 4	Restore the Licensed Internal Code using option 1 (Restore Licensed Internal Code). If user ASPs are configured, they remain intact.	“How to Prepare for Loading the Licensed Internal Code” on page 112 and “How to Load the Licensed Internal Code” on page 120.
<i>Actions to Be Performed by the User</i>		
___ Task 5	Restore the operating system, beginning with “Task 1—Starting to Restore the Operating System” on page 138. You are performing a complete restore operation.	Chapter 5, “Restoring the Operating System,” task 1 through task 6.
___ Task 6	If you restored the operating system using distribution media, some system information, such as access path recovery times and the system reply list, may have been reset to default values. Verify these values and correct them if necessary.	“Recovering System Information” on page 201.
___ Task 7	If necessary, change the QALWOBJRST system value. Write the old value here: _____	“Controlling Restoration of Security-Sensitive Objects” on page 40.
___ Task 8	If necessary, change the QVIFYOJRST system value. Write the old value here: _____	“Controlling Restoration of Security-Sensitive Objects” on page 40.
___ Task 9	If necessary, change the system value that controls whether the job log wraps when it is full. Use the Work with System Values command: WRKSYSVAL QJOBMSGQFL. Write down the current value here: _____. Then change the value to *PRTWRAP.	The System Values subtopic of the System Management topic in the iSeries Information Center.
___ Task 10	After changing the system values, sign off by using the command SIGNOFF *LIST. Then, using a newly created password, sign back on as QSECOFR for the new values to take effect.	“Describing the Contents of Your User Auxiliary Storage Pools” on page 169.
___ Task 11	Describe or diagram, as much as possible, the contents of your user ASPs before the failure.	“Describing the Contents of Your User Auxiliary Storage Pools” on page 169.
___ Task 12	Recover user profiles, configuration, libraries in the system ASP, and the contents of your basic user ASPs. If you choose not to restore all of your libraries at this time, ensure that you restore the QGPL and QUSRSYS libraries along with the libraries that you are restoring.	“How to Recover a Basic User ASP After Recovering the System ASP” on page 170, task 1 through task 11.
___ Task 13	Restore document library objects to the system ASP.	“Restoring Documents and Folders” on page 244.
___ Task 14	Restore your last complete save of directories. <sup>1</sup>	“Restoring Objects in Directories” on page 248.

Table 15. Recovery Checklist for Disk Failure—Checklist 9 (continued)

Task	What To Do	Where To Read More About It
___ Task 15	If you have User-Defined File Systems in User ASPs that do not restore correctly, you may need to perform additional recovery steps.	"Task 7—Restoring User-Defined File Systems to the User Auxiliary Storage Pool" on page 175.
___ Task 16	Restore changed objects and apply journaled changes.	Chapter 10, "How to Restore Changed Objects and Apply Journaled Changes," task 1 through task 7.
___ Task 17	Update Program Temporary Fix information for all PTF save files in library QGPL by typing: UPDPTFINF.	Chapter 10, "How to Restore Changed Objects and Apply Journaled Changes."
___ Task 18	If the Save System Information (SAVSYSINF) has been used, the run the Restore System Information (RSTSYSINF) command. The Restore System Information (RSTSYSINF) command restores a subset of the system data and objects saved by the Save System Information (SAVSYSINF) command.	"Restore system information" on page 260
___ Task 19	Restore authority. Type: RSTAUT	"Restoring Object Authorities" on page 206.
___ Task 20	Reapply any PTFs that were applied since your last SAVSYS operation.	"How to Restore Program Temporary Fixes" on page 259.
___ Task 21	If you use Windows server on iSeries and saved with the Integrated xSeries Server (NWS) varied off, complete recovery for the Windows server on iSeries product.	"Completing Recovery for the IBM iSeries Integration for Windows Server Product" on page 250.
___ Task 22	If you run Linux and saved Linux by varying off the network server description (NWS) for Linux, complete the recovery for Linux.	"Recovering Linux or AIX in a Partition" on page 251
___ Task 23	If necessary, change the QALWBJRST system value back to its original value by using the WRKSYSVAL command.	"Controlling Restoration of Security-Sensitive Objects" on page 40.
___ Task 24	If necessary, change the QVYOBJRST system value back to its original value by using the WRKSYSVAL command.	"Controlling Restoration of Security-Sensitive Objects" on page 40.
___ Task 25	If necessary, change the QJOBMSGQFL system value back to its original value by using the WRKSYSVAL command.	The System Values subtopic of the System Management topic in the iSeries Information Center.



Table 15. Recovery Checklist for Disk Failure—Checklist 9 (continued)

Task	What To Do	Where To Read More About It
___ Task 26	<p>Perform either a:</p> <p>SIGNOFF *LIST</p> <p>or a</p> <p>DSPJOBLOG * *PRINT</p> <p>Check the job log to ensure all objects were restored. The job log contains information about the restore operation. To verify that all objects were restored, spool the job log for printing along with the job's remaining spooled output, if any.</p> <p>Message CPC3703 is sent to the job log for each library that was successfully restored. Message CPF3773 is sent to tell you how many objects were restored. Objects are not restored for various reasons. Check for any error messages, correct the errors, and then restore those objects from the media.</p>	
___ Task 27	<b>You must perform a normal IPL at this time.</b>	"How to Perform a Normal IPL" on page 49.
___ Task 28	If you use Windows server on iSeries and saved with the Integrated xSeries Server (NWS) varied on, complete recovery for the Windows server on iSeries product.	"Completing Recovery for the IBM iSeries Integration for Windows Server Product" on page 250.
___ Task 29	<p>If IBM Content Manager OnDemand for iSeries is installed, complete journaling for IBM Content Manager OnDemand for iSeries by typing the following commands:</p> <p>CALL QRDARS/QLCSTRJ PARM('RLC')</p> <p>CALL QRDARS/QLCSTRJ PARM('RLR')</p> <p>CALL QRDARS/QLCSTRJ PARM('RLO')</p>	
___ Task 30	If you have 4764 Cryptographic Coprocessor Hardware recover 5733-CY1 CCA Device Manager by typing: CALL QCCAEV/QCCAELOAD.	<p>Refer to the eServer Hardware Information Center, IBM Cryptographic Coprocessor Card Return Program, at</p> <p><a href="http://publib.boulder.ibm.com/infocenter/eserver/v1r2s/en_US/info/icmain.htm">http://publib.boulder.ibm.com/infocenter/eserver/v1r2s/en_US/info/icmain.htm</a></p>
___ Task 31	Review job logs or output from your restore operations to ensure that all objects were restored successfully.	"How to verify that objects are restored successfully" on page 45.

Table 15. Recovery Checklist for Disk Failure—Checklist 9 (continued)

Task	What To Do	Where To Read More About It
1	<p>You may receive one of the following messages:            CPD377A: Object not restored, /QNTC.            CPD377A: Object not restored, /QNetWare.</p> <p>These objects cannot be restored until their file systems have been mounted during the IPL. You may ignore these messages. The additional recovery tasks will guide you through the steps to restore these objects.</p> <p><b>Note:</b> Since the i5/OS Enhanced Integration for Novell NetWare software resides on a remote server, you do not have to restore your Netware data when you restore your server. Previously, the i5/OS Enhanced Integration for Novell NetWare product ran on an Integrated xSeries Server and you had to restore the Novell product if you completely restored your server.</p>	

## Actions for non-load source disk unit failure—Checklist 10

This checklist should be used for the following problem situation:

**Failed Unit:**

Non-load source unit in system ASP

**Data Loss:**

All

**User ASP Configured:**

Yes

**Basic User ASP Overflowed:**

Yes

**Attention!**

When you replace a disk unit in your system ASP, the system loses addressability to the objects in your user ASPs. Recovering object ownership for objects other than DLOs will require manually assigning ownership for every object in every user ASP. You may want to treat this situation as a total recovery and restore all your information from your save media if the following conditions are true:

1. You have a large number of objects in your user ASPs
2. You have thoroughly backed up your system

If you choose to do this, perform the steps that are described in “Recovering your entire system after a complete system loss—Checklist 20” on page 85 to recover your system.

Table 16. Recovery Checklist for Disk Failure—Checklist 10

Task	What To Do	Where To Read More About It
<i>Actions to Be Performed by the Service Representative</i>		
___ <b>Task 1</b>	Physically remove the failed disk unit from the system.	
___ <b>Task 2</b>	Delete the data in the ASP that contains the failed unit. When you delete the data in the system ASP, the system also deletes data in any basic user ASPs that have a status of overflowed.	
___ <b>Task 3</b>	Install the replacement disk unit.	

Table 16. Recovery Checklist for Disk Failure—Checklist 10 (continued)

Task	What To Do	Where To Read More About It
___ Task 4	Configure the replacement disk unit by selecting the 'Replace configured unit' function on the Work with Disk Units display.	
___ Task 5	Restore the Licensed Internal Code using option 1 (Restore Licensed Internal Code). If user ASPs are configured and are not overflowed, they remain intact.	"How to Prepare for Loading the Licensed Internal Code" on page 112 and "How to Load the Licensed Internal Code" on page 120.
<i>Actions to Be Performed by the User</i>		
___ Task 6	Restore the operating system, beginning with "Task 1—Starting to Restore the Operating System" on page 138. You are performing a complete restore operation.	Chapter 5, "Restoring the Operating System," task 1 through task 6.
___ Task 7	If you restored the operating system using distribution media, some system information such as access path recovery times and the system reply list may have been reset to default values. Verify these values and correct them if necessary.	"Recovering System Information" on page 201.
___ Task 8	If necessary, change the QALWBJRST system value. Write the old value here: _____	"Controlling Restoration of Security-Sensitive Objects" on page 40.
___ Task 9	If necessary, change the QVFYOBJRST system value. Write the old value here: _____	"Controlling Restoration of Security-Sensitive Objects" on page 40.
___ Task 10	If necessary, change the system value that controls whether the job log wraps when it is full. Use the Work with System Values command: WRKSYSVAL QJOBMSGQFL. Write down the current value here: _____. Then change the value to *PRTWRAP.	The System Values subtopic of the System Management topic in the iSeries Information Center.
<u>Task 11</u>	After changing the system values, sign off by using the command SIGNOFF *LIST. Then, using a newly created password, sign back on as QSECOFR for the new values to take effect.	
___ Task 12	Describe or diagram, as much as possible, the contents of your user ASPs before the failure.	"Describing the Contents of Your User Auxiliary Storage Pools" on page 169.
___ Task 13	Recover user profiles, configuration, libraries in the system ASP, and the contents of any basic user ASPs that were <u>not</u> in overflowed status. If you choose not to restore all of your libraries at this time, ensure that you restore the QGPL and QUSRSYS libraries along with the libraries that you are restoring.	"How to Recover a Basic User ASP After Recovering the System ASP" on page 170, task 1 through task 11.
___ Task 14	Recover the objects in the basic user ASPs that were overflowed.	"How to Recover a Damaged Basic Auxiliary Storage Pool" on page 183, task 1 through task 9.

Table 16. Recovery Checklist for Disk Failure—Checklist 10 (continued)

Task	What To Do	Where To Read More About It
___ Task 15	Restore document library objects to the system ASP and to any overflowed basic user ASPs that had DLOs.	“Restoring Documents and Folders” on page 244.
___ Task 16	Restore your last complete save of directories. <sup>1</sup>	“Restoring Objects in Directories” on page 248.
___ Task 17	If you have User-Defined File Systems in User ASPs that do not restore correctly, you may need to perform additional recovery steps.	“Task 7—Restoring User-Defined File Systems to the User Auxiliary Storage Pool” on page 175.
___ Task 18	Restore changed objects and apply journaled changes.	Chapter 10, “How to Restore Changed Objects and Apply Journaled Changes,” task 1 through task 7.
___ Task 19	Update Program Temporary Fix information for all PTF save files in library QGPL by typing: UPDPTFINE.	
___ Task 20	If the Save System Information (SAVSYSINF) has been used, the run the Restore System Information (RSTSYSINF) command. The Restore System Information (RSTSYSINF) command restores a subset of the system data and objects saved by the Save System Information (SAVSYSINF) command. <b>Note:</b> If you have independent ASPs do not perform this step at this time.	“Restore system information” on page 260
___ Task 21	Restore authority. Type: RSTAUT	“Restoring Object Authorities” on page 206.
___ Task 22	Reapply any PTFs that were applied since your last SAVSYS operation.	“How to Restore Program Temporary Fixes” on page 259.
___ Task 23	If you use Windows server on iSeries and saved with the Integrated xSeries Server (NWSD) varied off, complete recovery for the Windows server on iSeries product.	“Completing Recovery for the IBM iSeries Integration for Windows Server Product” on page 250.
___ Task 24	If you run Linux and saved Linux by varying off the network server description (NWSD) for Linux, complete the recovery for Linux.	“Recovering Linux or AIX in a Partition” on page 251.
___ Task 25	If necessary, change the QALWOBJRST system value back to its original value by using the WRKSYSVAL command.	“Controlling Restoration of Security-Sensitive Objects” on page 40.
___ Task 26	If necessary, change the QVfyOBRST system value back to its original value by using the WRKSYSVAL command.	“Controlling Restoration of Security-Sensitive Objects” on page 40.
___ Task 27	If necessary, change the QJOBMSGQFL system value back to its original value by using the WRKSYSVAL command.	The System Values subtopic of the System Management topic in the iSeries Information Center.

Table 16. Recovery Checklist for Disk Failure—Checklist 10 (continued)

Task	What To Do	Where To Read More About It
<p>___ <b>Task 28</b></p>	<p>Perform either a: SIGNOFF *LIST</p> <p>or a DSPJOBLOG * *PRINT</p> <p>Check the job log to ensure all objects were restored. The job log contains information about the restore operation. To verify that all objects were restored, spool the job log for printing along with the job's remaining spooled output, if any.</p> <p>Message CPC3703 is sent to the job log for each library that was successfully restored. Message CPF3773 is sent to tell you how many objects were restored. Objects are not restored for various reasons. Check for any error messages, correct the errors, and then restore those objects from the media.</p>	
<p>___ <b>Task 29</b></p>	<p><b>You must perform a normal IPL at this time.</b></p>	<p>“How to Perform a Normal IPL” on page 49.</p>
<p>___ <b>Task 30</b></p>	<p>If you use Windows server on iSeries and saved with the Integrated xSeries Server (NWSD) varied on, complete recovery for the Windows server on iSeries product.</p>	<p>“Completing Recovery for the IBM iSeries Integration for Windows Server Product” on page 250.</p>
<p>___ <b>Task 31</b></p>	<p>If IBM Content Manager OnDemand for iSeries is installed, complete journaling for IBM Content Manager OnDemand for iSeries by typing the following commands:</p> <pre>CALL QRDARS/QRLCSTRJ PARM('RLC')</pre> <pre>CALL QRDARS/QRLCSTRJ PARM('RLR')</pre> <pre>CALL QRDARS/QRLCSTRJ PARM('RLO')</pre>	
<p>___ <b>Task 32</b></p>	<p>If you have 4764 Cryptographic Coprocessor Hardware recover 5733-CY1 CCA Device Manager by typing: CALL QCCAEDEV/QCCAELOAD.</p>	<p>Refer to the eServer Hardware Information Center, IBM Cryptographic Coprocessor Card Return Program, at</p> <p><a href="http://publib.boulder.ibm.com/infocenter/eserver/v1r2s/en_US/info/icmain.htm">http://publib.boulder.ibm.com/infocenter/eserver/v1r2s/en_US/info/icmain.htm</a></p>
<p>___ <b>Task 33</b></p>	<p>Review job logs or output from your restore operations to ensure that all objects were restored successfully.</p>	<p>“How to verify that objects are restored successfully” on page 45.</p>
<p><sup>1</sup></p>	<p>You may receive one of the following messages: CPD377A: Object not restored, /QNTC. CPD377A: Object not restored, /QNetWare.</p> <p>These objects cannot be restored until their file systems have been mounted during the IPL. You may ignore these messages. The additional recovery tasks will guide you through the steps to restore these objects.</p> <p><b>Note:</b> Since the i5/OS Enhanced Integration for Novell NetWare software resides on a remote server, you do not have to restore your Netware data when you restore your server. Previously, the i5/OS Integration for Novell NetWare product ran on a Integrated xSeries Server and you had to restore the Novell product if you completely restored your server.</p>	

## Actions for a failure in a basic ASP disk unit–Checklist 11

This checklist should be used for the following problem situation:

**Failed Unit:**

Basic ASP

**Data Loss:**

Some

Most steps in the checklist include references to other topics in this book. Refer to these topics if you need more information about how to perform a particular step. You may not need to perform some steps, such as restoring changed objects, if they do not apply in your situation.

Table 17. Recovery Checklist for Disk Failure–Checklist 11

Task	What To Do	Where To Read More About It
<i>Actions to Be Performed by the Service Representative</i>		
___ Task 1	Save the disk unit.	
___ Task 2	Attach the new disk unit.	
___ Task 3	Restore the disk unit data.	
<i>Actions to Be Performed by the User</i>		
___ Task 4	<b>You must perform an IPL at this time.</b> Follow the procedure for starting the system after it ends abnormally.	Chapter 6, “Starting the System After It Ends Abnormally,” task 1 through task 4.
___ Task 5	Reclaim storage.	“Reclaim Storage” on page 35.
___ Task 6	Evaluate the extent of the damage. Determine whether you will attempt to recover damaged objects or restore the entire system. <b>Do not skip this step.</b>	“Task 4–Recovering from Damaged Objects and Unreadable Sectors” on page 162.
___ Task 7	If you have decided to do a complete restore operation, use Table 30 on page 96 to determine the correct procedure for recovering user information.	
___ Task 8	If you have decided to attempt to recover damaged objects, perform the tasks in “Task 4–Recovering from Damaged Objects and Unreadable Sectors” on page 162.	

## Actions for a failure in a basic ASP disk unit–Checklist 12

This checklist should be used for the following problem situation:

**Failed Unit:**

Basic ASP Not in overflow status

**Data Loss:**

All

**Before you begin your recovery,** make a copy of this checklist. Fill in the appropriate areas as you and the service representative perform the recovery steps. This checklist provides an important record of your recovery actions. It may help you to diagnose any problems that occur after the recovery. It may also be useful in evaluating your backup strategy.

Most steps in the checklist include references to other topics in this book. Refer to these topics if you need more information about how to perform a particular step. You may not need to perform some steps, such as restoring changed objects, if they do not apply in your situation.

Table 18. Recovery Checklist for Disk Failure—Checklist 12

Task	What To Do	Where To Read More About It
<i>Actions to Be Performed by the Service Representative</i>		
___ Task 1	Physically remove the failed disk unit from the system.	
___ Task 2	Delete the data in the ASP that contains the failed unit.	
___ Task 3	Install the replacement disk unit.	
___ Task 4	Configure the replacement disk unit by selecting the 'Replace configured unit' function on the Work with Disk Units display.	
<i>Actions to Be Performed by the User</i>		
___ Task 5	<b>You must perform an IPL at this time.</b> Follow the procedure for starting the system after it ends abnormally.	Chapter 6, "Starting the System After It Ends Abnormally," task 1 through task 4.
___ Task 6	Restore user profiles: RSTUSRPRF USRPRF(*ALL) DEV(TAP01)	"Restoring User Profiles" on page 202.
___ Task 7	If necessary, change the QALWOBJRST system value. Write the old value here: _____	"Controlling Restoration of Security-Sensitive Objects" on page 40.
___ Task 8	If necessary, change the QVFYOBRST system value. Write the old value here: _____	"Controlling Restoration of Security-Sensitive Objects" on page 40.
___ Task 9	If necessary, change the system value that controls whether the job log wraps when it is full. Use the Work with System Values command: WRKSYSVAL QJOBMSGQFL. Write down the current value here: _____	The System Values subtopic of the System Management topic in the iSeries Information Center.
___ Task 10	After changing the system values, sign off by using the command SIGNOFF *LIST. Then, using a newly created password, sign back on as QSECOFR for the new values to take effect.	
___ Task 11	Recover the objects in the basic ASP.	"How to Recover a Damaged Basic Auxiliary Storage Pool" on page 183, task 1 through task 9.
___ Task 12	If you have User-Defined File Systems in basic ASPs that do not restore correctly, you may need to perform additional recovery steps.	"Task 7—Restoring User-Defined File Systems to the User Auxiliary Storage Pool" on page 175.

Table 18. Recovery Checklist for Disk Failure—Checklist 12 (continued)

Task	What To Do	Where To Read More About It
___ Task 13	<p>Perform either a: SIGNOFF *LIST</p> <p>or a DSPJOBLOG * *PRINT</p> <p>Check the job log to ensure all objects were restored. The job log contains information about the restore operation. To verify that all objects were restored, spool the job log for printing along with the job's remaining spooled output, if any.</p> <p>Message CPC3703 is sent to the job log for each library that was successfully restored. Message CPF3773 is sent to tell you how many objects were restored. Objects are not restored for various reasons. Check for any error messages, correct the errors, and then restore those objects from the media.</p>	
___ Task 14	Restore changed objects to the basic ASP. Apply journaled changes to objects in the basic ASP.	Chapter 10, "How to Restore Changed Objects and Apply Journaled Changes," task 1 through task 7.
___ Task 15	Restore authority. Type: RSTAUT	"Restoring Object Authorities" on page 206.
___ Task 16	If necessary, change the QALWOBJRST system value back to its original value by using the WRKSYSVAL command.	"Controlling Restoration of Security-Sensitive Objects" on page 40.
___ Task 17	If necessary, change the QVFYOBJRST system value back to its original value by using the WRKSYSVAL command.	"Controlling Restoration of Security-Sensitive Objects" on page 40.
___ Task 18	If necessary, change the QJOBMSGQFL system value back to its original value by using the WRKSYSVAL command.	The System Values subtopic of the System Management topic in the iSeries Information Center.
___ Task 19	<b>You must perform an IPL at this time.</b>	"How to Perform a Normal IPL" on page 49.
___ Task 20	Review job logs or output from your restore operations to ensure that all objects were restored successfully.	"How to verify that objects are restored successfully" on page 45.

## Actions for a failure in a basic ASP disk unit—Checklist 13

This checklist should be used for the following problem situation:

### Failed Unit:

Basic ASP in overflow status

### Data Loss:

All

**Before you begin your recovery**, make a copy of this checklist. Fill in the appropriate areas as you and the service representative perform the recovery steps. This checklist provides an important record of your recovery actions. It may help you to diagnose any problems that occur after the recovery. It may also be useful in evaluating your backup strategy.



Most steps in the checklist include references to other topics in this book. Refer to these topics if you need more information about how to perform a particular step. You may not need to perform some steps, such as restoring changed objects, if they do not apply in your situation.

Table 19. Recovery Checklist for Disk Failure—Checklist 13

Task	What To Do	Where To Read More About It
<i>Actions to Be Performed by the Service Representative</i>		
___ Task 1	Physically remove the failed disk unit from the system.	
___ Task 2	Delete the data in the ASP that contains the failed unit.	
___ Task 3	Install the replacement disk unit.	
___ Task 4	Configure the replacement disk unit by selecting the 'Replace configured unit' function on the Work with Disk Units display.	
<i>Actions to Be Performed by the User</i>		
___ Task 5	<b>You must perform an IPL at this time.</b> Follow the procedure for starting the system after it ends abnormally.	Chapter 6, "Starting the System After It Ends Abnormally," on page 155.
___ Task 6	Reclaim storage.	"Reclaim Storage" on page 35.
___ Task 7	Delete the overflowed objects.	"How to Delete Overflowed Objects during Recovery" on page 182.
___ Task 8	If necessary, change the QALWOBJRST system value. Write the old value here: _____	"Controlling Restoration of Security-Sensitive Objects" on page 40.
___ Task 9	If necessary, change the QVFYOBJRST system value. Write the old value here: _____	"Controlling Restoration of Security-Sensitive Objects" on page 40.
___ Task 10	If necessary, change the system value that controls whether the job log wraps when it is full. Use the Work with System Values command: WRKSYSVAL QJOBMSGQFL. Write down the current value here: _____. Then change the value to *PRTWRAP.	The System Values subtopic of the System Management topic in the iSeries Information Center.
___ Task 11	After changing the system values, sign off by using the command SIGNOFF *LIST. Then, using a newly created password, sign back on as QSECOFR for the new values to take effect.	
___ Task 12	Recover the objects in the basic ASP.	"How to Recover a Damaged Basic Auxiliary Storage Pool" on page 183, task 1 through task 9.
___ Task 13	If you have User-Defined File Systems in User ASPs that do not restore correctly, you may need to perform additional recovery steps.	"Task 7—Restoring User-Defined File Systems to the User Auxiliary Storage Pool" on page 175.
___ Task 14	Restore changed objects to the basic ASP. Apply journaled changes to objects in the basic ASP.	Chapter 10, "How to Restore Changed Objects and Apply Journaled Changes," task 1 through task 7.

Table 19. Recovery Checklist for Disk Failure—Checklist 13 (continued)

Task	What To Do	Where To Read More About It
___ Task 15	Restore authority. Type: RSTAUT	“Restoring Object Authorities” on page 206.
___ Task 16	If necessary, change the QALWOBJRST system value.	“Controlling Restoration of Security-Sensitive Objects” on page 40.
___ Task 17	If necessary, change the QVIFYOBJRST system value.	“Controlling Restoration of Security-Sensitive Objects” on page 40.
___ Task 18	If necessary, change the QJOBMSGQFL system value back to its original value by using the WRKSYSVAL command.	The System Values subtopic of the System Management topic in the iSeries Information Center.
___ Task 19	<p>Perform either a: SIGNOFF *LIST</p> <p>or a DSPJOBLOG * *PRINT</p> <p>Check the job log to ensure all objects were restored. The job log contains information about the restore operation. To verify that all objects were restored, spool the job log for printing along with the job’s remaining spooled output, if any.</p> <p>Message CPC3703 is sent to the job log for each library that was successfully restored. Message CPF3773 is sent to tell you how many objects were restored. Objects are not restored for various reasons. Check for any error messages, correct the errors, and then restore those objects from the media.</p>	
___ Task 20	<b>You must perform a normal IPL at this time.</b>	“How to Perform a Normal IPL” on page 49.
___ Task 21	Review job logs or output from your restore operations to ensure that all objects were restored successfully.	“How to verify that objects are restored successfully” on page 45.

## Actions for non-load source disk unit failure—Checklist 14

This checklist should be used for the following problem situation:

**Failed Unit:**

Any

**Mirrored Protection:**

Yes

**Before you begin your recovery**, make a copy of this checklist. Fill in the appropriate areas as you and the service representative perform the recovery steps. This checklist provides an important record of your recovery actions. It may help you to diagnose any problems that occur after the recovery. It may also be useful in evaluating your backup strategy.

Most steps in the checklist include references to other topics in this book. Refer to these topics if you need more information about how to perform a particular step. You may not need to perform some steps, such as restoring changed objects, if they do not apply in your situation.

**Note:** For many failures, the system does not have to stopped and started again. The service representative can repair the failed component while the system continues to run. See Chapter 11, “Mirrored Protection Recovery Actions,” on page 269.

Table 20. Recovery Checklist for Disk Failure—Checklist 14

Task	What To Do	Where To Read More About It
<i>Actions to Be Performed by the Service Representative</i>		
___ Task 1	Replace the failed disk unit.	
___ Task 2	Resume mirrored protection.	
<i>Actions to Be Performed by the User</i>		
___ Task 3	Ensure that disk configuration is correct.	Chapter 21, “Working with Mirrored Protection”.

## Actions for non-load source disk unit failure—Checklist 15

This checklist should be used for the following problem situation:

**Failed Unit:**

Any

**Device Parity Protection:**

Yes

Most steps in the checklist include references to other topics in this book. Refer to these topics if you need more information about how to perform a particular step. You may not need to perform some steps, such as restoring changed objects, if they do not apply in your situation.

**Note:** For many failures, the system does not have to stopped and started again. The service representative can repair the failed component while the system continues to run. See Chapter 20, “Working with Device Parity Protection,” on page 397.

Table 21. Recovery Checklist for Disk Failure—Checklist 15

Task	What To Do	Where To Read More About It
<i>Actions to Be Performed by the Service Representative</i>		
___ Task 1	Attach the new disk unit.	
___ Task 2	Rebuild the failed device parity disk unit data.	
<i>Actions to Be Performed by the User</i>		
___ Task 3	Ensure that disk configuration is correct.	Chapter 20, “Working with Device Parity Protection”.

## Actions for non-load source disk unit failure—Checklist 16

This checklist should be used for the following problem situation:

**Failed Unit:**

Non-Load source unit in system ASP

**Data Loss:**

N/A Disk unit cannot be replaced immediately

**Before you begin your recovery**, make a copy of this checklist. Fill in the appropriate areas as you and the service representative perform the recovery steps. This checklist provides an important record of your recovery actions. It may help you to diagnose any problems that occur after the recovery. It may also be useful in evaluating your backup strategy.

Most steps in the checklist include references to other topics in this book. Refer to these topics if you need more information about how to perform a particular step. You may not need to perform some steps, such as restoring changed objects, if they do not apply in your situation.

*Table 22. Recovery Checklist for Disk Failure—Checklist 16*

Task	What To Do	Where To Read More About It
<i>Actions to Be Performed by the User</i>		
___ <b>Task 1</b>	Remove the failed disk unit from the configuration.	“How to Remove a Disk Unit from an Auxiliary Storage Pool” on page 382.
___ <b>Task 2</b>	Restore the Licensed Internal Code using option 1 (Restore Licensed Internal Code).	“How to Prepare for Loading the Licensed Internal Code” on page 112 and “How to Load the Licensed Internal Code” on page 120
___ <b>Task 3</b>	Restore the operating system, beginning with “Task 1—Starting to Restore the Operating System” on page 138. You are performing a <b>complete restore</b> operation.	Chapter 5, “Restoring the Operating System,” task 1 through task 6.
___ <b>Task 4</b>	If you restored the operating system using distribution media, some system information, such as access path recovery times and the system reply list, <u>may</u> have been reset to default values. Verify these values and correct them if necessary.	“Recovering System Information” on page 201.
___ <b>Task 5</b>	Use Table 30 on page 96 to determine the correct procedure for recovering user information.	

## **Actions for independent ASP disk failure—Checklist 17**

This checklist should be used for the following problem situation:

**Failed Unit:**

Disk unit in independent ASP

**Data Loss:**

None

**User ASP Configured:**

Yes

**Before you begin your recovery**, make a copy of this checklist. Fill in the appropriate areas as you and the service representative perform the recovery steps. This checklist provides an important record of your recovery actions. It may help you to diagnose any problems that occur after the recovery. It may also be useful in evaluating your backup strategy.

Most steps in the checklist include references to other topics in this book. Refer to these topics if you need more information about how to perform a particular step. You may not need to perform some steps, such as restoring changed objects, if they do not apply in your situation.

Table 23. Recovery Checklist for Disk Failure—Checklist 17

Task	What To Do	Where To Read More About It
<i>Actions to Be Performed by the Service Representative</i>		
___ Task 1	Save the disk unit data.	
___ Task 2	Attach a new disk unit.	
___ Task 3	Restore data to the new disk unit.	
<i>Actions to Be Performed by the User</i>		
___ Task 4	Vary on the independent ASP.	Use the VRYCFG command or the iSeries Navigator interface to vary on the independent ASP.

## Actions for a failure in an independent ASP disk unit—Checklist 18

This checklist should be used for the following problem situation:

**Failed Unit:**

Independent ASP

**Data Loss:**

Some

**User ASP configured:**

Yes

Most steps in the checklist include references to other topics in this book. Refer to these topics if you need more information about how to perform a particular step. You may not need to perform some steps, such as restoring changed objects, if they do not apply in your situation.

Table 24. Recovery Checklist for Disk Failure—Checklist 18

Task	What To Do	Where To Read More About It
<i>Actions to Be Performed by the Service Representative</i>		
___ Task 1	Save the disk unit.	
___ Task 2	Attach the new disk unit.	
___ Task 3	Restore the disk unit data.	
<i>Actions to Be Performed by the User</i>		
___ Task 4	<b>You must vary on the independent ASP now.</b>	Use the VRYCFG command or the iSeries Navigator interface to vary on the independent ASP.
___ Task 5	Reclaim storage.	“Reclaim Storage” on page 35.
___ Task 6	Evaluate the extent of the damage. Determine whether you will attempt to recover damaged objects or restore the entire system. <b>Do not skip this step.</b>	“Task 4—Recovering from Damaged Objects and Unreadable Sectors” on page 162.
___ Task 7	If you have decided to proceed, continue with the restore operation for independent ASP data.	“How to Recover an Independent ASP” on page 187
___ Task 8	Restore changed objects apply journaled changes to the independent ASP.	Chapter 10, “How to Restore Changed Objects and Apply Journaled Changes.”
___ Task 9	Restore authority. Type: RSTAUT	“Restoring Object Authorities” on page 206.

## Actions for a failure in an independent ASP disk unit–Checklist 19

This checklist should be used for the following problem situation:

**Failed Unit:**

Independent ASP

**Data Loss:**

All

**User ASP configured:**

Yes

**Before you begin your recovery**, make a copy of this checklist. Fill in the appropriate areas as you and the service representative perform the recovery steps. This checklist provides an important record of your recovery actions. It may help you to diagnose any problems that occur after the recovery. It may also be useful in evaluating your backup strategy.

Most steps in the checklist include references to other topics in this book. Refer to these topics if you need more information about how to perform a particular step. You may not need to perform some steps, such as restoring changed objects, if they do not apply in your situation.

*Table 25. Recovery Checklist for Disk Failure–Checklist 19*

Task	What To Do	Where To Read More About It
<i>Actions to Be Performed by the Service Representative</i>		
___ Task 1	Physically remove the failed disk unit from the system.	
___ Task 2	Delete the data in the ASP that contains the failed unit.	
___ Task 3	Install the replacement disk unit.	
___ Task 4	Configure the replacement disk unit by selecting the 'Replace configured unit' function on the Work with Disk Units display.	
<i>Actions to Be Performed by the User</i>		
___ Task 5	<b>Vary on the independent ASP at this time.</b>	Use the VRYCFG command or the iSeries Navigator interface to vary on the independent ASP.
___ Task 6	If necessary, change the QALWOBJRST system value. Write the old value here: _____	"Controlling Restoration of Security-Sensitive Objects" on page 40.
___ Task 7	If necessary, change the QVFYOBJRST system value. Write the old value here: _____	"Controlling Restoration of Security-Sensitive Objects" on page 40.
___ Task 8	If necessary, change the system value that controls whether the job log wraps when it is full. Use the Work with System Values command: WRKSYSVAL QJOBMSGQFL. Write down the current value here: _____	The System Values subtopic of the System Management topic in the iSeries Information Center.
___ Task 9	After changing the system values, sign off by using the command SIGNOFF *LIST. Then, using a newly created password, sign back on as QSECOFR for the new values to take effect.	

Table 25. Recovery Checklist for Disk Failure—Checklist 19 (continued)

Task	What To Do	Where To Read More About It
___ Task 10	Recover the objects in the independent user ASP. <b>Note:</b> If you know which user profiles are authorized to objects in the independent ASP, you can specify the individual profiles and avoid restricting your system to process USRPRF *ALL.	“How to Recover an Independent ASP” on page 187.
___ Task 11	Restore changed objects apply journaled changes to the independent ASP.	Chapter 10, “How to Restore Changed Objects and Apply Journaled Changes.”
___ Task 12	Restore authority. Type: RSTAUT	“Restoring Object Authorities” on page 206.
___ Task 13	Perform either a: SIGNOFF *LIST  or a DSPJOBLOG * *PRINT  Check the job log to ensure all objects were restored. The job log contains information about the restore operation. To verify that all objects were restored, spool the job log for printing along with the job’s remaining spooled output, if any.  Message CPF3773 is sent to tell you how many objects were restored. Objects are not restored for various reasons. Check for any error messages, correct the errors, and then restore those objects from the media.	
___ Task 14	If necessary, change the QALWOBJRST system value back to its original value by using the WRKSYSVAL command.	“Controlling Restoration of Security-Sensitive Objects” on page 40.
___ Task 15	If necessary, change the QVIFYOBRST system value back to its original value by using the WRKSYSVAL command.	“Controlling Restoration of Security-Sensitive Objects” on page 40.
___ Task 16	If necessary, change the QJOBMSGQFL system value back to its original value by using the WRKSYSVAL command.	The System Values subtopic of the System Management topic in the iSeries Information Center.
___ Task 17	Review job logs or output from your restore operations to ensure that all objects were restored successfully.	“How to verify that objects are restored successfully” on page 45.

## Recovering your entire system after a complete system loss—Checklist 20

This checklist should be used if you need to restore your entire system to a system that is running the same version of the i5/OS licensed program. Do not use this checklist if you are performing an upgrade. For information on performing an upgrade, refer to the iSeries Information Center at <http://www.ibm.com/eserver/series/infocenter>. See **i5/OS and related software** —> **Install, upgrade, or delete** —> **Upgrade or replace i5/OS and related software**.

**Note:** If the system you must recover contains an independent ASP, refer to “Recovering your entire system after a complete system loss including independent ASPs—Checklist 21” on page 88.

**Attention:** If you use the Hardware Management Console for eServer (HMC), you must recover the HMC before you perform the following tasks in your recovery. See the eServer Hardware Information Center at <http://www.ibm.com/servers/library/infocenter/>.

**Before you begin your recovery,** make a copy of this checklist. Fill in the appropriate areas as you and the service representative perform the recovery steps. This checklist provides an important record of your recovery actions. It may help you to diagnose any problems that occur after the recovery. It may also be useful in evaluating your backup strategy.

Most steps in the checklist include references to other topics in this book. Refer to these topics if you need more information about how to perform a particular step. You may not need to perform some steps, such as restoring changed objects, if they do not apply in your situation.

Table 26. Recovery Checklist for Complete System Loss—Checklist 20

Task	What To Do	Where To Read More About It
<i>Actions to Be Performed by the User</i>		
___ <b>Task 1</b>	Starting in V5R4 there is no longer a need to manually reset the Operations Console (LAN) service tools device ID password on the client. The client will automatically attempt to resynchronize this password on all connections where a mismatch may occur. However, manually resetting the service tools device ID password on the server may still be required depending on your restore data. See Operations Console in the iSeries Information Center at <a href="http://www.ibm.com/eserver/iseres/infocenter">http://www.ibm.com/eserver/iseres/infocenter</a> for more information.	To resynchronize a previous release of Operations Console, see the Operations Console topic in the iSeries Information Center at <a href="http://www.ibm.com/eserver/iseres/infocenter">http://www.ibm.com/eserver/iseres/infocenter</a> .
___ <b>Task 2</b>	If you are using Operations Console, LAN or direct connect, disconnect from your server and close Operations Console. Restart Operations Console and reconnect by using the user ID of 11111111 and password of 11111111 to sign on to your server.	
___ <b>Task 3</b>	Prepare to load the Licensed Internal Code.	“How to Prepare for Loading the Licensed Internal Code” on page 112.
___ <b>Task 4</b>	Install the Licensed Internal Code using option 2 (Install Licensed Internal Code and Initialize System) <sup>1</sup> .	“How to Load the Licensed Internal Code” on page 120
___ <b>Task 5</b>	Configure the disk units (assign to ASP and set up disk protection). If you saved any User-Defined File Systems (UDFS), you must configure your user ASPs or the UDFS will not restore.	Chapter 18, “Configuring Disks and Disk Protection,” on page 355 and Chapter 19, “Working with Auxiliary Storage Pools,” on page 375.



Table 26. Recovery Checklist for Complete System Loss—Checklist 20 (continued)

Task	What To Do	Where To Read More About It
___ Task 6	<p>To allow system value security changes during your recovery, follow these steps:</p> <ol style="list-style-type: none"> <li>1. On the <i>IPL or Install the System</i> screen, select 3, <b>Use Dedicated Service Tools (DST)</b>. Press <b>Enter</b> to continue.</li> <li>2. Sign on to DST using your DST service tools user name and password.</li> <li>3. Select option 13 (Work with system security).</li> <li>4. Type <b>1</b> in the <b>Allow system value security changes</b> field and press <b>Enter</b>.</li> <li>5. Press <b>F3</b> or <b>F12</b> to get back to the <i>IPL or Install the System</i> screen.</li> </ol>	
___ Task 7	<p>Restore the operating system, beginning with “Task 1—Starting to Restore the Operating System” on page 138. You are performing a <b>complete restore</b> operation.</p>	<p>“How to Restore the operating system” on page 137.</p>
___ Task 8	<p>If you restored the operating system using distribution media, some system information, such as access path recovery times and the system reply list <u>may</u> have been reset to default values. Verify these values and correct them if necessary.</p>	<p>“Recovering System Information” on page 201.</p>
___ Task 9	<p>Recover user information from your save media. Restore changed objects and apply journal entries. <b>If you are restoring to a different system, or a different logical partition, you must specify ALWOBDDIF(*ALL) on the RSTxxx commands.</b>  <b>Note:</b> If you use Backup Recovery and Media Services, refer to your Backup Recovery and Media Services recovery report to recover your user information.</p>	<p>“Choosing the Procedure to Recover User Information” on page 95.</p>
___ Task 10	<p>If you are not sure what the password is for the QSECOFR profile that was restored from tape, change it before signing off: <code>CHGUSRPRF USRPRF(QSECOFR) PASSWORD(new-password)</code></p>	<p>“What Happens When You Restore User Profiles” on page 203.</p>
___ Task 11	<p>If you restored from distribution media, restore your system information to the correct settings.</p>	<p>“Recovering System Information” on page 201.</p>

Table 26. Recovery Checklist for Complete System Loss—Checklist 20 (continued)

Task	What To Do	Where To Read More About It
___ Task 12	<p>Perform either a SIGNOFF *LIST</p> <p>or a DSPJOBLOG * *PRINT</p> <p>Check the job log to ensure that all objects were restored. The job log contains information about the restore operation. To verify that all objects were restored, spool the job log for printing along with the job's remaining spooled output, if any.</p> <p>Message CPC3703 is sent to the job log for each library that was successfully restored. Message CPF3773 is sent to tell you how many objects were restored. Objects are not restored for various reasons. Check for any error messages, correct the error, and then restore those objects from the media.</p>	
___ Task 13	<b>You must perform a normal IPL at this time.</b>	"How to Perform a Normal IPL" on page 49.
___ Task 14	If you use Windows server on iSeries and saved with the Integrated xSeries Server (NWSD) varied on, complete recovery for the Windows server on iSeries.	"Completing Recovery for the IBM iSeries Integration for Windows Server Product" on page 250.
___ Task 15	<p>If IBM Content Manager OnDemand for iSeries is installed, complete journaling for IBM Content Manager OnDemand for iSeries by typing the following commands:</p> <pre>CALL QRDARS/QRLCSTRJ PARM('RLC') CALL QRDARS/QRLCSTRJ PARM('RLR') CALL QRDARS/QRLCSTRJ PARM('RLO')</pre>	
___ Task 16	If you have 4764 Cryptographic Coprocessor Hardware recover 5733-CY1 CCA Device Manager by typing: CALL QCCADEV/QCCAELOAD.	<p>Refer to the eServer Hardware Information Center, IBM Cryptographic Coprocessor Card Return Program, at</p> <p><a href="http://publib.boulder.ibm.com/infocenter/eserver/v1r2s/en_US/info/icmain.htm">http://publib.boulder.ibm.com/infocenter/eserver/v1r2s/en_US/info/icmain.htm</a></p>
___ Task 17	Review job logs or output from your restore operations to ensure that all objects were restored successfully.	"How to verify that objects are restored successfully" on page 45.

## Recovering your entire system after a complete system loss including independent ASPs—Checklist 21

This checklist should be used if you need to restore your entire system that includes an independent ASP to a system that is running the same version of the i5/OS licensed program. Do not use this checklist if you are performing an upgrade. For information on performing an upgrade, refer to the iSeries

Information Center at <http://www.ibm.com/eserver/iserries/infocenter>. See **i5/OS and related software** —> **Install, upgrade, or delete** —> **Upgrade or replace i5/OS and related software**.

**Note:** If you are restoring a clustered system with independent ASPs, refer to the Clustering topic in the Information Center at [www.ibm.com/eserver/iserries/infocenter](http://www.ibm.com/eserver/iserries/infocenter), along with this checklist.

**Attention:** If you use the Hardware Management Console for eServer (HMC), you must recover the HMC before you perform the following tasks in your recovery. See the eServer Hardware Information Center at <http://www.ibm.com/servers/library/infocenter/>.

**Before you begin your recovery**, make a copy of this checklist. Fill in the appropriate areas as you and the service representative perform the recovery steps. This checklist provides an important record of your recovery actions. It may help you to diagnose any problems that occur after the recovery. It may also be useful in evaluating your backup strategy.

Most steps in the checklist include references to other topics in this book. Refer to these topics if you need more information about how to perform a particular step. You may not need to perform some steps, such as restoring changed objects, if they do not apply in your situation.

*Table 27. Recovery Checklist for Complete System Loss—Checklist 21*

Task	What To Do	Where To Read More About It
<i>Actions to Be Performed by the User</i>		
___ <b>Task 1</b>	Starting in V5R4 there is no longer a need to manually reset the Operations Console (LAN) service tools device ID password on the client. The client will automatically attempt to resynchronize this password on all connections where a mismatch may occur. However, manually resetting the service tools device ID password on the server may still be required depending on your restore data. See Operations Console in the iSeries Information Center at <a href="http://www.ibm.com/eserver/iserries/infocenter">http://www.ibm.com/eserver/iserries/infocenter</a> for more information.	To resynchronize a previous release of Operations Console, see the Operations Console topic in the iSeries Information Center at <a href="http://www.ibm.com/eserver/iserries/infocenter">http://www.ibm.com/eserver/iserries/infocenter</a> .
___ <b>Task 2</b>	If you are using Operations Console, LAN or direct connect, disconnect from your server and close Operations Console. Restart Operations Console and reconnect by using the user ID of 1111111 and password of 1111111 to sign on to your server.	
___ <b>Task 3</b>	Prepare to load the Licensed Internal Code <sup>1</sup> .	“How to Prepare for Loading the Licensed Internal Code” on page 112.
___ <b>Task 4</b>	Install the Licensed Internal Code using option 2 (Install Licensed Internal Code and Initialize System).	“How to Load the Licensed Internal Code” on page 120
___ <b>Task 5</b>	Configure the disk units (assign to ASP and set up disk protection). If you saved any User-Defined File Systems (UDFS), you must configure your user ASPs or the UDFS will not restore. <b>Note:</b> You will configure and restore independent ASPs in a later step.	Chapter 18, “Configuring Disks and Disk Protection,” on page 355 and Chapter 19, “Working with Auxiliary Storage Pools,” on page 375.

Table 27. Recovery Checklist for Complete System Loss—Checklist 21 (continued)

Task	What To Do	Where To Read More About It
___ Task 6	To allow system value security changes during your recovery, follow these steps: <ol style="list-style-type: none"> <li>1. On the <i>IPL or Install the System</i> screen, select 3, <b>Use Dedicated Service Tools (DST)</b>. Press <b>Enter</b> to continue.</li> <li>2. Sign on to DST using your DST service tools user name and password.</li> <li>3. Select option 13 (Work with system security).</li> <li>4. Type 1 in the <b>Allow system value security changes</b> field and press <b>Enter</b>.</li> <li>5. Press <b>F3</b> or <b>F12</b> to get back to the <i>IPL or Install the System</i> screen.</li> </ol>	
___ Task 7	Restore the operating system, beginning with “Task 1—Starting to Restore the Operating System” on page 138. You are performing a <b>complete restore</b> operation.	“How to Restore the operating system” on page 137.
___ Task 8	If you restored the operating system using distribution media, some system information, such as access path recovery times and the system reply list <u>may</u> have been reset to default values. Verify these values and correct them if necessary.	“Recovering System Information” on page 201.
___ Task 9	Recover user information from your save media. Restore changed objects and apply journal entries. <b>If you are restoring to a different system, or a different logical partition, you must specify ALW0BJDIF(*ALL) on the RSTxxx commands and SRM(*NONE) on the RSTCFG command.</b> <b>Note:</b> You may want to wait to restore authorities until after you have configured the independent ASPs. You can also prompt on RSTAUT and specify SAVASPDEV(*SYSBAS). This allows users to access objects in the system and basic ASPs, while you complete recovery procedures for the independent ASPs. Both options can eliminate restricting your server again. <b>Note:</b> If you use Backup Recovery and Media Services, refer to your Backup Recovery and Media Services recovery report to recover your user information.	“Choosing the Procedure to Recover User Information” on page 95.
___ Task 10	If you are not sure what the password is for the QSECOFR profile that was restored from tape, change it before signing off: CHGUSRPRF USRPRF(QSECOFR) PASSWORD( <i>new-password</i> )	“What Happens When You Restore User Profiles” on page 203.
___ Task 11	If you restored from distribution media, restore your system information to the correct settings.	“Recovering System Information” on page 201.

Table 27. Recovery Checklist for Complete System Loss—Checklist 21 (continued)

Task	What To Do	Where To Read More About It
___ Task 12	<p>Perform either a SIGNOFF *LIST</p> <p>or a DSPJOBLOG * *PRINT</p> <p>Check the job log to ensure that all objects were restored. The job log contains information about the restore operation. To verify that all objects were restored, spool the job log for printing along with the job's remaining spooled output, if any.</p> <p>Message CPC3703 is sent to the job log for each library that was successfully restored. Message CPF3773 is sent to tell you how many objects were restored. Objects are not restored for various reasons. Check for any error messages, correct the error, and then restore those objects from the media.</p>	
___ Task 13	Configure the Service Tools Server for i5/OS in order to access disk management functions.	See <b>Security &gt; Service Tools</b> in the iSeries Information Center at <a href="http://www.ibm.com/eserver/series/infocenter">http://www.ibm.com/eserver/series/infocenter</a> .
___ Task 14	<b>You must perform a normal IPL at this time.</b>	"How to Perform a Normal IPL" on page 49.
___ Task 15	If you use Windows server on iSeries and saved with the Integrated xSeries Server (NWSD) varied on, complete recovery for the Windows server on iSeries.	"Completing Recovery for the IBM iSeries Integration for Windows Server Product" on page 250.
___ Task 16	Configure independent ASPs through iSeries Navigator.	iSeries Navigator online help for disk units.
___ Task 17	Verify the RESOURCE and make the independent ASP available now. This will create a directory for the independent ASP and automatically mount the UDFS to that directory.	Use the vary configuration (VRYCFG) command in the character-based interface, or the make available function in iSeries Navigator.
___ Task 18	Restore independent ASP data.	"How to Recover an Independent ASP" on page 187
___ Task 19	Update Program Temporary Fix information for all PTF save files in library QGPL by typing: UPDPTFINF.	Chapter 10, "How to Restore Changed Objects and Apply Journalized Changes."
___ Task 20	If the Save System Information (SAVSYSINF) has been used, the run the Restore System Information (RSTSYSINF) command. The Restore System Information (RSTSYSINF) command restores a subset of the system data and objects saved by the Save System Information (SAVSYSINF) command.	"Restore system information" on page 260
___ Task 21	Restore authority. Type: RSTAUT	"Restoring Object Authorities" on page 206.

Table 27. Recovery Checklist for Complete System Loss—Checklist 21 (continued)

Task	What To Do	Where To Read More About It
___ Task 22	If IBM Content Manager OnDemand for iSeries is installed, complete journaling for IBM Content Manager OnDemand for iSeries by typing the following commands:  CALL QRDARS/QRLCSTRJ PARM('RLC') CALL QRDARS/QRLCSTRJ PARM('RLR') CALL QRDARS/QRLCSTRJ PARM('RLO')	
___ Task 23	If you have 4764 Cryptographic Coprocessor Hardware recover 5733-CY1 CCA Device Manager by typing: CALL QCCAEDEV/QCCAELOAD.	Refer to the eServer Hardware Information Center, IBM Cryptographic Coprocessor Card Return Program, at  <a href="http://publib.boulder.ibm.com/infocenter/eserver/v1r2s/en_US/info/icmain.htm">http://publib.boulder.ibm.com/infocenter/eserver/v1r2s/en_US/info/icmain.htm</a>
___ Task 24	Review job logs or output from your restore operations to ensure that all objects were restored successfully.	“How to verify that objects are restored successfully” on page 45.
___ Task 25	When you are ready to start clustering on the node you just recovered, you must start clustering from the active node. This will propagate the most current configuration information to the recovered node.	See <b>Systems management &gt; Clusters</b> in the iSeries Information Center at <a href="http://www.ibm.com/eserver/series/infocenter">http://www.ibm.com/eserver/series/infocenter</a> .

## Restoring a Logical Partition to Another Logical Partition—Checklist 22

This checklist should be used if you need to restore one logical partition to another. If you have independent ASPs configured in your logical partition, refer to “Recovering your entire system after a complete system loss including independent ASPs—Checklist 21” on page 88 as well.

**Before you begin your recovery**, make a copy of this checklist. Fill in the appropriate areas as you and the service representative perform the recovery steps. This checklist provides an important record of your recovery actions. It may help you to diagnose any problems that occur after the recovery. It may also be useful in evaluating your backup strategy.

Most steps in the checklist include references to other topics in this book. Refer to these topics if you need more information about how to perform a particular step. You may not need to perform some steps, such as restoring changed objects, if they do not apply in your situation.

Table 28. Recovery Checklist for Complete System Loss—Checklist 22

Task	What To Do	Where To Read More About It
<i>Actions to Be Performed by the User</i>		
___ Task 1	Prepare to load the Licensed Internal Code <sup>1</sup> .	“How to Prepare for Loading the Licensed Internal Code” on page 112.
___ Task 2	Install the Licensed Internal Code using option 3 (Install Licensed Internal Code and Recover Configuration).	“How to Load the Licensed Internal Code” on page 120

Table 28. Recovery Checklist for Complete System Loss—Checklist 22 (continued)

Task	What To Do	Where To Read More About It
___ Task 3	Configure the disk units (assign to ASP and set up disk protection). If you saved any User-Defined File Systems (UDFS), you must configure your user ASPs or the UDFS will not restore.	Chapter 18, “Configuring Disks and Disk Protection,” on page 355 and Chapter 19, “Working with Auxiliary Storage Pools,” on page 375.
___ Task 4	Restore the operating system, beginning with “Task 1—Starting to Restore the Operating System” on page 138. You are performing a <b>complete restore</b> operation.	“How to Restore the operating system” on page 137.
___ Task 5	If you restored the operating system using distribution media, some system information, such as access path recovery times and the system reply list <u>may</u> have been reset to default values. Verify these values and correct them if necessary.	“Recovering System Information” on page 201.
___ Task 6	Recover user information from your save media. Restore changed objects and apply journal entries. <b>If you are restoring to a different system, or a different logical partition, you must specify ALWOBJDIF(*ALL) on the RSTxxx commands.</b>	“Choosing the Procedure to Recover User Information” on page 95.
___ Task 7	If you are not sure what the password is for the QSECOFR profile that was restored from tape, change it before signing off: CHGUSRPRF USRPRF(QSECOFR) PASSWORD( <i>new-password</i> )	“What Happens When You Restore User Profiles” on page 203.
___ Task 8	If you restored from distribution media, restore your system information to the correct settings.	“Recovering System Information” on page 201.

Table 28. Recovery Checklist for Complete System Loss—Checklist 22 (continued)

Task	What To Do	Where To Read More About It
___ Task 9	<p>Perform either a SIGNOFF *LIST</p> <p>or a DSPJOBLOG * *PRINT</p> <p>Check the job log to ensure that all objects were restored. The job log contains information about the restore operation. To verify that all objects were restored, spool the job log for printing along with the job's remaining spooled output, if any.</p> <p>Message CPC3703 is sent to the job log for each library that was successfully restored. Message CPF3773 is sent to tell you how many objects were restored. Objects are not restored for various reasons. Check for any error messages, correct the error, and then restore those objects from the media.</p>	
___ Task 10	<b>You must perform a normal IPL at this time.</b>	"How to Perform a Normal IPL" on page 49.
___ Task 11	If you use Windows server on iSeries and saved with the Integrated xSeries Server (NWSD) varied on, complete recovery for the Windows server on iSeries product.	"Completing Recovery for the IBM iSeries Integration for Windows Server Product" on page 250.
___ Task 12	<p>If IBM Content Manager OnDemand for iSeries is installed, complete journaling for IBM Content Manager OnDemand for iSeries by typing the following commands:</p> <pre>CALL QRDARS/QRLCSTRJ PARM('RLC') CALL QRDARS/QRLCSTRJ PARM('RLR') CALL QRDARS/QRLCSTRJ PARM('RLO')</pre>	
___ Task 13	If you have 4764 Cryptographic Coprocessor Hardware recover 5733-CY1 CCA Device Manager by typing: CALL QCCAEV/QCCAELOAD.	<p>Refer to the eServer Hardware Information Center, IBM Cryptographic Coprocessor Card Return Program, at</p> <p><a href="http://publib.boulder.ibm.com/infocenter/eserver/v1r2s/en_US/info/icmain.htm">http://publib.boulder.ibm.com/infocenter/eserver/v1r2s/en_US/info/icmain.htm</a></p>
___ Task 14	Review job logs or output from your restore operations to ensure that all objects were restored successfully.	"How to verify that objects are restored successfully" on page 45.

## Actions for a failed cache card – Checklist 23

This checklist should be used for the following problem situation:



**Failed Unit:**

Cache storage in input/output processor

**Data Loss:**

Some

Most steps in the checklist include references to other topics in this book. Refer to these topics if you need more information about how to perform a particular step. You may not need to perform some steps, such as restoring changed objects, if they do not apply in your situation.

*Table 29. Recovery Checklist for Failed Cache Card—Checklist 23*

Task	What To Do	Where To Read More About It
<i>Actions to Be Performed by the Service Representative</i>		
___ <b>Task 1</b>	Reclaim IOP cache storage.	
<i>Actions to Be Performed by the User</i>		
___ <b>Task 2</b>	<p>Evaluate the extent of the damage. It may be fastest to recover the entire ASP.</p> <p>Choose from the following actions to identify damaged objects in critical files where you suspect damage:</p> <ul style="list-style-type: none"> <li>• Use the Copy File (CPYF) command.</li> <li>• Use the Display Object Description (DSPOBJD) command.</li> <li>• Perform a save of your critical data.</li> </ul> <p>Choose from the following actions to identify damaged objects at the system level:</p> <ul style="list-style-type: none"> <li>• Use the Retrieve Disk Information (RTVDSKINF) command.</li> <li>• Use the Display Object Description (DSPOBJD) command and specify DSPOBJD OBJ(*ALL) OBJTYPE(*ALL).</li> <li>• Perform a full system save using GO SAVE option 21.</li> <li>• Run the RCLSTG procedure. Running the procedure is described in “Reclaim Storage” on page 35.</li> </ul>	
___ <b>Task 3</b>	If you have decided to do a complete restore operation, use Table 30 on page 96 to determine the correct procedure for recovering user information.	
___ <b>Task 4</b>	If you have decided to attempt to recover damaged objects, perform the tasks in “Task 4—Recovering from Damaged Objects and Unreadable Sectors” on page 162.	

---

## Choosing the Procedure to Recover User Information

Your first step in a recovery is to return your system to a normal operating condition. This may require:

- Replacing hardware
- Restoring or installing the Licensed Internal Code
- Performing an IPL after the system ends abnormally

When your system is running normally, you are ready to recover user information. Use Table 30 to determine the procedure you should follow. In the table, N/A in a column means that the recovery procedure is the same, whether you respond yes or no.

Table 30. Choosing the Correct Recovery Procedure for User Information

Are You Recovering All *SYSBAS ASPs?	Save Procedure Used	Do You Have SAVCHGOBJs or Journals to Apply?	Do You Want to Use Menu Options to Recover?	Recovery Procedure to Follow
Yes	Commands	N/A	See note 1.	"Recovering User Information Using Commands–Checklist 24" on page 97
Yes	Save menu option 21	No	Yes	"Using Option 21 from the Restore Menu–Checklist 25" on page 100
Yes	Save menu option 21	Yes	N/A	"Recovering User Information Using Commands–Checklist 24" on page 97
Yes	Save menu option 21	No	No	"Recovering User Information Using Commands–Checklist 24" on page 97
Yes	Save menu option 22 Save menu option 23	No	Yes	"Using Options 22 and 23 from the Restore Menu–Checklist 26" on page 103
Yes	Save menu option 22 Save menu option 23	Yes	N/A	"Recovering User Information Using Commands–Checklist 24" on page 97
Yes	Save menu option 22 Save menu option 23	No	No	"Recovering User Information Using Commands–Checklist 24" on page 97
Yes	Save menu option 21 Save menu option 23	No	Yes	"Using Options 22 and 23 from the Restore Menu–Checklist 26" on page 103
Yes	Save menu option 21 Save menu option 23	Yes	N/A	"Recovering User Information Using Commands–Checklist 24" on page 97
Yes	Save menu option 21 Save menu option 23	No	No	"Recovering User Information Using Commands–Checklist 24" on page 97
Yes	Operational Assistant Backup <sup>2</sup>	N/A	N/A	"Recovering User Information Using Tapes from Operational Assistant Backup–Checklist 27" on page 106
No	Any	N/A	N/A	"Recovering User Information Using Commands–Checklist 24" on page 97

<sup>1</sup> If you save using commands rather than menu options, you should recover using commands.

<sup>2</sup> You have saved using either the RUNBACKUP command or the Run Backup menu.

## Recovering User Information Using Commands—Checklist 24

This checklist shows the sequence of steps you should use to recover user information using commands. You may need to perform some tasks more than once. The correct steps for your situation depend on:

- How you saved your information.
- Whether you use journaling or whether applications you have purchased use journaling.
- Whether you have document library objects.
- Whether you save changed objects.

**Before you begin recovering user information**, make a copy of this checklist. Fill in the appropriate areas as you perform the recovery steps. This checklist provides an important record of your recovery actions. It may help you diagnose any problems that occur after the recovery. It may also be useful in evaluating your backup strategy.

Most steps in the checklist include references to other topics in this book. Refer to these topics if you need more information about how to perform a particular step. You may not need to perform some steps, such as restoring changed objects and applying journal changes, if they do not apply in your situation.

<b>Restoring to a Different System or Different Logical Partition?</b>		
<ul style="list-style-type: none"> <li>• You must specify ALWBJDIF(*ALL) on the RSTxxx commands.</li> <li>• You must specify SRM(*NONE) on the RSTCFG command.</li> <li>• Network attributes may be reset to the IBM-supplied defaults.</li> </ul>		

Table 31. Checklist for Recovering User Information Using Commands

Task	What To Do	Where To Read More About It
___ Task 1	If your system is not already in a restricted state, ensure that all users are off the system and that all jobs are ended. Then type <code>ENDSBS SBS(*ALL) OPTION(*CNTRLD) DELAY(600)</code> <sup>1,2</sup> .	“Putting Your System in a Restricted State” on page 35.
___ Task 2	If necessary, change the QALWBJRST system value. Write the old value here: _____	“Controlling Restoration of Security-Sensitive Objects” on page 40.
___ Task 3	If necessary, change the QVFYOBJRST system value. Write the old value here: _____	“Controlling Restoration of Security-Sensitive Objects” on page 40.
___ Task 4	If necessary, change the system value that controls whether the job log wraps when it is full. Use the Work with System Values command: <code>WRKSYSVAL QJOBMSGQFL</code> . Write down the current value here: _____. Then change the value to <code>*PRTWRAP</code> .	The System Values subtopic of the System Management topic in the iSeries Information Center.
___ Task 5	After changing the system values, sign off by using the command <code>SIGNOFF *LIST</code> . Then, using a newly created password, sign back on as QSECOFR for the new values to take effect.	
___ Task 6	If restoring to a system with a different processor or memory, ensure the QMCHPOOL, QBASPOOL, and QPFRADJ system values are correct by using the <code>WRKSYSVAL</code> command.	“How to Set the QPFRADJ System Value for a Different Processor or Memory” on page 44.

Table 31. Checklist for Recovering User Information Using Commands (continued)

Task	What To Do	Where To Read More About It
___ Task 7	Prevent messages that are not related to the recovery from interrupting by typing: CHGMSGQ MSGQ(QSYSOPR) DLVRY(*NOTIFY) SEV(99)	
<b>What ENDOPT?</b>		
When you are restoring from tape, you tell the system whether or not to rewind the tape. If you are using tape in the tasks that follow, specify ENDOPT(*LEAVE) when you have additional steps. Specify ENDOPT(*REWIND) for your last step.		
___ Task 8	Restore user profiles: RSTUSRPRF DEV(TAP01) USRPRF(*ALL)	"Restoring User Profiles" on page 202.
___ Task 9	Restore device configuration: RSTCFG OBJ(*ALL) OBJTYPE(*ALL) DEV(TAP01)	"How to Restore Configuration Objects" on page 218.
___ Task 10	Restore the libraries to each ASP that you are recovering. If you choose not to restore all of your libraries at this time, ensure that you restore the QGPL and QUSRSYS libraries along with the libraries that you are restoring.	"Restoring Libraries" on page 223.
___ Task 11	Restore the ownership for DLOs in the user ASPs you are restoring.	"Task 8– Reclaiming Document Library Objects" on page 176.
___ Task 12	Restore your last complete save of document library objects to each user ASP you are recovering.	"Restoring Documents and Folders" on page 244.
___ Task 13	Restore your last complete save of directories. <sup>3</sup>	"Restoring Objects in Directories" on page 248.
___ Task 14	If you have User-Defined File Systems in User ASPs that do not restore correctly, you may need to perform additional recovery steps.	"Task 7–Restoring User-Defined File Systems to the User Auxiliary Storage Pool" on page 175.
___ Task 15	Restore changed objects and apply journaled changes.	Chapter 10, "How to Restore Changed Objects and Apply Journaled Changes," task 1 through task 7.
l ___ Task 16	Update Program Temporary Fix information for all PTF save files in library QGPL by typing: UPDPTFINF.	
l ___ Task 17	If the Save System Information (SAVSYSINF) has been used, the run the Restore System Information (RSTSYSINF) command. The Restore System Information (RSTSYSINF) command restores a subset of the system data and objects saved by the Save System Information (SAVSYSINF) command. <b>Note:</b> If you have independent ASPs do not perform this step at this time.	"Restore system information" on page 260
___ Task 18	Restore authority. Type: RSTAUT <b>Note:</b> If you are restoring independent ASPs, you can prompt on RSTAUT and specify SAVASPDEV(*SYSBAS). This allows users access to objects in the system and basic ASPs, while you complete recovery procedures for the independent ASPs.	"Restoring Object Authorities" on page 206.

Table 31. Checklist for Recovering User Information Using Commands (continued)

Task	What To Do	Where To Read More About It
___ Task 19	Reapply any PTFs that were applied since your last SAVSYS operation.	"How to Restore Program Temporary Fixes" on page 259.
___ Task 20	If you use Windows server on iSeries and saved with the Integrated xSeries Server (NWSA) varied off, complete recovery for the Windows server on iSeries.	"Completing Recovery for the IBM iSeries Integration for Windows Server Product" on page 250.
___ Task 21	If you run Linux and saved Linux by varying off the network server description (NWSA) for Linux, complete the recovery for Linux.	"Recovering Linux or AIX in a Partition" on page 251
___ Task 22	If necessary, change the QALWBJRST system value back to its original value by using the WRKSYSVAL command.	"Controlling Restoration of Security-Sensitive Objects" on page 40.
___ Task 23	If necessary, change the QVFOBJRST system value back to its original value by using the WRKSYSVAL command.	"Controlling Restoration of Security-Sensitive Objects" on page 40.
___ Task 24	If necessary, change the QJOBMSGQFL system value back to its original value by using the WRKSYSVAL command.	The System Values subtopic of the System Management topic in the iSeries Information Center.
___ Task 25	If you are recovering from a complete system loss, return to the appropriate checklist. Continue with the tasks on that checklist.	
___ Task 26	<p>Perform either a:</p> <pre>SIGNOFF *LIST</pre> <p>or a</p> <pre>DSPJOBLOG * *PRINT</pre> <p>Check the job log to ensure all objects were restored. The job log contains information about the restore operation. To verify that all objects were restored, spool the job log for printing along with the job's remaining spooled output, if any.</p> <p>Message CPC3703 is sent to the job log for each library that was successfully restored. Message CPF3773 is sent to tell you how many objects were restored. Objects are not restored for various reasons. Check for any error messages, correct the errors, and then restore those objects from the media.</p>	
___ Task 27	<b>You must perform a normal IPL at this time.</b>	"How to Perform a Normal IPL" on page 49.
___ Task 28	If you use Windows server on iSeries and saved with the Integrated xSeries Server (NWSA) varied on, complete recovery for the Windows server on iSeries.	"Completing Recovery for the IBM iSeries Integration for Windows Server Product" on page 250.

Table 31. Checklist for Recovering User Information Using Commands (continued)

Task	What To Do	Where To Read More About It
Task 29	If IBM Content Manager OnDemand for iSeries is installed, complete journaling for IBM Content Manager OnDemand for iSeries by typing the following commands: CALL QRDARS/QLCSTRJ PARM('RLC') CALL QRDARS/QLCSTRJ PARM('RLR') CALL QRDARS/QLCSTRJ PARM('RLO')	
Task 30	If you have 4764 Cryptographic Coprocessor Hardware recover 5733-CY1 CCA Device Manager by typing: CALL QCCAEV/QCCAELOAD.	Refer to the eServer Hardware Information Center, IBM Cryptographic Coprocessor Card Return Program, at  <a href="http://publib.boulder.ibm.com/infocenter/eserver/v1r2s/en_US/info/icmain.htm">http://publib.boulder.ibm.com/infocenter/eserver/v1r2s/en_US/info/icmain.htm</a>
Task 31	Review job logs or output from your restore operations to ensure that all objects were restored successfully.	"How to verify that objects are restored successfully" on page 45.
1	Your system must be in a restricted state to restore user profiles. Other steps in the recovery may not require a restricted state. However, to ensure the success of your recovery and better performance when you are restoring information, a restricted state is recommended.	
2	For the delay parameter, specify a number of seconds that allows your system time to bring most jobs to a normal end. On a large, busy system, you may need a longer delay.	
3	You may receive one of the following messages: CPD377A: Object not restored, /QNTC. CPD377A: Object not restored, /QNetWare.  These objects cannot be restored until their file systems have been mounted during the IPL. The additional recovery tasks will guide you through the steps to restore these objects. <b>Note:</b> Since the i5/OS Enhanced Integration for Novell NetWare software resides on a remote server, you do not have to restore your Netware data when you restore your server. Previously, the i5/OS Integration for Novell NetWare product ran on a Integrated xSeries Server and you had to restore the Novell product if you completely restored your server.	

## Using Option 21 from the Restore Menu—Checklist 25

This checklist shows the sequence of steps you should use to recover user information using option 21 from the Restore menu. Option 21 restores your system to your last complete save.

**Before you begin recovering user information**, make a copy of this checklist. Fill in the appropriate areas as you perform the recovery steps. This checklist provides an important record of your recovery actions. It may help you diagnose any problems that occur after the recovery. It may also be useful in evaluating your backup strategy.

Most steps in the checklist include references to other topics in this book. Refer to these topics if you need more information about how to perform a particular step. You may not need to perform some steps, such as restoring changed objects and applying journal changes, if they do not apply in your situation.

### Restoring to a Different System?

If you are restoring to a different system or to a different logical partition, be aware of the following:

- You must specify ALWOBJDIF(\*ALL) on the RSTxxx commands.
- You must specify SRM(\*NONE) on the RSTCFG command.
- Network attributes may be reset to the IBM-supplied defaults.

**Note:** An option is available on the restore menu that indicates that you are restoring to a different system. If you selected this option, the system automatically specifies the first two items that are listed above. You should also specify this option if you are restoring to a different logical partition.

Table 32. Checklist for Recovering User Information Using Option 21

Task	What To Do	Where To Read More About It
___ Task 1	If necessary, change the QALWOBJRST system value. Write the old value here: _____	"Controlling Restoration of Security-Sensitive Objects" on page 40.
___ Task 2	If necessary, change the QVIFYOBRST system value. Write the old value here: _____	"Controlling Restoration of Security-Sensitive Objects" on page 40.
___ Task 3	If necessary, change the system value that controls whether the job log wraps when it is full. Use the Work with System Values command: WRKSYSVAL QJOBMSGQFL. Write down the current value here: _____. Then change the value to *PRTWRAP.	The System Values subtopic of the System Management topic in the iSeries Information Center.
___ Task 4	After changing the system values, sign off by using the command SIGNOFF *LIST. Then, using a newly created password, sign back on as QSECOFR for the new values to take effect.	
___ Task 5	If restoring to a system with a different processor or memory, ensure the QMCHPOOL, QBASPOOL, and QPFRADJ system values are correct by using the WRKSYSVAL command.	"How to Set the QPFRADJ System Value for a Different Processor or Memory" on page 44.
___ Task 6	Perform option 21 from the Restore menu. Use your most recent tapes from performing option 21 on the Save menu. <b>If you are recovering using "Recovering your entire system after a complete system loss—Checklist 20" on page 85 and restoring to a different system, use the "Restore to different system" option on the Specify Command Defaults display. You should also use this option if you restoring to a different logical partition. This option will automatically specify ALWOBJDIF(*ALL) on the RSTxxx commands and SRM(*NONE) on the RSTCFG command.</b> <sup>1</sup>	"How to Use Restore Menu Options 21, 22, and 23" on page 196.

Table 32. Checklist for Recovering User Information Using Option 21 (continued)

Task	What To Do	Where To Read More About It
___ Task 7	If you use Windows server on iSeries and saved with the Integrated xSeries Server (NWSA) varied off, complete recovery for the Windows server on iSeries product.	"Completing Recovery for the IBM iSeries Integration for Windows Server Product" on page 250.
___ Task 8	If you run Linux and saved Linux by varying off the network server description (NWSA) for Linux, complete the recovery for Linux.	"Recovering Linux or AIX in a Partition" on page 251
___ Task 9	If you have User-Defined File Systems in User ASPs that do not restore correctly, you may need to perform additional recovery steps.	"Task 7—Restoring User-Defined File Systems to the User Auxiliary Storage Pool" on page 175.
___ Task 10	Update Program Temporary Fix information for all PTF save files in library QGPL by typing: UPDPTFINE.	
___ Task 11	If the Save System Information (SAVSYSINF) has been used, the run the Restore System Information (RSTSYSINF) command. The Restore System Information (RSTSYSINF) command restores a subset of the system data and objects saved by the Save System Information (SAVSYSINF) command.	"Restore system information" on page 260
___ Task 12	Reapply any PTFs that were applied since your last SAVSYS operation.	"How to Restore Program Temporary Fixes" on page 259.
___ Task 13	If necessary, change the QALWBJRST system value back to its original value by using the WRKSYSVAL command.	"Controlling Restoration of Security-Sensitive Objects" on page 40.
___ Task 14	If necessary, change the QVFYBJRST system value back to its original value by using the WRKSYSVAL command.	"Controlling Restoration of Security-Sensitive Objects" on page 40.
___ Task 15	If necessary, change the QJOBMSGQFL system value back to its original value by using the WRKSYSVAL command.	The System Values subtopic of the System Management topic in the iSeries Information Center.
___ Task 16	If you are recovering from a complete system loss, return to "Recovering your entire system after a complete system loss—Checklist 20" on page 85. Refer to the appropriate task in the checklist.	
___ Task 17	<b>You must perform a normal IPL at this time.</b>	"How to Perform a Normal IPL" on page 49.
___ Task 18	If you use Windows server on iSeries and saved with the Integrated xSeries Server (NWSA) varied on, complete recovery for the Windows server on iSeries product.	"Completing Recovery for the IBM iSeries Integration for Windows Server Product" on page 250.
___ Task 19	If IBM Content Manager OnDemand for iSeries is installed, complete journaling for IBM Content Manager OnDemand for iSeries by typing the following commands: CALL QRDARS/QRLCSTRJ PARM('RLC') CALL QRDARS/QRLCSTRJ PARM('RLR') CALL QRDARS/QRLCSTRJ PARM('RLO')	



Table 32. Checklist for Recovering User Information Using Option 21 (continued)

Task	What To Do	Where To Read More About It
___ Task 20	If you have 4764 Cryptographic Coprocessor Hardware recover 5733-CY1 CCA Device Manager by typing: CALL QCCAEDEV/QCCAELOAD.	Refer to the eServer Hardware Information Center, IBM Cryptographic Coprocessor Card Return Program, at  <a href="http://publib.boulder.ibm.com/infocenter/eserver/v1r2s/en_US/info/icmain.htm">http://publib.boulder.ibm.com/infocenter/eserver/v1r2s/en_US/info/icmain.htm</a>
___ Task 21	Review job logs or output from your restore operations to ensure that all objects were restored successfully.	"How to verify that objects are restored successfully" on page 45.
<sup>1</sup>	<p>You may receive one of the following messages:            CPD377A: Object not restored, /QNTC.            CPD377A: Object not restored, /QNetWare.</p> <p>These objects cannot be restored until their file systems have been mounted during the IPL. The additional recovery tasks will guide you through the steps to restore these objects.</p> <p><b>Note:</b> Since the i5/OS Enhanced Integration for Novell NetWare software resides on a remote server, you do not have to restore your Netware data when you restore your server. Previously, the i5/OS Integration for Novell NetWare product ran on a Integrated xSeries Server and you had to restore the Novell product if you completely restored your server.</p>	

## Using Options 22 and 23 from the Restore Menu—Checklist 26

This checklist shows the sequence of steps you should use to recover user information using option 22 and 23 from the restore menu. Option 22 restores your IBM-supplied libraries to your last save. Option 23 restores your user libraries to your last save.

**Before you begin recovering user information,** make a copy of this checklist. Fill in the appropriate areas as you perform the recovery steps. This checklist provides an important record of your recovery actions. It may help you diagnose any problems that occur after the recovery. It may also be useful in evaluating your backup strategy.

Most steps in the checklist include references to other topics in this book. Refer to these topics if you need more information about how to perform a particular step. You may not need to perform some steps, such as restoring changed objects and applying journal changes, if they do not apply in your situation.

Table 33. Checklist for Recovering User Information Using Options 22 and 23

Task	What To Do	Where To Read More About It
___ Task 1	If necessary, change the QALWBJRST system value back to its original value by using the WRKSYSVAL command. Write the old value here: _____	"Controlling Restoration of Security-Sensitive Objects" on page 40.
___ Task 2	If necessary, change the QVfyOBRST system value back to its original value by using the WRKSYSVAL command. Write the old value here: _____	"Controlling Restoration of Security-Sensitive Objects" on page 40.

Table 33. Checklist for Recovering User Information Using Options 22 and 23 (continued)

Task	What To Do	Where To Read More About It
___ Task 3	If necessary, change the system value that controls whether the job log wraps when it is full. Use the Work with System Values command: WRKSYSVAL QJOBMSGQFL. Write down the current value here: _____. Then change the value to *PRTWRAP.	The System Values subtopic of the System Management topic in the iSeries Information Center.
___ Task 4	After changing the system values, sign off by using the command SIGNOFF *LIST. Then, using a newly created password, sign back on as QSECOFR for the new values to take effect.	
___ Task 5	If restoring to a system with a different processor or memory, ensure the QMCHPOOL, QBASPOOL, and QPFRADJ system values are correct by using the WRKSYSVAL command.	"How to Set the QPFRADJ System Value for a Different Processor or Memory" on page 44.
___ Task 6	Perform option 22 from the Restore menu to restore IBM-supplied libraries and directories. Use your most recent tapes from performing either option 21 or option 22 on the Save menu. <b>If you are recovering using "Recovering your entire system after a complete system loss—Checklist 20" on page 85 and restoring to a different system, use the "Restore to different system" option on the Specify Command Defaults display. You should also use this option if you restoring to a different logical partition. This option will automatically specify ALWOBJDIF(*ALL) on the RSTxxx commands and SRM(*NONE) on the RSTCFG command.<sup>1</sup></b>	"How to Use Restore Menu Options 21, 22, and 23" on page 196.
___ Task 7	Perform option 23 from the Restore menu to restore user libraries and user directories. Use your most recent tapes from performing either option 21 or option 23 on the Save menu. <b>If you are recovering using "Recovering your entire system after a complete system loss—Checklist 20" on page 85 and restoring to a different system, use the "Restore to different system" option on the Specify Command Defaults display. You should also use this option if you restoring to a different logical partition. This option will automatically specify ALWOBJDIF(*ALL) on the RSTxxx commands and SRM(*NONE) on the RSTCFG command.<sup>1</sup></b>	"How to Use Restore Menu Options 21, 22, and 23" on page 196.
___ Task 8	If you use Windows server on iSeries and saved with the Integrated xSeries Server (NWSA) varied off, complete recovery for the Windows server on iSeries product.	"Completing Recovery for the IBM iSeries Integration for Windows Server Product" on page 250.

Table 33. Checklist for Recovering User Information Using Options 22 and 23 (continued)

Task	What To Do	Where To Read More About It
___ Task 9	If you run Linux and saved Linux by varying off the network server description (NWSA) for Linux, complete the recovery for Linux.	"Recovering Linux or AIX in a Partition" on page 251
___ Task 10	If you have User-Defined File Systems in User ASPs that do not restore correctly, you may need to perform additional recovery steps.	"Task 7—Restoring User-Defined File Systems to the User Auxiliary Storage Pool" on page 175.
___ Task 11	Update Program Temporary Fix information for all PTF save files in library QGPL by typing: UPDPTFINF.	
___ Task 12	If the Save System Information (SAVSYSINF) has been used, the run the Restore System Information (RSTSYSINF) command. The Restore System Information (RSTSYSINF) command restores a subset of the system data and objects saved by the Save System Information (SAVSYSINF) command.	"Restore system information" on page 260
___ Task 13	Reapply any PTFs that were applied since your last SAVSYS operation.	"How to Restore Program Temporary Fixes" on page 259.
___ Task 14	If necessary, change the QALWOBJRST system value.	"Controlling Restoration of Security-Sensitive Objects" on page 40 on 41.
___ Task 15	If necessary, change the QVFYOBJRST system value.	"Controlling Restoration of Security-Sensitive Objects" on page 40 on 41.
___ Task 16	If necessary, change the QJOBMSGQFL system value back to its original value by using the WRKSYSVAL command.	The System Values subtopic of the System Management topic in the iSeries Information Center.
___ Task 17	<p>Perform either a:</p> <p>SIGNOFF *LIST</p> <p>or a</p> <p>DSPJOBLOG * *PRINT</p> <p>Check the job log to ensure all objects were restored. The job log contains information about the restore operation. To verify that all objects were restored, spool the job log for printing along with the job's remaining spooled output, if any.</p> <p>Message CPC3703 is sent to the job log for each library that was successfully restored. Message CPF3773 is sent to tell you how many objects were restored. Objects are not restored for various reasons. Check for any error messages, correct the errors, and then restore those objects from the media.</p>	
___ Task 18	<b>You must perform a normal IPL at this time.</b>	"How to Perform a Normal IPL" on page 49.

Table 33. Checklist for Recovering User Information Using Options 22 and 23 (continued)

Task	What To Do	Where To Read More About It
___ Task 18	If you use Windows server on iSeries and saved with the Integrated xSeries Server (NWSA) varied on, complete recovery for the Windows server on iSeries product.	“Completing Recovery for the IBM iSeries Integration for Windows Server Product” on page 250.
___ Task 20	If IBM Content Manager OnDemand for iSeries is installed, complete journaling for IBM Content Manager OnDemand for iSeries by typing the following commands: CALL QRDARS/QRLCSTRJ PARM('RLC') CALL QRDARS/QRLCSTRJ PARM('RLR') CALL QRDARS/QRLCSTRJ PARM('RLO')	
___ Task 21	If you have 4764 Cryptographic Coprocessor Hardware recover 5733-CY1 CCA Device Manager by typing: CALL QCCAEV/QCCAELOAD.	Refer to the eServer Hardware Information Center, IBM Cryptographic Coprocessor Card Return Program, at  <a href="http://publib.boulder.ibm.com/infocenter/eserver/v1r2s/en_US/info/icmain.htm">http://publib.boulder.ibm.com/infocenter/eserver/v1r2s/en_US/info/icmain.htm</a>
___ Task 22	Review job logs or output from your restore operations to ensure that all objects were restored successfully.	“How to verify that objects are restored successfully” on page 45.
<sup>1</sup>	<p>You may receive one of the following messages: CPD377A: Object not restored, /QNTC. CPD377A: Object not restored, /QNetWare.</p> <p>These objects cannot be restored until their file systems have been mounted during the IPL. The additional recovery tasks will guide you through the steps to restore these objects. <b>Note:</b> Since the i5/OS Enhanced Integration for Novell NetWare software resides on a remote server, you do not have to restore your Netware data when you restore your server. Previously, the i5/OS Integration for Novell NetWare product ran on a Integrated xSeries Server and you had to restore the Novell product if you completely restored your server.</p>	

## Recovering User Information Using Tapes from Operational Assistant Backup—Checklist 27

This checklist shows the sequence of steps you should use to recover user information when you have saved using Operational Assistant backup. These procedures assume that all of your backup is done using Operational Assistant. You have not mixed Operational Assistant backup with other save methods.

**Before you begin recovering user information,** make a copy of this checklist. Fill in the appropriate areas as you perform the recovery steps. This checklist provides an important record of your recovery actions. It may help you diagnose any problems that occur after the recovery. It may also be useful in evaluating your backup strategy.

Most steps in the checklist include references to other topics in this book. Refer to these topics if you need more information about how to perform a particular step. You may not need to perform some steps, such as restoring changed objects and applying journal changes, if they do not apply in your situation.

### Restoring to a Different System?

If you are restoring to a different system or to a different logical partition, be aware of the following:

- You must specify ALWOBJDIF(\*ALL) on the RSTxxx commands.
- You must specify SRM(\*NONE) on the RSTCFG command.
- Network attributes are reset to the IBM-supplied defaults.

Table 34. Checklist for Recovering User Information Using Operational Assistant Backup Tapes

Task	What To Do	Where To Read More About It
___ Task 1	If your system is operational and the QUSRSYS library is on the system, print the Backup Status and the Backup History by typing: DSPBCKSTS OUTPUT(*PRINT).	
___ Task 2	If your system is operational and the QUSRSYS library is on the system, print the Backup List by typing: DSPBCKUPL OUTPUT(*PRINT).	
___ Task 3	If your system is not already in a restricted state, ensure all users are off the system. Then type ENDSBS SBS(*ALL) OPTION(*CNTRLD) DELAY(600) <sup>1,2</sup> .	"Putting Your System in a Restricted State" on page 35.
___ Task 4	If necessary, change the QVYOBJRST system value back to its original value by using the WRKSYSVAL command. Write the old value here: _____	"Controlling Restoration of Security-Sensitive Objects" on page 40.
___ Task 5	If necessary, change the QALWOBJRST system value back to its original value by using the WRKSYSVAL command. Write the old value here: _____	"Controlling Restoration of Security-Sensitive Objects" on page 40.
___ Task 6	If necessary, change the system value that controls whether the job log wraps when it is full. Use the Work with System Values command: WRKSYSVAL QJOBMSGQFL. Write down the current value here: _____ Then change the value to *PRTWRAP.	The System Values subtopic of the System Management topic in the iSeries Information Center.
___ Task 7	After changing the system values, sign off by using the command SIGNOFF *LIST. Then, using a newly created password, sign back on as QSECOFR for the new values to take effect.	
___ Task 8	If restoring to a system with a different processor or memory, ensure the QMCHPOOL, QBASPOOL, and QPFRADJ system values are correct by using the WRKSYSVAL command.	"How to Set the QPFRADJ System Value for a Different Processor or Memory" on page 44.
___ Task 9	Prevent messages that are not related to the recovery from interrupting by typing: CHGMSGQ MSGQ(QSYSOPR) DLVRY(*NOTIFY) SEV(99)	
___ Task 10	Restore user profiles: RSTUSRPRF DEV(TAP01) USRPRF(*ALL).	"Restoring User Profiles" on page 202.

Table 34. Checklist for Recovering User Information Using Operational Assistant Backup Tapes (continued)

Task	What To Do	Where To Read More About It
___ Task 11	Restore device configuration: RSTCFG OBJ(*ALL) OBJTYPE(*ALL) DEV(TAP01)	"How to Restore Configuration Objects" on page 218.
___ Task 12	Restore the libraries to each ASP that you are recovering. If you choose not to restore all of your libraries at this time, ensure that you restore the QGPL and QUSRSYS libraries along with the libraries that you are restoring.	"How to Restore Your Libraries" on page 286
___ Task 13	Restore the ownership for DLOs in the user ASPs that you are restoring.	"Task 8– Reclaiming Document Library Objects" on page 176.
___ Task 14	Restore your last complete save of document library objects to each user ASP that you are recovering.	"Restoring Documents and Folders" on page 244.
___ Task 15	Restore your last complete save of directories <sup>3</sup> .	"Restoring Objects in Directories" on page 248.
___ Task 16	Restore incremental backups of libraries.	"How to Restore Libraries That You Saved by Using a Backup List" on page 287.
___ Task 17	Restore changed objects.	"How to Restore Changed Objects That You Saved by Using Operational Assistant" on page 288.
___ Task 16	Update Program Temporary Fix information for all PTF save files in library QGPL by typing: UPDPTFINE.	
___ Task 17	If the Save System Information (SAVSYSINF) has been used, the run the Restore System Information (RSTSYSINF) command. The Restore System Information (RSTSYSINF) command restores a subset of the system data and objects saved by the Save System Information (SAVSYSINF) command. <b>Note:</b> If you have independent ASPs do not perform this step at this time.	"Restore system information" on page 260
___ Task 18	Restore authority. Type: RSTAUT	"Restoring Object Authorities" on page 206.
___ Task 19	Reapply any PTFs that were applied since your last SAVSYS operation.	"How to Restore Program Temporary Fixes" on page 259.
___ Task 20	If you have User-Defined File Systems in User ASPs that do not restore correctly, you may need to perform additional recovery steps.	"Task 7–Restoring User-Defined File Systems to the User Auxiliary Storage Pool" on page 175.
___ Task 21	If you use Windows server on iSeries and saved with the Integrated xSeries Server (NWSD) varied off, complete recovery for the Windows server on iSeries product.	"Completing Recovery for the IBM iSeries Integration for Windows Server Product" on page 250.
___ Task 22	If you run Linux and saved Linux by varying off the network server description (NWSD) for Linux, complete the recovery for Linux.	"Recovering Linux or AIX in a Partition" on page 251
___ Task 23	If necessary, change the QALWOBJRST system value.	"Controlling Restoration of Security-Sensitive Objects" on page 40.

Table 34. Checklist for Recovering User Information Using Operational Assistant Backup Tapes (continued)

Task	What To Do	Where To Read More About It
___ Task 24	If necessary, change the QVIFYOJBRST system value.	"Controlling Restoration of Security-Sensitive Objects" on page 40.
___ Task 25	If necessary, change the QJOBMSGQFL system value back to its original value by using the WRKSYSVAL command.	The System Values subtopic of the System Management topic in the iSeries Information Center.
___ Task 26	<p>Perform either a:</p> <p>SIGNOFF *LIST</p> <p>or a</p> <p>DSPJOBLOG * *PRINT</p> <p>Check the job log to ensure all objects were restored. The job log contains information about the restore operation. To verify that all objects were restored, spool the job log for printing along with the job's remaining spooled output, if any.</p> <p>Message CPC3703 is sent to the job log for each library that was successfully restored. Message CPF3773 is sent to tell you how many objects were restored. Objects are not restored for various reasons. Check for any error messages, correct the errors, and then restore those objects from the media.</p>	
___ Task 27	<b>You must perform a normal IPL at this time.</b>	"How to Perform a Normal IPL" on page 49.
___ Task 28	If you use Windows server on iSeries and saved with the Integrated xSeries Server (NWSD) varied on, complete recovery for the Windows server on iSeries product.	"Completing Recovery for the IBM iSeries Integration for Windows Server Product" on page 250.
___ Task 29	<p>If IBM Content Manager OnDemand for iSeries is installed, complete journaling for IBM Content Manager OnDemand for iSeries by typing the following commands:</p> <p>CALL QRDARS/QRLCSTRJ PARM('RLC')</p> <p>CALL QRDARS/QRLCSTRJ PARM('RLR')</p> <p>CALL QRDARS/QRLCSTRJ PARM('RLO')</p>	
___ Task 30	If you have 4764 Cryptographic Coprocessor Hardware recover 5733-CY1 CCA Device Manager by typing: CALL QCCADEV/QCCAELOAD.	<p>Refer to the eServer Hardware Information Center, IBM Cryptographic Coprocessor Card Return Program, at</p> <p><a href="http://publib.boulder.ibm.com/infocenter/eserver/v1r2s/en_US/info/icmain.htm">http://publib.boulder.ibm.com/infocenter/eserver/v1r2s/en_US/info/icmain.htm</a></p>
___ Task 31	Review job logs or output from your restore operations to ensure that all objects were restored successfully.	"How to verify that objects are restored successfully" on page 45.

Table 34. Checklist for Recovering User Information Using Operational Assistant Backup Tapes (continued)

Task	What To Do	Where To Read More About It
1	Your system must be in a restricted state to restore user profiles. Other steps in the recovery may not require a restricted state. However, to ensure the success of your recovery and better performance when you are restoring information, a restricted state is recommended.	
2	For the delay parameter, specify a number of seconds that allows your system time to bring most jobs to a normal end. On a large, busy system, you may need a longer delay.	
3	<p>You may receive one of the following messages:</p> <p>CPD377A: Object not restored, /QNTC.            CPD377A: Object not restored, /QNetWare.</p> <p>These objects cannot be restored until their file systems have been mounted during the IPL. The additional recovery tasks will guide you through the steps to restore these objects.</p> <p><b>Note:</b> Since the i5/OS Enhanced Integration for Novell NetWare software resides on a remote server, you do not have to restore your Netware data when you restore your server. Previously, the i5/OS Integration for Novell NetWare product ran on a Integrated xSeries Server and you had to restore the Novell product if you completely restored your server.</p>	



---

## Chapter 4. Recovering the Licensed Internal Code

Licensed Internal Code is the layer of iSeries server architecture just above the hardware. You must have the Licensed Internal Code on your machine before you can restore the operating system. You must use the control panel on your system unit to start the recovery of the Licensed Internal Code.

The Install Licensed Internal Code (LIC) menu provides several methods for loading the Licensed Internal Code to your system. Table 35 describes the options and how they are used:

Table 35. Options from the Install the Licensed Internal Code (LIC) Menu

Option Number	Description	Purpose
1	Restore	<p>Restores the Licensed Internal Code without removing other information that is on the system. Option 1 is normally used in the following situations:</p> <ul style="list-style-type: none"><li>• You are encountering problems with the operating system, such as damaged objects. You sometimes need to restore the Licensed Internal Code before restoring the operating system.</li><li>• The software support center recommends it.</li><li>• You have replaced a failed disk unit other than unit 1 in the system ASP.</li><li>• You are updating your system to a new release. See the <i>Install, upgrade, or delete i5/OS and related software</i> book for the procedures to install a new release of the iSeries server.</li></ul>
2	Install the Licensed Internal Code and Initialize system	<p>Installs the Licensed Internal Code and removes all data from all disk units. Option 2 is normally used in the following situations:</p> <ul style="list-style-type: none"><li>• You are doing a restore operation using the SAVSTG media.</li><li>• You are restoring to another system to recover from a complete system loss.</li><li>• You are recovering with SAVSYS media that is at a previous release than what is currently installed on the system.</li></ul> <p>If a system is configured to use Operations Console, and that system undergoes a backup and recovery cycle, you will have to perform the following steps:</p> <ol style="list-style-type: none"><li>1. Perform an initial program load (IPL) in Manual mode.</li><li>2. If a system is configured to use the Operations Console, and that system undergoes a backup and recovery cycle, you may have to perform these steps:<ol style="list-style-type: none"><li>a. Perform an Initial Program Load (IPL) in Manual mode.</li><li>b. Use Dedicated Service Tools (DST) to reconfigure the system so that it will detect the PC console when you perform an IPL in Normal mode.</li></ol></li></ol> <p>Detailed instructions on setting up Operations Console are in the Connecting to iSeries topic in the iSeries Information Center at <a href="http://www.ibm.com/eserver/series/infocenter">http://www.ibm.com/eserver/series/infocenter</a>.</p>
3	Install Licensed Internal Code and Recover Configuration	<p>Installs the Licensed Internal Code and prompts you to begin the procedure to recover information about how the disks were configured on your system (including ASP assignments and protection). Option 3 is normally used in the following situations:</p> <ul style="list-style-type: none"><li>• You have replaced the load source unit.</li><li>• The software support center recommends it.</li></ul>

Table 35. Options from the Install the Licensed Internal Code (LIC) Menu (continued)

Option Number	Description	Purpose
4	Install Licensed Internal Code and Restore Disk Unit Data	Installs the Licensed Internal Code and restores data to a replacement disk unit. This option is used only by a service representative after data was successfully saved (pumped) from a failed load source disk unit.

The recovery checklists in Chapter 3 specify which procedures in this chapter are required for your situation.

**Attention!**

Make sure you use the correct procedure for your situation. Some of the procedures in this chapter will remove all data from your system.

## How to Prepare for Loading the Licensed Internal Code

The tasks for starting to load the Licensed Internal Code include the following:

- Finding the right media and documentation.
- Stopping your system, if it is running.
- Performing an IPL from an alternate device, either tape or optical media.

Check off each step in these tasks as you complete it.

## Task 1—Getting Ready to Load the Licensed Internal Code

*Find These Things Before You Begin:*

- Your most recent SAVSYS media. One of the following creates a SAVSYS media image:
  - Running the Save System (SAVSYS) command.
  - Using option 21 from the Save menu.
  - Using option 22 from the Save menu.
  - Using option 11 from the Run Backup menu.

**Attention!**

**DO NOT** use a media volume that you created through DST by using option 5=Save Licensed Internal Code from the IPL or Install the System menu unless you have been instructed to do so by Software Services. A media volume that is created through this process does not contain the Licensed Internal Code PTF Inventory information or the i5/OS Operating System. If you perform the recovery process using this media volume, you will have to re-install the Licensed Internal Code from either a SAVSYS media volume or from your distribution media before you can load any PTFs onto the system.

- If you enabled your device as an alternate installation device, you will need the Licensed Internal Code CD-ROM. (An alternate installation device is an alternate IPL device that is connected to a bus other than the system bus (bus 1).) Refer to Chapter 17, “Using an Alternate Installation Device,” on page 347 for more information.
- If you do not have current SAVSYS media or they are damaged, you need the following:
  - The distribution media (optical media or tape) that is supplied by IBM.

- All the optical media for program temporary fixes you have applied. Use the distribution media only if you do not have SAVSYS media. If you use the distribution media to restore the Licensed Internal Code, you will lose some of your system information, such as the program temporary fixes you have applied.
- The list of all the program temporary fixes (PTFs) applied to your system at the time you saved the entire system. This list should be attached to your backup log or found with your SAVSYS media.
- The keystick for the system if it is not already inserted in the control panel.
- The manual for the tape or optical device that is your alternate IPL device. It describes other SRC codes you might see.

**Note:** If you saved to virtual media, you must have subsequently saved your Licensed Internal Code and operating system to physical media from the virtual images. Physical media is required to begin the recovery process. You must also have access to all of your user data on physical media.

*Do These Things Before You Begin:*

- Clean the read and write heads of the tape unit if you are using a tape device.
- If your source system (the system that was saved and needs recovery) is operational, print a list of all the program temporary fixes (PTFs) currently on the system. Type the following and press the Enter key:  

```
DSPPTF LICPGM(*ALL) OUTPUT(*PRINT)
```
- If you are using Operations Console, LAN or direct connect, disconnect from your server and close Operations Console. Restart Operations Console and reconnect by using the user ID of 11111111 and password of 11111111 to sign on to your server.

## Task 2—Powering Down the System

**Attention:** If you are loading the Licensed Internal Code in a secondary partition, you do **not** need to power down the system.

If your system is already powered off or if you are recovering to a system at an IBM Business Recovery Services Center, skip this task and begin with “Task 3a—Preparing the System to Perform an IPL from an Alternate Device” on page 114. It is not necessary to power down a system that has no activity on the system.

1. Sign on the system as QSECOFR.
2. Change the QSYSOPR message queue:  

```
CHGMSGQ MSGQ(QSYSOPR) DLVRY(*BREAK)
SEV(60)
```
3. Bring your system to a restricted state:  

```
ENDSBS SBS(*ALL) OPTION(*CNTRLD)
DELAY(600)
```

**Note:** Specify a number of seconds for the delay parameter that is long enough for your system to bring most jobs to a normal end. On a large, busy system, you may need more time.

The system displays a message that subsystem ending is in progress. The system displays another message when all subsystems have ended and the system is in a restricted state. After the subsystems have ended, continue with the next step.

4. Power down the system:  

```
PWRDWSYS OPTION(*IMMED)
```

**Attention Logical Partitioning users!**

Before issuing this command, be certain that all secondary partitions have been powered off.

**Note:** This does not apply to HMC controlled systems.

**Note:** When the Power On light goes off or the partition on the HMC indicated **Not Activated**, continue with the next task.

## Task 3a—Preparing the System to Perform an IPL from an Alternate Device

To perform an initial program load (IPL) from tape, optical media, or CD-ROM, you must use the control panel on the system unit. The steps vary slightly based on the type of system unit that you have. Click on **Basic system operations** under the **Systems management** topic in the iSeries Information Center if you are unsure of the procedures for your system. You can find the Information Center at the following Web site:

<http://www.ibm.com/eserver/iseries/infocenter/>

**Note:** This task only applies to the primary partition. If you are installing to a secondary partition, use the **Work with system partitions** option in SST or DST on the primary partition. See the Information Center for more information about logical partitions.

Do the following:

1. If your system unit has a lock on the control panel, use the key or keystick to unlock the control panel.
2. Place the system in Manual mode.
3. Press the Function Select switch (or buttons) to display 02 (IPL) in the Function display.
4. Press the Enter button on the control panel.
5. Press the Function Select switch (or buttons) to display D (IPL from tape, optical media, or CD-ROM) in the Data display.
6. Press the Enter button on the control panel.
7. Ensure that any switches for the alternate IPL device and for all disk units are in the On position.

## Task 3b—Preparing a Logical Partition to Perform an IPL from an Alternate Device

To perform an IPL from tape, optical media, or CD-ROM, you must use the Work with Partition Status display from the primary partition. Perform the following steps on the primary partition:

1. Type STRSST on a command line, and press Enter.
2. On the System Service Tools (SST) display, select option 5 to work with system partitions, and press Enter.
3. On the Work with System Partitions display, select option 2 to work with system partition status, and press Enter.
4. On the Work with System Partition Status display, select manual mode by typing a 10 in the option field next to the partition that you are performing the alternate IPL on. Press Enter.
5. Select source D by typing a D in the option field next to the partition on which you are performing the alternate IPL. Press Enter.

- | If you are using logical partitions with an HMC, perform these steps on the console of the logical
- | partition on which you want to perform an IPL:

- | 1. Expand your **Management Environment** in your HMC.
- | 2. Expand your Server.
- | 3. Expand **Server and Partition**.
- | 4. Click on **Server Management**.
- | 5. Expand **Partitions**.
- | 6. Select the partition.
- | 7. Right click on the partition and select **Properties**.
- | 8. In the Partition Properties window, click the **Settings** tab.
- | 9. Under the Boot category change the **Keylock position** to Manual and the IPL source to D.
- | 10. Click on the **OK** button.
- | 11. Expand the partition.
- | 12. Right click on the partition profile and select **Properties**.
- | 13. Select the Tagged I/O tab.
- | 14. Under the Alternate Restart Device category press **Select**.
- | 15. Expand the Unit.
- | 16. Expand the bus.
- | 17. Select the slot with your I/O processor.
- | 18. Press **Select**.
- | 19. Press **OK**.
- | 20. Right click on the partition and select **Activate** if your system is powered off. Select Shut down Partition if your system is running, the select Activate.

## Task 4–Loading the Licensed Internal Code from Media

**Note:** If you are working in a secondary partition, keep the following considerations in mind for this task:

- You may skip step 3 below (turn on system power), since you have not powered off.
  - In step 4, you are using the virtual control panel instead of the system unit control panel.
  - Instructions dealing with alternate installation do not apply to secondary partitions. (You can install from any tape device or optical device in the partition.)
1. Find the Licensed Internal Code tape or optical media. It is the first volume of the most current set of SAVSYS media or the first volume of the distribution optical media.

### Attention!

- **DO NOT** use save media that was created through DST by using option 5=Save Licensed Internal Code from the IPL or Install the System menu unless you have been instructed to do so by Software Services. The save media that you create through this process does not contain the Licensed Internal Code PTF Inventory information or the i5/OS Operating System. If you perform the recovery process using this save media, you will have to re-install the Licensed Internal Code from either a SAVSYS media or from your distribution media before you can load any PTFs onto the system.
- Use the distribution media only if no SAVSYS media volume exists. If you use the distribution media, some system information will be lost. This includes, but is not limited to, PTFs and PTF packages. If you use the distribution media, you must reinstall all cumulative PTF packages and individual PTFs applied after the initial installation of your system.

2. Place the media volume in the device that you use for the IPL, or place the optical media in the optical disk unit. When you start the IPL, the system searches the alternate IPL devices for the correct media. For more information on loading the tape or optical media, see the setup manual for the device.

**Notes:**

- a. If you cannot load your alternate IPL device when the power is off, continue with the next step. The system prompts you later with an SRC code for the tape device or optical device.
  - b. If you use a tape device that you enabled as an alternate installation device, you must load **both** the Licensed Internal Code CD-ROM and your tape media. (An alternate installation device is an alternate IPL device that is connected to a bus other than the system bus (bus 1).) Refer to Chapter 17, "Using an Alternate Installation Device," on page 347 for more information.
3. Turn on the power to the system.

**Using Logical Partitions?**

On the primary partition, go to the Work with System Partition Status display. Turn the power on by typing a 1 in the option field next to the partition on which you are performing the alternate IPL .

4. If you could not load your media volume in step 2, load the first media volume into the device that you use for IPL. Make the device ready and then continue with the next step.

**Note:** If you did not power down your system after ending the subsystems, do the following:

- a. Press the Function Select switch (or buttons) to display 03 (continue the IPL) in the Function display on the control panel.
- b. Press the Enter button on the control panel.

### Using Logical Partitions?

If you are performing an alternate IPL for a logical partition, perform the following steps:

- 1) On the primary partition, go to the Work with System Partition Status display. Select IPL restart by typing a 3 in the option field next to the partition on which you are performing the alternate IPL .
- 2) Press Enter.
- 3) You will be shown the Confirm Alternate IPL display. The system denotes the selected alternate IPL device with a percent (%) sign. If this is the correct alternate IPL device, press Enter to continue with the IPL and continue with step 5.  
If there is no alternate IPL device defined, or if you want to select a different alternate IPL device, press F11 (Select alternate IPL resource). On the Select Alternate IPL Resource display, type a 1 in the option field next to the Storage IOP of the device that you want to select. Press the Enter key. You will be shown the Confirm Alternate IPL Resource display. Press Enter to confirm your choice. Press F12 to return to the Confirm Alternate IPL display. Press Enter to continue with the IPL.

To perform an alternate IPL for a logical partition using the HMC, perform these steps:

- 1) Expand your **Management Environment** in your HMC.
- 2) Expand your Server.
- 3) Expand **Server and Partition**.
- 4) Click on **Server Management**.
- 5) Expand **Partitions**.
- 6) Select the partition.
- 7) Right click on the partition and select **Properties**.
- 8) In the Partition Properties window, click the **Settings** tab.
- 9) Under the Boot category change the **Keylock position** to Manual and the **IPL source** to D.
- 10) Click on the **OK** button.
- 11) Expand the partition.
- 12) Right click on the partition profile and select **Properties**.
- 13) Select the **Tagged I/O** tab.
- 14) Under the Alternate restart device category press **Select**.
- 15) Expand the Unit.
- 16) Expand the Bus.
- 17) Select the Slot with your I/O processor.
- 18) Press **Select**.
- 19) Press **OK**.
- 20) Right click on the partition and select **Activate** if your system is powered off. Select **Shut Down Partition** if your system is running, then select **Activate**.

5. Ensure that the tape device or optical device is online or ready. No action is required for devices that perform this step automatically (such as the tape cartridge unit).
6. Ensure that the console display is turned on. After a delay, you should see the Install Licensed Internal Code menu. The length of the delay varies, depending on your system configuration and

the speed of your alternate IPL device. The delay is usually between 5 minutes and 30 minutes. When you see this menu, continue with step 7.

If the system attention light appears and one of the SRC codes that are shown in Table 36 is displayed in the Data display, complete the instructions for that SRC code.

**Note:** If you are using logical partitions, the SRC codes will be shown from the primary partition on the Work with Partition Status or the Monitor Partition Status displays or on the HMC under the operator panel value.

Table 36. SRC Codes When Loading the Licensed Internal Code

SRC Code	Why It Appears	What You Do
A1xx 1933 A12x 1933 (‘x’ is any character)	The device for the alternate IPL is not ready.	Make sure that you loaded the correct media volume. Make the device unit ready. Wait for the System Attention light to go off. Then continue with the next step. If the Sytem Attention light stays on for more than 5 minutes, check to see if you have the correct tape loaded in the device for the alternate IPL and make the device ready. Then continue with the next step.
B1xx 1803 B1xx 1806 B1xx 1938	The device for the alternate IPL was not found or was not ready.	Make sure that you powered on the device, that you loaded the correct media volume, and the media volume is ready. Then continue with the next step.
B1xx 1934	The wrong media volume is loaded. Or the high-speed feature is enabled on the 2440 Tape Unit.	Load the correct media volume and make the device ready. Then continue with the next step or disable the high-speed feature on the 2440 Tape Unit.
B608 1105	This SRC occurs when you exit from the automatic installation because an alternate installation device attached to the system is enabled but is otherwise not ready. The device may not be ready because the media volume is not loaded or the device may not be enabled as an alternate installation device. Or, there may be a problem with the device.	Power down the system. If necessary, fix the device. Power on the system. Verify that the alternate installation device is enabled. Load the media volume in the alternate installation device and start the installation procedure again.
2507 0001 2642 0001 2643 0001	A media volume is not loaded in the device for the alternate IPL.	Make sure the correct media volume is loaded in the correct device. Then continue with the next step.
2644 3136	The device is assigned to another system.	Go to the other system and vary off the device. Make sure that you loaded the correct media volume. Then continue with the next step.
Any other SRC	The system encountered a problem loading the Licensed Internal Code.	

If the System Attention light is lit and no SRC code appears on the control panel, do the following:

- a. Press the Function Select switch (or buttons) to display 03 (continue the IPL) in the Function display on the control panel.
- b. Press the Enter button on the control panel.

Then continue with the next step.

7. You are shown the Install Licensed Internal Code (LIC) display.



### Install Licensed Internal Code

Select one of the following:

1. Install Licensed Internal Code
2. Work with Dedicated Service Tools (DST)
3. Define alternate installation device

If you have an alternate installation device attached to the system, perform steps 8 through 10. If you do not have an alternate installation device attached to the system, type a 1 and press the Enter key.

#### Stop!

You are now ready to recover your Licensed Internal Code. Consult your recovery checklist before continuing. The checklist tells you the correct option to select from the Install Licensed Internal Code (LIC) display.

8. If you have an alternate installation device attached to the system, type a 3 to verify its address and determine whether it is enabled or disabled.
9. The Select Alternate Installation Device Bus display screen appears.

```

                                Select Alternate Installation Device Bus
                                System: YOURSYS
Type Option, press Enter.
1=Select

Option      Bus Number      Selected
-           2
-           3             *
-           4
-           5
-           6
-           7
-           8
-           9
-           A
-           B
-           C
-           D

                                More.....

F2=Deselect device  F3=Exit  I2=Cancel
```

The Selected column shows the bus where the alternate load source is currently defined. You can use option 1 (Select) to verify that the correct device has been selected. Select your media type and then press the Enter key. If the correct device has been selected, press F3 to exit.

You can use the F2 key to deselect the current bus and then use option 1 to select another. All buses that exist on the system are displayed.

After pressing the Enter key, there will be a brief delay (up to 10 minutes) while the bus is initialized. Following this delay, the Select Alternate Installation Device display screen appears.

Select Alternate Installation Device					System: YOURSYS
Type option, press Enter.					
1=Select 5=Details					
Option	Resource Name	Type	Model	Serial Number	Selected
-	TAP01	6380	001	00-1017187	
-	TAP08	3287	030	32-234333	
-	TAP02	6380	001	00-2017187	
-	TAP05	3287	030	72-234333	*
-	TAP09	6380	001	00-1015187	
-	TAP16	3287	030	22-234633	
F2=Deselect device F3=Exit F5=Refresh F12=Cancel					

Type a 1 in the Option field to select the device you wish to use, and press the Enter key.

**Note:** When installing from an alternate installation device, be sure that only one device contains valid install media. This will prevent the wrong version of the Licensed Internal Code from being installed.

10. Press F3 to exit.
11. The Install Licensed Internal Code display appears. Type a 1 and press the Enter key.
12. Press the Enter key on the Confirm Alternate Installation Device display.

**Stop!**

You are now ready to recover your Licensed Internal Code. Consult your recovery checklist before continuing. The checklist tells you the correct option to select from the Install Licensed Internal Code (LIC) display.

## How to Load the Licensed Internal Code

**If you receive an error display screen:**

See Appendix A, "Licensed Internal Code Installation Error Displays," on page 445 for information on the possible error display screens that can be displayed during LIC installation.

If you are using an alternate installation device and you receive an error display screen, it may be due to one of the following conditions:

- You are trying to install from CD-ROM when an alternate installation device is enabled.
- You are trying to use an alternate installation device which is not enabled.

Review "Setting up an Alternate Installation Device" on page 347 and "Disabling an Alternate Installation Device" on page 350 and perform the appropriate procedure.

**Note:** You may find that the address information is not available, or that the system configuration has changed so that the address information is not correct. If this occurs, you must determine the address information by a physical inspection of your system configuration. This inspection can be difficult and may vary depending on your system model and the specific configuration of your IO buses. For this reason, IBM recommends that you call your next level of support for assistance in determining the addresses you need for the alternate installation device. A service agreement may be required for this type of assistance.

To complete the procedure for loading the Licensed Internal Code to your system during a recovery, do the following:

1. You should see the Install Licensed Internal Code (LIC) display:  
Select the correct option and press the Enter key.

```
Install Licensed Internal Code (LIC)

Disk selected to write the Licensed Internal Code to:
Serial Number   Type   Model   I/O Bus   Controller   Device
xx-xxxxxxx     xxxx   xxx     x         x           x

Select one of the following:

1. Restore Licensed Internal Code
2. Install Licensed Internal Code and Initialize system
3. Install Licensed Internal Code and Recover Configuration
4. Install Licensed Internal Code and Restore Disk Unit Data
5. Install Licensed Internal Code and Upgrade Load Source
```

**Attention!**

Be sure you consult the correct recovery checklist before selecting an option from the Install Licensed Internal Code (LIC) display. Some options remove all data from your system.

2. If there is an alternate installation device defined and enabled, the Confirm Alternate Installation Device display appears.
  - To recover from the alternate installation device, press the Enter key.
  - To recover from CD-ROM, press F12 to cancel. The Install Licensed Internal Code display appears. Select option 3 (Define alternate installation device). Perform steps 8 through 10 and disable the alternate installation device.
3. One of the following Install LIC and Initialize System–Confirmation display screens is shown if you chose option 2, 3, 4, or 5 from the LIC installation display. You must press F10 to continue the installation; pressing the enter key just re-displays the confirmation display screen.

```
Install LIC and Initialize System - Confirmation

Warning:
All data on this system will be destroyed and the Licensed
Internal Code will be written to the selected disk if you
choose to continue the initialize and install.

Return to the install selection display screen and choose one of the
other options if you want to perform some type of recovery
after the install of the Licensed Internal Code is complete.

Press F10 to continue the install.
Press F12 (Cancel) to return to the previous display screen.
Press F3 (Exit) to return to the install selection display screen.
```

Install LIC and Recover Configuration - Confirmation

Warning:

All data on the selected disk will be destroyed and the Licensed Internal Code will be written to this disk if you choose to continue the install. When the install is complete, an IPL will be done and you will be prompted to continue the recovery of the DASD configuration.

Press F10 to continue the install.  
Press F12 (Cancel) to return to the previous display screen.  
Press F3 (Exit) to return to the install selection display screen.

Install LIC and Restore Disk Unit Data - Confirmation

Warning:

All data on the selected disk will be destroyed and the Licensed Internal Code will be written to this disk if you choose to continue the install. When the install is complete, an IPL will be done and you will be prompted to restore the disk unit data that you previously saved.

Press F10 to continue the install.  
Press F12 (Cancel) to return to the previous display screen.  
Press F3 (Exit) to return to the install selection display screen.

Install LIC and Upgrade Load Source - Confirmation

Warning:

All data on the selected disk will be destroyed and the Licensed Internal Code will be written to this disk if you choose to continue the install. When the install is complete, an IPL will be done and you will be prompted to complete the upgrade.

Press F10 to continue the install.  
Press F12 (Cancel) to return to the previous display screen.  
Press F3 (Exit) to return to the install selection display screen.

The Initialize the Disk-Status display screen is shown if you chose option 2, 3, 4, or 5 on the install selection menu, and then pressed F10 on the confirmation display screen. The actual time to initialize the disk can be considerably less than the estimated time, depending on the current state of the disk.

Initialize the Disk - Status

The load source disk is being initialized.

Estimated time to initialize in minutes : \_\_\_\_

Elapsed time in minutes . . . . . : \_\_\_\_.

- You are shown the Install Licensed Internal Code Installation Status display. You do not need to respond to this display. The system shows this display for approximately 30 minutes.

```

Licensed Internal Code Installation Status

Installation of the Licensed Internal Code in progress.

Percent complete  +-----+
                   |XXXXXXXXXXXXXXXXXXXXXXXXXXXXXXXXXXXX|
                   +-----+
                   0         20        40        60        100

Elapsed time in minutes . . . . . :    x.x

Please wait.

```

- If an error occurs, you may see a display that requires a response.
- You may see the *Accept Console* display screen. If it appears, press F10 to accept the current console. On the *Accept And Set New Console Type On This IPL* press Enter to continue.

**Stop!**  
 You have finished loading your Licensed Internal Code.

If you are using logical partitions, and you have installed the Licensed Internal Code to the primary partition, you will receive the following message on the Disk Configuration Error Report display:

```

Disk Configuration Error Report

Type option, press Enter
5=Display Detailed Report

OPT  Warning
___  Unit has incorrect logical partition configuration

```

This message indicates that the partitioning configuration should be recovered. Perform the steps that are listed below in *How to Recover Your Logical Partition Configuration*.

**Note:** There may be multiple logical partition configuration error messages for different disk units. The steps that are listed will resolve all of these messages.

## How to Recover Your Logical Partition Configuration

If you are using logical partitions, use the following steps to recover the primary partition.

- Select the Use Dedicated Service Tools option.
- Sign on to Dedicated Service Tools. The system displays the Use Dedicated Service Tools menu.
- From the Use Dedicated Service Tools (DST) menu, select option 11, Work with system partitions.

### Use Dedicated Service Tools

Select one of the following:

1. Perform an IPL
2. Install the operating system
3. Work with licensed internal code
4. Work with disk units
5. Work with DST environment
6. Select DST console model
7. Start a service tool
8. Perform automatic installation of the operating system
9. Work with save storage and restore storage
10. Work with remote DST support
11. Work with system partitions

You are shown the Work with System Partitions display.

4. From the Work with System Partitions display, select option 4, Recover configuration data.
5. Choose option 1, Recover primary partition configuration data.
6. The system will look through all non-configured disk units for partition configuration data. The disk unit with the newest configuration data for the current system will be listed.

### Select Disk Unit for Configuration Data Recovery

System: xxxxxxxx

Type option, press Enter:

1=Select

Opt	I/O Resource Description	Type-Model	--Last Updated-- Date Time		System Serial Number
-	_____	___-___	_____	_____	_____

7. Review the information for the displayed disk unit. Ensure that the Last Updated and System Serial Number fields contain reasonable information. Type a 1 to select the disk, and press the Enter key.
8. Press Enter to accept the recovery.

The system automatically copies the configuration data to the primary partition's load source, and performs an IPL to DST.

If you are restoring one partition with a previously mirrored load source, you may continue to receive an error message after the IPL to DST. The message text is "Unit has incorrect logical partition configuration".

If you do not receive this message, stop here. You have completed logical partition configuration. Consult your recovery checklist to determine the next step in your recovery process.

If you receive this message, you must clear this obsolete configuration by performing the following steps:

1. After receiving the error message, use option 5 to determine which disk unit has the obsolete partition configuration.
2. Exit the configuration error by pressing F3 to go to the DST menu.
3. From the Use Dedicated Service Tools menu, select option 11, Work with system partitions.
4. Select option 4 (Recover configuration data).
5. Select option 3 (Clear non-configured disk unit configuration data).
6. Select the disk unit that was originally reported for the partition configuration error.
7. Press F3 to return to the DST menu.
8. Select option 7, Start a service tool.
9. At the Start a Service Tool display, select option 7, Operator panel functions.
10. At the Operator Panel Functions display, press F8 to restart.

**Stop!**

You have completed logical partition configuration. Select from the following options:

- If you are loading the Licensed Internal Code as part of the steps of Chapter 13, “How to Restore the System from the Save Storage Media,” on page 289 you will see the Disk Configuration Attention Report displayed. Select F3=Exit to Dedicated Service Tools (DST). Return to Chapter 13 and continue the Restore Storage procedures.
- If you selected option 2 from the Install Licensed Internal Code display, continue with “How to Set Up Your Disk Configuration After Installing the Licensed Internal Code and Initializing the System.”
- If you selected option 3 from the Install Licensed Internal Code display, continue with “How to Recover Your Disk Configuration” on page 130.
- If you selected option 4 from the Install Licensed Internal Code display, continue with the recovery steps to restore disk unit data to the new load source disk unit.
- If you do not need to restore the operating system, continue with “How to Start Your System After Restoring Licensed Internal Code” on page 133.

## How to Set Up Your Disk Configuration After Installing the Licensed Internal Code and Initializing the System

When you install the Licensed Internal Code by using option 2 from the Install Licensed Internal Code (LIC) menu, the system does the following:

- The system clears disk unit 1. Disk unit 1 contains information about how all the other disk units on your system are configured. If you are using logical partitioning, disk unit 1 also contains your partitioning configuration data.
  - The system prepares to delete all data in the system ASP. The system ASP is not actually cleared until you perform the IPL after installing the Licensed Internal Code.
1. When you complete installing the Licensed Internal Code, you are shown the Disk Configuration Attention Report display on the A or B mode IPL:

```
                Disk Configuration Attention Report

Type option, press Enter
  5=Display Detailed Report

OPT   Warning
___   New disk configuration
```

2. If you type a 5 in the option column (OPT), you are shown the following display:

The current configuration indicates a single unit system. You can choose to accept it or do one of the following:

Following are the possible causes and recovery procedures:

- You can define a new configuration by adding units.
- Press F3 to exit to Dedicated Service Tools (DST) and if necessary, take the right option to get to 'Use Dedicated Service Tools (DST)' display.  
On the 'Use Dedicated Service Tools (DST)' display,
  - Select option 4, Work with disk units.
  - Select option 1, Work with disk configuration.
  - Select option 3, Work with ASP configuration.
  - Select option 3, Add units to ASPs.
- If you are performing 'Recover mirror load source' utility, press F3 to exit to Dedicated Service Tools (DST).  
If necessary, take the right option to get to 'Use Dedicated Service Tools (DST)' display.  
On the 'Use Dedicated Service Tools (DST)' display,
  - Select option 4, Work with disk units.
  - Select option 2, Work with disk unit recovery.
  - Select option 16, Recover mirrored load source.

Press Enter to accept the current configuration and continue.

3. Press F10 or enter to accept the new disk configuration and continue.
4. Perform the following steps:
  - a. Create all logical partitions. Refer to the iSeries Information Center at <http://www.ibm.com/eserver/iseries/infocenterfor> for information on creating logical partitions.
  - b. Initialize all of the non-load source disk units on your system.
  - c. Define which ASP each disk unit is configured in.
  - d. Determine which ASPs to start mirrored protection on.See "Configuring Disks on a New System—Checklist 1" on page 355 for a checklist on adding disk units to the system ASP, adding disk units to the user ASPs, starting mirrored protection on ASPs, and starting device parity protection. When you have completed the checklist press F12 to cancel the DST menu. You are shown the IPL or Install the System menu.

**Stop!**

You have now completed your disk configuration. Continue with the next step on your recovery checklist, which is restoring the operating system.

---

## How to Recover Your Disk Configuration Using iSeries Navigator at DST

When you install the Licensed Internal Code by using option 2 from the Install Licensed Internal Code (LIC) menu, the system does the following:

- The system clears disk unit 1. Disk unit 1 contains information about how all the other disk units on your system are configured. If you are using logical partitioning, disk unit 1 also contains your partitioning configuration data.
- The system prepares to delete all data in the system ASP. The system ASP is not actually cleared until you perform the IPL after installing the Licensed Internal Code.



These steps allow you to use the dedicated service tools (DST) debug mode to access disk management functions in iSeries Navigator where you can configure disk units in system, basic, and independent auxiliary storage pools (ASPs) while your server is still in DST mode. When you are finished configuring disk units you can complete the step-mode IPL.

**Note:** You must have configured the Service Tools Network Interface in order to do these steps.

1. You may have received a Disk Configuration Attention Report like the one below after you loaded the Licensed Internal Code. If so, press F10 to accept the problems and continue.

```

                                DISK CONFIGURATION ATTENTION REPORT

TYPE OPTION, PRESS ENTER.
  5=DISPLAY DETAILED REPORT

PRESS F10 TO ACCEPT ALL THE FOLLOWING PROBLEMS AND CONTINUE.
THE SYSTEM WILL ATTEMPT TO CORRECT THEM.

OPT  PROBLEM
     NEW DISK CONFIGURATION
  
```

2. From the IPL or Install the System menu, select option 3 (Use Dedicated Service Tools (DST)).

```

                                IPL or Install the System

Select one of the following:
  1. Perform an IPL
  2. Install the operating system
  3. Use Dedicated Service Tools (DST)
  4. Perform automatic installation of the operating system
  5. Save Licensed Internal Code
  
```

3. On the Dedicated Service Tools (DST) Sign On display, sign on with the QSECOFR service tools ID and the password for the QSECOFR service tools user ID.

```

                                Dedicated Service Tools (DST) Sign On

Type choices, press Enter.

Service tools user . . . . . QSECOFR
Service tools password . . . . . _
  
```

4. Change the password for the QSECOFR user profile on the resulting display screen, as the password is expired after the first use.

```

                                Change Service Tools User Password

Service tools user profile name . . . . . : QSECOFR
Password last changed . . . . . : 02/05/01

Type choices, press Enter.
Current password . . . . . _

New password . . . . .

New password (to verify) . . . . .
  
```

5. On the Use Dedicated Service Tools (DST) menu, select option 6, Select DST console mode.

Use Dedicated Service Tools (DST)

Select one of the following:

1. Perform an IPL
2. Install the operating system
3. Work with Licensed Internal Code
4. Work with disk units
5. Work with DST environment
6. Select DST console mode
7. Start a service tool
8. Perform automatic installation of the operating system
9. Work with save storage and restore storage
10. Work with remote service support

6. On the Select DST Console Mode display, select option 2 (Start DST debug mode on IPL).

Select DST Console Mode

Attention: Incorrect use of DST debug mode can cause damage to data in this system. Contact your service representative for assistance.

Select one of the following:

1. Exit Dedicated Service Tools (DST) on IPL
2. Start DST debug mode on IPL

7. On the IPL or Install the System menu, choose option 1 (Perform an IPL).

IPL or Install the System

Select one of the following:

1. Perform an IPL
2. Install the operating system
3. Use Dedicated Service Tools (DST)
4. Perform automatic installation of the operating system
5. Save Licensed Internal Code

8. On the Add All Disk Units to the System display, select option 1 (Keep the current disk configuration).

Add All Disk Units to the System

Select one of the following:

1. Keep the current disk configuration
2. Perform disk configuration using DST
3. Add all units to the system auxiliary storage pool (ASP)
4. Add all units to the system ASP and balance data

9. On the Install Required for Operating System display, press ENTER to continue.

Install Required for Operating System

The system ASP has been cleared, which requires an install of the operating system.

To install the operating system , do the following:

- Load the install media in the device used to install the operating system and make the device ready.
- Press Enter when the device is ready to install the operating system.

-OR-

Press F11 to display the Dedicated Service Tools sign on or main menu and not install the operating system.

10. On the Select Type of IPL display, select option 2 (Step-mode IPL).

Select Type of IPL

Select one of the following:

1. Normal IPL
2. Step-mode IPL

11. Step through the IPL by pressing ENTER. The last IPL step before you configure disk units is Storage Management Recovery. Press enter on the Storage Management Recovery display screen shown below.

Licensed Internal Code IPL in Progress

```
IPL:
Type . . . . . : Attended
Start date and time . . . . . : 00/00/00 00:00:00
Previous system end . . . . . : Abnormal

IPL step . . . . . : Storage Management Recovery
```

12. **Stop** at the resulting IPL step Start LIC Log display screen.

Licensed Internal Code IPL in Progress

```
IPL:
Type . . . . . : Attended
Start date and time . . . . . : 00/00/00 00:00:00
Previous system end . . . . . : Abnormal

IPL step . . . . . : Start LIC Log
```

13. Open iSeries Navigator to begin disk unit configuration.
14. In the Environmental tasks panel, click **Open iSeries Navigator service tools window**.
15. Enter the system name or IP address on the resulting window.
16. Expand the server you want to restore.
17. Expand **Disk Units**.
18. Right-click **All Disk Units** and select **Add Disk Unit**. The wizard will guide you through the process of adding disk units to disk pools and starting disk protection. Refer to a printed copy of your disk configuration to create all the necessary disk pools.

19. When your disk unit configuration is complete, continue through the step mode IPL. Press ENTER on all of the following IPL steps through Start the Operating System.
20. After the IPL steps complete, the Install the Operating System menu appears:

```

                                Install the Operating System

Type options, press Enter.

    Install
    option . . . . . —           1=Take defaults (No other
                                options are displayed)
                                2=Change install options

Date:
Year . . . . . —             00-99
Month . . . . . —           01-12
Day . . . . . —             01-31

Time:
Hour . . . . . —            00-23
Minute . . . . . —          00-59
Second . . . . . —          00-59

```

**Stop!** You have now completed disk unit configuration. Continue with the next step on your recovery checklist, which is restoring the operating system.

## How to Recover Your Disk Configuration

When you install the Licensed Internal Code by using option 3 from the Install Licensed Internal Code (LIC) menu, the system does the following:

- Clears disk unit 1. Disk unit 1 contains information about how all the other disk units on your system are configured.
- Prepares to delete all data in the system ASP. The system ASP is not actually cleared until you perform the IPL after installing the Licensed Internal Code.

Every disk unit on your system contains information about how it is configured. Dedicated services tools (DST) provides an option to recover the disk configuration on your system by using this information. The system reads every disk, assigns it to the correct auxiliary storage pool (ASP), and rebuilds the disk configuration information on unit 1.

In many cases, you can recover your disk configuration and avoid having to reload all your user ASPs. To recover your disk configuration, do the following:

1. When you complete installing the Licensed Internal Code, you are shown the Disk Configuration Error Report display on the A or B mode IPL:

```

Disk Configuration Error Report

Type option, press Enter
5=Display Detailed Report

OPT   Error
___   Missing disk configuration

```

2. If you type a 5 in the option column (OPT), you are shown Missing Disk Configuration display: From either display, press F3 (Exit to Use Dedicated Service Tools (DST)). The Use Dedicated Service

```

Missing Disk Configuration

The system disk configuration has been lost. The IPL
cannot be continued.

The following are the recommended recovery procedures:
o If the original system has more than one disk unit
configured and you want to keep the configuration
currently on the system, use Recover configuration
under Work with Disk Units.

Press F3 to exit to Dedicated Service Tools (DST) and
if necessary, take the right option to get to the 'Use
Dedicated Service Tools' (DST) display. On the 'Use
Dedicated Service Tools' (DST) display:
- Select option 4, Work with disk units.
- Select option 2, Work with disk unit recovery.
- Select option 5, Recover configuration.
o If the original system had only one disk unit configured
or you do not want to save the data currently on the
system, re-install the Licensed Internal Code, then
re-create the configuration, restore your data.

F3=Exit to use Dedicated Service Tools (DST)  F12=Cancel

```

Tools Sign On display is shown:

```

Dedicated Service Tools (DST) Sign On

Type choice, press Enter.

Service tools user . . . . .
Service tools password . . . . .

```

3. Sign on to Dedicated Service Tools. The system displays the Use Dedicated Service Tools menu. If you are using logical partitions, and you wish to recover the primary partition, continue with the following steps. If you are not using logical partitions, continue with step 4.
4. From the Use Dedicated Service Tools (DST) menu, select option 4 (Work with disk units).
5. From the Work with Disk Units menu, select option 2 (Work with disk unit recovery).
6. From the Work with Disk Unit Recovery menu, select option 5 (Recover disk configuration).

### Problem Report

Note: Some action for the problems listed below may need to be taken. Please select a problem to display more detailed information about the problem and to see what possible action may be taken to correct the problem.

Type option, press Enter.

5 = Display Detailed Report

OPT Problem  
\_ Load Source has been re-built  
\_ ASPs will be cleared

Press F10 to ignore problems and continue.

### Confirm Recover Configuration

ATTENTION: There are problems in the system that could cause some of the system data to be destroyed.

Press F11 to display the problems.

Press F10 to confirm your choice to recover configuration.

Press F12 to return to change your choice.

Possible configuration found in the system records:

ASP	Unit	Serial Number	Type	Model	Resource Name	Status
—	—	—	—	—	—	—
—	—	—	—	—	—	—
—	—	—	—	—	—	—
—	—	—	—	—	—	—
—	—	—	—	—	—	—
—	—	—	—	—	—	—

More...

F10=Confirm recover      F12=Cancel

7. Check the configuration of disk units on the display. The display shows the disk units that are assigned to each user ASP and to the system ASP (ASP 1). The warning on the display means that the system will clear all data on disk units in the system ASP.

If this configuration is *not* correct, contact a service representative or software support for assistance. Do not proceed further without getting help.

If the configuration that is shown *is* correct, press F10 to confirm the configuration. The system builds the configuration information and returns to the DST menu.

8. Press F12 to cancel the DST menu. You are shown the IPL or Install the System menu.

### Stop!

You have now completed disk configuration. Continue with the next step on your recovery checklist, which is restoring the operating system.

## How to Start Your System After Restoring Licensed Internal Code

Perform this procedure if you do not need to restore the operating system. After you complete loading the Licensed Internal Code, you should see the IPL or Install the System display:

### IPL or Install the System

Select one of the following:

1. Perform an IPL
2. Install the operating system
3. Use Dedicated Service Tools (DST)
4. Perform automatic installation of the operating system
5. Save Licensed Internal Code

Do the following:

1. Select option 1 (Perform an IPL) on the IPL or Install the System menu. When the IPL completes, the Sign On display is shown.
2. If your operator panel has a keylock switch, turn the key in the keylock switch to the normal position.
3. Sign on the system as QSECOFR.
4. If the Select Product to Work with PTFs display appears, press F3 (Exit) to continue the IPL.
5. Press the Enter key in response to any messages that are displayed.
6. When you are shown the IPL options display, type your choices and press the Enter key.

### IPL Options

Type choices, press Enter.

```
System date . . . . . 08 / 01 / 04
System time . . . . . 12 : 00 : 00
System time zone . . . . . Q0000UTC
Clear job queues . . . . . N
Clear output queues . . . . . N
Clear incomplete job logs . . . . . N
Start print writers . . . . . Y
Start system to restricted state . . . . . N

Set major system options . . . . . Y
Define or change system at IPL . . . . . N
```

### Stop!

You have now completed starting your system after recovering the Licensed Internal Code. Consult your recovery checklist to determine the next step in your recovery process.





---

## Chapter 5. Restoring the Operating System

This chapter describes the procedures for recovering the operating system. The procedure that is described here assumes that the Licensed Internal Code is already installed on your system. Normally, the Licensed Internal Code is installed. However, if the Licensed Internal Code is not on your system or is damaged, use the charts in Chapter 3 to determine the correct recovery procedure for your situation.

**Why You Restore the Operating System:** You might need to restore the operating system for several reasons, such as:

- You are encountering problems with the operating system, such as damaged objects.
- The software support center recommends it.
- You have replaced a disk unit in the system ASP.
- You are updating your system to a new release. See *Install, upgrade, or delete i5/OS and related software* for procedures to install a new release of the iSeries server. This document is available in the iSeries Information Center at <http://www.ibm.com/eserver/series/infocenter>.

**Find These Things Before You Begin:**

- Your most recent SAVSYS media. One of the following creates a SAVSYS media volume:
  - Running the Save System (SAVSYS) command.
  - Using option 21 from the Save menu.
  - Using option 22 from the Save menu.
  - Use of option 11 from the Run Backup menu.

**Attention!**

**DO NOT** use a media volume that you created through DST by using option 5=Save Licensed Internal Code from the IPL or Install the System menu unless Software Services instructs you to do so. This process creates a media volume that does not contain the Licensed Internal Code PTF Inventory information or the i5/OS Operating System. If you perform the recovery process using this media volume, you will have to re-install the Licensed Internal Code from either a SAVSYS media volume or from your distribution media before you can load any PTFs onto your system.

- If you do not have current SAVSYS media or they are damaged, you need the following:
  - The distribution media that is supplied by IBM
  - All the media for program temporary fixes (PTFs) that you have applied.

**Attention!**

Use the distribution media only if you do not have SAVSYS media. If you use the distribution media to restore the operating system, the version you restore will not have any of the PTFs that you have applied. In addition, the restore sets the following default values that ship with the i5/OS licensed program:

- System information
- Network attributes
- Configuration lists
- Edit descriptions
- Reply list entries
- IBM-supplied subsystem descriptions
- Passwords for IBM-supplied profiles

- The list of all the PTFs applied to your system at the time you saved the entire system. You should attach this list to your backup log or keep it with your SAVSYS media.
- The key or keystick for the system.
- The DST password for the QSECOFR service tools user ID.
- The QSECOFR password that is associated with the SAVSYS media that you are using.

***Do These Things Before You Begin:***

- Clean the read and write heads of the tape unit if you are using a tape unit.
- If your source system (the system that was saved and needs recovery) is operational, print a list of all the PTFs currently on the system, unless you printed the list before restoring the Licensed Internal Code. Type the following and press the Enter key:

```
DSPPTF LICPGM(*ALL) OUTPUT(*PRINT)
```

---

## Choosing the Right Procedure for Restoring the Operating System

You can restore the operating system in several different ways. At several points during the restore process, you need to make decisions based on which of these operations you are using:

**Complete Restore**

Use a complete restore operation if the operating system is not on your system or if it has damaged objects. This restores all the IBM-supplied objects in the QSYS library and the language libraries from media.

**Abbreviated Install**

Use an abbreviated install operation to replace parts of the operating system or system information, such as system values or the system reply list.

Use the recovery checklist that you selected in Chapter 3 to determine the correct procedure for your situation. You also need to know whether you are restoring from SAVSYS media or the IBM-supplied distribution media. Use the distribution media only if you do not have usable SAVSYS media.

***How to Begin Restoring the Operating System:*** The steps you have already performed determine where you start:

- If you have just restored or installed the Licensed Internal Code, you are doing a complete restore operation of the i5/OS program. You should see the IPL or Install the System display. Start with the steps described in “How to Restore the operating system” on page 137.
- If restoring the operating system is the first step or only step in your recovery process, start by performing a manual IPL. The following section describes how to do this.

---

## How to Load the Operating System Using a Manual IPL

Follow these steps to begin loading the operating system. Use these steps only if you have not just restored the Licensed Internal Code, as described in Chapter 4.

To perform a manual IPL, do the following:

1. Ensure that the tape unit, optical drive, or the CD-ROM unit is ready. For more information on loading the tape or optical media see the setup manual for the device.
2. Load the first media volume from your most recent SAVSYS media in the appropriate device. If you do not have SAVSYS media or they are unusable, load the first CD from the distribution media. Use the distribution media only if no SAVSYS media exists.

**Attention!**

**DO NOT** use media that was created through DST by using option 5=Save Licensed Internal Code from the IPL or Install the System menu unless you have been instructed to do so by Software Services. Media created through this process does not contain the Licensed Internal Code PTF Inventory information or the i5/OS Operating System. If you perform the recovery process using this media, you will have to re-install the Licensed Internal Code from either SAVSYS media or from your distribution media before you can load any PTFs onto the system.

3. Ensure the key or keystick is in the system unit.
4. Place the system in manual mode.
5. Ensure that all jobs are ended and all users are signed off.
6. Power down the system.

**Attention logical partitioning users!**

If you are going to use this command on the primary partition, be sure to power off all secondary partitions before running the command.

```
PWRDWSYS OPTION(*IMMED) RESTART(*YES) IPLSRC(B)
```

7. Continue with "How to Restore the operating system."

---

## How to Restore the operating system

You are ready to begin these steps when you have completed an IPL. Either you have just restored the Licensed Internal Code or you have just performed a manual IPL from your alternate IPL device.

**Note:** If you use Operations console, perform the following steps to reset your Operations console:

- \_\_\_ 1. On the *IPL or Install the System* display screen, select 3, **Use Dedicated Service Tools (DST)**. Press **Enter** to continue.
- \_\_\_ 2. Sign on to DST using a service tools user profile that has security officer authority and the assigned password.
- \_\_\_ 3. On the *Use Dedicated Service Tools (DST)* display screen, select 5, **Work with DST environment**. Press **Enter** to continue.
- \_\_\_ 4. On the *Work with DST Environment* display screen, select 2, **System Devices**. Press **Enter** to continue.
- \_\_\_ 5. On the *Work with System Devices* display screen, select 6, **Console Mode**. Press **Enter** to continue.
- \_\_\_ 6. On the *Select Console Type* display screen, select 2, **Operations Console (Direct)**, or select 3, **Operations Console (LAN)**. Press **Enter** to continue.

**Note:** If you replace the load source disk unit you may need to use the console service functions (65+21) to specify your console type, so that you can perform the restore operations. For more information refer to the Operations Console in the iSeries Information Center at <http://www.ibm.com/eserver/series/infocenter>.

7. Press **F3** or **F12** to get back to the *IPL or Install the System* display screen.

The **IPL or Install the System** display will appear.

IPL or Install the System

Select one of the following:

1. Perform an IPL
2. Install the operating system
3. Use Dedicated Service Tools (DST)
4. Perform automatic installation of the operating system
5. Save Licensed Internal Code

## Task 1—Starting to Restore the Operating System

1. Load the first media volume from your most recent SAVSYS media in the appropriate device. If you do not have SAVSYS media or they are unusable, load the first CD from the distribution media. Use the distribution media only if no SAVSYS media exists.

### Attention!

**DO NOT** use media that you created through DST by using option 5=Save Licensed Internal Code from the IPL or Install the System menu unless you have been instructed to do so by Software Services. Media created through this process does not contain the Licensed Internal Code PTF Inventory information or the i5/OS Operating System. If you perform the recovery process using this media, you will have to re-install the Licensed Internal Code from either SAVSYS media or from your distribution media before you can load any PTFs onto the system.

2. From the IPL or Install the System display, select option 2 (Install the operating system).

**Note:** Do not use option 4 (Perform automatic installation of the operating system) to restore the operating system. This option can only be used for installing the system and not for system recovery.

3. Make a selection on the Install Device Type Selection display and press Enter.

Install Device Type Selection

Select the installation device type

1. Tape
2. Optical
3. Virtual optical - preselected image catalog
4. Current alternate selected device

TAP06

4. Press the Enter key.

The **Confirm Install of the Operating System** display will appear.

Confirm Install of Operating System

Press Enter to confirm your choice to install the operating system.

Press F12 to return and cancel your choice to install the operating system.

- Press the Enter key. If you see the **Dedicated Service Tools (DST) Sign On** display, continue with step 6. If you see the Select a Language Group display, skip to step 7.
- If your system is set up to prevent unauthorized installation of the operating system, the Dedicated Service Tools (DST) Sign On display will appear.

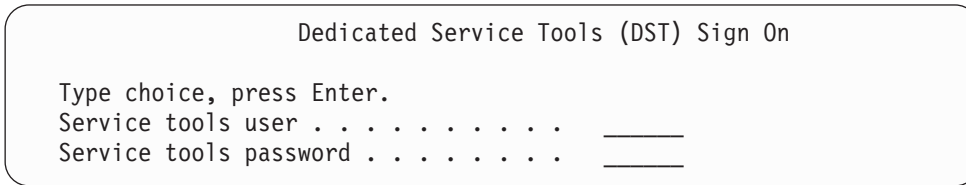

Type the DST service tools user ID and the DST service tools password and press the Enter key. You see the Select a Language Group display.

**Notes:**

- The DST service tools user ID and DST service tools password are case sensitive.
  - Sign on to DST using a service tools user profile that has security officer authority and the assigned password. The service tools user for security level DST is QSECOFR. The service tools profile QSECOFR password is expired after the first use. At the Change Service Tools User Password display screen, enter in all uppercase letters the current password QSECOFR and a new password, along with the verification password.
  - If your current DST password does not work, the password may have been reset to the shipped value. Try QSECOFR as the DST password.
  - For more information about preventing unauthorized installation of the operating system, see the *iSeries Security Reference* book.
- You are shown the **Select a Language Group** display. This display shows the primary language currently on the save media that you are restoring.

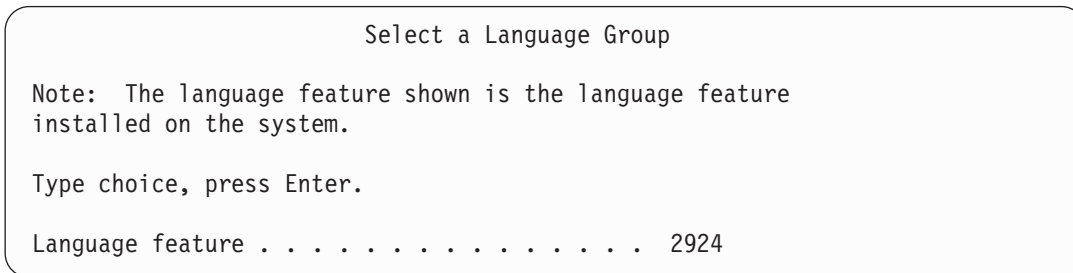

This value should match the value that is already on your system. If it does not, check to ensure that you have the correct save media. If you change the value on the display, you will be prompted to insert different media to load a different language feature. Press the Enter key. You are shown the **Confirm Language Feature Selection** display.

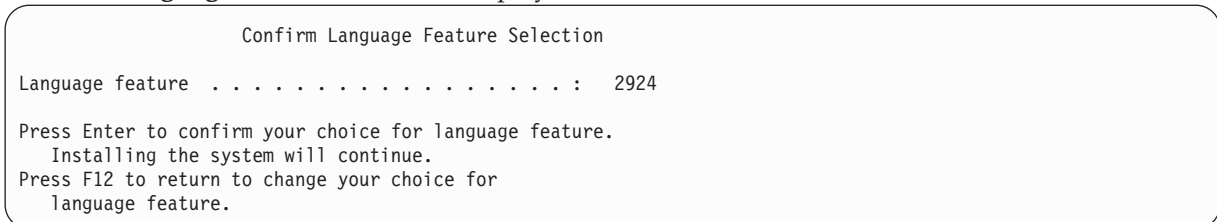

- Press the Enter key to confirm the information.

**Note:** If you have to change your system’s primary language, see the *Install, upgrade, or delete i5/OS and related software* book for more information.

If you see the Add All Disk Units to the System display, continue with step 9. If you see an IPL status message display, skip to step 10.

9. The **Add All Disk Units to the System** display is shown only if disk units are in nonconfigured status.

Add All Disk Units to the System

Select one of the following:

1. Keep the current disk configuration
2. Perform disk configuration using DST
3. Add all units to the system auxiliary storage pool (ASP)
4. Add all units to the system ASP and balance data

Disk units may be in nonconfigured status for these reasons:

- The Licensed Internal Code was installed using option 2 or option 3.
- The recover disk configuration procedure was not run.
- All disk units except unit 1 appear in non-configured status.
- You have new or spare disk units that have not yet been configured on your system.

Use the information in Table 37 to determine how to respond to this display:

*Table 37. Configuring Disk While Installing the Operating System*

Your Recovery Situation	How To Respond to the Display
Restoring your entire system to a different system or to an upgraded system.	<ul style="list-style-type: none"> <li>• If you plan to have user ASPs or mirrored protection you can select option 2 to configure your disks now. Or, you can select option 1 now and configure the disks after you have restored the operating system. Use the instructions in the section Part 6, "Disk Configuration and Protection" if you plan to configure disk protection or user ASPs.</li> <li>• If you want all disks in the system ASP and do not plan to have mirrored protection, select option 3.</li> </ul>
The Licensed Internal Code was installed on your own system using option 2 or option 3 during a recovery.	<ul style="list-style-type: none"> <li>• If you want all disks in the system ASP and do not plan to have mirrored protection, select option 3.</li> <li>• If you had user ASPs or mirrored protection on your system before the failure, you can select option 2 to reconfigure your disks. This removes any data from disks that show as not configured.</li> <li>• You can select option 1 and configure your disks later. However, the system will not be able to recover the data on the disks that are not configured.</li> </ul>

After selecting option 3, you receive an Attention Report display. Take the directed action for more detailed information, if necessary. Otherwise, press F10 to accept the problems and continue.

If you installed the Licensed Internal Code using option 2, you receive an Attention report display. Take the directed action for more detailed information, if necessary. Otherwise, press F10 to accept the problems and continue.

10. Following is an example of a status display. These status displays do not require any action by the user.

```

Licensed Internal Code IPL in Progress

IPL:
Type . . . . . : Attended
Start date and time . . . . . : xx/xx/xx xx:xx:xx
Previous system end . . . . . : Abnormal
Current step / total . . . . . : 16 16
Reference code detail . . . . . : C6004065

Ipl step                                Time Elapsed   Time Remaining
Commit Recovery                          xx:xx:xx      xx:xx:xx
Data Base Initialization                  xx:xx:xx      xx:xx:xx
Journal IPL Clean up                      xx:xx:xx      xx:xx:xx
Commit Initialization                     xx:xx:xx      xx:xx:xx
>Start the operating system                xx:xx:xx      xx:xx:xx

Item:
Current / Total . . . . . :

Sub Item:
Identifier . . . . . : Searching tape for install media
Current / Total . . . . . :

Wait for next display or press F16 for DST main menu

```

The following list shows some of the IPL steps that are shown on the Licensed Internal Code IPL in Progress display:

- Authority Recovery
- Journal Recovery
- Database Recovery
- Journal Synchronization
- Start the Operating System

Some of the IPL steps could take a long time.

While the system is performing the IPL, system reference codes (SRCs) are displayed on the control panel of the system unit to indicate what step is in progress. The *iSeries Service Functions* book describes these SRCs. If the same SRC is displayed for a long time in solid (not flickering) lights, your system may have a problem completing the IPL. Look up the SRC in the *iSeries Licensed Internal Code Diagnostic Aids - Volume 1* book or contact software support.

The system may prompt you for additional volumes of your SAVSYS media or the distribution media. Follow the instructions on the display.

After the IPL steps complete, the **Install the Operating System** menu appears.

```

Install the Operating System

Type options, press Enter.

Install
option . . . . . _          1=Take defaults (No other
                             options are displayed)
                             2=Change install options

Date:
Year . . . . . _          00-99
Month . . . . . _        01-12
Day . . . . . _         01-31

Time:
Hour . . . . . _        00-23
Minute . . . . . _     00-59
Second . . . . . _     00-59

```

11. Continue with Task 2.

## Task 2—Selecting the Installation Options

1. Type your choice for the *Install option* prompt based on the following:
  - If you are doing a *complete restore* operation, select option 1 (Take defaults). This restores the entire operating system. Use this option if any of the following is true:
    - You are recovering from a failure of the load source unit.
    - You are restoring your entire system.
    - You are upgrading to a new system.
    - You are recovering damaged objects in your operating system.

**Note:** If you are doing a complete restore operation and restoring a primary language other than English or if you have changed some of the shipped values of international system values, such as date and time (QDATFMT) or coded character set ID (QCCSID), you must select option 2 (Change install options). This ensures the language-dependent system values are restored correctly.

### Restoring to a different system?

If you are restoring to a different system (with a different serial number or different logical partition) and you want your network attributes to be restored, select option 2 (Change install options). This will allow you to select to restore your network attributes from your save media.

- If you are doing an *abbreviated install* operation, select option 2 (Change install options). This allows you to specify which parts of the operating system you want to restore. Use this option if you are recovering damaged system information, such as system values. Network attributes will not be restored.
2. If the date and time are not correct, type new values.
  3. Press the Enter key.

If you selected install option 1 (Take defaults), skip to step 14 on page 146.

If you selected install option 2 (Change install options), you are shown the **Specify Install Options display**.



### Specify Install Options

Type choices, press Enter.

```
Restore option . . . . _      1=Restore programs and language objects
                             from current media set
                             2=Do not restore programs or
                             language objects
                             3=Restore only language objects
                             from current media set
                             4=Restore only language objects
                             from a different media set using the
                             current install device

Job and output
queues option . . . . _      1=Clear, 2=Keep

Distribute i5/OS on
available disk units _      1=Yes, 2=No
```

Continue with step 4.

4. Type your choice for the *Restore option* prompt based on the following:

**Note:** If you are performing a complete system recovery, you must select option 1.

#### 1 = Restore programs and language objects

This option restores system objects from the media that you are using. Use this option if damage to a system user profile is found. If you select the option, you will be prompted to specify whether to restore system information, edit descriptions, or the system reply list.

##### Notes:

- a. If your system had access path recovery times for user ASPs and the user ASPs have not yet been reconfigured, the system cannot restore access path recovery times for the ASPs. Use the Edit Recovery Times for Access Paths (EDTRCYAP) command to set the times after you have reconfigured your ASP configuration.
- b. If you are restoring a primary language other than English, you must select option 1.

#### 2 = Do not restore programs or language objects

This option leaves the current programs and language objects on the system. Select this option to do an abbreviated install of the operating system.

When you select this option, the system does the following:

- Nothing is restored from media. Any damaged objects that the system deletes and creates again are empty.
- All libraries on the system are checked for damage. Damaged libraries are deleted and then created again.
- All system libraries (including QSYS) are created if they do not exist.
- Information associated with the user profiles is created if it does not exist or is damaged.
- The system entry-point table is created again.

#### 3 = Restore only language objects from current media

This option loads only those objects that make up the national language. The search for the language files begins on the current media. Select this option only if you need to change your primary language because you are recovering using the distribution media.

#### 4 = Restore only language objects from a different media

This option loads only those objects that make up the national language. The system prompts you to insert the language media. Select this option only if you need to change your primary language because you are recovering using the distribution media.

**Note:** Consult the *Install, upgrade, or delete i5/OS and related software* book if you want to change the primary language. You should avoid changing the primary language during a recovery.

5. Type your choice for the *Clear Job and Output Queues* prompt based on the following:

**1 = Clear**

If you do not want to keep any spooled files or entries on job queues after the installation or if you know they are damaged, select this option. The system removes all jobs on job queues and spooled files. It re-creates any internal objects associated with them. You should select this option if you are performing an abbreviated installation of the operating system. This option also resets the counter for assigning unique job numbers.

**2 = Keep**

Any entries on job queues and output queues remain after the installation. This is the normal option for this prompt.

6. Type your choice for the *Distribute operating system on available disk units* prompt based on the following:

**1 = Yes**

This option will take more time. You should only use this option in specific recovery situations as directed by your service representative. This option specifies to distribute operating system objects on available disk units in the system ASP during the installation process.

**2 = No**

Specifies to not distribute operating system objects on available disk units. This option will restore operating system objects from the media over the existing objects on the system.

7. Type your choices on the **Specify Restore Options** display and press the Enter key.

If you did not specify 1 for the *Restore option* prompt, skip to step 14 on page 146.

If you specified 1 for the *Restore option* prompt, you are shown the Specify Restore Options display.

Specify Restore Options

Type choices, press Enter.

Restore from the installation media:

System information. . . _	1=Restore, 2=Do not restore
Edit descriptions. . . _	1=Restore, 2=Do not restore
Message reply list. . . _	1=Restore, 2=Do not restore
Job descriptions. . . _	1=Restore, 3=Keep customization
Subsystem descriptions. _	1=Restore, 3=Keep customization

Continue with step 8.

8. Type your choice for the *System information* prompt based on the following:

**Note:** If you are performing a complete system recovery to a different system (with a different serial number or different logical partition), and you want to restore the network attributes from the save media, you must select option 1 (Restore).

**1 = Restore**

The system restores the system values and system management objects, such as access path recovery times, from media. Select this option if any of the following is true:

- You received a message during a previous IPL stating that the system value object was created again.
- You want to restore them to their values from your last save operation.

- You restored the operating system using option 2 or option 3 from the Install Licensed Internal Code (LIC) display.
- You are restoring a primary language other than English, or if you changed the shipped value of the QDATFMT system value.
- Your server is in a distributed relational database with unlike systems and the coded character set ID (QCCSID) system value is different than the shipped value.

If you have changed your primary language since your last save operation, the system may change some language-dependent system values during the restore operation.

**2 = Do not restore**

The system values and system management objects that are currently on the system are not changed.

A system value object must always be present on an operational system. If the system value object does not exist, the system restores it, even if you select option 2.

**Note:** For more information about system values, see the System Values topic in the iSeries Information Center (<http://www.ibm.com/eserver/series/infocenter>). For more information about access path recovery times, see the Journal Management topic in the iSeries Information Center (<http://www.ibm.com/eserver/series/infocenter>).

9. Type your choice for the *Edit descriptions* prompt based on the following:

**1 = Restore**

The system restores the edit descriptions from media. Select this option if:

- The edit descriptions are damaged.
- You want to restore them to their values from your last save operation.
- You installed the Licensed Internal Code by using option 2 or option 3 from the Install Licensed Internal Code (LIC) display.

**2 = Do not restore**

The edit descriptions currently on the system are not changed.

10. Type your choice for the *Message Reply List* prompt based on the following:

**1 = Restore**

The system restores the reply list from media. Select this option if:

- The message reply list is damaged.
- You want to restore it to its values from your last save operation.
- You installed the Licensed Internal Code by using option 2 or option 3 from the Install Licensed Internal Code (LIC) display.

**2 = Do not restore**

The message reply list currently on the system is not changed.

The default for these options is 2 if the operating system is loaded on the system. The default is 1 if the operating system is not already loaded.

11. Type your choice for the *Job descriptions* prompt based on the following:

**1 = Restore**

The system restores the job descriptions from media.

**3 = Keep customization**

The system restores the objects from media and customizes them with the values from the same objects that are already on the system.

12. Type your choice for the *Subsystem descriptions* prompt based on the following:

**1 = Restore**

The system restores the subsystem descriptions from media.

### 3 = Keep customization

The system restores the objects from media and customizes them with the values from the same objects that are already on the system.

13. Type your choices on the display and press the Enter key.
14. The **i5/OS Installation Status** display indicates how many program or language objects have been restored. They are for your information only and require no response.

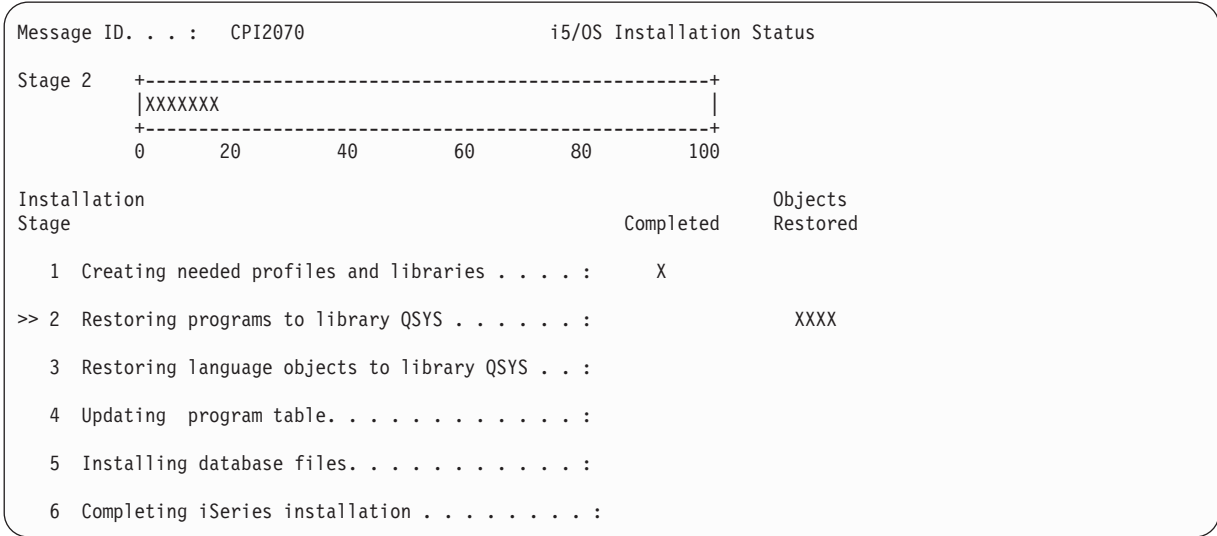

15. Continue loading media in sequence when messages are shown that ask you to load additional media. The system searches through the media and loads the necessary programs and language information. After processing all the system save media or distribution media, the system may display the following message at the bottom of a blank display:

Operating system has been installed. IPL in progress.

When the IPL is complete, the IPL Sign On display is shown and the system is ready to complete the IPL. Continue with the next task.

## Task 3—Selecting IPL Options

1. Sign on as QSECOFR. The password for QSECOFR depends on the recovery steps you have performed:
  - If you restored the operating system without first restoring the Licensed Internal Code, the QSECOFR password was not changed during the restore process.
  - If you used option 1 to restore the Licensed Internal Code before you restore the operating system, the system associates the QSECOFR password with your SAVSYS media.
  - If you used option 2 or option 3 to install the Licensed Internal Code before you restore the operating system, the system requires no password at this time. The system displays the Change Password display. The system sets the QSECOFR user profile to \*EXPIRED, and the system sets the password to QSECOFR. The system restores the system security level after you install the operating system and the IPL completes. When the IPL completes, the QSECOFR password is the password associated with the SAVSYS media you used.

**Note:** If you do not know the QSECOFR password, you can use DST to reset the password to its shipped value of QSECOFR.

```

Change Password
Password last changed . . . . . xx/xx/xx
Type choices, press Enter.
Current password . . . . . QSECOFR
New password . . . . . _____
New password (to verify) . . . _____

```

2. Press the Enter key. Informational messages are displayed.
3. If the **Select Product to Work with PTFs** display appears, press F3 (Exit) to continue.

```

Select Product to Work with PTFs
Position to . . . . . _____ Product
Type options, press Enter. Press F21 to select all.
1=Select

```

Opt	Product	Option	Release
_	5722999	*BASE	V5R3M0
_	5722SS1	*BASE	V5R3M0

4. You are shown the **IPL Options** display.

```

IPL Options
Type choices, press Enter.
System date . . . . . 08 / 01 / 04
System time . . . . . 12 : 00 : 00
System time zone . . . . . Q0000UTC
Clear job queues . . . . . N
Clear output queues . . . . . N
Clear incomplete job logs . . . . . N
Start print writers . . . . . Y
Start system to restricted state . . . . . N
Set major system options . . . . . Y
Define or change system at IPL . . . . . Y

```

The values that appear as defaults depend on the recovery steps you have performed.

5. If the system date, time, and time zone are not correct, type the correct values. If you installed the Licensed Internal Code using option 2 or option 3, the date and time may be blank. The system date must have a year value in the range of 87 to 99, or 00 to 22.
6. Type your choice for the *Start print writers* prompt based on the following:

**N = No**

Select this value if you are going to restore user profiles, device configuration objects, user libraries, and authorities.

**Y = Yes**

Select this value if you have completed your recovery.

7. Type your choice for the *Start system to restricted state* prompt based on the following:

**Y = Yes**

Select this value if you are going to restore user profiles, device configuration objects, user libraries, and authorities. Only the console is started (varied on).

**N = No**

Select this value if you have completed your recovery. All devices are started.

8. Type Y (Yes) for the *Set major system options* prompt.

9. Type Y (Yes) at the *Define or change system at IPL* prompt.

10. Type your choices on the display and press the Enter key. Continue with the next task.

## Task 4—Setting Major System Options

1. You are shown the **Set Major System Options** display.

Set Major System Options

Type choices, press Enter.

Enable automatic configuration . . . . . Y	Y=Yes, N=No
Device configuration naming . . . . . *NORMAL	*NORMAL, *S36,
*DEVADR	
Default special environment. . . . . *NONE	*NONE, *S36

2. If you choose to enable automatic configuration, the system will create a device description for every device that is attached to your system. The device description will be named according to the value that you specify for *Device configuration naming*. You may need to change the names and descriptions of these device descriptions later.

If you choose not to enable automatic configuration, you will need to configure at least one device later in your recovery. You must configure the device after you finish restoring the operating system and before you restore any other information. You may also need to correct the device configuration for the system console and respond to SRC A900 2000 (step 10 on page 152). The instructions to recover from SRC A900 2000 are provided.

3. Type your choices and press the Enter key.

4. If you specified Y for the *Define or change system at IPL* prompt in step 4 of Task 3, continue with “Task 5—Defining or Changing the System at IPL.” If you specified N for the *Define or change system at IPL* prompt in step 4 of Task 3, skip to “Task 6—Completing the IPL” on page 150.

## Task 5—Defining or Changing the System at IPL

1. If you specified Y for *Enable automatic configuration* on the Set Major System Options display, skip to step 3 on page 149. If you specified N, continue with step 2.

2. If you have chosen not to enable automatic configuration, you must change the QIPLTYPE system value. Do the following:

- a. From the Define or Change the System at IPL menu, select option 3 (System value commands). Press the Enter key.
- b. Select option 3 (Work with system values) and press the Enter key.
- c. Type a 2 in the *Option* column next to the system value QIPLTYPE and press the Enter key.

- d. Change the value to 2 and press the Enter key.
  - e. Press F12 until you return to the Define or Change the System at IPL menu.
3. When you are system, there are some system values that must be set correctly to prevent the recovery from failing. Also, if you restore the system from distribution media, your system values will be reset to the IBM-supplied defaults.

Use whatever documentation you have to set the system values to the correct settings for your installation.

**Attention!**

If you are restoring to a system with a different processor or memory, you must ensure that the QMCHPOOL, QBASPOOL, and QPFRADJ system values are correct.

As a general rule, if the main storage size is 64M or larger, change the QMCHPOOL system value to be 15 percent of the main storage size. If the main storage size is less than 64M, change the QMCHPOOL system value to be 20 percent of the main storage size. For a more precise setting of the QMCHPOOL system value, refer to the *Work Management* book.

The QBASPOOL system value should be equal to 5 to 10 percent of the main storage size.

The QPFRADJ system value should be set to 2.

- a. From the Define or Change the System at IPL menu, select option 3 (System value commands) and press the Enter key.
- b. Select option 3 (Work with system values) and press the Enter key.

If you are restoring to the same system from your SAVSYS media, skip to 6 on page 150.

4. Update the following System Values. Write down the existing values so you can update them after the recovery, if necessary.
  - QALWOBJRST to \*ALL
  - QFRCCVNRST to 0
  - QIPLTYPE to 2
  - QINACTITV to \*NONE
  - QJOBMSGQFL to \*PRTWRAP
  - QJOBMSGQMX to minimum of 30 with a recommendation of 64
  - QLMTDEVSSN to 0
  - QLMTSECOFR to 0
  - QMAXSIGN to \*NOMAX
  - QPFRADJ to 2
  - QPWDEXPITV to \*NOMAX
  - QSCANFSCTL add \*NOPOSTRST
  - QVFYOBJRST to 1

5. If you are restoring to a different system with a different serial number or different logical partitions, and you selected install option 1 (Take defaults) on the Install the Operating System menu, the following network attributes are reset to the shipped values.

If you selected install option 2 (Change install options) on the Install the Operating System menu, and selected option 1 (Restore) at the System Information field on the Specify Restore Options display, the network attributes will be restored.

- System name
- Local network ID
- Local control point name

- Default local location name
- Default node
- Default type
- Maximum number of intermediate sessions
- Route addition resistance
- Network node servers
- Alter primary focal point
- Alert default focal point

If you are restoring from distribution media and have previously changed the network attributes from the IBM-supplied defaults, you need to reset them. Do the following:

- From the Define or Change the System at IPL menu, select option 4 (Network attributes commands) and press the Enter key.
  - Select option 2 (Change network attributes). Press the Enter key to display a list of network attributes.
  - Change the values to the correct network attributes and press the Enter key.
  - Press F12 (Cancel) to return to the Define or Change the System at IPL menu.
- If you are partially restoring (only some libraries), continue with step 7. Otherwise, skip to step 8.
  - If you are partially restoring and do not plan to restore certain libraries that are listed in the QSYSLIBL and QUSRLIBL system values, you need to edit the QSYSLIBL and QUSRLIBL system values to remove those libraries. Do the following:
    - From the Define or Change the System at IPL menu, select option 3 (System value commands). Press the Enter key.
    - Select option 3 (Work with system values) and press the Enter key.
    - Type a 2 in the *Option* column next to the system values you want to change and press the Enter key.
    - Change the values to the correct values and press the Enter key.
    - Press F12 to return to the Define or Change the System at IPL menu.
  - Continue with "Task 6—Completing the IPL."

## Task 6—Completing the IPL

- Press F3 to continue the IPL.
- The **Edit Rebuild of Access Paths display** is shown during the IPL process (attended mode) when system access paths are marked for rebuild.  
"Task 2—Edit Rebuild of Access Paths" on page 159 describes how to interpret and update this

```

Edit Rebuild of Access Paths                                05/12/90 13:49:34

IPL threshold . . . . . 50 0-99

Type sequence, press Enter.
Sequence: 1-99, *OPN, *HLD

-----Access Paths----- Unique Rebuild
Seq  Status   File      Library  Member  Keyed  Time
25_  IPL       QAPZSYM2  QSYS    QAPZSYM2  NO    00:00:01

```

display.

A status message is sent to notify the user that the system is performing access path recovery.



- Make any changes and press the Enter key. If you have made changes, the Edit Rebuild of Access Paths display is shown again confirming your changes or showing your error messages. Repeat this step until the Display Access Path Status display is shown or the IPL continues.
- The **Display Access Path Status** display is updated every 5 seconds while the system is rebuilding access paths.

Display Access Path Status					
IPL Threshold . . . . . : 50					
Status	-----Access Paths-----			Rebuild	Current
	File	Library	Member	Build Time	Run Time
RUN	QAPZSYM2	QSYS	QAPZSYM2	00:00:01	00:00:01
JRN	QAPZREQ2	QSYS	QAPZREQ2	00:00:01	
SYS	QASULE03	QSYS	QASULE03	00:00:01	
IPL	QASULE01	QSYS	QASULE01	00:00:01	

If you want to make changes, press F12 (Cancel) to return to the Edit Rebuild of Access Paths display. If all access paths are rebuilt or you no longer want to see the display, press F3 (Exit and continue IPL).

**Note:** The rebuild of access paths requires system memory. It is recommended that you avoid a high level of system activity so that the rebuild of access paths can complete.

- The **Edit Check Pending Constraints** display is shown if referential constraints need to be verified. "Task 3–Edit Check Pending Constraints" on page 161 describes how to interpret and update this

Edit Check Pending Constraints						
Type sequence, press Enter.						
Sequence: 1-99, *HLD						
03/30/94 10:09:27						
Seq	Status	-----Constraints-----			Verify	Elapsed
		Cst	File	Library	Time	Time
75_	AFTIPL	CSTF1	FILE567890	LIB4567890	00:00:56	00:00:00

display.

- Make any changes and press the Enter key. The Edit Check Pending Constraints display is shown again confirming your changes or showing your error messages if you have made changes. Repeat this step until the Display Constraint Status display is shown or the IPL continues.
- The **Display Constraint Status** display is updated every 5 seconds while the system is verifying constraints.

Display Constraint Status					
IPL Threshold . . . . . : 50					
Status	-----Constraints-----			Verify	Elapsed
	Constraint	File	Library	Time	Time
RUN	CUST1	CUSTMAST	CUSTLIB	00:00:04	00:00:01
RUN	CUST2	CUSTMAST	CUSTLIB	00:00:05	00:00:01
IPL	ORDHST1	ORDHIST	ORDLIB	00:00:23	00:00:00

If you want to make changes, press F12 (Cancel) to return to the Edit Check Pending Constraints display. Press F3 (Exit and continue IPL) if all constraints are verified or you no longer want to see the display.

- Press the Enter key if QSYSOPR messages are displayed.

9. Press the Enter key to continue. If you restore the operating system from distribution media, you may have a problem with sending messages or creating documents if you have OfficeVision. To prevent errors, enter the following command:  
MRGMSGF Q0FC/QZ0FCMSG QSYS/Q0FCMSG
10. You may receive A900 2000 on the control panel or message CPF0975, Console did not vary on, on the console display. This occurs if your system configuration was lost and you have disabled automatic configuration. The system has created device description QCONSOLE to allow you to continue the restore operation. You may also receive SRC A900 2000 if you perform an IPL when the QIPLTYPE system value is set to 2. Do not create a user-defined device description for the console display. This can cause unpredictable results.  
If you receive this message, perform the steps that are described in “Recovering from SRC A900 2000” before continuing.
11. If you restored from the distribution media by using a 1/4-inch cartridge tape drive, the light on the tape drive may still be on. After the system has finished restoring the operating system, you may remove the tape while the light is on.

---

## Recovering from SRC A900 2000

When you restore the operating system, you may see SRC A900 2000. This happens when you use option 2 or option 3 to install the Licensed Internal Code and automatic configuration is not active while you are restoring the operating system. Before you can continue your recovery operations, you must create a device description and possibly a controller description to finish the restore operation. Do not create a user-defined device description for the console display.

## Creating a Configuration for Other Tape Units

If you are not using a 34xx tape unit, or want to create a 34xx (3490 Model E or F) tape unit without a controller, do the following:

1. Use the Work with Hardware Resource (WRKHDWRSC) command to determine tape controller name.  
WRKHDWRSC TYPE(\*STG)
2. Locate the tape controller on the Work with Hardware Resources display.
3. Type a 9 (Work with resource) next to tape controller name and press the Enter key.
4. Locate the resource name for the tape unit (for example, TAP01).
5. Enter a 5 (Work with Configuration Descriptions) in the *Opt* column next to the tape resource name and press the Enter key.  
You are shown the Work with Configuration Descriptions display.
6. Type a 1 (Create) in the *Option* field and a device description name (for example, TAP01) in the *Description* field. Press the Enter key. You are shown the Create Device Description display.
7. Change any values that you want to change, then press the Enter key (twice) to create the device description. You are shown the Work with Configuration Descriptions display again. The device that you created should appear on the display.
8. Type an 8 (Work with configuration status) in front of the new device description. You are shown the Work with Configuration Status display.
9. Type a 1 (Vary on) in front of the new device. If the status does not change to Varied On, wait a few minutes. Then press F5 (Refresh). If the status still does not change to Varied On, follow normal problem determination procedures for the device.
10. Press F3 until you return to the main menu.

SRC A900 2000 remains displayed on the control panel throughout the remaining restore operations. When the final IPL of the system is complete, SRC A900 2000 disappears. The user-defined device description for the console display will be restored when the Restore Configuration (RSTCFG) command is run later in the recovery.

**Stop!**

When the Sign On display appears, you have completed restoring the operating system. Consult your recovery checklist for the next step in your recovery process.



---

## Chapter 6. Starting the System After It Ends Abnormally

When your system stops normally, it does the following:

- Writes changed pages of information from memory to auxiliary storage.
- Closes access paths and files.
- Ends programs and jobs at the natural stopping points.

If your system stops without having time to do these things, it is called an **abnormal end**. Your system might end abnormally for the following reasons:

- A power failure.
- A disk failure, if you do not have mirrored protection or device parity protection.
- A failure in the processor.
- Failure of a critical operating system program.
- Operator action (forced power down).

---

### What Happens When Your System Stops

The following list describes circumstances that cause your system to stop unexpectedly and what happens:

- **Power failure with uninterruptible power supply:** When the system loses normal power, the uninterruptible power supply system takes over and keeps the system running. The system detects this change and sends a message to your power-monitoring program. Your program can decide whether to keep the system running until power returns or to begin an orderly shutdown.
- **Power failure with no protection:** If your system does not have an uninterruptible power supply feature and the power fails, your system stops immediately. The contents of main memory are lost. The system must reconstruct information when power returns. This can be very time-consuming. Whether the system starts automatically depends on how you have set the QPWRRSTIPL system value.
- **Disk failure with device parity protection or mirrored protection:** In many cases, the system can continue running without full disk protection until the failed unit is replaced.
- **Disk failure without disk protection:** This is like a power failure without protection. The system stops immediately. The system must reconstruct information about jobs that were running and files that were open after the disk is repaired or replaced.
- **Failure of a critical operating system program:** The system will stop immediately, just as it does if an unprotected power failure or disk failure occurs. The system attempts to copy the contents of main memory so that the problem can be analyzed. This is called a **main storage dump**. When the system stops, you will see the Main Storage Dump Manager Occurred display. See “Using the Main Storage Dump Occurred Display” on page 156 for more information about this display.

### Using the Disk Configuration Error Report Display

When your system starts, it checks to ensure that it can access all of the disk units that are configured. If it cannot access one or more disk units, you are shown the Disk Configuration Error Report display:

### Disk Configuration Error Report

Type option, press Enter.  
5=Display Detailed Report

OPT Error  
\_ Missing disk units in the configuration

Following a temporary power outage, you may see this display because power has been restored to the processor but not to the peripheral devices. Wait to respond to the display until power is restored to all the disk units. The system's ability to access all the disk units when the system is starting is important for a successful recovery. If disk units are not available, the system may not be able to recover changed pages of memory. This can lengthen the time it takes to perform the IPL.

This display screen may also be presented:

- After abnormal termination if the system is unable to activate all of the DASD on the re-IPL.
- During any system IPL that has a similar problem, even if normal system shutdown had taken the system down last.

## Using the Main Storage Dump Occurred Display

If your system encounters a serious software problem, you are shown the Main Storage Dump Occurred display:

### Main Storage Dump Occurred

S/N xxxxxxxx

The system has failed. Report the following information to your IBM service representative.

```
SRC word 1 . . . . . : A1D03000
SRC word 2 . . . . . : 69B0015F
SRC word 3 . . . . . : 0000308F
SRC word 4 . . . . . : 3FFFDE00
SRC word 5 . . . . . : 0C211008
SRC word 6 . . . . . : 00000000
SRC word 7 . . . . . : 00000000
SRC word 8 . . . . . : 00D5A400
SRC word 9 . . . . . : 00CDA400
Type/Model/Feature . . : xxxx xxxx xxxx
```

Warning: The Main Storage Dump (MSD) must be copied for service.  
Failure to copy the Main Storage Dump will limit  
the ability to diagnose the failure.

Press Enter to copy the MSD for service or view the MSD.

F3=Exit      F12=Cancel

Follow the instructions of your service provider in responding to this display. In most cases, you should make a copy of the main storage dump. Save it either to save media or to auxiliary storage (disk), to assist with diagnosing the problem.

The *iSeries Service Functions* book has more information about the Main Storage Dump Manager function.

---

## How to Restart Your System

When you have solved whatever problem caused your system to stop, you must start it again. In some cases, you start the initial program load (IPL) yourself. In other cases, such as a power loss, the system starts automatically. When you start your system again after it ends abnormally, the system tries to put things back in order. It closes files that were in use, rebuilds access paths that were open, and verifies file constraints. This process can take a long time.

If you want the system to determine when to rebuild and verify, perform a normal (automatic) IPL to restart your system. If you want to view and change the schedules for rebuilding access paths and verifying referential constraints, follow the steps in this chapter:

### Task 1—Performing an Attended IPL

Perform an attended IPL so that you have the opportunity to change rebuild options.

**Note:** Your service representative may have started the IPL already. If so, skip to the step in this task for the display that is currently shown on your system.

To perform an attended initial program load (IPL), you must use the control panel on the system unit. The steps vary slightly based on the type of system unit that you have. Click on **Basic system operations** under the **Systems management** topic in the Information Center if you are unsure of the procedures for your system. You can find the Information Center at the following Web site:

<http://www.ibm.com/eserver/iseriess/infocenter/>

Do the following:

1. If your system unit has a lock on the control panel, use the key or keystick to unlock the control panel.
2. Place the system in Manual mode.
3. Ensure that any switches for all disk units are in the On position.
4. If your system is currently running, ensure that all users are signed off and all jobs are ended.

**Attention logical partitioning users!**

If you are going to use this command on the primary partition, be sure to power off all secondary partitions before running the command.

Then type:

```
PWRDWN SYS OPTION(*CNTRLD) DELAY(600) RESTART(*YES)
```

**Note:** For the delay parameter, specify a number of seconds that allows your system time to bring most jobs to a normal end. On a large, busy system, you may need a longer delay.

5. If your system is not running, power on your system.
6. When you see the IPL or Install the System display, select option 1 (Perform an IPL). Following is an example of a status display. These status displays do not require any action by the user.

Licensed Internal Code IPL in Progress

```

IPL:
Type . . . . . : Attended
Start date and time . . . . . : xx/xx/xx xx:xx:xx
Previous system end . . . . . : Abnormal
Current step / total . . . . . : 16 16
Reference code detail . . . . . : C6004065

Ipl step                               Time Elapsed   Time Remaining
Commit Recovery                         xx:xx:xx      xx:xx:xx
Data Base Initialization                 xx:xx:xx      xx:xx:xx
Journal IPL Clean up                     xx:xx:xx      xx:xx:xx
Commit Initialization                    xx:xx:xx      xx:xx:xx
>Start the operating system               xx:xx:xx      xx:xx:xx

Item:
Current / Total . . . . . :

Sub Item:
Identifier . . . . . : Searching tape for install media
Current / Total . . . . . :

Wait for next display or press F16 for DST main menu
    
```

The following list shows some of the IPL steps that are shown on the Licensed Internal Code IPL in Progress display:

- Authority Recovery
- Journal Recovery
- Database Recovery
- Journal Synchronization
- Start the Operating System

Some of the IPL steps could take a long time.

While the system is performing the IPL, system reference codes (SRCs) are displayed on the control panel of the system unit to indicate what step is in progress. The *iSeries Service Functions* book describes these SRCs. If the same SRC is displayed for a long time in solid (not flickering) lights, your system may have a problem completing the IPL.

7. Press the Enter key. Informational messages are displayed.
8. If the Select Product to Work with PTFs display appears, press F3 (Exit) to continue.

```

                Select Product to Work with PTFs

Position to . . . . . _____ Product

Type options, press Enter. Press F21 to select all.
1=Select

      Product
Opt  Product  Option  Release
-    5722999  *BASE  V5R3M0
-    5722SS1  *BASE  V5R3M0
    
```

9. You are shown the IPL Options display:



```

                                IPL Options

Type choices, press Enter.

System date . . . . . 08 / 01 / 04
System time . . . . . 12 : 00 : 00
System time zone . . . . . QN0600UTC$
Clear job queues . . . . . N
Clear output queues . . . . . N
Clear incomplete job logs . . . . . N
Start print writers . . . . . Y
Start system to restricted state . . . . . N

Set major system options . . . . . Y
Define or change system at IPL . . . . . Y

```

The values that appear as defaults depend on the recovery steps you have performed.

10. If the system date, time, and time zone are not correct, type the correct values. If you installed the Licensed Internal Code using option 2 or option 3, the date and time may be blank. The system date must have a year value in the range of 87 to 99, or 00 to 22.
11. Specify these responses for the prompts on the display:

```

Clear job queues                N
Clear output queues            N
Clear incomplete job logs      N
Start print writers            Y
Start system to restricted state Y
Set major system options      N
Define or change system at IPL N

```

12. Enter your choices and press the Enter key.

## Task 2—Edit Rebuild of Access Paths

If access paths are marked for rebuilding, you are shown the following display:

```

                                Edit Rebuild of Access Paths
                                SYSTEMA
                                05/12/90 13:49:34

IPL threshold . . . . . 50 0-99

Type sequence, press Enter.
Sequence: 1-99, *OPN, *HLD

-----Access Paths----- Unique Rebuild
Seq  Status      File      Library   Member    Keyed    Time
25  IPL          QAPZSYM2  QSYS     QAPZSYM2  NO      00:00:01
25  IPL          QAPZREQ2  QSYS     QAPZREQ2  NO      00:00:01
25  IPL          QAPZPTF3  QSYS     QAPZPTF3  NO      00:00:01
25  IPL          QAPZPTF2  QSYS     QAPZPTF2  NO      00:00:01
25  IPL          QAPZOBJ2  QSYS     QAPZOBJ2  NO      00:00:01
*OPN OPEN          QTWALL    QSYS     QTWALL    NO      00:00:06
*OPN OPEN          QASULTEL  QSYS     QASULTEL  NO      00:00:01
*OPN OPEN          QASULE05  QSYS     QASULE05  NO      00:00:01
*OPN OPEN          QASULE03  QSYS     QASULE03  NO      00:00:01
*OPN OPEN          QASULE01  QSYS     QASULE01  NO      00:00:01
More...
F5=Refresh  F11=Display member text  F13=Change multiple  F15=Sort by
F16=Repeat position to  F17=Position to

```

**Note:** No access paths are listed if all access paths that are marked for rebuild have a status of SYS, JRN, or SMAPP.

While you are working with this display, the system is rebuilding access paths. You can use this display to:

- Change the sequence in which access paths are rebuilt.
  - Delay rebuilding some access paths until after the IPL.
1. If you do not want to make changes to this display, press the Enter key. Skip to step 5. If you want to make changes, continue with step 2.
  2. You may change the value of the IPL threshold. All access paths with a sequence (SEQ) less than or equal to the threshold are rebuilt during the IPL. Access paths with a greater sequence number are rebuilt after the IPL completes. The default threshold is 50.
  3. You may change the *sequence (SEQ)* column on the display for specific access paths. Initially, the sequence numbers are set this way:

```
25      Files with MAINT(*IMMED) and RECOV(*IPL)
75      Files with MAINT(*IMMED) and RECOV(*AFTIPL)
*OPN   Files with MAINT(*DLY)
```

Within a group (same sequence numbers), the system rebuilds access paths according to rebuild time, starting with the longest rebuild time.

Rebuild time is an estimate, based on the file size and key length. For journaled access paths (status JRN) and access paths protected by system-managed access-path protection (status SMAPP), the rebuild time shows as 0. The system uses the journal entries to recover these access paths rather than rebuilding them. The time that is required is minimal.

The estimate for rebuild time assumes that the rebuild job is not contending for resources. If an access path is rebuilt after the IPL, the rebuild will probably take longer.

4. Type your changes and press the Enter key. You are shown the Edit Rebuild of Access Paths display again. You see error messages if the system could not make some of the changes you requested. For example, you may have tried to change the sequence number for an access path that the system rebuilt while you were using the display.

If you have errors, return to step 2.

5. When you have finished the display, press the Enter key without making changes. You are shown the Display Access Path Status display:  
This display is updated every 5 seconds while the system is rebuilding access paths.

Display Access Path Status					
IPL Threshold . . . . . : 50					
Status	-----Access Paths-----			Rebuild	Current
	File	Library	Member	Build Time	Run Time
RUN	QAPZSYM2	QSYS	QAPZSYM2	00:00:01	00:00:01
JRN	QAPZREQ2	QSYS	QAPZREQ2	00:00:01	
SYS	QASULE03	QSYS	QASULE03	00:00:01	
IPL	QASULE01	QSYS	QASULE01	00:00:01	

6. If you want to make changes to the IPL threshold or the sequence for rebuilding access paths, press F12 (Cancel) to return to the Edit Rebuild of Access Paths display. Repeat steps 2 through 5.

If you do not want to make changes, you can allow the Display Access Path Status display to continue updating or you can press F3 (Exit and continue IPL). In either case, the system completes rebuilding access paths before continuing to the next step of the IPL.

## Task 3—Edit Check Pending Constraints

You can define required attributes for physical files on the system. The descriptions for these values are **referential constraints** or simply **constraints**. When you perform an IPL after the system ends abnormally or when you restore database files, the system checks the validity of file constraints. Look in the Information Center under the Database and File System topics for more information about using referential constraints.

If database constraints are marked for verification, you are shown the following display:

```

Edit Check Pending Constraints                                SYSTEMA
                                                           03/30/94 10:09:27
IPL threshold . . . . . 50_ 0-99

Type sequence, press Enter.
Sequence: 1-99, *HLD

Seq  Status      -----Constraints-----  Verify  Elapsed
      Cst      File      Library  Time    Time
75_  AFTIPL      CSTF1      FILE567890  LIB4567890  00:00:56  00:00:00
75_  AFTIPL      CSTF2      FILE567890  LIB4567890  00:00:56  00:00:00
*HLD INVAP      CSTF5      FILE567890  LIB4567890  10:30:06  00:00:00
*HLD CHKPND     CSTF6      FILE567890  LIB4567890  09:30:06  00:00:00
*HLD HELD      CSTF7      FILE567890  LIB4567890  08:30:06  00:00:00
                                           More...

```

You can use this display to do the following:

- Change the sequence in which constraints are verified.
  - Have the system verify some constraints before the IPL completes.
  - Delay verification for some constraints until you specifically request it.
1. If you do not want to make changes to this display, press the Enter key and skip to step 5. If you want to make changes, continue with step 2.
  2. You may change the value of the IPL threshold. All constraints with a sequence (SEQ) less than or equal to the threshold are verified during the IPL. Constraints with a greater sequence number are verified after the IPL completes. The default threshold is 50.
  3. You may change the *sequence* (SEQ) column on the display for specific constraints. Initially, the sequence for all constraints is set to 75.

Within a group (same sequence numbers), the system verifies constraints according to verify time, starting with the longest estimated time.

Verify that time is an estimate. The estimate assumes that the verify job is not contending for resources. If a constraint is verified after the IPL, the verify may take longer.

If you want to delay the verification of a constraint indefinitely, specify \*HLD for the sequence. You can use the Edit Check Pending Constraint (EDT CPCST) command later to set a sequence and have the system verify the constraint.

4. Type your changes and press the Enter key. You are shown the Edit Check Pending Constraint display again. You see error messages if the system could not make some of the changes you requested. For example, you may have tried to change the sequence number for a constraint that the system verified while you were using the display.
 

If you have errors, return to step 2.
5. When you have finished the display, press the Enter key without making changes. You are shown the Display Constraint Status display:

```

Display Constraint Status

IPL Threshold . . . . . : 50

-----Constraints-----
Status  Constraint  File      Library   Verify    Elapsed
        Constraint  File      Library   Time      Time
RUN     CUST1         CUSTMAST CUSTLIB   00:00:04  00:00:01
RUN     CUST2         CUSTMAST CUSTLIB   00:00:05  00:00:01
IPL     ORDHST1      ORDHIST  ORDLIB    00:00:23  00:00:00

F3=Exit and continue IPL  F12=Cancel

```

This display is updated every 5 seconds while the system is verifying constraints.

- If you want to make changes to the IPL threshold or the sequence for verifying constraints, press F12 (Cancel) to return to the Edit Check Pending Constraints display. Repeat steps 2 through 5.  
If you do not want to make changes, you can allow the Display Constraint Status display to continue updating or you can press F3 (Exit and continue IPL). In either case, the system completes verifying constraints before continuing to the next step of the IPL.
- When the IPL completes, continue with "Task 4–Recovering from Damaged Objects and Unreadable Sectors."

### Task 4–Recovering from Damaged Objects and Unreadable Sectors

If your system stops without warning or disk errors occur, some object description information may not be updated correctly. If this happens, the object is considered damaged. When you perform an IPL, the system attempts to locate damaged objects and write them to the object recovery list. It writes a message (CPI18xx) to the history (QHST) log for each damaged object that it finds. If any damaged objects are added to the object recovery list during the IPL, message CPI8197 is sent to the QSYSOPR message queue.

**Note:** Some damage, such as damage to the contents of a database file, may not be detected until the object is used. If you suspect that a large number of objects on your system have been damaged, contact your service representative for advice on how to recover.

Do the following to check and recover damaged objects:

- Display the QHST (history) log by typing DSPLOG and pressing F4 (Prompt).
- On the prompt display, fill in a starting date and time to limit the number of entries you see.
- On the display, fill in \*PRINT for the *Output* prompt and press the Enter key.
- Type: WRKSPLF. You are shown a list of spooled files for your job.
- Locate the spooled file for the DSPLOG command. Use option 3 to hold the spooled file.
- Use option 5 to display the spooled file.
- Look for entries for damaged objects that are not synchronized. You can use the Find function to search for lines that have these character strings: damage and sync. Following are some examples of messages you might see:

```

CPF3113
    Member damaged

CPF3175
    File is not synchronized

CPF3176
    Data space is partially damaged

```

**CPF3171**

Journal is damaged

**CPF3172**

Objects are not synchronized with the journal

**CPF3173**

Journal receiver is damaged

**CPF3174**

Journal receiver is partially damaged

**CPF700C**

Object of type \*object-type cannot be synchronized with journal.

**CPF81xx**

General messages about object damage

8. Write down the names and types of the objects you find. Consult Table 38 for the correct recovery procedure, based on the type of object that is damaged.

*Table 38. Recovery for Damaged Objects by Object Type*

Type of Object	Recovery Procedure
Operating system object in QSYS library	Contact software support for assistance. You may need to install the operating system again.
IBM-supplied user profile	Perform an abbreviated installation of the operating system.
Job description that is specified on the workstation entry for the console in the controlling subsystem	If no other workstation entries exist for the controlling subsystem, the system is not usable. Contact software support for assistance.
Job queue	Perform an IPL. Restore or re-create the damaged job queue. All entries are lost.
Output queue	Perform an IPL. If the output queue is the default output queue for a printer, it is re-created and its entries are rebuilt. Other output queues must be restored or re-created. Their entries are not recovered.
Damaged file whose name starts with QA0SS	Delete the file. Restore it from a backup copy. Run the RCLDLO DLO(*DOCDTL) command.
Database file	See "Recovering Damaged Database Files" on page 164
Journal	See "Recovering a Damaged Journal" on page 166.
Journal receiver	See "Recovering a Damaged Journal Receiver" on page 166.
Journalled object	See "Recovering a Journalled Object That Is Damaged or Not Synchronized" on page 167.
All others	See "Recovering Other Types of Damaged Objects" on page 167.

9. Watch for additional indications that objects have been damaged. Some indications are:
- You cannot start the system because auxiliary storage is full.
  - The system has ended abnormally several times since the last time you ran the Reclaim Storage (RCLSTG) procedure.
  - You see objects on the Work with Objects by Owner display that have no library associated with them.
  - The system status display shows an unexpectedly high percentage of auxiliary storage that is used.
  - You cannot access the data in a database file because a member is damaged. Message CPF8113 indicates this.
  - You cannot access objects because a damaged authorization list or authority holder secures them.

If you see these indications on your system, the following actions can help you identify damaged objects:

- a. Choose from the following actions to identify damaged objects in critical files where you suspect damage:

- Use the Copy File (CPYF) command
  - Use the Display Object Description (DSPOBJD) command
  - Perform a save of your critical data
- b. Choose from the following actions to identify damaged objects at the system level:
- Use the Retrieve Disk Information (RTVDSKINF) command
  - Use the Display Object Description (DSPOBJD) command and specify DSPOBJD OBJ(\*ALL) OBJTYPE(\*ALL)
  - Perform a full system save using GO SAVE option 21
  - Run the RCLSTG procedure. Running the procedure is described in “Reclaim Storage” on page 35.

If you see these indications after a disk unit was replaced and the data was restored from a partial pump, you should recover the entire ASP that contained the failed disk unit. See the appropriate checklist.

### Recovering Damaged Database Files

Performing a special IPL during which the system analyzes every disk segment for parts of database objects can recover some types of object-level damage to database files. Following are examples of object-level damage:

- Lost pointers between the index (access path) and the data.
- Unidentified objects on the object recovery list.

If you are experiencing problems with database files, you can display the Licensed Internal Code log to determine whether a special IPL may resolve the problems.

**Note:** You must have \*SERVICE special authority to perform the tasks that are described in this topic. Do the following:

1. Type STRSST and press the Enter key. You are shown the System Service Tools (SST) menu menu.
2. Select option 1 (Start a service tool). You are shown the Start a Service Tool display.
3. Select option 5 (Licensed Internal Code log). You are shown the Licensed Internal Code Log display.
4. Select option 1 (Select entries from the Licensed Internal Code log). You are shown the Specify Licensed Internal Code Log Selection Values display.

```

                Specify Licensed Internal Code Log Selection Values

Type choices, press Enter

Note ID:
  Starting . . . . . FFFFFFFF 00000000-FFFFFFF

Entry type:
  Major code . . . . . 0600      0000-FFFF
  Minor code . . . . . 145F      0000-FFFF

Starting:
  Date. . . . . 00/00/00 MM/DD/YY
  Time. . . . . 00:00:00 HH:MM:SS

Ending:
  Date. . . . . 00/00/00 MM/DD/YY
  Time. . . . . 00:00:00 HH:MM:SS

F3=Exit  F12=Cancel
```

5. Type 0600 for the *Major code* prompt.

6. Type 145F for the *Minor code* prompt.
7. For the starting date and time, enter values that approximate when you first started to have problems.
8. For the ending date and time, enter the current date and time.
9. Press the Enter key. If any errors have been recorded that may be resolved by a special IPL, you are shown a list of the entries. Otherwise, you receive a message that no log entries matched your criteria.

If you have log entries that suggest a special IPL, you need to schedule a time for this IPL. It may take many hours for the system to analyze all the disk segments. As a rough estimate, the analysis phase of the IPL will take approximately 1 second for each object on your system.

When you are ready to perform the IPL, do the following:

1. Place your system in a restricted state. See "Putting Your System in a Restricted State" on page 35.
2. Type STRSST and press the Enter key. You are shown the System Service Tools (SST) menu.
3. Select option 1 (Start a service tool). You are shown the Start a Service Tool display.
4. Select option 4 (Display/Alter/Dump). You are shown the Display/Alter/Dump Output Device display.
5. Select option 1 (Display/Alter storage). You are shown the Select Data display.
6. Select option 5 (Starting address). You are shown the Specify Starting Address display:

```

                Specify Starting Address

Output device . . . . . : Display/Alter storage

Type choice, press Enter.

Address . . . . .      000000000E 000000
```

7. Type 000000000E 000000 for the address and press the Enter key. You are shown the Display Storage display:

```

                Display Storage

Control . . . . .      nnnnn, Pnnnnn, Lcccccc, .cccccc, >
Address . . . . .      000000000E 000000

0000      20830048 00800000 00000000 0E00000000      * ..... *
0010      00010000 00000000 00000000 0000000000      * ..... *
0020      00000000 00000000 00000000 0000000000      * ..... *
```

8. On the third data line (offset 0020), type 8 in the first character. Press F11 (Alter storage) to make the change take affect.
9. Press F3 until you return to the Exit System Service Tools display.
10. Press the Enter key (continue ending SST).
11. On the command line, type
 

```
PWRDWN SYS OPTION(*IMMED) RESTART(*YES)
```

 This causes the system to begin the special IPL.

**Attention logical partitioning users!**  
 If you are going to use this command on the primary partition, be sure to power off all secondary partitions before running the command.

## Recovering a Damaged Journal

**Note:** The following steps only apply to recovering a damaged local journal.

Do the following:

1. Type WRKJRN.
2. On the prompt display, type the name of the journal. You are shown the Work with Journals display:

```
Work with Journals

Type options, press Enter.
 2=Forward recovery      3=Backout recovery    5=Display journal status
 6=Recover damaged journal 7=Recover damaged journal receivers
 9=Associate receivers with journal

Opt  Journal      Library      ASP
      JRNACC      DSTA1       Device      Text
                        JOURNAL FOR ACCOUNTS
```

3. Select option 6 (Recover damaged journal).
4. Type: WRKJRNA JRN(*library-name/journal-name*) OUTPUT(\*PRINT). You receive a listing that shows all the objects that are currently being journaled.
5. Start journaling for any physical files that should be journaled but are not on the list by using the STRJRNPF command.
6. Start journaling for any access paths that should be journaled but are not on the list by using the STRJRNAP command.
7. Start journaling for any integrated file system objects that should be journaled but are not on the list by using the STRJRN command.
8. Start journaling for any other object types that should be journaled but are not on the list by using the STRJRNOBJ command.
9. If you previously had any remote journals that were associated with the damaged journal, add those remote journals again. You can add the remote journals by using the Add Remote Journal (QjoAddRemoteJournal) API or the Add Remote Journal (ADDRMTJRN) command.
10. Save each journaled object. You should always save objects after you start journaling them.

## Recovering a Damaged Journal Receiver

**Note:** The following steps only apply to recovering a damaged journal receiver that was attached to a local journal.

Do the following:

1. Type WRKJRN.
2. On the prompt display, type the name of the journal that is associated with the damaged journal receiver. You are shown the Work with Journals display:



### Work with Journals

Type options, press Enter.

2=Forward recovery      3=Backout recovery      5=Display journal status  
6=Recover damaged journal      7=Recover damaged journal receivers  
9=Associate receivers with journal

Opt	Journal	Library	ASP Device	Text
	JRNACC	DSTA1		JOURNAL FOR ACCOUNTS

3. Select option 7 (Recover damaged journal receivers).

## Recovering a Journalled Object That Is Damaged or Not Synchronized

For a journalled object that is damaged, either selection option 2=Forward Recovery from the Work with Journals display (WRKJRN command), or perform the following steps.

1. Find your most recent saved copy of the object.
2. Delete the object.
3. Load the save media and restore the object.
  - a. For journalled database physical files, data areas, or data queues type:  
RSTOBJ OBJ(*object-name*) OBJTYPE(\**object-type*)  
SAVLIB(*library-name*)  
DEV(*media-device-name*)
  - b. For journalled integrated file system objects, type:  
RST DEV('device-path-name')  
OBJ('object-path-name')  
SUBTREE (\*ALL)
4. Restore any journal receivers that are needed to recover the object, if they are not already on the system.
5. Use the APYJRNCHG command to apply journalled changes. The Journal Management topic in the iSeries Information Center (<http://www.ibm.com/eserver/iseres/infocenter>) provides more information about applying journalled changes.

Do the following for a journalled object that could not be synchronized:

1. Restore the object from your most recent saved copy.
2. Apply journalled changes to bring the object up to date.

**Note:** You may need to perform this procedure for all the objects if there are other objects related to the object that is not synchronized. Otherwise, the objects may not be synchronized with each other.

## Recovering damaged objects in the integrated file system

To recover damaged objects in the integrated file system, run the Reclaim Storage (RCLSTG) command. For more information on the RCLSTG command, refer to “Reclaim Storage” on page 35.

- | To recover damaged objects without putting your system in a restricted state, you can use the Reclaim Object Links (RCLLNK) command. For more information on the RCLLNK command refer to “Reclaim Object Links” on page 39.

## Recovering Other Types of Damaged Objects

Use the following procedure to recover most damaged objects on the system. Table 38 on page 163 shows which types of objects require special procedures.

1. Find your most recent saved copy of the damaged object.

**Note:** If the damaged object is in the QSYS library, you may need to restore the operating system. Contact software support for assistance.

2. Delete the object.
3. Load the save media and restore the object. Type

```
RSTOBJ OBJ(object-name)  
      OBJTYPE(object-type)  
      SAVLIB(library-name)  
      DEV(media-device-name)
```

---

## Chapter 7. Recovering Information in a User Auxiliary Storage Pool

When you have user ASPs on your system, you assign specific libraries or objects to certain physical disk devices. One reason for having user ASPs is to limit the amount of information you need to recover if a DASD device must be replaced.

The basic process for recovering a user ASP is:

1. Understand what was in the user ASP.
2. Choose the correct recovery procedure.
3. Plan your recovery.
4. Perform the recovery steps.

---

### Describing the Contents of Your User Auxiliary Storage Pools

To choose the correct procedure for recovering the information on your user ASPs, you must understand what they looked like before the failure. Figure 5 shows an example of a user ASP configuration. This example is used throughout the explanations that follow. You may want to begin by drawing a similar picture of your configuration.

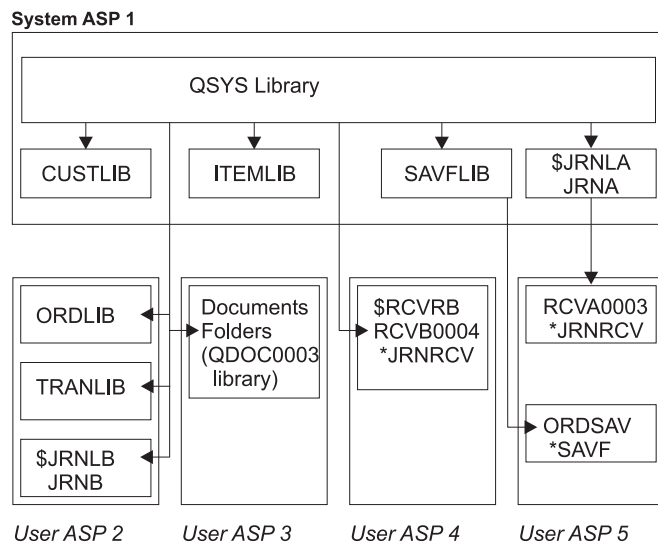

RBANS509-0

Figure 5. User ASP Configuration Before Failure

In the example:

- ASP 2 is a library user ASP. It contains these libraries: ORDLIB, TRANLIB, and \$JRNLB.
- Files in the ORDLIB library and TRANLIB library are journaled to the JRNB journal in the \$JRNLB library.
- The journal receivers for the JRNB journal are in the \$RCVRB library in ASP 4.
- ASP 3 is a library user ASP containing documents and folders.
- ASP 4 is a library user ASP. It contains the \$RCVRB library.

- ASP 5 is a nonlibrary user ASP. It contains the ORDSAV save file. ORDSAV is in the SAVFLIB library, which is in the system ASP. It also contains the RCVA0003 journal receiver, which is in the \$JRNLA library.

Before the failure, the receiver directory for the JRNA journal looks like this:

```

Work with Receiver Directory

Journal . . . . . : JRNA          Library . . . . . : $JRNLA

Total size of receivers (in kolobytes). . . . . : 155648

Type options, press Enter.
  4=Delete  8=Display attributes

Opt  Receiver  Library  Number  Attach  Status  Save
    _  RCVA0001  $JRNLA  00001  06/08/0x  SAVED  06/08/9x
    _  RCVA0002  $JRNLA  00002  06/09/0x  SAVED  06/09/9x
    _  RCVA0003  $JRNLA  00003  06/09/0x  ATTACHED  00/00/00

```

---

## Choosing the Procedure to Recover User ASPs

These basic situations may require you to recover information in a user ASP:

- You have replaced a disk unit in the system ASP. Although the data is still in your user ASPs, you must recover the system’s ability to locate that data (addressability). This process is described in “How to Recover a Basic User ASP After Recovering the System ASP.”
- You have replaced a disk unit in a basic user ASP. All the information that was in the user ASP must be recovered. If this is your situation, follow the procedure described in “How to Recover a Damaged Basic Auxiliary Storage Pool” on page 183.
- You have replaced a disk unit in the system ASP. One of your basic user ASPs was in overflowed status. You must recover the addressability to information in the user ASPs that were not overflowed by using the procedure described in “How to Recover a Basic User ASP After Recovering the System ASP.” You must also recover the information in the user ASP that was overflowed by using the procedure described in “How to Recover a Damaged Basic Auxiliary Storage Pool” on page 183.
- The service representative has replaced a failed disk unit in an independent auxiliary storage pool (ASP). When you lose a disk unit in an ASP, you must recover all of the information in that ASP. The information in other ASPs on your system is not affected. Follow the procedure described in “How to Recover an Independent ASP” on page 187.

---

## How to Recover a Basic User ASP After Recovering the System ASP

Perform this procedure after restoring your Licensed Internal Code and the operating system.

When you replace a unit in your system ASP, the system loses addressability to the objects in your basic user ASPs. The system in the example would look like this after the operating system has been restored:

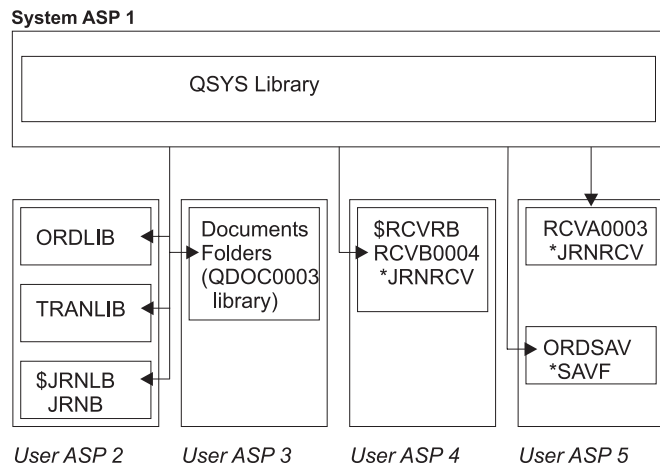

RBANS510-0

Figure 6. Basic User ASP Configuration After Restoring Operating System

The libraries and objects in the basic user ASPs are not known to the system.

You can use the procedures described in this topic to recover the objects in your basic user ASPs. However, the system cannot recover ownership to the objects other than document library objects (DLO) in the basic user ASPs because the addresses for all user profiles are changed when you restore them. All object types except DLOs use the address of the user profile to identify the owner.

Recovering object ownership for objects other than DLOs requires manually assigning ownership for every object in every basic user ASP.

## Task 1—Reclaiming Storage

1. Sign on the system with a user profile that is authorized to the RCLSTG command. Either sign on at the console or use the Transfer Job (TFRJOB) command to transfer your job to the controlling subsystem.
2. Type DSPSYSVAL QALWUSRDMN. If the current value does not include the QRCL (Reclaim Storage) library or does not specify \*ALL, use the CHGSYSVAL command to add QRCL to the list of libraries for this system value. Write the current value here: \_\_\_\_\_
3. Type DSPSYSVAL QCTLSBSD to display the name of your controlling subsystem. Write the current value here: \_\_\_\_\_
4. Ensure your system is in a restricted state. If it is not, follow the procedure in “Putting Your System in a Restricted State” on page 35.
5. Use these commands to reclaim storage in various ways:

RCLSTG	Reclaim storage of the entire system.
RCLSTG SELECT(*DBXREF)	Reclaim storage of the database cross-reference table.
RCLSTG SELECT (*DIR)	Reclaim storage of the directory recovery portion.
RCLSTG OMIT(*DBXREF)	Reclaim storage of the entire system <b>except</b> the database cross-reference table.
RCLSTG ASPDEV(*SYSBAS)	Reclaim the system ASP and all basic ASPs.
RCLSTG OMIT(*DIR)	Reclaim storage of the entire system except the directory recovery portion.

6. Use the CHGSYSVAL command to set the QALWUSRDMN system value back to its original setting. (You wrote the setting in step 2.)
7. When the reclaim storage procedure finishes, start the controlling subsystem by typing the following:  
STRSBS SBSD(*controlling-subsystem*)

(You wrote the name of the controlling subsystem in step 3.)

After the reclaim storage procedure, the example system looks like this:

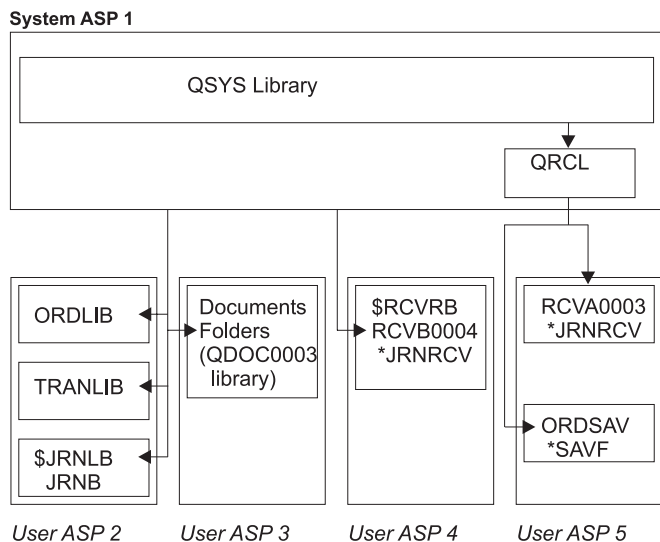

RBANS511-0

Figure 7. User ASP Configuration After Reclaiming Storage

The system recovers addressability to the objects in ASP 5, but it cannot recover their original library assignments. They are placed in the QRCL (Recovery) library. The objects in all user ASPs are owned by the QDFTOWN (Default Owner) user profile.

“Reclaim Storage” on page 35 provides more information about the RCLSTG procedure.

## Task 2—Restoring User Profiles

1. Sign on as QSECOFR.
2. In a clustered environment use the End Cluster Resource Group (ENDCRG) command and the End Cluster Node (ENDCLUNOD) command to stop clustering before ending subsystem QSYSWRK and continuing to restore the independent disk pool.
3. Ensure the system is in a restricted state. See “Putting Your System in a Restricted State” on page 35.
4. Find the most recent save media that has your user profiles. It may be a SAVSYS media volume or a SAVSECDTA media volume. The file on the save media volume is called QFILEUPR.
5. If you are using a SAVSYS media volume, type:
 

```
RSTUSRPRF DEV(media-device-name) USRPRF(*ALL)
      ENDOPT(*LEAVE)
```

 If you are using a SAVSECDTA media volume, type:
 

```
RSTUSRPRF DEV(media-device-name) USRPRF(*ALL)
      ENDOPT(*UNLOAD)
```

The time that this takes can vary significantly. “What Happens When You Restore User Profiles” on page 203 describes what the system does when you restore user profiles.

## Task 3—Restoring the Configuration

1. Find the most recent save media that has your configuration. It may be a SAVSYS media volume or a SAVCFG media volume. The file on the save media volume is called QFILEIOC.
2. If you are using a SAVSYS media volume, type:

```
RSTCFG OBJ(*ALL) DEV(media-device-name)
        OBJTYPE(*ALL)
        ENDOPT(*LEAVE)
```

If you are using a SAVCFG media volume, type:

```
RSTCFG OBJ(*ALL) DEV(media-device-name)
        OBJTYPE(*ALL)
        ENDOPT(*UNLOAD)
```

## Task 4—Recovering Journals and Journal Receivers in the QRCL Library

1. Determine if any objects are in the QRCL library. Type: DSPLIB QRCL. You see the Display Library display.
2. If no objects are listed on the display, skip to “Task 5—Restoring Libraries to the System Auxiliary Storage Pool” on page 174.
3. If the QRCL library contains objects, save them before proceeding with your recovery. Load a scratch media volume. Type the following:

```
SAVLIB LIB(QRCL) DEV(media-device-name)
        ENDOPT(*UNLOAD)
```
4. If the QRCL library does not contain journals or journal receivers, skip to “Task 5—Restoring Libraries to the System Auxiliary Storage Pool” on page 174.
5. Create one or more libraries in the system ASP for the journals and journal receivers from the QRCL library. The libraries you create must have the same names as the original libraries that contained the journals and journal receivers.

In the example shown in Figure 7 on page 172, the QRCL library contains the ORDSAV save file and the RCVA0003 journal receiver. At this point you need to create the \$JRNLA library. You would type: CRTLIB LIB(\$JRNLA).

6. Move the journals and journal receivers to the newly created libraries. This is the only circumstance in which you can move journals and journal receivers between libraries. You must use the MOVOBJ command. You cannot use save and restore commands. The MOVOBJ command leaves the journal or journal receiver in the user ASP but establishes its association with the correct library.

For the example shown in Figure 7 on page 172, you would type:

```
MOVOBJ OBJ(QRCL/RCVA0003) OBJTYPE(*JRNRCV) TOLIB($JRNLA)
```

7. Delete the QRCL library by typing DLTLIB QRCL.

**Note:** If the QRCL library contains save files, you will recover them in “Task 9—Recovering Save Files from the QRCL Library” on page 176. When you recover them, you will use the media volume that you created in step 3.

At this point, the system in the example would look like this:

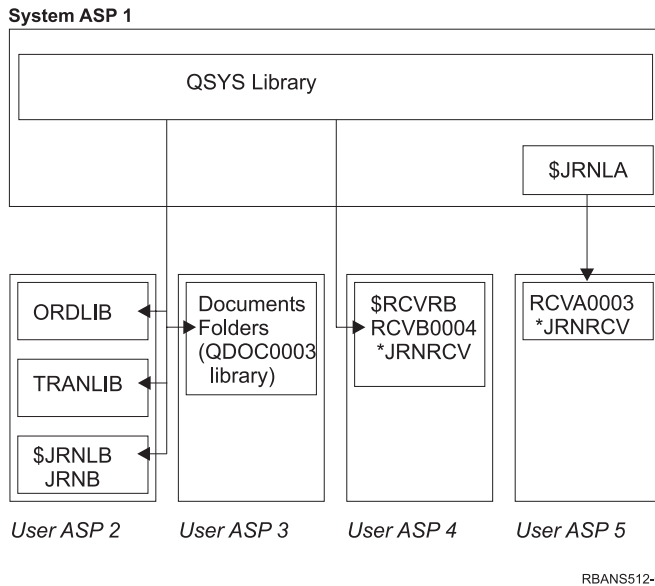

Figure 8. User ASP Configuration After Recovering Isolated Journal Receiver

## Task 5—Restoring Libraries to the System Auxiliary Storage Pool

1. Decide which libraries to restore. You should restore only the libraries in your system ASP. Do not restore the libraries that are already on your system in user ASPs.

If you are not sure which libraries are currently on your system, type `DSPOBJD OBJ(*ALL) OBJTYPE(*LIB)`.

**Note:** When you install the operating system, the system creates the QGPL library and the QUSRSYS library. You should still restore these libraries to restore the data from your saved copy.

2. Plan your restore sequence. If you restore in the wrong sequence, your journaling environment may not be started again or some objects may not restore successfully.  
For example, journals must be restored before the journaled objects. If journals and objects are in the same library, the system restores them in the correct order. If they are in different libraries, or the objects are integrated file system objects, you must restore them in the correct order. Similarly, physical files must be restored before their associated logical files. Read “Sequence for Restoring Related Objects” on page 34 for more information.
3. Choose the commands or menu options you will use. You can restore libraries by name or in a group, such as `*NONSYS`. See “The Relationship Between Save and Restore Commands” on page 31 for more information.

If you restore libraries in a group, **omit the libraries in your user ASPs**.

4. Type the restore commands or menu options that you have chosen. In the example shown in Figure 5 on page 169, libraries were saved using `SAVLIB(*ALLUSR)`. One way to restore them would be to type:

```
RSTLIB SAVLIB(*ALLUSR) DEV(media-device-name)
      OMITLIB(ORDLIB TRANLIB $JRNLB $RCVRB)
```

### If a media error occurs...

If you have an unrecoverable media error when you are restoring multiple libraries, see “Recovering from an Error While Restoring Libraries” on page 47.



## Task 6—Restoring Document Library Objects to the System Auxiliary Storage Pool

1. Find your most recent save media volume that you used to save all of the documents in the system ASP. You may have specified ASP(1) or ASP(\*ANY) for the save operation. The media volume should have the library QDOC on it.
2. Use the following command to restore the DLOs:  
RSTDLO DLO(\*ALL) FLR(\*ANY) ASP(1)

### If a media error occurs...

If you have an unrecoverable media error when you are restoring DLOs, see “Recovering from an Error While Restoring DLOs” on page 48.

## Task 7—Restoring User-Defined File Systems to the User Auxiliary Storage Pool

If you are journaling you need to plan your restore sequence. If you restore in the wrong sequence, your journaling environment may not be started again or some objects may not restore successfully. For example, journals must be restored before the journaled objects. If the objects are integrated file system objects, you must restore them in the correct order. Read “Sequence for Restoring Related Objects” on page 34 for more information.

Choose one of the three methods below based on the way in which your User-Defined File Systems (UDFS) were saved.

### Recovery Steps for Unmounted User-Defined File Systems (UDFS)

1. Load the media volume with the most recent backup of your UDFS when they were unmounted.
2. To restore a basic ASP, type RST OBJ((' /DEV/QASPxx ')) where xx is the Auxiliary Storage Pool number.

### Recovery Steps for Mounted User-Defined File Systems (UDFS) if Data is not Restored

Use the following steps if all UDFS are not already restored. The UDFS information is not saved or restored if the UDFS were saved mounted. You will need to recreate this information in step 1.

1. Create the UDFS exactly as they were before the recovery by using the CRTUDFS command. Be sure to include the authorities and object auditing.
2. Create the directory that each UDFS was mounted over at the time of the save by using the CRTDIR command.
3. Mount the UDFS over the directory by using the MOUNT command.

**Note:** If you were instructed to refer to these steps from another checklist, return to that checklist now.

4. Restore the UDFS by using the following command:

```
RST OBJ((' /directory_mounted_over '))
```

### Recovery Steps for Mounted User-Defined File Systems (UDFS) if Data is Restored

#### Attention!

This method is not recommended for recovery of UDFS. It is listed only as a means of recovery if the data is already restored. The previous method, “Recovery Steps for Mounted User-Defined File Systems (UDFS) if Data is not Restored,” is the recommended method.

The UDFS information is not saved or restored if the UDFS were saved mounted. You will need to recreate this information in step 1.

1. Create the UDFS exactly as they were before the recovery by using the CRTUDFS command.
2. Create temporary directories to use as mount points, using the CRTDIR command.
3. Mount the UDFS over the temporary directories, using the MOUNT command. This now becomes your UDFS in the user ASP.
4. Move or copy the objects in the new UDFS, using the MOV or CPY commands.
5. Unmount the UDFS, using the UNMOUNT command.

## Task 8– Reclaiming Document Library Objects

1. If you do not have DLOs in any user ASPs, skip to “Task 9–Recovering Save Files from the QRCL Library.”
2. Type:  
RCLDLO DLO(\*ALL) ASP(\*ANY)

This procedure rebuilds the association between the DLOs in the user ASP and the search index records. It also attempts to assign the DLOs to the correct owner.

## Task 9–Recovering Save Files from the QRCL Library

If you did not have any save files in the QRCL library, skip to “Task 10–Associating Journal Receivers with Journals.”

**Note:** You displayed the QRCL library in “Task 4–Recovering Journals and Journal Receivers in the QRCL Library” on page 173.

1. Load the scratch media volume that you created in “Task 4–Recovering Journals and Journal Receivers in the QRCL Library” on page 173.
2. Ensure that the original libraries for the save files were restored in “Task 5–Restoring Libraries to the System Auxiliary Storage Pool” on page 174. You can check by typing DSP0BJD OBJ(*library-name*) OBJTYPE(\*LIB).
3. Restore each save file from the scratch media volume to the correct library and user ASP. In the example shown in Figure 5 on page 169, you would type:

```
RSTOBJ OBJ(ORDSAV) SAVLIB(QRCL)
      RSTLIB(SAVFLIB)
      OBJTYPE(*SAVF) RSTASP(5)
```

## Task 10–Associating Journal Receivers with Journals

If you do not have any journals or journal receivers involved in the recovery, skip to “Task 11–Restoring Object Ownership” on page 178.

Whenever you do a recovery involving journals and journal receivers, you should ensure that your journal receivers are associated with the journal. This topic provides basic information about how to associate your journals and journal receivers.

Based on the steps performed so far, the receiver directory for journal JRNA in the example would look like this:

```

                                Work with Receiver Directory
Journal . . . . . : JRNA          Library . . . . . : $JRNLA
Total size of receivers (in kilobytes). . . . . : 155648
Type options, press Enter.
  4=Delete  8=Display attributes

Opt  Receiver  Library  Number  Attach  Status  Save
     RCVA0003  $JRNLA  00001  06/08/9x  ONLINE  00/00/00
-    RCVA1002  $JRNLA  01001  06/09/9x  ATTACHED 00/00/00

```

Notice that when JRNA was restored, the system created a new journal receiver called RCVA1002 and attached it. The receiver name is based on the name of the journal receiver that was attached when the journal was saved.

Do the following to associate journals and journal receivers:

1. Type WRKJRN on a command line and press the Enter key.
2. On the prompt display, type the name of the journal and the library name.
3. On the Work with Journals display, type a 9 (Associate receivers with journal) in the *Opt* column next to the journal that you want to work with.
4. Press the Enter key.
5. If you wish to limit the number of libraries being searched for your needs to be limited, type the name of the library that contains the journal receivers on the prompt display. A generic name can be specified for the journal receivers.

If any of the journal receivers in the user ASP were created before V3R1, using option 9 from the Work with Journals display might not associate them in the correct sequence. If you have journal receivers from a prior release or if any of the journal receivers you need are not online, do this:

1. Save the journal receivers that are on the system to a scratch media volume:
 

```

SAVOBJ OBJ(*ALL) LIB(library-name)
        DEV(media-device-name) OBJTYPE(*JRNRCV)
        VOL(*MOUNTED) ENDOPT(*UNLOAD)

```
2. After you ensure that the receivers were saved successfully, delete the journal receivers from the library:
  - a. Type WRKLIB *library-name* and press the Enter key. You are shown the work with library display.
  - b. Type a 12 (Work with Objects) in the *Opt* column.
  - c. Type a 4 (Delete) in the *Opt* for each journal receiver you want to delete.
  - d. Press the Enter key.
3. Restore the journal receivers you need from the scratch media volume and from your save media volumes. Restore them from newest to oldest by typing the following command for each journal receiver:
 

```

RSTOBJ OBJ(receiver-name)
        LIB(library-name) DEV(media-device-name)
        OBJTYPE(*JRNRCV) VOL(*MOUNTED)
        ENDOPT(*UNLOAD)

```

The receivers are reassociated with the journal.

At this point the receiver directory for JRNA looks like this:

```

Work with Receiver Directory

Journal . . . . . : JRNA          Library . . . . . : $JRNLA

Total size of receivers (in kilobytes). . . . . : 155648

Type options, press Enter.
 4=Delete  8=Display attributes

Opt Receiver  Library  Number Date      Status      Save
  _ RCVA0001  $JRNLA  00001  06/08/9x  SAVED       06/08/9x
  _ RCVA0002  $JRNLA  00002  06/09/9x  SAVED       06/09/9x
  _ RCVA0003  $JRNLA  00003  06/08/9x  ONLINE      00/00/00
  _ RCVA1002  $JRNLA  01002  06/09/9x  ATTACHED    00/00/00

```

### Task 11–Restoring Object Ownership

The RCLSTG procedure assigned ownership of all the objects in your user ASPs to the QDFTOWN user profile. In “Task 8– Reclaiming Document Library Objects” on page 176, you transferred ownership of DLOs to the correct user profiles. To transfer ownership of the other objects to the correct user profiles, do the following:

1. Type WRKOBJOWN USRPRF(QDFTOWN) and press the Enter key.

The Work with Objects by Owner display is shown:

```

Work with Objects by Owner

User profile . . . . . : QDFTOWN

Type options, press Enter.
 2=Edit authority      4=Delete  5=Display author
 8=Display description 9=Change owner

Opt Object      Library      Type      Attribute
 9 ORDRCV001    JRNLIB      *JRNRCV
 9 ORDHDR      ORDLIB      *FILE
 9 ORDDTL      ORDLIB      *FILE
 9 ORDHST      ORDLIB      *FILE
 9 ORDSAV      SAVFLIB     *SAVF
 9 TRAN01      TRANLIB     *FILE
:
Parameters or command
====> NEWOWN(OWNORD)
F3=Exit  F4=Prompt  F5=Refresh  F9=Retrieve
F18=Bottom

```

**Note:** If you see document library objects on this list (type \*DOC or \*FLR), one of the following has occurred:

- You forgot to run RCLDLO. See “Task 8– Reclaiming Document Library Objects” on page 176.
- The user profile that owns the DLO has not been restored. Restore the user profile. Then run the RCLDLO command.
- The DLO was owned by the QDFTOWN profile when it was saved. Determine the correct owner for the DLO and transfer ownership.

2. To transfer ownership of objects individually:

- a. Type a 9 in the *Opt* column for the object and press the Enter key. The Change Object Owner display is shown.
  - b. Type the name of the correct owner in the *New owner* prompt and press the Enter key.
  - c. Repeat steps 2a and 2b for each object on the display.
3. To transfer ownership of multiple objects that should have the same owner, use the technique shown in the display:
- a. Type 9 in the *Opt* column.
  - b. Type NEWOWN(*owner-name*) on the parameter line at the bottom of the display.
  - c. Press the Enter key. The system transfers ownership of each object you specified to the new owner.

**Stop!**

You have completed the recovery of information in your user auxiliary storage pools. Consult your recovery checklist for the next step in your recovery process.

## How to Recover An Overflowed User Auxiliary Storage Pool

The topics in this section provide basic information about working with user ASPs in recovery situations. Chapter 19, “Working with Auxiliary Storage Pools”, provides more information about setting up and managing user ASPs.

When the disk units allocated to a user ASP become full, the user ASP is in **overflowed status**. The system sends message CPI0953 to the QSYSOPR message queue warning you that an ASP is approaching its storage threshold. The system sends message CPI0954 when the storage threshold has been exceeded and the ASP is in overflowed status.

You should reset a user ASP in overflowed status as soon as possible. An overflowed ASP affects system performance. It also makes recovery more difficult and may increase the amount of data lost if a failure occurs. Follow the procedure in “Resetting An Overflowed User Auxiliary Storage Pool without an IPL.”

**Note:** To simplify future overflow recovery operations, you can enable automatic overflow recovery for basic user ASPs with the iSeries Navigator disk management function. For more information, refer to the Information Center at <http://www.ibm.com/eserver/series/infocenter>.

## Resetting An Overflowed User Auxiliary Storage Pool without an IPL

Do the following to reset a user ASP in overflowed status:

1. Determine which objects in the ASP have overflowed. Use one of these methods:
  - Use the DSPOBJD command to create an output file. Then run a query against that output file:
    - a. For the first library in the user ASP, type:
 

```
DSPOBJD OBJ(library-name/*ALL) OBJTYPE(*ALL)
          DETAIL(*FULL) OUTPUT(*OUTFILE)
          OUTFILE(library-name/file-name)
```
    - b. For each additional library in the user ASP, type:
 

```
DSPOBJD OBJ(library-name/*ALL) OBJTYPE(*ALL)
          DETAIL(*FULL) OUTPUT(*OUTFILE)
          OUTFILE(library-name/file-name)
          OUTMBR(*FIRST *ADD)
```
    - c. Create a query against the output file. Look for objects that have a 1 (Yes) in the ODOASP (overflowed ASP) field.
  - For a user ASP that contains only DLOs, use the QRYDOCLIB command. It has a parameter to display overflowed DLOs.
2. Save each overflowed object to a scratch media volume.

3. Delete each overflowed object.

Some objects, such as journals and physical files, require that you take certain actions before deleting them. Table 39. shows what to do before deleting these objects.

Table 39. Object Types That Require Special Procedures for Deleting

Object Type	Do This Before Deleting
Journal	“Steps before Deleting a Journal” on page 238
Journal receiver	“Steps before Deleting a Journal Receiver” on page 240
Physical file	“Steps Before Deleting a Physical File” on page 237

4. Ensure that the ASP is no longer in overflowed status. You should have received a message in the QSYSOPR message queue that the overflow condition has been recovered. You can also use System Service Tools (SST) to check:

- a. Type STRSST. You are shown the System Service Tools (SST) menu.
- b. Select the option to work with disk units.
- c. Select the option to display disk configuration.
- d. Select the option to display disk configuration capacity. You are shown the Display Disk Configuration Capacity display:  
This display shows whether any ASPs are in overflowed status.

Display Disk Configuration Capacity										
--Protected--				--Unprotected--						
ASP	Unit	Type	Model	Threshold	Overflow	Size	%Used	Size	%Used	
1				90%	No	0	0.00%	1400	8.22%	
	1	9332	400			0	0.00%	200	17.97%	
	2	9332	400			0	0.00%	200	6.60%	
	⋮									
2				90%	Yes	0	0.00%	200	99.99%	
	8	9332	200			0	0.00%	200	99.99%	

If the user ASP is still overflowed, follow the procedure described in “Resetting An Overflowed User Auxiliary Storage Pool during an IPL.”

5. Before you can restore the overflowed objects from a media volume, you must make additional space available in the user ASP. Do one or more of the following:

- Delete objects from the ASP if you no longer need them.
- Move one or more libraries to a different ASP.

**Note:** You cannot use the MOVOBJ command to do this. You must save the library, delete it, and restore it to a different ASP.

- Move one or more folders to a different ASP by saving the folder, deleting it, and restoring it to a different ASP.
- Add additional disk units to the ASP.

6. After you have made additional space available in the ASP, restore the objects you saved in step 2 on page 179.

7. Check to make sure the user ASP has sufficient space and is not overflowed. Repeat the procedure described in step 4.

## Resetting An Overflowed User Auxiliary Storage Pool during an IPL

Sometimes you are not able to find all the overflowed objects in a user ASP. If you have taken the steps described in “Resetting An Overflowed User Auxiliary Storage Pool without an IPL” on page 179 and the user ASP is still overflowed, you can perform a manual IPL to reset the user ASP. Do the following:

1. Ensure that you have enough space to reset the overflowed user ASP. Do the following:

- a. Type STRSST. You are shown the System Service Tools (SST) menu.
- b. Select the option to work with disk units.
- c. Select the option to display disk configuration.
- d. Select the option to display disk configuration capacity. You are shown the Display Disk Configuration Capacity display:  
This display shows whether any ASPs are in overflowed status.

Display Disk Configuration Capacity									
--Protected--					--Unprotected--				
ASP	Unit	Type	Model	Threshold	Overflow	Size	%Used	Size	%Used
1				90%	No	0	0.00%	1400	8.22%
1		9332	400			0	0.00%	200	17.97%
	2	9332	400			0	0.00%	200	6.60%
	:								
2					Yes	0	0.00%	200	99.99%
	8	9332	200	90%		0	0.00%	200	99.99%

- e. Press F9 (Display ASP Overflow information) to display the overflow amount and the additional amount of storage that is needed in the ASP to recover the overflowed objects.

Display ASP Overflow Information					
Overflow	---Amount Needed to Recover---		ASP	Threshold	Amount
	To Capacity	To Threshold			
2	90%	14		0	0
3	90%	25		25	45

- f. If the amount in the To Capacity field is greater than zero, the ASP will still be overflowed when the recovery completes. There is not enough free space in the user ASP to contain the overflowed data.
  - g. If you do not have enough space, repeat the instructions in step 5 on page 180 to free more space.
2. Do the following to put your system in a restricted state:
    - a. Before putting your system in a restricted state, ensure that all users are signed off and all jobs are ended.
    - b. To receive notification that the subsystems have ended, type the following and press the Enter key:  
CHGMSGQ MSGQ(QSYSOPR) DLVRY(\*BREAK)  
SEV(60)
    - c. To end all subsystems, type the following:  
ENDSBS SBS(\*ALL) OPTION(\*CNTRLD)  
DELAY(600)

**Note:** For the delay parameter, specify a number of seconds that allows your system time to bring most jobs to a normal end. On a large, busy system, you may need a longer delay.

A message is sent that indicates that the procedure for ending subsystems is in progress. A final message is sent when the system is in a restricted state.

3. Perform a manual IPL and access DST:

Use this procedure to start DST. If the IPL or Install the System menu is already displayed, start with step 5 on page 191.

- a. Ensure the keystick is in the system unit control panel.
- b. Place the system in manual mode.
- c. Power down the system:  
PWRDWN SYS OPTION(\*CNTRLD) DELAY(600)  
RESTART(\*YES) IPLSRC(B)

**Attention logical partitioning users!**

If you are going to use this command on the primary partition, be sure to power off all secondary partitions before running the command.

**Note:** If you are sure that no jobs are running on your system, you can specify `OPTION(*IMMED)` when you power down the system. Otherwise, specify a delay time that is sufficient to allow jobs to end normally.

- d. When the IPL completes, the IPL or Install the System menu appears.

IPL or Install the System

Select one of the following:

- 1. Perform an IPL
- 2. Install the operating system
- 3. Use Dedicated Service Tools (DST)
- 4. Perform automatic installation of the operating system
- 5. Save Licensed Internal Code

- 4. Select option 1 (Perform an IPL). You are shown the Disk Configuration Attention Report:

Disk Configuration Attention Report

Type option, press Enter.

5=Display Detailed Report

Press F10 to accept all the following problems and continue.

The system will attempt to correct them.

Opt	Problem
	Overflowed ASPs

If you type 5 in the Option field, the following screen is displayed, listing the User ASPs that are overflowed.

Recover Overflowed User ASP

The following user ASPs are overflowed.

ASP
2
3

- 5. Press the F10 key to request recovery of the overflowed user ASPs. The recovery takes place during the storage management recovery phase of the IPL. The operation takes from several minutes to a few hours, depending on the number of objects on the system and the amount of data to be recovered.
- 6. When the IPL of the system is complete, the Sign On display is shown.
- 7. Sign on and verify the results by checking the messages in the QSYSOPR message queue.

---

## How to Delete Overflowed Objects during Recovery

Use this procedure if you are recovering a user ASP that was in overflowed status.



1. After running the RCLSTG procedure, display the contents of the QRCL library by typing: DSPLIB QRCL
2. Write down the names of the objects in the library. These objects were overflowed into the system ASP at the time of the failure.  
Although the initial disk extents for these objects may have been allocated in the system ASP, portions of the objects may still have been lost. The integrity of these objects cannot be predicted. They should be deleted and recovered.
3. Delete the overflowed objects. You must take special action before deleting certain types of objects. See Table 39 on page 180 for more information.
4. When you run the RCLSTG command, any documents from the lost user ASP that were in overflowed status are placed in the user ASP again. (The system creates a new QDOCnnnn library, where *nnnn* is the number of the lost ASP, and places the overflowed DLOs in it.)

**Assuming you have not yet restored DLOs to the user ASP, type this to delete the overflowed DLOs:**

```
DLTDLO DLO(*ALL) FLR(*ANY) ASP(n)
```

where *n* is the number of the ASP whose data was lost.

## How to Recover a Damaged Basic Auxiliary Storage Pool

Perform this procedure if one of the following is true:

- The service representative has replaced a failed disk unit in a basic user ASP. If a disk unit is not parity protected or mirrored, when you lose that disk unit in an ASP, you must recover all of the information in that ASP. The information in other ASPs on your system is not affected.
- The system has reassigned sectors on a disk unit, but object damage has occurred.
- You have replaced a disk unit in the system ASP and one or more user ASPs was overflowed.

### Task 1—Restoring User Profiles

Even though user profiles are not lost when you replace a unit in a user ASP, they must be restored to prepare for restoring authority to objects in the user ASP. Do the following:

1. Sign on with the QSECOFR user profile.
2. End all subsystems with the ENDSBS command and go to a restricted state.
3. Load your most recent SAVSYS or SAVSECDTA media volume.
4. Restore all user profiles. Type:  
RSTUSRPRF DEV(media-device-name) USRPRF(\*ALL)  
ENDOPT(\*UNLOAD)
5. If you know what libraries or objects were in the user ASP that was lost, skip to “Task 3—Determining Tasks to Restore Objects” on page 184.  
If you do not know what was in the user ASP, continue with “Task 2—Determining the Contents of the Lost Auxiliary Storage Pool.”

### Task 2—Determining the Contents of the Lost Auxiliary Storage Pool

If your system has a small number of libraries and is well-documented, like the one in Figure 5 on page 169, your task is relatively simple. In the example, if a disk unit in ASP 2 is replaced, the user must recover the ORDLIB, TRANLIB, and \$JRNLA libraries. If a disk unit in ASP 5 is replaced, the user must recover all the journal receivers in the \$JRNLA library and the ORDSAV save file in the SAVFLIB library.

If you are not sure what was on the basic ASP, do this:

1. Sign on with a user profile that has \*ALLOBJ special authority so that your listings show all libraries.
2. Print a list of the libraries that are on the lost basic ASP by doing the following:
  - a. Create a list of all the libraries in an output file:

```

DSPOBJD OBJ(QSYS/*ALL) OBJTYPE(*LIB) OUTPUT(*PRINT)
        DETAIL(*FULL) OUTPUT(*OUTFILE)
        OUTFILE(library-name/file-name)

```

- b. Use a program or a query tool to display or print the output file. Select all entries that have an ASP field that matches the ASP that is lost.

**Notes:**

- 1) When you lose a basic ASP, you lose the contents of any libraries in the ASP, not the libraries themselves. The library objects are in the QSYS library, which is in the system ASP.
- 2) If you had documents in the basic ASP, you should have a library on your listing for the ASP. The library name is QDOCnnnn, where *nnnn* is the number of the ASP.
3. If you have determined what must be recovered, continue with “Task 3–Determining Tasks to Restore Objects.” If you have not found any libraries to recover, continue with step 4.
4. If you did not find any libraries to recover in step 2 on page 183, the ASP was probably a nonlibrary user ASP. A nonlibrary user ASP can contain only save files, journals, and journal receivers.

Determining the objects that were in a nonlibrary user ASP can be very time consuming. The following steps are one method. This method works only if you have not yet run RCLSTG after losing the user ASP.

- a. Type the following:

```

DSPOBJD OBJ(*ALL/*ALL)
        OBJTYPE(*LIB *FILE *JRN *JRNRCV)
        OUTPUT(*OUTFILE)
        OUTFILE(library-name/file-name)

```

- b. Use a program or query tool to list all the objects in the output file that are in the ASP that is damaged.
5. When you have determined the objects that need to be recovered, continue with “Task 3–Determining Tasks to Restore Objects.”

### Task 3–Determining Tasks to Restore Objects

1. Use Table 40 to determine how to recover the objects in your basic ASP. It shows the recovery tasks you must perform, based on the contents of the basic ASP you are recovering.
2. If you have different types of objects to recover, such as libraries and user-defined file systems, perform the tasks in the order shown in the table.

*Table 40. Tasks for Restoring basic ASP Objects*

Type of ASP	Contents	Recovery Tasks
Library User ASP	Libraries	“Task 4–Restoring Libraries to a Basic Auxiliary Storage Pool”
Nonlibrary User ASP	Journals	“Task 5–Restoring Journals to a Basic Auxiliary Storage Pool” on page 185
Library User ASP	Documents	“Task 6–Restoring Documents to a Basic Auxiliary Storage Pool” on page 186
Library User ASP	User-defined file systems	“Task 7–Restoring User-Defined File Systems to a Basic Auxiliary Storage Pool” on page 186
Nonlibrary User ASP	Journal receivers	“Task 8–Restoring Journal Receivers to a Basic Auxiliary Storage Pool” on page 187
Nonlibrary User ASP	Save files	“Task 9–Restore Save Files to a Basic Auxiliary Storage Pool” on page 187

### Task 4–Restoring Libraries to a Basic Auxiliary Storage Pool

1. Sign on with a user profile that has \*SAVSYS and \*JOBCTL special authority.
2. For each library you need to recover, load the correct volume from your latest save media volumes.
3. Type:

```
RSTLIB SAVLIB(library-name) DEV(media-device-name)
ENDOPT(*LEAVE)
```

**Note:** You should restore changed objects and apply journaled changes for all the ASPs included in your recovery at the same time. These steps appear on the recovery checklist at the appropriate point.

4. Continue with the next task shown in Table 40 on page 184. If you have completed all the appropriate tasks in the table, continue with the next task in the recovery checklist from Chapter 3.

## Task 5—Restoring Journals to a Basic Auxiliary Storage Pool

1. Sign on with a user profile that has \*SAVSYS and \*JOBCTL special authority.
2. For each journal you need to recover, load the correct save media volume and type:

```
RSTOBJ OBJ(journal-name) SAVLIB(library-name)
DEV(media-device-name) OBJTYPE(*JRN)
```

When you restore the journal, the system automatically creates and attaches a new journal receiver. The Journal Management topic in the iSeries Information Center (<http://www.ibm.com/eserver/series/infocenter>) describes how the system names the journal receiver that is created when you restore a journal.

3. Establish your journaling environment again. Do this:

- a. For each database physical file that was journaled to the restored journal, type:

```
STRJRNP FILE(library-name/file-name)
JRN(library-name/journal-name)
```

**Note:** To determine what options you specified for the file when you last journaled it, you can use the Display File Description (DSPFD) or Display Object Description (DSPOBJD) commands for the file to find out.

- b. For each access path that was journaled to the restored journal, type:

```
STRJRNP FILE(library-name/file-name)
JRN(library-name/journal-name)
```

- c. For each integrated file system object that was journaled to the restored journal, type:

```
STRJRN OBJ ('object-path-name')
JRN ('journal-path-name')
```

**Note:** To determine what options you specified for the object when you last journaled it, you can use the Display Link (DSPLNK) command.

- d. For all other object types that were journaled, type one of the following:

```
STRJRNOBJ OBJ(library-name/object-name)
OBJTYPE(object-type)
JRN(library-name/journal-name)
```

**Note:** To determine what options you specified for the object when you last journaled it, you can use the Display Object Description (DSPOBJD) command.

- e. Save each object that you started journaling.
4. If you need to restore journal receivers for the journals, skip to “Task 8—Restoring Journal Receivers to a Basic Auxiliary Storage Pool” on page 187.
5. Associate journal receivers with the journals you restored. Do the following:
  - a. Type WRKJRN on a command line and press the Enter key.
  - b. On the prompt display, type the name of the journal and the library name.
  - c. On the Work with Journals display, type a 9 (Associate receivers with journal) in the *Opt* column next to the journal that you want to work with.
  - d. Press the Enter key.

- e. If you wish to limit the number of libraries being searched for needs to be limited, type the name of the library that contains the journal receivers on the prompt display. A generic name can be specified for the journal receivers.
6. Continue with the next task shown in Table 40 on page 184. If you have completed all the appropriate tasks in the table, continue with the next task in the recovery checklist from Chapter 3.

## Task 6—Restoring Documents to a Basic Auxiliary Storage Pool

1. Sign on with a user profile that has \*SAVSYS and \*JOBCTL special authority.
2. Load the media volume with your last complete save of documents in the user ASP.
3. Restore the documents to the user ASP by typing:
 

```
RSTDLO DLO(*ALL) SAVASP(ASP-number)
RSTASP(ASP-number)
```

This restores the documents and makes any changes necessary to the search index database files.
4. Use the Query Document Library (QRYDOCLIB) to locate any documents that were created on the user ASP since the last save operation. Query by ASP number and creation date. Inform your users that these documents were lost and develop a plan to re-create them.
5. Continue with the next task in the recovery checklist from Chapter 3.

## Task 7—Restoring User-Defined File Systems to a Basic Auxiliary Storage Pool

Choose one of the three methods below based on the way in which your User-Defined File Systems (UDFS) were saved.

### Recovery Steps for Unmounted User-Defined File Systems (UDFS)

1. Load the media volume with the most recent backup of your UDFS when they were unmounted.
2. To restore a basic ASP, type `RST OBJ((' /DEV/QASPxx'))` where *xx* is the auxiliary storage pool number.

### Recovery Steps for Mounted User-Defined File Systems (UDFS) if Data is not Restored

Use the following steps if all UDFS are not already restored. The UDFS information is not saved or restored if the UDFS were saved mounted. You will need to recreate this information in step 1.

1. Create the UDFS exactly as they were before the recovery by using the CRTUDFS command. Be sure to include the authorities and object auditing.
2. Create the directory that each UDFS was mounted over at the time of the save by using the CRTDIR command.
3. Mount the UDFS over the directory by using the MOUNT command.

**Note:** If you were instructed to refer to these steps from another checklist, return to that checklist now.

4. Restore the UDFS by using the following command:

```
RST OBJ((' /directory_mounted_over'))
```

### Recovery Steps for Mounted User-Defined File Systems (UDFS) if Data is Restored

#### Attention!

This method is not recommended for recovery of UDFS. It is listed only as a means of recovery if the data is already restored. The previous method, “Recovery Steps for Mounted User-Defined File Systems (UDFS) if Data is not Restored” on page 175, is the recommended method.

The UDFS information is not saved or restored if the UDFS were saved mounted. You will need to recreate this information in step 1.

1. Create the UDFS exactly as they were before the recovery by using the CRTUDFS command.
2. Create a temporary directory to use as a mount point, using the CRTDIR command.
3. Mount the UDFS over the temporary directory, using the MOUNT command. This now becomes your UDFS in the user ASP.
4. Create the directories that are currently in the restored mounted UDFS in the UDFS that you created in the previous three steps. This tree structure must exist in order to move or copy the objects.
5. Move or copy the objects in the new UDFS, using the MOV or CPY commands.
6. Unmount the UDFS, using the UNMOUNT command.

## Task 8—Restoring Journal Receivers to a Basic Auxiliary Storage Pool

1. Sign on with a user profile that has \*SAVSYS and \*JOBCTL special authority.
2. For each journal receiver you need to recover, load the correct save media volume and type:
 

```
RSTOBJ OBJ(receiver-name) SAVLIB(library-name)
      DEV(media-device-name) OBJTYPE(*JRNRCV)
```
3. Continue with the next task shown in Table 40 on page 184. If you have completed all the appropriate tasks in the table, continue with the next task in the recovery checklist from Chapter 3.

## Task 9—Restore Save Files to a Basic Auxiliary Storage Pool

1. Sign on with a user profile that has \*SAVSYS and \*JOBCTL special authority.
2. For each save file you need to recover, load the correct save media volume and type:

```
RSTOBJ OBJ(save-file-name) SAVLIB(library-name)
      DEV(media-device-name) OBJTYPE(*SAVF)
```

**Note:** This command restores the description of the save file and its contents, if you specified SAVFDTA(\*YES) when you saved the save file. If you specified SAVFDTA(\*NO) when you saved the save file, this command restores only the save file description.

3. Continue with the next task in the recovery checklist from Chapter 3.

---

## How to Recover an Independent ASP

Perform this procedure if one of the following is true:

- The service representative has replaced a failed disk unit in an independent auxiliary storage pool (ASP). If a disk unit is not parity protected or mirrored, when you lose that disk unit in an ASP, you must recover all of the information in that ASP. The information in other ASPs on your system is not affected.
- The system has reassigned sectors on a disk unit, but object damage has occurred.
- You are performing a full system recovery and have been directed to this procedure from a recovery checklist.

The independent ASP that you recover must be in the Available state to perform the restore.

**Note:** Independent ASPs are called independent disk pools in iSeries Navigator.

## Task 1—Restoring User Profiles

Even though user profiles are not lost when you replace a unit in an independent ASP, they must be restored to prepare for restoring authority to objects in the independent ASP.

**Note:** If you are performing a full system recovery and chose not to perform a RSTAUT command before the IPL, or if you chose to only restore authorities for the system and basic ASPs, you can skip this step.

1. Sign on with the QSECOFR user profile.

2. End all subsystems with the ENDSBS command and go to a restricted state.
3. Load your most recent SAVSYS or SAVSECDTA media volume.
4. Restore all user profiles. Type:
 

```
RSTUSRPRF DEV(media-device-name) USRPRF(*ALL)
      ENDOPT(*UNLOAD) SECDTA(*PVTAUT)
```
5. If you are restoring a UDFS ASP, skip to “Task 4–Restoring User-Defined File Systems to the Independent Auxiliary Storage Pool” on page 189.

## Task 2–Determining Tasks to Restore Objects to an Independent ASP

If you are performing a full system recovery, you need to perform this task for each independent ASP. Your restore process will be most efficient if you restore independent ASPs and their contents in the order that they were saved. Independent ASPs are saved alphabetically. Secondary ASPs are saved along with their primary.

Table 41. Example of restore order for independent ASPs saved with GO SAVE: Option 21 or 23

Restore order	Independent ASP name	Independent ASP type	What is restored	Command
1	Apples	Primary	Libraries	RSTLIB SAVLIB (*ALLUSR)
	Cantaloupe	Secondary		
2	Apples	Primary	User-defined file systems	RST OBJ(('/DEV/iasp-name'))
	Cantaloupe	Secondary		
3	Bananas	UDFS	User-defined file systems	RST OBJ(('/DEV/iasp-name'))

1. Use Table 42 to determine how to recover the objects in your independent ASP. It shows the recovery tasks you must perform, based on the contents of the independent ASP you are recovering.
2. If you have different types of objects to recover, such as libraries and documents, perform the tasks in the order shown in the table.

Table 42. Tasks for Restoring independent ASP Objects

Contents	Recovery Tasks
Libraries	“Task 3–Restoring Libraries to the Independent Auxiliary Storage Pool”
User-defined file systems	“Task 4–Restoring User-Defined File Systems to the Independent Auxiliary Storage Pool” on page 189

## Task 3–Restoring Libraries to the Independent Auxiliary Storage Pool

1. Sign on with a user profile that has \*SAVSYS and \*JOBCTL special authority.
2. Specify the independent ASP group:
 

```
SETASPGRP(iasp-group-name)
```
3. To recover libraries within the independent ASP group, load the correct volume from your latest save media volumes. Make sure you are at the correct spot in the save media. You may need to specify a sequence number to access the correct library data for your independent ASP.
  - To restore libraries that were saved by a GO SAVE: Option 21 or 23 command, type:
 

```
RSTLIB SAVLIB(*ALLUSR) DEV(media-device-name)
          ENDOPT(*LEAVE)
```
  - To restore an individual library to the independent ASP, type:
 

```
RSTLIB SAVLIB(library-name) DEV(media-device-name)
          ENDOPT(*LEAVE)
```

**Note:** If you are restoring the library from optical media, you must also specify the path name:

```
RSTLIB SAVLIB(library-name) DEV(optical-device-name)
OPTFILE('QSRSAVIASP/iasp_name/*')
```

The default for the RSTLIB command is to restore the library to the independent ASP from which it was saved. If you want to restore the library to another independent ASP, you can use the RSTASPDEV parameter. If you want to restore the library to a basic ASP or the system ASP instead of the independent ASP you can use the RSTASP parameter. It is possible to restore the same library to two different independent ASPs. However, you cannot restore the same library to an independent ASP as well as the system ASP or basic ASP.

If you are restoring libraries to an independent ASP with the same name but a different ASP number, the following libraries will automatically be renamed when restored:

- QSYS2nnnnn
- QRCLnnnnn
- SYSIBnnnnn

where nnnnn is the number of the independent ASP.

**Note:** You should restore changed objects and apply journaled changes for all the ASPs included in your recovery at the same time. These steps appear on the recovery checklist at the appropriate point.

4. Continue with the next task shown in Table 42 on page 188. If you have completed all the appropriate tasks in the table, continue with the next task in the recovery checklist from Chapter 3.

## Task 4—Restoring User-Defined File Systems to the Independent Auxiliary Storage Pool

Choose one of the three methods below based on the way in which your User-Defined File Systems (UDFS) were saved.

### Recovery Steps for Unmounted User-Defined File Systems (UDFS)

1. Load the media volume with the most recent backup of your UDFS when they were unmounted.
2. Unmount any QDEFAULT user-defined file systems in the independent ASP.
3. To restore the UDFS into an independent ASP, type `RST OBJ('/DEV/iasp-name')` where *iasp-name* is the name of the independent ASP. If you are restoring multiple independent ASPs in the order you saved them, you can also specify `RST OBJ('/DEV/*')` to restore all user-defined file systems for each independent ASP.

**Note:** If you are restoring the file systems from optical media for an independent ASP, you must also specify the device and optical file path name for the current primary ASP group associated with the job:

```
RST DEV('/qsys.lib/optical-device-name') OBJ('/DEV/*')
OPTFILE('QSRSAVIASP/primary-ASP-name/*')
```

4. Mount any QDEFAULT user-defined file systems that were unmounted in an earlier step.
5. If your independent ASP includes system created Network Server Storage spaces (NWSSTG) that are referenced by a Network Server Description (NWS), verify that they are linked to the NWS. If necessary, add the network server storage links for the NWS, using the instructions in “Completing Recovery for the IBM iSeries Integration for Windows Server Product” on page 250.

### Recovery Steps for Mounted User-Defined File Systems (UDFS) if Data is not Restored

Use the following steps if all UDFS are not already restored. The UDFS information is not saved or restored if the UDFS were saved mounted. You will need to recreate this information in step 1.

1. Create the UDFS exactly as they were before the recovery by using the CRTUDFS command. Be sure to include the authorities and object auditing.

2. Create the directory that each UDFS was mounted over at the time of the save by using the CRTDIR command.
3. Mount the UDFS over the directory by using the MOUNT command.

**Note:** If you were instructed to refer to these steps from another checklist, return to that checklist now.

4. Restore the UDFS by using the following command:

```
RST OBJ('/directory_mounted_over')
```

## Recovery Steps for Mounted User-Defined File Systems (UDFS) if Data is Restored

### Attention!

This method is not recommended for recovery of UDFS. It is listed only as a means of recovery if the data is already restored. The previous method, "Recovery Steps for Mounted User-Defined File Systems (UDFS) if Data is not Restored" on page 175, is the recommended method.

The UDFS information is not saved or restored if the UDFS were saved mounted. You will need to recreate this information in step 1.

1. Create the UDFS exactly as they were before the recovery by using the CRTUDFS command.
2. Create a temporary directory to use as a mount point, using the CRTDIR command.
3. Mount the UDFS over the temporary directory, using the MOUNT command. This now becomes your UDFS in the user ASP.
4. Create the directories that are currently in the restored mounted UDFS in the UDFS that you created in the previous three steps. This tree structure must exist in order to move or copy the objects.
5. Move or copy the objects in the new UDFS, using the MOV or CPY commands.
6. Unmount the UDFS, using the UNMOUNT command.

## Task 5. Restoring Authority for an Independent ASP

These four scenarios are the most common restore methods:

- Save from an independent ASP and restore it to an independent ASP with an identical name.
- Save from \*SYSBAS and restore it to a new independent ASP.
- Save from an independent ASP and restore it to an independent ASP with a different name.
- Save from an independent ASP and restore it to \*SYSBAS.

The "Restore authorities for independent ASP data" on page 214 section explains the scenarios in more detail with command examples.

---

## How to Remove a Failed Disk Unit from the System ASP

Use this procedure to remove a disk unit from your configuration if the unit has failed. This procedure allows you to return your system to operation if a replacement disk unit is not immediately available. However, this procedure removes all data from your system and requires a complete restore operation.

After performing this procedure, your system will have less disk capacity. You may not be able to restore all user information until you have installed and configured a replacement disk unit.

Before you perform this procedure, ensure that the remaining 2800-001 storage units in your system ASP are large enough for a main storage dump. Consult software support or refer to Chapter 19, "Working with Auxiliary Storage Pools," on page 375.



## Task 1—Accessing Dedicated Service Tools

Use this procedure to start DST. If the IPL or Install the System menu is already displayed, start with step 5.

1. Ensure the keystick is in the system unit control panel.
2. Place the system in manual mode.
3. Power down the system:

```
PWRDOWNSYS OPTION(*CNTRL) DELAY(600) RESTART(*YES)
IPLSRC(B)
```

**Attention logical partitioning users!**

If you are going to use this command on the primary partition, be sure to power off all secondary partitions before running the command.

**Note:** If you are sure that no jobs are running on your system, you can specify `OPTION(*IMMED)` when you power down the system. Otherwise, specify a delay time that is sufficient to allow jobs to end normally.

4. When the IPL completes, the IPL or Install the System menu appears.

```
IPL or Install the System

Select one of the following:
  1. Perform an IPL
  2. Install the operating system
  3. Use Dedicated Service Tools (DST)
  4. Perform automatic installation of the operating system
  5. Save Licensed Internal Code
```

5. Select option 3 (Use Dedicated Service Tools (DST)) and press the Enter key. The Dedicated Service Tools (DST) Sign On display is shown.

```
Dedicated Service Tools (DST) Sign On
Type choice, press Enter.
Service tools user . . . . . _____
Service tools password . . . . . _____
```

6. In the *Service tools user* field, type QSECOFR. In the *Service tools password* field, type your DST service tools password. On a new system, the password is QSECOFR. The password is case sensitive; type in all capital letters. The service tools profile QSECOFR password is expired after the first use. At the Change Service Tools User Password screen, enter in all uppercase letters the current password QSECOFR and a new password, along with the verification password. You can find more information about service tools user IDs and passwords in the iSeries Information Center, <http://www.ibm.com/eserver/series/infocenter>. See **Security** -> **Service tools user IDs and passwords**.

The Use Dedicated Service Tools (DST) menu is shown.

Use Dedicated Service Tools (DST)

Select one of the following:

1. Perform an IPL
2. Install the operating system
3. Work with licensed internal code
4. Work with disk units
5. Work with DST environment
6. Select DST console mode
7. Start a service tool
8. Perform automatic installation of the operating system
9. Work with save storage and restore storage
10. Work with remote DST support

## Task 2–Deleting the Auxiliary Storage Pool Data

1. From the Use Dedicated Service Tools (DST) menu, do the following:
  - a. Select option 4 (Work with disk units).
  - b. Select option 1 (Work with disk configuration) on the Work with Disk Units display.
  - c. Select option 3 (Work with ASP configuration) on the Work with Disk Configuration display.
2. Select option 4 (Delete ASP data) on the Work with ASP Configuration display.

**Note:** Selecting this option deletes all data in the system ASP. Do not use this procedure unless you have a failed disk unit and there is no immediate replacement for the disk unit.

Select ASP to Delete Data From

Type options, press Enter

4=Delete ASP data  
Option

ASP	Threshold	Overflow	--Protected--		--Unprotected	
			Size	%Used	Size	%Used
1	90%	No	0.00	0.00%	1200	74.84%
2	90%	Yes	0.00	0.00%	200	99.99%
3	90%	Yes	0.00	0.00%	200	99.99%

3. Type a 4 in the *Option* column to select the ASP that you want to delete the data from and press the Enter key. The following display is shown.

Confirm Delete ASP Data

Warning: All data will be deleted from the selected ASPs.  
You have selected to delete data from ASP 1. This will prevent you from changing the disk configuration in some ways until the system is IPLed again to DST.

Press F10 to confirm your choice for 4=Delete ASP data.  
Press F12=Cancel to return to change your choice.

Option	ASP	Threshold	Overflow	--Protected--		--Unprotected--	
				Size	%Used	Size	%Used
4	1	90%	No	0	0.00	1200	*

4. Press F10 (Confirm) to confirm your choice to delete the ASP data.
5. When the delete of the ASP data is complete, you return to the Use Dedicated Service Tools (DST) menu.

## Task 3—Removing the Disk Unit from the Auxiliary Storage Pool Configuration

To remove the disk unit from the ASP, do the following:

1. If you are not already using DST, perform a manual IPL to start DST. See “How to Start Dedicated Service Tools (DST)” on page 366.
2. From the Use Dedicated Service Tools (DST) menu, do the following:
  - a. Select option 4 (Work with disk units).
  - b. Select option 1 (Work with disk configuration) on the Work with Disk Units display.
  - c. Select option 3 (Work with ASP configuration) on the Work with Disk Configuration display.
3. The Remove Units From Configuration display is shown.

Remove Units from Configuration								
Type options, press Enter.								
4=Remove unit from configuration								
OPT	Unit	ASP	Serial Number	Type	Model	Resource Name	Status	
	2	1	10-00A7529	9332	400	DD010	Configured	
	3	1	10-00A4936	9332	400	DD012	Configured	
	4	1	10-00A4936	9332	400	DD014	Configured	
4	5	1	10-00A7498	9332	400	DD015	Configured	
4	6	1	10-00A7498	9332	400	DD017	Configured	
	7	1	10-00A7530	9332	400	DD018	Configured	
	8	1	10-00A7530	9332	400	DD021	Configured	

4. Type a 4 (Remove unit from configuration) in the OPT column for each unit that you want to remove and press the Enter key. If the remove operation would leave the ASP with insufficient storage, you receive an error message.

If you see the Confirm Remove Disk Units display, skip to 6.

The Confirm Continuation display may be shown before the Confirm Remove Disk Units display if the storage management directories are not usable.

Confirm Continuation
To proceed, the system must perform internal processing that may take several minutes during which the system may appear inactive.
Press Enter to continue.
Press F12=Cancel to return and change your choice.

5. Determine whether you want to cancel the procedure or continue. If you want to continue, press the Enter key.
6. The Confirm Remove Disk Units display is shown:

### Confirm Remove Disk Units

Removing disk units will take several minutes.

Press Enter to confirm remove of disk units.  
Press F9=Capacity information to display the capacity information.  
Press F12=Cancel to return to change your choice.

OPT	Unit	ASP	Serial Number	Type	Model	Resource Name	Status
4	5	1	10-00A7498	9332	400	DD010	Configured
4	6	1	10-00A7498	9332	400	DD012	Configured

Press F9 (Capacity information to display the resulting capacity.

### Resulting Capacity

The configuration change that you requested would result in the following ASP capacities.

Press Enter to continue.

ASP	Threshold	-----Current-----				-----Modified-----			
		--Protected--		-Unprotected-		--Protected--		-Unprotected-	
		Size	%Used	Size	%Used	Size	%Used	Size	%Used
1	90%	0	0.00%	1600	52.70%	0	0.00%	1200	70.26%

7. Press the Enter key to return to the Confirm Remove Disk Units display.
8. Press the Enter key on the Confirm Remove Disk Units display to remove the selected units. The system moves the data off the units selected to be removed to the remaining units in the source ASP. The remove can take several minutes or several hours during which the system appears inactive.

#### Notes:

- a. The time it takes to remove a unit depends on the disk unit type and model.
  - b. If the data on the unit being removed is severely fragmented and the amount of storage used is high, the remove operation could take several hours.
9. When the remove operation is complete, you return to the Work with ASP Configuration display. Press F3 until you return to the Use Dedicated Service Tools (DST) display.

---

## Chapter 8. The Restore Menu

The Restore menu provides many options for recovering information. Figure 9 shows the menu. Options marked with a plus sign (+) require the system to be in a restricted state. When your system is in a restricted state, that does not prevent client workstations from attempting to access information. If you have directories managed by the Windows server on iSeries, you should vary off the network server descriptions.



*Figure 9. Restore Menu—First Display*

You can page down on the Restore menu to see additional options:

---

### Restore System and User Data

+ 21. System and user data

---

+ 22. System data only

---

+ 23. All user data

---

### Restore Office Data

30. All documents, folder, and mail

---

31. Documents and folders

---

32. Mail only

---

33. Calendars

---

### Restore Libraries

+ 40. All libraries other than system library

---

41. All IBM libraries other than system library

---

42. All user libraries

---

### Restore from Different Systems

50. Restore from System/36™ format

---

## What the Restore Menu Options Do

Following are the commands the system runs for the menu options that restore either the system, the system data only, or all user data. The name of the CL program that the system runs is in parentheses () following the description of the menu option. You can change this CL program if you need different values than the system-supplied defaults.

Option Number	Description and Commands
21	System and user data (QMNRSTE): ENDSBS SBS(*ALL) OPTION(*IMMED) RSTUSRPRF USRPRF(*ALL) RSTCFG OBJ(*ALL) RSTLIB SAVLIB(*NONSYS) RSTDLO DLO(*ALL) SAVFLR(*ANY) RST DEV('/QSYS.LIB/media-device-name.DEVD') OBJ('/*' ) ('/QSYS.LIB' *OMIT) ('/QDLS' *OMIT)) RSTAUT STRSBS SBSD( <i>controlling subsystem</i> )
22	System data only (QSRRSTI): ENDSBS SBS(*ALL) OPTION(*IMMED) RSTUSRPRF USRPRF(*ALL) RSTCFG OBJ(*ALL) RSTLIB SAVLIB(*IBM) RST DEV('/QSYS.LIB/media-device-name.DEVD') OBJ('/QIBM/ProdData') ('/QOpenSys/QIBM/ProdData')) STRSBS SBSD( <i>controlling subsystem</i> )
23	All user data (QSRRSTU): ENDSBS SBS(*ALL) OPTION(*IMMED) RSTUSRPRF USRPRF(*ALL) RSTCFG OBJ(*ALL) RSTLIB SAVLIB(*ALLUSR) RSTDLO DLO(*ALL) SAVFLR(*ANY) RST DEV('/QSYS.LIB/media-device-name.DEVD') OBJ('/*' ) ('/QSYS.LIB' *OMIT) ('/QDLS' *OMIT) ('/QIBM/ProdData' *OMIT) ('/QOpenSys/QIBM/ProdData' *OMIT)) RSTAUT USRPRF(*ALL) STRSBS SBSD( <i>controlling subsystem</i> )

## How to Use Restore Menu Options 21, 22, and 23

This topic describes the procedure for restoring information using option 21, 22, or 23 from the Restore menu. The basic steps are the same for each menu option. Which option or options you use depends on which save menu option was used and what other procedures, if any, you use to save information. This is discussed in “Choosing the Procedure to Recover User Information” on page 95.

### Before You Begin

- Clean the read and write heads of the tape unit if you are restoring from a tape drive.

1. Sign on the system using a user profile with sufficient authority to do the restore operation (such as QSECOFR).
2. Ensure that you load the correct volume of your last set of save media and make the device ready. The save media should contain the file labeled QFILEUPR.
  - a. If you use tape media, run the DSPTAP command and specify DATA(\*LABELS) to find the file labeled QFILEUPR.
  - b. If you use DVD-RAM optical media, perform the following steps:
    - 1) From a command line run this command: DSPOPT VOL(\*MOUNTED) DEV(OPT01) DATA(\*FILATR) PATH('QFILEUPR').

- 2) If the file is on the media, page down on your display to verify that the file is on the first volume. If the display says Continued from previous volume...NO, then the file QFILEUPR is on the first volume of your save media set.
3. Ensure that any device configuration objects not used in the restore operation are varied off. You can use the Work with Configuration Status (WRKCFGSTS) command to display the status of devices.
4. Ensure that the devices that you are using for the restore operation (workstations, devices, and device controllers) are varied on. These configuration objects are excluded from the restore operation (message CPF379C in the job log).
5. Display the Restore menu: GO RESTORE.
6. If you want to do an *attended restore*, skip to step 7. In most cases, you should do an attended restore operation to monitor for messages and correct any problems that occur. This helps your system return to operation as quickly as possible. If you want to do an *unattended restore*, do the following steps. This prevents your restore operation from stopping because of unanswered messages:
  - a. Display the reply list sequence numbers to find what numbers are available for use:  
WRKRPYLE
  - b. If MSGID(CPA3709) is not already in your reply list, add it. For *xxxx*, substitute an unused sequence number from 1 through 9999:  
ADDRPYLE SEQNBR(*xxxx*) MSGID(CPA3709) RPY('G')
  - c. Change your job to use the reply list:  
CHGJOB INQMSGRPY(\*SYSRPYL) BRKMSG(\*NOTIFY)
7. Select the option (21, 22, or 23) from the Restore menu.

Specify Command Defaults

Type choices, press Enter.

Devices . . . . .	TAP01	Names
	_____	
	_____	
	_____	
Prompt for commands . . . . .	Y	Y=Yes, N=No
Message queue delivery . . . . .	*BREAK	*BREAK, *NOTIFY
Restore to different system. . .	N	Y=Yes, N=No

8. Type your choices for the *Devices* prompt. You can specify up to four device names. If you specify more than one device, the system automatically switches to the next device after it finishes reading the current save media.
9. Type your choice for the *Prompt for commands* prompt. Specify N (No) if you want to run an unattended restore. Specify Y (Yes) if you want to change the defaults on the RSTxxx commands.
10. Type your choice for the *Message Queue Delivery* prompt. The Message Queue Delivery prompt only applies if messages are sent to the QSYSOPR message queue. Specify \*NOTIFY if you want to do an unattended restore. This prevents communications messages from stopping the restore procedure. For example, messages that request a new volume to be loaded interrupt the restore operation because they are associated with the job, they have nothing to do with setting the delivery mode of the message queue. You cannot continue until you reply to these messages. Specify \*BREAK, if you want to be interrupted for severity 99 messages that are sent to xxxx that require a reply. Specify \*BREAK, if you want to be interrupted for severity 99 messages that require a reply.

11. Type your choice for the *Restore to different system* prompt. If you specify Y (Yes), the following values will be specified. The system requires these values in order to perform a system recovery to a different system or to a different logical partition.
  - SRM(\*NONE) will be specified on the RSTCFG command
  - ALWOBJDIF(\*ALL) will be specified on all the restore commands
  - MBROPT(\*ALL) will be specified on the RSTLIB command
12. Type your choice in the *Spooled file data* prompt. Specify \*NEW to restore spooled file data that was saved and does not already exist on the system. Specify \*NONE if you do not want to restore spooled file data.
13. After you type your choices, press the Enter key.
14. If you responded Y to the *Prompt for commands* prompt, you are shown the End Subsystem display. Type any changes and press the Enter key. While the system is ending subsystems, you see and respond to these messages:
  - a. CPF0994 ENDSBS(\*ALL) command being processed. Press the Enter key.
  - b. CPF0968 System ended to restricted condition. Press the Enter key.
 If you responded N to the *Prompt for commands* prompt, skip to step 16 on page 199.
15. When the system is ready to perform each major step in the restore process, you are shown the prompt display for that step. The time between displays may be quite long.
 

For option 21, you are shown these displays:

  - ENDSBS SBS(\*ALL) OPTION(\*IMMED)
  - RSTUSRPRF USRPRF(\*ALL)
  - RSTCFG OBJ(\*ALL)
  - RSTLIB SAVLIB(\*NONSYS)
  - RSTDLO DLO(\*ALL) SAVFLR(\*ANY)
  - RST DEV('/QSYS.LIB/media-device-name.DEVD') OBJ('//\*') ('/QSYS.LIB' \*OMIT) ('/QDLS' \*OMIT))
  - RSTAUT
  - STRSBS SBS(*controlling subsystem*)

For option 22 (System data only) you are shown these displays:

  - ENDSBS SBS(\*ALL) OPTION(\*IMMED)
  - RSTUSRPRF USRPRF(\*ALL)
  - RSTCFG
  - RSTLIB SAVLIB(\*IBM)
  - RST DEV('/QSYS.LIB/media-device-name.DEVD') OBJ('/QIBM/ProdData') ('/QOpenSys/QIBM/ProdData')
  - STRSBS SBS(*controlling-subsystem*)

For option 23 (All user data) you are shown these displays:

  - ENDSBS SBS(\*ALL) OPTION(\*IMMED)
  - RSTUSRPRF USRPRF(\*ALL)
  - RSTCFG
  - RSTLIB SAVLIB(\*ALLUSR)
  - RSTDLO DLO(\*ALL) SAVFLR(\*ANY)
  - RST DEV('/QSYS.LIB/media-device-name.DEVD') OBJ('//\*') ('/QSYS.LIB' \*OMIT) ('/QDLS' \*OMIT) ('/QIBM/ProdData' \*OMIT) ('/QOpenSys/QIBM/ProdData' \*OMIT))
  - RSTAUT
  - STRSBS SBS(*controlling-subsystem*)

Type your changes, if any, when the display is shown and press the Enter key.



**Note:** The RSTAUT command will run immediately after the RST commands when you use option 21 or option 23. **If you use option 22 only, you must run the RSTAUT command.** If you have additional restore operations to run, you may need to restore security data and restore authority again after those restore operations.

16. When the system sends a message asking you to load the next volume, load the next media volume and respond to the message.

**If a media error occurs...**

If an error occurs during the restore operation, see “Recovery from an Unsuccessful Restore Operation” on page 46.

If an unrecoverable error occurs when running the RSTDLO DLO(\*ALL) SAVFLR(\*ANY) command, see “Recovering from an Error While Restoring DLOs” on page 48.

17. If you used the distribution media to restore the operating system, some information was not restored. If you are restoring to a different system or different logical partitions, the network attributes may have been reset to the IBM-supplied defaults. You must create or change this information again. You should have lists of this information that were created at the time you performed your save operation.

The following may need to be created or changed:

- Configuration lists
  - Network attributes
  - Edit descriptions
  - Reply list entries
  - IBM-supplied subsystem descriptions
- a. For the configuration lists, do the following:  
Use the Work With Configuration Lists (WRKCFGL CFGL(\*ALL)) command to create the configuration lists to match the information in your list.
  - b. For network attributes, do the following:  
Use the Change Network Attributes (CHGNETA) command to change the network attributes to match the information in your list.
  - c. For edit descriptions, do the following:  
Use the Work with Edit Descriptions (WRKEDTD EDTD(\*ALL)) command to create edit descriptions to match the information in your list.
  - d. For reply list entries, do the following:  
Use the Add Reply List Entry (ADDRPYLE) command to add reply list entries to match the information in your list.
  - e. For IBM-supplied subsystem descriptions, do the following:  
Use the Work with Subsystem Descriptions (WRKSBSD SBSDB(\*ALL)) command to change the IBM-supplied subsystem descriptions to match the information in your list.

18. If you need to restore independent ASPs, see “How to Recover an Independent ASP” on page 187. Skip this step if you use “Recovering your entire system after a complete system loss including independent ASPs–Checklist 21” on page 88.

19. This completes the restore operation.

20. If you are unsure what the QSECOFR password is, change it now. To see if the password has expired, type the following:

```
DSPUSRPRF QSECOFR
```

The passwords from your save media are now the current passwords. If the password expiration is active for the QSECOFR user profile, you will see the expiration date on the Date password expired field. If the date is the current system date or prior, change the password for the QSECOFR user profile.

21. Check the job log to ensure all objects were restored.

The job log contains information about the restore operation. To verify that all objects were restored, you should spool the job log for printing, along with the job's remaining spooled output, if any.

```
DSPJOBLOG * *PRINT
```

or

```
SIGNOFF *LIST
```

Message CPC3703 is sent to the job log for each library that was successfully restored. Message CPF3773 is sent to tell you how many objects were restored. It also tells you how many objects were not restored. Objects are not restored for various reasons. Check for any error messages, correct the errors, and then restore those objects from the media.

---

## Chapter 9. How to Restore Specific Types of Information

This chapter describes procedures for restoring particular types of information on the system. It also describes considerations when you restore particular types of information, whether you restore the information by using menu options or commands. The topics are presented in the same order as the recovery operations should occur.

---

### Recovering System Information

You can customize some system information, such as edit descriptions and network attributes. When you run the SAVSYS command this system information is saved. It cannot be saved separately.

If you have SAVSYS media and need to restore system information, follow the procedure that is described in Chapter 5, "Restoring the Operating System." Do an **abbreviated** installation of the operating system.

If you have restored your operating system from distribution media, you need to reconstruct system information. Printing system information describes how to print the system information. Find the most recent listings you have. Table 43 shows the commands for changing the system information to the correct values:

*Table 43. Commands for Changing System Information*

Information Type	Command
Access path recovery times <sup>1</sup>	EDTRCYAP
Configuration lists	WRKCFGL
Edit descriptions	WRKEDTD
IBM-supplied subsystem descriptions	WRKSBSD
Network attributes	CHGNETA
Reply list entries	ADDRPYLE
Service attributes	CHGSRVA
System values	WRKSYSVAL

---

<sup>1</sup> When you reset your access path recovery times, ensure that the ASP configuration matches the configuration at the time that you printed the recovery times. If it does not, make a note to reset your access path recovery times after ASP configuration.

---

---

### Sequence for Restoring Security Information

Security information on your system consists of:

- User profiles and group profiles
- Authorization lists
- Authority holders
- Authority information that is stored with objects:
  - Owner
  - Owner authority
  - Primary group
  - Primary group authority
  - Public authority
  - Authority list

- Private authorities

**It is essential that you restore security information in the correct sequence.** Otherwise, object ownership and authority information is not restored correctly and your applications may not run correctly. The recovery checklists include the correct sequence of steps for restoring security information. If you are developing your own restore procedure, restore security information in the following sequence:

1. Restore user profiles. The user profile that owns an object must exist before the object can be restored. If you restore all user profiles (RSTUSRPRF USRPRF(\*ALL)), you also restore authorization lists and authority holders. Authorization lists and authority holders must also be on the system before you restore objects.
2. Restore objects. This restores ownership and the authority information is stored with the object.
3. Restore authority. This restores users' private authorities to objects.

---

## Restoring User Profiles

You can restore a single user profile, a list of user profiles, or all user profiles. You restore a user profile to move a user from one iSeries server to another iSeries server and to recover a damaged user profile.

You can use the \*NEW value on the USRPRF parameter to restore only user profiles that are new to your system. If you choose to restore individual user profiles, you can specify SECDDTA(\*PWDGRP) to restore passwords and group connections. These values are useful if you are merging user profiles from multiple systems onto a single system.

You may also find the \*NONE value beneficial if you only want to restore the data needed to verify signatures, and not all of the actual user profiles.

The OMITUSRPRF parameter allows you to limit the number of user profiles you restore. You can specify a list of up to 300 specific or generic user profile values that will not be restored. This value is helpful if you are restoring a subset of user profiles.

The SAVASPDEV parameter allows you to limit the private authorities that are restored based on auxiliary storage pools.

**Note:** You cannot delete an IBM-supplied user profile if it is damaged. You must restore the operating system again by way of an abbreviated install to recover a damaged IBM-supplied user profile.

*Table 44. How User Profiles Are Restored*

Method	Restricted State?
RSTUSRPRF command <sup>1,3</sup>	No
Restore menu option 8 <sup>1,3</sup>	No
Restore menu option 21 <sup>1,2</sup>	Yes
Restore menu option 22 <sup>1,2</sup>	Yes
Restore menu option 23 <sup>1,2</sup>	Yes

<sup>1</sup> You must have \*SAVSYS special authority. You must have \*ALLOBJ special authority to specify a value other than \*NONE on the ALWOBJDIF parameter.

<sup>2</sup> These menu options restore all user profiles.

<sup>3</sup> You need to put the system in a restricted state if you specify USRPRF(\*ALL).

### *Do This to Restore All User Profiles*

1. Sign on as QSECOFR.
2. Ensure the system is in a restricted state. See "Putting Your System in a Restricted State" on page 35.

3. Find the most recent media volume that has your user profiles. It may be a SAVSYS volume or a SAVSECDTA volume. The name of the file on the media volume is QFILEUPR.

4. If you are using a SAVSYS media volume, type:

```
RSTUSRPRF DEV(media-device-name) USRPRF(*ALL)
          ENDOPT(*LEAVE)
```

If you are using a SAVSECDTA media volume, type:

```
RSTUSRPRF DEV(media-device-name) USRPRF(*ALL)
          ENDOPT(*UNLOAD)
```

## What Happens When You Restore User Profiles

When you restore a user profile, you restore all the attributes of the profile that you see on the Display User Profile display. The system builds a working table that holds that user's private authorities to objects. You must use the Restore Authority (RSTAUT) command to restore the user's private authorities. (See "Restoring Object Authorities" on page 206.) If you specify SECDTA (\*PVTAUT), then only the working tables that hold the user's private authorities are restored. The user profiles themselves are not restored.

Some values in a user profile may be changed when it is restored. Table 45 on page 204 shows the actions the system takes when you restore user profiles:

Table 45. Results of Restoring User Profiles

User Profile Attributes	Restore Procedure Used		
	Restore *ALL User Profiles	Restore Individual User Profile That Already Exists on System	Restore Individual User Profile That Does Not Exist on System
Group profile (GRPPRF)	Value is restored from media	Value on system is not changed <sup>1</sup>	Value is set to *NONE <sup>1</sup>
Owner (OWNER) of new objects	Value is restored from media	Value on system is not changed	Value is set to *USRPRF
Group authority (GRPAUT) to new objects	Value is restored from media	Value on system is not changed <sup>1</sup>	Value is set to *NONE <sup>1</sup>
Password	Value is restored from media	Value on system is not changed <sup>1</sup>	Value is set to *NONE <sup>1</sup>
Document Password	Value is restored from media	Value on system is not changed <sup>1</sup>	Value is set to *NONE <sup>1</sup>
Date password was last changed	Value is restored from media	Value on system is not changed <sup>1</sup>	The current date is used.
Owner of user profile	See "How the System Establishes Ownership for Restored Objects" on page 206.	Value on system is not changed	Value is restored from the media. If the owning profile does not exist, ownership is assigned to the QDFTOWN user profile.
Primary group of user profile	See "How the System Establishes the Primary Group for Restored Objects" on page 206	Value on system is not changed.	Value is restored from the media. If the primary group does not exist, the value in the user profile is set to *NONE.
*ALLOBJ special authority	See "What You Should Know About Restoring User Profiles."	See "What You Should Know About Restoring User Profiles."	See "What You Should Know About Restoring User Profiles."
User identification number (UID)	Results depend upon whether the user profile already exists on the system or not at the time it is restored. Actions are the same as for individual user profiles.	Value on system is not changed.	Value is restored from the media unless it is a duplicate of a UID on the system. In that case, a new UID is generated.
Group identification number (GID)	Results depend upon whether the user profile already exists on the system or not at the time it is restored. Actions are the same as for individual user profiles.	Value on system is not changed.	Value is restored from the media unless it is a duplicate of a GID on the system. In that case, a new GID is generated.

<sup>1</sup> If you specify SECDTA (\*PWDGRP) the value is restored from media.

## What You Should Know About Restoring User Profiles

When you are restoring user profiles from a source system to a target system, you must make sure that the password level values (QPWDLVL) are compatible. For example, restoring a user profile from the source system with a password value of 2 may result in an invalid password on the target system with a password value of 0 or 1. Password level 2 allows more characters than password level 0 or 1.

Keep these things in mind when you restore user profiles:

**Restoring All Profiles:** When you restore all profiles, the system does not first delete all profiles, authorization lists, and authority holders on the system. Therefore, the result is both of the following:

- All the profiles, authorization lists, and authority holders on the media.
- Any profiles, authorization lists, and authority holders on the system that were not on the save media.

Restoring all profiles is the only way to restore authorization lists and authority holders. However, if an authorization list secures an object in library QSYS, the association between the authorization list and the object is not restored automatically. This is because the objects in QSYS library are restored before the authorization lists. In other words, the object stores the name of the authorization list it is associated with, and the authorization lists are stored with the user profiles. Since QSYS is restored before the RSTUSRPRF command executes, the authorization list is not on the system at the time the object in QSYS is restored. The IBM publication, *An Implementation Guide for iSeries Security and Auditing*, contains sample programs (ALLAUTL and FIXAUTL) that can be used to attach authorization lists to the objects in library QSYS when the authorization lists are restored. ALLAUTL must be run before the operating system is restored or reinstalled in order to create a database of the objects secured by authorization lists. FIXAUTL must run afterwards to re-establish the links. These programs may need to be modified to meet your own requirements.

#### Security Note

If the IBM-supplied user profiles have the default passwords on your save media, they will again have default passwords after you restore. This is a security exposure. After a restore operation, verify that the IBM-supplied user profiles do not have the default passwords.

**Restoring \*ALLOBJ Special Authority:** \*ALLOBJ special authority is removed from user profiles being restored to a system at security level 30 or higher in either of these situations:

- The profile was saved from a different system, and the person doing the restore does not have \*ALLOBJ and \*SECADM authority.
- The profile was saved from the same system or a different system at security level 10 or 20.

The systems keeps \*ALLOBJ special authority for the following system user profiles:

- QSYS
- QSECOFR
- QLPAUTO
- QLPINSTALL

**Moving Users to Another System:** To transfer user profiles and their authorities to another system, do the following:

1. Save the user profiles and authorities by using the SAVSECDTA command.
2. Save the owned objects.
3. Restore the user profiles by using RSTUSRPRF USRPRF(\*ALL) ALWOBJDIF(\*ALL).

**Note:** You may want to consider using the USRPRF(\*NEW) parameter to restore only user profiles which do not currently exist on the target system. Also, you can omit profiles that you do not want to restore with the OMITUSRPRF command.

4. Restore the needed objects by using the RSTLIB, RSTOBJ, RST, or RSTDLO commands by specifying ALWOBJDIF(\*ALL).
5. Restore the private authorities of the user profiles by using the RSTAUT command.

Chapter 14, “Release-to-Release Support,” on page 299 provides more information about moving objects between systems running different releases of the operating system. The *iSeries Security Reference* book provides more information about these security features.

## How the System Establishes Ownership for Restored Objects

Most objects on the system have an owner. The exception to this is objects in the QNTC and QNetWare file systems because most PC applications do not have a concept of object ownership.

When you restore an object, the system determines what profile owns the restored object by using the following rules:

- Ownership is restored to that profile if the profile that owns the object is on the system.
- If the owner profile does not exist on the system, ownership of the object is given to the QDFTOWN (default owner) user profile.
- If the object exists on the system and the owner on the system is different from the owner on the save media, the object is not restored unless ALWOBJDIF(\*ALL) is specified. In that case, the object is restored and the owner on the system is used.
- See “How the System Restores Programs” on page 241 for additional considerations when restoring programs.

## How the System Establishes the Authorization List for a Restored Object

Table 46 shows what happens when you restore an object that already exists if the object is linked to an authorization list. These rules do not apply when you are restoring a document or a folder.

Table 46. Restoring an Object Linked to an Authorization List

Authorization List on System and Media	Value of ALWOBJDIF Parameter	Result
Same	Any	Data restored; link to authorization list not changed.
Different	*NONE	Object is not restored
Different	*ALL	Data restored; linked to authorization list associated with existing object.

## How the System Establishes the Primary Group for Restored Objects

Many objects on the system have a primary group. When you restore an object, the system determines the primary group for the object by using the following rules:

- If the profile that is the primary group for the object is on the system, that profile is the primary group for the object.
- If the profile that is the primary group for the object is not on the system, the primary group is set to \*NONE. Message CPI380E is sent to the job log.
- If the object exists on the system and the primary group on the system is different from the primary group on the save media, the system does not restore the object unless you specify ALWOBJDIF(\*ALL). In that case, the system restores the object with the primary group on the system.

## Restoring Object Authorities

Restoring a user’s private authorities to objects is a separate task from restoring user profiles. When you restore user profiles, the system builds authority reference tables for each user profile that you restore. The authority reference tables temporarily hold the user’s private authorities to objects.

Possible Method	Restricted State?
RSTAUT command <sup>1</sup>	No
Restore menu option 21 <sup>1</sup>	Yes
Restore menu option 22 <sup>1</sup>	Yes



Possible Method	Restricted State?
Restore menu option 23 <sup>1</sup>	Yes
<sup>1</sup> You must have *SAVSYS special authority.	

## Overview of Restoring Authorities

When you run the Restore Authority (RSTAUT) command, the system restores authority for each user you specify. You can restore authority for a specific user profile, a list of specific user profiles, or all user profiles. If you restore authority for all users, the RSTAUT command restores authority by using every authority reference table it finds on the system. If you restore a single user profile to the system because it was damaged, deleted, or is being moved from another system, you can also use RSTAUT and specify that profile name to restore authorities for that user profile.

When you run RSTAUT USRPRF(\*ALL), you will receive status message CPI3821 informing you of the current number of user profiles for which restore authority is complete after each authority reference table is processed.

You may run the RSTAUT command regardless of whether or not a system is in a restricted state. However, there are differences between running RSTAUT on systems in a restricted state and running RSTAUT on systems in a non-restricted state. These differences include system performance, job log appearance, and object availability. More information is provided below.

**Note:** The system saves and restores authorities differently for objects in the QNTC and QNetWare file systems. The system saves and restores all authorities, including private authorities, with the object. “Completing Recovery for the IBM iSeries Integration for Windows Server Product” on page 250 provides more information.

Restoring authorities should be the last thing you do before performing an IPL, in a recovery. If you restore authorities and accept the default parameter for RSTAUT SAVASPDEV(\*ALLAVL), but you still have additional restore operations to perform, you may need to restore security data and restore authority again after the additional restore operations.

You can also restore authority for a specific profile or a list of profiles. For example, if you have restored a single user profile to the system because it was damaged, you can also use the RSTAUT command and specify that profile name.

## Restoring Authority on a System in a Non-restricted State

The RSTAUT command uses prestared jobs in order to process more than one user’s authorities at a time. The prestared jobs that are used by RSTAUT use subsystem description QSYSWRK in library QSYS, program QSRRATBL in library QSYS, and class QINTER in library QGPL.

There are several advantages to running the RSTAUT command on a system in a non-restricted state. These advantages include the following:

- Because more than one user’s authority reference tables are being processed at a time, the RSTAUT command on a system in a non-restricted state is up to 30% faster in most cases than the same command on a system in a restricted state. Generally, the more user profiles for which RSTAUT is being run, the greater the performance gain for the RSTAUT command overall.
- Subsystems do not have to be terminated when one or more user profiles are restored without a full system recovery.
- Authority reference tables are not always deleted after RSTAUT is run for a user profile. If all private authorities are successfully granted or an abnormal error occurs then the authority reference table is deleted. Authority reference tables are also deleted if you create a data area named QSRCLRAUTS and it exists in the library list. However, if some of the private authorities are not granted for any reason

such as 'object not found' or 'object in use', then the entries for those private authorities that were not granted are kept in the authority reference table, and the RSTAUT command may be run again for the user profile to try granting the failed private authorities before the next restore of the user profile.

There are also some limitations to running the RSTAUT command on a system in a non-restricted state. These limitations include the following:

- Because the system is not in a restricted state, all objects must be locked by RSTAUT. This means that several objects could be in use during the processing of any authority reference table. If the RSTAUT command is unable to lock an object, a diagnostic message of CPF3736 or CPD3776 will be sent to the job log of the prestarted job for each object that could not have authority granted. This is most likely to occur when the object is a user profile or a message queue. Since private authorities that are not granted are kept in the authority reference table, the RSTAUT command may be run again to grant authorities to objects that were in use.

You may also receive CPD3776 if you use a product that has objects or directories with the "Allow save" attribute set to "No." If this scenario is true, then the CPD3776 messages can be ignored. See information APAR II13660 for more information about products that mark objects and directories not-saveable.

- If you are running RSTAUT for a large group of user profiles that have private authorities to the same few objects, it is recommended that you put the system in a restricted state before running the RSTAUT command. This will minimize the number of objects in use and consequently minimize the number of objects that are found locked by the RSTAUT command.
- Only one RSTAUT command may be run on a system at a time.

## What You Should Know Before Running RSTAUT

There are some general facts you should be aware of when running RSTAUT on a system in a non-restricted state.

- This command may take a long time depending on how many private authorities that you have on your system.
- During system recovery, you should not start all subsystems and allow all users to sign on and use the system while RSTAUT is being run. The only subsystem that is needed to run RSTAUT in a non-restricted state is QSYSWRK. Allowing all users access to the system before RSTAUT completes may cause many more objects to be locked, preventing a larger number of the private authorities from being restored.
- All private authorities for all authority reference tables that are processed by one prestarted job may or may not be successfully regranted. If they are regranted, then the message logging level that is used for that prestarted job will be the same as the logging level that is used by the user's main job.

If one or more private authorities for an authority reference table are not successfully regranted, then LOG(\*SECLVL) will be used for the message logging for that prestarted job.

For example, you could run the RSTAUT command with the system default logging level of LOG(4 0 \*NOLIST). All prestarted jobs that are run by RSTAUT that have all private authorities regranted successfully will use the LOG(4 0 \*NOLIST) message logging level. The job log will not remain on the system after the prestarted job completes. All prestarted jobs that are run by RSTAUT, that have one or more private authorities that are not regranted, will instead use the LOG(4 0 \*SECLVL) logging level. The job log will remain on the system after the prestarted job completes.

- Do not cancel any of the prestarted jobs RSTAUT has started. Doing so will cause the entire RSTAUT command to cancel, similar to cancelling a RSTAUT command on a restricted state system.
- One user's authority reference tables are always processed by a single prestarted job.
- If the authority reference tables are small, one prestarted job may process more than one user's authorities.

Subsystem QSYSWRK must be started in order for the prestarted jobs to start. The RSTAUT command will start several prestarted jobs at once, and assign the restore of authorities for one or more user

profiles to each of the prestarted jobs. During the RSTAUT command, when the prestarted jobs are running, an entry will appear for each prestarted job on the Work with Active Jobs screen.

```

Work with Active Jobs                                MYSYSTEM
05/01/97 16:02:05
CPU %: 26.5    Elapsed time: 00:00:31    Active jobs: 94

Type options, press Enter.
 2=Change  3=Hold  4=End  5=Work with  6=Release  7=Display message
 8=Work with spooled files  13=Disconnect ...

Opt  Subsystem/Job  User      Type  CPU %  Function  Status
---  -
---  QSYSWRK        QSYS      SBS   .1     DEQW      DEQW
---  QSRRTATBL      QUSER     PJ    1.2    RUN       RUN
---  QSRRTATBL      QUSER     PJ    1.0    RUN       RUN

```

If subsystem QSYSWRK is active but the prestarted jobs cannot be started for any reason, you should receive messages in your job log, including escape message CPF386D, stating why the prestarted jobs could not be started.

### Job Log Considerations

The job logs that are generated by a RSTAUT command running on a system in a non-restricted state are significantly different than those for a system in a restricted state. When the RSTAUT command runs on a system in a restricted state, one job log is generated. When the RSTAUT command runs on a system in a non-restricted state, each prestarted job (run by RSTAUT) generates a job log that contains some of the information that is found in the single job log that is produced on a system running in a non-restricted state. If only one user profile is being restored, only one job log is produced.

You may encounter a situation where job logs that contain diagnostic messages from prestarted jobs that ran during the RSTAUT get deleted. If this occurs, you can rerun the RSTAUT command at any time before running another RSTUSRPRF command or RCLSTG command. The system will attempt to regrant the failed private authorities, and will generate new job logs.

Figures 10 through 12 show a sample job log and message information for a RSTAUT USRPRF(QPGMR) command run on a system in a restricted state.

```

>RSTAUT USRPRF(QPGMR)
Authority not restored for user QPGMR.
Some authorities not restored for user profile QPGMR.
Not all user profiles had all authorities restored.

```

Figure 10. Sample Job Log for RSTAUT on a System in a Restricted State

The expanded text for message CPF3736 appears as follows:

Additional Message Information

Message ID.....: CPF3736           Severity.....: 20  
Message type....: Diagnostic  
Date sent .....: 04/24/97    Time sent.....: 19:35:17

Message....: Authority not restored for user QPGMR.  
Cause.....: Private authority for DTAARA DTAARA1 in library QGPL was  
not restored. Either the object does not exist, is damaged, or was not  
available at the time authority was being granted.

Recovery....:

Do one of the following:

--If the system was dedicated while the RSTAUT command was running,  
display the description of the object (DSPOBJD command). If the object was  
damaged or not found, restore the user profile (RSTUSRPRF command), restore  
the object (RSTOBJ command), and restore the authorizations (RSTAUT command).  
If the object exists and is not damaged, report the problem (ANZPRB command).

*Figure 11. Expanded Text for Message CPF3736*

The expanded text for message CPF3845 appears as follows:

Additional Message Information

Message ID.....: CPF3845           Severity.....: 20  
Message type....: Diagnostic  
Date sent .....: 04/24/97    Time sent.....: 19:35:17

Message....: Some authorities not restored for user profile QPGMR.  
Cause.....: 1434 authorities were restored and 1 authorities were not  
restored for user profile QPGMR at 04/24/97 19:21:36.

The prestart job name used to restore private authorities for this user  
profile is \*N. The prestart job name that contains messages about  
authorities not restored is \*N.

--If the job name above is \*N then a prestart job was not used to restore  
authorities for this user profile.

--If a job name other than \*N is listed above, then a prestart job was  
used to restore private authorities for this user profile and messages may  
be found in the joblog for the job name listed. Use one of the following  
commands to display the joblog for the prestarted job:

*Figure 12. Expanded Text for Message CPF3845*

In the case of a system in a restricted state, all messages appear in the user's main job log. When the name of the prestarted job that is used in message CPF3845 is \*N, then no prestarted job was used.

Figures 13 and 14 show a sample job log message information for a RSTAUT USRPRF(QPGMR QUSR) command run on a system in a non-restricted state.

```
>RSTAUT USRPRF(QPGMR QUSR)
Start of prestart jobs in progress.
Some authorities not restored for user profile QPGMR.
Private authorities restored for user profile QUSR.
End of prestart jobs.
Not all user profiles had all authorities restored.
```

*Figure 13. Sample Job Log for RSTAUT on a System in a Non-restricted State*

The expanded text for message CPF3845 appears as follows:

#### Additional Message Information

```
Message ID.....: CPF3845          Severity.....: 20
Message type....: Diagnostic
Date sent .....: 04/24/97       Time sent.....: 19:35:17

Message.....: Some authorities not restored for user profile QPGMR.
Cause.....: 1433 authorities were restored and 2 authorities were not
restored for user profile QPGMR at 04/24/97 19:21:36.
  The prestart job name used to restore private authorities for this user
  profile is 010648/QUSER/QSRRATBL. The prestart job name that contains
  messages about authorities not restored is 010648/QUSER/QSRRATBL.
  --If the job name above is *N then a prestart job was not used to restore
  authorities for this user profile.
  --If a job name other than *N is listed above, then a prestart job was
  used to restore private authorities for this user profile and messages may
  be found in the joblog for the job name listed. Use one of the following
  commands to display the joblog for the prestarted job:
```

*Figure 14. Expanded Text for Message CPF3845*

In figure 14, the name of the prestarted job used is 010648/QUSER/QSRRATBL, and it appears in the CPF3845 message. The CPF3736 message for the data area DTAARA1 in library QGPL whose authority was not restored, does not appear in the user's main job log. Instead, all messages that are related to restoring of individual private authorities are in the job log for the prestarted job. To view these messages, you would run the command `DSPJOB JOB(010648/QUSER/QSRRATBL)`, and then select option 4 to view the job log for the prestarted job. The expanded message text for CPF3736 appears in that job log.

You should pay special attention to any CPF3845 message that states that \*N authorities were not restored. This may indicate a problem such as damaged objects or a function check. Any CPF3845 message with \*N authorities that are not restored should be investigated further by checking the job log of the prestarted job that is named.

If all authorities in an authority reference table were restored successfully, then message CPC3706 is sent for the user profile instead of CPF3845. CPC3706 will also contain the name of the prestarted job that is used to restore authorities for the user profile. If all authorities restored from a prestarted job were restored successfully, then the job log for the prestarted job will contain only job start and end messages.

The order of CPC3706 and CPF3845 messages depends on whether you run the RSTAUT command on a system that is in a restricted or non-restricted state. These messages are for user profiles with restored private authorities. The order of these messages is as follows:

#### **Restricted state system**

The order will generally be alphanumeric because only one authority table is being restored at a time, in alphanumeric order

#### **Non-restricted state system**

The order will generally be that these messages will appear first for the user profiles with fewer private authorities, then later for the user profiles with many private authorities. This is because multiple authority reference tables are being restored at once and the smaller authority reference tables usually complete first.

## **Restoring Authority on a System in a Restricted State**

The RSTAUT command on a system running in a restricted state restores authorities for each authority reference table, one table at a time. No prestarted jobs are used.

When processing is complete for an authority reference table, the table is deleted regardless of whether all private authorities were successfully restored or not.

## What the System Does When You Restore Authority

When you run the RSTAUT command, the system grants all the private authorities that it finds in each authority reference table. The user's private authorities after the command are both of the following:

- The authorities from the temporary authority reference table.
- Any authorities that are granted to the user since the save operation.

*How the System Restores Authority—Example 1:* Assume that the authority to PRICES looks like this at the time of the save operation:

```
Display Object Authority
Object . . . . . : PRICES      Owner . . . . .
Library . . . . . : CONTRACTS  Primary group .
Object type . . . . : *FILE
Object secured by authorization list . . . . .

User      Group      Object
OWNCP          Authority
DPTSM          *ALL
DPTMG          *CHANGE
WILSONJ        *CHANGE
*PUBLIC        *USE
               *EXCLUDE
```

**Note:** Your display looks different when your user profile has a user option setting of \*EXPERT.

After you save security information, you grant and revoke several authorities to the PRICES file. Just before the restore operation, the authority looks like this:

```
Display Object Authority
Object . . . . . : PRICES      Owner . . . . .
Library . . . . . : CONTRACTS  Primary group .
Object type . . . . : *FILE
Object secured by authorization list . . . . .

User      Group      Object
OWNCP          Authority
DPTSM          *ALL
DPTMG          *USE
WILSONJ        *USE
ANDERSP        *CHANGE
*PUBLIC        *EXCLUDE
               *EXCLUDE
```

If authority is restored for all users, the authority to the PRICES file looks like this:

```

Display Object Authority
Object . . . . . : PRICES      Owner . . . . .
Library . . . . . : CONTRACTS  Primary group .
Object type . . . . : *FILE

Object secured by authorization list . . . . .

User      Group      Object
OWNCP          *ALL
DPTSM         *CHANGE
DPTMG         *CHANGE
WILSONJ       *USE
ANDERSP       *USE
*PUBLIC       *EXCLUDE

```

Authorities for DPTSM and WILSONJ are restored to the values they have on the save media. The authority for ANDERSP remains, even though it did not exist on the save media.

*How the System Restores Authority—Example 2:* Assume that the authority for the PRICES file looks like this just before the restore operation:

```

Display Object Authority
Object . . . . . : PRICES      Owner . . . . .
Library . . . . . : CONTRACTS  Primary group .
Object type . . . . : *FILE

Object secured by authorization list . . . . .

User      Group      Object
OWNCP          *ALL
DPTMG         *CHANGE
WILSONJ       *CHANGE
*PUBLIC       *USE

```

If authority is restored for all users, the authority to the PRICES file looks like this:

```

                                Display Object Authority
Object . . . . . : PRICES          Owner . . . . .
Library . . . . . : CONTRACTS      Primary group .
Object type . . . . : *FILE

Object secured by authorization list . . . . .

User      Group      Object
OWNCP     Group      Authority
DPTSM     *ALL
DPTSM     *CHANGE
DPTMG     *CHANGE
WILSONJ   *CHANGE
*PUBLIC   *USE

```

Notice that WILSONJ still has \*CHANGE authority. The authority from the save media (\*USE) is granted to WILSONJ, but the authority WILSONJ already has is not revoked. \*USE authority is added to \*CHANGE authority, so WILSONJ has \*CHANGE authority.

Notice also that \*PUBLIC authority is not affected by this process. Public authority is stored with the object and is handled when the object is restored. If public authority on the system is different from public authority on the save media, the public authority on the system is used.

Authority is restored to the object with the same name in the same library. In some cases, this could result in restoring authority to a different object.

If you restore authorities for an independent ASP, you can use the SAVASPDEV to limit the authorities that you restore. For example, you can limit the authorities to a specific independent ASP, or an ASP group. Authority is restored to the object with the same name in the same library and the same independent ASP, unless you specify another value for the RSTASPDEV parameter. A user will have separate authority reference tables for each independent ASP to which he is authorized.

Assume that you delete program PGMA in library CUSTLIB. You create a new program with the same name but different function. If you restore authority, users who were authorized to the original PGMA are now authorized to the new PGMA. See "How the System Restores Programs" on page 241 for more information.

---

## Restore authorities for independent ASP data

Restore authority for an independent ASP based on the following methods:

**Note:** These four scenarios are examples of the most common restore options.



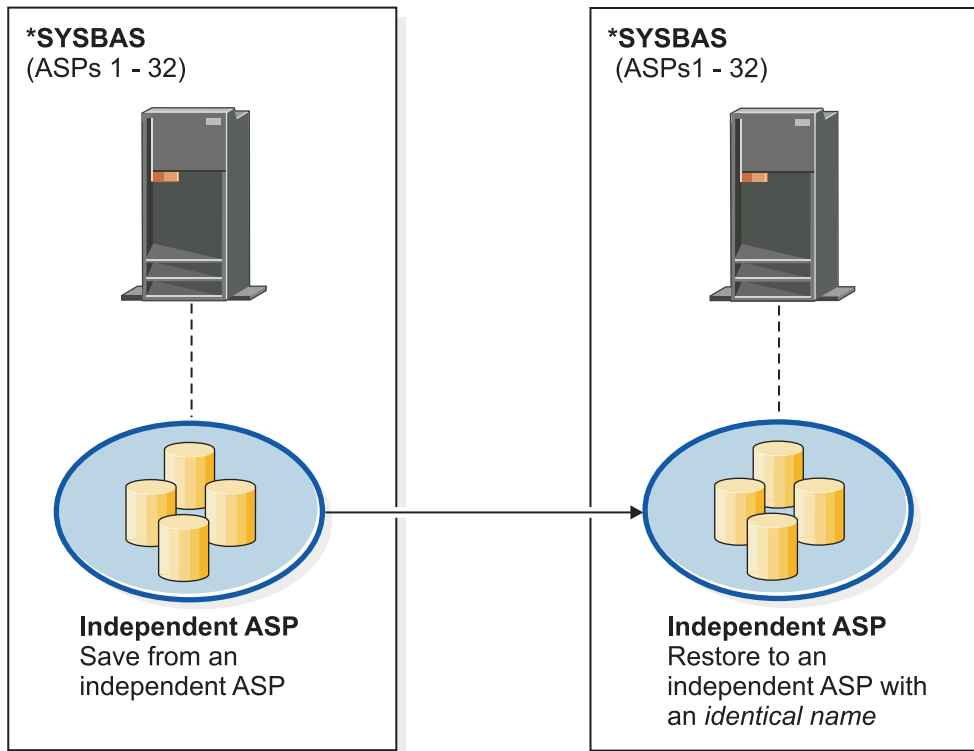

basicbr501-0

To restore authorities for data that was saved from an independent ASP and will be restored to an independent ASP with an identical name use this command:

RSTAUT

Figure 15. Save from an independent ASP and restore it to an independent ASP with an identical name.

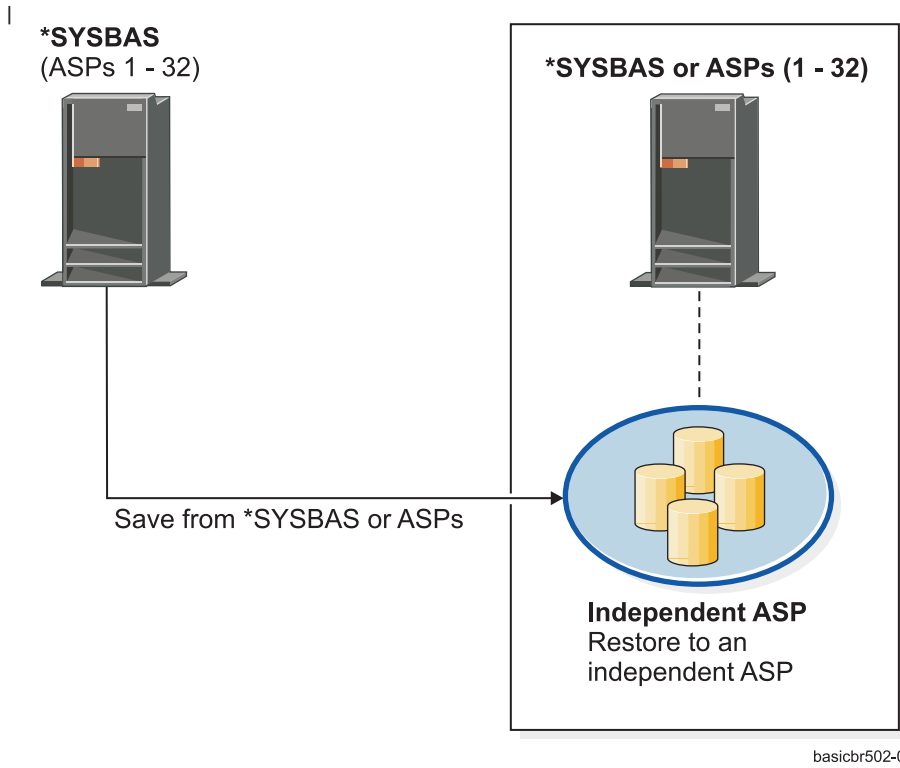

To restore authorities for data that was saved from \*SYSBAS and will be restored to an independent ASP use this command:

```
RSTAUT SAVASPDEV(*SYSBAS) RSTASPDEV(IASPABC)
```

Figure 16. Save from \*SYSBAS and restore it to an independent ASP.

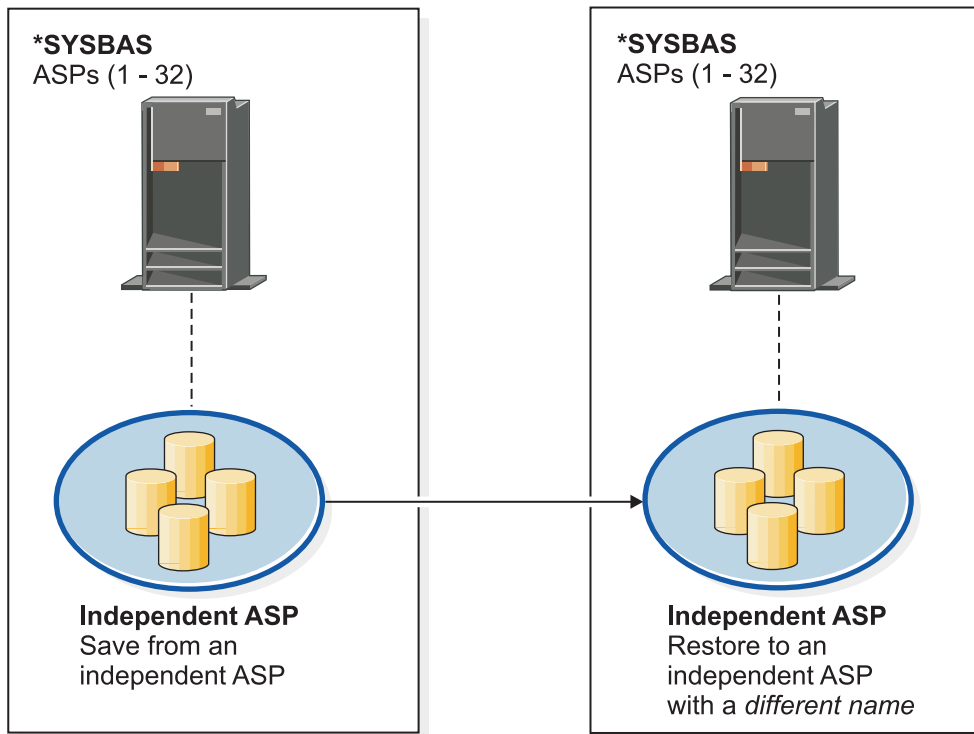

basicbr503-0

To restore authorities for data that was saved from an independent ASP and will be restored to an independent ASP with a different name use this command:

```
RSTAUT SAVASPDEV(IASPABC) RSTASPDEV(IASPXYZ)
```

Figure 17. Save from an independent ASP and restore it to an independent ASP with a different name.

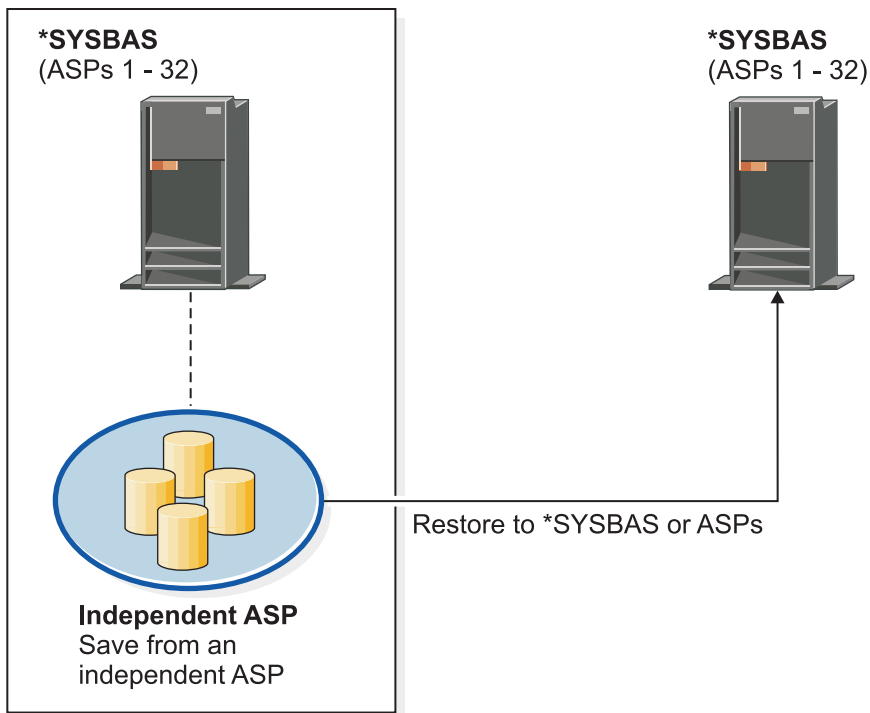

basicbr504-0

To restore authorities for data that was saved from an independent ASP and will be restored to \*SYSBAS use this command:

When restoring private authorities to integrated file system objects which have been migrated from a unmounted UDFS in an IASP to \*SYSBAS, additional recovery steps are needed.

1. Repeat these steps for each UDFS that was migrated from an IASP to \*SYSBAS:

a. Create a directory structure

```
'/QSR/MOUNTALL/iasp-name/udfs-name.udfs'
```

*iasp-name* was the name of the IASP that held the UDFS. *udfs-name.udfs* was the name of the unmounted UDFS, when the private authorities were saved.

b. Mount the UDFS which was restored to \*SYSBAS over the directory that was created.

```
MOUNT TYPE(*UDFS) MFS('/DEV/QASPxx/new-udfs-name.udfs')
MNTOVRDIR('/QSR/MOUNTALL/iasp-name/udfs-name.udfs')
```

QASPxx is the \*SYSBAS ASP that is located in the new UDFS. *new-udfs-name.udfs* is the new UDFS name.

2. RSTAUT SAVASPDEV(*iasp-name*) RSTASPDEV(\*SYSBAS)

Figure 18. Save from an independent ASP and restore it to \*SYSBAS.

## How to Restore Configuration Objects

You can restore:

- All configuration objects
- A group of configuration objects by generic name
- Only specific types of configuration objects, such as line descriptions or connection lists.
- System resource management information

A configuration object must be varied off before you can restore it.

If you execute the restore configuration (RSTCFG) command against a printer device description and the output queue associated with that device description contains zero spooled files, the system will recreate the output queue. Any changes made to the output queue prior to the RSTCFG will be lost.

*Table 47. How Configuration Objects Are Restored*

Possible Method	Restricted State?
RSTCFG command <sup>1</sup>	No
Restore menu option 7	No
Restore menu option 21	Yes
Restore menu option 22	Yes
Restore menu option 23	Yes

<sup>1</sup> You must have \*ALLOBJ special authority to specify ALWOBJDIF(\*ALL)

#### **Do This to Restore All Configuration Objects:**

1. Find the most recent media volume that has your configuration. It may be a SAVSYS volume or a SAVCFG volume. The name of the file on the volume is QFILEIOC.

2. If you are using a SAVSYS media volume, type:

```
RSTCFG OBJ(*ALL) DEV(media-device-name)
        OBJTYPE(*ALL)
        ENDOPT(*LEAVE)
```

If you are using a SAVCFG media volume, type:

```
RSTCFG OBJ(*ALL) DEV(media-device-name)
        OBJTYPE(*ALL)
        ENDOPT(*UNLOAD)
```

#### **Restoring to a Different System?**

You must specify ALWOBJDIF(\*ALL) when you restore the configuration to a different system. (An option is available on the restore menu that indicates that you are restoring to a different system or different logical partitions. If you selected this option, the system automatically specifies ALWOBJDIF(\*ALL) for you.)

The restoring of configuration objects to a different system whose configuration objects exist overlays the existing configuration. In some cases, the configuration description may not match the hardware on the system.

Do not restore system resource management objects to another system. This may cause problems that can be fixed only by a service representative. When you use the RSTCFG command to another system, specify SRM(\*NONE).

## **Correcting Problems with the System Resource Management Information**

The system resource management (SRM) information provides a link between the hardware on your system and the software descriptions of that hardware (the configuration). When you restore your configuration to a different system, you should not restore the SRM information because it will not match the hardware on the target system. Sometimes during a system upgrade, you are instructed to restore the SRM information to your system even though some of your hardware has changed.

If you have restored the SRM information and the hardware configuration does not match, use the following procedure to correct the SRM information:

1. Type STRSST and press the Enter key to access System Service Tools.
2. Select Option 1 (Start a service tool) from the System Service Tools menu and press Enter.
3. Select Option 7 (Hardware service manager) from the Start a Service Tool menu and press Enter.
4. Select Option 2 (Logical hardware resources) from the Hardware Service Manager menu and press Enter.
5. Select Option 1 (System bus resources) from the Logical Hardware Resources menu and press Enter.
6. Select F10 (Non-reporting resources) to display any non-reporting resources. Any hardware resources that did not report during the last IPL or that were created during the last Restore configuration (RSTCFG) will be displayed.
7. Type a 4 (Remove) in the Option column to delete any entry you are certain is not valid for this system's configuration.

## Recovering Devices That Will Not Vary On

If you have a problem with your devices, such as not being able to vary on a device, it may be because the system resource management (SRM) database that was restored does not match the device descriptions on the system.

To correct the problem for a tape unit or a tape controller, do the following:

1. Type WRKHDWRSC TYPE(\*STG). You are shown the Work with Storage Resources display.
2. Type a 9 (Work with resource) in the *Opt* column next to the resource name that would not vary on. The Work with Storage Controller Resources display is shown.
3. Write down the valid resource name for the device type and model that you tried to vary on.
4. Press F12 (Cancel) until you return to a display with a command line.
5. Type WRKCTLD CTLD(*controller-name*). You are shown the Work with Controller Descriptions display.
6. Type 2 (Change) in the *Opt* column next to the controller that would not vary on and press the Enter key. The Change Controller Description display is shown. Skip to step 9.
7. Type WRKDEVD DEVD(*media-device-name*). The Work with Device Descriptions display is shown.
8. Type 2 (Change) in the *Opt* column next to the device description that you want to change and press the Enter key. The Change Device Description display is shown.
9. Change the name in the *Resource name* prompt to the correct name for the resource and press the Enter key. You return to the Work with Device Descriptions display or the Work with Controller Descriptions display.
10. Type 8 (Work with status) in the *Opt* column next to the device or controller that you changed and press the Enter key. The Work with Configuration Status display is shown.
11. Type 1 (Vary on) in the *Opt* column next to the device description name or the controller description name. Press the Enter key to vary it on.

**Local Workstation Controller:** To correct the problem for a workstation, do the following:

1. Type the following and press the Enter key to display the Work with Local Workstation Resources display.  
WRKHDWRSC TYPE(\*LWS)
2. Find the correct controller description for the device that would not vary on.
3. Type a 5 (Work with configuration description) in the *Opt* column next to the controller description name and press the Enter key. The Work with Configuration Description display is shown.
4. Type a 5 (Display) in the *Opt* column to display the valid resource name for the workstation controller.
5. Press F12 (Cancel) until you return to a display with a command line.
6. Type the following and press the Enter key to display the device description for the device that would not vary on.  
WRKCTLD CTLD(*controller-name*)

The Work with Controller Descriptions display is shown.

7. Type a 2 (Change) in the *Opt* column next to the controller description that you want to change and press the Enter key. The Change Controller Description display is shown.
8. Change the name in the *Resource name* prompt to the correct name for the resource and press the Enter key. You will return to the Work with Controller Descriptions display.
9. Type an 8 (Work with status) in the *Opt* column next to the controller description that you changed and press the Enter key. The Work with Configuration Status display is shown.
10. Type a 1 (Vary on) in the *Opt* column next to the controller description name and press the Enter key to vary on the device.

**Note:** It is possible that another device description is varied on for this resource. Vary off the device first and then vary on the changed device description. This situation can happen to the console device.

## Recovering When You Change the Console Type

When you restore your information to a different system or an upgraded system, you may have a different console type on the target system. After you have restored user information, you need to create a new controller and device description. Do the following:

1. Type `WRKHDWRSC *LWS` and press the Enter key. You are shown the Work with Local Work Station Resources display.
2. Type a 5 (Work with controller descriptions) in the *Opt* column next to the name of the first workstation controller. Press the Enter key. You are shown the Work with Controller Descriptions display.

**Note:** The first workstation controller may not be CTL01.

3. Type a 1 in the *Opt* column and press the Enter key. You are shown the Create Controller Description display.
4. For the *New controller description* prompt, type the name that you want for the console. Press the Enter key.

**Note:** If you want to use the name that you had on your old system, you must first delete the device configuration name and then re-create it.

5. Use the `CRTDEVDSP` command to create a device description for the console.

## Recovering the System/36 Environment Configuration

If you are experiencing a problem with the System/36 environment after restoring the system, it may be caused by the locking rules used during the installation process. The QS36ENV configuration object in library #LIBRARY may have been locked by the System/36 environment.

This object contains the System/36 environment names for the workstation, printer, tape and diskette units on the system, and default System/36 environment values used for all users. This object may have been modified by the Change S/36 Environment Configuration (`CHGS36`) command to customize the System/36 environment.

When the first subsystem is started on the system after the installation process is complete, a new #LIBRARY and a new QS36ENV object in #LIBRARY are created with the system defaults. In addition to creating the new objects, each subsystem holds a lock on the QS36ENV configuration object to ensure that it is not deleted. This lock will not allow the saved QS36ENV configuration object to be restored.

If the QS36ENV configuration object did not restore, start with step 1 on page 222. If the configuration object did restore but you are experiencing problems with the System/36 environment configuration, go to step 5 on page 222.

1. Rename the newly created #LIBRARY to something else (for example, #LIBNEW).  
The locks held on the QS36ENV object remain with the renamed library. This allows the saved System/36 environment configuration object to be restored.
2. Restore the saved copy of library #LIBRARY: RSTLIB SAVLIB(#LIBRARY)
3. Perform an IPL of the system.  
The QS36ENV object in the restored copy of #LIBRARY is the System/36 environment configuration again.
4. Delete the earlier renamed version of #LIBRARY (for example, #LIBNEW).
5. Use the Change S/36 Environment Configuration (CHGS36) command to refresh the configuration object.
  - a. Select each of the device types that you want to change.
    - Workstation devices
    - Printer devices
    - Tape devices
    - Diskette devices
  - b. For each device type that you want to change:
    - 1) Press the F5 key to ensure the configuration object matches the device descriptions on the system.
    - 2) If any System/36 names are not specified, do one of the following:
      - Press the F10 key to use the defaults for the System/36 names for those devices.
      - Update the System/36 names manually.
  - c. Save the changes to the configuration object.

See the topic on configuring the System/36 environment in the *Concepts and Programmer's Guide for the System/36 Environment* for more information about configuring the System/36 environment.

---

## Restoring Logical Partitions

Look for information on how to restore your Logical Partitions that is integrated throughout this book. The integrated steps include information on how to recover your logical partitions configuration data and your system and user data for each partition.

Keep the following things in mind when you recover your system and user data:

1. Recover your primary partition first.
2. Recover each partition as if it is a stand-alone system.

For more information about logical partitions, refer to the Information Center Web site at the following url:

<http://www.ibm.com/eserver/iseriess/infocenter>

| For more information about logical partitions when you are using an HMC to manage the logical partitions, refer to the following information in the IBM Systems Hardware Information Center:

| Backing up and recovering Linux logical partitions that use i5/OS virtual I/O resources

| [http://publib.boulder.ibm.com/infocenter/eserver/v1r2s/en\\_US/info/iphbl/iphblrecoverykickoff.htm](http://publib.boulder.ibm.com/infocenter/eserver/v1r2s/en_US/info/iphbl/iphblrecoverykickoff.htm)

| Backing up and recovering AIX® logical partitions that use i5/OS virtual I/O resources

| [http://publib.boulder.ibm.com/infocenter/eserver/v1r2s/en\\_US/info/iphbl/iphblaixrecoverykickoff.htm](http://publib.boulder.ibm.com/infocenter/eserver/v1r2s/en_US/info/iphbl/iphblaixrecoverykickoff.htm)



---

## Restoring Libraries

Restoring entire libraries is a common way to recover user information. Use the Restore Library (RSTLIB) command to restore a single saved library or a group of libraries. The RSTLIB command restores the entire library, including the library description and the objects in the library. This command also restores status information for programming temporary fixes (PTFs) that were in the library at the time the library was saved.

When you use the RSTLIB command, you can use the OPTION parameter to specify which objects in a library are restored:

*Possible Values for the OPTION Parameter of the RSTLIB Command:*

---

<b>*ALL</b>	Old objects are replaced and new objects are added to a library. *ALL is the default.
<b>*OLD</b>	Only old objects that already exist on the system are replaced in a library.
<b>*NEW</b>	Only objects not found on the system are added to a library. The old objects are not replaced.
<b>*FREE</b>	Only those objects that have their storage freed on the system are restored.

## Restoring a Library From a Previous Release

When you are restoring a library that was saved on a system at an earlier release, you can use the *Force object conversion* (FRCOBJCVN) parameter to specify whether programs are translated when they are restored. This can significantly impact the time it takes to restore the library. See “Restoring Programs to a Different Release” on page 242 for more information.

## Restoring Multiple Libraries

You can use the RSTLIB command to restore libraries in these groups:

### **\*NONSYS**

All libraries that were saved with SAVLIB LIB(\*NONSYS) command, including the IBM-supplied libraries QGPL, QUSRSYS, and licensed program libraries.

### **\*ALLUSR**

All user libraries that were saved with SAVLIB LIB(\*ALLUSR) or SAVLIB LIB(\*NONSYS).

**\*IBM** All IBM-supplied libraries that were saved with SAVLIB LIB(\*IBM) or SAVLIB(\*NONSYS). Only IBM-supplied libraries that contain IBM objects are restored.

### **User-specified (up to 300 repetitions)**

**generic-name** – You can specify the generic name of the library to be restored. A generic name is specified as a character string that contains one or more characters followed by an asterisk (\*). If a generic name is specified, then all objects that have names with the same prefix as the generic object name are selected.

**name** – You can specify the names of the libraries to be restored. The names of the libraries being restored must be the same as the names that were used when the libraries were saved.

Figure 3 on page 30 shows which libraries are saved and restored in these groups. If you are restoring any of the following libraries, QSYS2, QGPL, QUSRSYS, or QSYS2nnnnn, where nnnnn specifies an independent ASP number, you must restore them before restoring any other user libraries. If you use the special values (\*ALLUSR or \*NONSYS), the system restores these libraries in the correct sequence.

When you restore a group of libraries, you can omit up to 300 libraries by using the OMITLIB parameter. You can specify to omit specific libraries or you can specify to omit generic names for the libraries to be omitted. The libraries you omit are not restored from the save media. You can also use the OMITOBJ parameter to omit up to 300 specific object names or generic object names.

When you use a media definition to restore libraries that were saved in parallel with one of the following groups specified, \*ALLUSR, \*IBM, \*NONSYS, or a generic value such as X\*, you may have to perform some involved recovery operations. You must first load each drive with the volume that contains the QFILE so that the system can verify that each library resulted from the same save operation. You will then have to answer an inquiry message for each drive to position it to the correct volume, if you are starting the recovery on a library other than \*FIRST.

**Attention!**

If you have related objects, such as physical and logical files or journals and journaled objects, in different libraries, you must ensure that you restore them in the correct sequence. Read “Sequence for Restoring Related Objects” on page 34.

If you are restoring to a different system or different logical partitions, specify ALWOBJDIF(\*ALL) when you are restoring libraries.

## Considerations and Restrictions

The following restrictions and considerations apply to the RSTLIB command:

- You cannot restore a QDOCnnnn (Document) library by using the RSTLIB command. Use the Restore Document Library Object (RSTDLO) command to restore documents.
- You cannot restore the QSYS (System) library by using the RSTLIB command. Use the procedures for restoring the operating system in Chapter 5 to restore QSYS.
- A RSTLIB command may run concurrently with a RSTOBJ or SAVOBJ command that uses the same library.
- You may not run multiple concurrent RSTLIB commands that use the same library.
- A RSTLIB and SAVLIB command may not run concurrently using the same library name, even if the libraries are in different Independent ASPs.

## How to Restore All Libraries from a Single Save Operation

Follow this procedure for restoring all libraries that were saved with a single command or menu option.

1. Sign on with a user profile that has \*SAVSYS special authority. Using \*SAVSYS special authority ensures that you will not have authority problems during the restore procedure and improves restore performance.
2. Ensure that the system is in a restricted state. For more information, see “Putting Your System in a Restricted State” on page 35.
3. Find your most recent save media.
4. Use “Task 4–Restoring Libraries to a Basic Auxiliary Storage Pool” on page 184. Type your choice and press F4 (prompt).

*Table 48. Methods for Restoring All Libraries–Single Save Operation*

How Your Libraries Were Saved	Type This to Restore Them
Save Menu option 21	RSTLIB SAVLIB(*NONSYS)
SAVLIB LIB(*NONSYS)	RSTLIB SAVLIB(*NONSYS)

5. Fill in your choices for other parameters, such as device and whether to rewind the tape in a tape device. Press the Enter key.
6. If you receive messages to load a media volume, load the correct media volume and respond to the messages.
7. When the restore operation completes, check your job log to see which libraries were restored and whether any objects were not restored.

## How to Restore All Libraries from Multiple Save Operations

Following is the procedure for restoring all libraries if they were saved with multiple menu options or commands. Adapt the examples to fit your own save procedures and recovery situation. Before restoring multiple libraries, make sure that you read about “Sequence for Restoring Related Objects” on page 34.

1. Sign on with a user profile that has \*SAVSYS special authority.
2. Ensure that the system is in a restricted state.
3. Find your most recent save media.
4. Use Table 49 repeat this step and step 5 for each command. Type your choice and press F4 (prompt).

Table 49. Methods for Restoring All Libraries—Multiple Save Operations

How Your Libraries Were Saved	Type This to Restore Them
Save Menu options 22 and 23	RSTLIB SAVLIB(*IBM) RSTLIB SAVLIB(*ALLUSR)
Save Menu options 21 and 23	RSTLIB SAVLIB(*IBM) RSTLIB SAVLIB(*ALLUSR)
SAVLIB *NONSYS followed by SAVLIB LIB(LIBA LIBB LIBC)	RSTLIB SAVLIB(*NONSYS) OMITLIB(LIBA LIBB LIBC) RSTLIB LIB(LIBA) RSTLIB LIB(LIBB) RSTLIB LIB(LIBC)

5. Fill in your choices for other parameters, such as device and whether you want to rewind the tape in a tape device or not. Press the Enter key.
6. If you receive messages to load a media volume, load the correct media volume and respond to the messages.
7. When the restore operation completes, check your job log to see which libraries were restored and whether any objects were not restored.

## How to Restore Objects

You can use the Restore Object (RSTOBJ) command to restore individual objects or an entire library. When you restore a library by using the RSTOBJ command, the library description is not restored.

The following conditions apply when using the RSTOBJ command:

- The RSTOBJ command restores objects to only one library.
- Multiple concurrent RSTOBJ commands may be run against a single library.
- Up to 300 objects or generic object values can be omitted on the OMITOBJ parameter.
- Multiple concurrent RSTOBJ commands may run against a single library concurrently with the following commands:
  - The SAVLIB command
  - The RSTLIB command
  - One or more SAVOBJ commands
  - The RSTLIB command and the SAVOBJ command
  - The SAVLIB command and the SAVOBJ command

### Attention!

Do not use RSTOBJ to restore licensed programs to library QSYS. Unpredictable results can occur.

---

## Restoring User-Defined File Systems

### Restoring an unmounted UDFS

To restore an unmounted UDFS, specify the following:

```
RST OBJ('/dev/QASP02/udfs_name.udfs)
```

If the UDFS does not exist on the server, the server creates \*BLKSF" to "creates the block special file (\*BLKSF) object that represents the UDFS. If the UDFS does exist, objects from the save media overlay objects on the server.

If you perform a disaster recovery, you must create the ASPs that contain the UDFSs before you attempt the restore operation. If you do not create the ASPs, the server does not restore the UDFSs.

### Restrictions while you restore an unmounted UDFS

1. You cannot restore individual objects to unmounted user-defined file systems (UDFS).
2. You cannot view or work with objects in an unmounted UDFS. Therefore, you cannot determine the amount of storage or time required by the restore operation once you unmount the UDFS.

### Restoring an individual object from an unmounted UDFS

You may restore individual objects from a save media volume that contains unmounted user-defined file systems (UDFS). To do so, give a new name to the object that you restore. The parent directory of the new name must exist in an accessible file system.

For example, use the following save command to save the unmounted UDFS /dev/QASP01/udfs\_name.udfs that contains object payroll:

```
SAV OBJ('/dev/QASP01/udfs_name.udfs')
```

To restore the object payroll from the unmounted UDFS to an existing directory /home/JON, use the following command:

```
RST OBJ('/DEV/QASP01/udfs_name.udfs/payroll' +  
        *INCLUDE +  
        '/home/JON/payroll'))
```

### Restoring a mounted UDFS

The server restores objects that are saved from mounted UDFSs to the pathname from which the server saved them. The server restores the objects into the file server of the parent directory to which the objects are restored. The server does not restore UDFS and ASP information.

To restore a mounted UDFS, specify the following command:

```
RST OBJ('/appl/dir1')
```

In this example, the server mounted the UDFS over directory /appl/dir1 when the server saved it.

When you recover from a disaster and if you saved your UDFS as mounted, re-create the UDFS and restore it into the new UDFS.

---

## Restoring Objects That Are Journalled

If the journal exists on the system before the journaled objects are restored, all objects that were saved while being journaled are journaled again provided one of the following is true:

- The objects are not on the system at restore time.
- The objects are on the system and journaling was not ended for the objects.

- The journal is on the system and it is not damaged.

To find out which object types can be journaled and therefore have these restore considerations, refer to the Journal Management topic in the iSeries Information Center (<http://www.ibm.com/eserver/iseries/infocenter>).

When you restore an object in a library that was being journaled at the time of the save operation, an entry is written to the journal to indicate that it was restored.

If the journal is not on the system at the time a journaled object is being restored, the restore operation for the object causes a warning message to be sent and journaling is not resumed. This warning message causes a diagnostic message to be sent at the end of the restore operation. (See the topic “How to verify that objects are restored successfully” on page 45.)

If an objects in a library are not journaled during save time, but the QDFTJRN data area indicates that journaling should automatically be started for the object during the restore, then the operating system will attempt to start journaling during the restore operation. For more information about journaling refer to the Journal Management topic in the information center.

**Note:** The QDFTJRN data area object indication that journaling should be automatically started is only intended for objects in a library that can be journaled. It is not intended for integrated file system objects.

## What Happens When You Restore Journaled Objects to a Different Library or Directory

The system assigns a unique internal journal identifier (JID) to every object that is journaled. If you restore a journaled object to a library or directory other than the original library or directory, and the object still exists on the system and continues to be journaled to the same journal, the JID of the restored object is changed. Message CPF70CB — “Journal identifier &2 is currently in use” is sent to the job log to confirm the changed JID of the restored object.

All the journal entries associated with the media copy of the object have the original JID. You cannot apply these journal entries to the object that was restored to a different library or directory because it has a different JID. For this reason, you should avoid restoring a journaled object to a different library or directory.

For example, in Figure 19, the original object FILEA in LIBX library has an internal journal identifier of Z that is recorded with every journal entry associated with FILEA in LIBX. When FILEA is restored from the media to LIBC library, it is assigned the journal identifier of Y because FILEA still exists in LIBX and continues to be journaled.

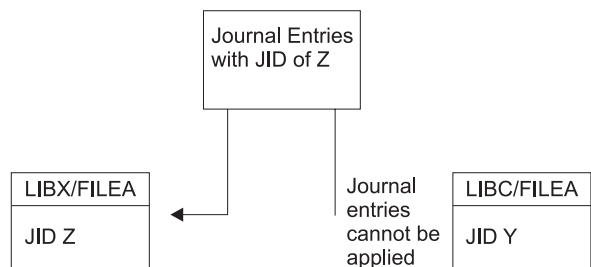

RBANS513-0

Figure 19. Example: Restoring a Journaled Object to a Different Library

Any journal operation that references an object by name and involves using journal entries requires that the journal identifier of the object and the journal identifier recorded in the journal entries be the same. Because FILEA in LIBC has journal identifier Y, journal entries with journal identifier Z are not associated with the restored FILEA in LIBC. As a result, journal changes that are recorded for FILEA in LIBX cannot be applied to FILEA in LIBC. For the same reason, if you are referencing FILEA in LIBC on the Display Journal (DSPJRN), Receive Journal Entry (RCVJRNE), or Retrieve Journal Entry (RTVJRNE) commands, or on the Retrieve Journal Entries (QjoRetrieveJournalEntries) API, the entries for FILEA in LIBX are not returned.

To display or retrieve the journal entries of the original object:

1. Save and then delete the existing object on the system.
2. Restore the original object to the system.
3. Display or retrieve the journal entries.
4. Delete the original object.
5. Restore the existing object back to the system.

---

## Restoring Database Files

You can restore one or more database files or one or more members of database files by using the RSTOBJ command. Figure 20 shows, conceptually, how a database file with two members looks to the system. It has multiple parts:

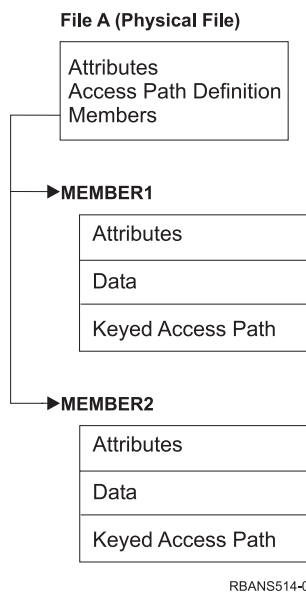

Figure 20. Example of a Database File with Two Members

If FILEA exists on the system and you restore it, the system restores the data and access paths for FILEA's two members. The attributes for the file and its members are not changed on the system.

If you want to restore the file attributes as they existed at the time of the save operation, delete the file, then restore it. If you want to restore the member attributes, remove the member (RMVM) and then restore it, specifying MBROPT(\*NEW).

When you restore a database file, the system uses information that is stored with the file and the parameters you specify to make decisions. The topics that follow describe special considerations when restoring database files and members.

**Unique File Identification:** You can restore a file only to itself. A saved version and a copied version of the same file are not the same and cannot be used interchangeably in a restore operation. Figure 21 illustrates this:

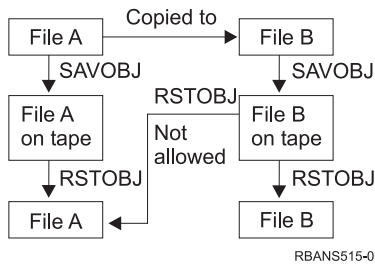

Figure 21. Restoring a Copy of a File

**File Locking during Restore Operation:** When you restore a file, no member of the file can be used during the restore operation, even through logical files. The file is exclusively locked during the restore operation.

## Comparing File Attributes during a Restore Operation

When you restore a database file or member that exists on the system, the system expects the creation dates for the system copy and the media copy to be the same. If they are not the same, the system cannot ensure that the contents of the saved copy match the format of the copy on the system.

If you specify `ALWOBJDIF(*NONE)` on the restore command, the system does not restore the file or member if the creation dates do not match. A message is sent to the user to indicate that the file or member could not be restored from the media. `ALWOBJDIF(*NONE)` is the default.

The creation dates on the system and media might be different because:

- A file or member was deleted and created again after the save operation.
- The file or member on the media was created on another system, but it has the same name as an existing file or member.

If you really want to restore a file or member whose creation date differs from the system version, you have three choices:

- Delete the file or member from the system. Then restore.
- Specify `ALWOBJDIF(*FILELVL)` on the restore command. This value lets you attempt to restore physical file data even though its creation date is different than the system copy creation date. At V5R3 you can specify `*AUTL`, `*OWNER`, and `*PGP` in conjunction with `*FILELVL` on the `ALWOBJDIF` parameter. You can use one or more of these values to allow for differences in authorization lists (`*AUTL`), object ownership (`*OWNER`), and primary group (`*PGP`). These values let you filter which types of differences are allowed on the restore operation. If you use all four values, you achieve the equivalent of `ALWOBJDIF(*ALL)` with the addition of the `*FILELVL` function.
- Specify `ALWOBJDIF(*ALL)` on the restore command. However, this can cause problems. You should be aware of what the system does when you specify `ALWOBJDIF(*ALL)`.

**How the System Restores Database Files with `ALWOBJDIF(*ALL)`:** Figure 22 on page 230 shows what the system does when creation dates for a database file are different on the system and media copies:

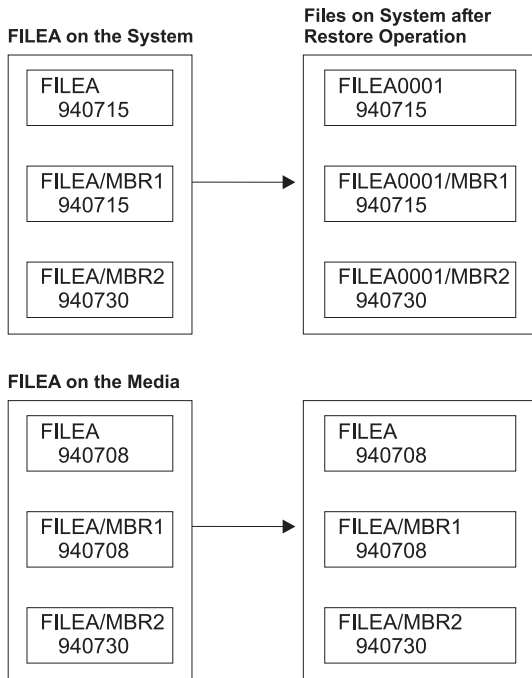

RBANS516-0

Figure 22. Restoring Database Files with Different Creation Dates

The file on the system is renamed. The media version is restored. A message is sent to the user.

Figure 23 shows what the system does when the creation date for one of the members in the file is different:

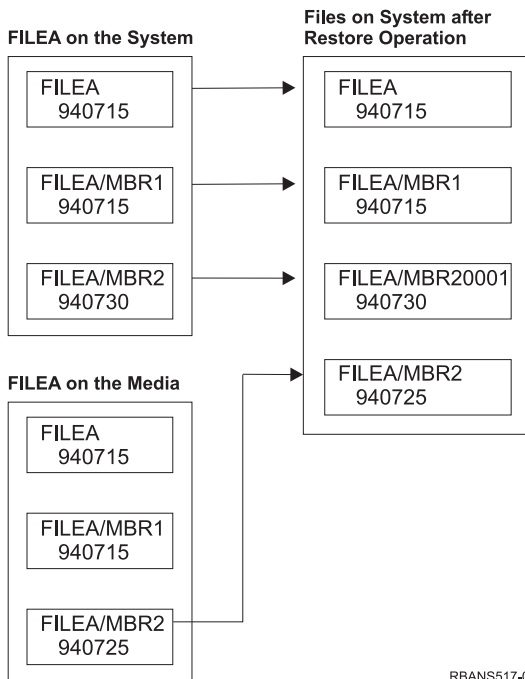

RBANS517-0

Figure 23. Restoring Database Files with Different Creation Dates



The member on the system is renamed. All members from the media are restored. A message is sent to the user.

When you specify ALWOBJDIF(\*ALL) and additional members are created during a restore operation, the system ignores the MAXMBRS (maximum members) parameter for the file. After the restore operation, you may have more than the allowed members in the file.

If a logical file is associated with a file or member that is renamed, the logical file is still associated with the renamed file or member, not the restored member.

In both examples, specifying ALWOBJDIF(\*ALL) can result in duplicate information, additional files, and additional members. Your system becomes cluttered and your applications may produce unexpected results. If you specify ALWOBJDIF(\*ALL), carefully check the messages you receive and analyze your files and members after the restore operation.

**Notes:**

1. The ALWOBJDIF parameter also affects object ownership. This is described in “How the System Establishes Ownership for Restored Objects” on page 206.
2. When you specify MBROPT(\*MATCH) on a restore command, you cannot specify ALWOBJDIF(\*ALL). See “How the System Matches File Members during a Restore Operation.”

## How the System Matches File Members during a Restore Operation

When you are restoring to an existing database file, you use the member option (MBROPT) parameter on either the RSTOBJ command or the RSTLIB command to tell the system what to do if the members do not match. The choices are:

**\*MATCH**

If the set of members on the save media and on the database are not identical, the restore operation fails. \*MATCH is the default.

**\*ALL** All members on the save media are restored, whether or not they exist on the system copy.

**\*NEW** Only those members on the save media that do not exist in the database file are restored.

**\*OLD** Only those members on the save media that already exist in the database file are restored.

**Note:** The ALWOBJDIF parameter determines what the system does if creation dates on the members do not match. See “Comparing File Attributes during a Restore Operation” on page 229.

## Restoring Members to a File

You can restore a list of members for a database file by using the FILEMBR parameter of the RSTOBJ command. This list may consist of specifically named members, generically named members, or a combination of both specifically and generically named members.

The FILEMBR parameter is used to specify:

- A list of file members (specific or generic) for a specific database file
- The same group of members from more than one file

The default value \*ALL causes all file members of files specified with the OBJ parameter to be restored.

## Restrictions on the File Member Parameter

The following restrictions apply to the FILEMBR parameter:

- Each database file that is specified in the FILEMBR parameter must also be specified in the OBJ parameter by its complete name, a generic name, or \*ALL.
- Generic names are not valid for the database file name.
- Generic names are valid for the member name.

If a generic file member name is used, and the file does not have members that fit the generic name, the file is not restored. If all files specified by the FILEMBR parameter are not restored, a diagnostic message is sent and the restore operation ends with an escape message giving the number of files not restored.

If a name that is not generic is used, the specific members must exist in the file for any part of the file to be restored.

- The OBJTYPE must be \*ALL or include \*FILE.
- The MBROPT parameter must not have the \*MATCH value.

## Restoring Logical Files

When you restore a logical file, the system uses the description for the logical file to establish its relationship with the based-on physical files and logical files. All based-on files must exist before you can restore the logical file.

You can restore a logical file to a library different than the library for the associated physical file. However, the associated physical file must remain in or be restored to its original library location.

If you try to restore a logical file to a library in which it does not exist, the restore operation fails if any of the associated physical files have had their storage freed.

When a logical file is restored, it must be dependent on the same physical files as it was when it was saved.

- The logical file is created over the physical files in the library where they are being restored if any of the following occur:
  - The logical file and the associated physical files existed in the same library at the time of the save operation.
  - The logical file and the associated physical files are present in the library where the files are being restored.
  - The logical file and the associated physical files are being restored to the same library.
- If the files are not present in the restore library, then the logical files are created over the physical files in the original saved library.
- If the correct physical files are not found in either library, then the restore operation of the logical file fails. To correct the problem, run the RSTOBJ command again and specify OBJ(\*NEW). If the restore operation is successful, an informational message (CPF3291) is sent to indicate which library was used for associated physical files.

The creation dates of the physical files must not have changed since the logical file was saved. If the date has changed, an informational message (CPF3293) is sent indicating that the physical file has been changed since the save operation, but the restore operation continues.

Restore physical or logical files with dependent logical files before the dependent logical files, unless the physical and logical files already exist on the system. The following considerations apply to restoring logical files:

- If the dependent physical or logical files are in the same library, the system provides the proper sequencing.
- If the files are in different libraries, you must restore the libraries in order, so that the physical or logical files that have logical files built on them are restored first.
- If the depended-on physical or logical files are not restored before you attempt to restore the logical files, restoring the logical files fails.
- This sequencing also applies to other requirements between files, such as shared formats. You can restore those logical files that failed by using the RSTOBJ command.

## How the System Restores Access Paths

The description for a database file contains a description of its access path, if it has one. When you save a database file, you may save the access path with the file. This depends on the type of file, the type of access path, and how you performed the save operation. For more information, see the **Back up your server** topic on the Information Center at the following Web site:

<http://www.ibm.com/eserver/series/infocenter>

When you restore a file, the system either restores the access path with the file or rebuilds the access path based on the information in the file description. The process of rebuilding the access path for a large database file can take a long time. This topic describes when the system restores access paths and when it cannot. If possible, you should plan your save operations to avoid having to rebuild access paths during a restore operation.

The system always restores the access path for a keyed physical file of type \*DATA unless the access path was not saved. The access path for a keyed physical file is always saved, unless the access path is not valid at the time of the save.

Normally, source physical files are not keyed. The default for the CRTSRCPF is to create a non-keyed file. When you restore a keyed source physical file, the access path is rebuilt after the restore operation.

Access paths that are owned by logical files are restored if all of the following conditions are true:

- The system saved the access path. Although this seems obvious, the system only saves access paths if the certain conditions are met. For more information, see the **Back up your server** topic on the Information Center at the following Web site:  
<http://www.ibm.com/eserver/series/infocenter>
- All based-on physical files are in the same library and are being restored at the same time on the same restore command.
- If the logical file exists on the system, it does not specify MAINT(\*REBLD).
- The logical file owned the access path at the time it was saved.
- If the logical file is created again by the restore operation and it shares an access path that already exists, the key length for the access path must be equal to the maximum key length of the logical file or you receive an error.

If you meet these conditions, you minimize the rebuilding of access paths. However, during the restore operation, the system checks the integrity of each access path. If it detects any discrepancy, the access path is rebuilt.

In a few cases, the system may decide to rebuild access paths even though they were saved. For example, you may have defined a new logical file that specified the same key as the physical file but also specified UNIQUE. The based-on physical file was in use at the time that the logical file was created. Therefore, the system had to create a new access path for the logical file. Assume that you save these two files with a single command. If you restore them with a single command, the system will determine that they can share a single access path. Instead of restoring the two access paths, it builds a new, shared access path for the two files.

### Restoring a File Network—Examples

Figure 24 on page 234 shows a physical file and two logical files:

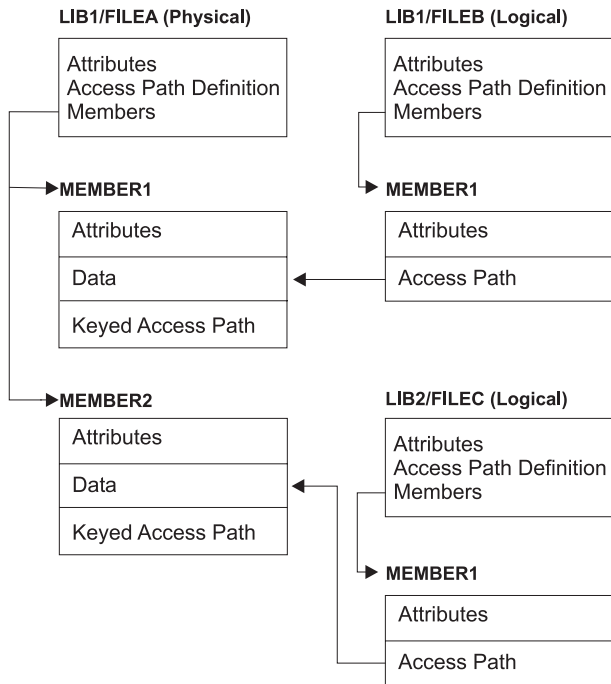

RBANS518-0

Figure 24. Restoring Access Paths

Assume that these files were saved with this command:

```
SAVLIB LIB(LIB1 LIB2) ACCPTH(*YES)
```

The save media volume contains all three files (FILEA, FILEB, and FILEC) and three access paths, each owned by a different file. Table 50 shows what the system does when you restore these libraries by using different methods. These examples assume that none of the files are on the system when the system restores them:

Table 50. Restoring a File Network

Sequence of Restore Commands	What the System Does
Example 1: 1. RSTLIB SAVLIB(LIB1) 2. RSTLIB SAVLIB(LIB2)	Results of Example 1: 1. FILEA and FILEB are restored. The access paths owned by FILEA and FILEB are restored. 2. FILEC is restored. The access path owned by FILEC is rebuilt.
Example 2: 1. RSTLIB SAVLIB(LIB2) 2. RSTLIB SAVLIB(LIB1)	Results of Example 2. 1. FILEC is not restored because FILEA is not on the system. 2. FILEA and FILEB are restored. The access paths owned by FILEA and FILEB are restored.

These examples highlight the problems that can occur when logical files and based-on physical files are in different libraries. Access paths are restored when physical files are restored because they are built over data that is contained in the physical file. In the first example, FILEC owned the access path but FILEC was not on the system when the physical file was restored. Therefore, the access path was not restored. In the second example, FILEC could not be restored because its based-on physical file (FILEA) was not on the system.

## How to Prevent the System from Rebuilding a Large Access Path

If the situation that is shown in Table 50 on page 234 occurs on your system and you want to prevent the system from rebuilding a large access path, do the following:

1. Restore the physical file or the library that contains the physical file. In the case of example 2, restore FILEA or LIB1.
2. Restore the logical file (FILEC) using the RSTOBJ command.
3. Immediately after restoring the logical file, type EDTRBDAP. You are shown the Edit Rebuild of Access Paths display.
4. Change the value in the *Seq* column for the logical file to \*HLD.
5. Restore the physical file (FILEA) again using the RSTOBJ command. Because the logical file (FILEC) is now on the system, the system will restore the access path that is owned by FILEC.
6. Type EDTRBDAP. You are shown the Edit Rebuild of Access Paths display.
7. Change the sequence number for FILEC to a value from 1 through 99 to remove the access path from the display.

## How the System Restores Files with Shared Formats

When a database file is restored and that file, before it was saved, had shared the record format of another file, an attempt is made to find the file whose format was shared, and reestablish the original format sharing.

The search for restoring the shared format starts in the library to which the restored file is directed and continues in the library from which the restored file was saved. Following are the results of the search:

- If the sharing file is found and has not been changed (level check) since the save, then no new format is created for the restored file.
- If the sharing file is not found, or it is found but fails the level check, then a new format for the restored file is created with the same definition as the one it initially shared.
- If a format sharing file has been renamed, deleted, or moved to a library other than the save or restore library, a new format is created for the dependent file when the dependent file is restored.

## How the System Restores Files with Referential Constraints

Information about DB2/400\* database files is kept in system cross-reference files. This includes information about constraints that are defined. When you define a referential constraint, you specify that a record with a certain primary key must exist in the parent file before a record with the same values in a foreign key can exist in the dependent file. For example, you cannot add an order to the order file (dependent file) unless a record exists for the customer in the customer file (parent file).

A referential constraint is defined, stored, and saved with the dependent file. Each referential constraint has a name, which must be unique for the library that contains the dependent file. When you restore a file that has a referential constraint name that already exists in the library, the system generates a new name for the referential constraint that is being restored.

When you restore a database file that already exists on the system, the referential constraints that are defined for the system copy of the file are used. If the saved version of the file has additional referential constraints that are not on the system copy, these additional constraints are not restored.

When you restore a database file that does not exist, you should ensure that any referential constraints that were not on the saved copy are reestablished. Otherwise, you lose the data integrity checking that was on your system before a failure occurred.

Files that are related by referential constraints form a database network similar to the network formed by logical files and the based-on physical files. You should try to save an entire referential constraint

network in one operation. If this is not possible, you should at least save the files with consecutive operations where no activity occurs in between. This ensures that the files are synchronized.

If you journal database files, you should journal all physical files that are part of a referential constraint network. This ensures that your referential constraints remain valid after you have applied journaled changes. The Journal Management topic in the iSeries Information Center (<http://www.ibm.com/eserver/series/infocenter>) provides more information about journaling and referential constraints.

## Referential Constraint Network–Example

Figure 25 shows an example of a referential constraint network.

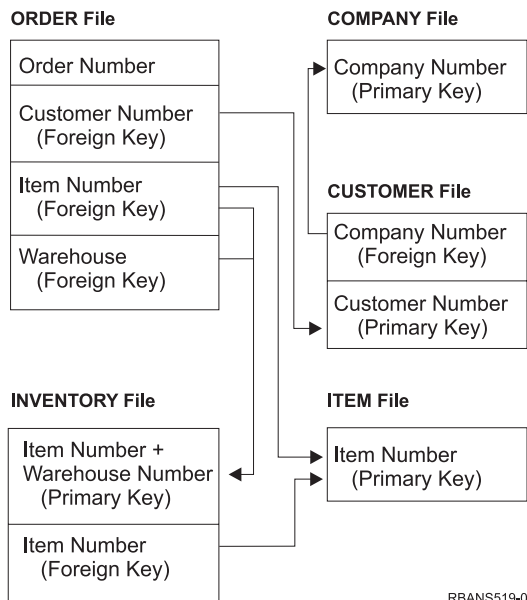

Figure 25. Restoring a Referential Constraint Network

You can restore the files in this network in any sequence. When you restore the files, the system reestablishes the relationships and attempts to determine whether the constraints are still valid.

For example, if you restore both the ITEM file and the INVENTORY file, the system checks the internal information stored with the files to determine whether the indexes for the two files are synchronized.

If the internal information does not match, the system validates the constraint for the INVENTORY file. It does this by reading every record in the INVENTORY file and ensuring that a record with that item number exists in the ITEM file. If this process is successful, the constraint is valid. If this process is not successful, the status of the constraint is set to **Check pending**. When the status of a constraint is check pending, you must take action to correct the situation, either by restoring one of the files or using a program to update the files.

If you restore one of the files, the system again attempts to validate the constraint. If you use a program to update the information, you must use the Edit Check Pending Constraints (EDTCPCST) command to force the system to revalidate the constraint. The topic “Task 3–Edit Check Pending Constraints” on page 161 describes how to determine the status of files that have referential constraints.

Look in the Information Center under the Database and File System topics for more information about using referential constraints.

## How the System Restores Files with Triggers

You can define one or more trigger programs for a file. When a certain event occurs in the file, the system calls the trigger program. When you save a file that has trigger programs, you are saving only the definitions of the trigger programs, not the programs themselves. You must ensure that the programs are also saved, perhaps by placing them in the library with the file.

When you restore a database file that already exists, the system does not restore any trigger program definitions from the save media. When you restore a database file that does not exist, you should ensure that any definitions for trigger programs that were not on the saved copy are reestablished. Otherwise, you lose the data integrity checking that was on your system before a failure occurred.

The system does not stop restoring a database file if its trigger programs cannot be found. Therefore, you must ensure that files and trigger programs are saved and restored correctly. Otherwise, an error may occur.

Table 51 shows examples of actions the system takes when you restore the physical file FILEA and the trigger program PGMA:

*Table 51. Restoring Files That Have Trigger Programs*

Save Procedure That Is Used	Restore Procedure That Is Used	How the Trigger Program Is Defined after the Restore Operation
FILEA is saved from LIBX. PGMA is saved from LIBX. The trigger is defined as LIBX/PGMA.	PGMA is restored to LIBY. FILEA is restored to LIBX.	The trigger is defined as LIBX/PGMA. When an event occurs that causes this trigger, the program will not be found.
FILEA is saved from LIBX. PGMA is saved from LIBX. The trigger is defined as LIBX/PGMA.	PGMA is restored to LIBY. FILEA is restored to LIBY.	The trigger is defined as LIBY/PGMA.
FILEA is saved from LIBX. PGMA is saved from LIBY. The trigger is defined as LIBY/PGMA.	PGMA is restored to LIBZ. FILEA is restored to LIBZ.	The trigger is defined as LIBY/PGMA. When an event occurs that causes this trigger, the program will not be found.

Look in the Information Center under the Database and File System topics for more information about using trigger programs. The Journal Management topic in the iSeries Information Center at <http://www.ibm.com/eserver/iseres/infocenter> describes special considerations when you journal database files that have triggers defined. You must make special provisions to ensure the integrity of your data because trigger programs are not called when you apply journaled changes.

## Steps Before Deleting a Physical File

In some situations, you must delete a physical file as part of your recovery. For example, the physical file may be damaged. Or a physical file in a user ASP may have overflowed into the system ASP. You cannot delete a physical file if other files are dependent on it, such as logical files or files that share the record format.

Before deleting a physical file, do the following:

1. Use the Display Database Relationships (DSPDBR) command to list all the files that are dependent on the physical file.
2. Save and delete each file that is dependent on the physical file.

After you have recovered the physical file, restore all the dependent files.

---

## Restoring Journals and Journal Receivers

**Note:** If you are restoring remote journals or journal receivers that are associated with remote journals, refer to the Journal Management topic in the iSeries Information Center at <http://www.ibm.com/eserver/series/infocenter>.

Usually you can restore journals or journal receivers only to the same library from which they were saved. The one exception is journal receivers that are part of a remote journal network. These receivers can often be restored to the remote receiver library as well. See the Journal Management information on Info Center for additional details. Use the RSTOBJ and RSTLIB commands to restore journals and journal receivers. When you are restoring multiple objects with one of these commands, journals and journaled objects are restored before the journal receivers.

When you use several commands to restore several objects, restore the objects in this order:

1. Journals
2. Based-on physical files
3. Other journaled objects associated with those journals
4. Dependent logical files
5. Journal receivers

**Note:** Journal receivers can be restored at any time after the journals. They do not have to be restored after the journaled objects.

### Restoring Journals

When you restore a journal, the system creates a new journal receiver and attaches it. The characteristics of the new journal receiver are based on the journal receiver that was attached when the journal was saved:

- The system creates a name that is not likely to conflict with other journal receivers that may be on the system. The Journal Management topic in the iSeries Information Center (<http://www.ibm.com/eserver/series/infocenter>) describes how the system generates a name.
- The system attempts to assign the same owner and to create the journal receiver in the same library. If the owner of the receiver is not found, the receiver is assigned to the default owner (QDFTOWN) user profile. If the library is not found, the journal receiver is placed in the journal's library.
- The system starts a new receiver chain. The Journal Management topic in the iSeries Information Center (<http://www.ibm.com/eserver/series/infocenter>) discusses receiver chains.

**Note:** At the time a new journal receiver is created and attached, private authorities have not been restored on the system. Therefore, private authorities will not be assumed by the new journal receiver. After the Restore Authority (RSTAUT) command is run, users will receive private authority to the receiver that was attached before the restore operation. Users will not receive private authority to the new receiver. Users must be manually granted private authority to the new receiver.

You cannot restore a journal to a library that contains the same journal. If a journal must be restored (because of damage) to a library, the existing journal must be deleted first.

### Steps before Deleting a Journal

In some situations, you must delete a journal as part of your recovery. For example, the journal may be damaged, or a journal in a basic ASP may have overflowed into the system ASP. You cannot delete a journal while objects are being journaled to it.



You use the Delete Journal (DLTJRN) command to delete a journal. Before deleting a journal, try to do the following steps. You may not be able to perform these steps successfully if the journal is damaged.

1. Type

```
WRKJRNA JRN(library-name/journal-name)
OUTPUT(*PRINT)
```

and press the Enter key. You receive a listing that shows all the objects that are currently being journaled.

2. End journaling for all the access paths assigned to the journal by typing:

```
ENDJRNAP FILE(*ALL)
JRN(library-name/journal-name)
```

3. End journaling for all the physical files assigned to the journal by typing:

```
ENDJRNPF FILE(*ALL)
JRN(library-name/journal-name)
```

4. End journaling for all the integrated file system objects assigned to the journal by typing:

```
ENDJRN OBJ(*ALL)
JRN(/QSYS.LIB/library-name.LIB/journal-name.JRN)
```

5. End journaling for all other object types assigned to the journal by typing:

```
ENDJRNOBJ OBJ(*ALL) OBJTYPE(*ALL)
JRN(library-name/journal-name)
```

6. Deactivate any remote journals that are associated with the journal by using the Change Journal State (QjoChangeJournalState) API or the CHGRMTJRN command.

When you try to delete the journal, you may receive message CPF7021 indicating that the journal is being used for commitment control. If this occurs, end the jobs that are using commitment control and then try to delete the journal again. To see the commitment control uses of the journal use the Work with Journal Attributes (WRKJRNA) command, function key 19 (F19=Display journaled objects), and option 6 (6=Commitment Definitions). You can use the End Job (ENDJOB) command or you can use the *End* option from the Work with Active Jobs (WRKACTJOB) display.

After you restore the journal or create it again, you must start journaling again for each object. Use the following commands to begin journaling for each object type listed below:

- Database physical files — STRJRNPF
- Access paths — STRJRNAP
- integrated file system objects — STRJRN
- All other object types — STRJRNOBJ

You should save the objects after you start journaling, in case the system assigned a new journal identifier (JID) to an object. If you previously had any remote journals associated with the journal, add them again by using the Add Remote Journal (ADDRMTJRN) command or the Add Remote Journal (QjoAddRemoteJournal) API. If you added any remote journals, you should save the journal in order to preserve that information.

## Restoring Journal Receivers

The system will not restore a journal receiver over the journal receiver that is currently attached. The system will not restore a journal receiver over an existing journal receiver that contains more entries. If you use the SAVCHGOBJ command to save journal receivers, this is likely to occur. The journal receiver that is attached at the time of the save operation is a changed object and is saved by the command. When you restore, you receive message CPF3706 and the system continues with the next journal receiver.

If your save procedure saves the currently attached journal receiver, you may try to restore a journal receiver with fewer entries than the journal receiver on the system. For example, assume that you save your journal receivers when receiver RCVR0006 is attached. RCVR0006 has 1500 entries. Later, you use the CHGJRN command to create and attach a new receiver. Now receiver RCVR0007 is attached. Receiver

RCVR0006 is still on the system and has 4300 entries. If you attempt to restore receiver RCVR0006 from your save media volume, the operation fails because the saved copy has only 1500 entries.

If the library you specify on the restore command for a journal receiver does not exist, the system restores the journal receiver to the library that contains the journal. If you specify RSTASP(\*SAVASP) and the ASP does not exist, the system usually restores the journal receiver to the same ASP as the library that contains the journal.

**Placing Journal Receivers in the Correct Auxiliary Storage Pool:** If the attached journal receiver is not in the desired ASP after the restore operation, do the following:

1. Create a journal receiver in the desired ASP. Follow your existing naming convention and use the same journal receiver attributes.
2. Use the CHGJRN command to attach the new journal receiver to the journal.

## How to Resolve Name Conflicts When Restoring Journal Receivers

When you restore a journal, the system creates and attaches a new journal receiver. The system attempts to name this journal receiver so that a name conflict does not occur. However, in rare cases, this new journal receiver may have a name that matches the name of a journal receiver that you need to restore. If this occurs, do the following:

1. Create a new journal receiver with a name separate from your normal naming convention. For example, type: CRTJRNRCV JRNRCV(*library-name*/TMP0001).
2. Use the CHGJRN command to attach the temporary journal receiver: CHGJRN JRN(*library-name*/*journal-name*) JRNRCV(*library-name*/TMP0001).
3. Delete the journal receiver that has the name conflict. This journal receiver should not have any entries you need for your recovery because it was created when the journal was restored.
4. Restore the journal receivers.
5. Create a journal receiver that continues your naming convention and has the same journal receiver attributes.
6. Use the CHGJRN command again to attach the journal receiver that you created in step 5.

## How to Correct the Journal Receiver Directory

Every journal has a directory of journal receivers. The sequence of journal receivers is called the **receiver chain**. Before you begin a recovery by using journal receivers, you should ensure that this receiver directory is current and correct.

Do the following:

1. Type WRKJRNA JRN(*library-name*/*journal-name*) and press the Enter key.
2. From the Work with Journal Attributes display, press F15 (Work with receiver directory). You are shown the Work with Receiver Directory display.
3. If the receiver directory is not correct, do the following:
  - a. Type WRKJRN and press the Enter key.
  - b. On the prompt display, enter the name of the journal.
  - c. On the Work with Journals display, type a 9 (Associate receivers with journal) in the option column in front of the journal. The system establishes the receiver chain for the journal.

## Steps before Deleting a Journal Receiver

In some situations, you must delete a journal receiver as part of your recovery. For example, the journal receiver may be damaged. Or a journal receiver in a user ASP may have overflowed into the system ASP.

You cannot delete a journal receiver that is currently attached to a local journal. You also cannot delete a journal receiver if later journal receivers in the receiver chain are still on the system, unless one of the following conditions exists:

- The receiver being deleted is damaged
- The journal is a remote journal
- The journal is system-managed and the system is deleting journal receivers

If you need the journal receiver for recovery, you should not delete it without first saving it. If you do, the system warns you but does not prevent you from deleting the journal receiver.

Before deleting a journal receiver, do the following:

1. If the journal receiver is attached, detach it by typing:

```
CHGJRN JRN(library-name/journal-name)
JRNRCV(*GEN)
```

**Notes:**

- a. If the current journal receiver is damaged, you cannot specify JRNRCV(\*GEN). Use the Create Journal Receiver (CRTJRNRCV) command to create a new journal receiver that follows your naming convention and has the same attributes. Specify that receiver name on the CHGJRN command.
2. If earlier journal receivers are on the system, save them and delete them. You can print the receiver chain by typing WRKJRNA JRN(library-name/journal-name) OUTPUT(\*PRINT).

---

## How the System Restores Programs

Restoring programs to your system represents a security exposure. A restored program may have been altered to perform functions that you do not intend, or the program may adopt the authority of a powerful user profile.

When the QSECURITY (security level) system value on your system is 40 or higher, the system checks for restricted instructions in all programs that are restored. You can use the QALWOBJRST system value to allow or prevent the restoration of certain types of objects on your system. You can also set the QVfyOBJRST (verify object on restore) system value to specify how the system verifies program-object signatures during a restore operation. See “Controlling Restoration of Security-Sensitive Objects” on page 40.

In order for an object to be restored successfully, it must pass the three system values that work together during a restore operation: Verify object signatures during restore (QVfyOBJRST), Force conversion on restore (QFRCCVNRST) and Allow restore of security-sensitive objects (QALWOBJRST). However, if the Force object conversion (FRCOBJCVN) parameter on the restore command being used and Force conversion on restore (QFRCCVNRST) system value are not compatible, no conversion will occur and nothing is restored. To learn more about the compatibility of the FRCOBJCVN parameter and QFRCCVNRST system value, see Effects of system value settings on restore operations in the System Values topic of the iSeries Information Center at <http://www.ibm.com/eserver/series/infocenter>.

The system stores a validation value for all programs. When a program is restored, the system calculates the validation value and compares it to the value on the media. You can use the convert objects during restore (QFRCCVNRST) and allow restore of security sensitive objects (QALWOBJRST) system values to control the action to take when restoring programs with validation errors. You can choose to have the system recreate the program. If recreation is successful the program is restored and the validation error is corrected. If recreation is not successful the program is not restored. As an alternative, you can choose not to have the system attempt recreation and not allow any program with a validation error to be restored. A third alternative is to not attempt recreation and have the system restore the program with the validation error (which may be a security risk). The system contains all the information necessary to re-create an AS/400® or iSeries program.

| When an external procedure associated with an ILE external program is created, an attempt is made to save the attributes for the procedure in the associated program object. If the \*PGM object is saved and then restored to this or another system, the catalogs are automatically updated with those attributes.

| The attributes can be saved for external procedures subject to the following restrictions:

- | • The external program library must not be QSYS or QSYS2.
- | • The external program must exist when the CREATE PROCEDURE statement is issued.
- | • The external program must be an ILE \*PGM object.
- | • The external program must contain at least one SQL statement.
- | • If the object cannot be updated, the procedure will still be created.

| During restore of the procedure, this may occur:

- | • If the specific name was specified when the procedure was originally created and it is not unique, an error is issued.
- | • If the specific name was not specified, a unique name is generated, if necessary.
- | • If the procedure name and number of parameters is not unique, the procedure cannot be registered, and an error is issued.

## Restoring Programs to a Different Release

Servers that run Version 3 Release 2 Modification 0 or earlier of the i5/OS licensed programs are IMPI (internal microprogramming interface) processors. IMPI refers to the low-level instruction set and the Licensed Internal Code. iSeries or AS/400 processors that run V3R6 or higher of the i5/OS licensed programs are PowerPC® AS processors. When you move a program object (\*MODULE, \*PGM, \*SRVPGM, \*SQLPKG) between a system with an IMPI processor and a system with a PowerPC AS processor, the system must create the program object again from the information that is stored with the program.

Object conversion occurs at one of the following times:

- When the object is used for the first time. This is the default.
- When you use the Start Object Conversion (STROBJCVN) command to convert objects. This is normally done for an entire library.
- When you restore the object.

The *AS/400 Road Map for Changing to PowerPC Technology* has more information about moving from an IMPI system to a system with a PowerPC AS processor.

---

## Restoring Save File Data

You can save a save file to tape or optical media with the SAVSAVFDTA command. When you restore the save file, it appears as though the data originally came from the same type of save media. You can use the RSTOBJ, RSTLIB, RST, RSTDLO, RSTCFG, or RSTUSRPRF commands to restore the data.

You can save file data to tape or optical media by using the SAVLIB, SAVOBJ, or SAVCHGOBJ commands. If you specified SAVFDTA(\*YES) on the save command, you must restore the save file before you can restore the objects in the save file.

## Save and restore spooled files

Save and restore spooled files and all of their attributes. Prior to V5R4M0, you must use indirect methods to save and restore spooled files. These indirect methods may not preserve all of the attributes. This table summarizes the methods.

Table 52. Save and restore spooled files

Restore Methods	Method descriptions	Spooled file attributes preserved
SAVLIB, SAVOBJ commands SAVRSTLIB, SAVRSTOBJ commands QSRSAVO API Save menu options 21-23	RSTLIB, RSTOBJ commands SAVRSTLIB, SAVRSTOBJ commands QSRRSTO API Restore menu options 21-23	Data and all attributes
QSPOPNSP, QSPGETSP, QUSRSPLA APIs	QSPCRTSP, QSPPUTSP, QSPCLOSP APIs	Data, but not all attributes
CPYSPLF, SAVOBJ commands	CPYF command	Textual data only

When you save an output queue with the save commands, menu, or QSRSAVO API, you can choose to save all its spooled files. You can do this by specifying \*ALL for the Spooled file data (SPLFDTA) command parameter, menu prompt or API key. When you restore output queues with the restore commands, menu, or QSRRSTO API, you can choose to restore any saved spooled files that do not already exist on the system. You can do this by specifying \*NEW for the SPLFDTA parameter, prompt, or key. With the QSRSAVO and QSRRSTO APIs, you can also choose to save or restore spooled files by using a set of selection criteria. If you save spooled files with the QSRSAVO API using selection criteria and the \*SPLF special library value, then you must use the QSRRSTO API with the \*SPLF special library value to restore the spooled files.

This example describes how to save spooled files:

1. Create an output queue to store the spooled files.  
CRTOUTQ OUTQ(lib-name/que-name)
2. Use the Work with Spooled File (WRKSPLF) command to list the spooled files.
3. Use option 2, Change Spooled File Attributes (CHGSPLFA) command to move the spooled files you wish to save to the output queue you created.
4. Use the Save Object (SAVOBJ) command to save the spooled file data.  
SAVOBJ OBJ(que-name) LIB(lib-name) DEV(dev-name) OBJTYPE(\*OUTQ) SPLFDTA(\*ALL)

This example describes how to restore spooled files:

1. Restore spooled files that are not already on the system.  
RSTOBJ OBJ(que-name) SAVLIB(lib-name) DEV(dev-name)  
OBJTYPE(\*OUTQ) SPLFDTA(\*NEW)

### Using spooled file APIs

If your source or target system is earlier than V5R4M0, you can use spooled file APIs as an indirect method to save and restore spooled files. This method preserves the spooled file data stream but not all of the attributes.

To save spooled files:

- The spooled files are opened using the Open Spooled File (QSPOPNSP) API.
- The spooled file data is retrieved using the Get Spooled File Data (QSPGETSP) API.
- The spooled file attributes are retrieved using the User Spooled File Attributes (QUSRSPLA) API.

To restore spooled files:

1. The spooled files are created using the Create Spooled File (QSPCRTSP) API .
2. The spooled file data is written to a new spooled file using the Put Spooled File Data (QSPPUTSP) API.
3. The spooled file is closed using the Close Spooled File (QSPCLOSP) API.

The System API Reference in the iSeries Information Center includes information about these APIs. You can find an example and a tool for using these APIs in the QUSRTOOL library in the TSRINFO member of the QATTINFO file.

## Copying spooled files to database files

If your source or target system is earlier than V5R4M0, you can copy data between spooled files and database files as an indirect method to save and restore spooled files. This method copies textual data only and not advanced function attributes such as graphics and variable fonts. This method does not provide a complete solution for saving your spooled files.

The Copy Spooled File (CPYSPLF) command saves spooled file data to a database file. The Copy File (CPYF) command can copy data from a database file to a spooled file. Refer to Restoring Previous Release User Data to a New System in the Backup and Recovery book for more details.

View Entire GO SAVE checklist in the iSeries Information Center includes more information about menu options 21, 22, and 23 of the GO SAVE command.

Refer to Print restrictions in the Information center within the Print topic for restrictions of saving and restoring spooled files.

---

## Restoring Licensed Programs

Use the RSTLICPGM command to add or replace licensed programs on the system. Refer to the *Install, upgrade, or delete i5/OS and related software* book for more information about installing licensed programs.

---

## Restoring Documents and Folders

Use the Restore Document Library Object (RSTDLO) command to restore documents, folders, and mail. To use this command most efficiently, you should know how documents were saved. To determine this, use the output that was printed for the SAVDLO procedures, the DSPTAP command, or the DSPOPT command. RSTDLO performance is also better if you have \*SAVSYS special authority.

## RSTDLO Command Options

The RSTDLO command provides many options. You can restore any of the following:

- A specific document or system object whose name you specify.
- All the documents and folders you saved by typing: RSTDLO DLO(\*ALL) SAVFLR(\*ANY). If you saved DLOs from more than one ASP, you must specify SAVASP(\*ANY). You must also specify the sequence numbers (SEQNBR parameter) for the files on the save media.

**Note:** When you use RSTDLO DLO(\*ALL), this includes the folders that are used by IBM-supplied programs, such as iSeries Access. Ensure that you saved these folders from the current release, or you may need to install the licensed programs again.

- 1 to 300 documents from the same media file by specifying the names of the documents or the system object names.
- 1 to 300 folders from the same media file.

- All filed documents that are not in any folder on the save media. See “Restoring Folders” on page 246 for more information.

## Using Multiple Concurrent DLO commands

Multiple concurrent SAVDLO or RSTDLO commands may be used in specific situations.

No two of the following commands may be run on one system at the same time:

- RCLDLO DLO(\*ALL)
- RCLDLO DLO(\*DOCDTL)
- RCLDLO DLO(\*INT)
- DLTDL DLO(\*ALL)
- RNMDIRE

An attempt to run these commands at the same time results in the message CPF8A47: Internal system objects are in use. An attempt to run a SAVDLO or RSTDLO operation while one of these commands is running will also result in MSGCPF8A47 and no objects will be saved or restored.

## Output from the RSTDLO Command

You can use the OUTPUT parameter on the RSTDLO command to show information about the restored documents, folders, and mail. You can either print the output (OUTPUT(\*PRINT)) or save it to a database file (OUTPUT(\*OUTFILE)).

If you print the output, you should be aware of device dependencies:

- The heading information in the output is device-dependent. All information does not appear for all devices.
- The print file for the RSTDLO command uses a character identifier (CHRID) of 697 500. If the printer you are using does not support this character identifier, you will receive message CPA3388. To print the RSTDLO output and not receive message CPA3388, specify the following before specifying \*PRINT on the RSTDLO command:

```
CHGPRTF FILE(QSYSOPR/QPRSTDLO) CHRID(*DEV)
```

For more information about character identifiers (CHRID), see the *Printer Device Programming* book.

If you use an output file, the system uses the file format QSYS/QAOJRSTO.OJRDLO. The file layout is described in the *Office Services Concepts and Programmer's Guide* book.

## Considerations and Restrictions

You should be aware of the following additional factors when using the RSTDLO command.

### Moving Documents

When you restore documents, you can rename them, restore them to a different folder, or have the system assign new system object names. The folder for a document determines its ASP location. You can move a document to a different ASP by doing the following:

1. Save the document.
2. Delete it with the DLTDL command.
3. Restore it into a folder in a different ASP.

### Searching Tape Files

When you restore documents or folders from a list and specify SEQNBR(\*SEARCH), the system restores from the first tape file that contains any of the documents or folders that you specified. If the tape file does not contain all the documents and folders in your list, the system does not search other tape files for the additional documents and folders. You can specify SEQNBR(*starting-sequence ending-sequence*) to search more than one tape file.

## Selecting files from DVD-RAM optical media

The OPTFILE and SAVASP parameters control which file(or files) that the system uses. If you specify a file pathname, the system uses that file. If you specify the default of OPTFILE('\*') or OPTFILE('directory-path-name/\*'), the system uses files named QDOC or QDOCnnnn in the directory that you specify, depending on the SAVASP value.

## Search Index Database Errors

When you restore DLOs, the system updates the search index database information for the DLOs. If you receive error messages during the restore procedure because the information in the database does not match the DLOs, run the Reclaim Document Library Object (RCLDLO) command. Then try the restore procedure again.

**Note:** The message tells you if the RCLDLO procedure is necessary. Use RCLDLO only if you are instructed by a message or by the recovery checklist you are using.

## Authority Required to Restore DLOs

If you are restoring DLOs into a folder, you must have authority to the folder. If you are restoring existing DLOs, you must have authority to those DLOs. Certain combinations of the RSTDLO command require additional authority. The *iSeries Security Reference* book provides information about the specific authorities that are required for the RSTDLO command.

## How the System Restores New DLOs

When you restore new DLOs, the system files them. The DLO is treated as new to the system if any of the following is true:

- It has been previously deleted.
- It is being restored to a different system.
- It is being restored with the NEWOBJ(\*NEW) parameter.

## How the System Restores Existing DLOs

When you are restoring an existing DLO, the system skips the DLO and continues with the next one if either of the following is true:

- The DLO is in use.
- You do not have the necessary authority.

If the existing document is damaged, some of the security information may be lost. The restore operation continues and a message is sent informing you that the document is damaged and some of the security information is lost.

## Size Limitations When Restoring Document Library Objects

On V2R3 or later, you cannot restore more than 349 000 objects to a single library. Before V2R3, the limit is 250 000 objects from a single library. Because DLOs are nominally stored in libraries, this limit applies to the QDOC library in the system ASP and to the QDOCnnnn libraries in user ASPs.

## Restoring Folders

To restore a folder object, the entire folder (the folder object plus all document and folder objects within it) must also be restored. However, if the specific folder being restored was stored in other folders at the time it was saved, those higher level folders do not have to be restored to restore the specific folder.

When you restore a folder, the fully qualified folder path name you are restoring must exist unless you are restoring a first-level folder. For example, if you save folder A and then delete it, you can enter RSTDLO DLO(\*ALL) SAVFLR(A) and restore folder A in addition to all the documents and folders in it. However, if you want to restore folder A/B/C/D, you must create folder A, then folder B in folder A,



then folder C in folder A/B, before you can restore folder D in folder C. You only have to create the folders that comprise the A/B/C path, and you do not have to create folder D in folder A/B/C before you can restore it.

If you try to restore a folder that is in use, the system bypasses restoring the folder and all the DLOs in it.

If you try to restore into an existing folder but the folder is damaged and cannot be reclaimed, you receive a message informing you that the folder is damaged and not restored. The folder and all documents and folders in it are not restored.

## Renaming Documents When Restoring

You can use the RENAME parameter to give documents a different name when they are restored. You can also place them in a different folder by using the RSTFLR parameter.

If renaming a document when it is restored would result in a duplicate name in a folder, the system does the following:

- If ALWOBJDIF(\*NONE) is specified, the document is not restored.
- If ALWOBJDIF(\*ALL) is specified, the document is restored and replaces the existing document in the folder.

You can specify more than one value for the RENAME parameter. The system matches the RENAME values with the DLO values until it runs out of values for one or the other. Assume that you specify:

```
RSTDLO DLO(A B C D) SAVFLR(X) RENAME(J K L) RSTFLR(Y)
```

After the restore operation, you would have these documents:

- Document J in folder Y
- Document K in folder Y
- Document L in folder Y
- Document D in folder Y

## How the System Restores Descriptive Information for DLOs

The creation date, file date, and revision date for restored documents and folders are set as follows:

- The creation date of the document or folder on the save media is restored with the document or folder.
- When the RSTDLO command replaces a document or folder, the file date of the document or folder being replaced on the system is used.
- The object revision date is set to the current date when the document or folder is restored.
- The content revision date of the document on the save media is restored with the document.
- The content revision date is set to the current date when replacing a folder.
- The content revision date of the folder on the save media is restored with the folder if the folder is new.

## How the System Restores Authority and Ownership for DLOs

“How the System Establishes Ownership for Restored Objects” on page 206 and “Restoring Object Authorities” on page 206 describe how the system handles ownership and authority when restoring objects. These same rules apply when restoring DLOs, with these additions:

- If the user profile that owns a DLO is not in the system distribution directory, ownership is assigned to the QDFTOWN user profile.
- When you restore a DLO that does not exist on the system, any access codes and explicit users are removed. If you have restored user profiles and you later run the RSTAUT command, the private authorities to the DLO are restored. The access codes are not restored.

## When to Run the Rename Directory (RNMDIRE) Command

When you need to run the Rename Directory Entry (RNMDIRE) command for a local user, schedule it just before you perform the following operations:

- Saving mail
- Saving the system distribution directory

If the rename operation is performed just before saving the mail and the directory, the changed information is saved and the information will be the same as what is on the system. If the information on the media does not match the information on the system, the mail will not be restored during the restore operation.

## When to Run the Rename Document Library Object (RNMDLO) Command

When you need to run the Rename Document Library Object (RNMDLO) command, schedule it just before you back up document library objects. If the rename operation is performed just before saving the document library object, the changed name is saved and the information on the media will be the same as what is on the system.

If you rename a document library object after a save operation, the document library object name on the system is different than the name on the media. However, the system object names remain the same. The restore operation fails because the system thinks that the document library object already exists. Message CPF90A3 or CPF909C is sent indicating that the document or folder already exists.

Do one of the following:

- To create a new document or folder, specify NEWOBJ(\*NEW).
- To replace an existing document, specify RENAME(*document-name*), where *document-name* is the name that is given to the document by the RNMDLO command.
- To replace an existing folder, specify RSTFLR(*folder-name*), where *folder-name* is the name that is given to the folder by the RNMDLO command.

---

## Restoring Objects in Directories

Use the RST (Restore) command to restore objects that you have saved with the SAV command. These commands are most commonly used to save and restore objects the "root" file system, the QOpenSys file system, and the QNTC file system.

### Attention!

If you have related objects, such as journals and journaled objects, you must ensure that you restore them in the correct sequence. Read "Sequence for Restoring Related Objects" on page 34.

If you are restoring to a different system or different logical partitions, specify ALWOBJDIF(\*ALL) when you are restoring directories.

You can use the RST command to restore:

- A specific object
- A directory or subdirectory
- An entire file system
- Objects that meet search criteria
- A list of object path names

You can also restore the items in the preceding list by using the QsrRestore API. For more information, look in the Information Center under the Programming topic at the following Web site:  
<http://www.ibm.com/eserver/iseres/infocenter>.

For example, to restore all objects (or changed objects) in directories, use the following:

```
RST DEV('/QSYS.LIB/media-device-name.DEVD')  
  OBJ('//*') ('/QSYS.LIB' *OMIT) ('/QDLS' *OMIT))
```

**Note:** This example is the same restore (RST) command that is issued under option 21 on the Restore menu.

You can rename an object or restore it to a different directory by using the new-name element of the object (OBJ) parameter.

The OBJ parameter on the RST command supports the use of wildcard characters and the directory hierarchy. When you have a specific subset of similar objects within a directory subtree that you want to restore, you can use the Name pattern (PATTERN) parameter to further define the objects that are identified in the (OBJ) parameter. For more information about how to specify object names when you use integrated file system commands, look at the Information Center at the following Web site:

<http://www.ibm.com/eserver/iseres/infocenter>.

Some file systems allow you to name the same physical object different ways by using aliases and links. For examples of objects with links and how those objects are saved, go to the Backing up your system topic on the Information Center.

In the example of Figure 26, FILEA in the JCHDIR directory and FILEB in the DRHDIR directory are both hard links to the same file. They point to the same object. They can have the same name or different names for the objects.

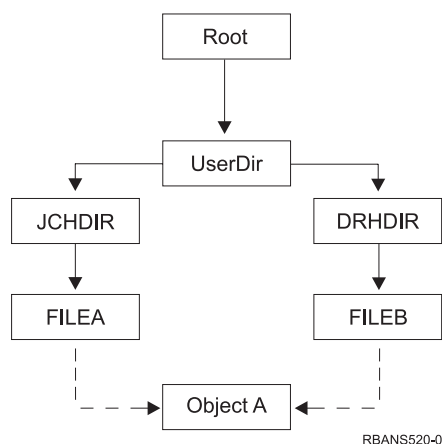

Figure 26. An Object with Hard Links—Example

Table 53 on page 250 shows several examples of how the system restores these objects. These examples assume that you use this SAV command: SAV OBJ('/UserDir/\*'). The media volume contains OBJECT A and both hard links that point to the object.

Table 53. Restoring Objects That Have Hard Links

Object Parameter on RST Command	Objects That Are on the System before the RST Command	Objects after the RST Command
RST OBJ('/UserDir/*')	JCHDIR/FILEA	The saved data is restored. The object DRHDIR/FILEB is created on the system. It points to the same object as JCHDIR/FILEA.
RST OBJ('/UserDir/DRHDIR/*')	JCHDIR/FILEA	A new object, DRHDIR/FILEB, is created. The JCHDIR/FILEA that exists on the system is not affected by the restore operation.
OBJ('/UserDir/*'), or OBJ('/UserDir/JCHDIR/*'), or OBJ('/UserDir/DRHDIR/*')	JCHDIR/FILEA, DRHDIR/FILEB	Data from the media copy of FILEA and FILEB is restored over the system copy because the same name is specified as a name that already exists on the system.
RST	CRTPRNDIR	If parent directories of objects being restored do not exist CRTPRNDIR specifies if they should be created.
RST	PRNDIROWN	PRNDIROWN specifies the name of an existing user profile that will own parent directories created by the restore.

Figure 27 shows the symbolic link called customer that points in the CUSTLIB library.

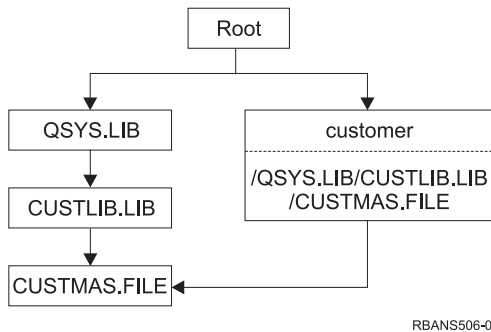

Figure 27. An Object with a Symbolic Link—Example

If you restore the customer object (RST OBJ('/customer')), you are restoring only the fact that it points to the CUSTMAS file, not the file itself. If the CUSTMAS file does not exist, the restore operation succeeds. However, if you try to use the customer object, you receive an error message. If you restore the CUSTMAS file or create it again, the symbolic link between customer and the CUSTMAS file is re-established.

## Completing Recovery for the IBM iSeries Integration for Windows Server Product

### Recovery for save performed with Integrated xSeries Server varied off

If you completely saved your directories with the Integrated xSeries Server varied off, your system restores Windows server on iSeries data. You need to perform the following steps to complete the recovery of these products:

1. To add the links for the server descriptions, type the following for each server description:  

```
ADDNWSSTGL NWSSTG(Storage_Name)
           NWS( Server_Description)
```
2. Vary on your Integrated xSeries Servers by typing WRKCFGSTS \*NWS and selecting option 1 to vary on each Integrated xSeries Server.

**Note:** If you saved the Server Storage space beneath QFPNWSSTG (by using the command SAV OBJ('/QFPNWSSTG/Server\_Storage')), you must create the QFPNWSSTG first. Create /QFPNWSSTG by performing the following steps:

1. Create the server storage by using the CRTNWSSTG command.
2. RST OBJ('/QFPNWSSTG/Server\_Storage')
3. Add the storage link by using the ADDNWSSTGL command.
4. Vary on the Integrated xSeries Server by typing WRKCFGSTS \*NWS and selecting option 1 to vary on.

## Recovery for save performed with Integrated xSeries Server varied on

Perform the following steps for Windows server on iSeries:

1. If you have any Integrated xSeries Servers that are varied on, vary them off by using the WRKCFGSTS \*NWS command and selecting option 2.
2. Create any needed Network Storages by using the CRTNWSSTG command.
3. Add the storage links by using the ADDNWSSTGL command.
4. Vary on your Integrated xSeries Servers by using the WRKCFGSTS \*NWS command and selecting option 1.
5. Format the new storage spaces for Windows.
6. Restore the Windows server data by typing RST DEV('/qsys.lib/tapxx.devd') OBJ('/QNTC/\*') and press the Enter key.

## Recovering Linux or AIX in a Partition

If you completely saved your directories with the network server description (NWS) for Linux or AIX varied off, your system restores Linux or AIX data. You need to perform the following steps to complete the recovery of Linux or AIX:

1. To add the links for the server descriptions, type the following for each server description:  

```
ADDNWSSTGL NWSSTG(Storage_Name)
           NWS( Server_Description)
```
2. Vary on your NWS for Linux or AIX by typing WRKCFGSTS \*NWS and selecting option 1 to vary on each NWS for Linux or AIX.

**Note:** If you saved the Server Storage space beneath QFPNWSSTG (by using the command SAV OBJ('/QFPNWSSTG/Server\_Storage')), you must create the QFPNWSSTG first. Create the storage space by performing the following steps:

1. Create the server storage by using the CRTNWSSTG command.
2. RST OBJ('/QFPNWSSTG/Server\_Storage')
3. Add the storage link by using the ADDNWSSTGL command.
4. Vary on the NWS for Linux or AIX by typing WRKCFGSTS \*NWS and selecting option 1 to vary on.

**Note:** Linux or AIX (\*GUEST) NWSs that use an NWSSTG as the IPL source (IPLSRC(\*NWSSTG)) or use a stream file as the IPL source (IPLSRC(\*STMF)) will be fully saved and restored using Option 21. \*GUEST NWSs that use IPLSRC(A), IPLSRC(B), or IPLSRC(PANEL) will NOT be able to start on a system restored from an Option 21 save and will require additional actions, such as booting Linux or AIX from the original installation media, to be recovered.

## Recovery Steps for i5/OS Enhanced Integration for Novell NetWare

i5/OS Enhanced Integration for Novell NetWare runs on a remote server. Your iSeries server communicates with the remote server through /QNetWare, but it saves all of the Netware data on remote server storage.

i5/OS Enhanced Integration for Novell NetWare runs on a remote server. Your iSeries server communicates with the remote server through /QNetWare, but it saves all of the Netware data on remote server storage.

The previous i5/OS Integration for Novell NetWare ran on an Integrated xSeries Server which meant that you restored both the /QNetWare subdirectory and Netware server storage when you restored your server.

Your second option is to restore your server to the point that you can start your network descriptions and save the data from your remote Netware server through /QNetWare. This is very slow, however.

A better choice is to consider your remote server like a personal computer workstation and save the Netware data with workstation backup software. You can save the remote directories on your Netware Server with ARCserve or SBACKup utilities after you vary the Integrated xSeries Server on.

Refer to the ARCserve or SBACKup documentation for the recovery steps.

For additional information about NetWare environment, refer to the Information Center at the following Web site: <http://www.ibm.com/eserver/iseries/infocenter>.

---

## Recovering a Domino Server

The Domino product resides in libraries in the QSYS.LIB file system on your server. All of your Domino databases reside in the integrated file system in a directory path that you specify when you configure your server. Your backup strategy for your Domino server should include saving both the libraries (infrequently) and the database directories (frequently).

You might need to recover Domino for a variety of reasons, for example:

- Damage to your server, such as fire or flooding
- Hardware problems, such as a disk failure
- User or operator error, such as deleting a database or running a month-end procedure twice.

Sometimes, you must recover your entire server. Other times, you must restore a specific directory. The following topics provide general information about recovery procedures for Domino.

- "Recovering an entire Domino server"
- "Recovering Domino mail" on page 253
- "Recovering specific Domino databases" on page 253
- "Restoring changed objects to a Domino server" on page 254

## Recovering an entire Domino server

If you are faced with a system disaster, such as a site loss or the failure of an unprotected disk unit, you must recover (restore) your entire server from a backup. Because the iSeries and AS/400 servers are highly integrated systems, you must restore objects in the correct sequence to rebuild the proper links between objects. Consult other parts of this book for complete instructions for performing a full system recovery.

If you are faced with a problem that requires restoring only your Domino server, you can use the Restore (RST) command to restore your Domino directories from save media. Following is an example of the steps.

### Example

1. Start an iSeries session with a user profile that has \*JOBCTL and \*SAVSYS special authorities.
2. To ensure that no one is using the server that you plan to restore, stop the server. Use the End Domino Server (ENDDOMSVR) command.
3. Mount the media volume that has the most recent backup copy of the directories for the server.
4. Type the appropriate restore (RST) command for your Domino directory. For example, if your Domino directory is /NOTES/DATA, type the following command:

```
RST DEV('/QSYS.LIB/media-device-name.DEVD')
    OBJ('/NOTES/DATA/*')
```

**Note:** Consult your Domino documentation for any special recovery activities that you might need to perform after you have restored the directories.

## Recovering Domino mail

If you need to recover one or more mail databases from your backup save media, use the Restore (RST) command. Following is an example of the steps:

1. Start an iSeries session with a user profile that has \*JOBCTL and \*SAVSYS special authorities.
2. Stop the server that contains the mail databases that you want to restore. Use the End Domino Server (ENDDOMSVR) command.
3. Mount the media volume that has the most recent backup of the mail databases.
4. Type the appropriate Restore (RST) command for the mail databases that you want to restore. For example, to restore all the databases to the MAIL subdirectory, type the following command:

```
RST DEV('/QSYS.LIB/media-device-name.DEVD')
    OBJ('/NOTES/DATA/MAIL/*')
```

### Examples

- The name of a user's mail database is usually the user's ID (short name) with the .NSF extension. (The Domino administrator has the option to use different names for mail database files.) To restore a specific user's mail database, such as the mail database for user GNELSON, use the following command:

```
RST DEV('/QSYS.LIB/media-device-name.DEVD')
    OBJ('/NOTES/DATA/MAIL/GNELSON.NSF')
```

- You can specify more than one file on the restore command. To restore mail databases for GNELSON, LSMITH, and JPETERS, use the following command:

```
RST DEV('/QSYS.LIB/media-device-name.DEVD')
    OBJ((' /NOTES/DATA/MAIL/GNELSON.NSF'
        (' /NOTES/DATA/MAIL/LSMITH.NSF'
         (' /NOTES/DATA/MAIL/JPETERS.NSF'))))
```

### Notes<sup>®</sup> about the examples:

1. All of the examples assume that the directory for your Domino server is /NOTES/DATA.
2. You cannot restore over a database that is in use. All users must close the database before you can restore a backup copy.
3. Consult your Domino documentation for any special recovery activities that you might need to perform after you have restored Domino mail.

## Recovering specific Domino databases

You might need to restore a specific Domino database or a group of databases. Use the Restore (RST) command. Following is an example of the steps for restoring all the files to the HRDPT subdirectory:

1. Start an iSeries session with a user profile that has \*JOBCTL and \*SAVSYS special authorities.

2. Stop the server that contains the databases that you want to restore. Use the End Domino Server (ENDDOMSVR) command. (You can restore a database when the server is running. However, you need to make sure that no one is using the database. Stopping the server is the best way to ensure that no one is using the database.)
3. Mount the media volume that has the most recent backup of the databases.
4. Type the appropriate Restore (RST) command for the mail files that you want to restore. For example, to restore all the files to the MAIL subdirectory, type the following command:

```
RST DEV('/QSYS.LIB/media-device-name.DEVD')
    OBJ('/NOTES/DATA/HRDPT/*.NSF')
```

### Examples

- To restore a specific database that is named HRINFO to the HRDPT subdirectory (folder), type the following:

```
RST DEV('/QSYS.LIB/media-device-name.DEVD')
    OBJ('/NOTES/DATA/HRDPT/HRINFO.NSF')
```

- To restore all the Domino databases to the CUSTSVC subdirectory, type the following:

```
RST DEV('/QSYS.LIB/media-device-name.DEVD')
    OBJ('/NOTES/DATA/CUSTSVC/*.NSF')
```

- To restore all the Domino databases whose name begins with INV to the main directory for your server, type the following:

```
RST DEV('/QSYS.LIB/media-device-name.DEVD')
    OBJ('/NOTES/DATA/INV*.NSF')
```

### Notes about the examples:

1. All of the examples assume that the directory for your Domino server is /NOTES/DATA.
2. You cannot restore over a database that is in use. All users must close the database before you can restore a backup copy.
3. Consult your Domino documentation for any special recovery activities that you might need to perform after you have restored a Domino database.

## Restoring changed objects to a Domino server

To reduce the length of your backup window, your save strategy might include saving only changed objects from your Domino during the business week. When you need to use this save media to recover, you must decide your recovery sequence and determine the location of the most recent copy of each database. Following are examples of different recovery scenarios and an overview of the recovery steps for each.

### Example: Restoring changed Domino objects from a cumulative backup

Assume that your strategy for saving changed objects is cumulative (each night you save everything that changed since the last complete backup). To recover your entire Domino directory, do the following:

1. Start an iSeries session with a user profile that has \*JOBCTL and \*SAVSYS special authorities.
2. To ensure that no one is using the databases, stop the Domino server. Use the End Domino Server (ENDDOMSVR) command.
3. Locate the save media from your most recent complete backup. Mount the correct media volume in the save device.
4. To restore the entire Domino database directory, use the Restore (RST) command. For example,

```
RST DEV('/QSYS.LIB/media-device-name.DEVD')
    OBJ('/NOTES/DATA/*')
```

5. Locate your most recent save media (from saving changed objects).
6. To restore all the objects on the save media (everything that has changed since your full backup), type the following:

```
RST DEV('/QSYS.LIB/media-device-name.DEVD')
    OBJ('/NOTES/DATA/*')
```



**Notes about the example:**

1. All of the examples assume that the directory for your Domino server is /NOTES/DATA.
2. You cannot restore over a database that is in use. All users must close the database before you can restore a backup copy.
3. Consult your Domino documentation for any special recovery activities that you might need to perform after you have restored a Domino database.

**Example: Restoring changed Domino objects from a nightly backup**

Assume that your strategy for saving changed objects is nightly (each night you save only objects that changed since the previous night). To recover your entire Domino directory, do the following:

1. Start an iSeries session with a user profile that has \*JOBCTL and \*SAVSYS special authorities.
2. To ensure that no one is using the databases, stop the Domino server. Use the End Domino Server (ENDDOMSVR) command.
3. Locate the save media from your most recent complete backup. Mount the correct media volume in the save device.
4. To restore the entire Domino database directory, use the Restore (RST) command. For example,  

```
RST DEV('/QSYS.LIB/media-device-name.DEVD')
    OBJ('/NOTES/DATA/*')
```
5. Locate your first save media volume (from saving changed objects). For example, if you save everything on Saturday night, locate your save media from Sunday night.
6. To restore all the objects on the save media (everything that has changed since the previous night), type the following:  

```
RST DEV('/QSYS.LIB/media-device-name.DEVD')
    OBJ('/NOTES/DATA/*')
```
7. Repeat steps 5 and 6 for each nightly save media until your directory is current. For example, if you are restoring on Thursday, you will need to use the media volumes for Monday, Tuesday, and Wednesday nights.

**Notes about the example:**

1. All of the examples assume that the directory for your Domino server is /NOTES/DATA.
2. You cannot restore over a database that is in use. All users must close the database before you can restore a backup copy.
3. Consult your Domino documentation for any special recovery activities that you might need to perform after you have restored a Domino database.

**Example: Restoring Domino databases from an incremental backup**

To restore a specific database that is named HRINFO to the HRDPT subdirectory (folder), do the following:

1. Start an iSeries session with a user profile that has \*JOBCTL and \*SAVSYS special authorities.
2. To ensure that no one is using the databases, stop the Domino server. Use the End Domino Server (ENDDOMSVR) command.
3. Locate the most recent save media that has the database. Do one of the following:
  - Consult the log that the system creates during the save operation.
  - Use the Display Tape (DSPTAP) or the Display Optical (DSPOPT) command to display the contents of the save media volume.
4. Mount the save media volume in the save device.
5. To restore the database, type the following:  

```
RST DEV('/QSYS.LIB/media-device-name.DEVD')
    OBJ('/NOTES/DATA/HRDPT/HRINFO.NSF')
```

**Notes about the example:**

1. All of the examples assume that the directory for your Domino server is /NOTES/DATA.

2. You cannot restore over a database that is in use. All users must close the database before you can restore a backup copy.
3. Consult your Domino documentation for any special recovery activities that you might need to perform after you have restored a Domino database.

### **Example: Restoring changed objects from a specific Domino subdirectory**

To restore all the Domino databases to the CUSTSVC subdirectory, use the same approach that you use to recover the entire server. Do the following:

1. Start an iSeries session with a user profile that has \*JOBCTL and \*SAVSYS special authorities.
2. To ensure that no one is using the databases, stop the Domino server. Use the End Domino Server (ENDDOMSVR) command.
3. Locate the save media from your most recent complete backup. Mount the correct media volume in the save device.
4. To restore the entire directory from the media volumes from your last full save, use the RST (Restore) command:

```
RST DEV('/QSYS.LIB/media-device-name.DEVD')
    OBJ('/NOTES/DATA/CUSTSVC/*')
```

5. If your incremental backup media volumes are cumulative, mount your most recent incremental backup media volume. Use the same restore command (step 4) to restore the changes.

Otherwise, if your backup media volumes are nightly, repeat step 4 for each incremental backup media volume. Start with the oldest volume and work forward.

#### **Notes about the example:**

1. All of the examples assume that the directory for your Domino server is /NOTES/DATA.
2. You cannot restore over a database that is in use. All users must close the database before you can restore a backup copy.
3. Consult your Domino documentation for any special recovery activities that you might need to perform after you have restored a Domino database.

---

## **Restoring a Windows server**

Information for restoring a Windows server is in the Information Center. You can access the Information Center at the following Web site:

<http://www.ibm.com/eserver/series/infocenter>

---

## **Restrictions When Using the Restore Command**

The RST command can be used to restore objects to any file system. The topics that follow describe restrictions that apply when using the RST command.

**Restrictions When Restoring Objects to Multiple File Systems:** When you use the RST command to restore objects to more than one file system at the same time and the file systems include the QSYS.LIB file system or the QDLS file system, the following restrictions apply:

- Different file systems support different types of objects and different methods of naming objects. Therefore, when you restore objects from more than one file system with the same command, you cannot specify object names or object types. You can restore all objects from all file systems, or you can omit some file systems. These combinations are valid:
  - Restoring all objects on the system: OBJ('/\*')

**Note:** Using this command is not the same as using option 21 from the Restore menu. Following are the differences between SAV OBJ('/\*') and option 21:

- RST OBJ('/\*') does not put the system in a restricted state.
- RST OBJ('/\*') does not start the controlling subsystem when it finishes.

- RST OBJ('/\*') does not provide prompting to change default options.
  - Restoring all objects in all file systems except the QSYS.LIB file system and the QDLS file system: OBJ('/\*') ('/QSYS.LIB' \*OMIT) ('/QDLS' \*OMIT))
  - Restoring all objects in all file systems except the QSYS.LIB file system, the QDLS file system, and one or more other file systems: OBJ('/\*') ('/QSYS.LIB' \*OMIT) ('/QDLS' \*OMIT) ('/other values' \*OMIT))
- Values for other parameters of the RST command are supported only for some file systems. You must choose values that are supported by all file systems. Specify the following parameters and values:

**OPTION**

\*ALL

**ALWOBJDIF**

\*NONE or \*ALL

**LABEL**

\*SEARCH

**OUTPUT**

\*NONE

**SUBTREE**

\*ALL

**SYSTEM**

\*LCL

**DEV** (Must be a tape device or an optical device)

**VOL** \*MOUNTED

- When you specify RST OBJ('/\*'), the following applies:
  - The system restores only objects that are saved by SAV OBJ('/\*').
  - The system must be in a restricted state.
  - You must have \*SAVSYS or \*ALLOBJ special authority.
  - You cannot specify the save file for the DEV parameter.
  - You must specify SEQNBR(\*SEARCH).

**Note:** RST OBJ('/\*') is not the recommended method for restoring the entire system. Chapter 3, "Selecting the Appropriate Recovery Strategy" describes how to determine the recovery procedure for your situation.

**Restrictions When Restoring Objects to the QSYS.LIB File System:** When you use the RST command to restore objects to the QSYS.LIB (library) file system, the following restrictions apply:

- The OBJ parameter must have only one name.
- You specify objects in the same way that you specify them on the RSTOBJ command and the RSTLIB command. Table 54 shows the valid options for the Object (OBJ) parameter when restoring objects to the QSYS.LIB file system and the equivalent RSTOBJ or RSTLIB command:

Table 54. Using the RST Command for QSYS.LIB Objects

Object Parameter on RST Command	Equivalent RSTxxx Command
OBJ('/QSYS.LIB/library-name.LIB')	RSTLIB SAVLIB(library-name)
OBJ('/QSYS.LIB/library-name.LIB/*')	RSTOBJ SAVLIB(library-name) OBJ(*ALL) OBJTYPE(*ALL)
OBJ('/QSYS.LIB/library-name.LIB/*.object-type')	RSTOBJ SAVLIB(library-name) OBJ(*ALL) OBJTYPE(object-type) FILEMBR(*ALL)

Table 54. Using the RST Command for QSYS.LIB Objects (continued)

Object Parameter on RST Command	Equivalent RSTxxx Command
OBJ('/QSYS.LIB/library-name.LIB/object-name.object-type')	RSTOBJ SAVLIB(library-name) OBJ(object-name) OBJTYPE(object-type)
OBJ('/QSYS.LIB/library-name.LIB/file-name.FILE/*')	RSTOBJ SAVLIB(library-name) OBJ(file-name) OBJTYPE(*FILE)
OBJ('/QSYS.LIB/library-name.LIB/file-name.FILE/*.MBR')	RSTOBJ SAVLIB(library-name) OBJ(file-name) OBJTYPE(*FILE)
OBJ('/QSYS.LIB/library-name.LIB/file-name.FILE/ member-name.MBR')	RSTOBJ SAVLIB(library-name) OBJ(file-name) OBJTYPE(*FILE) FILEMBR((*ALL) (member-name))

- You can specify only object types that are allowed on the RSTOBJ command. For example, you cannot use the RST command to restore user profiles because OBJTYPE(\*USRPRF) is not allowed on the RSTOBJ command.
- Some libraries in the QSYS.LIB file system cannot be restored with the RSTLIB command because of the type of information they contain. Following are examples:
  - The QDOC library, because it contains documents.
  - The QSYS library, because it contains system objects.

You cannot use the RST command to restore these entire libraries:

QDOC	QSRV	QSPLxxxx <sup>2</sup>
QDOCxxxx <sup>1</sup>	QSPL	
QRECOVERY	QSYS	
QRPLOBJ	QTEMP	

<sup>1</sup> Where xxxx is a value from 2 to 32, corresponding to an ASP.

<sup>2</sup> Where xxxx is a value from 2 to 255, corresponding to an ASP.

- You can use the new-name element of the object parameter to rename an object in a directory, restore an object to a different directory, or restore an object to a different library. Table 55 shows some examples:

Table 55. New Name Options on the RST Command—Examples

Object Parameter on RST Command	Results
OBJ((' /DBSDIR/FILEB' *INCLUDE ' /DBSDIR/FILEX'))	FILEX is created in the DBSDIR directory. The data that was saved with FILEB is restored to FILEX. If FILEB still exists on the system, it is not changed.
OBJ((' /DBSDIR/FILE*' *INCLUDE LMSDIR))	Restores all objects from the DBSDIR whose names begin with FILE to the LMSDIR directory.
OBJ((' /QSYS.LIB/LIB1.LIB'))	Library LIB1 (and all objects) are restored as library LIB2.
OBJ((' /QSYS.LIB/LIB2.LIB/*' *INCLUDE ' /QSYS.LIB/LIB2.LIB'))	All the objects of library LIB1 are restored into library LIB2.
OBJ(' /QSYS.LIB/LIB2.LIB/*.type')	All objects of type 'type' from library LIB1 are restored into library LIB2.

- For database file members, OPTION(\*NEW) restores members for new files only.
- Other parameters must have these values:

**SUBTREE**  
\*ALL

SYSTEM  
\*LCL

OUTPUT  
\*NONE

ALWOBJDIF  
\*ALL or \*NONE

- You can only rename the library, you cannot rename the object. The new name must be \*SAME or /QSYS.LIB/*libname*.LIB where the library that is specified by *libname* must exist.

**Restrictions When Restoring Objects to the QDLS File System:** When you use the RST command to restore objects to the QDLS (document library services) file system, the following restrictions apply:

- The OBJ parameter must have only one name.
- The OBJ and SUBTREE parameters must be one of the following:
  - OBJ('/QDLS/*path/folder-name*') SUBTREE(\*ALL)
  - OBJ('/QDLS/*path/document-name*') SUBTREE(\*OBJ)
- Other parameters must have these values:

SYSTEM  
\*LCL

OUTPUT  
\*NONE

ALWOBJDIF  
\*ALL or \*NONE

OPTION  
\*ALL

---

## How to Restore Program Temporary Fixes

If you have restored the Licensed Internal Code or the operating system, you need to ensure that the PTFs on your system are current. Do the following:

1. Print a list of all the program temporary fixes (PTFs) currently on the system. Type the following and press the Enter key:  
DSPPTF LICPGM(\*ALL) OUTPUT(\*PRINT)
2. Compare this list of PTFs with the list you printed when you saved the system. If the lists are the same, return to your recovery checklist. If PTFs are missing from the list you printed in step 1, you must apply them. Continue with the next step.
3. Find the most recent cumulative program temporary fix media. This package could be on distribution media or on a stand-alone media volume.

**Note:** If you do not have the PTFs you need, order them and apply them later. Continue with your recovery checklist.

4. You can use option 8 (Install program temporary fix package) on the Program Temporary Fix menu. All of the PTFs in the cumulative PTF package will be installed for the licensed programs you have installed on your system. Refer to the *iSeries System PTF Shipping Information Letter* for special instructions that are required.

If you want to restore individual PTFs, see the iSeries Information Center at <http://www.ibm.com/eserver/iSeries/infocenter>.

---

## | Restore system information

| The Restore System Information (RSTSYSINF) command restores a subset of the system data and objects saved by the Save System Information (SAVSYSINF) command.

| RSTSYSINF is not to be used for system upgrades or migrations.

| The RSTSYSINF does not restore:

- | • Security related system values are not restored if they have been locked. For information on how to lock and unlock security related system values, see the iSeries Information Center at <http://www.ibm.com/eserver/series/infocenter>.
- | • Objects that are in use when the Restore System Information (RSTSYSINF) command is running. This command can be run while the system is either restricted or not restricted. There will be less objects in use if the command is run while the system is restricted.

| **Note:** You will need to determine if the objects on the system are usable or if it is necessary to perform a recovery on the objects.

- | • The QPWDLVL (Password level) system value will not be restored. See Planning Password Level Changes in Chapter 7 of the iSeries Security Reference, SC41-5302 before changing the QPWDLVL system value. Also, based on the current setting of the QPWDLVL system value, QPWDMAXLEN (Maximum password length), QPWDMINLEN (Minimum password length), and QPWDVLDPGM (Password validation program) system values may not be restored.

| These are examples to restore your system using the Restore System Information (RSTSYSINF) command:

| Example 1: System information restored from TAP01

```
| RSTSYSINF DEV(TAP01)
```

| This command restores the system information from the tape put on the TAP01 tape drive.

| Example 2: System information restored from SAVF and Printed Output Generated

```
| RSTSYSINF DEV(*SAVF) SAVF(QGPL/SAVF) OUTPUT(*PRINT)
```

| This command restores the system information from the save file named SAVF in library QGPL. The information that was restored will be written to a spooled file.

| For information about the Save System Information (SAVSYSINF) command refer to the iSeries Information Center at <http://www.ibm.com/eserver/series/infocenter>.

---

## Chapter 10. How to Restore Changed Objects and Apply Journalled Changes

Figure 28 shows a typical time line for system.

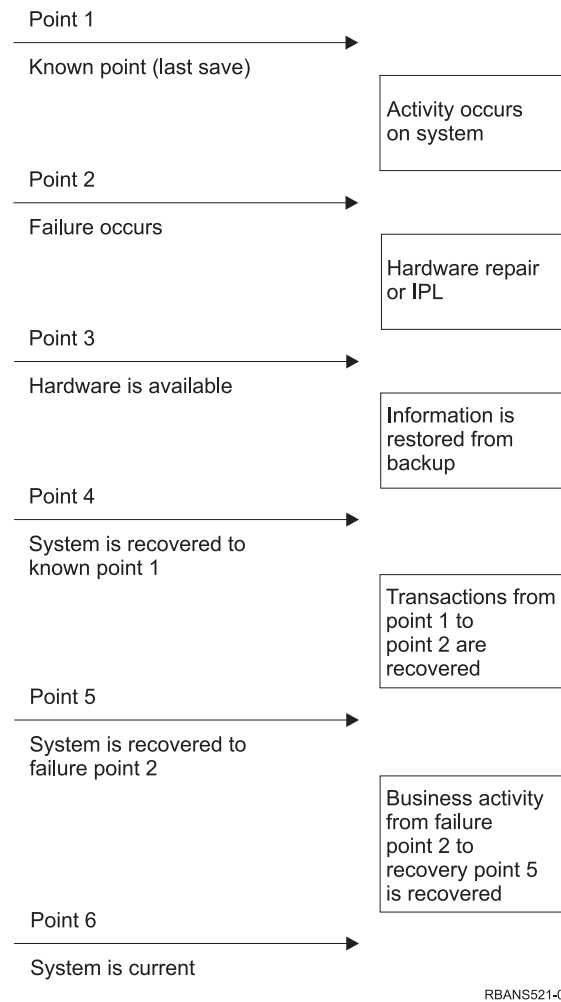

Figure 28. Sample Recovery Time Line

Chapter 4 through Chapter 9 describe what is required to reach point 4 in the time line. This returns your system to the point of the last complete save operation.

This chapter describes two procedures that are available to reach point 5 in the time line:

- Restoring changed objects
- Applying journal changes

These procedures are designed to recover activity that has occurred since the last complete save operation.

---

## Task 1–Restoring Changed Objects

The Backing up your system topic on the Information Center at the following Web site: <http://www.ibm.com/eserver/iserries/infocenter> describes two methods of saving changed objects. Table 56 shows the two methods and the correct restore procedures for each:

Table 56. Restore Procedures for Changed Objects

Save Method	Description	Restore Procedure
Cumulative	You save all changes since the last complete save operation.	“Restoring Changed Objects by Library”
Not cumulative	You save changes since the last SAVCHGOBJ operation.	“Restoring Changed Objects Individually”

**Note:** The SAVCHGOBJ command does not apply to objects in directories. If you are restoring changed objects in directories, go to “Task 2–Restoring Changed Objects in Directories” on page 263 for restore instructions from both the cumulative and not cumulative save methods.

If you save journal receivers using the SAVCHGOBJ command, read “Restoring Journal Receivers” on page 239 for special considerations that may apply when restoring them.

### Restoring Changed Objects by Library

Do the following to restore changed objects by library:

1. Load the SAVCHGOBJ media volume.
2. Type DSPTAP DEV(media-device-name) OUTPUT(\*PRINT) for tape media. Type DSPOPT VOL(\*MOUNTED) DEV(OPT01) DATA(\*SAVRST) PATH(\*ALL) OUTPUT(\*PRINT) for DVD-RAM optical media. Press the Enter key.
3. Restore the data with this command:  
RSTOBJ OBJ(\*ALL) DEV(media-device-name) SAVLIB(\*ANY)  
OBJTYPE(\*ALL) MBROPT(\*ALL)
4. If you have journaled changes to apply, continue with “Task 4–Determining What Journal Receivers to Use” on page 264. If you do not need to apply journaled changes, skip to “Task 7–Restoring Changed Documents and Folders” on page 268. If you are not sure whether you need to apply journaled changes, continue with “Task 3–Determining Whether You Need to Apply Journaled Changes” on page 263.

### Restoring Changed Objects Individually

If your method for saving changed objects is not cumulative, you may have the same object on more than one set of SAVCHGOBJ save media. You may choose to restore each set of SAVCHGOBJ save media completely, starting from the oldest media volume. This is the simplest method. However, it may be time-consuming if you have the same large objects on more than one SAVCHGOBJ media volume.

If you want to restore each set of SAVCHGOBJ save media completely, follow the procedure described in “Restoring Changed Objects by Library” for each set of save media. If you want to restore each object only once, follow this procedure:

1. Load each SAVCHGOBJ media volume.
2. Type DSPTAP DEV(media-device-name) OUTPUT(\*PRINT) and press the Enter key.
3. Compare the listings and find the most recent saved copy of each object.
4. For each object, load the correct media volume and type:

```
RSTOBJ OBJ(object-name)DEV(media-device-name)
SAVLIB(library-name) OBJTYPE(*ALL)
ENDOPT(*LEAVE) MBROPT(*ALL)
```



Repeat this step for each object you need to restore.

5. If you have journaled changes to apply, continue with “Task 4–Determining What Journal Receivers to Use” on page 264. If you do not need to apply journaled changes, skip to “Task 7–Restoring Changed Documents and Folders” on page 268. If you are not sure whether you need to apply journaled changes, continue with “Task 3–Determining Whether You Need to Apply Journaled Changes.”

---

## Task 2–Restoring Changed Objects in Directories

Perform this task if you saved changed objects in directories. If you do not need to do this task, continue with the next step in your recovery checklist.

If you use a cumulative method when you saved changed objects from directories (your save media contain all objects that have changed since the last complete save operation), do the following:

1. Mount your most recent save media from saving changed objects in directories.
2. Type:  

```
RST DEV('/QSYS.LIB/media-device-name.DEVD')
OBJ('//*') ('/QSYS.LIB' *OMIT) ('/QDLS' *OMIT)
```
3. If you have journaled changes to apply, continue with “Task 4–Determining What Journal Receivers to Use” on page 264. If you do not need to apply journaled changes, skip to “Task 7–Restoring Changed Documents and Folders” on page 268. If you are not sure whether you need to apply journaled changes, continue with “Task 3–Determining Whether You Need to Apply Journaled Changes.”

If your save media from saving changed objects in directories is not cumulative, repeat the following steps for each set of save media since your last complete save operation. Start with the oldest save media volumes and end with the most recent volumes.

1. Mount the media volume.
2. Type:  

```
RST DEV('/QSYS.LIB/media-device-name.DEVD')
OBJ('//*') ('/QSYS.LIB' *OMIT) ('/QDLS' *OMIT)
```
3. If you have journaled changes to apply, continue with “Task 4–Determining What Journal Receivers to Use” on page 264. If you do not need to apply journaled changes, skip to “Task 7–Restoring Changed Documents and Folders” on page 268. If you are not sure whether you need to apply journaled changes, continue with “Task 3–Determining Whether You Need to Apply Journaled Changes.”

---

## Task 3–Determining Whether You Need to Apply Journaled Changes

You may have set up journaling yourself, or you may be using applications that use journaling. For example, the OfficeVision program and the iSeries Access program use the QUSRSYS/QAOSDIAJRN journal. Some applications provided by software vendors also use journaling. If you have objects that are restored with partial transactions (message CPI3731), you must apply journaled changes in order to bring these objects to a usable state.

If you know you have journaled changes to apply, continue with “Task 4–Determining What Journal Receivers to Use” on page 264. If you are not sure, do the following:

1. Type `DSPOBJD OBJ(*ALL/*ALL) OBJTYPE(*JRN) OUTPUT(*PRINT)` and press the Enter key. This command prints a list of all the journals on your system.
2. For each journal on the list, do the following:
  - a. Type: `WRKJRNA JRN(library-name/journal-name)`. You are shown the Work with Journal Attributes display.
  - b. Press F19 to display the objects being journaled.
  - c. Press F12 to return to the Work with Journal Attributes display.

- d. Press F15 to display the receiver directory. Note the attach and detach times for the journal receivers in relation to your journaled objects change dates. Additionally, you can use option 8 to display specifics about each journal receiver.
  - e. Press F12 to return to the Work with Journal Attributes display.
  - f. From the information you have seen, you should be able to determine whether any objects are being journaled and whether any journal entries exist that are more recent than your most recent saved copies of the objects. You can also determine which receivers are on the system for the journal. Repeat these steps for each additional journal.
3. If you need to apply journaled changes, continue with “Task 4–Determining What Journal Receivers to Use.” If you do not need to apply journaled changes, skip to “Task 7–Restoring Changed Documents and Folders” on page 268.

---

## Task 4–Determining What Journal Receivers to Use

The next several topics describe the general procedure for applying journaled changes.

Follow this procedure:

1. Ensure that all the journal receivers required for the apply journaled changes operation are available on the system. In general, you will need all journal receivers that were attached to the journal for the length of time for which journaled changes are now to be applied to the restored files.

If you have restored objects with partial transactions, you may also need earlier receivers. Refer to any CPI3731 messages that you received during the restore to find the earliest receiver that you need. You can also use the Display File Description (DSPFD) for the files you just restored to determine the earliest receiver that is required.

2. Restore all necessary journal receivers that are not already on the system. Use the Display Journal Receiver Attributes (DSPJRNRCVA) command to determine when a journal receiver was attached to and detached from a journal.
3. Determine the name of the last journal receiver (the last receiver restored) and whether there are chain breaks by printing the receiver chain:
  - a. Type `WRKJRNA JRN(library-name/journal-name) OUTPUT(*PRINT)` and press the Enter key. You receive a listing that shows the receiver directory and all the objects being journaled.
  - b. Look at the receiver directory part of the listing. If you saved the currently attached journal receiver, your journal receiver directory should look similar to Figure 29. The journal receiver that was attached during the save procedure shows a status of `Partial`. The following example shows the displayed version of the receiver directory:

Receiver Directory						
Total size of receivers (in kilobytes). . . . . :						1507
Number	Receiver	Library	Attach Date	Save Date	Status	Size (K)
00001	RCVA0001	DSTJRN	06/08/9x	06/08/9x	SAVED	42
00002	RCVA0002	DSTJRN	06/09/9x	06/09/9x	SAVED	900
00003	RCVA0003	DSTJRN	06/09/9x	06/09/9x	PARTIAL	92
01001	RCVA1003	DSTJRN	06/10/9x	00/00/00	ATTACHED	473

Figure 29. Receiver Directory—Saving Attached Receivers

If you save only detached journal receivers, your receiver directory should look similar to Figure 30 on page 265:

		Receiver Directory				
Total size of receivers (in kilobytes). . . . . :				1507		
Number	Receiver	Library	Attach Date	Save Date	Status	Size (K)
00001	RCVA0001	DSTJRN	06/08/9x	06/08/9x	SAVED	42
00002	RCVA0002	DSTJRN	06/09/9x	06/09/9x	SAVED	900
00003	RCVA0003	DSTJRN	06/09/9x	06/09/9x	SAVED	92
01001	RCVA1003	DSTJRN	06/10/9x	00/00/00	ATTACHED	473

Figure 30. Receiver Directory—Saving Detached Receivers

- On the listing, mark the name of the last receiver with a status of SAVED or PARTIAL.
- Determine the chain of receivers to be used in the APYJRNCHG command from the Work with Receiver Directory listing. Mark the first and last receiver that you need, based on the date that you saved the objects being recovered. Notice that the first and last receiver are the same if only one journal receiver was restored.

**Note:** While looking at the receiver directory, you should also look for any receiver chain breaks. You can determine a chain break by looking at the first two digits in the *Number* column on the Work with Receiver Directory display. You cannot apply journaled changes across receiver chain breaks. Therefore, you must write down the beginning and ending receiver names for each receiver chain. Then you need to run a series of apply journaled changes operations, one for each chain using these receivers. A chain break may mean that you are missing all or part of a journal receiver. (It was on the system and was not saved before the failure occurred.) You should evaluate how applying journaled changes across a change break may affect the integrity of your data. The Journal Management topic in the iSeries Information Center (<http://www.ibm.com/eserver/iseries/infocenter>) has more information about receiver chain breaks.

- Look at the part of the listing that shows what objects are currently being journaled. (You printed the listing in step 3a on page 264.) Compare it to your records of what objects should be journaled. Follow the procedures in Printing system information before you save your system.
- For each physical file that should be journaled and does not appear on the current listing, type:
 

```
STRJRNPF FILE(library-name/file-name)
          JRN(library-name/journal-name)
```
- For each access path that should be journaled and does not appear on the current listing, type:
 

```
STRJRNAP FILE(library-name/file-name)
          JRN(library-name/journal-name)
```
- For each integrated file system object that should be journaled and does not appear on the current listing, type:
 

```
STRJRN OBJ('object-path-name')
          JRN('journal-path-name')
```
- For all other object types that should be journaled and do not appear on the current listing, type the following:
 

```
STRJRNOBJ OBJ(library-name/object-name)
            OBJTYPE(object-type)
            JRN(library-name/journal-name)
```
- The journal receiver that is currently attached may not match your naming conventions. Usually this is because the journal receiver was created when you restored the journal. If this is the case, create a new receiver that follows the same naming convention and receiver attributes as the last receiver but assign it a number of one greater. In the example shown on the Work with Receiver Directory display, you would type:
 

```
CRTJRNCV JRNCV(DSTJRN/RCVA0004)
```
- Use the CHGJRN command to detach the current receiver and attach the journal receiver you just created. In the example, you would type:

---

## Task 5—Applying Journalized Changes for User Journals

Do the following steps if you need to apply journalized changes from user journals. If you do not need to apply journalized changes, skip to “Task 6—Applying Journalized Changes for the QAOSDIAJRN Journal” on page 267.

1. If you have a single receiver chain for the journal entries that you need to apply and the status of the last receiver you are using is `SAVED`, do one of the following:

- a. For objects in libraries type the following:

```
APYJRNCHG JRN(library-name/journal-name)
           OBJ((library-name/*ALL object-type))
           RCVRNG(*LASTSAVE)
           FROMENT(*LASTSAVE) TOENT(*LAST)
```

- b. For objects in directories type the following:

```
APYJRNCHG JRN(jrnlib/jrnname)
           OBJPATH('object-path-name')
           RCVRNG(*LASTSAVE)
           FROMENT(*LASTSAVE) TOENT(*LAST)
```

**Note:** If you want to apply journalized changes to library and directory objects in the same command invocation, you can use both the `OBJ` and `OBJPATH` parameters in one `APYJRNCHG` command invocation.

- c. If you have restored objects with partial transactions, but you don't have any journal receivers more recent than the receiver that contains the save entries, you have the option to remove journal changes to resolve the partial transaction. The following command removes the changes in journal `JRN1` from all the members of `OBJ1`:

```
RMVJRNCHG JRN(JRN1) FILE(LIB1/OBJ1)
           FROMENT(*LASTSAVE) TOENT(*COMMITSTART)
           RCVRNG(*LASTSAVE)
```

Starting with the last save journal entry, only changes for journal entries for any partial transactions are removed, back to the start of the commit transaction.

- d. If you are unable to complete the previous steps for objects with partial transactions because the journal receivers are unavailable, you can use the Change Journalized Object (`CHGJRNOBJ`) command to get the object to a usable state. The Partial Transactions (`PTLTNS`) parameter allows the object to be used, but does not complete the transactions. In the example below, the object, `BRKNOBJ`, still has changes caused by the partial transactions, but you are able to open the file.

**Attention:** Only use the following command as a last resort. You **will lose data** if you use this command. You should only use this command for the following reasons:

- You have objects with partial transactions as a result of the terminations of a long-running rollback and you have no saved version to restore.
- You have objects with partial transactions as a result of a save-while-active operation, and the journal receivers required to apply or remove journalized changes have been lost, destroyed, or damaged beyond repair.

```
CHGJRNOBJ OBJECT(LIB1/BRKNOBJ *FILE) ATR(*PTLTNS) PTLTNS(*ALWUSE)
```

2. If you have determined that this journal had receiver chain breaks, you must decide whether you are actually missing journal receivers and necessary journal entries or whether the chain breaks were caused by something else. You should evaluate how applying journalized changes across a chain break may affect the integrity of your data. The Journal Management topic in the iSeries Information Center (<http://www.ibm.com/eserver/series>) provides more information about receiver chain breaks.

If you decide to apply journal entries across chain breaks, you must use a APYJRNCHG command for each chain. Type the APYJRNCHG command and use these values in place of the values shown in step 1 on page 266.

For the first (earliest) receiver chain:

**RCVRNG**

First and last receivers in this chain

**FROMENT**

\*LASTSAVE

**TOENT**

\*LAST

For each middle receiver chain:

**RCVRNG**

First and last receivers in this chain

**FROMENT**

\*FIRST

**TOENT**

\*LAST

For the last receiver chain:

**RCVRNG**

First and last receivers in this chain

**FROMENT**

\*FIRST

**TOENT**

\*LAST

---

## Task 6—Applying Journalized Changes for the QAOSDIAJRN Journal

If you have document library objects, you may need to apply journaled changes from the receivers associated with the QAOSDIAJRN journal. If you are not sure, determine when you last saved the QUSRSYS library. Then perform the steps through step 1c to determine whether you have any journal entries for the QAOSDIAJRN journal that are more recent than your save media for the QUSRSYS library.

You cannot apply all journaled changes in the QAOSDIAJRN journal in library QUSRSYS. You must specify individual files on the FILE parameter instead of \*ALL. Do not apply journal changes to the document and folder search index database files (QAOSSS10 through QAOSSS15, QAOSSS17, and QAOSSS18) for journal QAOSDIAJRN in library QUSRSYS.

1. Display the receiver chain for the QAOSDIAJRN journal by doing the following:
  - a. Type: WRKJRNA JRN(QUSRSYS/QAOSDIAJRN) and press the Enter key.
  - b. From the Work with Journal Attributes display, press F15 (Work with receiver directory). Examine the receiver directory to determine whether any chain breaks exist. (See the note on page 5 on page 265.)
  - c. Press F12 two times to return to a command line.
2. If no chain breaks exist, type the following to apply journaled changes for the QAOSDIAJRN journal to individual files:

```
APYJRNCHG JRN(QUSRSYS/QAOSDIAJRN)
          FILE((QUSRSYS/QAOKPLCA) (QUSRSYS/QAOSAY05)
              (QUSRSYS/QAOKPX4A) (QUSRSYS/QAOSAY07)
              (QUSRSYS/QAOKP01A) (QUSRSYS/QAOKP02A)
              (QUSRSYS/QAOKP03A) (QUSRSYS/QAOKP04A)
              (QUSRSYS/QAOKP05A) (QUSRSYS/QAOKP06A))
```

```
(QUSRSYS/QAOKP08A) (QUSRSYS/QAOKP09A)
RCVRNG(lib-name/first-receiver
        lib-name/last-receiver)
FROMENT(*LASTSAVE)
TOENT(*LAST)
```

3. If chain breaks exist, you must determine whether any journal receivers are missing and how that may affect the integrity of your recovery. If you decide to apply journaled changes, use the command shown in step 2 of this topic. Repeat the command for each receiver chain, substituting the correct receiver range, from-entry, and to-entry parameters. Step 2 in the topic “Task 5–Applying Journaled Changes for User Journals” on page 266 describes how to use these parameters.

---

## Task 7–Restoring Changed Documents and Folders

Perform this task if you save changed documents and folders. If you do not need to do this task, skip to “Task 2–Restoring Changed Objects in Directories” on page 263.

Do the following:

1. If your procedure for saving changed DLOs is cumulative, load the last daily SAVDLO media volume. If your procedure is not cumulative, start with your earliest daily save volume and repeat these steps for each set of SAVDLO save media.
2. If you have documents in user ASPs, display the save media volumes to find the sequence numbers for each ASP. Type `DSPTAP DEV(media-device-name) OUTPUT(*PRINT)` for tapes. Mark the names and sequence numbers of the files on the listing. They will be named QDOC for the system ASP and QDOCnnnn for each user ASP that contains DLOs, where *nnnn* is the number of the ASP.
3. To restore the DLOs to a single ASP, type:  
`RSTDLO DLO(*ALL) DEV(media-device-name) SAVFLR(*ANY)`  
`SAVASP(ASP-number) RSTASP(*SAVASP)`
4. To restore the DLOs to all ASPs, type:  
`RSTDLO DLO(*ALL) DEV(media-device-name) SAVFLR(*ANY)`  
`SAVASP(*ANY) RSTASP(*SAVASP)`
5. If an unrecoverable error occurs when running the `RSTDLO DLO(*ALL) SAVFLR(*ANY)` command, see “Recovering from an Error While Restoring DLOs” on page 48.

---

## Chapter 11. Mirrored Protection Recovery Actions

In considering aspects of recovery, you need to distinguish between *errors* and *failures* in the disk subsystem.

A disk *error* refers to an unexpected event during an I/O operation which can cause the loss or corruption of the data that is being transferred. Most disk errors are caused by a failure in some part of the component chain from the I/O processor to the disk surface. Environmental effects such as power abnormalities or severe electrostatic discharges can also cause disk errors. Included in the definition of disk errors is a failure of the Licensed Internal Code that controls the disk subsystem.

When the system detects an error, generally the occurrence is logged and the operation is attempted again. Temporary errors are those from which the system can recover and complete the I/O operation successfully. When the error is so severe that the I/O operation cannot succeed, it is a permanent error.

When the system detects a permanent error, it classifies it as a *failure* in that hardware subsystem. In an ASP that does not have mirrored protection, a failure causes the system to become unusable. The system displays an error message which contains a System Reference Code (SRC) of A6xx 0244, A6xx 0255, or A6xx 0266 where xx is incremented every minute. During this time, the system will retry the operation in which the failure occurred. If the condition that caused the failure can be corrected (for example, by powering on a disk unit or replacing an electronic component), then normal system operations are resumed.

On a system with mirrored protection, errors and failures have different effects. When a failure occurs on a system with mirrored protection, the recovery procedure is affected by the level of protection that is configured.

---

### System Actions for Permanent Errors

When a permanent error occurs and mirroring is active, the system attempts to recover. The topics that follow describe the actions the system takes for different types of permanent errors.

**Device Error:** If the system detects a device, I/O processor or bus failure on a mirrored unit, it does the following:

1. The system disables the failing unit and suspends mirroring for the pair. If the other unit in the pair is also failing or is already suspended, the first unit is considered unprotected.
2. The system sends a message that identifies the failing unit and indicates that mirroring has been suspended. You can use problem analysis on this message for more information.
3. When a disk unit is suspended following an error, the system records all updates that are performed on the active unit of the mirrored pair. If the suspended disk unit becomes usable within a short period of time, the system automatically synchronizes the data between the mirrored units.
4. After the failed unit is replaced, the system synchronizes the pair and resumes mirrored protection. The system sends a message that indicates that mirrored protection has been resumed.

**Read Error:**

1. The system reads from the other storage unit of the mirrored pair. If the permanent read error occurs on the other storage unit as well, the original read request completes with a permanent read error.
2. If the read operation from the other storage unit is successful, the data is written back to the first unit of the mirrored pair, assigning an alternate sector. Only then does the system signal that the original read request is complete.

**Connection Failure:** If the system cannot communicate with a device, it does the following:

1. The system attempts to recover from the communications error. Any job requesting the disk unit waits during the period that the system is attempting recovery.
2. If the recovery is successful, normal system operations continues.
3. If the system cannot recover within the time limit for the reset command, the unit is considered to have a device error. The system performs the steps that are described in 269.

**Load Source Unit Failure:** If an error occurs on the load source unit before the Storage Management Recovery portion of the IPL, the system does the following:

1. The system determines if the other mirrored unit in the load source mirrored pair is usable. If not, the system fails.
2. If the system is able to continue, it starts an IPL from the remaining usable unit in the load source mirrored pair.

---

## Suspending Mirrored Units

If you have to suspend a mirrored unit, you can do so using the Suspend Mirrored Protection option on the Work With Disk Unit Recovery display using SST or DST.

To suspend mirrored protection, do the following:

1. Type:  
STRSST
2. From the System Service Tools (SST) menu, do the following:
  - a. Select option 3 (Work with disk units).
  - b. Select option 3 (Work with disk unit recovery) on the Work with Disk Units display.
3. Select option 3 (Suspend mirrored protection) on the Work with Disk Unit Recovery display and press the Enter key.

Suspend Mirrored Protection							
Type option, press Enter.							
1=Suspend Mirrored Protection							
OPT	Unit	ASP	Serial Number	Type	Model	Resource Name	Status
-	1	1	00-31297	6109	030	DD002	Resuming
-	3	1	00-0184097	6602	050	DD011	Active
-	3	1	00-0125986	6602	050	DD005	Active

4. Type a 1 (Suspend Mirrored Protection) in the *Option* column for each unit that you want to suspend mirrored protection. You can suspend protection only on units that have both units in an *Active* or *Resuming* status. If one of the units is in *Resuming* status, then it is the only unit that can be selected to suspend. It takes several minutes to suspend a resuming unit that is using SST.

If you suspend a mirrored unit that is using SST, the system starts to keep a list of disk pages that are changed. If you resume mirrored protection on the suspended mirrored unit before this list becomes full, the system uses this list to copy data from only those disk pages that were changed instead of copying an entire disk.



---

## Resuming Mirrored Units

If you have to resume a mirrored unit, you can do so using the Resume Mirrored Protection option on the Work With Disk Unit Recovery display using SST or DST.

To resume mirrored protection, do the following:

1. Type:  
STRSST
2. From the System Service Tools (SST) menu, do the following:
  - a. Select option 3 (Work with disk units).
  - b. Select option 3 (Work with disk unit recovery) on the Work with Disk Units display.
3. Select option 4 (Resume mirrored protection) on the Work with Disk Unit Recovery display and press the Enter key.

Resume Mirrored Protection								
Type option, press Enter.								
1=Resume Mirrored Protection								
Resource	OPT	Unit	ASP	Serial Number	Type	Model	Name	Status
-		2	3	00-59681F7	6602	050	DD004	Suspended

4. Type a 1 (Resume Protection) in the *Option* column for each unit that you want to resume mirrored protection. You can select only a unit in *Suspended* status to resume.

---

## Replacing a Mirrored Unit

A unit selected to replace the failed mirrored unit must satisfy all of the mirrored protection configuration rules and restrictions when it is paired with the remaining unit in the mirrored pair. (See “Mirrored Protection–Configuration Rules” on page 411.)

You can replace mirrored units by using the Replace Disk Unit option in either DST or SST. To do this, you need to have a spare storage unit that can be paired with the mirrored unit of the storage unit that is being replaced. The storage unit being replaced can have a status of active or suspended. However, one of the storage units in the pair must be suspended. The results of the replace operation is different for each status. Replacing a suspended storage unit causes that storage unit to go to a status of resuming after the replace operation. Replacing an active unit causes data in the ASP to be lost, so you must first delete the data in ASP (using the DST ‘Delete ASP Data’ option). The storage unit being replaced can also be missing or not missing. To replace a unit with a status of resuming, you must suspend it. If the status of unit 1 is unknown, replace operations are not allowed until the status of the mirrored units for unit 1 is known. The unit selected to replace another mirrored unit must satisfy all of the mirrored protection configuration rules and restrictions when it is paired with the remaining unit in the mirrored pair. (See “Mirrored Protection–Configuration Rules” on page 411.)

If a storage unit fails, and if the same storage unit that failed has been repaired, it is not necessary to replace it. The failed disk should have a status of suspended and can be resumed after the repair is complete.

If the storage unit that is being replaced is active, it can only be replaced at DST before the IPL to the i5/OS licensed program. It should never be necessary to replace an active unit unless both units of the mirrored pair have failed. If this situation does occur, the service representative should first try to recover the data from the failed units using the Save Disk Unit Data option on the Work with Disk Unit Recovery

display. When an active unit is replaced, the last good copy of the data has been lost. The data in the ASP that contains the unit being replaced must be deleted using the DST 'Delete ASP Data' option before an active unit is allowed to be replaced.

Replacing unit 1 requires special handling. If the system ASP has mirrored protection, one of the units in the mirrored pair for unit 1 is selected as the IPL device. It is the only unit that is used until the system performs an IPL to the i5/OS licensed program. Until then, it cannot be replaced or even suspended. However, its mirrored unit can be both suspended and replaced. After the IPL to the i5/OS licensed program, the IPL device can be suspended and then replaced.

Replacing a unit may cause the level of protection for a mirrored pair to change. If a lower level of protection results from a replacement operation, it displays a warning screen. At certain times, especially when missing units are involved in the replace operation, the system may not be able to accurately calculate the level of protection and the same warning display is shown.

To replace a disk unit by using SST, do the following:

1. Type:  
STRSST
2. From the System Service Tools (SST) menu, do the following:
  - a. Select option 3 (Work with disk units).
  - b. Select option 3 (Work with disk unit recovery) on the Work with Disk Unit display.
3. Select option 1 (Replace configured unit) on the Work with Disk Unit Recovery display and press the Enter key.  
The Select Configured Unit to Replace display is shown.

Select Configured Unit to Replace								
Type option, press Enter.								
1=Select								
Resource	OPT	Unit	ASP	Serial Number	Type	Model	Name	Status
1		1	1	00-0163477	6602	030	DD019	Suspended
1		2	1	00-17900	6602	030	DD002	Suspended

4. Type a 1 in the *Option* column on the Select Configured Unit to Replace display and press the Enter key.

Select Replacement Unit							
Resource	Unit	ASP	Serial Number	Type	Model	Name	Status
2	1		00-17900	6602	030	DD002	Suspended
Type option, press Enter. 1=Select							
Resource	Option	Serial Number	Type	Model	Name	Status	
1		00-0330477	6602	030	DD005	Non-configured	
1		00-0323200	6602	030	DD033	Non-configured	

5. Type a 1 in the *Option* column on the Select Replacement Unit display and press the Enter key.

Confirm Replace of Configured Unit

This screen allows the confirmation of the configured unit to be replaced with the selected replacement unit. Press Enter to confirm your choices for Replace Press F12 to return to change your choices. The configured unit being replaced is:

Resource	Unit	ASP	Serial Number	Type	Model	Name	Status
2	1	00-17900	6602	030	DD002	Suspended	

The replacement unit will be:

Resource	Unit	ASP	Serial Number	Type	Model	Name	Status
2	1	00-0323200	6602	030	DD033	Resuming	

6. Press Enter to Confirm.
7. The replacement function runs for several minutes. Wait until the replacement function completes.

## Using Spare Nonconfigured Units for Replacement

If mirrored units become suspended as a result of a hardware failure, the system continues to run. However, one or more storage units will be suspended and therefore unprotected until your service representative can repair or replace the failed hardware. If you have spare nonconfigured units, you may be able to resume mirrored protection before the repair actions are done.

Call your service representative. You may be directed to examine the Service Action Log for information that is concerning the failure. Use the Display Disk Configuration Status option by using SST or the Work with Disk Status (WRKDSKSTS) command to determine which units are suspended. If all disk units under an I/O processor are suspended, the I/O processor probably has failed. If you have enough spare units of the right type and model, and if the spare units are not on the I/O processor that has failed, you may be able to use the spare nonconfigured units to resume mirrored protection.

After your service representative repairs a failed storage unit, you may want to use it instead of the spare to restore the previous level of protection. To use the repaired unit, do the following:

1. Suspend the active storage unit that was previously used as the spare by typing the following on a command line and pressing the Enter key.  
STRSST
2. From the System Service Tools (SST) menu, do the following:
  - a. Select option 3 (Work with disk units).
  - b. Select option 3 (Work with dik unit recovery) on the Work with Disk Units display.
3. Select the option 3 (Suspend mirrored protection).

Suspend Mirrored Protection

Type option, press Enter.  
1=Suspend Mirrored Protection

Resource	OPT	Unit	ASP	Serial Number	Type	Model	Name	Status
-		1	1	00-0193825	6602	030	DD001	Active
-		1	1	00-0184097	6602	030	DD019	Active
-		2	1	00-0125986	6602	030	DD036	Active
-		2	1	00-0125986	6602	030	DD002	Active

4. Type a 1 (Suspend Mirrored Protection) in the *Option* column. The original spare unit is the same disk type and model as the repaired disk unit.

5. Return to the Work with Disk Unit Recovery display by pressing F12 (Cancel)

```

Work with Disk Unit Recovery

Select one of the following:
1. Replace configured unit
2. Disk unit problem recovery procedures
3. Suspend mirrored protection
4. Resume mirrored protection
5. Delete disk unit data
6. Rebuild disk unit data
  
```

6. Select option 1 (Replace configured unit).

```

Select Configured Unit to Replace
Type option, press Enter.
1=Select

Resource OPT Unit ASP Serial
Number Type Model Name Status
1 1 1 00-0163477 6602 030 DD019 Suspended
1 2 1 00-17900 6602 030 DD002 Suspended
  
```

7. Type a 1 in the *Option* column on the Select Configured Unit to Replace display and press the Enter key.

```

Select Replacement Unit

Resource Unit ASP Serial
Number Type Model Name Status
2 1 00-17900 6602 030 DD002 Suspended

Type option, press Enter. 1=Select
Serial
Resource Option Number Type Model Name Status
1 00-0330477 6602 030 DD005 Non-configured
1 00-0323200 6602 030 DD033 Non-configured
  
```

8. Type a 1 in the *Option* column on the Select Replacement Unit display and press the Enter key.

```

Unit

This screen allows the confirmation of the configured unit to be replaced
with the selected replacement unit. Press Enter to confirm your choices for
Replace Press F12 to return to change your choices. The configured unit
being replaced is:

Resource Unit ASP Serial
Number Type Model Name Status
2 1 00-17900 6602 030 DD002 Suspended

The replacement unit will be:

Resource Unit ASP Serial
Number Type Model Name Status
2 1 00-0323200 6602 030 DD033 Resuming
  
```

9. Press Enter to confirm.

10. The replacement function runs for several minutes. Wait until the replacement function completes.

## Mirrored Protection Recovery Actions Performed by the Service Representative

The procedures that are described here are overviews of the steps and considerations involved in disk unit repair in the mirrored environment. Although your service representative performs these steps, they are included here for your information.

### Actions When Concurrent Maintenance is Possible

1. Perform problem analysis on the failing storage unit.  
Performing problem analysis may cause mirrored protection to be suspended on the failing storage unit, and in some cases, on additional storage units.
2. Power down the failing storage unit.
3. Repair or replace the failing storage unit.
4. If the Replace Configured Unit option is necessary, the new storage unit is formatted and initialized, and mirrored protection is automatically resumed.
5. Resume mirrored protection on the repaired unit, if necessary, and on any other units that were suspended as part of the repair action.  
Synchronization begins on the resuming storage units immediately, and a message is sent to the QSYSOPR message queue when synchronization completes.

### Actions When Concurrent Maintenance is Not Possible

1. Power down the system.
2. If unit 1 has failed, see “Mirrored Protection–Configuration Rules” on page 411 for restrictions that apply.
3. Perform an attended IPL to DST.
4. Perform problem analysis on the failing storage unit.  
Performing problem analysis may cause mirrored protection to be suspended on the failing storage unit, and in some cases, on additional storage units.
5. Power down the failing storage unit.
6. Repair or replace the failing storage unit.
7. If the Replace Configured Unit option is necessary, the new storage unit is formatted and initialized, and mirrored protection automatically resumes.
8. Resume mirrored protection on the repaired unit, if necessary, and on any other storage units that were suspended as part of the repair action.
9. Continue the IPL to command entry. Synchronize the resuming storage units during the IPL.

## Other Recovery Considerations for Mirrored Protection

**Message Handling:** When a system with mirrored protection experiences a disk failure, the only external indication of the failure is a message that is sent to the system operator message queue (QSYSOPR). If there is a message queue that is named QSYSMSG in the QSYS library, the messages are sent there also.

When suspended units exist, the system sends a message every hour to the QSYSOPR message queue as a reminder.

You should have a method of bringing these messages to the attention of the system administrator. If the interactive job at the console allocates the QSYSMSG message queue and places it in break mode, it notifies you of any problems. For more information on QSYSMSG, see the CL commands in the iSeries Information Center at <http://www.ibm.com/eserver/series/infocenter>.

**Synchronization:** When the system is synchronizing (resuming) a disk unit, the system response time becomes longer.

When mirrored protection is resumed on a suspended disk unit at DST, the synchronization to the i5/OS licensed program is done during the IPL.

## Mirrored Protection Disk-Error Handling

Mirrored protection handles disk errors as follows:

### *Unrecoverable device error:*

1. The system suspends the failing storage unit and mirrored protection is suspended for the mirrored pair.
2. The system continues operations by using the operating storage unit of the mirrored pair.
3. A message sent to the QSYSOPR message queue identifies the failing storage unit. It informs you that mirrored protection is suspended for the mirrored pair.

### *Permanent read error:*

1. The system reads from the other storage unit of the mirrored pair. If the permanent read error occurs on the other storage unit as well, the original read request completes with a permanent read error.
2. If the read operation from the other storage unit is successful, the data is written back to the first unit of the mirrored pair, assigning an alternate sector. Only then does the system signal that the original read request is complete.

### *Not operational storage unit:*

1. The system attempts recovery. If it is successful, normal system operations continue with mirrored protection and without suspending or synchronizing the unit.
2. If recovery is unsuccessful, the unit is considered to have an unrecoverable device error, which is processed as described previously.

### *Time-out:*

1. The system attempts to recover from the timeout. If it is successful, normal system operations continue with mirrored protection and without suspending or synchronizing this unit.
2. If recovery is unsuccessful, the storage unit is considered to have an unrecoverable device error, which is processed as described previously.

### *I/O processor or bus failure:*

1. The system suspends each disk unit that is attached to the failing I/O processor or bus in the same way it is done for an unrecoverable error.
2. The system saves a copy of the failing I/O processor's storage so the problem can be diagnosed. The system continues without the failing I/O processor.

*Disk-related failure of unit 1 before the IPL to the Operating System/400:* See "Mirrored Protection-Configuration Rules" on page 411 for restrictions that apply.

## Missing Disk Units

If a disk unit, a controller, or an I/O processor fails during an IPL, the system detects the failure and does one of the following:

- Displays an SRC on the control panel if the keylock switch is not in the Manual position.
- Displays the Missing Disk Unit display on the console if the keylock switch is in the Manual position.

If the failing unit has mirrored protection and its mirrored unit is active, the following display is shown.

### Disk Configuration Warning Report

Type option, press Enter.  
5=Display Detailed Report

Press F10 to accept all the warnings and continue the IPL.  
The system will attempt to correct the warnings.

OPT Warning  
5 Missing mirror protected units in the configuration

Type a 5 in the option column and press the Enter key.

### Suspend Missing Disk Units

The following disk units are missing from the disk configuration:

Resource	Reference	ASP	Unit	Type	Model	Serial Number	Name	Code
		1	2	6602	030	00-0190494	DD036	1713

You can suspend mirrored protection on the affected units and continue the IPL. An entry is written in the problem log. You can run problem analysis on the failing unit at a later time. The *type* and *reference code* fields can be used with the unit reference code guide to determine the cause of the problem. If the keylock switch is not in the Manual position, a system reference code is displayed on the control panel. If the affected units do not report to the system within six minutes, the system automatically suspends mirrored protection on the affected units and continues the IPL.

If the suspended disk units become ready before the system is powered down, the system will automatically resume mirrored protection on these units.

## Saving a Unit

The system allows you to save data from storage units that use the DST Save Disk Unit Data option.

The following rules apply to saving units on a system with mirrored protection:

- Only configured units can be saved.
- The save operation is not allowed when both mirrored units of a mirrored pair are active. Only one of the mirrored units can be saved. Therefore, one mirrored unit must be suspended.
- Only the active unit of a mirrored pair can be saved because the active unit contains the current data.
- If multiple failures cause the state of unit 1 to be unknown, saving of any storage unit is not allowed.

## Restoring a Unit

In the mirrored environment, the system allows you to restore data to storage units.

The following rules apply to restoring units on a system with mirrored protection:

- The restore is possible only for an active device.
- This option can restore to either a configured or nonconfigured disk unit.
- The restore operation requires that the unit restored to is as large as or larger than the unit saved.
- The restore operation is not permitted if the state of a unit is unknown. You can restore unit 1 only to the IPL device.
- After a unit is restored, the system performs an IPL to DST.

- The unit being restored must satisfy all mirrored protection configuration rules and restrictions.

## Active Mirrored Load Source Failure

If unit 1 is mirrored, the system attempts to IPL from a load source mirrored unit that contains Licensed Internal Code and system data. The mirrored unit state of that storage unit will be *active*.

### System Cannot Find Active Mirrored Load Source for IPL

If the system cannot find a load source unit that contains current data and can only find a load source unit that is *suspended* or *resuming*, the system will IPL on the suspended/resuming unit. That unit contains back-level data. The system cannot be used until it finds or repairs the active mirrored load source.

If the system has not been able to IPL on an active mirrored load source, it is presumed to be broken in some way, and the following screens are displayed.

```

Disk Configuration Error Report

Type option, press Enter.
 5=Display Detailed Report

OPT   Error
 5    Load source failure

```

Type a 5 in the option column and press the Enter key.

```

Display Load Source Failure

The system could not use the load source disk unit that
contains correct data.

The following disk unit contains the correct data:

Disk unit:
Type . . . . . : 6603
Model . . . . . : 030
Serial number . . . . . : 00-0193825
Resource name . . . . . : DD001

Press Enter to use Dedicated Service Tools (DST).

```

### Active Mirrored Load Source Being Used for IPL Fails

If the system is IPLing on an active mirrored load source and that storage unit fails during the IPL to DST or at DST, the system attempts to perform a directed IPL to the other storage unit (tries to re-IPL on the remaining load source).

- If the directed IPL fails, the system ends abnormally and displays a system reference code.
- If the remaining storage unit of the load source mirrored pair is active and the original load source is still broken on the re-IPL, the broken load source is treated like any other missing mirrored unit, and the following are displayed:



```

Disk Configuration Warning Report
Type option, press Enter.
  5=Display Detailed Report

Press F10 to accept all the warnings and continue the IPL.
The system will attempt to correct the warnings.

OPT Warning
  5 Missing mirror protected units in the configuration

```

Type a 5 in the option column and press the Enter key.

```

Suspend Missing Disk Units
The following disk units are missing from the disk configuration:
Serial
Resource Reference ASP Unit Type Model Number Name Code
1 2 6602 030 00-0190494 DD036 1713

```

- If the remaining storage unit of the load source mirrored pair does not contain current data (it is suspended or resuming), it is treated as if the system cannot find an active mirrored load source for IPL, as described earlier. The IPL is not allowed to continue past DST until the active load source is found or repaired.

**Active Mirrored Load Source Fails Late in the IPL or at Runtime**

When an active mirrored load source fails after Storage Management Recovery is completed, it is treated like a failure in any other mirrored pair:

- If the other storage unit in the mirrored pair is present and active, the failing unit is suspended and the system continues to run using data the data on the remaining active unit of the pair.
- If the failing storage unit is the last active unit of the mirrored pair (the other unit of the pair is either suspended or resuming), the system displays a DASD Attention system reference code and becomes unusable.

**Cannot Read System Configuration Data from Active Mirrored Load Source**

If the system cannot read the system configuration data from the active mirrored load source that is being used for the IPL, one of the following screens is displayed.

```

Accept Load Source Warning Report

Some of the configuration information on the load source is
missing. The system can rebuild this information using
the default values.

Press Enter to let the system rebuild the configuration
information on the load source.

If you were performing any disk unit recovery actions, go to
Work with Disk Units and complete those actions.

```

```
Disk Configuration Warning Report
Type option, press Enter.
5=Display Detailed Report
```

```
Press F10 to accept all the warnings and continue the IPL.
The system will attempt to correct the warnings.
```

```
OPT Warning
5 Bad load source configuration
```

## Unknown Unit 1 Status

If both the service processor and one unit of the mirrored pair for unit 1 have failed, the following display is shown.

### Disk Configuration Error Report

```
Type option, press Enter.
5=Display Detailed Report
```

```
OPT Error
5 Unknown load source status
```

Type a 5 in the option column and press the Enter key.

### Display Unknown Mirrored Load Source Status

```
The system can not determine which disk unit of the load
source mirrored pair contains the correct level of data.
```

```
The following disk unit is not available:
```

```
Disk unit:
Type . . . . . : 6603
Model . . . . . : 030
Serial number . . . . . : 00-0193825
Resource name . . . . . : DD001
```

```
Press Enter to continue.
```

If the keylock switch is not in the Manual position, the control panel displays a system reference code .

The missing unit must be repaired or the state of the unknown load source recovered. If the missing unit can be repaired without losing the data on the unit, then the state of the load source will become known when the system is IPLed. If the missing unit cannot be repaired or if the data on it is lost, then you can possibly recover the state of the unknown load source and avoid restoring the entire system.

You should only attempt to recover the state of the unknown load source when you know its mirrored unit state was *active* before the failures that caused the state to become unknown. Since the state is unknown, the system cannot verify that your choice is correct. If you recover the state of the unknown load source when the actual state of the disk unit used to IPL was not active, you will cause data loss or damaged objects on your system.

## To Recover the State of the Unknown Load Source

1. From the DST main menu, select option 4, Work with disk units.
2. From the Work with disk units menu, select option 2, Work with disk unit recovery.
3. From the Work with disk unit recovery menu, selection option 15, Recover unknown load source.  
This will display a confirmation screen, showing the disk configuration and mirrored unit states the system will have after the recovery.
4. If the configuration and states are as you expect, press Enter to confirm.  
The state of the load source mirrored pair is changed so that the load source just used to IPL is active and the other (missing) load source is suspended.

If you cannot recover the state of the unknown load source and if the missing unit cannot be repaired, you must install the Licensed Internal Code and restore the entire system.

## Display Incorrect Licensed Internal Code Installation

When the Licensed Internal Code is restored on a mirrored unit for unit 1, one of the mirrored units may have the incorrect level of data stored on it. If this condition occurs, and the disk unit that contains the correct data is not available, the Licensed Internal Code is restored to the disk unit with the incorrect data. When a disk preforms an IPL and the correct disk unit is available, the following display is shown. If the keylock switch is not in the Manual position, system reference code (SRC) is shown on the control panel.

```
Display Incorrect Licensed Internal Code Install

Licensed Internal Code has been installed on the incorrect
disk unit of the load source mirrored pair.

If you continue the IPL, the previously installed Licensed Internal
Code installed on the incorrect disk unit of the mirrored
load source pair will be deleted. The Licensed Internal Code
will be replaced by the Licensed Internal Code from the correct
disk unit.

The following disk unit is the correct disk unit.

Disk unit:
Type . . . . . : 6602
Model . . . . . : 030
Serial number. . . . . : 00-0163477_
Resource name . . . . . : DD019

Press Enter to continue.
```

---

## Recovering remote load source mirroring

### Recovering After the Remote Load Source Has Failed

If the load source is not attached to its controlling IOP, a non-load source disk unit failure will occur. After the disk unit has been suspended, it can be repaired or replaced using concurrent or deferred maintenance, depending of the type of failure. While the remote load source is suspended, the system can still IPL by using the load source.

## Recovering After the Local Load Source Has Failed on an iSeries™ server

When the load source that is attached to its controlling IOP has failed, the system can continue to run using the data on the other load source. However, if the system is powered down, either for the repair or for another reason, it cannot be IPLed again without repairing the broken load source, because, the system can only IPL from the load source attached to its controlling IOP. If the local load source can be repaired or replaced using concurrent maintenance procedures, without powering down the system, then system use will not be interrupted. If the IPL load source has failed in such a way that concurrent maintenance is not possible, or if the IOP that controls the load source or Bus 1 have failed, then the system must be powered down, the broken hardware repaired or replaced, and the mirrored load source recovered.

Use normal system problem analysis to determine if concurrent maintenance is possible. If it is, use concurrent maintenance to repair or replace the broken load source. The repaired/replaced load source will be synchronized with the other load source, which the system has continued to use. When the repaired load source is synchronized, the load source is fully protected again and can be used for IPL and main storage dumps.

When concurrent maintenance is not possible, you can sometimes defer maintenance until a convenient time. However, the load source and your system will be running unprotected until all service and mirrored synchronization have been completed. If the other load source fails, data may be lost and the system may have to be reloaded.

There are two scenarios for dedicated recovery after a local load source failure:

### Dedicated Recovery of Local Load Source -- Local System is Still Functional

To recover from a local load source failure that uses dedicated maintenance when the local system unit and site are functional, do the following:

**Note:** If the IOP that controls the load source supports 520 or 522 byte sector disk units, then you can move the remote load source disk units to it.

- \_\_ 1. Power down the system.
- \_\_ 2. Repair/replace the broken load source.
- \_\_ 3. Install the Licensed Internal Code on the repaired/replaced load source.

After the install completes, the system will automatically IPL to DST. When the system reaches DST, all disk units and the system disk configuration will be missing.

**Note:** Press F3 to go to DST and perform the remote load source recovery actions. Do not press F10 to accept the New Disk Configuration warning. If you do, you must restart the dedicated recovery from remote DASD at Step 2 above.

- \_\_ 4. Use the Recover Mirrored Load Source function to recover the disk configuration and data. When recovery is complete, the system will re-IPL automatically.

### Dedicated Recovery From Remote Disk Units -- After a Local Site Disaster

To recover the system after a local site disaster, using the set of remote DASD, do the following:

**Note:** If your IOP that controls your load source supports 520 or 522 byte sector DASD, then you can move 1 the remote load source DASD to the replacement system.

- \_\_ 1. Attach a new system unit to the remote DASD. The new system unit must contain a disk unit that will become the new load source.

- \_\_\_ 2. Install the Licensed Internal Code to the disk unit in the new system unit. After the install completes, the system will automatically IPL to DST. When the system reaches DST, all disk units and the system disk configuration will be missing.

**Note:** Do not accept the New Disk Configuration warning. If you do, you must restart at Step 2.

- \_\_\_ 3. Use Recover Mirrored Load Source to recover the disk configuration and data. When recovery is complete, the system will automatically re-IPL.

## Using the Recover Mirrored Load Source Function

Recover Mirrored Load Source is used after a local load source failure to recover both the system and user data from the remote load source and to copy the data to the new local load source. Recover Mirrored Load Source assumes that the load source used for the IPL is new and has just been installed. This should be true whether recovering after a site disaster or after a local load source failure. After the new load source is installed and the system IPLs to DST, Recover Mirrored Load Source finds the remote load source and then synchronizes the new load source from the remote load source. When the synchronization is complete, the system re-IPLs automatically, since the Licensed Internal Code that was copied onto the IPL load source during synchronization may be different from the code used to IPL to DST.

Recover mirrored load source requires that:

- The current load source must have just been installed.
- The system must be able to find a valid configuration on the other disk units that are attached to the system.
- In the recovered configuration, remote load source mirroring must have been enabled.
- In the recovered configuration, the system ASP and the load source must have been mirrored.
- The remote load source must be attached to the system, it must be functional, and its mirrored unit state must be active; that is, it must contain current data.

To use Recover Mirrored Load Source, do the following:

- \_\_\_ 1. From the DST Main Menu, selection option 4, Work with disk units.
- \_\_\_ 2. From the Work with disk units menu, select option 2, Work with disk unit recovery.
- \_\_\_ 3. From the Work with disk units recovery menu, select option 16, Recover mirrored load source.

The system will check to see if it is possible to recover the mirrored load source. If recovery is possible, the system finds the best recovered configuration, finds the remote load source to use for recovery, and verifies that the remote load source and other disk units of the configuration are functional.

- If the mirrored load source can be recovered, the system will display a confirmation screen that shows the configuration that will be recovered.
- If the mirrored load source cannot be recovered, the system will display an error message. Follow the recovery actions that are listed for the error, and resolve the problem, if possible. If it is not possible to recover the mirrored load source, the data in the system ASP will be lost. If other ASPs in the system are intact, you can use the Recover Configuration function to recover the system configuration and the data in the complete ASPs.
- If the mirrored load source can be recovered, but there is not an active, usable disk unit present for each configured logical unit of the system (at least one active unit of each mirrored pair present and all device parity and unprotected units present), then all data will be lost in ASPs that have missing units.

The system will display a warning message for the ASPs that will lose data. Follow the recovery actions and try to resolve the missing unit situations if possible before continuing. If you cannot make the missing units present and active, then you can still continue, but all data will be lost in the ASPs where units are missing.

- \_\_\_ 4. Press Enter on the confirmation screen to begin to recover the mirrored load source. The recovery will use the configuration and remote load source that are found, verified, and displayed on the confirmation screen. During recovery, the following steps occur:
  - The system copies the recovered load source onto the load source used for the IPL. All data on the disk, including LIC, system data, and user data, are copied, except for the few pages that uniquely identify each individual disk unit and help distinguish between the two disk units of a mirrored pair. Those pages are built separately for the recovered load source.

During the recovery the system displays the System Reference Code C6 XX 4205 in the control panel. The percent complete, in decimal, is displayed in the third and fourth digits of the reference code (the XX).
  - When the recovery of the load source data is complete, the system performs a directed IPL, using the load source attached to the IOP that controls the load source, which now contains the recovered data.
- \_\_\_ 5. If any errors (for example, I/O errors or hardware failures) occur after the copy phase of recovery has begun, you must start the recovery process over again, beginning with the LIC install of the new load source.

---

## Chapter 12. How to Restore Your System Using Operational Assistant Tapes

The topic “Recovering User Information Using Tapes from Operational Assistant Backup—Checklist 27” on page 106 provides a list of the steps necessary to recover user information on your system. This chapter describes specific tasks associated with restoring information from Operational Assistant backup tapes. The descriptions assume that you are recovering all the data on your system. If you are recovering a single library or a single ASP, adapt the procedures to your situation.

Figure 31 on page 286 shows the parts of your system and how they are saved with Operational Assistant. Refer to it in the topics that follow.

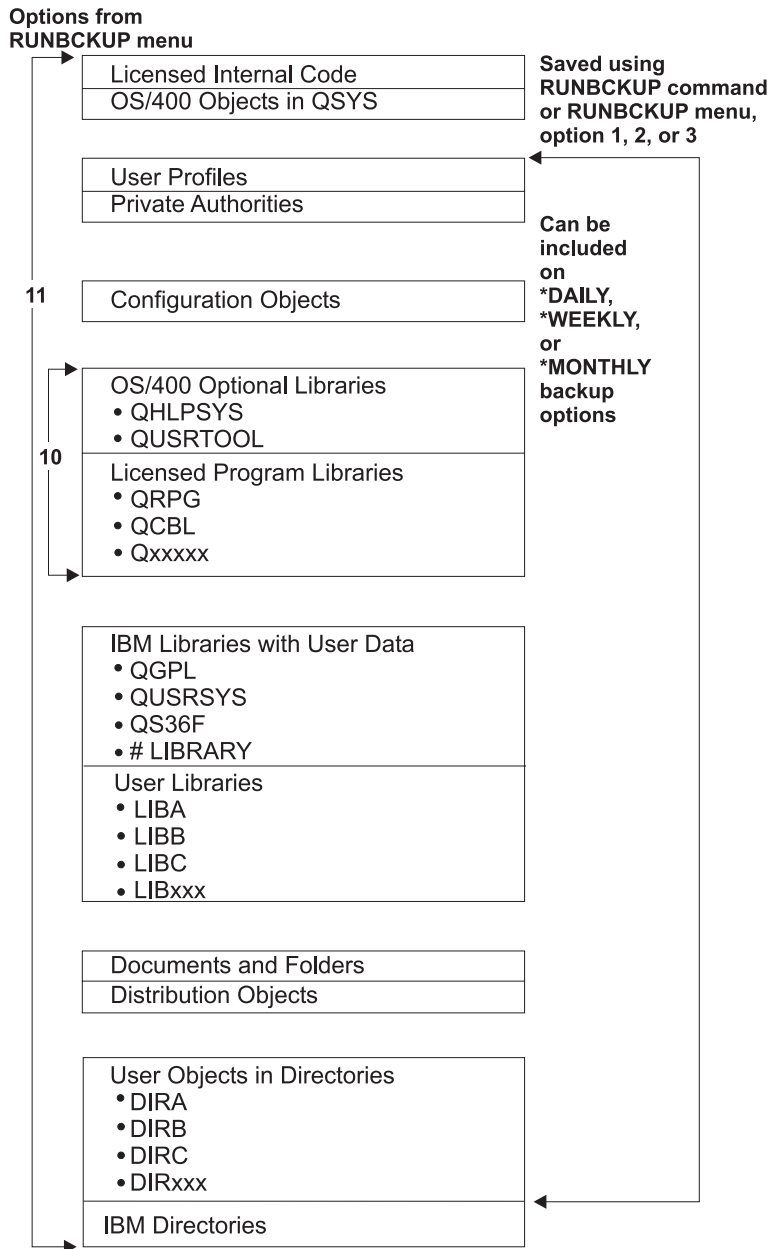

RBANS522-0

Figure 31. How the System Is Saved with Operational Assistant Backup

## How to Restore Your Libraries

To recover your entire system, you must restore IBM-supplied libraries and user libraries. To restore IBM-supplied libraries, do the following:

1. Find the tapes that you used most recently to save IBM-supplied libraries. You saved them by using one of these methods:
  - Option 10 from the Run Backup menu.
  - Option 11 from the Run Backup menu.
  - The SAVLIB LIB(\*IBM) command.
  - The SAVLIB LIB(\*NONSYS) command.



- Option 21 from the Save menu.
  - Option 22 from the Save menu.
  - Option 41 from the Save menu.
2. Mount the first tape and type: `RSTLIB SAVLIB(*IBM) DEV(media-device-name)`. Press the Enter key.

To restore user libraries, do the following:

1. Find the tapes that you used most recently to save all user libraries. You saved them by using one of these methods:
  - Option 1, 2, or 3 from the Run Backup menu and specifying 2 (All) for the *User libraries* option.
  - Option 11 from the Run Backup menu.
  - The `SAVLIB LIB(*ALLUSR)` command.
  - The `SAVLIB LIB(*NONSYS)` command.
  - Option 21 from the Save menu.
  - Option 23 from the Save menu.
  - Option 40 from the Save menu.
  - Option 42 from the Save menu.

If you are not sure which tapes have your user libraries on them, do the following for each possible tape:

- a. Mount the tape.
  - b. Type `DSPTAP DEV(media-device-name)`
  - c. Page through the displays, looking for the file called `QFILE`.
  - d. When you find the tape with the `QFILE` file on it, write down the sequence number for that file on the tape.
  - e. Leave the tape in the tape unit and type: `DSPTAP DEV(media-device-name) LABEL(QFILE) SEQNBR(sequence-number) DATA(*SAVRST) OUTPUT(*PRINT)`.
  - f. If the listing contains user libraries, it was created by either the `SAVLIB(*NONSYS)` command or the `SAVLIB(*ALLUSR)` command. The libraries from the tape can be restored using the `RSTLIB SAVLIB(*ALLUSR)` command.
2. Mount the first tape that has user libraries and type: `RSTLIB SAVLIB(*ALLUSR) DEV(media-device-name)`. Press the Enter key.

You have now restored all the libraries on your system to the point where they were all saved completely. Return to “Recovering User Information Using Tapes from Operational Assistant Backup–Checklist 27” on page 106.

---

## How to Restore Libraries That You Saved by Using a Backup List

This topic describes how to restore libraries that you saved using a backup list, either for daily or weekly backup. It assumes that you save all libraries for your monthly backup. This topic describes how to restore libraries, not changed objects. Use this procedure if all of the following are true:

- You have an Operational Assistant backup that is more recent than the last time you saved the entire system or all libraries.
- You specified 1 (Selected from list) for the *User libraries* option for your Operational Assistant backup.
- You specified N (No) for the *Save changed objects only* option for your Operational Assistant backup.

If you have both a weekly and a daily backup that meet these conditions, do the following:

- If your daily backup and weekly backup both save exactly the same libraries from the backup list, perform steps 2 on page 288 through 4 on page 288 once, using your most recent set of tapes (daily or weekly).
- If your daily backup saves fewer libraries than your weekly backup, do the following:

- If your most recent backup is a weekly backup, perform steps 2 through 4 once, using your most recent set of weekly tapes.
  - If your most recent backup is a daily backup, perform steps 2 through 4 once, using your most recent set of weekly tapes. Repeat step 2 through 4, using your most recent set of daily tapes.
1. Mount the first tape.
  2. Find the printed copy of the backup list associated with the save tapes. If you have the list, skip to step 4
  3. If you do not have the list, display the contents of the save tapes by typing: DSPTAP DEV(media-device-name) OUTPUT(\*PRINT) DATA(\*SAVRST).
  4. Use the listing from step 2 or step 3. For each library that was saved, do the following:
    - a. Type: RSTLIB SAVLIB(*library-name*) DEV(media-device-name).
    - b. Check off the library name on the list.

**Note:** Restore the user libraries to each user ASP that you are recovering. If you are restoring the QGPL library and the QUSRSYS library and doing partial recovery, restore these libraries before any other libraries.

---

## How to Restore Changed Objects That You Saved by Using Operational Assistant

If you save only changed objects for either your weekly or daily backup, use this procedure. If you save changed objects both weekly and daily, use your most recent set of tapes. If you save complete libraries on your weekly backup and changes on your daily backup, perform this procedure only if your daily backup is more recent than your weekly backup.

Do the following:

1. Mount the first tape from your most recent backup of changed objects.
2. Determine if any objects are on the tape for libraries that do not exist on the system:
  - a. Print a list of libraries on the system by typing: DSPBCKUPL OUTPUT(\*PRINT).
  - b. Print the contents of the tape by typing: DSPTAP DEV(media-device-name) OUTPUT(\*PRINT) DATA(\*SAVRST).
  - c. Compare the two lists. Mark any libraries on the DSPTAP listing (from step 2b) that do not appear on the DSPBCKUPL listing (from step 2a).
  - d. For any libraries you marked in step 2c, type the following: CRTLIB LIB(*library-name*).
3. Restore the changed objects from the tapes. For each library that appears on the DSPTAP listing (from step 2b), type:
 

```
RSTOBJ OBJ(*ALL) SAVLIB(library-name)
      OBJTYPE(*ALL) DEV(media-device-name)
```

---

## Chapter 13. How to Restore the System from the Save Storage Media

When you recover your system from the Save Storage (SAVSTG) media in a disaster recovery situation, you reset your system to the point when the SAVSTG procedure was run. Your system will not be available for use until the restore process completes successfully.

The disk configuration of the restoring system must be the same as the disk configuration of the saving system. There must be at least as many disk units on the restoring system as there were on the saving system. Each disk unit capacity on the restoring system must be equal to or greater than the capacity of the disk unit on the saving system. Serial numbers and physical addresses do not have to be the same. All disk units that were saved are required for the restore operation.

The restore storage process does not automatically start or stop device parity protection on the restoring system. If you determine that the disk units on the restoring system should be protected with device parity protection, start device parity protection before restoring the SAVSTG tapes.

If your system has mirrored protection now, when the restore storage procedure runs, your system will not have mirrored protection on any Auxiliary Storage Pool (ASP).

### *Find These Things Before You Begin:*

- The list of all the Licensed Internal Code fixes applied to your system at the time you saved storage. This list should be attached to your backup log or found with the SAVSTG tapes.
- If you applied any PTFs since the last save storage operation, you will need your most recent cumulative PTF tape.
- A recent SAVSYS or SAVCFG media volume. The SAVSYS or SAVCFG media contains configuration information that you will have to restore after the restore storage is completed.

### *Do These Things Before You Begin:*

- Clean the read and write head of the tape unit.
- Print a list of all the Licensed Internal Code fixes currently on the system. Type the following and press the Enter key:  
DSPPTF LICPGM(\*ALL) OUTPUT(\*PRINT)

### *Considerations for recovering to a different system:*

- Ensure that your restoring tape drive supports the capabilities of your storage tapes in regard to compression and compaction.
- Performance on the target system may be different than the source system if you use different disk protection mechanism.
- In the future you must obtain software license keys for the target system.

---

## Task 1—Powering Down the System and Loading the Licensed Internal Code

1. Ensure that all users are off the system.
2. Type the following to power down the system:  
PWRDWSYS OPTION(\*IMMED)

**Attention logical partitioning users!**

If you are going to use this command on the primary partition, be sure to power off all secondary partitions before running the command.

3. Load the first SAVSTG tape in the tape unit that is your alternative IPL device.
4. Install the Licensed Internal Code by using the procedure that is described in “Task 2–Powering Down the System” on page 113 through “How to Load the Licensed Internal Code” on page 120. Select option 2 (Install Licensed Internal Code and Initialize System) from the Install Licensed Internal Code (LIC) display. When the procedure asks for SAVSYS media, use your SAVSTG tapes instead.

---

## Task 2–Restoring the Save Storage Tapes

1. When the IPL following the installation of the Licensed Internal Code completes, the Disk Configuration Attention Report display is shown. Press F10 to accept the new configuration. The IPL or Install the System menu is displayed.

```
                IPL or Install the System
Select one of the following:
  1. Perform an IPL
  2. Install the operating system
  3. Use Dedicated Service Tools (DST)
  4. Perform automatic installation of the operating system
  5. Save Licensed Internal Code
```

2. Select option 3 (Use Dedicated Service Tools (DST)) and press the Enter key. The Dedicated Service Tools (DST) Sign On display is shown.

```
                Dedicated Service Tools (DST) Sign On
Type choice, press Enter
Service tools user . . . . . _____
Service tools password . . . . . _____
```

3. Sign on to DST with the QSECOFR service tools user ID. You can find more information about service tools user IDs and passwords in the iSeries Information Center, <http://www.ibm.com/eserver/series/infocenter>. See **Security** → **Service tools user IDs and passwords**.

The Use Dedicated Service Tools (DST) menu is shown.

```
                Use Dedicated Service Tools
Select one of the following:
  1. Perform an IPL
  2. Install the operating system
  3. Work with licensed internal code
  4. Work with disk units
  5. Work with DST environment
  6. Select DST console mode
  7. Start a service tool
  8. Perform automatic installation of the operating system
  9. Work with save storage and restore storage
 10. Work with remote DST support
```

**Note:** If you are able to use logical partitions on your system, the Use Dedicated Service Tools display screen will include option 11, Work with system partitions.

4. If you are using logical partitioning, and you are restoring to the primary partition, you must restore your partition configuration before you restore storage. For secondary partitions, you will not restore the partition configuration — this step is only for primary partitions. Refer to “How to Recover Your Logical Partition Configuration” on page 123 for instructions on restoring your partition configuration. Then return here and continue with the next step.
5. Select option 9 (Work with save storage and restore storage) and press the Enter key.
6. Select option 1 (Restore storage) and press the Enter key. The Specify Volume Identifier display is shown:

```

                Specify Volume Identifier

Type choice, press Enter.

Volume identifier . . . . . _____
```

7. Type the volume name in the *Volume Identifier* prompt. The volume name is SAVEDS. This is the volume that is currently loaded. You will be shown one of the following displays. Continue with the step that is indicated:

Display Name	Continue With This Step
Select Tape Unit	Step 8
Device Intervention Required	Step 9
Confirm Restore Storage	

8. If the Select Tape Unit display appears, select the proper unit and press the Enter key. Continue with step 12 on page 292.

```

                Select Tape Unit

Type option, press Enter.
 1=Select

Serial
Option   Type      Model          Number         Resource Name
-        -        -              -              -
-:      -        -              -              -
:        -        -              -              -
```

9. If the wrong volume is loaded, the following display appears:

```

                Device Intervention Required

Device type. . . . . : _____
Device model . . . . . : _____
:
If the wrong volume was loaded, type change, press Enter.

Type choice, press enter
New volume or file . . . . . _____
:

Wrong volume loaded
```

10. Type the name of the correct volume or file, and press the Enter key. The following display is shown:

```

Device Intervention Required

Device type. . . . . : ____
Device model . . . . . : ____
:
Type choice, press enter
Action . . . . . 1=Cancel
                    3=Retry
                    _____
                    _____

```

11. Select option 3 (Retry), and press the Enter key.
12. There is a delay while the tape is read to determine what has been saved on the tape. The Confirm Restore Storage display is shown.

```

Confirm Restore Storage

Warning: A restore of storage will destroy the current data
on the system. The restore will take several minutes for each
unit saved. An automatic IPL is part of the restore.

Press F10 to confirm your choice to restore all storage.
Press F12 to return to change your choice.

----- Restore To -----
Unit  ASP  Type  Model  Serial      Resource
      1    1  6602  030   00-0261624 DD003
      3    5  6602  030   00-0211957 DD002
      :
----- Saved From -----
Unit  ASP  Type  Model  Serial      Resource
      1    1  6602  030   00-0261624 DD003
      3    5  6602  030   00-0211957 DD002
      :

```

13. Press F10 (Confirm restore) to confirm. The restore status display on the console continually displays the progress of the restore operation.

```

Function Status

You selected to restore storage.

51% Complete
12 pages not readable

```

The display indicates what percent of the total system sectors have been restored. However, this is an estimate and cannot be used to predict how long the entire restore procedure will take.

14. If no errors occur, the system performs a programmed IPL when the restore storage process completes, go to "Task 4—Completing the Restore Storage Operation" on page 293 otherwise, continue to "Task 3—Responding to Messages."

## Task 3—Responding to Messages

While you are performing the restore storage operation, you may see the Device Intervention Required display or the Handle Tape Intervention display.

When one of these displays appears, look for messages at the bottom of the display or for an I/O manager code on the display. Respond to the display by using the information in Table 57:

*Table 57. Handling Messages When Restoring Storage*

Message or Code	Your Action
End of tape encountered. Load next volume.	Load the next tape volume. Select option 3 (Continue), and press the Enter key.
Tape unit not ready	Make the tape unit ready, select option 3 (Continue), and press the Enter key.
Wrong volume loaded	Remove the tape. Load the correct tape. Selection option 3 (Retry) and press the Enter key.

If the tape can not be read because of a media error, the following display is shown:

```

Restore Storage
Status of restore . . . . . : Ended
A media error was found on tape.
If this is the first time the restore storage has ended because
a media error occurred on this tape, do the following:
1. Remove the tape from the tape device.
2. Clean the tape path using the cleaning procedure
described in the tape device operator's guide.
3. Press Enter, F3, or F12 to continue. The system will
perform an IPL, an then display either the IPL or Install
the System menu or the Missing Disk Units display.
4. Select the option to use Dedicated Service Tools (DST)
5. Select the option to Work with Save Storage and Restore
Storage.
6. Select the option Resume restore storage.
7. Insert the tape which had the media error into the tape
device.
8. Make the tape device ready, if necessary.

```

**Media Error While Restoring?**  
For information on how to recover, see "How to Resume the Restore Storage Operation" on page 296.

## Task 4—Completing the Restore Storage Operation

1. When the IPL completes after the restore storage operation, the IPL or Install the System menu appears.

```

IPL or Install the System
Select one of the following:
1. Perform an IPL
2. Install the operating system
3. Use Dedicated Service Tools (DST)
4. Perform automatic installation of the operating system
5. Save Licensed Internal Code

```

2. Perform an attended IPL by selecting the Perform an IPL option.
3. If the following display is shown, disk units have been attached to the system and are in nonconfigured status.

Add All Disk Units to the System

Select one of the following:

1. Keep the current disk configuration
2. Perform disk configuration using DST
3. Add all units to the system auxiliary storage pool (ASP)
4. Add all units to the system ASP and balance data

Select option 3 (Add all disk units to the system auxiliary storage pool) and press the Enter key. As the disk units are being configured, the following display is shown:

```

:
      Function status
      You selected to add units
      10% complete
:

```

Adding disk units takes several minutes. The time it takes depends on the size of each unit and the number of units to be added.

4. The Sign On display appears. Sign on as QSECOFR.

**Note:** It is important that the following steps are performed so that the device resource names are updated correctly.

5. At the IPL Options display, set the Start system to restricted state option to Y (yes).

**Note:** As the IPL continues, SRC A900-2000 may appear. See "Recovering from SRC A900 2000" on page 152. This section describes how to create a tape device descriptor so that the system hardware configuration can be restored in a later step of this procedure.

6. When the IPL is complete, ensure that the system is in a restricted state. See "Putting Your System in a Restricted State" on page 35.
7. You have to restore the configuration of your system. Use the most recent media volume that has your saved configuration. If you performed the Restore Storage on the same system that you did the Save Storage (SAVSTG) on, you were instructed to create a SAVCFG media volume before the SAVSTG ran. If your system configuration has changed since the Save Storage was performed, use the most recent SAVCFG or SAVSYS media volume. If you performed the Restore Storage on a system different than the system the Save Storage (SAVSTG) ran on, use the most recent SAVCFG or SAVSYS media volume from the system you restored to. The file on the tape is called QFILEIIOC.

Before you perform the RSTCFG command, you need to vary off all unnecessary configuration objects. Do not vary off the workstation and media drive that you are using to perform the restore operation.

With the SAVSYS or SAVCFG media volume loaded, type:

```
RSTCFG OBJ(*ALL) DEV(media-device-name) OBJTYPE(*ALL)
```

8. If you want the system to automatically configure new devices on subsequent IPLs, change the system value for QIPLTYPE to allow an unattended IPL. Type:

```
CHGSYSVAL QIPLTYPE '0'
```

9. It may be necessary to update the Network Attributes on the system. Get the latest list of the system's Network Attributes. The instructions for the Save Storage (SAVSTG) command directed you to print the list of the Network Attributes and keep that list with the Save Storage tapes. To update the Network Attributes on the system, type the following and press the Enter key:

```
CHGNETA
```



Use the list of Network Attributes to enter the values on the input fields.

10. Change the system value for QAUTOCFG to allow automatic configuration to run. Type:  
CHGSYSVAL QAUTOCFG '1'
11. Do a PWRDWN SYS \*IMMED RESTART(\*YES).

**Attention logical partitioning users!**

If you are going to use this command on the primary partition, be sure to power off all secondary partitions before running the command.

If you have a problem with your devices, such as not being able to vary on a device, see “Recovering Devices That Will Not Vary On” on page 220.

When you restore your information to a different system or an upgraded system, you may have a different console type on the target system. See “Recovering When You Change the Console Type” on page 221.

12. While the system is IPLing, you may see an error message about the System/36 environment, such as CPF3761. Refer to “Recovering the System/36 Environment Configuration” on page 221 for the procedure to follow after you have completed restoring storage.
13. When the IPL completes, the restore history information for data area QSAVSTG in library QSYS is updated to show the date and time of the last restore storage operation. Use the Display Object Description (DSPOBJD) to display the last date and time of the restore storage operation.
14. Use the Display Log (DSPLOG) command to display the QHST log or use the Display Messages (DSPMSG) command to display the QSYSOPR messages. Look at the restore storage message CPC3735 to determine if:
  - The system found any sectors that had data that could not be restored. The data may have been unreadable during the Save Storage operation.
  - The restore storage process is complete.
15. If you have additional information to restore, such as SAVCHGOBJ tapes or journaled changes to apply, continue with “Task 5–Restoring Additional Information.” Otherwise, skip to “Task 6–Restoring Program Temporary Fixes (PTFs).”

---

## Task 5–Restoring Additional Information

If you are restoring changed objects, changed DLOs, or changed objects in directories, you must first restore user profiles. This builds the authority information for any new objects that you restore. If you are applying only journaled changes, start with step 4.

1. Sign on as QSECOFR.
2. Put your system in a restricted state. See “Putting Your System in a Restricted State” on page 35.
3. Restore user profiles. See “Restoring User Profiles” on page 202.
4. Restore changed objects and apply journaled changes. Follow the instructions in Chapter 10, “How to Restore Changed Objects and Apply Journaled Changes,” on page 261.
5. Restore authority by typing: RSTAUT.

---

## Task 6–Restoring Program Temporary Fixes (PTFs)

If you have applied PTFs since your SAVSTG procedure, follow the instructions in “How to Restore Program Temporary Fixes” on page 259.

**Stop!**

You have now completed restoring your system from SAVSTG media.

## How to Resume the Restore Storage Operation

You can use this procedure to resume the restore storage operation that ended before the entire restore operation of the disk unit data was complete.

To start the restore storage operation again, do the following:

1. From the Dedicated Service Tools (DST) menu, select option 9 (Work with save storage and restore storage) and press the Enter key.
2. Select option 2 (Resume restore storage) and press the Enter key.
3. If the following display is shown, load the tape that is indicated and press the Enter key.

Resume Restore Storage

Do the following:

1. Locate the tape to resume the restore on. The tape that was being read when the restore storage was interrupted has the following identification:  
Volume identifier . . . . . : \_\_\_\_\_  
Sequence number . . . . . : \_\_\_\_\_
2. Insert the tape in the tape device.
3. Make the tape device ready, if necessary.

Note:  
If the restore storage was interrupted because of a media error on a tape, you may want to resume the restore storage on the tape following the failing tape. If you resume the restore storage on that tape, the system will have damaged objects, and the system might not be able to perform and IPL to i5/OS when the restore storage is complete.

Press Enter to continue.

4. If the wrong volume is loaded, the Device Intervention Required display with a message at the bottom is shown. Type the name of the correct volume or file, and press the Enter key.
5. The restore storage operation starts again.

If the restore storage operation continues to fail on the same tape with a tape media failure, you have three options:

- Use a previous copy of your save storage tapes to completely restore storage.
- Resume the restore storage operation by using the tape following the tape with the media error. If the tape that has the media error is the last tape to restore in the set, option 3 (Force end of an interrupted restore storage) on the Restore Storage menu should be selected.

**Attention!**

Some disk unit data is not restored. There may also be many objects that are damaged on the system when the restore operation completes. An initial program load of the operating system may not be successful. You should restore the operating system again.

- Initialize your system and then begin a restore of your system from the tapes that were created using SAVSYS and SAVLIB commands or options from the Save menu.

---

## Part 3. Release-to-Release Support

<b>Chapter 14. Release-to-Release Support</b>	299
Current Release-to-Previous Release Support	299
Creating the Object for the Previous Release	300
Saving the Object for the Previous Release	301
Testing the Object on the Current Release	306
Restoring and Using the Object on the Previous Release	307
Restrictions for Current Release-to-Previous Release Support	307
Previous Release-to-Current Release Support	307
Considerations when Moving System Customization Information	308
Restoring Previous Release User Data to a New System	308
Prerequisites for the recovery...	309
Restoring previous release user data to a new system: Step-by-step instructions	310
Saving spooled files	324
Restrictions When Going from Previous Release to Current Release	325
<b>Chapter 15. System Synchronization-Planning and Procedures</b>	327
Synchronization Methods: Overview	328
Moving Changed Objects	329
Steps for Saving Changed Objects	329
Steps for Restoring Changed Objects	331
Problems When Restoring Changed Objects	332
Problems Restoring Journal Receivers	332
Problems Restoring Database File Members	332
Problems with Object Authority or Ownership	334
Moving Entire Libraries	334
Considerations for Moving Entire Libraries	335
Moving Individual Objects	335
Applying Journalized Changes	336
Refreshing Your new system	338
Additional Synchronization Tips	338



---

## Chapter 14. Release-to-Release Support

The release-to-release support on the iSeries and AS/400 servers allows you to move data from the current release to a previous-release system. This support also allows you to move data from a previous-release system to a current-release system.

Releases of licensed programs on the iSeries or AS/400 servers have a three-part name that consists of a version, a release, and a modification. For example, the current version is Version 5 Release 4 Modification 0. The short form of the current release name is V5R4M0. This chapter uses the short form for release names.

Please read and “Restrictions When Going from Previous Release to Current Release” on page 325 for important information.

---

### Current Release-to-Previous Release Support

This support enables objects (such as programs and files) that are created and saved on the **current release** to be restored and used on a **previous release**. Object compatibility is provided for many languages, and most object types are supported on both release levels as long as the objects use only functions from a previous release.

You can enable current release-to-previous release support by using the target release (TGTRLS) parameter on create or save commands.

Table 58 illustrates the TGTRLS parameter and values available for the current and previous releases. The values in the table are used throughout this chapter. Refer to this table to determine the valid values for the release currently on your system.

*Table 58. Values for TGTRLS Parameter*

Current® i5/OS Release	*CURRENT	*PRV	Other Valid Values
V5R4M0	V5R4M0	V5R3M0	V5R2M0
V5R3M0	V5R3M0	V5R2M0	V5R1M0
V5R2M0	V5R2M0	V5R1M0	V4R5M0
V5R1M0	V5R1M0	V4R5M0	V4R4M0

This support is extremely useful to:

- A network enterprise with a central site development system on the current release and with remote sites still on the previous release.
- An application development business with a single system on the current release that supports customers who may still be on the previous release.

Current release-to-previous release support provides great savings and productivity improvements to application developers. By using this support, most network enterprises and application development businesses no longer need to maintain two development systems. (For example, two development systems could contain a previous-release system that contains previous-release objects, or a current-release system that contains current-release objects.) In most cases, this support enables previous- and current-release objects to exist on one development system.

The following sections describe how to create and save objects on the current release, and how to restore and use them on the previous release.

## Creating the Object for the Previous Release

If you wish to run CL programs for a previous release, you must install option 9 (\*PRV CL Compiler Support) from i5/OS.

The following object types must be created specifically for a target release:

- Program (\*PGM)
- Service program (\*SRVPGM)
- Module (\*MODULE)
- C locale description (\*CLD)
- SQL package (\*SQLPKG)

Create the object on the current release by using the appropriate create command with the TGTRLS parameter. All other object types can skip this step. If the object was created on, or is restored from, the previous release, and is not created again on the current release, you can skip this step. To determine what release the object was created on, use the DSPOBJD command and specify DETAIL(\*SERVICE) to display the *System-level* value.

It is recommended that previous-release programs and current-release programs be stored in separate libraries to simplify maintenance. Using the DSPPGM command, the *Earliest release that program can run* field shows if a program can be saved to the previous release. This recommendation also applies to previous-release and current-release modules and service programs. To determine if \*MODULE objects can be saved to a previous release, use the DSPMOD command. To determine if \*SRVPGM objects can be saved to a previous release, use the DSPSRVPGM command.

Table 59 shows the languages and commands that support the TGTRLS parameter:

Table 59. Language Support for the Target Release Parameter

Language	Command
ILE C	CRTBNDC CRTCMOD CRTCLD
ILE C++	CRTBNDCPP CRTCPPMOD
CICS®	CRTCICSC CRTCICSCBL CRTCICSGRP CRTCICSMAP
CL	CRTBNDCL CRTCLMOD CRTCLPGM
ILE COBOL	CRTBNDCBL CRTCBLMOD CRTCBLPGM CRTS36CBL

Table 59. Language Support for the Target Release Parameter (continued)

Language	Command
ILE RPG	CRTBNDRPG
	CRTRPGMOD
	CRTRPGPGM
	CRTRPTPGM
	CRTS36RPG
	CRTS36RPT
SQL	CRTSQLCI
	CRTSQLCBL
	CRTSQLCBLI
	CRTSQLCPPI
	CRTSQLPLI
	CRTSQLRPG
	CRTSQLRPGI
Other	CRTPGM
	CRTSRVPGM

## Saving the Object for the Previous Release

You must save the object on the current release by using the TGTRLS parameter before restoring it on the previous release or previous modification. This saves the object in a format that is known to the previous release or previous modification.

Use communication lines or removable storage media (tape or optical media volume to move the objects from the current-release system).

It is recommended that you store previous-release and current-release objects in separate libraries to simplify maintenance.

The following save commands support the TGTRLS parameter:

- Save (SAV)
- Save Changed Objects (SAVCHGOBJ)
- Save CICS Group (SAVCICSGRP)
- Save Document Library Objects (SAVDLO)
- Save DLO using BRM (SAVDLOBRM)
- Save Folder List using BRM (SAVFLRLBRM)
- Save Library (SAVLIB)
- Save Library using BRM (SAVLIBBRM)
- Save Licensed Program (SAVLICPGM)
- Save Media Information using BRM (SAVMEDIBRM)
- Save Object (SAVOBJ)
- Save Object by using BRM (SAVOBJBRM)
- Save Object List by using BRM (SAVOBJLBRM)
- Save/Restore Objects (SAVRST)
- Save/Restore Changed Object (SAVRSTCHG)
- Save/Restore Document Library Object (SAVRSTDLO)
- Save/Restore Library (SAVRSTLIB)

- Save/Restore Object (SAVRSTOBJ)

The System Manager licensed program uses the previous-release support provided by the SAVLICPGM command. It provides the capability to package software for multiple releases from the same system.

Object compatibility is provided for most object types that are supported on *both* levels as long as the object only uses the previous-release function.

Table 60 shows what object types can and cannot be specifically created or saved for a previous release. IBM does not support saving IBM-supplied objects (such as system commands and programs) from the current release and restoring them on a previous-release system. Refer to Table 58 on page 299 for a list of supported TGTRLS values.

Table 60 uses these values:

- **All** means the object can be saved to all TGTRLS values that are supported on the current version of the operating system.
- **VvRrMm** indicates the earliest release to which an object could be saved. However, you may need to refer to Table 58 on page 299 to find the earliest TGTRLS value that is supported on the current version of the operating system.
- **\*CURRENT** means the object can only be saved to the current release, TGTRLS(\*CURRENT).
- **None** means the object is saved by a command, such as SAVSECDTA or SAVCFG, that does not support the TGTRLS parameter.

Table 60. Previous-Release Support by Object Type

Object Type	Earliest Target Release
*ALRTBL	All
*AUTHLR	None
*AUTL	None
*BLKSF	All
*BNDDIR	All
*CFGL	None
*CHTFMT	All
*CHRSF	V5R2M0
*CLD	All
*CLS	All
*CMD	All
*CNL	None
*COSD	None
*CRG	*CURRENT
*CRQD	All
*CSI	All
*CTLD	None
*DDIR	All
*DEV	None
*DIR	All
*DOC	All
*DSTMF	All



Table 60. Previous-Release Support by Object Type (continued)

Object Type	Earliest Target Release
*DTAARA	All
*DTADCT	All
*DTAQ	All <sup>5</sup>
*EDTD	All
*EXITRG	All
*FCT	All
*FIFO	V5R1M0
*FILE (database, device, save)	All
*FLR	All
*FNTRSC	All
*FNTTBL	V3R7M0
*FORMDF	All
*FTR	All
*GSS	All
*IGCDCT	All
*IGCSRT	All
*IGCTBL	All
*IMGCLG	V5R2M0
*IPXD	None
*JOB	All
*JOBQ	All
*JOBSCD	All
*JRN	All
*JRNRCV <sup>4</sup>	All
*LIB	All
*LIND	None
*LOCALE	V3R7M0
*MEDDFN	V4R4M0
*MENU	All
*MGTCOL	V4R4M0
*MODD	None
*MODULE <sup>1</sup>	
• ILE C	All
• ILE C++	All
• ILE CL	All
• ILE COBOL	All
• ILE RPG/400 <sup>®</sup>	All
*MSGF	All <sup>6</sup>
*MSGQ	All

Table 60. Previous-Release Support by Object Type (continued)

Object Type	Earliest Target Release
*NODGRP	V3R2M0
*NODL	All
*NTBD	None
*NWID	None
*NWSCFG	V5R4M0
*NWSD	None
*OUTQ <sup>8</sup>	All
*OVL	All
*PAGDFN	All
*PAGSEG	All
*PDFMAP	V5R3M0
*PDG	All
*PGM: <sup>1</sup>	
• BASIC	*CURRENT
• CL (S/38 environment)	*CURRENT
• CL (iSeries environment)	All
• COBOL (iSeries environment)	All
• COBOL/74 (S/38 environment)	*CURRENT
• COBOL/74 (S/36 environment)	All
• ILE C	All
• ILE C++	All
• ILE CL	All
• ILE COBOL	All
• ILE RPG	All
• PASCAL	*CURRENT
• PL/I	*CURRENT
• RPG/II (S/36 environment)	All
• RPG/III (S/38 environment)	*CURRENT
• RPG (iSeries environment)	All
*PNLGRP	All
*PRDAVL	*CURRENT
*PRDDFN	All
*PRDLOD	All
*PSFCFG	V3R2M0
*QMFORM	All
*QMQRV	All
*QRYDFN	All

Table 60. Previous-Release Support by Object Type (continued)

Object Type	Earliest Target Release
*RCT	*CURRENT
*SBSD	All
*SCHIDX	All
*SOCKET	None
*SPADCT	All
*SQLPKG	All
*SQLUDT	V4R4M0
*SRVPGM <sup>2</sup>	
• ILE C	All
• ILE C++	All
• ILE CL	All
• ILE COBOL	All
• ILE RPG/400	All
*SSND	All
*STMF <sup>3</sup>	All
*SVRSTG	V3R2M0
*SYMLNK	All
*S36	*CURRENT
*TBL	All
*TIMZON	V5R3M0
*USRIDX	All
*USRPRF	V5R1M0 <sup>7</sup>
*USRQ	All
*USRSPC	All
*VLDL	V4R1M0
*WSCST	All

Table 60. Previous-Release Support by Object Type (continued)

Object Type	Earliest Target Release
1	For ILE programs (a *PGM object created by binding one or more *MODULE objects together), the target release is determined by examining the target release value for each input *MODULE. If the target release values are different, the most recent target release value is used. An ILE program can be created from *MODULE objects created by different ILE compilers. The entries in this table for ILE languages under the *PGM object type state which target release values are supported by the ILE compiler when creating a *MODULE object. The *MODULE object can be used in turn to create an ILE program by using the CRTPGM command.
2	For ILE service programs (a *SRVPGM object created by binding one or more *MODULE objects together), the target release is determined by examining the target release value for each input *MODULE. If the target release values are different, the most recent target release value is used. An ILE service program can be created from *MODULE objects created by different ILE compilers. The entries in this table for ILE languages under the *SRVPGM object type state which target release values are supported by the ILE compiler when creating a *MODULE object. The *MODULE object can be used in turn to create an ILE service program by using the CRTSRVPGM command.
3	In V4R3, support was added for *STMF sizes up to 4gigabyte - 1byte. A *STMF larger than 2gigabyte - 1 byte cannot be saved to releases prior to V4R3. In V4R4, support was added for *STMF sizes greater than 4gigabyte - 1byte. A *STMF larger than 4gigabyte - 1byte cannot be saved to releases prior to V4R4.
4	<p>If a journal receiver was attached to a journal when RCVSIZOPT(*MAXOPT1) was in effect, then it cannot be saved or restored to a release prior to V4R5M0. Also, it cannot be replicated to any remote journals on any systems at release prior to V4R5M0. If a journal receiver was attached to a journal when RCVSIZOPT(*MAXOPT2) was in effect, then it cannot be saved or restored to a release prior to V5R1M0. Also, it cannot be replicated to any remote journals on any systems at releases prior to V5R1M0. If a journal receiver was attached to a journal when any MINENTDTA options were in effect, then it cannot be saved or restored to a release prior to V5R1M0. Also, it cannot be replicated to any remote journals an any system prior to V5R1M0.</p> <p>If a journal receiver was attached to a journal when RCVSIZOPT(*MAXOPT3) was in effect, then it cannot be saved or restored to a release prior to V5R3M0. Also, it cannot be replicated to any remote journals on any systems at releases prior to V5R3M0.</p>
5	V4R5M0 is the earliest release for *DTAQ if the SIZE and AUTORCL parameters on CRTDTAQ did not contain the default values when the data queue was created. Data queues cannot be saved for releases prior to V5R4M0 if QDTA(*DTAQ) is specified.
6	V4R5M0 is the earliest release if *UBIN or *BIN 8 is specified for the format of a message description within the message file.
7	*USRPRF can only be saved to an earlier target release by using the Save Object List (QSRSAVO) API. See the iSeries Information Center ( <a href="http://www.ibm.com/eserver/iseries/infocenter">http://www.ibm.com/eserver/iseries/infocenter</a> ) for more information about QSRSAVO.
8	Spooled file data on output queues cannot be saved or restored for releases prior to V5R4M0. For more information refer to Save and restore spooled files.

## Testing the Object on the Current Release

Once the object has been created and saved using the TGTRLS parameter it can be tested on the current-release system. Thus, it is no longer necessary to support and maintain two development systems (one running the current release and one running the previous version). Testing this object should be like testing any other object. Make sure that all the objects that are to be used on the previous-release system have been saved using the TGTRLS parameter, restored onto the current-release system, and tested as a group on the current-release system.

## Restoring and Using the Object on the Previous Release

Once testing on the current-release system is completed, it is recommended that the object be distributed on a limited basis to previous-release systems or previous modification systems. Thus, if problems arise, they can be quickly corrected and contained with minimal impact to users.

## Restrictions for Current Release-to-Previous Release Support

The following restrictions apply when you create and save objects on the current release, and then restore and use them on the previous release.

- You cannot specify a TGTRLS value earlier than V4R5M0 to save data to optical media that you initialized with Universal Disk Format (UDF).
- The System/38™ environment compilers (CL, COBOL/74, and RPG/III) do not support the TGTRLS parameter. Programs that are created using these compilers cannot be saved to, restored, or run on a previous-release system.
- The only way to save an object for a previous-release system is to use the TGTRLS parameter. If the TGTRLS parameter is not specified on the save command, and you attempt to restore the object on the previous-release system, the object is not restored.
- IBM does not support saving IBM-supplied objects (such as system commands, system programs, IBM spelling aid dictionaries, and so forth) from a current-release system and restoring and using them on a previous-release system or previous modification. As a result, the TGTRLS parameter is not supported on a SAVLIB command that specifies \*ALLUSR, \*IBM, or \*NONSYS on the LIB parameter.
- IBM does not support new function from the current release to be used on a previous-release system or previous modification.
- When saving document library objects for a previous release, only folders and filed documents can be saved. Other items, such as mail or documents that are not filed cannot be saved using TGTRLS values other than \*CURRENT.
- If a current-release program temporary fix (PTF) save file is sent from a current release-system to a previous-release system for distribution to another current-release system, object distribution must be used. The Copy PTF (CPYPTF) command or any save file command, such as DSPSAVE, cannot process the PTF save file.
- When you save optical volume images, you cannot specify a value previous to V5R2M0 for the TGTRLS parameter on the SAV command.

---

## Previous Release-to-Current Release Support

### Moving All Your Data to the Current Release?

This topic describes considerations when you are moving specific types of information from an earlier release to the most current release. Before you begin a data migration, refer to the **Migration** —> **Data migrations** topic in the iSeries Information Center at <http://www.ibm.com/eserver/series/infocenter>.

Generally, the system to which you are restoring objects must be at the same or a higher release level than the system from which the objects were saved, unless you specified a target release value when you saved. When moving data to a higher level release, you should only move user data. This may include user libraries, user directories, user profiles, user objects in IBM-supplied libraries, DLOs, and mail. IBM-supplied libraries and IBM-supplied directories should not be restored to a higher release since these are handled during the licensed program install process. The target system should have the current-level release installed. This includes the Licensed Internal Code, i5/OS operating system, IBM-supplied libraries QGPL and QUSRSYS, i5/OS optional libraries, and any licensed programs that are purchased. See the *Install, upgrade, or delete i5/OS and related software* document to install the current release.

Preventive service planning (PSP) information is available at the following Internet location:  
<http://www.ibm.com/eserver/iseriessupport/>. Alternatively, you can obtain PSP information from your software service provider. You should check the PSP before beginning your server upgrade or data migration. The PSP identifier for information that pertains to upgrading your server or migrating your data is SF98168. Information within this PSP describes known high-impact and pervasive problems related to upgrades and migrations. To receive this PSP information by using ECS, type this command on an iSeries command line: SNDPTFORD SF98168.

## Considerations when Moving System Customization Information

Some system customization information that is stored in the QSYS library cannot be saved. This includes network attributes, system values, the system reply list, and configuration information. You must manually re-create this information on your new or upgraded system. In addition, you will not be able to recover your problem log and your question and answer database. Use the procedure that is described in Printing system information to print your current values.

## Restoring Previous Release User Data to a New System

The preferred method to restore previous release user data on your new, target system is to use the migration method. The migration method asks you to first install the new, current release onto your old, source system. After which, you save your old system and then you perform a full system recovery onto the new, target system. Only use these instructions if it is not possible to perform the preferred migration process referenced in the **Migration** —> **Data migrations** topic in the iSeries Information Center at <http://www.ibm.com/eserver/iseriessupport/>.

This section provides instructions to restore user data from a previous-release system to a later release system. Look for supported releases for software upgrades in the *Install, upgrade, or delete i5/OS and related software* document for your new, target release. This information explains for which releases you can use these instructions to restore your previous release user data to your new system.

The restore procedure involves two save steps, and four recovery steps. The save steps include printing your system information and completely backing up your old, source system.

The recovery steps on the new, target system involve the following four steps:

1. Install Licensed Internal Code and i5/OS on the target system using new release distribution media.

**Note:**

- a. If you order a new system (feature code 0205), the system arrives with the Licensed Internal Code and the base operating system (i5/OS) preloaded on its disk units. Therefore, you can skip this step unless you are configuring a system with logical partitions. Then you will need to install the Licensed Internal Code and i5/OS on each secondary logical partition. Allow at least two additional hours to load the Licensed Internal Code and base i5/OS. If your system has more than LIC and i5/OS on it you will also need to perform this step.
2. Restore system and user data to target system using the option 21 save of the source system.
  3. Update the system information on the target system.
  4. Install QGPL, QUSRSYS, Base options, and LPPs using new release distribution media on target system.

This converts restored source data to new target release.

Verify the prerequisites below and proceed to the step-by-step instructions to restore previous release user data to a new system.

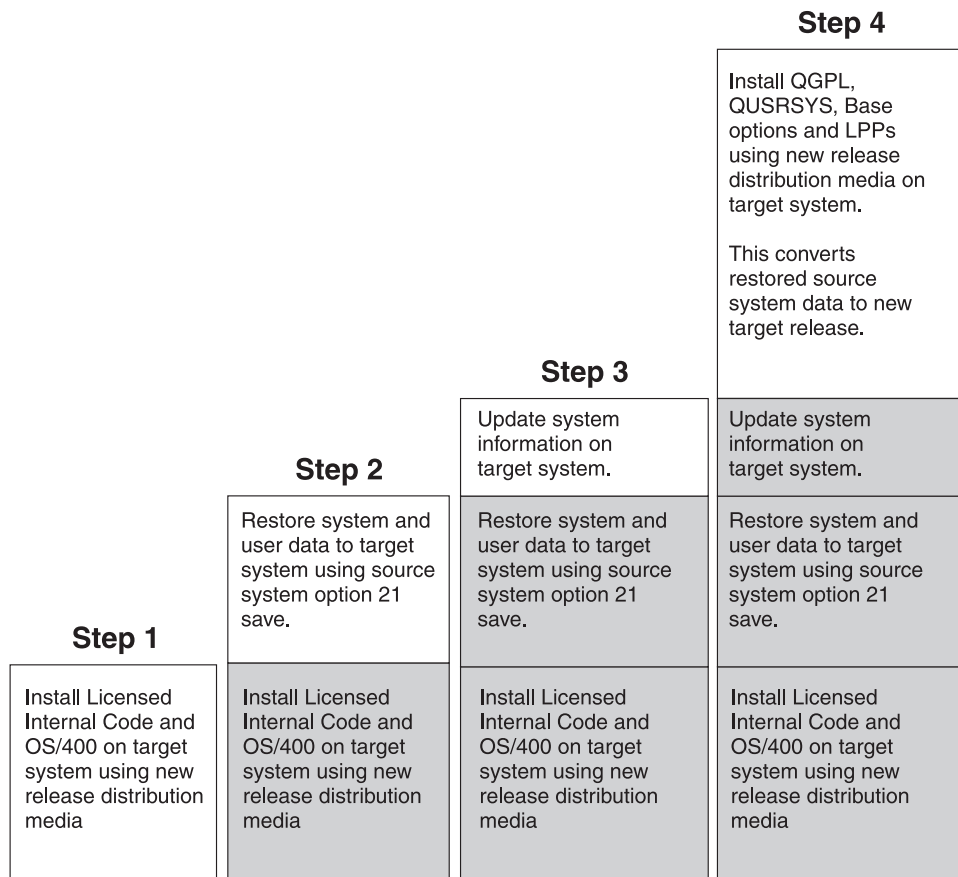

RBANS502-0

Figure 32. Recovery steps for restoring previous release user data to a new system

### Prerequisites for the recovery...

These instructions are sometimes used for a system upgrade when you install a replacement processor.

You must perform the following prerequisite steps before you start the recovery portion of these instructions:

- If available on your system, you run the RTVSYINF command on the source system. Some releases of i5/OS do not support the RTVSYINF command. When you run the RTVSYINF command, the system asks you what library to use. Typically, you should specify the QUPGRADE library. If the QUPGRADE library does not exist, you should create it with the CREATE LIBRARY (CRTLIB) command.
- If this is available on your system, you print system information with the PRVSYINF command on the source system. Some releases of i5/OS do not support the PRVSYINF command. If your release does not support it, refer to the Backup and Recovery book for the release of your i5/OS for instructions on how to print the system information.
- If necessary, save spooled files. For step-by-step instructions on how to save spooled files, see "Saving spooled files" on page 324.

**Note:** Job scheduler entries will not be restored. If necessary, make a note of your current job scheduler entries by using the Work with Job Schedule Entries (WRKJOBSCDE) command and selecting the print option. Then you can recreate the job scheduler entries manually on the new system.

- If you have remote output queues associated with remote printers, make sure you save this information:

```
SAVOBJ OBJ(*ALL) OBJTYPE(*OUTQ)
```

- You run Save menu option 21 of the GO SAVE command on the source system. Make sure that you specify the following options:
  1. Vary off the network servers...\*ALL
  2. Unmount file systems.....Y
- You have a copy of the distribution media for the target system.
- If you want to restore data to logical partitions on your target system, you have already configured the logical partitions. See the iSeries Information Center at <http://www.ibm.com/eserver/series/infocenter> for instructions to create logical partitions.
- If required, you set up device parity protection and load source mirroring on the target system. If you have not done so on the new system, consult an iSeries and AS/400 specialist to configure your DASD for your level of mirroring, and parity protection before you continue with these instructions.

### Restoring previous release user data to a new system: Step-by-step instructions

Perform the following steps on the new, target system. You will first install only the Licensed Internal Code and the i5/OS operating system from the I\_Base distribution media for the target release. Do not install any of the base options or LPPs at this time.

**Note:** If you have ordered a new system with feature code 0205, go to step 26 on page 320 after you have referred to the **i5/OS and related software** → **Install, upgrade, or delete** topic in the iSeries Information Center at <http://www.ibm.com/eserver/series/infocenter>.

Check off each item as you complete the task on the target system.

- 1. If you use the Operations Console with LAN connectivity, you may need to manually reset the service tools device ID password on the server to be the same as the iSeries device ID, in order to connect to the Operations Console. After you begin the step, you must continue until you have performed the IPL from SAVSYS media. Do not perform this as a preliminary step. If you are using V5R4 Operations Console, you only have to reset the service tools device ID password on the server. The client will automatically attempt a signon using the reset device ID password for Operations Console. See the Operations Console topic in the iSeries Information Center at <http://www.ibm.com/eserver/series/infocenter> for more information.
  - 2. If you are using Operations Console, LAN or direct connect, disconnect from your server and close Operations Console. Restart Operations Console and reconnect by using the user ID of 11111111 and password of 11111111 to sign on to your server.
  - 3. IPL the system from the first distribution media.
    - a. Mount the first distribution media on the alternate IPL device. Wait for the **READY** status.
    - b. At the CPU control panel, place the system in **MANUAL** mode.
    - c. Press the Function Select switch (or buttons) to display 02 (IPL) in the Function display.
    - d. Press **Enter**.
    - e. Press the Function Select switch (or buttons) to display D (IPL from tape or CD-ROM) in the Data display.
    - f. Press **Enter**.
    - g. If the system is powered down, press the power button on the system to power the system on. Skip to Step 6 on page 311. Otherwise, continue with Step 3h.
    - h. If the system is powered on, press the Function Select switch (or buttons) to display 03 (continue the IPL) in the Function display.
    - i. Press **Enter**.
- If you are using an HMC to IPL the system from alternate media, complete the following steps.
- a. Expand your **Management Environment** in your HMC.
  - b. Expand your Server.
  - c. Expand **Server and Partition**.
  - d. Click on **Server Management**.



- | e. Expand **Partitions**.
  - | f. Select the partition.
  - | g. Right click on the partition and select **Properties**.
  - | h. In the Partition Properties window, click the **Settings** tab.
  - | i. Under the Boot category change the **Keylock position** to Manual and the **IPL source** to D.
  - | j. Click on the **OK** button.
  - | k. Expand the partition.
  - | l. Right click on the partition profile and select **Properties**.
  - | m. Select the **Tagged I/O** tab.
  - | n. Under the Alternate restart device category press **Select**.
  - | o. Expand the Unit.
  - | p. Expand the Bus.
  - | q. Select the Slot with your I/O processor.
  - | r. Press **Select**.
  - | s. Press **OK**.
  - | t. Right click on the partition and select **Activate** if your system is powered off. Select **Shut Down Partition** if your system is running, then select **Activate**.
- \_\_\_ 4. The *Select a Language Group* screen displays the primary language feature that is currently on your distribution media. Press **Enter** to accept this value.

```

                                Select a Language Group

Note: The language feature shown is the language feature
installed on the system.

Type choice, press Enter.

Language feature . . . . . 2924
```

- \_\_\_ 5. The *Confirm Language Feature Selection* screen appears. Press **Enter** to continue.
- \_\_\_ 6. On the *Install Licensed Internal Code (LIC)* screen, select option 1 to **Install Licensed Internal Code**. Then select 2, **Install Licensed Internal Code and Initialize system**, to start the install of the Licensed Internal Code.

```

                                Install Licensed Internal Code (LIC)

Disk selected to write the Licensed Internal Code to:

  Serial Number   Type   Model   I/O Bus   Controller   Device
  xx-xxxxxxx     xxxx  xxx     x         x             x

Select one of the following:

  1. Restore Licensed Internal Code
=>2. Install Licensed Internal Code and Initialize System
  3. Install Licensed Internal Code and Recover Configuration
  4. Install Licensed Internal Code and Restore Disk Unit Data
  5. Install Licensed Internal Code and Upgrade Load Source

Selection
2
```

- \_\_\_ 7. On the *Install LIC and Initialize System - Confirmation* screen, press **F10** to confirm the initialization and to continue the install.

Install LIC and Initialize System - Configuration

Warning:

All data on this system will be destroyed and the Licensed Internal Code will be written to the selected disk if you choose to continue the initialize and install.

Return to the install selection screen and choose one of the other options if you want to perform some type of recovery after the install of the Licensed Internal Code is complete.

Press F10 to continue the install.  
Press F12 (Cancel) to return to the previous screen.  
Press F3 (Exit) to return to the install selection screen.

- \_\_\_ a. The *Initialize the Disk - Status* screen appears.

Initialize the Disk - Status

The load source disk is being initialized.

Estimated time to initialize in minutes: xx  
Elapsed time in minutes . . . . .: 0.0

- \_\_\_ b. The *Install Licensed Internal Code - Status* screen appears.

Install Licensed Internal Code - Status

Install the Licensed Internal Code in progress

Percent Complete . . . . . 0%      8.5 minutes

- \_\_\_ 8. You may see the *Accept Console* screen. If it appears, press F10 to accept the current console. On the *Accept And Set New Console Type On This IPL* press Enter to continue.
- \_\_\_ 9. On the *Disk Configuration Attention Report* screen, press F10 to accept any problems and to continue.

```

Disk Configuration Attention Report

Type option, press Enter
 5=Display Detailed Report

Press F10 to accept all the following problems and continue.
The system will attempt to correct them.

OPT Problem
_ New disk configuration

F3=Exit                F10=Accept the problems and continue

```

\_\_ 10. On the *IPL or Install the System* screen, select 3, **Use Dedicated Service Tools (DST)**.

```

IPL or Install the System

Select one of the following:

 1. Perform an IPL
 2. Install the operating system
 3. Use Dedicated Service Tools (DST)
 4. Perform automatic installation of the operating system
 5. Save Licensed Internal Code

Selection
3

```

\_\_ 11. Sign on to DST as service tools user, QSECOFR, with the password for the QSECOFR service tools user ID. The password is case sensitive; use all capital letters. You can find more information about service tools user IDs and passwords in the iSeries Information Center, <http://www.ibm.com/eserver/series/infocenter>. See **Security** -> **Service tools user IDs and passwords**.

```

Dedicated Service Tools (DST) Sign On

Type choices, press Enter.

Service tools user . . . . . QSECOFR
Service tools password . . . . . QSECOFR

```

- \_\_ a. Select option 4, **Work with Disk Units**.
  - \_\_ b. Select option 1, **Work with Disk Configuration**.
  - \_\_ c. Select option 3, **Work with ASP Configuration**.
  - \_\_ d. Select option 3, **Add Units to ASPs**.
- \_\_ 12. On the *Specify ASPs to Add Units to* screen, enter "1" for each unit that needs to be in the System ASP (ASP 1).
- \_\_ a. If you require more than one ASP, enter the corresponding ASP number on each selected unit.

Specify ASPs to Add Units to

Specify the ASP to add each unit to.

Specify ASP	Serial Number	Type	Model	Capacity	Resource Name
1	00-0103706	6602	030	1031	DD031
1	00-1000341	9337	211	542	DD012
1	00-5000341	9337	211	542	DD015
1	00-7000341	9337	211	542	DD011
1	00-3000341	9337	211	542	DD014
1	00-2000341	9337	211	542	DD013
1	00-61300	6603	074	1475	DD006
1	00-52262	6606	074	1475	DD008
1	00-86978	6606	050	1967	DD009
2	00-95744	6603	074	1475	DD005
2	00-47657	6606	074	1475	DD007
-	00-0238703	6602	074	773	DD051
-	00-0128350	6602	074	773	DD051

\_\_ b. After you complete all units, press **Enter**.

\_\_ c. If the list of units is correct, press **Enter** to start initializing the units.

\_\_ 13. On the *Problem Report* screen, press F10, **Ignore problems and continue**.

Problem Report

Note: Some action for the problems listed below may need to be taken. Please select a problem to display more detailed information about the problem and to see what possible action may be taken to correct the problem.

Type option, press Enter.

5=Display Detailed Report

OPT Problem

\_ Unit possibly configured for Power PC AS

F3=Exit

F10=Ignore problems and continue

F12=Cancel

\_\_ 14. On the *Confirm Add Units* screen, press **Enter** to confirm the selected units.

### Confirm Add Units

Add will take several minutes for each unit. The system will have the displayed protection after the unit(s) are added.

Press Enter to confirm your choice for 1=Add units.  
 Press F9=Capacity Information to display the resulting capacity.  
 Press F12=Cancel to return and change your choice.

ASP	Unit	Serial Number	Type	Model	Resource Name	Protection
1	1	00-0103706	6602	030	DD031	Unprotected
	2	00-1000341	9337	211	DD012	Unprotected
	3	00-5000341	9337	211	DD015	Unprotected
	4	00-7000341	9337	211	DD011	Unprotected
	5	00-3000341	9337	211	DD014	Device Parity
	6	00-2000341	9337	211	DD013	Device Parity
	7	00-61300	6603	074	DD006	Device Parity
	8	00-52262	6606	074	DD008	Device Parity
	9	00-86978	6606	050	DD009	Device Parity
2	10	00-95744	6603	074	DD005	Device Parity
	11	00-47657	6606	074	DD007	Device Parity
						Unprotected

- \_\_\_ a. The *Function Status* screen displays the percentage of completion.
- \_\_\_ b. The "*Selected units have been added successfully*" message appears when the system completes the **Add Units** process.
- \_\_\_ c. Press F12 to return to the *Work with Disk Configuration* screen.
- \_\_\_ d. If your system requires mirrored protection, continue to Step 14e. If your system does not require mirrored protection, press **F3** until you exit the *Dedicated Service Tools (DST)* screen.
- \_\_\_ e. To start mirrored protection for your system, follow these instructions:
  - \_\_\_ 1) On the *Work with Disk Configuration* screen, select 4, **Work with Mirrored Protection**.
  - \_\_\_ 2) On the *Work with Mirrored Protection* screen, select 2, **Start Mirrored Protection**.
  - \_\_\_ 3) Select an ASP by placing a "1" next to it. Press **Enter** to start mirrored protection.
  - \_\_\_ 4) On the *Confirm Continuation* screen, press **Enter**.
  - \_\_\_ 5) On the *Confirm Start Mirrored Protection* screen, press **Enter**.
  - \_\_\_ 6) The *Function Status* screen displays the completion status of the Start Mirrored Protection request.
  - \_\_\_ 7) The *Start mirroring completed successfully* message appears on the *Disk Configuration Information Report* screen.
  - \_\_\_ 8) Press **Enter** to continue.
- \_\_\_ f. If you use the Operations Console, follow these instructions to switch from the current console, or to verify the console mode value:
  - \_\_\_ 1) On the *IPL or Install the System* screen, select 3, **Use Dedicated Service Tools (DST)**. Press **Enter** to continue.
  - \_\_\_ 2) Sign on to DST using a service tools user profile that has security officer authority and the assigned password.
  - \_\_\_ 3) On the *Use Dedicated Service Tools (DST)* screen, select 5, **Work with DST environment**. Press **Enter** to continue.
  - \_\_\_ 4) On the *Work with DST Environment* screen, select 2, **System Devices**. Press **Enter** to continue.
  - \_\_\_ 5) On the *Work with System Devices* screen, select 6, **Console Mode**. Press **Enter** to continue.

- |           \_\_ 6) On the *Select Console Type* screen, select 2, **Operations Console** or option 3
- |           **Operations Console (LAN)**. Press **Enter** to continue.
- |           \_\_ 7) If you select option 3, **Operations Console (LAN)**, press F11 to configure the LAN
- |           console.
- |           \_\_ 8) Press **F3** or **F12** to get back to the *IPL or Install the System* screen.
- \_\_ 15. Load the first volume of installation media that contains i5/OS. (This volume is labeled B29xx\_01, where 29xx is the identifier for the primary language.)  
When you are installing from optical media, wait until the In Use indicator goes out before you continue.
- \_\_ 16. On the *IPL or Install the System* screen, select 2, **Install the Operating System**.

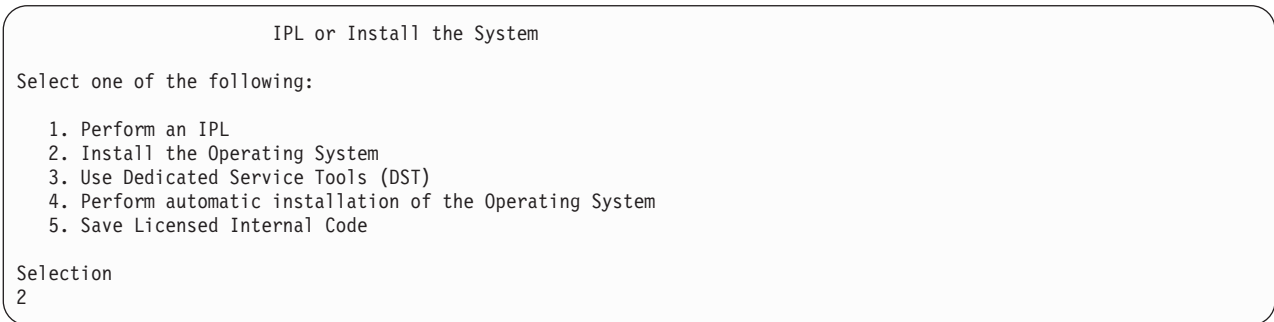

- \_\_ a. Make a selection on the *Install Device Type Selection* screen and press **Enter**.

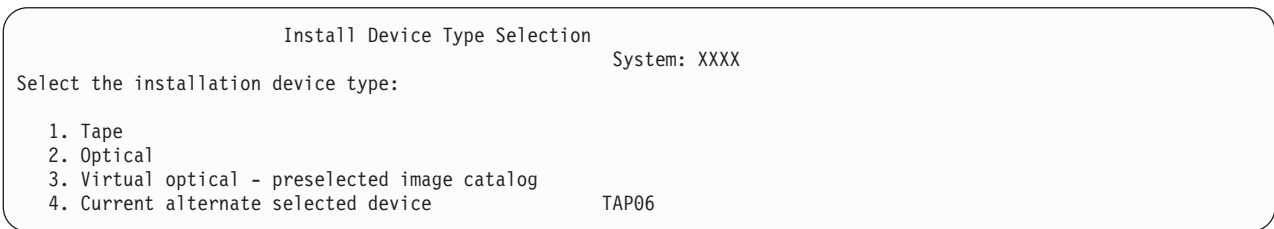

- \_\_ b. On the *Confirm Install of i5/OS* screen, press **Enter**.
- \_\_ 17. Make your selection on the *Add All Disk Units to the System* screen. If you have any nonconfigured disk units that are capable of being protected by device parity protection, but are currently unprotected, the following Add All Disk Units to the System display is shown.

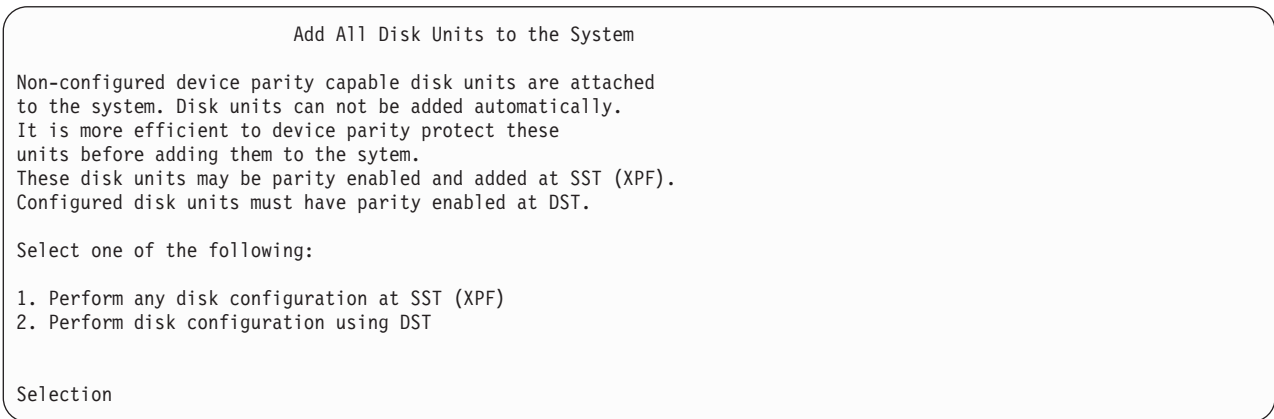

**Note:** This screen does not appear if you selected all disk units that are known to the system on Step 12 on page 313.

The *Add All Disk Units to the System* screen could also look like this:

```

                                Add All Disk Units to the System

Select one of the following:

1. Keep the current disk configuration
2. Perform disk configuration using DST
3. Add all units to the system auxiliary storage pool (ASP)
4. Add all units to the system ASP and balance data

Selection
1
```

\_\_\_ 18. The *Licensed Internal Code IPL in Progress* screen displays the IPL progress.

```

                                Licensed Internal Code IPL in Progress

IPL:
Type . . . . . : Attended
Start date and time . . . . . : xx/xx/xx xx:xx:xx
Previous system end . . . . . : Abnormal
Current step / total . . . . . : 16 16
Reference code detail . . . . . : C6004065

Ipl step                                Time Elapsed  Time Remaining
Commit Recovery                          xx:xx:xx      xx:xx:xx
Data Base Initialization                  xx:xx:xx      xx:xx:xx
Journal IPL Clean up                       xx:xx:xx      xx:xx:xx
Commit Initialization                      xx:xx:xx      xx:xx:xx
>Start the operating system                xx:xx:xx      xx:xx:xx

Item:
Current / Total . . . . . :

Sub Item:
Identifier . . . . . : Searching tape for install media
Current / Total . . . . . :

Wait for next display or press F16 for DST main menu
```

\_\_\_ 19. On the *Install the Operating System* screen, select option 1, **Take defaults**. Make sure that the values for Date and Time are correct. Press **Enter** to continue.





- Set major system options
- Define or change the system at IPL

```

                                IPL Options

Type choices, press Enter.

System date . . . . . 08/01/04   MM/DD/Y
System time . . . . . 16:58:00   HH:MM:S
System time zone . . . . . Q0000UTC F4 for list
Clear job queues . . . . . N      Y=Yes, N=No
Clear output queues . . . . . N   Y=Yes, N=No
Clear incomplete job logs . . . . . N Y=Yes, N=No
Start print writers . . . . . N   Y=Yes, N=No
Start system to restricted state . . . . . Y Y=Yes, N=No

Set major system options . . . . . Y   Y=Yes, N=No
Define or change system at IPL . . . . . Y Y=Yes, N=No

```

\_\_\_ a. On the *Set Major System Options* screen, select **N** to not enable automatic configuration.

```

                                Set Major System Options

Type choices, press Enter.

Enable automatic configuration . . . . . N      Y=Yes, N=No
Device configuration naming . . . . . *NORMAL *NORMAL, *S36,
                                         *DEVADR
Default special environment. . . . . *NONE     *NONE, *S36

```

\_\_\_ 24. The *Define or Change the System at IPL* screen appears.

\_\_\_ a. Select **3, System value commands**.

\_\_\_ b. On the *System Value Commands* screen, select **3, Work with System Values**.

\_\_\_ c. On the *Work with System Values* screen, select the System Value that you plan to change by placing a "2" next to it. Press **Enter** ONLY after you select all the values.

Update the following System Values. Write down the existing values so you can update them after the recovery, if necessary.

- | • QALWOBJRST to \*ALL
- | • QFRCCVNRST to 0
- | • QIPLTYPE to 2
- | • QINACTITV to \*NONE
- | • QJOBMSGQFL to \*PRTWRAP
- | • QJOBMSGQMX to minimum of 30 with a recommendation of 64
- | • QLMTDEVSSN to 0
- | • QLMTSECOFR to 0
- | • QMAXSIGN to \*NOMAX
- | • QPFRADJ to 2
- | • QPWDEXPITV to \*NOMAX
- | • QSCANFSCTL add \*NOPOSTRST
- | • QVFYOBJRST to 1

\_\_\_ d. After the system changes the system values, press F3 twice to return to the *Define or Change the System at IPL* screen.

- \_\_ e. On the *Define or Change the System at IPL* screen, press F3 to exit and continue the IPL.
- \_\_ 25. On the *Change Password* screen, type QSECOFR as the current password. Enter a new password. Re-enter the password to verify and press **Enter**. (New password cannot be QSECOFR.)

Change Password

Password last changed . . . . . xx/xx/xx

Type choices, press Enter.

Current password . . . . . QSECOFR

New password . . . . . \_\_\_\_\_

New password (to verify) . . . . . \_\_\_\_\_

- \_\_ 26. Because you have not selected automatic configuration, you must manually configure a tape drive to perform the following restore step for your user data and related system data.
  - \_\_ a. To configure 3422, 3430, 3480, or 3490 tape units, follow these instructions. If you have a 3490 Model E or F or to configure other types of tape units, go to step 26b on page 321.
    - 1) Use the Work with Hardware Resource (WRKHDWRSC) command to determine the location of the tape controller.
 

```
WRKHDWRSC TYPE(*STG)
```
    - 2) Create the controller description for the tape controller by doing the following:
      - a) Locate the resource name for the tape controller on the Work with Storage Resources display. The value 34xx is displayed in the *Type* column.
      - b) Write down the name of the resource.
      - c) Type a 9 (Work with resource) in the *Opt* column next to name of the tape controller and press the Enter key. You see the Work with Storage Resources display.
 

**Note:** If the resource is not listed on the display, you need to select other resources, such as disk storage controllers. For some server models, resources are now attached through combined-function IOPs. Look through the resources until you find the device you want.
      - d) Type 5 (Work with controller descriptions) in the *Opt* column in front of the tape controller. You see the Work with Controller Description display.
      - e) Type 1 (Create) in the *Opt* column on the top line.
      - f) Type the controller name (such as TAPCTL01) in the description field and press the Enter key. You see the Create Controller Description display.
      - g) If necessary, type additional information on the display. Then press the Enter key. You return to the Work with Controller Descriptions display.
      - h) If the controller description that you created does not appear, press F5 (Refresh).
    - 3) To create device descriptions for the tape units that are attached to the controller, do the following:
      - a) On the work with Controller Descriptions display, press F23 (More options). The list of options changes.
      - b) Type 9 (Work with associated descriptions) in the *Opt* column in front of the new tape controller. You see the Work with Associated Descriptions display.
      - c) Locate the resource for the tape unit. Because no device description exists, the description says \*NONE.
      - d) Write down the name of the tape resource.
      - e) Type a 1 (Create) in the *Opt* column next to the description of \*NONE and press the Enter key. You see the Create Device Desc (Tape) (CRTDEVTAP).

- f) In the *Device description* field, type a name such as TAP01.
  - g) In the *Resource name* prompt, type the name that you wrote down in step 26a3d on page 320. (If you did not write it down, press F12 to return to the display. Repeat steps 26a3d through 26a3g.)
  - h) Press the Enter key.
  - i) Additional parameters appear on the display.
  - j) If necessary, type additional information on the display. Then press the Enter key. You return to the Work with Associated Descriptions display.
  - k) Press F5 (Refresh). The name of the description that you created should now be associated with the resource.
  - l) Type 8 (Work with configuration status) in front of the controller description and the device description. You see the Work with Configuration Status display.
  - m) Type 1 (Vary on or Make available) in front of the controller and the devices.
- 4) Press F3 until your return to your original menu.
- \_\_\_ b. To configure tape units that are not models 34xx, use the following instructions:
- 1) Use the Work with Hardware Resource (WRKHDWRSC) command to determine tape controller name.  
WRKHDWRSC TYPE(\*STG)
  - 2) Locate the tape controller on the Work with Storage Resources display.
  - 3) Type a 9 (Work with resource) next to tape controller name and press the Enter key.
- Note:** If the tape controller is not listed on the display, you need to select other resources, such as disk storage controllers. For some server models, tape units are now attached through combined-function IOPs. Look through the resources until you find the tape unit you want.
- 4) Locate the resource name for the tape unit (in most cases it is TAP01).
  - 5) Enter a 5 (Work with Configuration Descriptions) in the *Opt* column next to the tape resource name and press the Enter key.  
You are shown the Work with Configuration Descriptions display.
  - 6) Type a 1 (Create) in the *Opt* field and a tape device description name (for example, TAP01) in the *Description* field. Press the Enter key. You are shown the Create Device Description (Tape) display.
  - 7) Change any values that you want to change, then press the Enter key (twice) to create the device description. You are shown the Work with Configuration Descriptions display again. The device that you created should appear on the display.
  - 8) Type an 8 (Work with configuration status) in front of the new device description. You are shown the Work with Configuration Status display.
  - 9) Type a 1 (Vary on or Make available) in front of the new device. If the status does not change to Varied On or Available, wait a few minutes. Then press F5 (Refresh). If the status still does not change to Varied On or Available, follow normal problem analysis for the device.
  - 10) Press F3 until you return to the main menu.

i5/OS Main Menu

Select one of the following:

1. User tasks
2. Office tasks
3. General system tasks
4. Files, libraries, and folders
5. Programming
6. Communications
7. Define or change the system
8. Problem handling
9. Display a menu
10. Information Assistant options
11. iSeries Access tasks
  
90. Sign off

Selection or command  
=>

- \_\_\_ 27. Use the save media of the option 21 save from the source system to perform the following steps to restore the user data and related system data, and user data to the target system:
- \_\_\_ a. ENDSBS SBS(\*ALL) OPTION(\*IMMED)
  - \_\_\_ b. Prevent messages that are not necessary by typing: CHGMSGQ MSGQ(QSYSOPR) DLVRY(\*NOTIFY) SEV(99)
  - \_\_\_ c. RSTUSRPRF DEV(*media-device-name*) ALWOBJDIF(\*ALL) ENDOPT(\*LEAVE)
  - \_\_\_ d. RSTCFG OBJ(\*ALL) DEV(*media-device-name*) OBJTYPE(\*ALL) SRM(\*NONE) ALWOBJDIF(\*ALL) ENDOPT(\*LEAVE)
  - \_\_\_ e. If you saved remote output queue information for printers, RSTOBJ OBJ(\*ALL) OBJTYPE(\*OUTQ) MBROPT(\*ALL) ALWOBJDIF(\*ALL)
  - \_\_\_ f. RSTLIB SAVLIB(\*NONSYS) DEV(*media-device-name*) OPTION(\*NEW) ALWOBJDIF(\*ALL) MBROPT(\*ALL) FRCOBJCVN(\*NO) ENDOPT(\*LEAVE) OMITOBJ(QOFC)
- Note:** This command does not restore the QAUDJRN and QACGJRN objects and any job scheduler entries
- \_\_\_ g. RSTDLO DLO(\*ALL) DEV(*media-device-name*) SAVFLR(\*ANY) ALWOBJDIF(\*ALL) ENDOPT(\*LEAVE)
- Note:** If you have DLOs in any of your user ASPs, you need to use the following command to restore DLOs to each user ASP: RSTDLO DLO(\*ALL) ALWOBJDIF(\*ALL) SAVASP(ASP-number) RSTASP(ASP-number)
- \_\_\_ h. RST DEV('/QSYS.LIB/*media-device-name*.DEVD') OBJ(('/\*') ('/QSYS.LIB' \*OMIT) ('/QDLS' \*OMIT)) ALWOBJDIF(\*ALL)
  - \_\_\_ i. To restore spooled files that you saved on your source system, do the following:
    - \_\_\_ 1) In "Saving spooled files" on page 324, you saved spooled files to database files in a library. If that library has not yet been restored to your upgraded system, restore it now by using the RSTLIB command.
- Note:** Use the RSTLIB command only if you used the SAVLIB command to save the objects. If you used the SAVOBJ command, you must use the RSTOBJ command.
- \_\_\_ 2) For each spooled file that you need to restore, do the following:
    - \_\_\_ a) On the printout that you used when you saved the spooled files, locate the name of the printer file that was used to create the spooled file. It appears in the File column on the left side of the printout.

- \_\_\_ b) To override the control character value for the QPRINTS file, type the following command: `OVRPRTF FILE(QPRINTS) CTLCHAR(*FCFC)`
  - \_\_\_ c) Copy the database file to the printer file by typing the following: `CPYF FROMFILE(LIBSPLF/SPOOLF1) TOFILE(QGPL/QPRINTS) MBROPT(*REPLACE)`  
In this example, a spooled file named QPRINTS is placed on the output queue that is associated with the definition for the QPRINTS printer file.
  - \_\_\_ d) Delete the database file by using the Delete File (DLTF) command.
- \_\_\_ 3) When you restored all spooled files, delete the override for the QPRINTS file by typing the following: `DLTOVR FILE(QPRINTS)`
- \_\_\_ j. It is recommended that you start object conversion (STROBJCVN) to convert user objects from the format used in the previous version, release, and modification level of an IBM-supported operating system to the format required for use in the current operating system.
- \_\_\_ 28. If you used the RTVSYISINF command on the source system, you must now run the UPDSYISINF command to update the system information on the target system.  
If your source system does not support the RTVSYISINF command, you need to use the printed system information to update **all** system information such as system values, message reply lists entries, etc. on the target system.  
The RTVSYISINF command does not update all system information. Use the printed system information to update additional system information such as access path recovery times, subsystem descriptions, RJE configurations, etc.
- \_\_\_ 29. Install the base options (including QGPL and QUSRSYS) and other licensed programs using the distribution media for the target system (current release) and the GO LICPGM command. Ensure that your optical installation is varied on. Refer to the iSeries Information Center, <http://www.ibm.com/eserver/series/infocenter>. See **i5/OS and related software --> Install, upgrade, or delete i5/OS and related software --> Upgrade or replace i5/OS and related software --> Upgrade or replace software using manual installation --> Replace the licensed programs**. Begin with step 5, The i5/OS Main Menu appears on your console. Do not continue with the Checklist: Completing the upgrade or replacement until instructed to do so.
- \_\_\_ 30. Run the RSTAUT command.
- \_\_\_ 31. If necessary, change the following system values back to their original values by using the WRKSYSVAL command:
  - QALWOBJRST
  - QIPLTYPE
  - QJOBMSGQFL
  - QJOBMSGQMX
  - QPFRADJ
  - QVFOBJRST
- \_\_\_ 32. If you do not know the password for the restored QSECOFR profile, change the password before signing off. Type the following command:  
`CHGUSRPRF USRPRF(QSECOFR) PASSWORD(new-password)`
- \_\_\_ 33. Type the command, `DSPJOBLOG *PRINT`. Check the job log to ensure that the job restored all objects. To verify if the job restored all objects, spool the job log for printing along with any remaining spooled job output. Check for any error messages. Correct the errors and restore those objects from media. If you are using this checklist as part of a data migration, return to the iSeries Information Center at <http://www.ibm.com/eserver/series/infocenter>: **Migration -> Data Migrations -> Migration -> Perform the migration -> Complete the migration from a 4xx or 5xx server**.

- \_\_\_ 34. Complete the installation. Refer to the Software Installation manual for your target release. Follow the instructions in the chapter that contains the Checklist for Completing the Installation. It instructs you to Install the cumulative PTF package; when you do this, accept the default option to perform an IPL of the system.
- \_\_\_ 35. Add job scheduler entries with the ADDJOBSCDE command using the information you printed from your source system. Use the Work with Job Schedule Entries (WRKJOBSCDE) command and select the print option.
- \_\_\_ 36. If you installed **iSeries Integration for Windows Server** on your system and you saved with your network servers in a VARIED OFF setting, perform the following steps:
  - \_\_\_ a. Add the links for the server descriptions. Type the following for each server description:
 

```
ADDNWSSTGL NWSSTG(Storage_Name) NWS(Server_Description)
```
  - \_\_\_ b. Vary on your network servers by typing WRKCFGSTS \*NWS and selecting option 1 to vary on each network server.

### Saving spooled files

When you save a library that contains output queues, you save the descriptions of the output queues but not their contents. If you have critical spooled files that you will need after the upgrade procedure, you can use the following procedure to save them:

- \_\_\_ 1. Create a library to hold copies of the critical spooled files by using the CRTLIB command. For example, to create a library called LIBSPLF to hold your spooled files, type the following: CRTLIB LIB(LIBSPLF)

**Note:** If the spooled files contain confidential information, specify AUT(\*EXCLUDE) on the CRTLIB command.

- \_\_\_ 2. Use the Work with Output Queue command to locate the spooled files that you want to save from a designated output queue: WRKOUTQ OUTQ(lib-name/queue-name) OUTPUT(\*PRINT)

**Note:** If you do not have special output queues that are designated for critical spooled files, type WRKOUTQ OUTQ(\*ALL)

- \_\_\_ 3. Print out and retrieve the listing of the spooled files that you need to save.
- \_\_\_ 4. On the printout, mark the spooled files that you need to save.
- \_\_\_ 5. For each spooled file, do the following:
  - \_\_\_ a. Choose a name (8 characters or less) for the spooled file that will help you to identify it. Each file should have a unique name.
  - \_\_\_ b. Create a database file to hold the contents of the spooled file by typing the following: CRTPF FILE(LIBSPLF/file-name) RCDLEN(133)

**Notes:**

- 1) For file-name, substitute the name that you assigned in step 5a.
- 2) Use an appropriate record length for the spooled file that you are copying. The record length must be at least 1 character larger than the spooled data to allow for the control character.
- 3) If you are copying a large spooled file, specify SIZE(\*NOMAX) when you create the database file.

- \_\_\_ c. Copy the contents of the spooled file to the database file that you created by typing the following: CPYSPLF FILE(spooled-file) TOFILE(LIBSPLF/file-name) JOB(job-number/user-name/job-name) SPLNBR(nnn) CTLCHAR(\*FCFC)

**Note:** For spooled-file, substitute the value from the File column on the listing that you created in step 2.

- \_\_\_ d. You may receive message CPA3312 if the spooled file contains special attributes. Respond with G (GO) to continue saving the contents of the spooled file.

- \_\_\_ 6. Repeat step 5 on page 324, steps 5a on page 324 through step 5d on page 324, for each spooled file that you need to save.
- \_\_\_ 7. If you have additional output queues to process, return to 2 on page 324.
- \_\_\_ 8. Use the SAVLIB command to save the library that contains the copies of your spooled files.

**Note:** Use this method if you are saving spooled files on a release earlier than V5R4M0. For release V5R4M0 and later, you can save the output queues with their contents by specifying SPLFDTA(\*ALL) when you save the output queues

## **Restrictions When Going from Previous Release to Current Release**

Previous releases of i5/OS may support products that are not supported at the current release. For a list of products that will no longer work with the current release, see the iSeries Support Web site at <http://www.ibm.com/servers/eserver/series/support/planning>. To avoid losing data that depends on these products, migrate that data from your server to an accessible location before upgrading to the current release.





---

## Chapter 15. System Synchronization-Planning and Procedures

System synchronization is the second part of moving data between two systems. You perform system synchronization if you have purchased a new system, you have moved all of your data to the new system, and one of the following applies:

- The existing system is a production system that needs to stay up and running while you convert to the new system.
- You want to test the new system before making the switch over.

Since the existing system is a production system, changes occur to the existing system which do not get applied to the new system. Therefore after you have loaded the new system, you need to synchronize the new system and the existing system before you can put the new system into production.

You can perform system synchronization only if one the following is true:

- The new system and the existing system are at the same release. You have fully reloaded the new system from the existing system either using “Recovering your entire system after a complete system loss—Checklist 20” on page 85.
- The new system is at a newer release than the existing system. You have fully reloaded the new system from the source system using one of the procedures in Chapter 14, “Release-to-Release Support,” on page 299.

The method that you use to synchronize the two systems is the side-by-side method. The underlying principal of the side-by-side method is that you will run your existing system and your new system in parallel for a test period. During that test period, you will periodically perform activities to synchronize the data on your new system with the data on your existing system. At the end of the test period, you will perform final synchronization activities before moving your production work to your new system. When you complete your final synchronization, the software environment on the two systems should be identical.

The topics that follow discuss several different approaches that you can take for performing synchronization. In all cases, synchronization requires careful planning and monitoring. It also requires a good understanding of your applications and the library structure on your system. Running two systems in parallel also requires strong change-control practices. This chapter focuses primarily on synchronizing data.

If possible, during the synchronization period you should carefully limit other changes on your existing system, such as adding or changing user profiles or changing the system distribution directory. When this type of change to system customization occurs on your existing system, you need to manually perform the same updates on your new system.

You might find the security auditing function helpful for keeping track of changes to system information on your existing system. If you are not familiar with security auditing see the *iSeries Security Reference* book. It describes how to set up security auditing and which values to choose to get the entries that you need.

You can print the entries in the audit journal receiver and enter the same information on your new system. The Security ToolKit provides a function to select, format, and print (or display) audit journal entries.

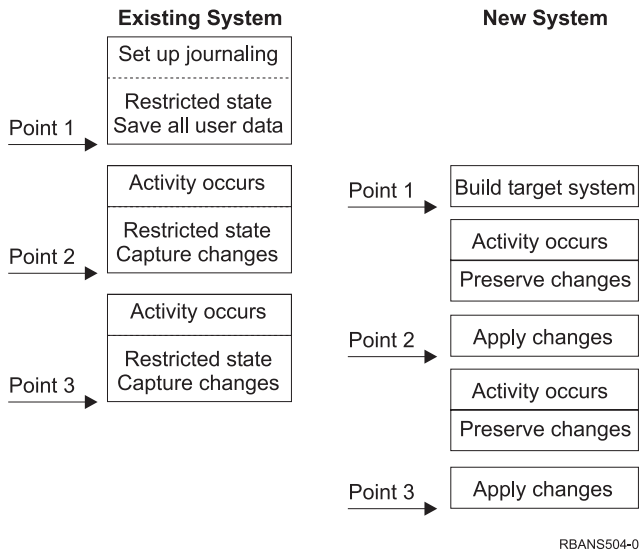

Figure 33. Overview of Synchronization Process

Figure 33 provides an overview of the synchronization process. The process starts with building an initial test environment that matches a known point on your existing system (**Point 1**). Periodically, you establish a new known point (synchronization point) on your existing system. **Point 2** and **Point 3** are examples of synchronization points. After preserving any work that you have performed on your new system, such as object conversion, you use one of the synchronization methods to bring your new system to the same level as your existing system.

While you read and plan, consider how the options for synchronization relate to your current procedures (such as regular save procedures and change control procedures). By using your existing procedures as a starting point, you can reduce the level of disruption and build on your existing base of knowledge. For example, if you currently use object journaling, then object journaling might be a logical part of your synchronization strategy. If no one in your organization has experience with object journaling, then it might not be the best solution for you.

#### Start with a Valid Test Environment

All of the following synchronization methods assume that you start by loading an entire copy of your existing system to your new system. To create this initial test environment, you must follow the sequence in your reload checklist to ensure that the system correctly merges your user data with licensed program data. The reload checklist is "Recovering your entire system after a complete system loss—Checklist 20" on page 85 if you are restoring to the same release or the procedures in Chapter 14, "Release-to-Release Support," on page 299 if you are restoring to a higher release.

## Synchronization Methods: Overview

Following are the common methods for synchronizing test and existing systems:

### Moving changed objects

With this method, you periodically save everything on your existing system that has changed since your last synchronization point. You then restore these changed objects to the new machine.

### Moving libraries

With this method, you periodically copy entire libraries from your existing system to your new system. This method works best when your programs are in separate libraries from your database files. You synchronize the libraries that contain database files.

### Moving individual objects

With this method, you periodically copy specific objects, such as database files, from your existing system to your new system.

### Applying journaled changes

With this method, you journal objects on your existing system. You move the journal receivers from your existing system to your new system. You apply the journaled changes to the test objects on your new system. This method is sometimes used in conjunction with moving changed objects.

### Refreshing new system

With this method, you periodically refresh your new system by restoring an entire copy of your existing system.

Table 61 provides a comparison of these synchronization methods. It also shows where you can read more about each method. You can use these methods individually or in combination.

Table 61. Comparison of Synchronization Methods

Method	Complexity	Risk	Time Required for Synchronization	Frequency Used	Where to Read More About It
Moving changed objects	High	Medium to high	Medium	High	"Moving Changed Objects"
Moving libraries	Low	Low to medium	Medium	Medium to high	"Moving Entire Libraries" on page 334
Moving objects	Medium to high	Low to medium	Low to medium	Medium	"Moving Individual Objects" on page 335
Applying journaled changes	High	High	Medium <sup>1</sup>	Low	"Applying Journaled Changes" on page 336
Refreshing new system	Low	Low	High	Low	"Refreshing Your new system" on page 338

<sup>1</sup> The time required to apply journaled changed depends on how many journal entries need to be applied, and how many objects you need to apply those entries to. The greater these two numbers are, the longer synchronization time is.

---

## Moving Changed Objects

With this method, you periodically save everything that has changed since your last synchronization point. You then restore those changed objects to your new system. The recommended method when you save changed objects is to specify an exact reference date and time that corresponds to your last synchronization point. This ensures that the contents of your save tapes are not affected by any intermediate save operations that might have occurred since your last synchronization point.

Following is an example of the save and restore procedures when you use this method. You will need to change these sample steps to meet the needs of your own situation. This example assumes that the last synchronization point was at 1800 hours (6 p.m.) on July 27, 1998.

## Steps for Saving Changed Objects

Perform these steps on your existing system:

1. To avoid any problems with inadequate authority, sign on as the security officer (QSECOFR).
2. Place your system in a restricted state to ensure that you get a stable copy of the changed objects on your existing system.
3. Use the Save Security Data (SAVSECDDTA) command to save all user profiles. You use this information to correctly synchronize ownership and authority for any new objects that you move.

- To save objects that have changed since your last synchronization point, use the Save Changed Object (SAVCHGOBJ) command. This command example saves objects in libraries (the QSYS.LIB file system):

```
SAVCHGOBJ OBJ(*ALL) LIB(*ALLUSR) DEV(tape-device)
  OBJJRN(*YES) REFDATE('07/27/xx') REFTIME(180000)
  ACCPTH(*YES)
```

**Note:** If you are using the SAVCHGOBJ method in conjunction with applying journaled changes, specify OBJJRN(\*N0).

- If you have user libraries whose names begin with Q, save the changed objects in those libraries. Repeat step 4 and substitute the name of your Q library in place of \*ALLUSR.

**Note:** The online information for the LIB parameter tells which Q libraries are included when you specify \*ALLUSR.

- To save document library objects that have changed since your last synchronization point, use the Save Document Library Object (SAVDLO) command:

```
SAVDLO DLO(*SEARCH) DEV(tape-device)
  REFCHGDATE('07/27/xx') REFCHGTIME(180000)
  SRCHTYPE(*ALL) OWNER(*ALL)
```

- You cannot just save changed mail. You must save all mail, if necessary. To save mail, use the Save Document Library Object (SAVDLO) command as follows:

```
SAVDLO DLO(*MAIL)
```

- To save objects in directories that have changed since your last synchronization point, do the following:

**Note:** \*LANSERVER and \*NETWARE are not supported on V4R5M0 or later.

- If you have any network server descriptions (NWSDs), you must vary them off before starting the save procedure. Use the command WRKCFGSTS CFGTYPE(\*NWS) (Work with Configuration Status) to display the configured NWSDs on your system.

Select option 2 (Vary off) on this display to vary off the NWSDs.

**Note:** Alternatively, use the Vary Configuration command to vary off a NWSD:

```
VRYCFG CFGOBJ(XXX) CFGTYPE(*NWS) STATUS(*OFF)
```

- Use the Save (SAV) command to save changed objects:

```
SAV DEV('/QSYS.LIB/tape-device.DEVD')
  OBJ((/*' *INCLUDE) ('/QSYS.LIB' *OMIT)
  ('/QDLS' *OMIT)) CHGPERIOD('07/27/xx' 180000)
  UPDHST(*YES)
```

- To vary on the network servers, use the WRKNWSSTS command and select option 14. Use the WRKCFGSTS \*NWS command to display all network servers and select option 1 to vary on any that were previously varied off.
- Use the Start Subsystem (STRSBS) command to restart the controlling subsystem to return your system to productive use.
- To display the log of what changed objects the system saved, use the Display Job Log (DSPJOBLOG) command.
- Print the job log and highlight each library that was saved. You will need this information to restore changed objects.

## Steps for Restoring Changed Objects

### Test Objects to Preserve

This example assumes that you are not making permanent changes to volatile objects (such as database files) on your new system. When you restore, you will be overlaying test objects.

It also assumes that after you build your initial new system, you will not restore programs from the existing system to the new system during synchronization (because those programs are already converted on your new system).

If you need to preserve test objects or if programs change on your existing system, you need to make special plans for your restore procedures.

To restore the changed objects that you saved, perform these steps on your test system:

For more information about restoring changed objects, refer to “What Happens When You Restore Objects” on page 32.

1. To avoid any problems with inadequate authority, sign on as the security officer (QSECOFR).
2. Place your system in a restricted state.
3. To restore the saved user profiles, use the Restore User Profile (RSTUSRPRF) command:

```
RSTUSRPRF USRPRF(*ALL) DEV(tape-device)  
          ENDOPT(*LEAVE)
```

4. If your new release is V4R3M0 or a newer release, you can omit this step. If your test machine has a different serial number, use the Change User Profile (CHGUSRPRF) command to add \*ALLOBJ special authority to user profiles, if necessary.
5. Locate the printout of the job log from your save operation. Use it to determine which libraries the system saved. If you do not have the job log, you can use the Display Tape (DSPTAP) command to display the contents of the save tapes:

```
DSPTAP DATA(*SAVRST) OUTPUT(*PRINT)
```

6. For each library on the save tapes, type the following:

```
RSTOBJ OBJ(*ALL) DEV(tape-device) OBJTYPE(*ALL)  
       SAVLIB(library-name) ENDOPT(*LEAVE) MBROPT(*ALL)
```

#### Notes:

- a. For both the QGPL library and the QUSRSYS library, you must specify MBROPT(\*NEW). This prevents overlaying new system files with old system files.
  - b. Do not specify ALW0BJDIF(\*ALL). Normal restore processing with the default ALW0BJDIF value protects you from accidentally overlaying critical information. ALW0BJDIF(\*ALL) is intended only when you are initially loading information from one system to another.
  - c. If your new system has a different ASP configuration from your existing system, you might need to specify the SAVASP and RSTASP parameters.
7. To restore document library objects that you saved in step 6 on page 330, type the following:

```
RSTDLO DLO(*ALL) DEV(tape-device) ENDOPT(*LEAVE)
```

#### Notes:

- a. Do not use this restore command unless your save tapes contain only changed DLOs. If you restore all DLOs from your existing system, you will overlay IBM-supplied objects that are used for iSeries Access.
- b. This command does not restore mail that has changed. Mail gets restored in step 8.
- c. Changes to calendars are restored when you restore the QUSRSYS library.
- d. If you have DLOs in more than one ASP, you need to run the RSTDLO command for each ASP. You specify the SAVASP and RSTASP parameters.

8. To restore mail that you saved in step 7 on page 330, use the Restore Document Library Object (RSTDLO) command as follows:

```
RSTDLO DLO(*MAIL)
```

9. To restore the changed directory objects that you saved in 8b on page 330, type the following:

```
RST DEV('/QSYS.LIB/tape-device.DEVD')  
OBJ('//*' *INCLUDE) ('/QSYS.LIB' *OMIT) ('/QDLS' *OMIT))
```

10. Use the Display Job Log to print your job log:

```
DSPJOBLOG OUTPUT(*PRINT)
```

Review it carefully. Whenever you restore changed objects, you are likely to encounter situations that you will need to recover manually. If you plan to synchronize your system several times, you might find it useful to create a log that describes synchronization problems and their resolutions. This will help to reduce your synchronization time in the future.

“Problems When Restoring Changed Objects” describes common problems and solutions when restoring changed objects.

11. After you resolve any problems that occurred with restored objects, use the Restore Authority (RSTAUT) command to restore private authorities.

**Note:** You should wait to restore authority until after you resolve any problems because some problem resolution steps might require you to restore new objects.

12. Restart the controlling subsystem and make the system available for more testing.

## Problems When Restoring Changed Objects

Because you specify `ALWOBJDIF(*NONE)` when you restore changed objects, the system compares heading information on the system copy of an object with heading information on the media copy. When the system detects discrepancies that might indicate mismatches, the system does not restore an object. Following are common cases where this occurs in a test environment and possible solutions:

### Problems Restoring Journal Receivers

If you are journaling objects on both your existing system and your new system, you might have cases where two different journal receivers exist with the same name. Usually this occurs because you change journal receivers on both systems. The systems automatically generate the same next-receiver name.

In some environments, you may not need the information that is in the journal receivers on your new system. Use the Change Journal (CHGJRN) command to create and attach a new journal receiver with a unique name. Then you can simply save and delete the journal receivers that you do not need (on your new system).

**Note:** This strategy applies when you are using a change-object synchronization method. If you plan to apply journaled changes to synchronize systems, you need to devise a method for naming and changing journal receivers that allows you to successfully restore journal receivers.

For more information about the rules to name, attach, and restore journal receivers, see the Journal Management topic in the iSeries Information Center at <http://www.ibm.com/eserver/iseriesseries/infocenter>.

### Problems Restoring Database File Members

When you delete and re-create a database file, that database file has a different file level identifier than the previously saved version. Therefore, the file level identifier for the database file on your save media that you attempt to restore will not match the file level identifier on the new database file. When this type of mismatch occurs, the system will not restore the database file using the default values on the restore command parameters. The same problem occurs when you delete and re-create individual members for a database file, causing the member level identifiers of a file to mismatch.

Following are several options for handling this problem. Choose the correct option for your situation. Base your decision on your synchronization requirements and your application architecture. Always make sure that you have a good backup of your new system.

**Recovery Option 1—Allow file level identifier differences on the restore operation:** If you specify \*FILELVL on the ALWOBJDIF parameter of the restore command, the file and/or member level identifier of a physical file can be different. If a database physical file already exists on the system with a different file and/or member level identifier than the saved physical file, then an attempt will be made to restore the physical file data. The file and/or member level identifiers of the physical file on the system remain unchanged. Objects other than physical files will be restored as if ALWOBJDIF(\*NONE) is specified.

**Recovery Option 2—Restore entire library:** A simple solution is to restore the entire library from your existing system to your new system. To do this, you will need to first clear the library on your new system. To use this option, you might need to change your save strategy. For libraries where you regularly delete and re-create database files or members, you might not be able to use the SAVCHGOBJ approach.

**Recovery Option 3—Delete files or members before restoring:** Another option is to delete (from the new system) the database file or the database file member that causes the problem. When you use this method, you must make provisions for any logical files that are dependent on the files or members that you plan to delete. Do the following:

1. To determine whether dependent logical files exist, use the Display Database Relationships (DSPDBR) command on your test system:

```
DSPDBR FILE(library-name/file-name) MBR(member-name)
```

**Note:** Specify the member only when you need to delete individual members instead of the whole file.

2. If no database dependencies exist, continue with step 5.
3. On your existing system, use the SAVOBJ command to save each dependent file to tape.
4. On your test system, use the Delete File (DLTF) command to delete each dependent file.
5. On your test system, delete the physical files or file members.
6. From your SAVCHGOBJ tape, use the RSTOBJ command to restore the physical files or physical file members that you could not previously restore.
7. If you saved dependent files in step 3, use the RSTOBJ command to restore them.

**Recovery Option 4—Use a temporary library:** A variation of the previous option is to use a temporary library on your new system. Do the following:

1. On the test system, use the Create Library (CRTLIB) to create a temporary library.
2. Restore the physical files or file members from your SAVCHGOBJ tape to the temporary library. (Use the RSTOBJ command with the SAVLIB and RSTLIB parameters.)
3. To determine whether dependent logical files exist, use the Display Database Relationships (DSPDBR) command on your test system:

```
DSPDBR FILE(library-name/file-name) MBR(member-name)
```

**Note:** Specify member only when you need to delete individual members instead of the whole file.

4. If no database dependencies exist, continue with step 7.
5. On the test system, use the Copy File (CPYF) command to copy dependent files from the original libraries to the temporary library.
6. Delete the dependent files from the original libraries.
7. Delete the physical files from the original libraries.
8. Copy the physical files from the temporary library to the original libraries.
9. If the temporary library contains any dependent files, copy them to the original libraries.

10. Use the Delete Library (DLTLIB) command to delete the temporary library.

## Problems with Object Authority or Ownership

To protect you from someone who might attempt to restore an illicit program to your system, the system makes authority or ownership changes during some restore operations. Review the job log to determine whether these changes occurred. You can use the Change Object Owner (CHGOBJOWN) command to transfer ownership to the correct user profile. You can use the Edit Object Authority (EDTOBJAUT) command to make changes to public authority for an object.

---

## Moving Entire Libraries

When your library structure is organized to separate volatile information (for example, database files) from static information (for example, programs), this synchronization method might be simple and effective. You can periodically restore entire database file libraries from your existing system to your new system.

- | **Note:** Do not use this method for IBM supplied (Qxxx) libraries, for example, libraries QSYS2, QGPL,  
| and QUSRSYS.

Following is an example of the steps for moving a library:

1. On your existing system, sign on with the QSECOFR user profile to avoid authority problems.
2. Place your existing system in a restricted state to ensure that you get a fixed (static) copy of the database files.
3. Use the SAVSECDTA command to save all user profiles. You use this information to correctly synchronize ownership and authority for any new objects that you move.
4. Use the Save Library (SAVLIB) command to save the libraries to tape:

```
SAVLIB LIB(library-name) DEV(tape-device)  
      ENDOPT(*LEAVE) ACCPTH(*YES)
```

### Notes:

- a. Specify ENDOPT(\*REWIND) when you save the last library.
  - b. You can specify multiple libraries on the SAVLIB command.
5. Restart the controlling subsystem on your existing system.
  6. On your test system, sign on with the QSECOFR user profile to avoid authority problems.
  7. Place your new system in a restricted state to ensure that you do not have restore problems because of object-locking conflicts.
  8. Use the Clear Library (CLRLIB) for each library that you plan to restore. This eliminates any potential problems with objects not restoring because of mismatches between the media version and the system version.

**Note:** If you restore a library that contains Structured Query Language (SQL) collections that contain \*DTADCT objects, for each of these libraries use the Delete Library (DLTLIB) command. (Use DLTLIB rather than Clear Library (CLRLIB). SQL collections that contain \*DTADCT objects will fail during the Restore Library (RSTLIB) operation unless you first delete the library.

9. To restore the saved user profiles, use the RSTUSRPRF command:  
RSTUSRPRF USRPRF(\*ALL) DEV(*tape-device*) ENDOPT(\*LEAVE)
10. If your new release is V4R3M0 or a newer release, you can omit this step. If your test machine has a different serial number, use the Change User Profile (CHGUSRPRF) command to add \*ALLOBJ special authority to user profiles, if necessary.
11. For each library that you saved, use the Restore Library (RSTLIB) command:

```
RSTLIB SAVLIB(library-name) DEV(tape-device) MBROPT(*NEW)  
      ENDOPT(*LEAVE) OPTION(*NEW) ALWOBJDIF(*ALL)
```



**Notes:**

- a. If you have a different ASP organization on your new system, you might need to specify the SAVASP and RSTASP parameters.
  - b. You specify ALWOBJDIF(\*ALL) because you may be restoring to a system with a different serial number. ALWOBJDIF(\*ALL) links the authorization lists back with the objects. You should only specify ALWOBJDIF(\*ALL) when you are restoring to an empty library or the library does not exist on the system.
  - c. When you restore the last library, specify ENDOPT(\*REWIND) unless you have additional objects to restore from the tape.
12. Check your job log to ensure that the system successfully restored the libraries.
  13. Use the “Restoring Object Authorities” on page 206 (RSTAUT) command to restore private authorities to objects.

## Considerations for Moving Entire Libraries

Following are some considerations when you use this synchronization method:

- You might want to combine this method with the SAVCHGOBJ method. For example, you might move several large libraries that contain database files. You can use the SAVCHGOBJ command for other libraries (by using the OMITLIB parameter on the SAVCHGOBJ command to omit libraries that you are moving in their entirety). SQL collections containing \*DTADCT objects will fail during the Restore Library (RSTLIB) operation unless you first delete the library.
- When you use this method, you need to decide how to handle DLOs and objects in directories. You might use a save-changed method for those objects. Or, you might consider moving entire folders or directories if that method will work with your folder and directory organization.
- In all cases, it is essential that you have a complete copy of your existing system on tape before you cut over to your new system. This provides for recovery if you discover you have neglected to synchronize some critical objects.

---

## Moving Individual Objects

With this method, you periodically copy specific objects (or example, database files) from your existing system to your new system. This method is most often used in two situations:

- When you have a short test period, careful change control, and a very well-defined set of database files that change frequently.
- When you plan to completely rebuild your new system at the end of the test period. In this case, you might periodically move individual objects to create a more current set of test data on your new system.

Following is an example of the procedure for moving individual objects:

1. On your existing system, sign on with the QSECOFR user profile to avoid authority problems.
2. Place your existing system in a restricted state to ensure that you get a fixed (static) copy of the database files.
3. Use the SAVSECDTA command to save all user profiles. You use this information to correctly synchronize ownership and authority for any new objects that you move.
4. Use the SAVOBJ command to save individual objects that you want to synchronize:

```
SAVOBJ OBJ(object-name)  
      LIB(library-name)  
      OBJTYPE(object-type)  
      DEV(tape-device) ENDOPT(*LEAVE)
```

**Notes:**

- a. Specify ENDOPT(\*REWIND) for the last object.

- b. On the same SAVOBJ command, you can save multiple objects of the same type from the same library.
  5. Restart the controlling subsystem on your existing system.
  6. Place your new system in a restricted state.
  7. On the new system, use the RSTUSRPRF command:
 

```
RSTUSRPRF USRPRF(*ALL) DEV(tape-device)
          ENDOPT(*LEAVE)
```
  8. If your new release is V4R3M0 or a newer release, you can omit this step. If your test machine has a different serial number, use the Change User Profile (CHGUSRPRF) command to add \*ALLOBJ special authority to user profiles, if necessary.
  9. For each library that contains objects that you saved, use the RSTOBJ command:
 

```
RSTOBJ OBJ(*ALL) SAVLIB(library-name)
          DEV(tape-device) ENDOPT(*LEAVE) OBJTYPE(*ALL)
```
- Notes:**
- a. If you have a different ASP organization on your new system, you might need to specify the SAVASP and RSTASP parameters.
  - b. When you restore the last object, specify ENDOPT(\*REWIND).
10. Check your job log to ensure that the system successfully restored the objects.
  11. Use the RSTAUT command to restore private authorities to objects.
  12. Restart the controlling subsystem on your new system.

---

## Applying Journalled Changes

With this synchronization method, you use server journaling capabilities to synchronize the information in journalled objects on your test and existing systems. This is most commonly used either by installations that already use and understand journaling or by installations that have very large journalled objects.

The advantage of this method is that you save and restore only the changes that occur to a journalled object, not the entire object. The disadvantage of this method is its complexity. See the Journal Management topic in the iSeries Information Center at <http://www.ibm.com/eserver/series/infocenter> for more information about journaling.

### Journal Before Saving

You must set up journaling on your existing system before you perform the save operation from which you build your new systems. When you start journaling for an object, the system assigns a journal ID number (JID) to that object. An object must have a JID before you save it from your existing system and restore it to your new system or you will not be able to apply journalled changes to the test version. For more information about restoring journalled objects see "Restoring Objects That Are Journalled" on page 226.

Conceptually, when you use journaling to synchronize objects, you do the following to establish a synchronization point:

1. On your existing system, do the following:
  - a. Save security data to get a current copy of user profiles and private authorities.
  - b. Save new journal receivers (that contain entries that you have not yet applied on your new system).
  - c. Save any new objects (that do not yet exist on your new system).
2. On your new system, do the following:
  - a. Restore user profiles (to get any new profiles and current authority information).

- b. Restore any new objects.
- c. Restore journal receivers.
- d. Apply journaled changes from the journal receivers.
- e. Restore authority to any new objects.

Following is an example of the steps for using journaled changes to synchronize systems:

1. To establish a checkpoint on your existing system, do the following:
  - a. Use the Work with Journal Attributes (WRKJRNA) command to determine what journal receivers have been created since your last checkpoint.
  - b. Write down the names of the new journal receivers.
  - c. Determine whether any files, or data areas, have been added to any journaled objects since your last checkpoint. You can use the DSPJRN command to do this by typing the following:

```
DSPJRN JRN(journal-name) JRNCD((D) (E) (Q)) ENTYP(JF EG QB)
      RCVRNG(first-receiver *CURRENT)
```

For *first-receiver*, use the name of the first receiver after the most recent checkpoint.

**Note:** If you are journaling integrated file system objects, and your directories are not using the inherit journaling attribute, look for new integrated file system objects by adding B to the JRNCD parameter, and JT to the ENTYP parameter.

- d. Write the new object names on a list. (You will need to save them later.)
  - e. If you have other journals on your system, repeat step 1a through step 1c for each additional journal.
  - f. For each journal on your system, use the CHGJRN command to detach the current journal receivers and attach new journal receivers.
  - g. Use the SAVOBJ command or SAV command to save any newly journaled objects that you listed in step 1d and step 1c.
 

**Note:** The system needs an exclusive lock on an object to save it. You might need to stop certain application activity on your system to be able to save the newly journaled objects.
  - h. Use the SAVOBJ command to save the journal receivers that you listed in step 1b.
  - i. If you do not have a current copy of your user profiles on tape, use the SAVSECDTA command to save them to tape.
  - j. You have completed establishing a new checkpoint (such as **Point 2**) on your existing system.
2. To synchronize the journaled objects on your new system with the existing versions, do the following:
    - a. Place your new system in a restricted state.
    - b. On the new system, use the RSTUSRPRF command:
 

```
RSTUSRPRF USRPRF(*ALL) DEV(tape-device)
          ENDOPT(*LEAVE)
```
    - c. If your new release is V4R3M0 or a newer release, you can omit this step. If your test machine has a different serial number, use the Change User Profile (CHGUSRPRF) command to add \*ALLOBJ special authority to user profiles, if necessary.
    - d. Use the RSTOBJ or RST command to restore any objects that you saved in step 1g.
    - e. Use the RSTOBJ command to restore the journal receivers that you saved in step 1h.
    - f. Use the Apply Journaled Changes (APYJRNCHG) command to bring your journaled objects to the checkpoint level:
      - For the starting receiver, specify the journal receiver that was created and attached when you established your most recent checkpoint on the existing system. For the ending receiver, specify \*CURRENT.
      - For the starting sequence number, specify \*FIRST.
      - For the ending sequence number, specify \*LAST.

See the Journal Management topic in the iSeries Information Center at <http://www.ibm.com/eserver/series/infocenter> to understand what journal entries may either be skipped or may stop the apply process.

- g. Use the RSTAUT command to restore private authorities for any new objects that you restored.
- h. Restart the controlling subsystem on your new system.

---

## Refreshing Your new system

When you use this method, you periodically rebuild your entire new system from the current information on your existing system. To ensure that user data and system data are merged correctly, you must follow the same procedure that you used when you initially built your new system:

1. Install the Licensed Internal Code from scratch.
2. Install OS/400.
3. Restore user data.
4. Install licensed programs.

**Note:** The preceding list is a conceptual view of the sequence. Use the checklists for the complete list of steps.

Before refreshing your new system, be sure to save the work that you have already performed on your new system. In particular, save any program objects that you have converted. After you have rebuilt the new system, restore these converted objects.

---

## Additional Synchronization Tips

Following are some additional considerations when you plan to keep your test and existing systems synchronized during a test period:

- Synchronization (especially the first few times) can be difficult. You should always save your entire new system before you begin your synchronization efforts. With these save tapes available, you have the option of restoring your entire new system and starting the synchronization again (or changing synchronization methods).
- To synchronize correctly, you need to understand how to save and restore the authority to objects. When you use the SAVSECDTA command, the system saves user profiles, authorization lists, and private authorities.

When you restore user profiles (RSTUSRPRF \*ALL), the system restores user profiles and authorization lists. It puts private authority information in work files on the system. After you restore objects, use the RSTAUT command to re-establish the private authorities that are in the work files.

- When you are ready to perform your final synchronization before you move your new system to productive use, be sure to plan both for disaster recovery and for verification. If possible, keep your former existing system functional during the verification period in case you discover objects that you did not properly synchronize.

In addition, make sure that you save an entire copy of your former existing system to tape before you dismantle it. You might need the objects on these tapes if you discover errors in your synchronization procedures.

Finally, print listings from your former existing system that you can use as a basis for verifying the validity of information on your new existing system.

- Good synchronization requires careful change-control procedures. You must plan for information that you cannot easily synchronize automatically, such as changes to system information. As much as possible, you should freeze changes to this type of information during your test period.
- If you do not use the SAVCHGOBJ command as part of your synchronization strategy, you might need to use special procedures to synchronize mail.

Following are the steps for moving mail from your existing system to your new system:

1. On your existing system, use the SAVDLO command:  
SAVDLO DLO(\*MAIL) DEV(*tape-device*)
  2. On your new system, use the RSTDLO command:  
RSTDLO DLO(\*MAIL) DEV(*tape-device*)
- To synchronize the Backup Recovery and Media Services licensed program, do the following:

**Note:** Use the following tip only for BRMS installations that do not share media information with other systems.

1. On your existing system, stop all activity that might place locks on objects in the Backup Recovery and Media Services libraries. If you have scheduled jobs that use Backup Recovery and Media Services, you need to hold them.

2. Mount a tape that is compatible with the tape unit on your new system.

3. Type the following:

```
SAVLIB LIB(QBRM QUSRBRM) DEV(tape-device)
```

**Note:** If you want, you can use save files and transfer the libraries electronically.

4. On the new system, do the following:

- a. Stop all activity that might place locks on objects in the Backup Recovery and Media Services libraries. If you have scheduled jobs that use Backup Recovery and Media Services, you need to hold them.

- b. Save a copy of the current Backup Recovery and Media Services product; enter the following command:

```
SAVLICPGM LICPGM(57nnBR1) DEV(tape-device)
```

(Replace *nn* with the appropriate number for your release, for example, DSPPTF 5763BR1 for V3R2.)

- c. Delete the version of Backup Recovery and Media Services that has outdated information; enter the following command:

```
DLTLICPGM LICPGM(57nnBR1)
```

- d. Mount the tape that you created in step 3.

- e. Restore the Backup Recovery and Media Services libraries; enter the following command:

```
RSTLIB SAVLIB(QBRM QUSRBRM) DEV(tape-device)
```

- f. Load the tape that you created using SAVLICPGM in step 4b.

- g. Restore the current version of Backup Recovery and Media Services; enter the following command:

```
RSTLICPGM LICPGM(57nnBR1) DEV(tape-device)
```

- h. To set up Backup Recovery and Media Services again, consult *Backup Recovery and Media Services for iSeries*.



---

## Part 4. Tips for Merging two or more i5/OS systems

<b>Chapter 16. Tips for merging two systems into a single system</b> . . . . .	343
Guidelines for Restoring Information from the Development System . . . . .	343





---

## Chapter 16. Tips for merging two systems into a single system

Merging systems is a complex process. Various factors can affect merging systems that include the software release, system names, or IBM-supplied objects. The following information is provided as a guideline to assist you in the planning process of merging systems. You should consult the documentation for your additional products to ensure proper migration.

Objects that can migrate from one system only are:

- Directory entries
- Office enrollments
- Distribution lists
- Other IBM-supplied files or libraries
- System values
- Network attributes
- Access path recovery times
- Communications configurations
- System reply list
- Edit descriptions

Determine which system to restore all of these objects from and restore that system first. If you have a production system and a development system, restore the production system first, then follow the guidelines below to restore the information from the development system.

---

### Guidelines for Restoring Information from the Development System

1. Determine which system to restore first. To assist in determining this, you may need to answer several questions: Which system is more complex? Which has more users? Which system is more critical to your operations? If you are choosing between merging a production system and merging a development system, selecting the production system is recommended.

Restore the production system by following the steps in Table 26 on page 86.

2. User profiles and associated objects that are the same on both systems will not be merged. However, they are affected in the following manner:
  - Object owners, authorization lists, and primary groups will be restored from the production system.
  - Passwords and group connections will be restored from the development system.
  - Merging of private authorities is an AND operation. The object authorities and data authorities will be added together from both systems. The resulting authorities on the merged system will be the higher of the matching authorities from the production and development systems.
  - USRPRF (\*NEW) and OMITUSRPRF are parameters that may be useful when you consolidate systems. They allow you to restore only new user profiles or omit certain user profiles. Refer to "Restoring User Profiles" on page 202 for more information.
3. Groups of configurations that are needed from the development system may be restored with the Restore Configuration (RSTCFG) command:

```
RSTCFG OBJ(workstation) OBJTYPE(*DEVD)
        SRM(*NONE)
```

Automatic configuration may also be enabled to recover the groups of configurations from the development system.

4. User libraries may be restored with the Restore Library (RSTLIB) command.

**Note:** Be sure to omit any IBM-supplied libraries such as QGPL and QUSRSYS.

If there are libraries that are the same on both systems, you should consider using the OPTION(\*NEW) parameter to restore only the new objects:

```
RSTLIB SAVLIB(User library) OPTION(*NEW)
```

Then determine which objects you want from each system and restore those objects individually. If there are objects in QGPL or QUSRSYS that are unique to either system, those objects should be restored individually as well.

5. Documents and folders may be restored with the RSTDLO command. When saving documents and folders to be restored, any IBM-supplied folders should be omitted when using the SAVDLO command:

```
SAVDLO DLO(*ALL) OMITFLR(Q*)
```

If any IBM-supplied folders are restored, the original information may be overwritten. Additional considerations will need to be made if any of the DLOs are from a previous release.

6. The integrated file system may be restored with the following command:  
RST OPTION(\*NEW)
7. Once the preceding instructions have been completed, run the Restore Authorities (RSTAUT) command.
8. Once the RSTAUT command completes, perform a normal IPL.

---

## Part 5. Alternate Installation Device

### Chapter 17. Using an Alternate Installation

<b>Device</b> . . . . .	347
Alternate Installation Device—Overview . . . . .	347
Setting up an Alternate Installation Device . . . . .	347
Disabling an Alternate Installation Device . . . . .	350
Verifying and selecting an alternate installation device during a manual installation . . . . .	350



---

## Chapter 17. Using an Alternate Installation Device

---

### Alternate Installation Device—Overview

You can perform installation and recovery procedures by using the primary installation device along with an alternate installation device that you define. The alternate installation device can be a tape device or an optical device. Some servers, typically with faster devices attached, might see a performance improvement when using an alternate installation device. You can use the alternate installation device for any installation or recovery that requires replacing Licensed Internal Code. Some models may require that you set up an alternate installation device.

When you use an alternate installation device, the system may use the primary installation device to load a small portion of the Licensed Internal Code during an IPL-type D and then continues the installation by using the media in the alternate installation device. The media in the alternate installation device can be SAVSYS media or distribution media created by a central site.

**Attention!**

Tape devices attached by a Fibre Channel interface will need to be set up as alternate installation devices.

If you use an alternate installation device, you need to ensure that you set up the device and that you enable the device. You also need to have the CD-ROM, DVD-RAM, or tape media that contains the Licensed Internal Code and your save media.

---

### Setting up an Alternate Installation Device

Before you use an alternate installation device, you need to ensure that you define it on a bus, and you must enable the device. You need to record and keep the logical address of the system bus and system card at which the alternate installation device is attached. If you have the device set up on a different bus and you do not have this information available, you will not be able to complete installations or recoveries.

- | It is helpful to record the tape or optical drive's serial number that you plan to use as the alternate
- | installation device.

If you change the configuration of your system, you need to ensure that this information is correct before you start to use the alternate installation device.

Do the following to set the addresses and enable the alternate installation device:

**Note:** You need to know the password for Dedicated Service Tools to perform this procedure.

- \_\_\_ 1. Place the media that contains the current release Licensed Internal Code into the primary installation device.
- \_\_\_ 2. Set the system mode to **Manual**. Then perform an IPL using the command: PWRDWSYS OPTION(\*IMMED) RESTART(\*YES) IPLSRC(B).

**Note:** An alternative to this step is to select function 21. (Dedicated Service Tools). If you use this alternative, the next step is step 4 on page 348. You will not need to perform step 12 on page 349.

**Attention logical partitioning users!**

If you are going to use this command on a primary partition, be sure to power off all secondary partitions before running the command.

If you are using Hardware Management Console for eServer, see the eServer Hardware Information Center at <http://www.ibm.com/servers/library/infocenter/>.

- \_\_\_ 3. When the IPL or Install the System display appears, select option 3 (Use Dedicated Service Tools (DST)) and press the Enter key.
- \_\_\_ 4. The Dedicated Service Tools (DST) Sign On display appears.

```
                Dedicated Service Tools (DST) Sign On                System:  SYSTEMA
Type choices, press Enter.
Service tools user . . . . . QSECOFR
Service tools password . . . . . _____
```

Sign on using the QSECOFR user profile.

**Note:** Do **not** sign on with a profile other than QSECOFR.

- \_\_\_ 5. The Use Dedicated Service Tools (DST) menu appears. From the Use Dedicated Service Tools (DST) menu, do the following:
  - a. Select option 5 (Work with DST environment).
  - b. Select option 2 (System devices) on the Work with DST Environment display.
  - c. Select option 5 (Alternate installation device) on the Work with System Devices display.
  - d. Select your device type on the Select Media Type display.
- \_\_\_ 6. From the Select Alternate Installation Device display, type a 1 (Select) next to the resource you want and press the Enter key.

```
                Select Alternate Installation Device                System:  SYSTEMA
Additional devices may be available for use. Press F5 to see
if any additional devices have been detected.
Type option, press Enter.
  1=Select  5=Display details

```

Option	Bus Number	Resource Name	Type	Model	Serial Number	Selected
-	1	TAP08	6386	001	00-11111	
-	3	TAP19	3570	B11	13-22222	*

```
F2=Deselect device  F3=Exit  F5=Refresh  F12=Cancel
```

- \_\_\_ 7. The Display Device Details display appears.

```

                                Display Device Details
                                System:  SYSTEMA

Resource
Name           Type           Model          Serial
TAP19          3570           B11            13-22222

Physical location:
Location text . . . . . :
Frame ID . . . . . :
Card slot . . . . . :

Logical address:
SPD bus:
System bus . . . . . : 0003
System board . . . . . : 0000
System card . . . . . : 0002

Storage:
I/O bus number . . . . . : 0000
Controller . . . . . : 0007
Device address . . . . . : 0000

F3=Exit  F12=Cancel

```

You need to have a record of the addresses assigned to the alternate installation device selected for installing a system. Record the following information:

- Type/Model: \_\_\_\_\_
- System bus: \_\_\_\_\_
- System card: \_\_\_\_\_
- Serial number: \_\_\_\_\_

**Notes:**

- a. You may want to repeat this process to record the addresses for all alternate installation devices that appear in step 6 on page 348. You should store this information in a safe place, such as the location where your recovery information and recovery media are stored.
- b. If more than one alternate installation device is defined, only one can be enabled.
- c. You should ensure that only one device contains valid installation media. This prevents you from loading the wrong version of the Licensed Internal Code.

Press the Enter key.

- \_\_\_ 8. The Select Alternate Installation Device display appears. Type 1 (Select) next to the resource you want and press the Enter key.
- \_\_\_ 9. You should see the following message at the bottom of the display:  
Alternate installation device selected
- \_\_\_ 10. Press F3 (Exit) to return to the Use Dedicated Service Tools (DST) display.
- \_\_\_ 11. Press F3 (Exit) again. The Exit Dedicated Service Tools (DST) display appears.

```

                                Exit Dedicated Service Tools
                                System:  SYSTEMA

Select one of the following:

1. Exit Dedicated Service Tools (DST)
2. Resume Dedicated Service Tools

```

Type 1 (Exit Dedicated Service Tools (DST)) and press the Enter key.

- \_\_\_ 12. The next display you see is the IPL or Install the System display. Type 1 (Perform an IPL) and press the Enter key to complete the procedure.

---

## Disabling an Alternate Installation Device

You may need to disable an alternate installation device for one of the following reasons:

- To continue with an installation using the primary installation device.
  - To enable a different device as an alternate installation device.
  - To correct the logical address if hardware has been moved or changed.
- \_\_ 1. Use the control panel to set the mode to **Manual**. Then perform an attended IPL using the command: `PWRDWN SYS OPTION(*IMMED) RESTART(*YES) IPLSRC(B)`.

**Note:** An alternative to this step is to select function 21. (Dedicated Service Tools). If you use this alternative, skip steps 2 and 9.

### Attention logical partitioning users!

If you are going to use this command on a primary partition, be sure to power off all secondary partitions before running the command.

If you are using Hardware Management Console for eServer, see the eServer Hardware Information Center at <http://www.ibm.com/servers/library/infocenter/>.

- \_\_ 2. When the IPL or Install the System display appears, select option 3 (Use Dedicated Service Tools (DST)) and press the Enter key.
- \_\_ 3. The Dedicated Service Tools (DST) Sign On display appears. Sign on using the QSECOFR user profile.
- \_\_ 4. The Use Dedicated Service Tools (DST) menu appears. From the Use Dedicated Service Tools (DST) menu, do the following:
- a. Select option 5 (Work with DST environment).
  - b. Select option 2 (System devices) on the Work with DST Environment display.
  - c. Select option 5 (Alternate installation device) on the Work with System Devices display.
- \_\_ 5. At the Select Alternate Installation Device display, press F2 (Deselect device).
- \_\_ 6. You should see the following message at the bottom of the display:
- ```
Alternate installation device deselected
```
- \_\_ 7. Press F3 (Exit) to return to the Use Dedicated Service Tools (DST) display.
- \_\_ 8. Press F3 (Exit) again. The Exit Dedicated Service Tools (DST) display appears. Type 1 (Exit Dedicated Service Tools (DST)) and press the Enter key.
- \_\_ 9. The next display you see is the IPL or Install the System display. Type 1 (Perform an IPL) and press the Enter key to complete the procedure.

---

## Verifying and selecting an alternate installation device during a manual installation

- \_\_ 1. The Install Licensed Internal Code display appears.

```
Install Licensed Internal Code                               System:  XXXX
Select one of the following:
1. Install Licensed Internal Code
2. Work with Dedicated Service Tools (DST)
3. Define alternate installation device
```



Type 3, and press Enter. This will verify the address of an alternate installation device attached to the system and determine whether it is enabled or disabled.

- \_\_\_ 2. **Verifying and Selecting Alternate Installation Device:** The Select Alternate Installation Device Bus display appears.

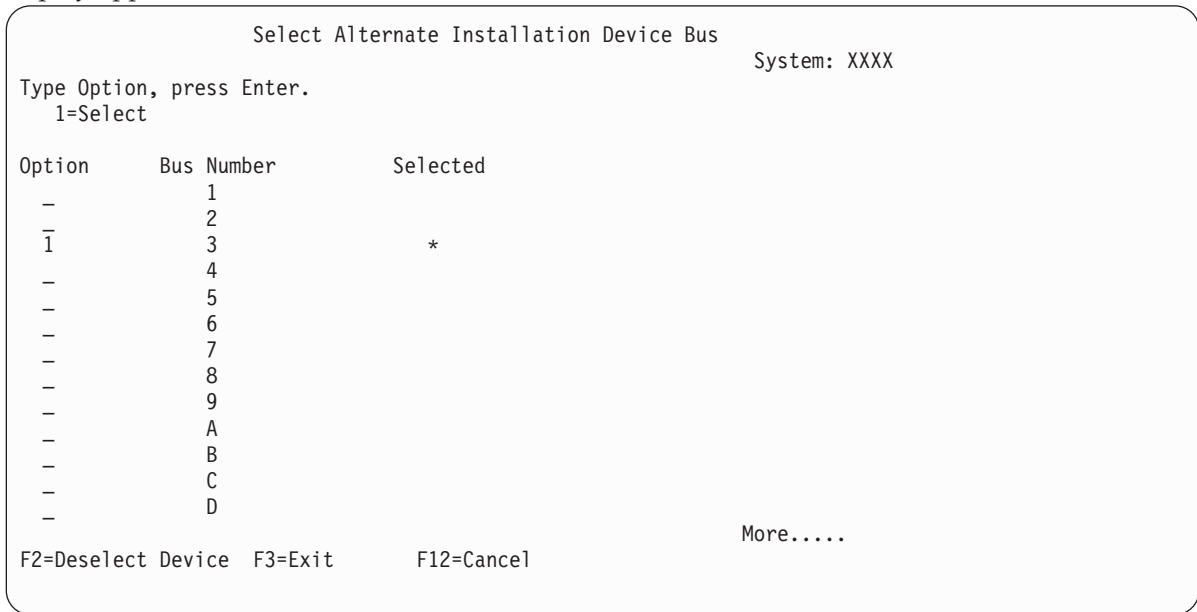

- \_\_\_ a. Verify that the selected device is on the correct system bus. Type 1 in the Options field next to the selected bus, and press Enter to view information about the device that is attached to the bus. This may take several minutes. If you see the message No alternate installation device configured, wait one minute and refresh the screen.
- \_\_\_ b. Select the media type on the Select Media Type display.
- \_\_\_ c. The Select Alternate Installation Device display appears. Use this display to verify the resource name, type, model, and serial number for the device.

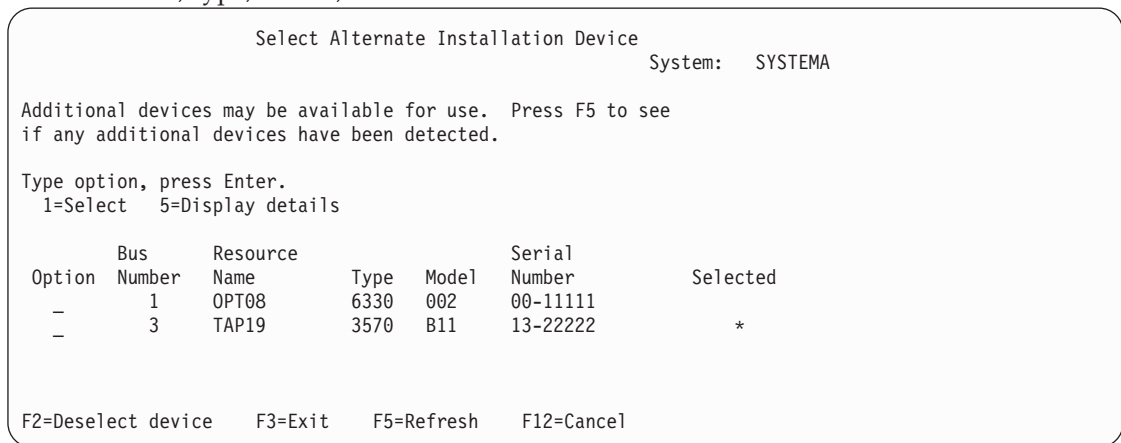

- \_\_\_ d. Type 1 to select the device and make any needed corrections to select, enable, or disable the device. Press Enter to confirm the changes.
- \_\_\_ e. The message Alternate installation device selected appears. Press F3 to return to the Install Licensed Internal Code display.
- \_\_\_ f. Type 1 and press Enter to install the Licensed Internal Code.

**End of Verifying and Selecting Alternate Installation Device.**

- | If you are using an HMC to IPL the system from alternate media, complete the following steps.

- | 1. Expand your **Management Environment** in your HMC.
- | 2. Expand your Server.
- | 3. Expand **Server and Partition**.
- | 4. Click on **Server Management**.
- | 5. Expand **Partitions**.
- | 6. Select the partition.
- | 7. Right click on the partition and select **Properties**.
- | 8. In the Partition Properties window, click the **Settings** tab.
- | 9. Under the Boot category change the **Keylock position** to Manual and the **IPL source** to D.
- | 10. Click on the **OK** button.
- | 11. Expand the partition.
- | 12. Right click on the partition profile and select **Properties**.
- | 13. Select the **Tagged I/O** tab.
- | 14. Under the Alternate restart device category press **Select**.
- | 15. Expand the Unit.
- | 16. Expand the Bus.
- | 17. Select the Slot with your I/O processor.
- | 18. Press **Select**.
- | 19. Press **OK**.
- | 20. Right click on the partition and select **Activate** if your system is powered off. Select **Shut Down Partition** if your system is running, then select **Activate**.

## Part 6. Disk Configuration and Protection

### Chapter 18. Configuring Disks and Disk Protection . . . . . 355

|                                                                                                                      |     |
|----------------------------------------------------------------------------------------------------------------------|-----|
| Choosing the Right Procedure for Configuring Disks . . . . .                                                         | 355 |
| Configuring Disks on a New System—Checklist 1 . . . . .                                                              | 355 |
| Adding Disk Units without Device Parity Protection—Checklist 2 . . . . .                                             | 356 |
| Adding Disk Units to an Existing Input/Output Adapter—Checklist 3 . . . . .                                          | 358 |
| Adding a New Input/Output Adapter—Checklist 4 . . . . .                                                              | 359 |
| Moving Disk Units Between Non-Mirrored Auxiliary Storage Pools—Checklist 5 . . . . .                                 | 360 |
| Moving Disk Units Between Mirrored Auxiliary Storage Pools—Checklist 6 . . . . .                                     | 361 |
| Deleting an Auxiliary Storage Pool—Checklist 7 . . . . .                                                             | 362 |
| Removing Disk Units Without Device Parity Protection—Checklist 8 . . . . .                                           | 363 |
| Removing Disk Units That Have Device Parity Protection from an ASP Without Mirrored Protection—Checklist 9 . . . . . | 364 |
| Removing Disk Units That Have Device Parity Protection from an ASP With Mirrored Protection—Checklist 10 . . . . .   | 365 |
| Using System Service Tools and Dedicated Service Tools . . . . .                                                     | 366 |
| How to Start Dedicated Service Tools (DST) . . . . .                                                                 | 366 |
| How to Stop Dedicated Service Tools (DST) . . . . .                                                                  | 368 |
| Starting System Service Tools (SST) . . . . .                                                                        | 368 |
| Stopping System Service Tools (SST) . . . . .                                                                        | 368 |
| How to Display Your Disk Configuration . . . . .                                                                     | 368 |
| Displaying Your Disk Configuration—Hardware View . . . . .                                                           | 369 |
| Displaying Your Disk Configuration—Software View . . . . .                                                           | 370 |
| Interpreting Disk Configuration and Status Displays . . . . .                                                        | 372 |

### Chapter 19. Working with Auxiliary Storage Pools . . . . . 375

|                                                                                     |     |
|-------------------------------------------------------------------------------------|-----|
| How to Add Disk Units to an Auxiliary Storage Pool . . . . .                        | 375 |
| How to Change the Storage Threshold for an Auxiliary Storage Pool . . . . .         | 377 |
| How to Change the Storage Threshold for the System Auxiliary Storage Pool . . . . . | 378 |
| How to Move a Disk Unit to a Different Auxiliary Storage Pool . . . . .             | 380 |
| How to Remove a Disk Unit from an Auxiliary Storage Pool . . . . .                  | 382 |
| How to Delete an Auxiliary Storage Pool . . . . .                                   | 384 |
| Calculating Space Requirements for an Auxiliary Storage Pool . . . . .              | 385 |
| How to Display the Objects in a User ASP . . . . .                                  | 385 |
| Balancing an Auxiliary Storage Pool . . . . .                                       | 386 |
| Capacity Balancing . . . . .                                                        | 386 |

|                                                                           |     |
|---------------------------------------------------------------------------|-----|
| Usage Balancing . . . . .                                                 | 386 |
| Hierarchical Storage Management (HSM) Balancing . . . . .                 | 386 |
| Transferring Objects between Auxiliary Storage Pools . . . . .            | 386 |
| How to Move Authorities to a Different ASP . . . . .                      | 387 |
| How to Transfer a Library to a Different ASP . . . . .                    | 387 |
| How to Transfer a Folder to a Different ASP . . . . .                     | 388 |
| How to Transfer Journals and Objects to a Different ASP . . . . .         | 388 |
| How to Create Objects in a Library User ASP . . . . .                     | 389 |
| Placing a Document in a Basic ASP—Example . . . . .                       | 390 |
| Placing an Object in a User ASP—Example . . . . .                         | 390 |
| Creating a UDFS in User ASP—Example . . . . .                             | 390 |
| How to Place Journal Receivers in a User ASP . . . . .                    | 390 |
| Placing Journal Receivers in a Library User ASP . . . . .                 | 390 |
| How to Move Journal Receivers From an Overflowed Basic User ASP . . . . . | 391 |
| How to Reset a Journal with a Status of Overflowed . . . . .              | 391 |
| How to Work with Nonlibrary User ASPs . . . . .                           | 393 |
| Creating Objects in a Nonlibrary User ASP . . . . .                       | 393 |
| Transferring an Object to a Nonlibrary User ASP . . . . .                 | 393 |
| Transferring a Journal to a Nonlibrary User ASP . . . . .                 | 394 |
| Placing Journal Receivers in a Nonlibrary Basic ASP . . . . .             | 394 |

### Chapter 20. Working with Device Parity Protection . . . . . 397

|                                                                                                                         |     |
|-------------------------------------------------------------------------------------------------------------------------|-----|
| Starting Device Parity Protection . . . . .                                                                             | 397 |
| How to Start Device Parity Protection for an Input/Output Adapter . . . . .                                             | 397 |
| Stopping Device Parity Protection . . . . .                                                                             | 399 |
| How to Stop Device Parity Protection on an Input/Output Adapter . . . . .                                               | 399 |
| How to Remove Disk Units that have Device Parity Protection for an iSeries server with the system powered on . . . . .  | 400 |
| How to remove disk units that have device parity protection for an iSeries server with the system powered off . . . . . | 402 |
| How to remove disk units that have device parity protection for an eServer i5 . . . . .                                 | 405 |
| How to include a disk unit in device parity protection . . . . .                                                        | 406 |
| How to Exclude a Disk Unit from Device Parity Protection . . . . .                                                      | 407 |
| How to Display Device Parity Status . . . . .                                                                           | 408 |

### Chapter 21. Working with Mirrored Protection . . . . . 411

|                                                                   |     |
|-------------------------------------------------------------------|-----|
| Mirrored Protection—Configuration Rules . . . . .                 | 411 |
| How to Start Mirrored Protection . . . . .                        | 411 |
| What the System Does When You Start Mirrored Protection . . . . . | 413 |
| Mirrored Protection Configuration Errors . . . . .                | 413 |

|                                                     |            |
|-----------------------------------------------------|------------|
| How to Stop Mirrored Protection . . . . .           | 414        |
| <b>Chapter 22. Working with Disk Compression</b>    | <b>417</b> |
| Introduction to Disk Compression . . . . .          | 417        |
| Restrictions and Considerations . . . . .           | 417        |
| Disk Compression and Capacity . . . . .             | 418        |
| Disk Unit Full Considerations . . . . .             | 419        |
| How The System Responds to Disk Unit Full           |            |
| 448 Reference Code A6xx 0277 . . . . .              | 420        |
| SRC Code A6xx 0277 . . . . .                        | 420        |
| User Action 1 . . . . .                             | 422        |
| User Action 2 . . . . .                             | 422        |
| User Action 3 . . . . .                             | 423        |
| User Action 4 . . . . .                             | 423        |
| Examples of A6xx 0277 . . . . .                     | 423        |
| How to Start Disk Compression . . . . .             | 424        |
| How to Stop Disk Compression . . . . .              | 426        |
| Procedural Sequences for Configuring Disks and      |            |
| Protection . . . . .                                | 428        |
| Adding a New I/O Compression-Capable                |            |
| Storage Controller . . . . .                        | 428        |
| Adding Disk Units to an Existing                    |            |
| Compression-Capable Storage Controller . . . . .    | 429        |
| Moving Disk Units from the System ASP to a          |            |
| User ASP . . . . .                                  | 430        |
| Recovering from Error Codes . . . . .               | 431        |
| Recovering from SRC 6xxx 7051 . . . . .             | 431        |
| Recovering from SRC 6xxx 7052 . . . . .             | 432        |
| <b>Chapter 23. Managing Auxiliary Storage Pools</b> | <b>433</b> |
| Working with ASP Trace and ASP Balance . . . . .    | 433        |
| Capacity Balance . . . . .                          | 434        |
| Hierarchical Storage Management (HSM)               |            |
| Balance . . . . .                                   | 434        |
| Usage Balance . . . . .                             | 435        |
| ASP Trace . . . . .                                 | 435        |
| Determining adequate disk storage . . . . .         | 436        |

---

## Chapter 18. Configuring Disks and Disk Protection

This chapter describes the procedures for using the character-based interface to configure and protect disks on your system. It includes checklists for performing the disk configuration tasks in the correct sequence. You can also configure disks through iSeries Navigator. For more information see **Systems management** → **Disk management** → **Disk pools** in the iSeries Information Center at <http://www.ibm.com/eserver/iseres/infocenter>.

You can use System Service Tools (SST) to do some disk configuration procedures while your system is active. For other procedures, you must stop your system and use Dedicated Service Tools (DST). This chapter provides information about both SST and DST.

---

### Choosing the Right Procedure for Configuring Disks

This chapter contains several checklists for performing configuration procedures. Use Table 62 to determine which checklist to use for your situation.

*Table 62. Choosing the Right Disk Procedure*

| Task Description                                                                                                                                                                                                                                    | Procedure to Follow       | Requires DST? |
|-----------------------------------------------------------------------------------------------------------------------------------------------------------------------------------------------------------------------------------------------------|---------------------------|---------------|
| Configure your system for the first time                                                                                                                                                                                                            | Checklist 1 on page 355.  | Yes           |
| <u>Add</u> one or more disk units that will not have device parity protection. This checklist applies to disk units that are capable of device parity protection if you <u>do not plan</u> to start device parity protection for the disks.         | Checklist 2 on page 356.  | No            |
| <u>Add</u> one or more disks to an existing Input/Output Adapter. Use this checklist if you plan to protect some or all of the new disks with device parity protection.                                                                             | Checklist 3 on page 358.  | No            |
| <u>Add</u> a new IOA. Use this checklist if you plan to protect some or all of the new disks with device parity protection.                                                                                                                         | Checklist 4 on page 359.  | Yes           |
| <u>Move</u> disk units between existing ASPs without mirrored protection.                                                                                                                                                                           | Checklist 5. on page 360. | Yes           |
| <u>Move</u> disk units between existing ASPs with mirrored protection.                                                                                                                                                                              | Checklist 6 on page 361.  | Yes           |
| <u>Delete</u> a user ASP.                                                                                                                                                                                                                           | Checklist 7 on page 362.  | Yes           |
| <u>Remove</u> one or more disk units without device parity protection.                                                                                                                                                                              | Checklist 8 on page 363.  | Yes           |
| <u>Remove</u> one or more disk units from an Input/Output Adapter (IOA). Use this checklist if device parity protection is started for some or all of the disk units that are attached to the IOA and they are in ASPs without mirrored protection. | Checklist 9 on page 364.  | Yes           |
| <u>Remove</u> one or more disk units from an IOA. Use this checklist if device parity protection is started for some or all of the disks units that are attached to the IOA and they are in ASPs with mirrored protection.                          | Checklist 10 on page 365. | Yes           |

### Configuring Disks on a New System—Checklist 1

This checklist shows the sequence of tasks that you use to configure disks on a new iSeries server. Whether you need to perform all the tasks depends on the disk protection that you want on your system.

The topic **Setting up disk protection for your data** in the iSeries Information Center provides more information about the disk protection that is available. You can access the Information Center from the iSeries Information Center CD-ROM or from the following Web site:

<http://www.ibm.com/eserver/iseries/infocenter>

**Before you begin**, make a copy of this checklist. Fill in the appropriate areas as you or the service representative perform the configuration tasks. This checklist provides an important record of your actions. It may help you diagnose any problems that occur.

**Attention:** When you perform the tasks in this checklist, the system moves large amounts of data. Make sure that you have saved your system completely in the event that you need to recover from an error situation.

Most tasks in the checklist include references to other topics in this book. Refer to these topics if you need more information about how to perform a particular task.

*Table 63. Configuring Disks on a New System—Tasks*

| Task        | What To Do                                                                                                                                                                                          | Where To Read More About It                                                                                   |
|-------------|-----------------------------------------------------------------------------------------------------------------------------------------------------------------------------------------------------|---------------------------------------------------------------------------------------------------------------|
| ___ Task 1  | Start DST.                                                                                                                                                                                          | "How to Start Dedicated Service Tools (DST)" on page 366.                                                     |
| ___ Task 2  | Display your disk configuration. Currently, all of your disk units except the load source unit appear as nonconfigured.                                                                             | "How to Display Your Disk Configuration" on page 368.                                                         |
| ___ Task 3  | If you plan to have device parity protection on any of your disk units, start it using the procedure for the types of disk units that you have.                                                     | "How to Start Device Parity Protection for an Input/Output Adapter" on page 397                               |
| ___ Task 4  | Add nonconfigured disk units to the correct ASPs.                                                                                                                                                   | "How to Add Disk Units to an Auxiliary Storage Pool" on page 375.                                             |
| ___ Task 5  | The default storage threshold for each ASP is 90%. If you want a different storage threshold for any ASP, change it.                                                                                | "How to Change the Storage Threshold for an Auxiliary Storage Pool" on page 377.                              |
| ___ Task 6  | Specify the storage threshold for the system ASP. If you use the QSTGLOWLMT and QSTGLOWACN system values, you can prevent the system ASP from filling to capacity and causing an abnormal shutdown. | "How to Change the Storage Threshold for the System Auxiliary Storage Pool" on page 378.                      |
| ___ Task 7  | If you plan to have mirrored protection for any ASPs, start it.                                                                                                                                     | "How to Start Mirrored Protection" on page 411.                                                               |
| ___ Task 8  | If you started mirrored protection, wait until the system completes the initial program load. Then sign on and start SST.                                                                           | "Starting System Service Tools (SST)" on page 368.                                                            |
| ___ Task 9  | Verify that your disk configuration is correct and print a copy for your records.                                                                                                                   | "How to Display Your Disk Configuration" on page 368.                                                         |
| ___ Task 10 | End DST or SST.                                                                                                                                                                                     | "How to Stop Dedicated Service Tools (DST)" on page 368 or "Stopping System Service Tools (SST)" on page 368. |

## Adding Disk Units without Device Parity Protection—Checklist 2

This checklist shows the sequence of tasks that you use to add one or more disks to your system when you do not plan to protect the new disks with device parity protection. You can use either DST or SST to perform the tasks in this checklist. If you use SST, you can perform the tasks while your system is active. If you use DST, you must stop your system to perform the tasks in this checklist.

### Adding to an ASP with Mirrored Protection?

You can add disk units to an ASP that has mirrored protection without stopping and starting mirrored protection. You must add disk units in pairs with equal capacities. The added units will always be paired with each other. You may want to choose a later time, when your system can be unavailable for several hours, to stop and start mirrored protection. When you start mirrored protection again, the system evaluates the pairing for all disk units on your system. This may provide a higher level of availability for failures that affect a controller, an IOA, or a bus.

**Before you begin**, make a copy of this checklist. Fill in the appropriate areas as you or the service representative perform the configuration tasks. This checklist provides an important record of your actions. It may help you diagnose any problems that occur.

**Attention:** When you perform the tasks in this checklist, the system moves large amounts of data. Make sure that you have saved your system completely in the event that you need to recover from an error situation.

Most tasks in the checklist include references to other topics in this book. Refer to these topics if you need more information about how to perform a particular task.

*Table 64. Adding Disk Units without Device Parity Protection—Tasks*

| Task         | What To Do                                                                                                                                                                                          | Where To Read More About It                                                                                    |
|--------------|-----------------------------------------------------------------------------------------------------------------------------------------------------------------------------------------------------|----------------------------------------------------------------------------------------------------------------|
| ___ Task 1   | Physically attach disk units.                                                                                                                                                                       |                                                                                                                |
| ___ Task 2   | Start DST or SST                                                                                                                                                                                    | “How to Start Dedicated Service Tools (DST)” on page 366 or “Starting System Service Tools (SST)” on page 368. |
| ___ Task 3   | Print your current disk configuration.                                                                                                                                                              | “How to Display Your Disk Configuration” on page 368.                                                          |
| ___ Task 4   | Add nonconfigured disk units to the correct ASPs. See note 1 and note 2.                                                                                                                            | “How to Add Disk Units to an Auxiliary Storage Pool” on page 375.                                              |
| ___ Task 5   | If you created a new ASP on your system when you added disk units, the system set the storage threshold of the ASP to 90%. If you want a different threshold, change it.                            | “How to Change the Storage Threshold for an Auxiliary Storage Pool” on page 377.                               |
| ___ Task 6   | Specify the storage threshold for the system ASP. If you use the QSTGLOWLMT and QSTGLOWACN system values, you can prevent the system ASP from filling to capacity and causing an abnormal shutdown. | “How to Change the Storage Threshold for the System Auxiliary Storage Pool” on page 378.                       |
| ___ Task 7   | Verify that your disk configuration is correct and print a copy for your records.                                                                                                                   | “How to Display Your Disk Configuration” on page 368.                                                          |
| ___ Task 8   | End DST or SST.                                                                                                                                                                                     | “How to Stop Dedicated Service Tools (DST)” on page 368 or “Stopping System Service Tools (SST)” on page 368.  |
| <sup>1</sup> | You can add the disk units to an existing ASP or you can add them to a new ASP.                                                                                                                     |                                                                                                                |
| <sup>2</sup> | If you are adding disk units to an ASP that has mirrored protection and the new disk units do not have device parity protection, you must add pairs of disk units that have identical capacities.   |                                                                                                                |

## Adding Disk Units to an Existing Input/Output Adapter—Checklist 3

This checklist shows the sequence of tasks that you use to add one or more disks to an existing input/output adapter. Use this checklist if you plan to protect some or all of the new disk units with device parity protection. If you do not plan to protect any of the new disk units, use checklist 2.

You can use this procedure whether or not you have mirrored protection on your system because you start device parity protection before you add the disk units to an ASP. You can use either DST or SST to perform the tasks in this checklist. If you use SST, you can perform the tasks while your system is active. If you use DST, you must stop your system to perform the tasks in this checklist.

**Before you begin**, make a copy of this checklist. Fill in the appropriate areas as you or the service representative perform the configuration tasks. This checklist provides an important record of your actions. It may help you diagnose any problems that occur.

**Attention:** When you perform the tasks in this checklist, the system moves large amounts of data. Make sure that you have saved your system completely in the event that you need to recover from an error situation.

Most tasks in the checklist include references to other topics in this book. Refer to these topics if you need more information about how to perform a particular task.

*Table 65. Adding Disk Units to an Existing Input/Output Adapter—Tasks*

| Task         | What To Do                                                                                                                                                                                          | Where To Read More About It                                                                                    |
|--------------|-----------------------------------------------------------------------------------------------------------------------------------------------------------------------------------------------------|----------------------------------------------------------------------------------------------------------------|
| ___ Task 1   | Physically attach disk units. This is normally done by a service representative.                                                                                                                    |                                                                                                                |
| ___ Task 2   | Start DST or SST                                                                                                                                                                                    | “How to Start Dedicated Service Tools (DST)” on page 366 or “Starting System Service Tools (SST)” on page 368. |
| ___ Task 3   | Print your current disk configuration.                                                                                                                                                              | “How to Display Your Disk Configuration” on page 368.                                                          |
| ___ Task 4   | Include the disk units that you want to protect in device parity protection.                                                                                                                        | “How to include a disk unit in device parity protection” on page 406.                                          |
| ___ Task 5   | Add nonconfigured disk units to the correct ASPs. See note 1 and note 2.                                                                                                                            | “How to Add Disk Units to an Auxiliary Storage Pool” on page 375.                                              |
| ___ Task 6   | If you created a new ASP on your system when you added disk units, the system set the storage threshold of the ASP to 90%. If you want a different threshold, change it.                            | “How to Change the Storage Threshold for an Auxiliary Storage Pool” on page 377.                               |
| ___ Task 7   | Specify the storage threshold for the system ASP. If you use the QSTGLOWLMT and QSTGLOWACN system values, you can prevent the system ASP from filling to capacity and causing an abnormal shutdown. | “How to Change the Storage Threshold for the System Auxiliary Storage Pool” on page 378.                       |
| ___ Task 8   | Verify that your disk configuration is correct and print a copy for your records.                                                                                                                   | “How to Display Your Disk Configuration” on page 368.                                                          |
| ___ Task 9   | End DST or SST.                                                                                                                                                                                     | “How to Stop Dedicated Service Tools (DST)” on page 368 or “Stopping System Service Tools (SST)” on page 368.  |
| <sup>1</sup> | You can add the disk units to an existing ASP or you can add them to a new ASP.                                                                                                                     |                                                                                                                |
| <sup>2</sup> | If you are adding disk units to an ASP that has mirrored protection and the new disk units do not have device parity protection, you must add pairs of disk units that have identical capacities.   |                                                                                                                |



## Adding a New Input/Output Adapter–Checklist 4

This checklist shows the sequence of tasks that you use to add a new input/output adapter (IOA) and disk units to your system. Use this checklist if you plan to protect some or all of the new disks with device parity protection.

You can use this procedure whether or not you have mirrored protection on your system because you start device parity protection before you add the disk units to an ASP. If you do have mirrored protection and you are adding disks that do not have device parity protection, you must add them in pairs that have equal capacities. You can use either DST or SST to perform the tasks in this checklist. If you use SST, you can perform the tasks while your system is active. If you use DST, you must stop your system to perform the tasks in this checklist.

**Note:** If you do not plan to start device parity protection for any of the new disks, use the procedure in checklist 2 to add them.

**Before you begin,** make a copy of this checklist. Fill in the appropriate areas as you or the service representative perform the configuration tasks. This checklist provides an important record of your actions. It may help you diagnose any problems that occur.

**Attention:** When you perform the tasks in this checklist, the system moves large amounts of data. Make sure that you have saved your system completely in the event that you need to recover from an error situation.

Most tasks in the checklist include references to other topics in this book. Refer to these topics if you need more information about how to perform a particular task.

*Table 66. Adding a New input/output adapter–Tasks*

| Task       | What To Do                                                                                                                                                                                          | Where To Read More About It                                                      |
|------------|-----------------------------------------------------------------------------------------------------------------------------------------------------------------------------------------------------|----------------------------------------------------------------------------------|
| ___ Task 1 | Install the new input/output adapter in the system. This is normally done by a service representative.                                                                                              |                                                                                  |
| ___ Task 2 | Physically attach disk units to the new IOA. This is normally done by a service representative.                                                                                                     |                                                                                  |
| ___ Task 3 | Start DST.                                                                                                                                                                                          | “How to Start Dedicated Service Tools (DST)” on page 366.                        |
| ___ Task 4 | Print your current disk configuration.                                                                                                                                                              | “How to Display Your Disk Configuration” on page 368.                            |
| ___ Task 5 | Start device parity protection for the IOA.                                                                                                                                                         | “How to Start Device Parity Protection for an Input/Output Adapter” on page 397. |
| ___ Task 6 | Add nonconfigured disk units to the correct ASPs.                                                                                                                                                   | “How to Add Disk Units to an Auxiliary Storage Pool” on page 375.                |
| ___ Task 7 | If you created a new ASP on your system when you added disk units, the system set the storage threshold of the ASP to 90%. If you want a different threshold, change it.                            | “How to Change the Storage Threshold for an Auxiliary Storage Pool” on page 377. |
| ___ Task 8 | Specify the storage threshold for the system ASP. If you use the QSTGLOWLMT and QSTGLOWACN system values, you can prevent the system ASP from filling to capacity and causing an abnormal shutdown. | “How to Display Your Disk Configuration” on page 368.                            |
| ___ Task 9 | Verify that your disk configuration is correct and print a copy for your records.                                                                                                                   | “How to Display Your Disk Configuration” on page 368.                            |

Table 66. Adding a New input/output adapter—Tasks (continued)

| Task                                                                                                                                                                                                 | What To Do | Where To Read More About It                              |
|------------------------------------------------------------------------------------------------------------------------------------------------------------------------------------------------------|------------|----------------------------------------------------------|
| ___ Task 10                                                                                                                                                                                          | End DST.   | “How to Stop Dedicated Service Tools (DST)” on page 368. |
| <b>Notes:</b>                                                                                                                                                                                        |            |                                                          |
| 1. You can add the disk units to an existing ASP or you can add them to a new ASP.                                                                                                                   |            |                                                          |
| 2. If you are adding disk units to an ASP that has mirrored protection and the new disk units do not have device parity protection, you must add pairs of disk units that have identical capacities. |            |                                                          |

## Moving Disk Units Between Non-Mirrored Auxiliary Storage Pools—Checklist 5

This checklist shows the sequence of tasks that you use to move one or more disk units from one ASP to another ASP. Use these tasks when you do not have mirrored protection active for the ASPs. You must stop your system and use DST to perform the tasks in this checklist.

**Note:** You cannot move disk units to or from an independent ASP.

**Before you begin,** make a copy of this checklist. Fill in the appropriate areas as you or the service representative perform the configuration tasks. This checklist provides an important record of your actions. It may help you diagnose any problems that occur.

**Attention:** When you perform the tasks in this checklist, the system moves large amounts of data. Make sure that you have saved your system completely in the event that you need to recover from an error situation.

Most tasks in the checklist include references to other topics in this book. Refer to these topics if you need more information about how to perform a particular task.

Table 67. Moving Disk Units Between ASPs—Tasks

| Task       | What To Do                                                                                                                                                                                          | Where To Read More About It                                                              |
|------------|-----------------------------------------------------------------------------------------------------------------------------------------------------------------------------------------------------|------------------------------------------------------------------------------------------|
| ___ Task 1 | Print your current disk configuration.                                                                                                                                                              | “How to Display Your Disk Configuration” on page 368.                                    |
| ___ Task 2 | Calculate the space requirements for both the source and target ASPs for the disk units.                                                                                                            | “Calculating Space Requirements for an Auxiliary Storage Pool” on page 385.              |
| ___ Task 3 | Use option 21 from the Save menu to save your entire system.                                                                                                                                        |                                                                                          |
| ___ Task 4 | Start DST.                                                                                                                                                                                          | “How to Start Dedicated Service Tools (DST)” on page 366.                                |
| ___ Task 5 | Move the disk units.                                                                                                                                                                                | “How to Move a Disk Unit to a Different Auxiliary Storage Pool” on page 380.             |
| ___ Task 6 | If you created a new ASP on your system when you moved disk units, the system set the storage threshold for the ASP to 90%. If you want a different threshold, change it.                           | “How to Change the Storage Threshold for an Auxiliary Storage Pool” on page 377.         |
| ___ Task 7 | Specify the storage threshold for the system ASP. If you use the QSTGLOWLMT and QSTGLOWACN system values, you can prevent the system ASP from filling to capacity and causing an abnormal shutdown. | “How to Change the Storage Threshold for the System Auxiliary Storage Pool” on page 378. |
| ___ Task 8 | Verify that your disk configuration is correct and print a copy for your records.                                                                                                                   | “How to Display Your Disk Configuration” on page 368.                                    |

Table 67. Moving Disk Units Between ASPs–Tasks (continued)

| Task        | What To Do                               | Where To Read More About It                                         |
|-------------|------------------------------------------|---------------------------------------------------------------------|
| ___ Task 9  | End DST.                                 | “How to Stop Dedicated Service Tools (DST)” on page 368.            |
| ___ Task 10 | If necessary, move objects between ASPs. | “Transferring Objects between Auxiliary Storage Pools” on page 386. |

## Moving Disk Units Between Mirrored Auxiliary Storage Pools–Checklist 6

This checklist shows the sequence of tasks that you use to move one or more disk units from one ASP to another ASP. Use these tasks when one or more of the ASPs involved in the move has mirrored protection. You cannot use the move unit procedure when mirrored protection is active. Instead, you remove mirrored pairs from the source ASP and add them to the target ASP. You must stop your system and use DST to perform the tasks in this checklist.

**Note:** You cannot move disk units to or from an independent ASP.

**Before you begin,** make a copy of this checklist. Fill in the appropriate areas as you or the service representative perform the configuration tasks. This checklist provides an important record of your actions. It may help you diagnose any problems that occur.

**Attention:** When you perform the tasks in this checklist, the system moves large amounts of data. Make sure that you have saved your system completely in the event that you need to recover from an error situation.

Most tasks in the checklist include references to other topics in this book. Refer to these topics if you need more information about how to perform a particular task.

Table 68. Moving Disk Units Between ASPs with mirrored protection–Tasks

| Task       | What To Do                                                                                                                                                                                          | Where To Read More About It                                                              |
|------------|-----------------------------------------------------------------------------------------------------------------------------------------------------------------------------------------------------|------------------------------------------------------------------------------------------|
| ___ Task 1 | Print your current disk configuration.                                                                                                                                                              | “How to Display Your Disk Configuration” on page 368.                                    |
| ___ Task 2 | Calculate the space requirements for the ASPs that are involved in moving disk units.                                                                                                               | “Calculating Space Requirements for an Auxiliary Storage Pool” on page 385.              |
| ___ Task 3 | Use option 21 from the Save menu to save your entire system.                                                                                                                                        |                                                                                          |
| ___ Task 4 | Start DST.                                                                                                                                                                                          | “How to Start Dedicated Service Tools (DST)” on page 366.                                |
| ___ Task 5 | Remove disk units that you plan to add to a different ASP.                                                                                                                                          | “How to Remove a Disk Unit from an Auxiliary Storage Pool” on page 382.                  |
| ___ Task 6 | Add nonconfigured disk units to the correct ASPs. See note 1.                                                                                                                                       |                                                                                          |
| ___ Task 7 | If you created a new ASP on your system when you added disk units, the system set the storage threshold of the ASP to 90%. If you want a different threshold, change it.                            | “How to Change the Storage Threshold for an Auxiliary Storage Pool” on page 377.         |
| ___ Task 8 | Specify the storage threshold for the system ASP. If you use the QSTGLOWLMT and QSTGLOWACN system values, you can prevent the system ASP from filling to capacity and causing an abnormal shutdown. | “How to Change the Storage Threshold for the System Auxiliary Storage Pool” on page 378. |

Table 68. Moving Disk Units Between ASPs with mirrored protection—Tasks (continued)

| Task         | What To Do                                                                                                                                                                                        | Where To Read More About It                                         |
|--------------|---------------------------------------------------------------------------------------------------------------------------------------------------------------------------------------------------|---------------------------------------------------------------------|
| ___ Task 9   | If you created any new ASPs and you want those ASPs to have mirrored protection, start mirrored protection now.                                                                                   | “How to Start Mirrored Protection” on page 411.                     |
| ___ Task 10  | Verify that your disk configuration is correct and print a copy for your records.                                                                                                                 | “How to Display Your Disk Configuration” on page 368.               |
| ___ Task 11  | End DST.                                                                                                                                                                                          | “How to Stop Dedicated Service Tools (DST)” on page 368.            |
| ___ Task 12  | If necessary, move objects between ASPs.                                                                                                                                                          | “Transferring Objects between Auxiliary Storage Pools” on page 386. |
| <sup>1</sup> | If you are adding disk units to an ASP that has mirrored protection and the new disk units do not have device parity protection, you must add pairs of disk units that have identical capacities. |                                                                     |

## Deleting an Auxiliary Storage Pool—Checklist 7

This checklist shows the sequence of tasks that you use to delete a user ASP. You must stop your system and use DST to perform the tasks in this checklist.

**Before you begin**, make a copy of this checklist. Fill in the appropriate areas as you or the service representative perform the configuration tasks. This checklist provides an important record of your actions. It may help you diagnose any problems that occur.

**Attention:** When you perform the tasks in this checklist, the system moves large amounts of data. Make sure that you have saved your system completely in the event that you need to recover from an error situation. Also note that when an ASP is deleted, all data remaining in that ASP is lost.

Most tasks in the checklist include references to other topics in this book. Refer to these topics if you need more information about how to perform a particular task.

Table 69. Deleting an Auxiliary Storage Pool—Tasks

| Task       | What To Do                                                                                                                                                               | Where To Read More About It                                                      |
|------------|--------------------------------------------------------------------------------------------------------------------------------------------------------------------------|----------------------------------------------------------------------------------|
| ___ Task 1 | Print your current disk configuration.                                                                                                                                   | “How to Display Your Disk Configuration” on page 368.                            |
| ___ Task 2 | Calculate the space requirements for the remaining ASPs.                                                                                                                 | “Calculating Space Requirements for an Auxiliary Storage Pool” on page 385.      |
| ___ Task 3 | Use option 21 from the Save menu to save your entire system.                                                                                                             |                                                                                  |
| ___ Task 4 | Remove objects from the ASP that you are deleting or move the objects to a different ASP.                                                                                | “Transferring Objects between Auxiliary Storage Pools” on page 386.              |
| ___ Task 5 | Start DST.                                                                                                                                                               | “How to Start Dedicated Service Tools (DST)” on page 366.                        |
| ___ Task 6 | Delete the ASP. This procedure places all of the disks that were assigned to the deleted ASP in nonconfigured status.                                                    | “How to Delete an Auxiliary Storage Pool” on page 384.                           |
| ___ Task 7 | Add nonconfigured disk units to the correct ASPs. See note 1.                                                                                                            | “How to Add Disk Units to an Auxiliary Storage Pool” on page 375.                |
| ___ Task 8 | If you created a new ASP on your system when you added disk units, the system set the storage threshold of the ASP to 90%. If you want a different threshold, change it. | “How to Change the Storage Threshold for an Auxiliary Storage Pool” on page 377. |

Table 69. Deleting an Auxiliary Storage Pool—Tasks (continued)

| Task         | What To Do                                                                                                                                                                                          | Where To Read More About It                                                              |
|--------------|-----------------------------------------------------------------------------------------------------------------------------------------------------------------------------------------------------|------------------------------------------------------------------------------------------|
| ___ Task 9   | Specify the storage threshold for the system ASP. If you use the QSTGLOWLMT and QSTGLOWACN system values, you can prevent the system ASP from filling to capacity and causing an abnormal shutdown. | “How to Change the Storage Threshold for the System Auxiliary Storage Pool” on page 378. |
| ___ Task 10  | Verify that your disk configuration is correct and print a copy for your records.                                                                                                                   | “How to Display Your Disk Configuration” on page 368.                                    |
| ___ Task 11  | End DST.                                                                                                                                                                                            | “How to Stop Dedicated Service Tools (DST)” on page 368.                                 |
| ___ Task 12  | If necessary, move objects between ASPs.                                                                                                                                                            | “Transferring Objects between Auxiliary Storage Pools” on page 386.                      |
| <sup>1</sup> | If you are adding disk units to an ASP that has mirrored protection and the new disk units do not have device parity protection, you must add pairs of disk units that have identical capacities.   |                                                                                          |

## Removing Disk Units Without Device Parity Protection—Checklist 8

This checklist shows the sequence of tasks that you use to remove one or more disk units from your system when the disk units do not have device parity protection. Use these tasks when you are permanently removing disk units from your system. Do not use these tasks when you are repairing or replacing a failed disk unit. You must stop your system and use DST to perform the tasks in this checklist.

**Before you begin**, make a copy of this checklist. Fill in the appropriate areas as you or the service representative perform the configuration tasks. This checklist provides an important record of your actions. It may help you diagnose any problems that occur.

**Attention:** When you perform the tasks in this checklist, the system moves large amounts of data. Make sure that you have saved your system completely in the event that you need to recover from an error situation.

Most tasks in the checklist include references to other topics in this book. Refer to these topics if you need more information about how to perform a particular task.

Table 70. Removing Disk Units That Do Not Have Device Parity Protection—Tasks

| Task       | What To Do                                                                              | Where To Read More About It                                                 |
|------------|-----------------------------------------------------------------------------------------|-----------------------------------------------------------------------------|
| ___ Task 1 | Print your current disk configuration.                                                  | “How to Display Your Disk Configuration” on page 368.                       |
| ___ Task 2 | Calculate the space requirements for the ASPs that are involved in removing disk units. | “Calculating Space Requirements for an Auxiliary Storage Pool” on page 385. |
| ___ Task 3 | Use option 21 from the Save menu to save your entire system.                            |                                                                             |
| ___ Task 4 | Start DST.                                                                              | “How to Start Dedicated Service Tools (DST)” on page 366.                   |
| ___ Task 5 | Remove disk units that you plan to remove from the system.                              | “How to Remove a Disk Unit from an Auxiliary Storage Pool” on page 382.     |
| ___ Task 6 | Verify that your disk configuration is correct and print a copy for your records.       | “How to Display Your Disk Configuration” on page 368.                       |
| ___ Task 7 | End DST.                                                                                | “How to Stop Dedicated Service Tools (DST)” on page 368.                    |

**Note:** This checklist works only if at least one unit remains in the ASP and there is enough capacity remaining.

## Removing Disk Units That Have Device Parity Protection from an ASP Without Mirrored Protection—Checklist 9

This checklist shows the sequence of tasks that you use to remove one or more disk units from an Input/Output Adapter. These tasks apply when the ASPs containing the disk units do not have mirrored protection and when device parity protection is started for the IOA. Use these tasks when you are permanently removing disk units from your system. Do not use these tasks when you are repairing or replacing a failed hard disk. You must stop your system and use DST to perform the tasks in this checklist.

**Before you begin,** make a copy of this checklist. Fill in the appropriate areas as you or the service representative perform the configuration tasks. This checklist provides an important record of your actions. It may help you diagnose any problems that occur.

**Attention:** When you perform the tasks in this checklist, the system moves large amounts of data. Make sure that you have saved your system completely in the event that you need to recover from an error situation.

Most tasks in the checklist include references to other topics in this book. Refer to these topics if you need more information about how to perform a particular task.

*Table 71. Removing Disk Units from an IOA and a Non-Mirrored ASP—Tasks*

| Task       | What To Do                                                                                                                                                 | Where To Read More About It                                                    |
|------------|------------------------------------------------------------------------------------------------------------------------------------------------------------|--------------------------------------------------------------------------------|
| ___ Task 1 | Print your current disk configuration.                                                                                                                     | “How to Display Your Disk Configuration” on page 368.                          |
| ___ Task 2 | Calculate the space requirements for the ASPs that are involved in removing disk units.                                                                    | “Calculating Space Requirements for an Auxiliary Storage Pool” on page 385.    |
| ___ Task 3 | Use option 21 from the Save menu to save your entire system.                                                                                               |                                                                                |
| ___ Task 4 | Start DST.                                                                                                                                                 | “How to Start Dedicated Service Tools (DST)” on page 366.                      |
| ___ Task 5 | Remove disk units that you plan to remove from the system.                                                                                                 | “How to Remove a Disk Unit from an Auxiliary Storage Pool” on page 382.        |
| ___ Task 6 | Exclude the disk units from device parity protection. If you were successful in excluding the disk units, skip to task 8. Otherwise, continue with task 7. | “How to Exclude a Disk Unit from Device Parity Protection” on page 407.        |
| ___ Task 7 | Stop device parity protection for the IOA.                                                                                                                 | “How to Stop Device Parity Protection on an Input/Output Adapter” on page 399. |

Table 71. Removing Disk Units from an IOA and a Non-Mirrored ASP—Tasks (continued)

| Task        | What To Do                                                                        | Where To Read More About It                                                                                                                                                                                                                                                                                                                                                  |
|-------------|-----------------------------------------------------------------------------------|------------------------------------------------------------------------------------------------------------------------------------------------------------------------------------------------------------------------------------------------------------------------------------------------------------------------------------------------------------------------------|
| ___ Task 8  | Physically remove disk units.                                                     | <p>“How to Remove Disk Units that have Device Parity Protection for an iSeries™ server with the system powered on” on page 400.</p> <p>“How to remove disk units that have device parity protection for an iSeries™ server with the system powered off” on page 402</p> <p>“How to remove disk units that have device parity protection for an eServer™ i5” on page 405.</p> |
| ___ Task 9  | Start device parity protection for the IOA.                                       | “How to Start Device Parity Protection for an Input/Output Adapter” on page 397.                                                                                                                                                                                                                                                                                             |
| ___ Task 10 | Verify that your disk configuration is correct and print a copy for your records. | “How to Display Your Disk Configuration” on page 368.                                                                                                                                                                                                                                                                                                                        |
| ___ Task 11 | End DST.                                                                          | “How to Stop Dedicated Service Tools (DST)” on page 368.                                                                                                                                                                                                                                                                                                                     |

## Removing Disk Units That Have Device Parity Protection from an ASP With Mirrored Protection—Checklist 10

This checklist shows the sequence of tasks that you use to remove one or more disk units from an input/output adapter. These tasks apply when the ASPs that contain the disk units have mirrored protection and when the disk units have device parity protection. Use these tasks when you are permanently removing disk units from your system. Do not use these tasks when you are repairing or replacing a failed disk unit. You must stop your system and use DST to perform the tasks in this checklist.

**Before you begin**, make a copy of this checklist. Fill in the appropriate areas as you or the service representative perform the configuration tasks. This checklist provides an important record of your actions. It may help you diagnose any problems that occur.

**Attention:** When you perform the tasks in this checklist, the system moves large amounts of data. Make sure that you have saved your system completely in the event that you need to recover from an error situation.

Most tasks in the checklist include references to other topics in this book. Refer to these topics if you need more information about how to perform a particular task.

Table 72. Removing Disk Units from an IOA and a Mirrored ASP—Tasks

| Task       | What To Do                                                                              | Where To Read More About It                                                 |
|------------|-----------------------------------------------------------------------------------------|-----------------------------------------------------------------------------|
| ___ Task 1 | Print your current disk configuration.                                                  | “How to Display Your Disk Configuration” on page 368.                       |
| ___ Task 2 | Calculate the space requirements for the ASPs that are involved in removing disk units. | “Calculating Space Requirements for an Auxiliary Storage Pool” on page 385. |
| ___ Task 3 | Use option 21 from the Save menu to save your entire system.                            |                                                                             |
| ___ Task 4 | Start DST.                                                                              | “How to Start Dedicated Service Tools (DST)” on page 366.                   |

Table 72. Removing Disk Units from an IOA and a Mirrored ASP—Tasks (continued)

| Task         | What To Do                                                                                                                                                                                                                          | Where To Read More About It                                                      |
|--------------|-------------------------------------------------------------------------------------------------------------------------------------------------------------------------------------------------------------------------------------|----------------------------------------------------------------------------------|
| ___ Task 5   | Remove disk units that you plan to remove from the system.                                                                                                                                                                          | “How to Remove a Disk Unit from an Auxiliary Storage Pool” on page 382.          |
| ___ Task 6   | Exclude the disk units from device parity protection. If you were successful in excluding the disk units, skip to task 9. Otherwise, continue with task 7.                                                                          | “How to Exclude a Disk Unit from Device Parity Protection” on page 407.          |
| ___ Task 7   | Stop mirrored protection for the ASPs that will have disk units removed. When you stop mirrored protection, one disk unit from each mirrored pair becomes nonconfigured. See note 1.                                                | “How to Stop Mirrored Protection” on page 414.                                   |
| ___ Task 8   | Stop device parity protection for the IOA.                                                                                                                                                                                          | “How to Stop Device Parity Protection on an Input/Output Adapter” on page 399.   |
| ___ Task 9   | Physically remove disk units. This is normally done by a service representative. If you stopped device parity protection in task 8, then continue with task 10. If you did not stop device parity protection, then skip to task 14. |                                                                                  |
| ___ Task 10  | Start device parity protection for the IOA.                                                                                                                                                                                         | “How to Start Device Parity Protection for an Input/Output Adapter” on page 397. |
| ___ Task 11  | Add nonconfigured disk units to the correct ASPs. These disks became nonconfigured when you stopped mirrored protection in task 7.                                                                                                  | “How to Add Disk Units to an Auxiliary Storage Pool” on page 375.                |
| ___ Task 12  | If you created a new ASP on your system when you added disk units, the system set the storage threshold of the ASP to 90%. If you want a different threshold, change it.                                                            | “How to Change the Storage Threshold for an Auxiliary Storage Pool” on page 377. |
| ___ Task 13  | Start mirrored protection for the ASPs that had mirrored protection stopped in task 7.                                                                                                                                              | “How to Start Mirrored Protection” on page 411.                                  |
| ___ Task 14  | Verify that your disk configuration is correct and print a copy for your records.                                                                                                                                                   | “How to Display Your Disk Configuration” on page 368.                            |
| ___ Task 15  | End DST.                                                                                                                                                                                                                            | “How to Stop Dedicated Service Tools (DST)” on page 368.                         |
| <sup>1</sup> | You need to stop mirrored protection only if the ASP contains other disk units that are attached to the IOA and have device parity protection.                                                                                      |                                                                                  |

## Using System Service Tools and Dedicated Service Tools

Several backup and recovery procedures, including disk storage management, require the use of Dedicated Service Tools (DST) or System Service Tools (SST). This topic describes how to start and end SST and DST. It also provides a list of the options available through these tools.

### How to Start Dedicated Service Tools (DST)

Use this procedure to start DST. If the IPL or Install the System menu is already displayed, start with step 5 on page 367.

1. Ensure that the keystick is in the system unit control panel.
2. Place the system in manual mode.
3. Power down the system:



```
PWRDWN SYS OPTION(*CNTRL D) DELAY(600)
RESTART(*YES) IPLSRC(B)
```

**Attention logical partitioning users!**

If you are going to use this command on the primary partition, be sure to power off all secondary partitions before running the command.

**Note:** If you are sure that no jobs are running on your system, you can specify `OPTION(*IMMED)` when you power down the system. Otherwise, specify a delay time that is sufficient to allow jobs to end normally.

4. When the IPL completes, the IPL or Install the System menu appears.

```
                IPL or Install the System
Select one of the following:
  1. Perform an IPL
  2. Install the operating system
  3. Use Dedicated Service Tools (DST)
  4. Perform automatic installation of the operating system
  5. Save Licensed Internal Code
```

5. Select option 3 (Use Dedicated Service Tools (DST)) and press the Enter key. The Dedicated Service Tools (DST) Sign On display is shown.

```
                Dedicated Service Tools (DST) Sign On
Type choice, press Enter.
Service tools user . . . . . _____
Service tools password . . . . . _____
```

6. In the *Service tools user* field, type QSECOFR. In the *Service tools password* field, type your service tools password. On a new system, the password is QSECOFR. The password is case sensitive; use all capital letters. The service tools profile QSECOFR password is expired after the first use. At the Change Service Tools User Password screen, enter in all uppercase letters the current password QSECOFR and a new password, along with the verification password. Record the new password for future reference. You can find more information about service tools user IDs and passwords in the iSeries Information Center, <http://www.ibm.com/eserver/series/infocenter>. See **Security** → **Service tools user IDs and passwords**.

The Use Dedicated Service Tools (DST) menu is shown.

```
                Use Dedicated Service Tools (DST)
Select one of the following:
  1. Perform an IPL
  2. Install the operating system
  3. Work with licensed internal code
  4. Work with disk units
  5. Work with DST environment
  6. Select DST console mode
  7. Start a service tool
  8. Perform automatic installation of the operating system
  9. Work with save storage and restore storage
 10. Work with remote DST support
```

## How to Stop Dedicated Service Tools (DST)

Use this procedure to end DST:

1. If you do not want to see the displays for a manual initial program load (IPL), return the system to automatic mode. If you want to see the displays, leave the system in manual mode.
2. Press F3 until you return to the Use Dedicated Service Tools (DST) menu.
3. From the Use Dedicated Service Tools (DST) menu, select option 1 (Perform an IPL).

**Note:** Do **not** perform an IPL if you are performing a complete system recovery.

The system may take significantly longer than normal to complete the IPL. Some functions that you perform by using DST, such as starting mirrored protection, require the system to do additional work during the IPL before the system is available for your use.

## Starting System Service Tools (SST)

You can access system service tools doing the following:

1. Use the Start System Service Tools (STRSST) command or by selecting the option for problem handling from the iSeries Main menu. From the Problem Handling menu, select the option for system service tools.
2. At the Start Service Tools (STRSST) Sign On display, enter your service tools user profile and password. For more information about about Service tools user profiles, see *Tips and Tools for Securing Your iSeries*.
3. Press Enter.
4. The System Service Tools (SST) menu appears:

```
System Service Tools (SST)
Select one of the following:
  1. Start a service tool
  2. Work with active service tools
  3. Work with disk units
  4. Work with diskette data recovery
  5. Work with system partitions
```

## Stopping System Service Tools (SST)

To end system service tools, do the following:

1. Press F3 (Exit) until you return to the System Service Tools (SST) menu.
2. Press F3 (Exit) again. You are shown the Exit System Service Tools display.
3. Press the Enter key to end SST.

## How to Display Your Disk Configuration

This topic describes how to display or print your current disk configuration. It also explains some of the fields that appear on the display or listing. For some purposes, such as planning a mirrored configuration, you need to view your disk configuration both from a hardware perspective and from a software perspective. The hardware perspective shows how the disk units are attached by bus, IOA, and controller. The software perspective shows how disk units are assigned to ASPs and how they are protected.

You can use DST, SST, or commands to display your disk configuration. When you are planning changes to your disk configuration, use SST and commands to print your current configuration before you begin to make changes. After you have made changes, you can use DST to verify the new configuration before you end DST.

## Displaying Your Disk Configuration—Hardware View

When you display your hardware disk configuration, you see all disk-related components that are physically attached to your system. This includes disk units whose software status is nonconfigured because they are not assigned to an ASP yet.

This topic describes both the DST method and the command method for displaying your disk hardware configuration.

**Displaying Disk Hardware Configuration—Command Method:** To display the hardware configuration of disk units on your system, do the following:

1. On a command line, type `WRKHDWRSC TYPE(*STG)` and press the Enter key. The Work with Storage Resources display appears. The display shows buses, IOPs, and controllers.

```

Work with Storage Resources
System: RCHASDP4
Type options, press Enter.
9=Work with resource

Opt Resource      Status      Text
CMB01             Operational Combined function IOP
DC01              Operational Disk Storage Controller
DC02              Operational Disk Storage Controller
DC05              Operational Tape Controller
  
```

2. If you want to see the detail about disk units that are attached to a controller, type 9 (Work with resource) in the *Option* column for the controller.

To print the hardware configuration of disk units on your system, do the following:

1. On a command line, type `DSPHDWRSC TYPE(*STG) OUTPUT(*PRINT)` and press the Enter key. Figure 34 shows part of the listing that you receive:

```

Display Spooled File
File . . . . . : QSYSVRT      Page/Line  1/1
Control . . . . : +15          Columns    1 - 78
Find . . . . .
*...+...1...+...2...+...3...+...4...+...5...+...6...+...7...+...
Display Hardware Resources
5716SS1 V3R6M0 950602

Storage Resources List
-----
Resource      Type-Model  Serial      Part      Frame
CMB01         9162-001   10-00000   0000086G7917 1
DC01          6602-030   00-0193825 1
DD001         6602-030   00-0193825 1
DC02          6602-030   00-17900   1
DD002         6602-030   00-17900   1
  
```

Figure 34. Display Hardware Resource Listing

**Displaying Disk Hardware Configuration—DST Method:** When you are using DST, you can use the following method to display your disk hardware configuration:

1. If you are not already using DST, perform a manual IPL to start DST. See “How to Start Dedicated Service Tools (DST)” on page 366.
2. From the Use Dedicated Service Tools (DST) menu, do the following:

- a. Select option 7 (Start a service tool).
- b. Select option 4 (Hardware service manager) on the Start a Service Tool display.
3. To print the hardware disk configuration, press F6 (Print configuration). If your system already has a printer defined for DST, the output is sent to that printer. If you do not have a DST printer defined, you are prompted with a list of attached printers. When you are using DST, output goes directly to the printer because spooling is not active.
4. To display the configuration, select option 2 (Logical hardware resources) from the Hardware Service Manager menu. From this display, you can select to show system bus, processor, or main storage resources.
5. To see additional detail, type 5 (Display detail) in the *Option* column next to each controller and press the Enter key.
6. If you have no other tasks to perform, end DST. (See “How to Stop Dedicated Service Tools (DST)” on page 368.)

### Displaying Your Disk Configuration—Software View

When you display your software disk configuration, you see how disk units are assigned to ASPs and how they are protected. A separate display shows disk units that are attached to the system but have not been assigned to an ASP (nonconfigured status).

To display the software configuration of disk units on your system, do the following:

1. If you are not already using DST, perform a manual IPL to start DST. See “How to Start Dedicated Service Tools (DST)” on page 366.
2. From the Use Dedicated Service Tools (DST) menu, do the following:
  - a. Select option 4 (Work with disk units).
  - b. Select option 1 (Work with disk configuration) on the Work with Disk Units display.
  - c. Select option 1 (Display disk configuration) on the Work with Disk Configuration display.
  - d. Select option 1 (Display disk configuration status) on the Display Disk Configuration display.
 or from the System Service Tools (SST) menu, do the following:
  - a. Select option 3 (Work with disk units).
  - b. Select option 1 (Display disk configuration) on the Work with Disk Units display.

The Display Disk Configuration menu appears.

Display Disk Configuration

Select one of the following:

1. Display disk configuration status
2. Display disk configuration capacity
3. Display disk configuration protection
4. Display non-configured units
5. Display device parity status
6. Display disk hardware status

3. Select option 1 to see the Display Disk Configuration Status display:

| Display Disk Configuration Status |      |               |      |       |               |             |
|-----------------------------------|------|---------------|------|-------|---------------|-------------|
| ASP                               | Unit | Serial Number | Type | Model | Resource Name | Status      |
| 1                                 | 1    | 00-0193825    | 6602 | 030   | DD001         | Unprotected |
|                                   | 2    | 00-0163477    | 6602 | 074   | DD019         | Configured  |
|                                   | 3    | 00-0190494    | 6602 | 070   | DD036         | DPY/Active  |
|                                   | 6    | 00-17900      | 6602 | 030   | DD002         | DPY/Active  |
| 3                                 |      |               |      |       |               | Configured  |
|                                   | 4    | 00-0330477    | 6602 | 074   | DD005         | Unprotected |
|                                   | 5    | 00-0323200    | 6602 | 074   | DD033         | DPY/Active  |

Press Enter to continue.

F3=Exit          F5=Refresh          F9=Display disk unit details  
F11=Disk configuration capacity      F12=Cancel

**Note:** If you are performing a complete system restore, all the disk units on the system may not report in right away. Verify that the number of disk units displayed matches the number of disk units physically attached to the system. If they do not match, wait a few minutes and press F5 (Refresh) until all of the disk units report in.

- If the lower right of the display says More..., you can page forward to see additional units.
- To display the capacity of your disk units and how much capacity is used, press F11 from the Display Disk Configuration Status display or select option 2 from the Use Dedicated Service Tools (DST) menu:

| Display Disk Configuration Capacity |      |      |       |           |          |               |       |                 |       |
|-------------------------------------|------|------|-------|-----------|----------|---------------|-------|-----------------|-------|
| ASP                                 | Unit | Type | Model | Threshold | Overflow | --Protected-- |       | --Unprotected-- |       |
|                                     |      |      |       |           |          | Size          | %Used | Size            | %Used |
| 1                                   |      |      |       | 90%       | No       | 1805          | *     | 2063            | *     |
|                                     | 1    | 6602 | 030   |           |          | 0             | 0.00% | 1031            | *     |
|                                     | 2    | 6602 | 074   |           |          | 773           | *     | 0               | 0.00% |
|                                     | 3    | 6602 | 070   |           |          | 1031          | *     | 0               | 0.00% |
| 3                                   | 6    | 6602 | 030   |           |          | 0             | 0.00% | 1031            | *     |
|                                     |      |      |       | 90%       | No       | 1547          | *     | 0               | 0.00% |
|                                     | 4    | 6602 | 074   |           |          | 773           | *     | 0               | 0.00% |
|                                     | 5    | 6602 | 074   |           |          | 773           | *     | 0               | 0.00% |

- To display the disk protection that is configured for each disk unit, press F11 again:
- To display nonconfigured disk units, press F11 from the Display Disk Configuration Protection display or select option 4 from the Display Disk Configuration menu:

| Display Non-Configured Units |      |       |               |          |            |  |
|------------------------------|------|-------|---------------|----------|------------|--|
| Serial Number                | Type | Model | Resource Name | Capacity | Status     |  |
| 00-0313374                   | 6602 | 074   | DD003         | 773      | DPY/Active |  |

- To print the software disk configuration, use the print key from the displays. If your system already has a printer defined for DST, the output is sent to that printer. If you do not have a DST printer

defined, you are prompted with a list of attached printers. When you are using DST, output goes directly to the printer because spooling is not active.

9. If you have no other tasks to perform, end DST or SST. (See “How to Stop Dedicated Service Tools (DST)” on page 368 or “Stopping System Service Tools (SST)” on page 368.)

## Interpreting Disk Configuration and Status Displays

This topic explains some of the fields that appear on the displays that you use to look at your disk configuration and status. You can view online information for all the fields and their possible values.

**Unit Field:** A unit number is assigned by the system to identify a specific disk unit. The unit number is a software function and does not appear when you display the hardware configuration. When disk units are protected by mirrored protection, both disk units in a mirrored pair are assigned the same unit number.

**Resource Name Field:** The system resource manager assigns a resource name to every hardware device that is physically attached to the system. This resource name is the link between the hardware and the software definition of the hardware. When you add a disk unit to an ASP, you use the resource name to identify which disk unit to add.

**Status Field for the Auxiliary Storage Pool:** The display shows the status of an entire ASP. This status indicates the software disk protection that is in effect for the ASP. The possible values are:

|             |                                                                                                                                                                                                                                              |
|-------------|----------------------------------------------------------------------------------------------------------------------------------------------------------------------------------------------------------------------------------------------|
| Unprotected | Mirrored protection is not active for the ASP. However, device parity protection may be active for some or all of the disk units in the ASP. You need to look at the individual disk units to determine the level of protection for the ASP. |
| Mirrored    | The ASP is fully protected. Mirrored protection has been started for the ASP. All of the disk units in the ASP are protected either by mirrored protection or by device parity protection.                                                   |

**Status–Disk Unit:** The display also shows the status of individual disk units. The possible values are:

|                      |                                                                                                                                                                                                                                           |
|----------------------|-------------------------------------------------------------------------------------------------------------------------------------------------------------------------------------------------------------------------------------------|
| Operational          | The disk unit is operational and ready to accept input or output operations.                                                                                                                                                              |
| Not operational      | The device cannot communicate with the IOP. You should verify that the unit is powered on.                                                                                                                                                |
| Not ready            | The device cannot perform media-related functions, but it can still communicate with the IOP.                                                                                                                                             |
| Busy                 | The device is not available for processing any commands on this connection.                                                                                                                                                               |
| Read/write protected | The device cannot process either a read or a write operation. A device may be in this state due to a cache problem, a device configuration problem, or other types of problems that could cause a data integrity exposure.                |
| Write protected      | The device cannot accept write operations. Read operations are allowed.                                                                                                                                                                   |
| Performance degraded | The device is functional, but performance may be impacted due to other hardware problems (such as a problem with the IOP cache).                                                                                                          |
| Redundant failure    | The device is functional, but availability may be impacted due to other problems (such as a redundant power supply problem). Service is required to prevent additional failures that will stop input and output operations to the device. |
| DPY/Failed           | This unit is part of a disk unit subsystem that has device parity protection. The disk unit failed within its device parity set, causing the loss of data protection for the device parity set.                                           |
| DPY/Unprotected      | This unit is part of a disk unit subsystem that has device parity protection. Data protection is no longer in effect due to a failure in another resource.                                                                                |
| DPY/Rebuilding       | This unit is part of a disk unit subsystem that has device parity protection. Data protection is being rebuilt.                                                                                                                           |

|               |                                                                                                                                                                                                                                                                  |
|---------------|------------------------------------------------------------------------------------------------------------------------------------------------------------------------------------------------------------------------------------------------------------------|
| DPY/Active    | This unit is part of a disk unit subsystem that has device parity protection. The unit is operational and ready to accept input or output operations.                                                                                                            |
| DPY/Resyncing | This unit is part of a disk unit subsystem that has device parity protection. The subsystem is in the process of recreating the redundancy data for the device parity set. All units in the set that are being synchronized will have this status.               |
| DPY/Unknown   | This unit is part of a disk unit subsystem that has device parity protection. The status of this unit is not known to the system.                                                                                                                                |
| Active        | This unit is one of a mirrored pair. It is capable of having data written to it or read from it.                                                                                                                                                                 |
| Suspended     | This unit is one of a mirrored pair. It is not capable of having data written to it or read from it. The data on this unit is not current. For example, if the disk needs repair action or has been manually suspended, it would be in a <i>Suspended</i> state. |
| Resuming      | This unit is one of a mirrored pair. The current data is being copied (or will be copied) to this unit from the other active unit of the mirrored pair.                                                                                                          |
| Unprotected   | The device is in a state that cannot be determined.                                                                                                                                                                                                              |





---

## Chapter 19. Working with Auxiliary Storage Pools

This chapter contains procedures for working with auxiliary storage pools (ASPs). When you are making changes to the disk configuration on your system, refer to Chapter 18, “Configuring Disks and Disk Protection” for the correct sequence of steps for your situation.

Support for independent ASPs is provided through iSeries Navigator. If you want to work with independent ASPs, you can find information in the Information Center at the following Web site:

<http://www.ibm.com/eserver/iseriess/infocenter>

Both the Information Center and iSeries Navigator refer to ASPs as Disk Pools.

---

### How to Add Disk Units to an Auxiliary Storage Pool

#### Do Things in the Right Sequence

- If you want to have device parity protection for the disks that you are adding, you should start device parity protection before you add the disk units to an ASP.
- If you have more than one ASP on your system, you should plan how you want to add the new disk units before you begin this procedure. The topic, Information Center contains more information. You can access the Information Center from the from the following Web site:

<http://www.ibm.com/eserver/iseriess/infocenter>

When you (or your service representative) physically attach a new disk unit to your system, the status of the new disk unit is nonconfigured. **Nonconfigured** status means that a disk unit has not yet been assigned to an ASP on the system. You can assign disk units to an existing ASP or to a new ASP. You create a new ASP simply by assigning disk units to it.

To assign nonconfigured disks to an ASP, do the following:

1. If you are not already using DST, perform a manual IPL to start DST. See “How to Start Dedicated Service Tools (DST)” on page 366.
2. From the Use Dedicated Service Tools (DST) menu, do the following:
  - a. Select option 4 (Work with disk units).
  - b. Select option 1 (Work with disk configuration) on the Work with Disk Units display.
  - c. Select option 3 (Work with ASP configuration) on the Work with Disk Configuration display.or from the System Service Tools (SST) menu,
  - a. Select option 3 (Work with disk units).
  - b. Select option 2 ( Work with disk configuration) on the Work with Disk Units display.
3. Select the option to add units to ASPs and balance data. The Specify ASPs to Add Units to display appears. It lists all the disk units that have a status of nonconfigured.

Specify ASPs to Add Units to

Specify the ASP to add each unit to.

| Specify ASP | Serial Number | Type | Model | Capacity | Resource Name |
|-------------|---------------|------|-------|----------|---------------|
| ---         | 00-0103706    | 6602 | 030   | 1031     | DD031         |
| ---         | 00-1000341    | 9337 | 211   | 542      | DD012         |
| ---         | 00-5000341    | 9337 | 211   | 542      | DD015         |
| ---         | 00-7000341    | 9337 | 211   | 542      | DD011         |
| ---         | 00-3000341    | 9337 | 211   | 542      | DD014         |
| ---         | 00-2000341    | 9337 | 211   | 542      | DD013         |
| 1           | 00-61300      | 6603 | 074   | 1475     | DD006         |
| 1           | 00-52262      | 6606 | 074   | 1475     | DD008         |
| 1           | 00-86978      | 6606 | 050   | 1967     | DD009         |
| 2           | 00-95744      | 6603 | 074   | 1475     | DD005         |
| 2           | 00-47657      | 6606 | 074   | 1475     | DD007         |
| ---         | 00-0238703    | 6602 | 074   | 773      | DD052         |
| ---         | 00-0128330    | 6602 | 074   | 773      | DD051         |

More...

F3=Exit      F5=Refresh      F11=Display disk configuration capacity  
F12=Cancel

**Note:** If you are performing a complete system restore, all the disk units on the system may not report in right away. Verify that the number of disk units displayed matches the number of disk units physically attached to the system. If they do not match, wait a few minutes and press F5 (Refresh) until all of the disk units report in.

4. Type an ASP number next to each disk unit that you want to configure. If you type an ASP number that does not currently exist on your system, the system will create that ASP.

Number 1 is reserved for the system ASP. You can enter a number from 2 to 32. Numbers 33 to 225 are reserved for independent ASPs.

The **Confirm Add Units** display appears:

Confirm Add Units

Add will take several minutes for each unit. The system will have the displayed protection after the unit(s) are added.

Press Enter to confirm your choice for 1=Add units.  
Press F9=Capacity Information to display the resulting capacity.  
Press F12=Cancel to return and change your choice.

| ASP | Unit | Serial Number | Type | Model | Resource Name | Protection    |
|-----|------|---------------|------|-------|---------------|---------------|
| 1   |      |               |      |       |               | Unprotected   |
|     | 1    | 00-48519      | 6606 | 030   | DD010         | Unprotected   |
|     | 2    | 00-86978      | 6606 | 050   | DD009         | Unprotected   |
|     | 3    | 00-52262      | 6606 | 074   | DD008         | Device Parity |
|     | 4    | 00-61300      | 6603 | 074   | DD006         | Device Parity |
| 2   |      |               |      |       |               | Unprotected   |
|     | 5    | 00-95744      | 6603 | 074   | DD005         | Device Parity |
|     | 6    | 00-47657      | 6606 | 074   | DD007         | Device Parity |

F9=Resulting Capacity      F12=Cancel

The **Confirm Add Units** display shows what the entire system configuration will be when you add the units. If you have more than one ASP on your system, verify this configuration against your planned configuration.

5. You can press F9 (Resulting capacity) to see how the change will affect your disk utilization. You are shown the **Resulting Capacity** display:

| Resulting Capacity                                                                        |           |                   |       |               |        |                    |       |               |        |
|-------------------------------------------------------------------------------------------|-----------|-------------------|-------|---------------|--------|--------------------|-------|---------------|--------|
| The configuration change that you requested would result in the following ASP capacities. |           |                   |       |               |        |                    |       |               |        |
| Press Enter to continue.                                                                  |           |                   |       |               |        |                    |       |               |        |
|                                                                                           |           | -----Current----- |       |               |        | -----Proposed----- |       |               |        |
|                                                                                           |           | --Protected--     |       | -Unprotected- |        | --Protected--      |       | -Unprotected- |        |
| ASP                                                                                       | Threshold | Size              | %Used | Size          | %Used  | Size               | %Used | Size          | %used  |
| 1                                                                                         | 90%       | 0                 | 0.00% | 1967          | 23.98% | 2950               | 0.07% | 3934          | 12.02% |
| 2                                                                                         | 90%       |                   |       |               |        | 2950               | 0.07% | 0             | 0.00%  |

6. Press F12 (Cancel) to return to the **Confirm Add Units** display.
7. If you are satisfied with the configuration, press the Enter key to add the disk units to the ASP. If you want to make changes, press F12 to return to step 4 on page 376

Adding units can take from several minutes to several hours. During that time, you are shown the **Function Status** display.

The system updates the display periodically.

| Function Status            |  |
|----------------------------|--|
| You selected to add units. |  |
| 5 % Complete               |  |

**Note:** You can press F16 to return to the Use Dedicated Service Tools (DST) menu if you have other tasks to perform. However, you cannot perform any disk configuration tasks or end DST until the system has finished adding disk units.

The time it takes the system to add units depends on the type, model, and size of each unit being added and the ability of the system to do multiple adds at the same time.

8. If you have no other tasks to perform, end DST or SST. (See “How to Stop Dedicated Service Tools (DST)” on page 368 or “Stopping System Service Tools (SST)” on page 368.)

## How to Change the Storage Threshold for an Auxiliary Storage Pool

The storage threshold for an ASP determines when the system warns you that the space allocated for the ASP is almost full. The default for an ASP is 90%. To change the storage threshold for an ASP, do the following:

1. From the System Service Tools (SST) menu, do the following:
  - a. Select option 3 (Work with disk units).
  - b. Select option 2 (Work with disk configuration).

**Note:** If you are not already using DST, see “How to Start Dedicated Service Tools (DST)” on page 366.

or from the Use Dedicated Service Tools (DST) menu, do the following:

- a. Select option 4 (Work with disk units).
- b. Select option 1 (Work with disk configuration) on the Work with Disk Units display.
- c. Select option 3 (Work with ASP configuration) on the Work with Disk Configuration display.

If you are not already using DST, perform a manual IPL to start DST. See “How to Start Dedicated Service Tools (DST)” on page 366.

2. Select the option to work with the ASP threshold. The Select ASP to Change Threshold display is shown.

```

                                Select ASP to Change Threshold
Type option, press Enter.
1=Select
Option  ASP  Threshold  Overflow      --Protected--  --Unprotected--
          1    90%      No           Size %Used       Size %Used
1         2    90%      No           6046 0.31%     7676 6.36%
          2    90%      No           2950 *         0 0.00%
  
```

3. On the Select the ASP to Change Threshold display, select the ASP that you want to have a different threshold. Press the Enter key. The following display is shown.

```

                                Change Storage Threshold
ASP  Threshold  Overflow      --Protected--  --Unprotected--
  2    90%      No           Size %Used       Size %Used
  2    90%      No           2950 *         0 0.00%

This is an unprotected ASP. The threshold represents the amount of
unprotected storage used before a warning message is sent to the system
operator. Type choice, press Enter.
New threshold . . . . . 88% 1-100
  
```

4. Type your choice for the *New threshold* prompt and press the Enter key.
5. If you have no other tasks to perform, end DST or SST. (See “How to Stop Dedicated Service Tools (DST)” on page 368 or “Stopping System Service Tools (SST)” on page 368.)

---

## How to Change the Storage Threshold for the System Auxiliary Storage Pool

It is important to prevent the system ASP from filling to capacity. If this occurs, the system will end abnormally. You can try to avoid this by specifying a storage threshold that warns you of a potential space shortage.

One way to establish this threshold is through Dedicated Service Tools (DST) or System Service Tools (SST). Use the same procedures as you would when setting the storage threshold for any other ASP. See “How to Change the Storage Threshold for an Auxiliary Storage Pool” on page 377 for information on this procedure.

**Note:** Establishing the threshold through DST will not prevent the system from ending abnormally. It will only notify you when the system ASP reaches the capacity threshold.

You can also protect the system ASP from filling to capacity by using the QSTGLOWLMT and QSTGLOWACN system values. The QSTGLOWLMT system value specifies the percentage of unallocated auxiliary storage that is remaining when the critical storage lower limit is reached. If the system reaches that limit, the QSTGLOWACN system value specifies what action the system should take. Using this method allows the system to actively prevent an abnormal shutdown instead of simply sending a warning of the condition.

**Note:** Using these system values does **not** affect any existing storage threshold that you may have set through DST.

You can use the QSTGLOWLMT and QSTGLOWACN system values on the following commands:

CHGSYSVAL            RTVSYSVAL  
 DSPSYSVAL            WRKSYSVAL

The following procedure demonstrates how to use these system values. (The WRKSYSVAL command is used as an example.)

1. At a command line, type WRKSYSVAL and press Enter. You are shown the Work with System Values display.

```

                                Work with System Values
                                System: YOURSYS
Position to . . . . . _____ Starting characters of system value
Subset by Type . . . . . _____ F4 for list

Type options, press Enter.
  2=Change  5=Display

Option   System
Value   Type   Description
-       QSTGLOWACN *STG   Auxiliary storage lower limit action
-       QSTGLOWLMT *STG   Auxiliary storage lower limit
  
```

2. Type a 2 in the option field to change QSTGLOWACN and press Enter. You must have \*ALLOBJ and \*SECADM authority to change QSTGLOWACN. You are shown the Change System Value display.

```

                                Change System Value

System value . . . . . : QSTGLOWACN
Description . . . . . : Auxiliary storage lower limit action

Type choice, press Enter.

Action . . . . . *MSG_____ *MSG
                                     *CRITMSG
                                     *REGFAC
                                     *ENDSYS
                                     *PWRDWSYS
  
```

3. On the Change System Value display, type the name of the action that you want the system to perform after reaching the critical storage lower limit. Press the Enter key. The actual actions that are performed by the action names are as follows:

**\*MSG**

The system sends the CPI099C message to the QSYSMSG and QSYSOPR message queues. (The system also sends this message when you select any one of the other actions.)

**\*CRITMSG**

The system sends the CPI099B critical message to the user who is specified in the service attribute to receive critical messages.

**\*REGFAC**

The system submits a job to call exit programs that are registered for the QIBM\_QWC\_QSTGLOWACN exit point.

**\*ENDSYS**

The system ends to the restricted state.

**\*PWRDWN SYS**

The system powers down immediately and restarts

- From a command line, type DSPSYSVAL and press the Enter key. The Display System Value screen is shown.

```

                Display System Value
System value . . . . . : QSTGLOWLMT
Description . . . . . : Auxiliary storage lower limit
Lower limit . . . . . : 1.0000      0-100 percent

```

The lower limit value is the lowest amount of unused storage that can exist in the system ASP before the system performs the QSTGLOWACN action. (You can use the WRKSYSSTS command to view the amount of storage that is currently being used in the system ASP.) The system is shipped with the QSTGLOWLMT system value set to 5.0. Any change you make to this system value takes effect immediately.

**Note:** If the DST threshold is above 95%, the lower limit value will be set to the difference between 100% and the threshold setting. For example, if the DST threshold is set to 98%, QSTGLOWLMT will be set to 2.0. (100 — 98 = 2.) This only occurs at the time you install V4R2.

---

## How to Move a Disk Unit to a Different Auxiliary Storage Pool

You may want to move a disk unit from one ASP to another. For example, you want to create a user ASP for journal receivers and move some of the disk units on your system to the new user ASP. You can accomplish this in one process. When you move a disk unit to an ASP that does not exist, the system creates the ASP.

You may also decide to move disk units because you no longer need to have user ASPs on your system and you want to move all the disk units back to the system ASP.

**Note:** Disk units cannot be moved to or from an independent auxiliary storage pool.

**Restrictions When Changing Your ASP Configuration:** Consider these things when you are planning to move disk units from an ASP:

- The system may take a long time to move the unit because it must copy the data from that unit to other units in the ASP.
- You cannot move unit 1 (the load source unit) from the system ASP.
- You cannot move disk units from a user ASP that is overflowed.
- You cannot move units in and out of the same ASP in the same operation.

- When mirrored protection is active for an ASP, you cannot move disk units in and out of the ASP. You must remove disk units in pairs from a mirrored ASP. You can then add them to a different ASP.
- When mirrored protection is active for the ASP that contains the disk units, you must remove both units of a mirrored pair.
- When you remove a disk unit, it becomes nonconfigured.

To move disk units between ASPs, do the following:

1. If you are not already using DST, perform a manual IPL to start DST. See “How to Start Dedicated Service Tools (DST)” on page 366.
2. From the Use Dedicated Service Tools (DST) menu, do the following:
  - a. Select option 4 (Work with disk units).
  - b. Select option 1 (Work with disk configuration) on the Work with Disk Units display.
  - c. Select option 3 (Work with ASP configuration) on the Work with Disk Configuration display.
3. Select option 6 (Move units from one ASP to another) from the Work with ASP Configuration display. The Specify ASP to Move Disk Units display is shown.

| Specify ASP to Move Disk Units                                                                                                                         |             |      |               |      |       |               |       |                 |        |
|--------------------------------------------------------------------------------------------------------------------------------------------------------|-------------|------|---------------|------|-------|---------------|-------|-----------------|--------|
| To move units to different ASPs, specify the ASP that you want to move each one to in the 'New ASP' field. Specify the units to be moved, press Enter. |             |      |               |      |       |               |       |                 |        |
| New ASP                                                                                                                                                | Current ASP | Unit | Serial Number | Type | Model | --Protected-- |       | --Unprotected-- |        |
|                                                                                                                                                        |             |      |               |      |       | Size          | %Used | Size            | %Used  |
|                                                                                                                                                        | 1           |      |               |      |       | 0             | 0.00% | 4124            | 41.50% |
|                                                                                                                                                        |             | 1    | 00-0193825    | 6602 | 030   | 0             | 0.00% | 1031            | 82.00% |
|                                                                                                                                                        |             | 2    | 00-0163477    | 6602 | 030   | 0             | 0.00% | 1031            | 29.00% |
| 2                                                                                                                                                      |             | 3    | 00-0190494    | 6602 | 030   | 0             | 0.00% | 1031            | 27.00% |
| 2                                                                                                                                                      |             | 4    | 00-17900      | 6602 | 030   | 0             | 0.00% | 1031            | 28.00% |

4. Type the number of the ASP you want to move the units to in the *New ASP* column and press the Enter key. If you specify an ASP that does not currently exist on your system, the system creates a new ASP. If the move operation would leave the source ASP with insufficient storage, you receive an error message.

If you see the Confirm Move of Unit display, skip to step 6.

The Confirm Continuation display is shown if the storage management directories are not usable:

| Confirm Continuation                                                                                                                                                                                                   |
|------------------------------------------------------------------------------------------------------------------------------------------------------------------------------------------------------------------------|
| In order to proceed the system must perform internal processing that may take several minutes during which the system may appear inactive. Press Enter to continue. Press F12=Cancel to return and change your choice. |

5. Determine whether you want to cancel the procedure or continue. If you want to continue, press the Enter key.
6. The Confirm Move of Unit display is shown:

Confirm Move of Unit

Moving units will take several minutes. Press Enter to confirm your choice to move the units. Press F9=Capacity information to display the capacity. Press F12=Cancel to return to change your choice.

| ASP | Unit | Serial     |      |       | --Protected-- |       | --Unprotected-- |        |
|-----|------|------------|------|-------|---------------|-------|-----------------|--------|
|     |      | Number     | Type | Model | Size          | %Used | Size            | %Used  |
| 1   | 1    | 00-0193825 | 6602 | 030   | 0             | 0.00% | 2062            | 83.00% |
|     | 2    | 00-0163477 | 6602 | 030   |               |       |                 |        |
| 2   | 3    | 00-0190494 | 6602 | 030   | 0             | 0.00% | 2062            | 0.01%  |
|     | 4    | 00-17900   | 6602 | 030   |               |       |                 |        |

Press F9 (Capacity information) to display the resulting capacity.

Resulting Capacity

The configuration change that you requested would result in the following ASP capacities. Press Enter to continue.

| ASP | Threshold | -----Current----- |       |               |        | -----Propose----- |       |               |        |
|-----|-----------|-------------------|-------|---------------|--------|-------------------|-------|---------------|--------|
|     |           | --Protected--     |       | -Unprotected- |        | --Protected--     |       | -Unprotected- |        |
|     |           | Size              | %Used | Size          | %Used  | Size              | %Used | Size          | %Used  |
| 1   | 90%       | 0                 | 0.00% | 4124          | 41.50% | 0                 | 0.00% | 2062          | 83.00% |
| 2   | 90%       |                   |       |               |        | 0                 | 0.00% | 2062          | 0.01%  |

7. Press the Enter key to return to the Confirm Move of Unit display.
8. Press the Enter key on the Confirm Move of Units display to move the selected units. The system will move the data off the selected units to the remaining units in the source ASP. The move can take several minutes during which the system appears inactive.
9. When the move operation is complete, you return to the Work with ASP Configuration display.
10. If you have no other tasks to perform, end DST. (See "How to Stop Dedicated Service Tools (DST)" on page 368.)

## How to Remove a Disk Unit from an Auxiliary Storage Pool

Use the procedure for removing disk units from your system for the following reasons:

- You want to physically remove a disk unit from your system.
- You want to move a disk unit from an ASP that has mirrored protection to another ASP. You can remove pairs of disk units from a mirrored ASP without stopping mirrored protection. You then add the disk units to the target ASP.

**Considerations When Changing Your ASP Configuration:** Consider these things when you are planning to remove disk units from an ASP:

- The system may take a long time to remove the unit because it must copy the data from that unit to other units in the ASP.
- To proceed, the system must perform internal processing that may take several minutes during which the system may appear inactive.
- When you remove a disk unit, it becomes nonconfigured.

**Restrictions When Changing Your ASP Configuration:** Consider these restrictions when you are planning to remove disk units from an ASP:

- You cannot remove unit 1 (the load source unit) from the system ASP.
- You cannot remove disk units from a user ASP that is overflowed.



- When mirrored protection is active for the ASP that contains the disk units, you must remove both units of a mirrored pair.
- If you are going to physically remove a disk unit from an IOA, you must either exclude the disk unit or stop device parity protection first.

To remove a disk unit, do the following:

1. If you are not already using DST, perform a manual IPL to start DST. See “How to Start Dedicated Service Tools (DST)” on page 366.
2. From the Use Dedicated Service Tools (DST) menu, do the following:
  - a. Select option 4 (Work with disk units).
  - b. Select option 1 (Work with disk configuration) on the Work with Disk Units display.
  - c. Select option 3 (Work with ASP configuration) on the Work with Disk Configuration display.
3. You are shown the Remove Units from Configuration display.

| Remove Units from Configuration  |      |     |               |      |       |               |            |
|----------------------------------|------|-----|---------------|------|-------|---------------|------------|
| Type options, press Enter.       |      |     |               |      |       |               |            |
| 4=Remove unit from configuration |      |     |               |      |       |               |            |
| OPT                              | Unit | ASP | Serial Number | Type | Model | Resource Name | Status     |
|                                  | 2    | 1   | 10-00A7529    | 9332 | 400   | DD010         | Configured |
|                                  | 3    | 1   | 10-00A4936    | 9332 | 400   | DD012         | Configured |
|                                  | 4    | 1   | 10-00A4936    | 9332 | 400   | DD019         | Configured |
| 4                                | 5    | 1   | 10-00A7498    | 9332 | 400   | DD025         | Configured |
| 4                                | 6    | 1   | 10-00A7498    | 9332 | 400   | DD036         | Configured |
|                                  | 7    | 1   | 10-00A7530    | 9332 | 400   | DD042         | Configured |
|                                  | 8    | 1   | 10-00A7530    | 9332 | 400   | DD052         | Configured |

4. Type a 4 (Remove unit from configuration) in the OPT column for each unit that you want to remove and press the Enter key. If the remove operation would leave the ASP with insufficient storage, you receive an error message.

If you see the Confirm Remove Disk Units display, skip to 6.

The Confirm Continuation display may be shown before the Confirm Remove Disk Units display if the storage management directories are not usable.

| Confirm Continuation                                                                                                               |
|------------------------------------------------------------------------------------------------------------------------------------|
| To proceed, the system must perform internal processing that may take several minutes during which the system may appear inactive. |
| Press Enter to continue.                                                                                                           |
| Press F12=Cancel to return and change your choice.                                                                                 |

5. Determine whether you want to cancel the procedure or continue. If you want to continue, press the Enter key.
6. The Confirm Remove Disk Units display is shown:

### Confirm Remove Disk Units

Removing disk units will take several minutes.

Press Enter to confirm remove of disk units.  
Press F9=Capacity information to display the capacity information.  
Press F12=Cancel to return to change your choice.

| OPT | Unit | ASP | Serial Number | Type | Model | Resource Name | Status     |
|-----|------|-----|---------------|------|-------|---------------|------------|
| 4   | 5    | 1   | 10-00A7498    | 9332 | 400   | DD010         | Configured |
| 4   | 6    | 1   | 10-00A7498    | 9332 | 400   | DD012         | Configured |

Press F9 (Capacity information to display the resulting capacity.

### Resulting Capacity

The configuration change that you requested would result in the following ASP capacities.

Press Enter to continue.

| ASP | Threshold | -----Current----- |       |               |        | -----Modified----- |       |               |        |
|-----|-----------|-------------------|-------|---------------|--------|--------------------|-------|---------------|--------|
|     |           | --Protected--     |       | -Unprotected- |        | --Protected--      |       | -Unprotected- |        |
|     |           | Size              | %Used | Size          | %Used  | Size               | %Used | Size          | %Used  |
| 1   | 90%       | 0                 | 0.00% | 1600          | 52.70% | 0                  | 0.00% | 1200          | 70.26% |

7. Press the Enter key to return to the Confirm Remove Disk Units display.
8. Press the Enter key on the Confirm Remove Disk Units display to remove the selected units. The system moves the data off the units selected to be removed to the remaining units in the source ASP. The remove can take several minutes or several hours during which the system appears inactive.

#### Notes:

- a. The time it takes to remove a unit depends on the disk unit type and model.
  - b. If the data on the unit being removed is severely fragmented and the amount of storage used is high, the remove operation could take several hours.
9. When the remove operation is complete, you return to the Work with ASP Configuration display.

If you have no other tasks to perform, end DST. (See “How to Stop Dedicated Service Tools (DST)” on page 368.)

## How to Delete an Auxiliary Storage Pool

When you delete a user ASP, the status of all the units that are assigned to the ASP becomes nonconfigured. Any data that is in the ASP is deleted. The normal procedure is to remove all objects from the ASP before you delete the ASP. You can do this either by moving the objects to a different ASP or by deleting the objects. If you delete an ASP that has objects in it, those objects are marked by the system as damaged or destroyed.

You cannot delete ASP 1, which is the system ASP and holds the operating system.

To delete a user ASP, do the following:

1. If you are not already using DST, perform a manual IPL to start DST. See “How to Start Dedicated Service Tools (DST)” on page 366.
2. From the Use Dedicated Service Tools (DST) menu, do the following:
  - a. Select option 4 (Work with disk units).
  - b. Select option 1 (Work with disk configuration) on the Work with Disk Units display.

- c. Select option 3 (Work with ASP configuration) on the Work with Disk Configuration display.
3. Select option 2 (Delete user ASP) on the Work with ASP Configuration display and press the Enter key.

| Delete User ASP          |     |           |          |               |        |                 |       |
|--------------------------|-----|-----------|----------|---------------|--------|-----------------|-------|
| Type option, press Enter |     |           |          | 4=Delete      |        |                 |       |
| Option                   | ASP | Threshold | Overflow | --Protected-- |        | --Unprotected-- |       |
|                          |     |           |          | Size          | %Used  | Size            | %Used |
| 1                        |     | 90%       | No       | 600           | 77.84% | 0               | 0.00% |
| 2                        |     | 90%       | No       | 0             | 0.00%  | 200             | 0.53% |
| 3                        |     | 90%       | No       | 0             | 0.00%  | 200             | 0.53% |

4. Type a 4 in the *Option* field of the ASP you want to delete and press the Enter key. The Confirm Delete of User ASP display is shown.

| Confirm Delete Of User ASP                                                                                                                                                                                                 |     |           |          |               |       |                 |       |
|----------------------------------------------------------------------------------------------------------------------------------------------------------------------------------------------------------------------------|-----|-----------|----------|---------------|-------|-----------------|-------|
| Warning: Deleting a user ASP will remove all units of that ASP from the configuration. The units will become nonconfigured. Press F10 to confirm your choice for 4=delete Press F12=Cancel to return to change your choice |     |           |          |               |       |                 |       |
| Option                                                                                                                                                                                                                     | ASP | Threshold | Overflow | --Protected-- |       | --Unprotected-- |       |
|                                                                                                                                                                                                                            |     |           |          | Size          | %Used | Size            | %Used |
| 4                                                                                                                                                                                                                          | 2   | 90%       | No       | 0             | 0.00% | 200             | 0.53% |

5. Press F10 (Confirm) to confirm that delete of the ASP. The delete operation may take several minutes.
6. If you have no other tasks to perform, end DST. (See “How to Stop Dedicated Service Tools (DST)” on page 368.)

---

## Calculating Space Requirements for an Auxiliary Storage Pool

When you are planning to make changes to the disk configuration or disk protection on your system, you need to calculate the space requirements for the change before you begin. You want to ensure that your system has sufficient disk storage for the changes. Use the disk space calculator available in the Systems Management topic of the iSeries Information Center at <http://www.ibm.com/eserver/iseriew/infocenter>.

---

## How to Display the Objects in a User ASP

To print a list of all the objects in a user ASP, use the DSPOBJD command and specify the object types you want to display. For a nonlibrary user ASP specify object types \*FILE (savf), \*JRN, and \*JRNRCV. For a list of objects that are supported in an independent ASP, see **Systems management** —> **Disk management** —> **Disk management concepts** —> **Types of disk pools** —> **Independent disk pools** in the iSeries Information Center, <http://www.ibm.com/eserver/iseriew/infocenter>. The object description information includes the ASP where the object is located.

To list all the documents in a user ASP, use the Query Document Library (QRYDOCLIB) command:  
 QRYDOCLIB ... QRYDFN(\*IF(\*ASP \*EQ 4))

To determine which ASP an object is in, use the DSPOBJD command and look at the number shown on the *Auxiliary storage pool* field. To determine which ASP a DLO is in, use the DSPDLONAM command. Look at the number shown on the *Auxiliary storage pool* field.

If the object is an integrated file system object, use the Display Object Links (DSPLNK) command. Select option 8 (Display attributes) to determine which ASP the object is in.

---

## Balancing an Auxiliary Storage Pool

Beginning with V4R4M0, you can use the ASP balancing function. This function improves system performance by balancing disk utilization across all of the disk arms in an ASP. You can use the Start ASP Balance (STRASPBAL) command to start the function. You will need to select the method of balancing that you wish to use:

- Capacity balancing
- Usage balancing
- Hierarchical Storage Management (HSM) balancing

**Note:** You cannot balance journal receivers among the disk units of an ASP if the journal does not have one of the receiver size options specified. If neither \*MAXOPT1 nor \*MAXOPT2 are specified for the RCVSIZOPT parameter on CRTJRN or CHGJRN, then the journal receiver can only be spread across 10 disk arms. If either \*MAXOPT1 or \*MAXOPT2 is specified, then the journal receiver can be spread across as many as 100 arms. Using RCVSIZOPT(\*RMVINTENT) will also effect how the journal receiver uses the disk arms in the ASP.

Before using usage balancing or HSM balancing, you must run the Trace ASP Balance (TRCASPBAL) command. This command starts a trace function that collects statistics on the data in the ASPs that you wish to balance. Data that is used often is referred to as **high use** or **hot** data. Data that is not used often is referred to as **low use** or **cold** data.

To end the ASP balancing function, use the End ASP Balance (ENDASPBAL) command.

### Capacity Balancing

When you use capacity balancing, the data on the disk units within an ASP is distributed evenly across all the units. Instead of some units containing the majority of the data, each unit has an equal percentage of used and unused space. This type of balancing is useful when you add new disk units to an ASP.

### Usage Balancing

Usage balancing is useful when the ASP contains some disk units which are utilized to a higher degree than other disk units in the ASP. The TRCASPBAL command must finish collecting statistics before usage balancing can begin. When you use usage balancing, the high use and low use data on each unit in the ASP is redistributed to balance the arm utilization of each unit within the specified ASP.

### Hierarchical Storage Management (HSM) Balancing

Hierarchical Storage Management balancing can only be used ASPs that contain a mixture of compressed and non-compressed disk units. The TRCASPBAL command must finish collecting statistics before hierarchical storage management balancing can begin. When you use hierarchical storage management balancing, the high use and low use data on each unit in the ASP is redistributed. The high use data is moved to high performance units and the low use data is moved to low performance units. After the balance activity has completed, the system clears the trace information.

---

## Transferring Objects between Auxiliary Storage Pools

This topic explains how to move entire libraries or folders from one ASP to another ASP. It also describes special procedures when you are moving a library that contains journals because a journal and the journaled objects must be in the same basic user ASP or the same independent ASP group. "How to Work with Nonlibrary User ASPs" on page 393 discusses the procedures for working with nonlibrary user ASPs.

You cannot directly move objects between ASPs because the MOVOBJ command and the MOVDOC command move only the pointer to the object. They do not physically copy data from one location to another. In general, do the following to move an object to a different ASP:

1. Save the object.
2. Delete the object from the system. If you are transferring the object from one independent ASP to another independent ASP, this step is not required.
3. Restore the object to the target ASP by using the RSTASP parameter on the RSTxxx command. If you are restoring objects to an independent ASP, use the RSTASPDEV parameter.

These restrictions apply when specifying the RSTASP parameter for a basic user ASP:

- When you attempt to restore an object to a different basic ASP from its library, the ASP must be a nonlibrary user ASP and the object must be a journal, a journal receiver, or a save file.
  - For journals, journal receivers, and save files, if a library exists on the ASP, you receive an error message and the object is not restored.
  - For other object types, the object is restored to the ASP that contains the library.
- If you try to restore an object to a basic user ASP by explicitly specifying the desired user ASP for the RSTASP parameter and the designated user ASP does not exist, you receive a message. The object is not restored.
- If you restore an object and specify RSTASP(\*SAVASP), and if the basic ASP from which the object was saved no longer exists, the object is restored to the system ASP. You receive an informational message.

If you try to restore an object to an independent ASP by explicitly specifying the desired independent ASP for the RSTASPDEV parameter and the designated independent ASP does not exist, you receive a message. The object is not restored.

## How to Move Authorities to a Different ASP

Because you must delete an object in order to move it to another ASP, private authorities to the object are lost. To move authorities for an object, do the following:

1. Sign on as QSECOFR.
2. Copy the object's authorities to a temporary object.

- a. Create a temporary object:

```
CRTDTAARA QTEMP/X *CHAR AUT(*EXCLUDE)
```

- b. Copy the authorities:

```
RVKOBJAUT QTEMP/X *DTAARA QSECOFR *ALL
GRTOBJAUT OBJ(QTEMP/X) OBJTYPE(*DTAARA)
REFOBJ(object)
REFOBJTYPE(object-type)
```

3. Save the object to your save media.
4. Delete the object from the system.
5. Restore the object to the target ASP.
6. Copy the authorities to the restored object.

```
GRTOBJAUT OBJ(object) OBJTYPE(object-type)
REFOBJ(QTEMP/X)
REFOBJTYPE(*DTAARA)
```

7. Delete the temporary object:

```
DLTDTAARA QTEMP/X
```

## How to Transfer a Library to a Different ASP

Use the following procedure to move a library to a different ASP. This example moves the CUSTLIB library from ASP 1 to ASP 2.

1. Save the private authorities for the library: SAVSECDTA DEV(TAP01).
2. Save the library: SAVLIB LIB(CUSTLIB) DEV(TAP01) ACCPTH(\*YES). Consider saving the object twice to 2 different media volumes.

3. Delete the library: DLTLIB LIB(CUSTLIB).
4. Place the system in a restricted state: ENDSBS \*ALL \*IMMED.
5. Restore the information about private authorities that you saved along with user profiles in step 1 on page 387: RSTUSRPRF USRPRF(\*ALL) DEV(TAP01)
6. Restore the library to the new user ASP: RSTLIB SAVLIB(CUSTLIB) RSTASP(2)
7. Restore authority to the library and its objects: RSTAUT

As an alternative to the preceding method, you can consider using the Move Library to ASP (QHSMMOVL) API to transfer the library to a different ASP. The QHSMMOVL API handles object authorities as part of the library transfer process. You cannot use the QHSMMOVL API for libraries that contain journals, journal receivers, or objects that are journaled. For more information and restrictions, see **Programming** —> **APIs** in the iSeries Information Center, <http://www.ibm.com/eserver/series/infocenter>.

## How to Transfer a Folder to a Different ASP

Use the following procedure to move a folder to a different ASP. This example moves the HRFLR folder from ASP 1 to ASP 2. Do not move IBM-supplied folders (those starting with Q) to a user ASP. These folders must be in the system ASP.

1. Save the private authorities for the folder: SAVSECDTA DEV(TAP01).
2. Save the folder: SAVDLO DLO(\*ALL) FLR(HRFLR) DEV(TAP01). Consider saving the object twice to 2 different media volumes.
3. Delete the folder: DLTDL0 DLO(\*ALL) FLR(HRFLR). Do not skip this step. If you restore a DLO to an ASP and it already exists in another ASP, you receive an error message. The restore operation continues with the next DLO. If you issue a restore command for a large number of DLOs, you will receive a large number of error messages.
4. Place the system in a restricted state: ENDSBS \*ALL \*IMMED.
5. Restore the private authorities you saved in step 1: RSTUSRPRF USRPRF(\*ALL) DEV(TAP01)
6. Restore the folder to the new user ASP: RSTDLO DLO(\*ALL) SAVFLR(HRFLR) RSTASP(2)
7. Restore authority to the folder and its objects: RSTAUT

You can move more than one folder at a time by specifying multiple folders on the SAVDLO and RSTDLO commands. If you save DLOs from more than one ASP, you must specify sequence numbers on the RSTDLO command.

## How to Transfer Journals and Objects to a Different ASP

If you use a library user ASP, both the objects you are journaling and the journal must be in the same ASP. For the purpose of recovery as well as performance, it is recommended that the journal receiver be placed in a different user ASP. If the journal is in the system or a basic user ASP, place the journal receiver in another basic user ASP. If the journal is in an independent ASP, place the journal receiver in secondary ASP when the journal is stored in the primary ASP of the disk pool group. If a failure occurs in the ASP that contains the objects and the journal, you do not lose both the objects and the journaled changes that are in the receiver. Placing your objects and journal receiver in the same user ASP also causes contention between access to the object and access to the journal receiver.

Use the following procedure to move a journal and the associated journaled objects to a different ASP. This procedure applies to library user ASPs (where the journal and its library are in the same ASP). If the journal is in a nonlibrary user ASP, refer to “How to Work with Nonlibrary User ASPs” on page 393.

### Transferring journaled objects

1. Save private authorities for the journal and journaled objects: SAVSECDTA DEV(TAP01)
2. Save the journal using the SAV, SAVOBJ or the SAVLIB command.

3. Because the journal and journaled objects must be in the same ASP, the objects must also be moved to the same user ASP before you can resume journaling the objects after the move.
4. Save any objects that you journal and save any logical files that have their access paths journaled. You can use the Work with Journal Attributes command to determine which objects that you journal. Consider saving the journal and journaled objects twice to two different media volumes.
5. Delete the journaled objects using the appropriate delete command.
6. Delete the journal using the Delete Journal (DLTJRN) command.
7. Delete the library that contained the journal.
8. Create the library for the journal in the user ASP using the Create Library (CRTLIB) command:
  - For basic ASPs specify:  
`CRTLIB LIB(library-name) ASP(asp-number)`
  - For independent ASPs specify:  
`CRTLIB LIB(library-name) ASP(*ASPDEV) ASPDEV(asp-device-name)`

**Note:** The new library must have the same name as the library in which the journal was originally located.

9. Place the system in a restricted state: ENDSBS \*ALL \*IMMED
10. Restore the user profiles you saved in step 1 on page 388:  
`RSTUSRPRF USRPRF(*ALL) DEV(TAP01)`
11. Restore the journal to the library in the user ASP using the Restore Object (RSTOBJ) command. For independent ASPs, specify the RSTASPDEV parameter.
12. Restore the previously journaled objects to the library or directory in the user ASP. If you want to restore the previously journaled objects to their original libraries or directories, you must first move those libraries or directories to the user ASP. You move libraries and directories to a different ASP by saving them, deleting them, and restoring them to the new ASP.  
 Restoring the previously journaled objects automatically resumes journaling for the objects if the journal already exists.
13. Restore the private authorities you saved in step 1 on page 388:  
`RSTAUT`
14. Save the journaled objects so that the journaled changes can be applied, if necessary. When journaling starts, the system assigns a journal identifier (JID) to the object. Usually the JID that is assigned is the same JID that the object had when it was saved. The object must be saved after the JID is assigned.

## How to Create Objects in a Library User ASP

You create an object in a specific ASP by placing it in a library or folder that is in the ASP. You place a library or a folder in an ASP in one of the following ways:

- Specify a value for the ASP parameter on either the CRTLIB command or the CRTFLR command. The default for the ASP parameter is 1. For independent ASPs, you must also specify the ASP device name in the ASPDEV parameter.
- Restore the library or the folder to a specific ASP by using the RSTASP parameter on the restore command.

integrated file system objects can reside in a user ASP through the use of User-defined file systems (UDFS) by doing the following:

1. Create a user defined file system in the ASP.
2. Mount the UDFS over another directory and use it through the mounted-over path.

For more information about User-defined files systems, see the Information Center at the following Web site:

<http://www.ibm.com/eserver/iseres/infocenter>

## Placing a Document in a Basic ASP—Example

The following is an example of placing a document in a specific basic ASP:

1. To create a folder in a basic ASP, use the ASP parameter on the CRTFLR command:  
`CRTFLR FLR(ASP3FLR) ASP(3)`
2. To create a document in that folder, use the CRTDOC command or a program that creates documents.

When you create a document or another folder in ASP3FLR, the new document or folder is automatically placed in ASP 3.

When you create the first folder in a basic ASP, the system creates the corresponding library. For example, when you create the ASP3FLR folder, the system creates the QDOC0003 library if it does not already exist. You should never create a QDOCnnnn library yourself. This can cause unpredictable results.

## Placing an Object in a User ASP—Example

The following is an example of placing a journal receiver in a specific user ASP:

1. Create a library for the journal receiver:
  - For basic ASPs, specify:  
`CRTLIB LIB(ASP2LIB) ASP(2)`
  - For independent ASPs, specify:  
`CRTLIB LIB(library name) ASP(*ASPDEV) ASPDEV(asp-dev-name)`
2. If the journal receiver is being placed in an independent ASP, use the Set ASP Group (SETASPGRP) command to associate the job with the correct independent ASP.
3. Create the journal receiver in the library that you created in the user ASP:  
`CRTJRNRCV JRNRCV(ASP2LIB/RCVINASP2)`

## Creating a UDFS in User ASP—Example

The following is an example of creating a UDFS in a user ASP using the Create User-Defined File System (CRTUDFS) command and the Add Mounted File System (MOUNT) command.

1. Create a user-defined file system in ASP 2. All objects created in this new file system will also reside in ASP 2:  
`CRTUDFS UDFS('/dev/qasp02/asp2dir.udfs')`
2. Mount the user-defined file system over directory '/myLocalPath':  
`MOUNT TYPE(*UDFS) MFS('/dev/qasp02/asp2dir.udfs') MNTOVRDIR('/myLocalPath')`
3. Create a directory in the user-defined file system:  
`CRTDIR DIR('/myLocalPath/newDir')`

## How to Place Journal Receivers in a User ASP

Placing journal receivers in a user ASP may improve your system performance. Dedicating a user ASP to the journal receivers for a single journal is the recommended approach. Placing journal receivers in a library user ASP simplifies recovery. Following are the procedures for placing journal receivers in both a library user ASP and a nonlibrary user ASP.

## Placing Journal Receivers in a Library User ASP

The following procedure uses the example of the CUSTJRN journal and journal receivers that use the naming convention CUSTRnnnn.

1. Create a library for the journal receiver in the desired user ASP:
  - For a basic ASP, specify:  
`CRTLIB LIB(CUSTJRNR) ASP(4)`
  - For an independent ASP, specify:  
`CRTLIB LIB(CUSTJRNR) ASP(*ASPDEV) ASPDEV(asp-dev-name)`



2. Use the WRKJRNA command to find the name of the currently attached journal receiver: WRKJRNA JRN(CUSTJRN/CUSTJRN). For the example, assume the currently attached journal receiver is CUSTR0005.
3. Use F17 (Display attributes) to determine the attributes for the current receiver.
4. If the journal receiver is being placed in an independent ASP, use the Set ASP Group(SETASPGRP) command to associate the job with the correct independent ASP.
5. Create a new journal receiver in the library that is in the user ASP. Use a name that continues your naming convention. Specify the attributes that you displayed. For example, if the threshold of the current receiver is 100000, you would specify the following:  
CRTJRNRCV JRNRCV(CUSTJRN/CUSTR0006) THRESHOLD(100000)
6. Change journal receivers so the new journal receiver is attached and actively receiving journal entries:  
CHGJRN JRN(CUSTJRN) JRNRCV(CUSTJRN/CUSTR0006)
7. You can save the detached journal receiver and delete it from the system.
8. In the future, when you change journal receivers and specify JRNRCV(\*GEN), the system will create the new journal receiver in the CUSTJRN library in ASP 4.

## How to Move Journal Receivers From an Overflowed Basic User ASP

To maintain journaling for the objects, do the following steps:

1. Use the WRKJRNA command to determine the names of the journal receivers associated with the journal: WRKJRNA JRN(*library-name/journal-name*)
2. Use F17 to display the attributes of the receiver that is attached.
3. If the journal receiver to be moved is attached to a journal, create a new journal receiver on a different ASP by using the CRTJRNRCV command. Assume the currently attached receiver is CUSTR0005. Use a name for the journal receiver that continues your naming conventions.  
If the journal receiver is in a library user ASP, do the following:
  - a. Create a new library in a different ASP, such as LIBJNEW: CRTLIB LIB(LIBJNEW) ASP(4)
  - b. Create a new journal receiver in the library. Specify the attributes that you displayed. For example, if the threshold of the current receiver is 100000, you would specify the following:  
CRTJRNRCV JRNRCV(LIBJNEW/CUSTR0006) THRESHOLD(100000)
 If the journal receiver is in a nonlibrary user ASP, create a new journal receiver in a different nonlibrary user ASP or in the system ASP: CRTJRNRCV JRNRCV(CUSTJRN/CUSTR0006) ASP(5)
4. Change the journal by using the Change Journal (CHGJRN) command. Specify the newly created journal receiver on the JRNRCV parameter: CHGJRN JRN(CUSTJRN/CUSTJRN) JRNRCV(*library-name/CUSTR0006*)
5. Save the journal receivers from the overflowed user ASP. If the journal receivers are the only objects in the library, use the Save Library (SAVLIB) command. If other objects are in the library, use the Save Object (SAVOBJ) command.
6. If you used the SAVLIB command in step 5, delete the library from the overflowed user ASP by using the DLTLIB command. If you used the SAVOBJ command, delete the journal receivers using the DLTJRNRCV command.
7. Journal receivers can be restored only to the library from which they were saved. The steps required to restore these journal receivers if you need them for a recovery depend on whether they were in a library user ASP or a nonlibrary user ASP. For journal receivers in a nonlibrary user ASP, you can restore them to any ASP, as long as their library is in the system ASP. For libraries that were in a library user ASP, you must ensure that the ASP has adequate space before restoring the journal receivers to the library.

## How to Reset a Journal with a Status of Overflowed

If a journal object has a status of overflowed, you must delete it and restore it to reset its status.

**Note:** Use the DSPOBJD command to determine whether a specific object in a library has a status of overflowed. Use the DSPLNK command and select option 8 to determine whether a specific object in a directory has a status of overflowed.

Because journals and journaled objects must be in the same ASP, the best method for dealing with an overflowed journal is to restore it to the same basic ASP. If you restore the journal to a different ASP, you must also move all the journaled objects to that ASP.

This topic describes the procedure for restoring a journal to the same ASP to reset its overflowed status. If you want to move the journal and journaled objects to a different ASP, follow the procedure in “How to Transfer Journals and Objects to a Different ASP” on page 388.

Before beginning this procedure, ensure that you have freed enough space in the overflowed ASP to prevent the journal from overflowing when it is restored.

1. Use the WRKJRNA command to print information about journaled objects and the receiver directory:  
`WRKJRNA JRN(library-name/journal-name) OUTPUT(*PRINT).`
2. Use the SAVOBJ command to save the journal that must be reset.
3. Save the journal receivers that are associated with the journal by using the Save Object (SAVOBJ) command.
4. End journaling for any objects being journaled as follows
  - a. Access paths:  
`ENDJRNAP JRN(library-name/journal-name) FILE(*ALL)`
  - b. Physical database files:  
`ENDJRNPF JRN(library-name/journal-name) FILE(*ALL)`
  - c. integrated file system objects:  
`ENDJRN OBJ(*ALL) JRN('QSYS.LIB/library-name.LIB/journal-name.JRN')`
  - d. All other object types:  
`ENDJRNOBJ OBJ(*ALL) OBJTYPE(*ALL) JRN(library-name/journal-name)`
5. Deactivate any remote journals that are associated with the journal by using the Change Journal State (QjoChangeJournalState) API or the CHGRMTJRN command.
6. Delete the journal: `DLTJRN JRN(library-name/journal-name).`
7. Restore the journal to the same library and the same ASP. If the journal was in library user ASP, you do not need to specify the ASP parameter on the RSTOBJ command. If the journal was in a nonlibrary user ASP, specify `RSTASP(*SAVASP)` on the RSTOBJ parameter.
8. Start journaling again for each object that was journaled as follows:
  - a. Database physical files:  
`STRJRNPF FILE(library-name/file-name) JRN(library-name/journal-name)`
  - b. Access paths:  
`STRJRNAP FILE(library-name/file-name) JRN(library-name/journal-name)`
  - c. integrated file system objects:  
`STRJRN OBJ('object-path-name')`  
`JRN('/QSYS.LIB/library-name.LIB/journal-name.JRN')`
  - d. All other object types:  
`STRJRNOBJ OBJ(library-name/file-name) OBJTYPE(object-type)`  
`JRN(library-name/journal-name)`

You printed a list of objects in step 1.

9. Reestablish the journal receiver chain. Do the following:
  - a. Type WRKJRN and press the Enter key.
  - b. On the prompt display, type the name of the journal and the library.

- c. On the Work with Journals display, select option 9 (Associate receivers with journal).
  - d. When you receive a message that the receivers have been associated, press F12 to return.
  - e. Type the following:  

```
WRKJRNA JRN(library-name/journal-name)
```
10. Use the DSPOBJD command to display the object description for the journal. Ensure that the journal is no longer in overflowed status.

---

## How to Work with Nonlibrary User ASPs

This topic describes the procedures for working with objects in a nonlibrary user ASP. The object types that are allowed in a nonlibrary user ASP are:

- Journal
- Journal receiver
- Save file

## Creating Objects in a Nonlibrary User ASP

You can create journals, journal receivers, and save files in nonlibrary user ASPs. When you create an object in a nonlibrary user ASP, the library for the object must exist in the system ASP. For example, to create a save file in a nonlibrary user ASP, do the following:

```
CRTSAVF FILE(SAVFLIB/DSTSAV) ASP(4)
```

where 4 is the number of the user ASP where you are placing the save file. The library for the save file is in the system ASP and ASP 4 does not contain any libraries.

After the object is created, all storage for the object resides in the designated user ASP. Changes and additions to that object are also made in the user ASP. If the ASP becomes full, it overflows into the system ASP. Chapter 19, “Working with Auxiliary Storage Pools,” on page 375 describes how to reset an overflowed auxiliary storage pool.

It is recommended that all journals and journal receivers on the system have unique names. RCLSTG renames them if duplicate names are found when objects are placed in library QRCL and the user cannot rename them to their original name.

Monitor the size of objects to prevent them from overflowing into the system ASP with the MAXRCDS parameter on the CRTSAVF command, and the THRESHOLD parameter on the CRTJRNRCV command.

## Transferring an Object to a Nonlibrary User ASP

The following procedure shows an example of moving an object to a nonlibrary user ASP. In the example, the DSTSAVF save file is moved to ASP 4. The library (SAVFLIB) for the DSTSAVF is in the system ASP. You can use this procedure only for save files, journals, and journal receivers.

1. Display private authorities for the save file: `DSPOBJAUT OBJ(SAVFLIB/DSTSAVF) OBJTYPE(*SAVF) OUTPUT(*PRINT)`
2. Save the save file: `SAVOBJ OBJ(SAVFLIB/DSTSAVF) OBJTYPE(*SAVF) DEV(TAP01)`

**Note:** If you want to save the data in the save file, specify `SAVFDTA(*YES)`.

3. Delete the save file: `DLTSAVF SAVF(SAVFLIB/DSTSAVF)`
4. Restore the save file to ASP 4: `RSTOBJ OBJ(SAVFLIB/DSTSAVF) RSTASP(4)`
5. Use the Edit Object Authority (EDTOBJAUT) command to reestablish the private authorities you printed in step 1.

## Transferring a Journal to a Nonlibrary User ASP

Use the following procedure to move a journal to a different nonlibrary basic user ASP and to reassociate any previously journaled objects with that journal.

1. Sign on as QSECOFR.
2. Save the journal with either the SAV, SAVOBJ, or SAVLIB command.
3. List the objects being journaled: `WRKJRNA JRN(library-name/journal-name) OUTPUT(*PRINT)`
4. Copy private authorities for the journal to a temporary object.
  - a. Create a temporary object:

```
CRTDTAARA DTAARA(QTEMP/X)
          TYPE(*CHAR)
          AUT(*EXCLUDE)
```
  - b. Make sure that there are no authorities to the temporary object:

```
RVKOBJAUT OBJ(QTEMP/X) OBJTYPE(*DTAARA)
          USER(QSECOFR) AUT(*ALL)
```
  - c. Copy the authorities from the journal to the temporary object:

```
GRTOBJAUT OBJ(QTEMP/X) OBJTYPE(*DTAARA)
          REFOBJ(library-name/journal-name)
          REFOBJTYPE(*JRN)
```
5. Stop journaling access paths for the journal: `ENDJRNAP FILE(*ALL) JRN(library-name/journal-name)`
6. Stop journaling physical files for the journal: `ENDJRNPF FILE(*ALL) JRN(library-name/journal-name)`
7. Stop journaling integrated file system objects: `ENDJRN OBJ(*ALL) JRN('/QSYS.LIB/library-name.LIB/journal-name.JRN')`
8. Stop journaling all other object types for the journal: `ENDJRNOBJ OBJ(*ALL) OBJTYPE(*ALL) JRN(library-name/journal-name)`
9. Deactivate any remote journals that are associated with the journal by using the Change Journal State (QjoChangeJournalState) API or the CHGRMTJRN command.
10. Delete the journal with the DLTJRN command.
11. Restore the journal to the user ASP: `RSTOBJ OBJ(journal-name) OBJTYPE(*JRN) RSTASP(asp-number)`
12. Use the STRJRNPF, STRJRNAP, STRJRNOBJ, and STRJRN commands to resume journaling for any previously journaled objects. Refer to the list you printed in step 3.
13. Reestablish private authorities to the journal.
  - a. Copy authorities from the temporary object to the journal.

```
GRTOBJ OBJ(library-name/journal-name)
          OBJTYPE(*JRN) REFOBJ(QTEMP/X)
          REFOBJTYPE(*DTAARA)
```
  - b. Delete the temporary object. `DLTDTAARA QTEMP/X`

## Placing Journal Receivers in a Nonlibrary Basic ASP

The following procedure also uses the example of the CUSTJRN journal and journal receivers that use the naming convention CUSTRnnnn. This example assumes that the library for the journal receiver (CUSTJRNR) already exists in the system ASP.

1. Use the WRKJRNA command to find the name of the currently attached journal receiver: `WRKJRNA JRN(CUSTJRNR/CUSTJRN)`. For the example, assume that the currently attached journal receiver is CUSTR0005.
2. Use the Display Journal Receivers Attributes (DSPJRNRCVA) command to determine the attributes for the current receiver: `DSPJRNRCVA JRNRCV(CUSTJRNR/CUSTR0005)`
3. Create a new journal receiver in a user ASP. Use a name that continues your naming convention. Specify the attributes that you displayed, such as the threshold:

```
CRTJRNRCV JRNRCV(CUSTJRNR/CUSTR0006) ASP(4)
          THRESHOLD(100000)
```
4. Change journal receivers so the new journal receiver is attached and actively receiving journal entries:

CHGJRN JRN(CUSTJRN) JRNRCV(CUSTJRNR/CUSTR0006)

5. You can save the detached journal receiver and delete it from the system.
6. In the future, when you change journal receivers and specify JRNRCV(\*GEN), the system will create the new journal receiver in the CUSTJRNR library in ASP 4.



---

## Chapter 20. Working with Device Parity Protection

This chapter describes procedures for working with device parity protection on your system. When you are making changes to the disk configuration or disk protection on your system, you need to perform tasks in the correct sequence. Refer to “Choosing the Right Procedure for Configuring Disks” on page 355 to determine the correct tasks for your situation.

---

### Starting Device Parity Protection

Usually, you start device parity protection when you attach a new disk subsystem to your system. Ideally, you should start device parity protection before you add the disk units to the software disk configuration. When you start device parity protection for disk units that are already being used, the system must move data off of the disk units to other disk units in the ASP in order to make space available for the parity data. The performance for starting device parity protection is much better if the system does not have to move data.

When you start device parity protection, the system does validity checking and moves data from the required units, if necessary. For some types of disk units, you or your service representative must perform tasks with the disk subsystem when you start device parity protection.

**Note:** If you plan to start device parity protection for disk units that are already part of your disk configuration, check the following before you start device parity protection.

- The configuration must be complete and no disk units can be missing in any ASPs that contain disk units that are to have device parity protection. This is because the system must move data off the disks that are to be protected to make room for parity information.
- The disk units that will become device-parity protected cannot be in an ASP that has mirrored protection active. If the disk units are in an ASP that has mirrored protection, you must stop mirrored protection before starting device parity protection.
- When you start device parity protection, you reduce the capacity of some of the disk units in the subsystem. The system must have sufficient storage in each affected ASP to make room for redundant parity data.

### How to Start Device Parity Protection for an Input/Output Adapter

This topic lists the rules and describes the procedure for starting protection on V5R2 and later IOAs:

- Maximum number of parity sets allowed: 8 (some adapters may support fewer parity sets)
- Maximum number of devices per parity set: 18
- | • Minimum number of devices per parity set: 3 for RAID 5
- | • Minimum number of devices per parity set: 4 for RAID 6
- All devices in a parity set must be the same capacity

The IOA starts the fewest number of parity sets needed to protect all the devices of the same capacity. For example, to protect 10 devices, it starts one parity set of ten devices. To protect 11 devices, it starts two parity sets: one parity set of seven devices and one parity set of four devices. You can use iSeries Navigator to optimize your parity sets for *availability*, *capacity*, *performance*, or *balanced* (a mixture of the two). For more information see **Systems management** —> **Disk management** —> **Disk pools** in the iSeries Information Center at <http://www.ibm.com/eserver/series/infocenter>.

### Displays May Differ

When you work with device parity protection, the displays you see may differ slightly from the displays in this book because of differences in disk subsystem requirements. The best way to ensure that you are running the correct step in each procedure is to refer to the titles of the displays.

1. From the Use Dedicated Service Tools (DST) menu, do the following:
  - a. Select option 4 (Work with disk units).
  - b. Select option 1 (Work with disk configuration) on the Work with Disk Units display.
  - c. Select option 5 (Work with device parity protection) on the Work with Disk Configuration display.
2. Select option 2 (Start device parity protection) on the Work with Device Parity Protection display and press the Enter key. You are shown the Start Device Parity Protection display. It lists all the disk unit subsystems for which you can start device parity protection.

```
                Start Device Parity Protection
Select the subsystems to start device parity protection.
Type choices, press Enter.
1=Start device parity protection
          Parity  Serial
Resource Option  Set  Number  Type  Model  Name
          1      2   3314025  6502  001   SI01
          -      1   0000318  9337  225   DD013
          -      -      -      -      -      -
```

3. Type a 1 in the *Option* column for the disk unit subsystems that you want to prepare to start device parity protection. Press the Enter key.  
If you are shown the following display, press Enter to continue.

```
                Confirm Continuation
In order to proceed the system must perform internal processing that may
take several minutes during which the system may appear inactive. Once you
confirm to continue, the system must perform an IPL when you leave Work with
Disk Configuration functions.

Press Enter to continue.
Press F12=Cancel to return to change your choice.
```

4. Press the Enter key to continue. You are shown the Confirm Starting Device Parity Protection display. The display shows all the disk unit subsystems that you have selected and the individual disk units that are eligible to be started. Disk units that have an asterisk (\*) in the *ASP* and *Unit* columns are not yet configured.



Confirm Starting Device Parity Protection During the preparation for starting device parity protection, data will be moved from parts of some disk units. This may take several minutes for each subsystem selected. Press Enter to continue. Press F12=Cancel to return and change your choice.

| Resource | Option | Parity |     |      | Serial     |      |       |       |
|----------|--------|--------|-----|------|------------|------|-------|-------|
|          |        | Set    | ASP | Unit | Number     | Type | Model | Name  |
|          | 1      | 2      |     |      | 3314025    | 6502 | 001   | SI01  |
|          | 1      | 2      | *   | *    | 00-0051556 | 6603 | 074   | DD056 |
|          | 1      | 2      | *   | *    | 00-0020525 | 6603 | 074   | DD025 |
|          | 1      | 2      | *   | *    | 00-0024030 | 6603 | 074   | DD030 |
|          | 1      | 2      | *   | *    | 00-0013026 | 6603 | 074   | DD026 |
|          | 1      | 2      | *   | *    | 00-0024519 | 6603 | 074   | DD019 |
|          | 1      | 2      | *   | *    | 00-0046338 | 6603 | 074   | DD038 |

- Notice:** At this point, pressing the Enter key initiates the procedure for starting device parity protection. Once begun, this procedure continues to run until it is complete. If the subsystems that you have selected are correct, press the Enter key to continue. The status display shows how the operation is proceeding. When the system has completed its preparation for starting device parity protection on the selected subsystems, the following display is shown.

```

Start Device Parity Protection Status
The operation to start device parity protection will be done in several
phases. The phases are listed here and the status will be indicated when
known.
Operation                                     Status
Initialize disk units . . . . . : Running
Prepare to start . . . . . : _____
Start device parity protection . . . . . : ___ %

```

- Press the Enter key to return to the Work with Device Parity Protection menu.

## Stopping Device Parity Protection

When preparing to stop device parity protection, the system does validity checking to make sure that stopping device parity protection does not leave the system in a configuration that is not supported. The following restrictions apply when you stop device parity protection:

- You cannot stop device parity protection on a subsystem when a unit in that subsystem is in a mirrored ASP. In order to stop device parity protection, mirrored protection must be stopped first.

## How to Stop Device Parity Protection on an Input/Output Adapter

The following instructions only apply to IOAs that support device parity protection.

- If you are not already using DST, perform a manual IPL to start DST. See “How to Start Dedicated Service Tools (DST)” on page 366.
- From the Use Dedicated Service Tools (DST) menu, do the following:
  - Select option 4 (Work with disk units).
  - Select option 1 (Work with disk configuration) on the Work with Disk Units display.
  - Select option 5 (Work with device parity protection) on the Work with Disk Configuration display.
- Select option 3 (Stop device parity protection) on the Work with Device Parity Protection display and press the Enter key. The following display is shown.

```

                Stop Device Parity Protection
Select the subsystems to stop device parity protection.
Type choices, press Enter.
1=Stop device parity protection
                Parity Serial
Resource Option  Set  Number  Type  Model  Name
                1    1  10-4453031  6502  001  SI01
                2    2  00-00341   9337  212  DC09

```

4. Type a 1 in the *Option* column for the disk unit subsystems that you want to stop device parity protection. Press the Enter key. The following display is shown.

```

                Confirm Stop Device Parity Protection
Warning: Disk units connected to these subsystems will not be protected
after you confirm your choices.
Press Enter to continue.
Press F12=Cancel to return and change your choices.
                Parity Serial
Resource Option  Set  ASP  Unit  Number  Type  Model  Name
                1    1          10-4453031  6502  001  SI01
                1    1    8    3  00-0334602  6602  050  DD012
                1    1    8    4  00-0334673  6602  050  DD011
                1    1    8    5  00-0231915  6602  050  DD010
                1    1    8    6  00-0334610  6602  050  DD009
                1    1    8    7  00-0274937  6602  050  DD008

```

5. **Notice:** At this point, pressing the Enter key initiates the procedure for stopping device parity protection. Once this procedure has begun, you may not cancel it. If the subsystems you have selected are correct, press the Enter key to continue. You will get status screens.

```

                Stop Device Parity Protection Status
The operation to stop device parity protection will be done in several
phases. The phases are listed here and the status will be indicated when
known.
Operation                               Status
Prepare to stop . . . . . : Completed
Stop device parity protection . . . . . : Completed
WARNING: There are now unprotected disk units on this system. When a system
has unprotected, exposed, or suspended disk units attached to it, disk related
failures may affect the availability of the system and can cause loss of data.

```

**Note:** If you have not yet received "Completed" status you can press F16 to return to the Use Dedicated Service Tools (DST) menu if you have other tasks to perform. However, you cannot perform any disk configuration tasks or end DST until the system has finished starting device parity protection.

6. When the status shows Completed, press the Enter key to return to the Work with Device Parity Protection menu.

---

## How to Remove Disk Units that have Device Parity Protection for an iSeries™ server with the system powered on

1. If possible, use a wrist strap to prevent electrostatic discharge from damaging your hardware. If you do not have a wrist strap, touch a metal surface of the system or expansion unit before installing or replacing hardware.
  - If you received the 2209 Disposable Wrist Strap, follow these steps:
    - a. Attach the disposable wrist strap.
    - b. When you unroll the strap, remove the liner from the copper foil at the end.

- c. Attach the adhesive part of the copper foil to an **exposed, unpainted** metal surface on the frame of the unit.

**Note:** Follow the same precautions you would use without the wrist strap. The 2209 Disposable Wrist Strap is for static control. It will not increase or decrease your risk of receiving electric shock when using or working on electrical equipment.

2. Find the Disk unit locations for your system unit or your expansion unit.
3. Remove the disk unit cover. Squeeze the latch and pull out.

**Note:** iSeries 825 does not have disk unit covers.

4. Be sure you are signed on with **at least service level authority**.
5. Type **strsst** on the command line of the i5/OS session and press Enter.
6. Type **your service tools user ID and service tools password** on the System Service Tools (SST) Sign On display. Press Enter.

**Note:** The service tools password is case sensitive.

7. Select **Start a service tool** from the System Service Tools (SST) display. Press Enter.
8. Select **Hardware service manager** from the Start a Service Tool display. Press Enter.
9. Select **Device Concurrent Maintenance** from the Hardware Service Manager display. Press Enter.
10. Type the **Physical Location** (Frame ID and position) where you will be replacing the disk unit.

**Note:** The physical location of the disk unit to be replaced should have been provided by customer support.

In this example, Physical Location: Frame ID 1\_\_\_\_ Position D06\_\_\_\_ , you would install a disk unit in frame 1 (base system), disk unit position 6.

11. Select option 1 (Remove device) for the action to be performed.
12. Set the time delay for one minute—01. **Do not press Enter at this time.**

**Note:** Locate the light in the numbered arrow by the disk unit you are replacing. When you press Enter, after a one minute delay, this light comes on and begins to blink rapidly. You then have nine seconds to slide the disk unit into place.

13. Press Enter on the console.
14. When the light starts blinking, squeeze and pull the handle of the disk unit out toward you before you remove the disk unit. If the handle is not all the way out, the disk unit will not slide out of the system.
15. Support the bottom of the disk unit assembly as you slide it completely out. Do not hold the disk unit by the handle.
16. The light will stop blinking and remain off when the disk unit is removed.
17. Return to the console and wait until the Concurrent Maintenance Results display appears. Press **F12**.
18. Find the package that contains the new disk unit assembly and remove it from the static-protective package.

**Attention:** Disk units are fragile. Handle with care.

19. Unlock the handle by squeezing and pulling it out toward you before you install the disk unit. If the handle is not all the way out, the disk unit will not slide into the system unit or the expansion unit.
20. Support the bottom of the disk unit assembly as you slide it half way into the system unit or the expansion unit. Do not push it any further.

**Note:** You install the disk units horizontally in the 7123, 7136, and 7137 disk unit enclosure.

21. The physical locations you entered in step 11 of this procedure may still appear on the display. If not, retype the **Physical Location** (Frame ID and position) where you will be installing the new disk unit. In this example, Physical Location: Frame ID 1\_\_\_\_ Position D06\_\_\_\_ , you would install a disk unit in frame 1 (base system), disk unit position 6.
  22. Select **option 2** (Install device) for the action to be performed.
  23. Set the time delay for one minute—01. **Do not press Enter at this time.**

**Note:** Locate the light in the numbered arrow by the disk unit you are replacing. When you press Enter, after a one minute delay, this light comes on and begins to blink rapidly. You then have nine seconds to slide the disk unit into place.
  24. Press Enter on the console.
  25. When the light starts blinking, slide the disk unit **all the way in** and then lock it in place by closing the latch.
  26. The light stops blinking and remains on when you have installed the disk unit properly.
  27. Return to the console and wait until the Concurrent Maintenance Results display appears. Press Enter.
  28. When the Hardware Service Manager display appears, press F3.
  29. Select **Work with Disk Units** on the System Service Tools display. Press Enter.
  30. Select **Work with disk unit recovery** on the Work with Disk Units display. Press Enter.
  31. Select **Rebuild disk unit data** on the Work with Disk unit recovery display. Press Enter.
  32. Select **1** to rebuild the disk unit displayed (disk unit displayed is the disk unit that you **removed**) on the Rebuild Disk Unit Data display. Press Enter.
  33. Press Enter on the Confirm Rebuild Disk Unit Data display. The rebuild process may take several minutes to complete.
  34. Install the disk unit covers. Align the tabs on the disk unit cover with the slots in the system unit. Push the cover in until it latches.
  35. Install or close the system unit or expansion unit front cover.
  36. Press F5 to refresh the display until the **Percent complete** shows 5%.
  37. When the display shows at least 5% complete, you can either continue to monitor this display to completion, or press F3 (Exit) to return to the Work with disk units display.
  38. Press F3 (Exit) to return to the System service tools display.
  39. Press F3 (Exit) to return to the exit SST display and press Enter.
- The replacement procedure is complete.

---

## How to remove disk units that have device parity protection for an iSeries™ server with the system powered off

1. Press F3 repeatedly to exit System Service Tools and return to the main menu.
2. Vary off the IXS:
  - a. Go to the Work with Configuration Status display by entering **WRKCFGSTS** at any command line. Press F4.
  - b. At the Work with Configuration Status display, enter **\*NWS** at the Type field and press Enter two times.
  - c. At the Work with Configuration Status display, select the **Vary off** option in the Opt column next to the IXS and press Enter.
  - d. Press F12 to return to the Main Menu.
3. Power down the system unit.

4. **If possible, use a wrist strap to prevent electrostatic discharge from damaging your hardware.** If you do not have a wrist strap, touch a metal surface of the system or expansion unit before installing or replacing hardware. If you received the 2209 Disposable Wrist Strap, follow these steps:
  - a. Attach the disposable wrist strap.
  - b. When you unroll the strap, remove the liner from the copper foil at the end.
  - c. Attach the adhesive part of the copper foil to an **exposed, unpainted** metal surface on the frame of the unit.

**Note:** Follow the same precautions you would use without the wrist strap. The 2209 Disposable Wrist Strap is for static control. It will not increase or decrease your risk of receiving electric shock when using or working on electrical equipment.

5. Remove the disk unit covers. Squeeze the latch and pull out.

**Note:** iSeries 825 does not have disk unit covers.

6. Locate the disk unit you want to replace.
7. Unlock the handle by squeezing it and pulling it out toward you before you remove the disk unit. If the handle is not all the way out, the disk unit will not slide out of the system.
8. Support the bottom of the disk unit assembly as you slide it completely out. Do not hold the disk unit by the handle.
9. Find the package that contains the new disk unit assembly and remove it from the static-protective package. Write the serial number (use the last 4 digits) of the disk unit here \_\_\_\_\_ before you install it.

**Attention:** Disk units are fragile. Handle with care.
10. Squeeze and pull the handle out toward you before you install the disk unit. If the handle is not all the way out, the disk unit will not slide into the system unit or the expansion unit. Do not hold the disk unit by the handle.
11. Make sure that the disk unit handle is fully extended when sliding into the system unit or the expansion unit. Support the bottom of the disk unit assembly as you slide it into the system unit or the expansion unit until it stops.
12. Close the disk unit handle firmly locking it into place.
13. Install the disk unit covers. Align the tabs on the disk unit enclosure cover with the slots on the system unit enclosure. Push the cover in until it latches.
14. Install or close the unit front cover.
15. **DANGER**

**An electrical outlet that is not correctly wired could place hazardous voltage on metal parts of the system or the products that attach to the system. It is the customer's responsibility to ensure that the outlet is correctly wired and grounded to prevent an electrical shock. (RSFTD201) Plug the following power cords into an electrical outlet.**

- System unit
- System unit console
- Expansion units

16. Plug in and power on all attached devices, such as printers and displays.
17. If your system unit is an iSeries 270, 800, or 810, go to step 20.
18. If your system unit is an iSeries 820, 825, 830, 840, 870 or 890, go to step 22.
19. Look at the Function/Data display on the control panel. Refer to System-unit control panel.
20. Does **01 B N V=S** appear in the Function/Data display?
  - \_ **Yes:** Go to step 24.
  - \_ **No:** Follow these steps:

- a. Press the Increment/Decrement push button until 02 appears in the Function/Data display
  - b. Press the Enter push button on the control panel.
  - c. Press the Increment/Decrement push button until B appears in the Function/Data display.
  - d. Press the Enter push button on the control panel.
  - e. Press the Increment/Decrement push button until N appears in the Function/Data display.
  - f. Press the Enter push button on the control panel.
  - g. Press the Increment/Decrement push button until S appears in the Function/Data display.
  - h. Press the Enter push button on the control panel.
  - i. Press the Increment/Decrement push button until 01 appears in the Function/Data display.
  - j. Press the Enter push button on the control panel. 01 B N S should appear in the Function/Data display. If it does not, repeat steps 21a through 21j.
  - k. Go to step 24
21. Look at the Function/Data display on the control panel.
22. Does **01 B V=S** appear in the Function/Data display and the Normal mode indicator (OK) illuminated?
- \_ **Yes:** Continue with the next step.
- \_ **No:** Do the following:
- a. Press the Mode Select button until the Normal mode indicator (**OK**) lights up.
  - b. Press the Increment/Decrement push button until **02** appears in the Function/Data display.
  - c. Press the Enter push button on the control panel.
  - d. Press the Increment/Decrement push button until **B** appears in the Function/Data display.
  - e. Press the Enter push button on the control panel.
  - f. Press the Increment/Decrement push button until **S** appears in the Function/Data display .
  - g. Press the Enter push button on the control panel
  - h. Press the Increment/Decrement push button until **01** appears in the Function/Data display.
  - i. Press the Enter push button on the control panel.
- 01 B S should appear in the Function/Display panel. If it does not appear, repeat steps 23a through 23i.
23. Press the Power push button that is located on the control panel. There is approximately a 10-second delay before the power-on light comes on, and data appears in the Function/Data display.
- Note:** The system takes several minutes to power on and complete an IPL. When the IPL is complete, the i5/OS signon display should appear on your system unit console.
24. Follow these steps to verify your disk unit configuration:
- a. Type **strsst** on the command line of the iSeries session and press Enter.
  - b. Select **Work with disk units** from the System Service Tools (SST) display. Press Enter.
  - c. Select **Work with disk unit recovery** from the Work with Disk Units display. Press Enter.
  - d. Select **Rebuild disk unit data** on the Work with Disk unit recovery display. Press Enter.
  - e. Select **1** to rebuild the disk unit displayed (disk unit displayed is the disk unit that you **removed**) on the Rebuild Disk Unit Data display. Press Enter.
  - f. Press Enter on the Confirm Rebuild Disk Unit Data display. The rebuild process may take several minutes to complete.
  - g. Install the disk unit covers. Align the tabs on the disk unit cover with the slots in the system unit. Push the cover in until it latches.
  - h. Install or close the system unit or expansion unit front cover.
  - i. Press F5 to refresh the display until the **Percent complete** shows 5%.

- j. When the display shows at least 5% complete, you can either continue to monitor this display to completion, or press F3 (Exit) to return to the Work with disk units display.
  - k. Press F3 (Exit) to return to the System service tools display.
  - l. Press F3 (Exit) to return to the exit SST display and press Enter.
- The replacement procedure is complete.

---

## How to remove disk units that have device parity protection for an eServer™ i5

1. Prepare to remove the disk drive from the system configuration.
  - a. Determine the protection status of the disk drive that you are replacing.
  - b. Unprotected disk drives must be replaced by a service provider. Before replacing the disk drive, the service provider must perform one of the following tasks:
    - Save data and initialize the disk drive.
    - Initialize the disk drive and copy to disk.
2. Locate the disk drive to be removed.
3. Stop the system or logical partition that controls the disk drive location.
4. If you stopped the logical partition, do not disconnect the power source. If you stopped the system, disconnect the power source from the system by unplugging the system.

### DANGER

**This system might be equipped with a second power supply. Before continuing with this procedure, ensure that all power sources to the system have been completely disconnected.**

5. Remove the system unit door or expansion unit door or open the rack front door.
6. Remove the front cover.
7. Unlock the disk drive handle by squeezing it and pulling it out toward you.

**Attention:** Attach a wrist strap to an unpainted metal surface of your hardware to prevent electrostatic discharge from damaging your hardware. When using a wrist strap, follow all electrical safety procedures. A wrist strap is for static control. It does not increase or decrease your risk of receiving electric shock when using or working on electrical equipment. If you do not have a wrist strap, just prior to removing the product from ESD packaging and installing or replacing hardware, touch an unpainted metal surface of the system for a minimum of 5 seconds.
8. Support the bottom of the disk drive as you slide it out of the system or expansion unit. Do not hold the disk drive by the handle.
9. If a disk drive filler is available, follow these steps:

**Note:** IBM® recommends that disk drive slots be refilled with either another disk drive or a disk drive filler. Filling the disk drive slot will help ensure proper air flow for cooling and help maintain optimal EMI compliance. Ordering feature 6598 results in four additional disk slot fillers being shipped.

- a. Attach the disk drive bezel to the filler.
  - b. Press in and then tighten the thumbscrew B to secure the bezel to the disk drive.
  - c. Install the disk drive filler in the system or expansion unit
10. Replace the front cover.
  11. Install or close the system, expansion unit or rack front door.
  12. Reconnect all system power cables.
  13. Reconnect the system to the power supply by plugging it in.
  14. Start the system or logical partition.
- To start a system that is not managed by an HMC, follow these steps:

- a. Before you press the power button on the control panel, ensure that power is connected to the system unit as follows:

**Note:** On the OpenPower™ 710 or model 9110-510, the power button is on the operations panel. All system power cables are connected to a power source. The power-on light F is slowly blinking. The top of the display D contains 01 V=F.

- b.

**Note:** The system attention light G does not appear on the control panel on the model 570.

- c. Press the power button A on the control panel.

**Note:** If pressing the power button does not start the system, use the Advanced System Management Interface (ASMI) to start the system. First, set up access to the ASMI

- d. Start the system using the ASMI.

- e. After pressing the power button, observe the following: The power-on light begins to blink visibly faster. The system cooling fans are activated after approximately 30 seconds and begin to accelerate to operating speed. Progress indicators, also referred to as checkpoints, appear on the control panel display while the system is being started. The power-on light on the control panel stops blinking and remains on, indicating that system power is on

Start the system using the Hardware Management Console

- a. In the navigation area, open **Server and Partition**.
- b. Select **Server Management**.
- c. In the contents area, open the server on which the partition profile is located.
- d. Open **Partitions**.
- e. Open the logical partition for the partition profile.
- f. Right-click the partition profile and select **Activate**.
- g. Select the partition profile you want to activate and click **OK**.

The replacement procedure is complete.

---

## How to include a disk unit in device parity protection

When you attach a new disk unit to an existing IOA that has device parity protection, you can include the disk unit in the device parity set. You can include a disk unit by using either DST or SST.

This topic lists the rules and describes the procedure for starting device parity protection for an IOA. The following are the basic rules for this type of IOA:

- Maximum number of parity sets allowed: 8 (some adapters may support fewer parity sets)
- Maximum number of devices per parity set: 18
- Minimum number of devices per parity set: 3 for RAID 5 protection
- Minimum number of devices per parity set: 4 for RAID 6 protection
- All devices in a parity set must be the same capacity

The devices will be included into an existing array. However, if enough devices exist to create a new array, the devices will be eligible for start but not include.

**Note:** You cannot include a disk unit if that disk unit has already been added to an ASP that has mirrored protection. **You must stop mirrored protection before including the disk unit.** Stopping mirrored protection must be done from the DST menu. Adding mixed protection on the same IOP requires mirroring to be stopped and restarted.

To include disk units in a device parity set, perform the following steps:



1. From the System Service Tools (SST) menu, do the following:
  - a. Select option 3 (Work with disk units).
  - b. Select option 2 (Work with disk configuration) on the Work with Disk Units display.
  - c. Select option 4 (Include unit in device parity protection) on the Work with Disk Configuration display.

or from the Use Dedicated Service Tools (DST) menu, do the following:

**Note:** If you are not already using DST, see “How to Start Dedicated Service Tools (DST)” on page 366.

- a. Select option 4 (Work with disk units).
- b. Select option 1 (Work with disk configuration) on the Work with Disk Units display.
- c. Select option 5 (Work with device parity protection) on the Work with Disk Configuration display.
- d. Select option 4 (Include unit in device parity protection) on the Work with Device Parity Protection display.

The Include Disk Units in Device Parity Protection display appears:

```

      Include Disk Units in Device Parity Protection
      Select the units to be included in Device Parity Protection.
      Type choices, press Enter.
      1=Include unit in device parity protection
      Parity      Serial
      Resource Option Set ASP Unit Number      Type Model Name
      1           1   8   7 00-0274937 6602  050 DD008
  
```

2. Select option 2 for RAID 5 parity protection. Or select option 6 for RAID 6 parity protection.
3. If the disk units that you selected are to be included in device parity protection, confirm this by pressing the Enter key. After the include operation has completed, the following display is shown.

```

      Include Disk Units in Device Parity Protection Status
      The operation to include units in the device parity protection will be done
      in several phases. The phases are listed here and the status will be indicated
      when known.
      Operation                               Status
      Prepare to include units . . . . . : Completed
      Include units . . . . . : Completed
  
```

**Note:** You can press F16 to return to the Use Dedicated Service Tools (DST) menu if you have other tasks to perform. However, you cannot perform any disk configuration tasks or end DST until the system has finished including disk units in device parity protection.

4. Press the Enter key to return to the Work with Device Parity Protection menu.

---

## How to Exclude a Disk Unit from Device Parity Protection

You can exclude a disk unit that is attached to an IOA from device parity protection. You cannot exclude a disk unit that has been assigned to an ASP that has mirrored protection. To exclude a disk unit from device parity protection, do the following.

1. If you are not already using DST, perform a manual IPL to start DST. See “How to Start Dedicated Service Tools (DST)” on page 366.
2. From the Use Dedicated Service Tools (DST) menu, do the following:
  - a. Select option 4 (Work with disk units).
  - b. Select option 1 (Work with disk configuration) on the Work with Disk Units display.

- c. Select option 5 (Work with device parity protection) on the Work with Disk Configuration display.
3. Select option 5 (Exclude unit from device parity protection) on the Work with Device Parity Protection display and press the Enter key. The following display is shown.

```

                Exclude Disk Units from Device Parity Protection
Select the units to be excluded from Device Parity Protection.
Type choices, press Enter.
1=Exclude unit from device parity protection
                Parity      Serial
Resource Option  Set ASP Unit Number   Type Model  Name
                1      1   8   7 00-0274937 6602  070  DD008

```

This display shows only disk units that are eligible to be excluded. A disk unit is eligible to be excluded if it does not contain parity information. If the disk units that you want to remove are not eligible to be excluded, you must stop device parity protection instead. Then physically remove the disk units and restart device parity protection.

4. Type a 1 in the *Option* column for the disk units that you want to exclude from device parity protection and press the Enter key. The following display is shown.

```

                Confirm Disk Units to be Excluded
Press Enter to confirm your choice to have the system exclude the selected
units from device parity protection
Press F12=Cancel to return to change your choice
                Parity      Serial
Resource Option  Set ASP Unit Number   Type Model  Name
                1      1   8   7 00-0274937 6602  050  DD008

```

5. If the disk units you selected are to be excluded from device parity protection, confirm this by pressing the Enter key. After the exclude operation has completed, the following display is shown.

```

                Exclude Disk Units in Device Parity Protection Status
The operation to exclude units from the device parity protection will be done
in several phases. The phases are listed here and the status will be indicated
when known.
Operation                               Status
Prepare to exclude units . . . . . : Completed
Exclude units . . . . . : Completed

```

**Note:** You can press F16 to return to the Use Dedicated Service Tools (DST) menu if you have other tasks to perform. However, you cannot perform any disk configuration tasks or end DST until the system has finished excluding disk units in device parity protection.

6. Press the Enter key to return to the Work with Device Parity Protection menu.

---

## How to Display Device Parity Status

To display device parity status, do the following:

1. From the System Service Tools (SST) menu, do the following:
  - a. Select option 3 (Work with disk units).
  - b. Select option 1 (Display disk configuration) on the Work with Disk Units display.

or from the Use Dedicated Service Tools (DST) menu, do the following:

  - a. Select option 4 (Work with disk units).
  - b. Select option 1 (Work with disk configuration) on the Work with Disk Units display.
  - c. Select option 1 (Display disk configuration) on the Work with Disk Configuration display.

- d. Select option 1 (Display disk configuration status) on the Display Disk Configuration display. The Display Disk Configuration menu appears.
2. Select option 5 (Display device parity status) on the Display Disk Configuration display and press the Enter key. The Display Device Parity Status display appears:

| Display Device Parity Status |     |      |               |      |       |       |        |
|------------------------------|-----|------|---------------|------|-------|-------|--------|
| Parity                       | ASP | Unit | Serial Number | Type | Model | Name  | Status |
| Resource Set 1               |     |      | 10-4251006    | 6502 | 001   | SI01  |        |
|                              | *   | *    | 00-0128330    | 6602 | 074   | DD055 | Active |
|                              | *   | *    | 00-0238703    | 6602 | 070   | DD053 | Active |
|                              | *   | *    | 00-0162516    | 6602 | 074   | DD052 | Active |
|                              | *   | *    | 00-0186325    | 6602 | 074   | DD051 | Active |
|                              | *   | *    | 00-0103706    | 6602 | 074   | DD050 | Active |
| Resource Set 2               |     |      | 00-00341      | 9337 | 212   | DC12  |        |
|                              | *   | *    | 00-7000341    | 9337 | 212   | DD015 | Active |
|                              | *   | *    | 00-5000341    | 9337 | 212   | DD034 | Active |
|                              | *   | *    | 00-3000341    | 9337 | 212   | DD033 | Active |
|                              | *   | *    | 00-2000341    | 9337 | 213   | DD012 | Active |
|                              | *   | *    | 00-1000341    | 9337 | 212   | DD011 | Active |

\* - See help for more information  
 Press Enter to continue. F3=Exit F5=Refresh  
 F11=Display disk hardware status F12=Cancel

The display is organized by device parity set. It includes controllers that can support device parity protection and all of the disk units that have the hardware capability for device parity protection. The possible values for the *Status* column are the following:

**Active** This unit is part of a disk unit subsystem that has device parity protection. This unit is fully operational.

**Failed** This unit is part of a disk unit subsystem that has device parity protection. This unit has failed. If another unit in the disk unit subsystem fails, data could be lost.

**% Rebuilt**

This unit is part of a disk unit subsystem that has device parity protection. The data on this unit is being rebuilt from other units in the disk unit subsystem.

**Unprotected**

This unit is part of a disk unit subsystem that has device parity protection. This unit is operational. However, another unit in the disk unit subsystem has failed or is being rebuilt. If another unit in the disk unit subsystem fails, data could be lost.

**% Resyncing**

The parity for the parity set is being built from the data within the disk unit subsystem.



---

## Chapter 21. Working with Mirrored Protection

This chapter describes how to start and stop mirrored protection. It also describes the rules that apply when you set up a mirrored ASP.

---

### Mirrored Protection–Configuration Rules

The following rules apply to mirrored configurations:

- Mirrored protection is configured by ASP number. The system configures the two units of a mirrored pair within an ASP.
- Mirrored protection requires an even number of storage units for each size of disk unit in the ASP that is being mirrored. An uneven number of storage units for any size of disk unit prevents mirrored protection from starting. This requirement does not apply to disk units that have device parity protection.
- The system attempts to assign the two storage units of a mirrored pair so that a failed unit can be repaired while the system continues to use the other mirrored unit. For a hardware configuration where this is not possible, the repair of the failing unit must be delayed until the system can be powered down. This may be true for a failing mirrored unit which is sharing the same controller or I/O processor as its mirrored unit.
- Standard DASD mirroring support requires that the mirrored units are at specific input and output addresses on the system. (For Version 3 Release 6, you can override this restriction with a patch.) Both units in the pair must be attached to the multi-function IOP because the system must be able to perform an IPL from either unit. Therefore, the system attempts to assign the mirrored units for unit 1 of the system ASP first. If you are mirroring the system ASP, mirrored protection does not start if valid mirrored units for unit 1 cannot be found.

**Note:** Remote mirroring support removes this requirement and provides IOP-level or bus-level protection.

---

### How to Start Mirrored Protection

You start mirrored protection for a specific ASP on your system. Before you attempt to start mirrored protection, you should ensure that the ASP meets the requirements that are described in “Mirrored Protection–Configuration Rules.” If you are performing several disk configuration and disk protection tasks, refer to Chapter 18 to determine the correct sequence of steps for your situation.

To start mirrored protection, do the following:

**Logical partitioning users:** If you perform an IPL on the primary partition, the secondary partitions will power down. If there is any activity on the secondary partitions when this occurs, the next IPL may be abnormal. You should power off all secondary partitions before starting mirroring on the primary partition.

1. If you are not already using DST, perform a manual IPL to start DST. See “How to Start Dedicated Service Tools (DST)” on page 366.
2. From the Use Dedicated Service Tools (DST) menu, do the following:
  - a. Select option 4 (Work with disk units).
  - b. Select option 1 (Work with disk configuration) on the Work with Disk Units display.
  - c. Select option 4 (Work with mirrored protection) on the the Work with Disk Configuration display.
3. Select option 2 (Start mirrored protection) on the Work with Mirror Protection display.

Select ASP to Start Mirrored Protection

Select the ASPs to start mirrored protection on.

Type options, press Enter

1=Select

| Option | ASP | Protection  |
|--------|-----|-------------|
| 1      | 1   | Unprotected |
| 1      | 2   | Unprotected |

4. Select the ASP or ASPs to be mirrored on the Select ASP to Start Mirrored Protection display and press the Enter key.

You may see the following display:

Press the Enter key to continue.

Confirm Continuation

To proceed, the system must perform directory recovery, which may take a significant amount of time. The system may appear inactive during this time.

Press Enter to continue. Press F12=Cancel to return and change your choices.

5. The system shows a confirmation display of the new mirrored protection configuration, including the levels of protection. Notice that half of the previous unit numbers for units being mirrored in the ASP no longer exist. The storage units for those unit numbers have been paired with the storage units for the remaining unit numbers to make mirrored pairs. Also notice that device parity units in the ASP have not been affected.

Confirm Start Mirrored Protection

Press Enter to confirm your choice to start mirrored protection. During this process the system will be IPLed. You will return to the DST main menu after the IPL is complete. The system will have the displayed protection.

Press F12 to return to change your choice.

| ASP | Unit | Serial Number | Type | Model | Resource Name | Protection    |
|-----|------|---------------|------|-------|---------------|---------------|
| 1   | 1    | 00-48519      | 6606 | 030   | DD010         | Unprotected   |
| 2   | 2    | 00-1000341    | 9337 | 211   | DD012         | Unprotected   |
|     |      | 00-5000341    | 9337 | 211   | DD015         | Mirrored      |
|     |      | 00-0186325    | 6602 | 074   | DD019         | Disk Unit     |
|     |      | 00-0162516    | 6602 | 074   | DD025         | Disk Unit     |
|     |      | 00-0238703    | 6602 | 074   | DD052         | Device Parity |
|     |      |               |      |       |               | Device Parity |

6. If the configuration is what you had planned and you do not have other configuration changes to make, skip to step 7 on page 413

If the configuration is not what you had planned, for example, the level of protection is less, you have the following options:

- Verify that the correct ASP was selected. Verify that any new storage units have been added to the correct ASP.
- Determine if additional hardware is required to achieve the planned level of protection.
- Determine if the existing hardware needs to be connected differently to achieve the planned level of protection. Contact your technical support organization for assistance.
- Consider continuing the start mirrored protection process which will provide better availability than non-mirrored protection, rather than waiting until additional hardware arrives so that you can

achieve your planned level of protection. After you receive and install the additional hardware, use Table 62 on page 355 to determine the procedure for configuring your disk storage correctly. Even on very large systems, the tasks to stop mirroring, add units, and start mirrored protection can be done in several hours.

- Place the system in **Normal** mode and press the Enter key to accept the configuration. The system performs the first part of the process for starting mirrored protection. During that time, you are shown the Function Status display:  
The system updates the display periodically.

|                                            |              |
|--------------------------------------------|--------------|
| Function Status                            | 5 % Complete |
| You selected to start mirrored protection. |              |

**Note:** You can press F16 to return to the Use Dedicated Service Tools (DST) menu if you have other tasks to perform. However, you cannot perform any disk configuration tasks or end DST until the system has finished starting mirrored protection.

The system continues the start mirrored protection process in What the System Does When You Start Mirrored Protection without further operator intervention.

- After the system reaches the Command Entry display, you may want to create the QSYSMSG message queue to receive messages. If you have this message queue, the system sends certain critical messages to it. You can monitor the message queue with a program to make sure the messages are not missed.

## What the System Does When You Start Mirrored Protection

The following steps are performed by the system when mirrored protection is started.

- Data is moved off half of the storage units in the selected ASPs. This can take from a few minutes to a few hours, depending on the amount of data that must be moved.  
Objects that are created on a preferred unit may be moved to another unit. The preferred unit number may no longer exist when mirrored protection starts.
- New control information is written to disk, describing the new mirrored system configuration.
- After the data is moved and the control information is written, the system performs an IPL. However, when you start mirroring only on independent ASPs, the system does not perform an IPL.
- When the system reaches DST, the previously selected ASPs are mirrored, although the two storage units in the mirrored pairs are not yet synchronized.

If the keylock switch is in the Manual position, you have the option to perform other configuration changes or perform an IPL. If you do not have configuration changes to make, select the option to perform an IPL and press the Enter key.

If the keylock switch is in the Normal position, the system automatically continues the IPL.

- When the system continues the IPL past DST, the mirrored pairs are synchronized during storage management recovery. This can take a few hours, although this long recovery time only occurs when mirrored protection is first started, and not during every IPL on a mirrored system. The progress of the synchronization process is displayed and periodically updated on the control panel. The system will display the code SRC C6xx 4205 where xx indicates the completed percentage of the synchronization process. On very large systems, the entire start mirrored protection process can take up to approximately 8 to 10 hours.
- After storage management recovery is completed, the selected ASPs have mirrored protection.

---

## Mirrored Protection Configuration Errors

There can be no missing, active disk units **anywhere** in the configuration when mirroring is being started. Units with a status of missing must be powered, repaired, or replaced.

Starting mirrored protection can fail if there is insufficient storage available in the ASP to contain the current data in the ASP. The percentage that is used in the ASP must normally be less than half of the

ASP threshold. The exception to this occurs when the ASP contains device parity protected disk units that can allow starting mirrored protection with a greater percent used.

There must be sufficient storage units in the ASP for the system to create mirrored pairs. If you receive a message that indicates that the system cannot pair unit 1 or other units, review “Mirrored Protection–Configuration Rules” on page 411.

---

## How to Stop Mirrored Protection

When you stop mirrored protection, one unit from each mirrored pair becomes nonconfigured. Before you can stop mirrored protection for an ASP, at least one unit in each mirrored pair in that ASP must be present and not suspended. To control which mirrored unit of each pair becomes nonconfigured, you may suspend the storage units that you want to become nonconfigured. For units that are not suspended, the selection is automatic.

To stop mirrored protection, do the following:

1. If you are not already using DST, perform a manual IPL to start DST. See “How to Start Dedicated Service Tools (DST)” on page 366.
2. From the Use Dedicated Service Tools (DST) menu, do the following:
  - a. Select option 4 (Work with disk units).
  - b. Select option 1 (Work with disk configuration) on the Work with Disk Units display.
  - c. Select option 4 (Work with mirrored protection) on the Work with Disk Configuration display.
3. Select option 3 (Stop mirrored protection) on the Work with Mirror Protection display. You are shown the Select ASP to Stop Mirrored Protection display:

Select ASP to Stop Mirrored Protection

Select the ASPs to stop mirrored protection on.

Type options, press Enter  
1=Select

| Option | ASP | Protection |
|--------|-----|------------|
| 1      | 2   | Mirrored   |

4. Select the ASP or ASPs for which mirrored protection is to be stopped on the Select ASP to Stop Mirrored Protection display and press the Enter key. The Confirm Stop Mirrored Protection display is shown:



### Confirm Stop Mirrored Protection

Press Enter to confirm your choice to stop mirrored protection. During this process the system will be IPLed. You will return to the DST main menu after the IPL is complete. The system will have the displayed protection.

Press F12 to return to change your choice.

| ASP | Unit | Serial Number | Type | Model | Resource Name | Protection    |
|-----|------|---------------|------|-------|---------------|---------------|
| 1   |      |               |      |       |               | Unprotected   |
|     | 1    | 00-48519      | 6606 | 030   | DD010         | Unprotected   |
| 2   |      |               |      |       |               | Unprotected   |
|     | 2    | 00-1000341    | 9337 | 211   | DD012         | Unprotected   |
|     | 3    | 00-0186325    | 6602 | 074   | DD019         | Device Parity |
|     | 4    | 00-0162516    | 6602 | 074   | DD025         | Device Parity |
|     | 5    | 00-0238703    | 6602 | 074   | DD052         | Device Parity |

5. Press the Enter key to confirm your choice. The system stops mirrored protection for the ASPs you requested and performs an IPL. However, when you stop mirroring on only independent ASPs, the system does not perform an IPL.



---

## Chapter 22. Working with Disk Compression

This chapter describes how to start and stop disk compression. It also discusses various considerations for using disk compression.

---

### Introduction to Disk Compression

Disk compression is a technology that increases the apparent capacity of disk storage devices by encoding the data to take up less physical storage space on disk. Disk compression is performed in the disk subsystem controller and does not affect the iSeries system processor. The compression and decompression of data is performed automatically on each write command and read command, respectively. With the exception of a performance impact, disk compression is transparent to applications. The performance of compressed disk drives is slower than the performance of non-compressed disk drives. This is due to the overhead of compression and decompression, and the variations in the length of the data that is written to disk.

Typically, data that is found on disk units has a wide range of access requirements. You may choose to move data that is accessed infrequently, or data that does not require high performance I/O rates, to compressed disk units. Disk compression is intended to make infrequently accessed data available on-line at a lower cost. This storage alternative is positioned between non-compressed disk unit storage and optical or tape storage.

Compressed disks have the same disk subsystem availability options of device parity protection and mirrored protection as non-compressed disks. Disk compression is only supported in user ASPs.

### Restrictions and Considerations

The following restrictions and considerations apply to disk compression:

- A compression-capable storage controller is required for the compressed disk units.
- If you configured a 2748 or 2778 storage I/O controller for extended adaptive cache, you cannot use this controller for disk compression at the same time. However, you may re-configure the 2748 or the 2778 storage I/O controller for disk compression.

The iSeries Information Center contains information on how to reconfigure your 2748 or 2778 storage I/O controller. Search for "jumper" in the Information Center. Select the page about setting or changing the mode of an I/O card from the search results and follow the procedure. You can access the Information Center from the following Web site:

<http://www.ibm.com/eserver/iseries/infocenter>

- Disk compression is only allowed on certain types of disk units. Contact your service provider for the most current list of disk units which are capable of disk compression.
- If you are using V4R3M0 on your system, you can start or stop disk compression only on nonconfigured disk units. If you are using V4R4M0 or later on your system, you can start or stop disk compression on configured and nonconfigured disk units.

**Note:** If the disk unit is configured, you can only start disk compression if the disk unit is less than or equal to 92% full. You can only stop disk compression if there is room in the ASP for moving data off the disk unit so that the amount of data left on the disk unit is 92% of its uncompressed capacity.

- Disk units that are compressed may not be added to the System ASP. You can only add compressed units to a User ASP.
- A User ASP may contain compressed and non-compressed disk units.
- A device parity protection set may contain compressed and non-compressed disk units.

- If you are using mirrored protection, both disk units in the mirrored pair must have the same compression status (either both compressed or both non-compressed).
- You may experience a zero to 30% performance degradation on I/O operations to compressed disk units. Your results may vary based on your actual work load characteristics.

## Disk Compression and Capacity

Capacity gains may vary and are determined by the amount of compression that can be performed on the data. An overall 2:1 compression ratio should be expected for a disk unit. A maximum 4:1 compression ratio for a disk unit may be achievable in certain circumstances. Additionally, a compression ratio for a set of data on that disk unit may reach a maximum of 8:1. The iSeries software enforces the overall disk unit maximum compression ratio of 4:1. Because capacity is dependent on how well the data compresses, the capacity that is displayed will change as data is written to or deleted from the disk. The capacity that is displayed for a compressed disk unit is the amount of data on the disk plus an estimate of how much additional data can fit on the disk.

The following example shows the calculation and display of capacity by the system for compressed disk units. The disk unit capacities are available on the Display Disk Configuration Capacity display under the DST menus and the SST menus. The capacities are also available on the Work with Disk Status (WRKDSKSTS) display.

**Note:** If you have the licensed program 5769PT1 Performance Tools for iSeries installed on the system, you may use the system report to display the compression ratio. (You can find the ratio in the "Disk Compression Statistics" section in the system report.)

1. Prior to starting compression, a nonconfigured 6602 Model 050 has a capacity of 1031 megabytes.

| Display Non-Configured Units |      |       |               |          |                |
|------------------------------|------|-------|---------------|----------|----------------|
| Serial Number                | Type | Model | Resource Name | Capacity | Status         |
| 83-0135199                   | 6602 | 050   | DD005         | 1031     | Non-configured |
| 83-0306044                   | 6602 | 050   | DD006         | 1031     | Non-configured |

2. After starting compression, the 6602 model number changes to 060, and the capacity doubles.

| Display Non-Configured Units |      |       |               |          |                |
|------------------------------|------|-------|---------------|----------|----------------|
| Serial Number                | Type | Model | Resource Name | Capacity | Status         |
| 83-0135199                   | 6602 | 060   | DD005         | 2062     | Non-configured |
| 83-0306044                   | 6602 | 060   | DD006         | 2062     | Non-configured |

3. Two compressed disk units are added into user ASP 2.

| Display Disk Configuration Capacity |      |      |       |           |          |                   |        |                   |        |
|-------------------------------------|------|------|-------|-----------|----------|-------------------|--------|-------------------|--------|
| ASP                                 | Unit | Type | Model | Threshold | Overflow | ----Protected---- |        | ---Unprotected--- |        |
|                                     |      |      |       |           |          | Size              | % Used | Size              | %Used  |
| 1                                   |      |      |       | 90%       | No       | 0                 | 0.00%  | 21372             | 17.26% |
|                                     | 1    | 6607 | 050   |           |          | 0                 | 0.00%  | 4194              | 29.25% |
|                                     | 2    | 6713 | 050   |           |          | 0                 | 0.00%  | 8589              | 14.33% |
| 2                                   | 3    | 6713 | 050   |           |          | 0                 | 0.00%  | 8589              | 14.34% |
|                                     |      |      |       | 90%       | No       | 0                 | 0.00%  | 4124              | 0.10%  |
|                                     | 5    | 6602 | 060   |           |          | 0                 | 0.00%  | 2062              | 0.10%  |
|                                     | 6    | 6602 | 060   |           |          | 0                 | 0.00%  | 2062              | 0.10%  |

4. After writing data to the user ASP, capacities and percentages that are used are displayed.

| Display Disk Configuration Capacity |      |      |       |           |          |                   |        |                   |        |  |
|-------------------------------------|------|------|-------|-----------|----------|-------------------|--------|-------------------|--------|--|
| ASP                                 | Unit | Type | Model | Threshold | Overflow | ----Protected---- |        | ---Unprotected--- |        |  |
|                                     |      |      |       |           |          | Size              | % Used | Size              | %Used  |  |
| 1                                   |      |      |       | 90%       | No       | 0                 | 0.00%  | 21372             | 17.26% |  |
|                                     | 1    | 6607 | 050   |           |          | 0                 | 0.00%  | 4194              | 29.25% |  |
|                                     | 2    | 6713 | 050   |           |          | 0                 | 0.00%  | 8589              | 14.33% |  |
|                                     | 3    | 6713 | 050   |           |          | 0                 | 0.00%  | 8589              | 14.34% |  |
|                                     | 2    |      |       | 90%       | No       | 0                 | 0.00%  | 5812              | 61.06% |  |
|                                     | 5    | 6602 | 060   |           |          | 0                 | 0.00%  | 2905              | 61.04% |  |
|                                     | 6    | 6602 | 060   |           |          | 0                 | 0.00%  | 2907              | 61.08% |  |

5. The following calculations may be performed to determine how well the data is being compressed, and the estimated disk unit capacity. These calculations may be performed on a user ASP basis, as well as on individual disk units.

| Amount                            | Calculation                                      |
|-----------------------------------|--------------------------------------------------|
| Logical data written              | Size * (% Used / 100)                            |
| Physical free space               | (Size * (1-(% Used / 100))) / 2                  |
| Physical space used               | Non-compressed size - Physical free space        |
| Compression ratio of data written | Logical data written / Physical space used       |
| Estimated disk capacity           | Logical data written + (2 * Physical free space) |

Using the values listed for Unit 5 in the preceding step with these formulas produces the following:

| Amount                  | Calculation                    |
|-------------------------|--------------------------------|
| Logical data written    | 2905 * .6104 = 1773            |
| Physical free space     | (2905 * (1-(.6104))) / 2 = 566 |
| Physical space used     | 1031 - 566 = 465               |
| Compression ratio       | 1773 / 465 = 3.8               |
| Estimated disk capacity | 1773 + (2 * 566) = 2905        |

## Disk Unit Full Considerations

As space is being reserved or data is being written to compressed disk units, it is possible for a unit to become temporarily full. The storage subsystem controller will detect this situation and attempt to reposition the data on the unit in order to maximize the amount of data that can be stored on the unit. This repositioning of the data increases the effective size of the disk unit. If the storage subsystem controller can not immediately service a system request, a failure will be returned to the system. The system bases its response to this failure on the type of I/O operation that is requested. One of the following scenarios may occur:

- The system responds to this failure by overflowing the auxiliary storage pool (ASP). Once the overflow occurs, this I/O request will be performed in the system ASP and will succeed.
- The system responds to this failure by displaying an A6xx 0277 system reference code (SRC) on the control panel in the system unit. The system displays this attention SRC until storage space becomes available on the disk unit that is denoted in the attention SRC.

For more information, refer to "How The System Responds to Disk Unit Full 448 Reference Code A6xx 0277" on page 420.

When the system displays an A6xx 0277 attention SRC on the control panel, it also logs a corresponding A6xx 0277 record in the Product Activity Log. This occurs each time this disk unit full condition is detected. The system also sends message CPI116C "Compressed disk unit &1 is full" to the QSYSOPR message queue. The system will reissue the failed I/O operation and will continue to display the attention SRC on the control panel until the condition is corrected. When the storage subsystem controller

creates sufficient space on the compressed unit to contain the system request, the I/O operation completes successfully and the system resumes normal processing.

While this attention SRC is being displayed, some I/O operations to the affected compressed disk unit may be suspended. As a result, you may observe that jobs which issue I/O operations to the affected unit appear to hang.

To reduce the likelihood of system operations hanging while the storage subsystem recovers from a disk unit full condition, it is recommended that ASPs with compressed units operate with a storage threshold of less than or equal to 90%.

As space on the disk unit continues to be used, eventually the storage subsystem controller can no longer store more data on the unit. At this point, the storage subsystem controller will return a failure on any system requests requiring storage space. Refer to the following section, How The System Responds to Disk Unit Full 448 Reference Code A6xx 0277, for more information.

## How The System Responds to Disk Unit Full 448 Reference Code A6xx 0277

The system bases its response to the disk unit full condition on the type of I/O operation that was issued that caused the condition.

If the system request is reserving additional storage space in the ASP, the compression recovery policy for the ASP determines the system response. You set this policy by using the Change ASP Attribute (CHGASPA) command.

The system may respond to the disk unit full condition in one of the following ways:

- If the compression recovery policy is \*OVERFLOW, the system responds to this condition by overflowing the ASP. Once the overflow occurs, this I/O request will be performed in the system ASP and will succeed. This is the system default compression recovery policy for all user ASPs.

For more information, refer to “How to Recover An Overflowed User Auxiliary Storage Pool” on page 179.

- If the compression recovery policy is \*RETRY, the system responds to this condition by displaying an A6xx 0277 SRC on the control panel and repeatedly retrying the failed I/O operation. The system displays this attention SRC until storage space becomes available on the disk unit and the I/O operation succeeds. If storage space does not become available on the disk unit, the ASP overflows. The system removes the attention SRC from the control panel, and the I/O operation is successfully performed in the system ASP.

For more information, refer to “How to Recover An Overflowed User Auxiliary Storage Pool” on page 179.

- If the compression recovery policy is \*WAIT, the system responds to this condition by displaying an A6xx 0277 SRC on the control panel and repeatedly retrying the failed I/O operation. If storage space does not become available on the disk unit, the ASP does not overflow. The user must take one of the corrective actions that are discussed in “SRC Code A6xx 0277.”

---

## SRC Code A6xx 0277

When you see the A6xx 0277 SRC code in the control panel, select the appropriate compression reference code word for additional information. The compression reference code word is either word 15 or word 17. In the V4R5 release, the compression reference code word format changed.

*Table 73. Word formats for SRC codes in V4R5.*

| Word for the SRC code | Word format | Description |
|-----------------------|-------------|-------------|
|-----------------------|-------------|-------------|

Table 73. Word formats for SRC codes in V4R5. (continued)

|                                                                  |                                                                                                                                                                                                                                                                                                                                                                                                                                                                                                                                                                   |                                                                                                                                                                                                                                                                                                                                                               |
|------------------------------------------------------------------|-------------------------------------------------------------------------------------------------------------------------------------------------------------------------------------------------------------------------------------------------------------------------------------------------------------------------------------------------------------------------------------------------------------------------------------------------------------------------------------------------------------------------------------------------------------------|---------------------------------------------------------------------------------------------------------------------------------------------------------------------------------------------------------------------------------------------------------------------------------------------------------------------------------------------------------------|
| <p>5 (for models 270 and 8xx)</p> <p>15 for all other models</p> | <p>CCEE 0000</p> <p>CC indicates the operation in progress with the following values:</p> <ul style="list-style-type: none"> <li>• 84 is an allocate operation</li> <li>• 2x is a write operation where x is 1, 2, or 4</li> </ul> <p>EE indicates the error code with the following values:</p> <ul style="list-style-type: none"> <li>• 00 is the storage subsystem controller can not obtain any additional storage space on the unit</li> <li>• 02 is the storage subsystem controller will be able to obtain additional storage space on the unit</li> </ul> | <p>This word is the compression reference code that indicates two things. First, it indicates which operation was in progress. Second, it indicates whether or not the storage subsystem controller can obtain additional storage space on the system.</p> <p>This reference code word was formerly word 17 in the V4R4 release and in previous releases.</p> |
| <p>6 (for models 270 and 8xx)</p> <p>16 for all other models</p> | <p>uuuu uuuu</p>                                                                                                                                                                                                                                                                                                                                                                                                                                                                                                                                                  | <p>This word describes the unit address of the disk unit.</p>                                                                                                                                                                                                                                                                                                 |
| <p>7 (for models 270 and 8xx)</p> <p>17 for all other models</p> | <p>BBBB cbbb</p>                                                                                                                                                                                                                                                                                                                                                                                                                                                                                                                                                  | <p>This word defines the bus, card, and board address of the disk unit.</p>                                                                                                                                                                                                                                                                                   |

**Note:** The Information Center contains information that correlates the function and word for SRC codes on models 270, and 8xx. Look under System Administration, Availability, and Maintenance->Logical Partitions->Troubleshooting logical partitions->Learning about system reference codes (SRC) for logical partitions.

Table 74. SRC code word formats in V4R4 and previous releases.

| Word for the SRC code | Word format | Description                                            |
|-----------------------|-------------|--------------------------------------------------------|
| 15                    | 0000 0000   | Unassigned in V4R4 and previous releases.              |
| 16                    | uuuu uuuu   | This word describes the unit address of the disk unit. |

Table 74. SRC code word formats in V4R4 and previous releases. (continued)

|    |                                                                                                                                                                                                                                                                                                                                                                                                                                                                                                                                                                                                                                            |                                                                                                                           |
|----|--------------------------------------------------------------------------------------------------------------------------------------------------------------------------------------------------------------------------------------------------------------------------------------------------------------------------------------------------------------------------------------------------------------------------------------------------------------------------------------------------------------------------------------------------------------------------------------------------------------------------------------------|---------------------------------------------------------------------------------------------------------------------------|
| 17 | <p>CCEE BBcb</p> <p>CC indicates the operation in progress with the following values:</p> <ul style="list-style-type: none"> <li>• 84 is an allocate operation</li> <li>• 2x is a write operation where x is 1, 2, or 4</li> </ul> <p>EE indicates the error code with the following values:</p> <ul style="list-style-type: none"> <li>• 00 is the storage subsystem controller can not obtain any additional storage space on the unit</li> <li>• 02 is the storage subsystem controller will be able to obtain additional storage space on the unit</li> </ul> <p>BBcb indicates the bus, card, and board address of the disk unit.</p> | <p>Word 17 defines: the operation in progress, the error code; and the bus, card, and board address of the disk unit.</p> |
|----|--------------------------------------------------------------------------------------------------------------------------------------------------------------------------------------------------------------------------------------------------------------------------------------------------------------------------------------------------------------------------------------------------------------------------------------------------------------------------------------------------------------------------------------------------------------------------------------------------------------------------------------------|---------------------------------------------------------------------------------------------------------------------------|

Perform one of the three following actions in response to SRC A6xx 0277.

## User Action 1

Wait for the storage subsystem controller to reposition the data on the disk unit.

If the error code for **EE** of the attention SRC is 02, the storage subsystem controller will eventually obtain additional storage space on the unit, such that the I/O operation will succeed. If the system does not resume normal processing within 20 minutes, contact your next level of support.

## User Action 2

Make storage space available in the ASP that contains the disk unit that is denoted in the SRC.

Word 16 contains the unit address of the disk unit. Word 17 (V4R4 and previous) contains the right most characters as BBcb. Word 17 or 7 (V4R5) is BBBB cbb. Refer to "Hardware Service Manager" in the iSeries Service Functions to correlate the unit address (logical address) with a resource name or serial number. The ASP that contains the disk unit can be determined by using the Display Disk Configuration Status display under the DST and SST menus.

If the error code for **EE** of the attention SRC is 00, the storage subsystem controller determined that the disk unit is full.

Perform one or more of the following actions:

- Delete objects that are not needed from the ASP.
- Save objects that are not needed from the ASP by specifying STG(\*FREE) on the Save Object (SAVOBJ) command.
- Move one or more libraries to a different ASP.

**Note:** You cannot use the MOV OBJ command to do this. You must save the library, delete it, and then restore it to a different ASP.

- Move one or more folders to a different ASP by saving the folder, deleting it, and restoring it to a different ASP.
- Increase the storage capacity by adding disk units to the ASP.



## User Action 3

Change the compression recovery policy to the desired system behavior. For more information on the CHGASPA command, refer to the iSeries server online help.

## User Action 4

Re-IPL the system so that additional storage space can be made available in the ASP that contains the disk unit that was denoted in the attention SRC on the subsequent IPL.

Word 16 contains the unit address of the disk unit. Word 17 (V4R4 and previous) contains the right most characters as BBcb. Word 17 or 7 (V4R5) is BBBB ccbb. Refer to "Hardware Service Manager" in the iSeries Service Functions to correlate the unit address (logical address) with a resource name or serial number. The ASP that contains the disk unit can be determined by using the Display Disk Configuration Status display under the DST and SST menus.

If the error code for EE of the attention SRC is 00 and the system is holding critical resources, the system will eventually hang. The recommended recovery procedure is to re-IPL the system. The system must be in Manual mode. Perform the following steps:

1. Force the system to write changed data in main storage to disk storage by pressing the power push-button twice to stop the system. Wait for system activity to stop.  
There will be changed data that is in main storage which can not be written to the disk unit. Therefore, the above system power off will eventually hang.
2. Start an IPL.
  - a. Ensure that the keystick is in the system unit control panel.
  - b. Place the system in manual mode.
  - c. Press the Function Select switch (or buttons) to display 03 in the Function display.
  - d. Press the Enter button on the control panel.
3. On the following Manual mode IPL, perform **one** of the following:
  - Increase the storage capacity by adding disk units to the ASP at DST
  - Start the system to restricted state. Make storage space available in the ASP that contains the disk unit denoted in the attention SRC. Make the space available by performing one or more of the following steps:
    - Delete objects that are not needed from the ASP.
    - Save objects that are not needed from the ASP by specifying STG(\*FREE) on the Save Object (SAVOBJ) command.
    - Move one or more libraries to a different ASP.

**Note:** You cannot use the MOV OBJ command to do this. You must save the library, delete it, and restore it to a different ASP.

  - Move one or more folders to a different ASP by saving the folder, deleting it, and restoring it to a different ASP.

## Examples of A6xx 0277

The following examples illustrate two situations where an A6xx 0277 SRC record will be generated, and any associated actions you may need to take.

### 17 8402 0110 (V4R4 and previous) OR 15 or 5 8402 0000 (V4R5)

In this example, an allocate operation (84) is being attempted and the error code (02) denotes the operation is being retried and will eventually succeed. You do not need to take any additional action. If the system does not resume normal processing within 20 minutes, contact your next level of support.

If you want the system to overflow the user ASP into the system ASP, take User Action 3 that specifies the compression recovery policy \*OVERFLOW, described above.

**17 2000 0110 (V4R4 and previous) OR 15 or 5 2000 0000 (V4R5)**

In this example, a write operation (20) is being attempted and the error code (00) denotes that the operation is being retried indefinitely, because the storage subsystem controller has determined that there is no storage space available on the disk unit. Take either User Action 2 or User Action 4, described above.

---

## How to Start Disk Compression

You can start disk compression from the Dedicated Service Tools (DST) menu.

**Note:**

You can use a 2748 storage I/O controller for extended adaptive cache or disk compression, but not both at the same time. The Information Center contains information on how to configure your 2748 storage I/O controller. Look under the Storage I/O card modes and jumpers information in the Information Center Website: <http://www.ibm.com/eserver/series/infocenter>.

The V4R5 navigation path to this information is System Management->System hardware->Storage I/O card modes and jumpers->Setting or changing the mode of an I/O card.

To start disk compression from DST, perform the following steps.

1. If you use your 2748 storage I/O controller for compression, make sure that you set the jumper for compression mode before you continue with the following steps. See 424.
2. If you are not already using DST, perform a manual IPL to start DST. See "How to Start Dedicated Service Tools (DST)" on page 366.
3. From the Use Dedicated Services Tools (DST) menu, do the following:
  - a. Select option 4 (Work with disk units).
  - b. Select option 1 (Work with disk configuration) on the Work with Disk Units display.
  - c. Select option 6 (Work with disk compression) on the Work with Disk Configuration display.
4. Select option 2 on the Work with Disk Compression .

Work with Disk Compression

Select one of the following:

1. Display disk compression status
2. Start compression on disk units
3. Stop compression on disk units

Selection

F3=Exit      F12=Cancel

5. Select the disk units that you want to start compression on from the Select Disk Units for Start Compression screen.

**Note:** You can only start compression on a configured unit if the disk unit is less than or equal to 92% full.

```

Select Disk Units for Start Compression

Select the units for start compression.

Type choice, press Enter.
1=Start compression

```

| OPT Unit | ASP | Serial Number | Type | Model | Resource Name | Status         |
|----------|-----|---------------|------|-------|---------------|----------------|
| 1        |     | 68-7F0DB      | 6607 | 050   | DD005         | Non-configured |
|          |     | 68-5FB0B      | 6713 | 050   | DD001         | Non-configured |

```

F3=Exit    F12=Cancel

```

6. You are shown the Confirm Disk Units for Start Compression screen. This display shows the approximate amount of time that is required to start disk compression, and the current and proposed sizes of the disk unit.

```

Confirm Disk Units for Start Compression

Estimated time for this operation to complete : 14-16 Minutes

Press Enter to confirm your choice to compress the disk units.
Press F9=Capacity Information to display the resulting capacity.
Press F12=Cancel to return to change your choice.

```

| OPT | ASP | Unit | Serial Number | Type | Model | Current Size | Proposed Size |
|-----|-----|------|---------------|------|-------|--------------|---------------|
| 1   |     |      | 68-7F0DB      | 6607 | 050   | 4194         | 8388          |

```

F9=Resulting Capacity    F12=Cancel

```

7. At the Confirm Disk Units for Start Compression screen, press Enter to confirm your choice of disk units that you want to start compression on. You are shown the Start Compression on Disk Unit Status screen.

```

Start Compression on Disk Unit Status

Estimated time for this operation to complete : 14-16 Minutes

The operation to start compression on the selected disk units
will be done in multiple phases. The phases are listed here
and the status will be updated as the phase proceeds.

```

| Phase                                  | Status       |
|----------------------------------------|--------------|
| Prepare to start compression . . . . . | 0 % Complete |
| Start compression . . . . .            |              |
| Prepare to compress data . . . . .     |              |
| Compress data . . . . .                |              |

```

Wait for next display or press F16 for DST menu

```

8. After the start compression operation completes, you are returned to the Work with Disk Compression screen, and shown a completion message.

```
Work with Disk Compression

Select one of the following:

    1. Display disk compression status
    2. Start compression on disk units
    3. Stop compression on disk units

Selection

F3=Exit    F12=Cancel
The requested compression operation completed successfully.
```

---

## How to Stop Disk Compression

To stop disk compression from DST, perform the following steps.

1. If you are not already using DST, perform a manual IPL to start DST. See “How to Start Dedicated Service Tools (DST)” on page 366.
2. From the Use Dedicated Services Tools (DST) menu, do the following:
  - a. Select option 4 (Work with disk units).
  - b. Select option 1 (Work with disk configuration) on the Work with Disk Units display.
  - c. Select option 6 (Work with disk compression) on the Work with Disk Configuration display.
3. Select option 3 on the Work with Disk Compression screen.

```
Work with Disk Compression

Select one of the following:

    1. Display disk compression status
    2. Start compression on disk units
    3. Stop compression on disk units

Selection

F3=Exit    F12=Cancel
```

4. Select the disk units that you want to stop compression on from the Select Disk Units for Start Compression screen.

**Note:** Compression can only be stopped if there is room in the ASP for moving data off of the disk unit. Once the data has been moved off, the amount of data that is left on the disk is less than or equal to 92% of its uncompressed capacity.

```

Select Disk Units for Stop Compression

Select the units for stop compression.

Type choice, press Enter.
1=Stop compression

```

| OPT | Unit | ASP | Serial Number | Type | Model | Resource Name | Status         |
|-----|------|-----|---------------|------|-------|---------------|----------------|
| 1   |      |     | 68-7F0DB      | 6607 | 060   | DD005         | Non-configured |

```

F3=Exit      F12=Cancel

```

5. You are shown the Confirm Disk Units for Stop Compression screen. This display shows the approximate amount of time that is required to stop disk compression, and the current and proposed sizes of the disk unit.

```

Confirm Disk Units for Stop Compression

Estimated time for this operation to complete : 1-2 Minutes

Press Enter to confirm stop compression.
Press F9=Capacity Information to display the resulting capacity.
Press F12=Cancel to return to change your choice.

```

| OPT | ASP | Unit | Serial Number | Type | Model | Current Size | Proposed Size |
|-----|-----|------|---------------|------|-------|--------------|---------------|
| 1   |     |      | 68-7F0DB      | 6607 | 060   | 8388         | 4194          |

```

F9=Resulting Capacity      F12=Cancel

```

6. At the Confirm Disk Units for Stop Compression screen, press Enter to confirm your choice of disk units that you want to stop compression on. You are shown the Stop Compression on Disk Unit Status screen.

```

Stop Compression on Disk Unit Status

Estimated time for this operation to complete : 1-2 Minutes

The operation to stop compression on the selected disk units
will be done in multiple phases. The phases are listed here
and the status will be updated as the phase proceeds.

```

| Phase                                 | Status       |
|---------------------------------------|--------------|
| Prepare to stop compression . . . . . | 0 % Complete |
| Stop compression . . . . .            |              |

7. After the stop compression operation completes, you are returned to the Work with Disk Compression screen, and shown a completion message.

### Work with Disk Compression

Select one of the following:

1. Display disk compression status
2. Start compression on disk units
3. Stop compression on disk units

Selection

F3=Exit      F12=Cancel

The requested compression operation completed successfully.

## Procedural Sequences for Configuring Disks and Protection

Each respective configuration change requires you to perform procedures in a specific order. The following lists show the order that you should use when performing the procedures.

### Adding a New I/O Compression-Capable Storage Controller

This checklist shows the sequence of tasks that you use to add a new compression-capable I/O Storage Controller and disk units to your system.

Before you begin, make a copy of this checklist. Fill in the appropriate areas as you or the service representative perform the configuration tasks. This checklist provides an important record of your actions. It may help you to diagnose any problems that occur.

Most tasks in the checklist include references to other topics in this book. Refer to these topics if you need more information about how to perform a particular task.

*Table 75. Adding a New I/O Storage Controller and Disk Units*

| Task              | What to Do                                                                                                     | Where to Read More About It                                                      |
|-------------------|----------------------------------------------------------------------------------------------------------------|----------------------------------------------------------------------------------|
| ___ <b>Task 1</b> | Install the new storage controller in the system. This is normally done by a service representative.           |                                                                                  |
| ___ <b>Task 2</b> | Physically attach disk units to the new storage controller. This is normally done by a service representative. |                                                                                  |
| ___ <b>Task 3</b> | Start DST.                                                                                                     | "How to Start Dedicated Service Tools (DST)" on page 366.                        |
| ___ <b>Task 4</b> | Print your current disk configuration.                                                                         | "How to Display Your Disk Configuration" on page 368.                            |
| ___ <b>Task 5</b> | If you want to have device parity protection for the storage controller, start device parity protection now.   | "How to Start Device Parity Protection for an Input/Output Adapter" on page 397. |
| ___ <b>Task 6</b> | Start disk compression on nonconfigured disk units.                                                            | "How to Start Disk Compression" on page 424.                                     |

Table 75. Adding a New I/O Storage Controller and Disk Units (continued)

| Task        | What to Do                                                                                                                                                                                                                                                                                                          | Where to Read More About It                                                      |
|-------------|---------------------------------------------------------------------------------------------------------------------------------------------------------------------------------------------------------------------------------------------------------------------------------------------------------------------|----------------------------------------------------------------------------------|
| ___ Task 7  | Add nonconfigured disk units to the correct ASPs. You can add the disk units to an existing user ASP or to a new ASP. If you are adding disk units to an ASP that has mirrored protection and the new disk units do not have device parity protection, you must add pairs of disk units that have equal capacities. | "How to Add Disk Units to an Auxiliary Storage Pool" on page 375.                |
| ___ Task 8  | If you created a new ASP on your system when you added disk units, the system set the storage threshold of the ASP to 90%. If you want a different threshold, change it at this time.                                                                                                                               | "How to Change the Storage Threshold for an Auxiliary Storage Pool" on page 377. |
| ___ Task 9  | If you created any new ASPs and you want those ASPs to have mirrored protection, start mirrored protection now.                                                                                                                                                                                                     | "How to Start Mirrored Protection" on page 411.                                  |
| ___ Task 10 | Verify that your disk configuration is correct.                                                                                                                                                                                                                                                                     | "How to Display Your Disk Configuration" on page 368.                            |
| ___ Task 11 | End DST.                                                                                                                                                                                                                                                                                                            | "How to Stop Dedicated Service Tools (DST)" on page 368.                         |

## Adding Disk Units to an Existing Compression-Capable Storage Controller

Before you begin, make a copy of this checklist. Fill in the appropriate areas as you or the service representative perform the configuration tasks. This checklist provides an important record of your actions. It may help you to diagnose any problems that occur.

Most tasks in the checklist include references to other topics in this book. Refer to these topics if you need more information about how to perform a particular task.

Table 76. Adding Compressed Disk Units to an Existing Storage Controller

| Task       | What to Do                                                                                                         | Where to Read More About It                                                                                    |
|------------|--------------------------------------------------------------------------------------------------------------------|----------------------------------------------------------------------------------------------------------------|
| ___ Task 1 | Physically attach disk units to an existing storage controller. This is normally done by a service representative. |                                                                                                                |
| ___ Task 2 | Start DST or SST.                                                                                                  | "How to Start Dedicated Service Tools (DST)" on page 366 or "Starting System Service Tools (SST)" on page 368. |
| ___ Task 3 | Print your current disk configuration.                                                                             | "How to Display Your Disk Configuration" on page 368.                                                          |
| ___ Task 4 | Include the disk units that you want to protect in device parity protection.                                       | "How to include a disk unit in device parity protection" on page 406.                                          |
| ___ Task 5 | Start disk compression on nonconfigured disk units.                                                                | "How to Start Disk Compression" on page 424.                                                                   |

Table 76. Adding Compressed Disk Units to an Existing Storage Controller (continued)

| Task        | What to Do                                                                                                                                                                                                                                                                                                          | Where to Read More About It                                                                                   |
|-------------|---------------------------------------------------------------------------------------------------------------------------------------------------------------------------------------------------------------------------------------------------------------------------------------------------------------------|---------------------------------------------------------------------------------------------------------------|
| ___ Task 6  | Add nonconfigured disk units to the correct ASPs. You can add the disk units to an existing user ASP or to a new ASP. If you are adding disk units to an ASP that has mirrored protection and the new disk units do not have device parity protection, you must add pairs of disk units that have equal capacities. | "How to Add Disk Units to an Auxiliary Storage Pool" on page 375.                                             |
| ___ Task 7  | If you created a new ASP on your system when you added disk units, the system set the storage threshold of the ASP to 90%. If you want a different threshold, change it at this time.                                                                                                                               | "How to Change the Storage Threshold for an Auxiliary Storage Pool" on page 377.                              |
| ___ Task 8  | If you created any new ASPs and you want those ASPs to have mirrored protection, start mirrored protection now.                                                                                                                                                                                                     | "How to Start Mirrored Protection" on page 411.                                                               |
| ___ Task 9  | Verify that your disk configuration is correct.                                                                                                                                                                                                                                                                     | "How to Display Your Disk Configuration" on page 368.                                                         |
| ___ Task 10 | End DST or SST.                                                                                                                                                                                                                                                                                                     | "How to Stop Dedicated Service Tools (DST)" on page 368 or "Stopping System Service Tools (SST)" on page 368. |

## Moving Disk Units from the System ASP to a User ASP

This checklist shows the sequence of tasks that you use to move one or more disk units from the System ASP to a User ASP. This checklist assumes that the disk units are attached to a compression-capable subsystem storage controller.

Before you begin, make a copy of this checklist. Fill in the appropriate areas as you or the service representative perform the configuration tasks. This checklist provides an important record of your actions. It may help you diagnose any problems that occur.

**Attention:** When you perform the tasks in this checklist, the system moves large amounts of data. Make sure that you have saved your system completely in the event that you need to recover from an error situation.

Most tasks in the checklist include references to other topics in this book. Refer to these topics if you need more information about how to perform a particular task.

Table 77. Moving Disk Units from the System ASP to a User ASP

| Task       | What to Do                                                                               | Where to Read More About It                                                 |
|------------|------------------------------------------------------------------------------------------|-----------------------------------------------------------------------------|
| ___ Task 1 | Print your current disk configuration.                                                   | "How to Display Your Disk Configuration" on page 368.                       |
| ___ Task 2 | Calculate the space requirements for both the source and target ASPs for the disk units. | "Calculating Space Requirements for an Auxiliary Storage Pool" on page 385. |
| ___ Task 3 | Use option 21 from the Save menu to save your entire system.                             |                                                                             |
| ___ Task 4 | Start DST.                                                                               | "How to Start Dedicated Service Tools (DST)" on page 366.                   |
| ___ Task 5 | Remove disk units that you plan to add to a different ASP.                               | "How to Remove a Disk Unit from an Auxiliary Storage Pool" on page 382.     |



Table 77. Moving Disk Units from the System ASP to a User ASP (continued)

| Task        | What to Do                                                                                                                                                                                                                                                                                                          | Where to Read More About It                                                                                                                                               |
|-------------|---------------------------------------------------------------------------------------------------------------------------------------------------------------------------------------------------------------------------------------------------------------------------------------------------------------------|---------------------------------------------------------------------------------------------------------------------------------------------------------------------------|
| ___ Task 6  | If you wish to use device parity protection, start device parity protection (if necessary), and include the disk units that you want to protect. If you do not wish to use device parity protection, proceed to the next step.                                                                                      | "How to Start Device Parity Protection for an Input/Output Adapter" on page 397 (if necessary), and "How to include a disk unit in device parity protection" on page 406. |
| ___ Task 7  | Start disk compression on nonconfigured disk units.                                                                                                                                                                                                                                                                 | "How to Start Disk Compression" on page 424.                                                                                                                              |
| ___ Task 8  | Add nonconfigured disk units to the correct ASPs. You can add the disk units to an existing user ASP or to a new ASP. If you are adding disk units to an ASP that has mirrored protection and the new disk units do not have device parity protection, you must add pairs of disk units that have equal capacities. | "How to Add Disk Units to an Auxiliary Storage Pool" on page 375.                                                                                                         |
| ___ Task 9  | If you created a new ASP on your system when you added disk units, the system set the storage threshold of the ASP to 90%. If you want a different threshold, change it at this time.                                                                                                                               | "How to Change the Storage Threshold for an Auxiliary Storage Pool" on page 377.                                                                                          |
| ___ Task 10 | If you created any new ASPs and you want those ASPs to have mirrored protection, start mirrored protection now.                                                                                                                                                                                                     | "How to Start Mirrored Protection" on page 411.                                                                                                                           |
| ___ Task 11 | Verify that your disk configuration is correct.                                                                                                                                                                                                                                                                     | "How to Display Your Disk Configuration" on page 368.                                                                                                                     |
| ___ Task 12 | End DST.                                                                                                                                                                                                                                                                                                            | "How to Stop Dedicated Service Tools (DST)" on page 368.                                                                                                                  |
| ___ Task 13 | If necessary, move objects between ASPs.                                                                                                                                                                                                                                                                            | "Transferring Objects between Auxiliary Storage Pools" on page 386.                                                                                                       |

## Recovering from Error Codes

You may encounter SRC codes when working with disk compression. This section discusses some causes of SRC codes, and how to respond to them. You may want to refer to Chapter 19, "Working with Auxiliary Storage Pools," on page 375 for information on moving disk units into and out of auxiliary storage pools (ASPs).

### Recovering from SRC 6xxx 7051

You are receiving this message because the compressed device and the compression input/output adapter (IOA) are not compatible.

1. Did you remove the disk unit from another system?

Yes No

↓ Go to step 6 on page 432.

2. Was it removed from the ASP of the other system?

Yes No

↓ Go to step 4 on page 432.

3. Stop compression on the disk unit.

**This ends the procedure.**

4. Do you want to save the data that is on the disk unit?

Yes No

↓ Stop compression on the disk unit.

**This ends the procedure.**

5. Return the disk unit to its original system and IOA and perform the following:

a. Remove the disk unit from the ASP.

b. Stop compression on the disk unit.

Reinstall the disk unit to this system.

**This ends the procedure.**

6. The IOP or IOA that you are using is not compatible with the disk unit.

Do you want to save the data that is on the disk unit?

Yes No

↓ Stop compression on the disk unit.

**This ends the procedure.**

7. If you came here from another procedure, return there and follow the procedure, otherwise contact your next level of support.

**This ends the procedure.**

## Recovering from SRC 6xxx 7052

You are receiving this message because the counter that tracks the number of write operations to this drive has reached 75% of its maximum value. This counter is used to determine if data on the drive is current with data within IOA memory. Since this counter is large, it is not necessary to stop compression for this drive immediately, but you should do so during your next scheduled maintenance. If this counter wraps, data can be lost.

To stop compression and restart compression on the disk drive to reset the write count, perform the following:

1. Perform a Manual Mode IPL to DST. (Refer to “Dedicated Service Tools (DST)” in the *iSeries Service Functions* for more information.)
2. To find the resource name of the disk drive with the problem, perform the following:
  - a. Select the *Use Dedicated Service Tools* option.
  - b. Select the *Start a service tool* option.
  - c. Select the *Hardware service manager* option.
  - d. Select the *Work with service action log* option.
  - e. Select the time frame of the problem.
  - f. Record the resource name that is associated with the 6xxx 7052 entry in the SRC column.
3. Remove the disk unit from the ASP.
4. Stop compression on the disk unit.
5. Start compression on the disk unit.
6. Add the disk drive back to the ASP from which it was removed.

**This ends the procedure.**

---

## Chapter 23. Managing Auxiliary Storage Pools

Auxiliary Storage Pools (ASPs) separate disk units into logical subsets, which can give you a number of advantages. Using ASPs helps protect your data. By separating libraries, documents, or other objects in an ASP, you protect them from data loss should a disk unit in a different ASP fail. The importance of protecting the data in the ASP and the capacity of the ASP are factors in determining what protection mechanisms (mirroring or device parity, for example) you choose to implement on the disk units in each ASP. Independent ASPs are unique in that you can make them available or unavailable as you need the information. This allows you to store low-usage data offline until it needs to be accessed, thus reducing system start time. In a clustered environment you can configure independent ASPs to switch between systems. To learn more about the benefits of independent ASPs, also called independent disk pools in iSeries Navigator, see the iSeries Information Center at <http://www.ibm.com/eserver/series/infocenter>.

Using ASPs also increases performance. You can place libraries or objects in an ASP, allowing you to dedicate the disk units in the ASP exclusively for the use of those objects. If you do extensive journaling, a dedicated disk unit for the journal receiver can also improve journaling performance.

**Note:** Placing many active journal receivers in the same user ASP is not productive. The resulting contention between writing to more than one receiver in the ASP can slow system performance. For maximum performance, place each active journal receiver in a separate user ASP.

You can improve system performance by using the ASP Trace and ASP Balance features.

Changing ASP size may involve determining adequate disk storage, “How to Add Disk Units to an Auxiliary Storage Pool” on page 375 and “How to Delete an Auxiliary Storage Pool” on page 384.

If the amount of data in a storage pool increases, you may need to increase the size of the storage pool. Conversely, if data in a storage pool decreases, you may want to decrease the size of that storage pool and use the disk space elsewhere.

Changing the size of an ASP can mean adding a disk unit, removing a disk unit, moving a disk unit, or deleting an ASP from the system. You must typically have QSECOFR authority to access these tasks.

---

### Working with ASP Trace and ASP Balance

There are three types of balancing action a user can choose:

- Capacity Balance
- Hierarchical Storage Management (HSM)
- Usage Balance

The balancing actions use the results of previous ASP traces to determine disk unit usage. Therefore, an ASP balance will be more effective if you perform an ASP trace first.

The following restrictions and considerations:

- The Usage Balance uses the results of previous ASP traces to determine the disk unit usage. You must perform an ASP trace before you run a Usage Balance.
- The Hierarchical Storage Management (HSM) Balance uses the results of previous ASP traces to determine the disk unit usage. You must perform an ASP trace before you can run a HSM Balance.
- The Hierarchical Storage Management (HSM) Balance requires a mixture of compressed and non-compressed disk units in the ASP.
- The system will experience degraded performance during the Trace activity and Balance activity.

- You can only use the Trace and Balance functions in Auxiliary Storage Pools which contain more than one disk unit.
- You can add a non-configured disk unit to the configuration during the time a Trace is running. In this case the system will automatically include the newly configured disk unit in the trace activity.
- You can only run a single Trace activity or Balance<sup>®</sup> activity at a given time to an Auxiliary Storage Pool.
- The amount of improvement in system throughput that is achieved by running the balance is dependent on many factors. This includes some of the following items.
  - The amount of mainstore.
  - The number of processors.
  - The level of activity running on the system.
  - The amount of cache in the storage subsystem.
  - The quantity of disk arms under each I/O Processor in each storage subsystem.

## Capacity Balance

The Capacity Balance function rearranges the data on all of the disk units within an Auxiliary Storage Pool. It moves data so that each disk unit has an equal percentage of used and unused space. This is useful when you add new units to an Auxiliary Storage Pool. We want to avoid the situation where several disk units contain the majority of the data and the newly added disk units contain very little data. This situation leads to poor system performance. The balance function spreads the data in the ASP evenly across all of the disk units.

Below is a display which shows the effects of using Capacity Balance. Before using Capacity Balance the recently added Unit 4 contained very little data. The system storage management allocates newly created data to the disk unit that has the lowest percentage of capacity used. Thus, the system routes all new storage allocations to the unit 4. If the system uses that newly created data frequently, a potential bottleneck is created. The system directs all of the I/O operations to a single disk unit instead of spreading it across all units in the ASP. The Capacity Balance performed on the ASP allows the data to be evenly distributed across all of the disk units in the ASP. This means that the distribution of future space allocation on the disk units in the ASP is even across all of the disk units in the ASP. That ensures that the I/O to those allocates are also evenly spread out amongst the disk units instead of being concentrated on the newly added disk unit.

| Unit | Before Capacity Balancing |        | After Capacity Balancing |        |
|------|---------------------------|--------|--------------------------|--------|
|      | Disk Size                 | % Used | Disk Size                | % Used |
| 1    | 1967                      | 54.59% | 1967                     | 55.69% |
| 2    | 1031                      | 68.45% | 1031                     | 55.80% |
| 3    | 1031                      | 68.41% | 1031                     | 55.76% |
| 4    | 1031                      | 0.30%  | 1031                     | 55.77% |

To start Capacity Balance via a CL command use the Start ASP Balance (STRASPBAL) command. For example, if you want to start a capacity balance on ASP 4 and have it run for 25 minutes, enter the following command: **STRASPBAL ASP(4) TYPE(\*CAPACITY) TIMLMT(25)**.

If you want to end a Capacity Balance before the time limit requested is reached, use the End ASP Balance (ENDASPBAL) command. For example, if you want to end a running capacity balance on ASP 4, enter the following command: **ENDASPBAL ASP(4)**.

## Hierarchical Storage Management (HSM) Balance

The high-use and low-use data on each disk unit in the ASP is redistributed. This is done so that the high-use data resides on 'fast' disk units and the low-use data resides on compression disk units, which

are typically slower than standard disk units. The ASP selected for a HSM Balance must have a combination of compression disk units and non-compression disk units. You can only run a HSM Balance following a Trace ASP Balance. The Trace ASP Balance function monitors the I/O activity on each of the disk units in the ASP to determine where the high-use and low-use data resides.

Compression disk units have larger capacity, but are somewhat slower than non-compression disk units. This is due to the overhead of compression and decompression, and the variations in the length of the data that is written to disk. Typically, data that is found on disk units has a wide range of access requirements. The HSM balance function moves data that is accessed infrequently to compression disk units. Disk compression makes infrequently accessed data available on-line at a lower cost. System throughput improves when you move high-use data off of compression disk units. Moving the low-use data to the large compression disk units makes additional capacity available on the standard disk units so high-use data can be allocated.

The Start ASP Balance (STRASPBAL) command is used to perform the HSM Balance function. For example, if you want to run a HSM balance on ASP 4 for 25 minutes, enter the following command: **STRASPBAL ASP(4) TYPE(\*HSM) TIMLMT(25)**.

If you want to end a HSM Balance before the time limit requested is reached, use the End ASP Balance (ENDASPBAL) command. For example, if you want to end a running HSM balance on ASP 4, enter the following command: **ENDASPBAL ASP(4)**.

## Usage Balance

The Usage Balance attempts to balance the usage of the disk units in an Auxiliary Storage Pool. The Usage Balance can only be done following a Trace ASP Balance. The Trace ASP Balance function monitors the I/O activity on each of the disk units in the ASP. It then determines where the frequently used and infrequently used data resides. The Usage Balance function utilizes that trace information. It adjusts the data on the disk units so future system activity will be more equally balanced amongst the disk units in the ASP.

If the system determines that all of the disk units are of approximately equal utilization, the balance will end very quickly. The Balance Usage function uses the Trace information in its calculations. If the trace data is old, or if your applications have changed to reference different data since the trace was run, the Usage Balance could result in very little improvement in your system throughput. It might even cause the throughput to decrease somewhat.

The Start ASP Balance (STRASPBAL) command is used to perform the Archive Balance function. For example, if you want to start a usage balance on ASP 4 to run for 25 minutes, enter the following command: **STRASPBAL ASP(4) TYPE(\*USAGE) TIMLMT(25)**.

If you want to end a Usage Balance before the time limit requested is reached, use the End ASP Balance (ENDASPBAL) command. For example, if you want to end a running usage balance on ASP 4, enter the following command: **ENDASPBAL ASP(4)**.

## ASP Trace

The Trace ASP Balance command monitors the frequency that data is accessed on the disk units in the Auxiliary Storage Pool. Each I/O to the disk units is monitored, and the results are recorded for use by the Balance commands. The statistics which are collected are cumulative. For example, suppose you start one Trace and it runs for 35 minutes. Then you start another trace on that ASP and it runs for 15 minutes. The second group of statistics is added to the first collection and the cumulative result is used to balance the ASP.

Select an Auxiliary Storage Pool that you want the system to monitor. The system will record all of the I/O activity on the disk units in that ASP. For example to start a trace on ASP 4 which will run for 35 minutes, enter the following command: **TRCASPBAL ASP(4) SET(\*ON) TIMLMT(35)**.

If you want to end a trace before the time limit requested on the Start Trace is reached, use the Trace ASP Balance (TRCASPBAL) command. For example, if you want to end the trace on ASP 4, enter the following command: **TRCASPBAL ASP(4) SET(\*OFF)**.

The collected statistics on each disk units I/O activity can be cleared by use of the TRCASPBAL command. You can clear old trace data if you do not want that data to be used in determining the locations of the high-use and low-use data on the disk units in the ASP. Use the Trace ASP Balance (TRCASPBAL) command to clear the trace data. For example, if you want to clear the trace data which has been collected from ASP 4, enter the following command: **TRCASPBAL ASP(4) SET(\*CLEAR)**.

---

## Determining adequate disk storage

If you need to know how much disk storage is available on your system, use the Work with System Status (WRKSYSSTS) command.

1. Type WRKSYSSTS at the command line. The Work with System Status display appears.
2. Record the values that are shown for System ASP and % system ASP used.
3. Use those values in the formula that is shown below to calculate the available free space on your system:

$$\text{System ASP} \times (100 - \% \text{ system ASP used}) \times 0.01 = \text{Available disk storage}$$

If the amount of storage is less than you need to complete your task, you must create more disk space. You can create more space by adding additional disk units or by cleaning your system of files and programs you no longer use.

---

## Part 7. Backup and Recovery Tools and Techniques

|                                                                                 |     |
|---------------------------------------------------------------------------------|-----|
| <b>Chapter 24. Examples: Techniques and Programming for Backup and Recovery</b> | 439 |
| Examples: Backup and Recovery                                                   | 439 |
| Using the Retrieve Journal Entry (RTVJRNE) Command in a Program                 | 439 |
| CL Program to Handle Escape Conditions                                          | 439 |
| Writing Output to Save Media Using the Receive Journal Entry Command            | 441 |
| Considerations When Writing to Tape                                             | 442 |
| Journal Entries Written to an ICF File                                          | 443 |





---

## Chapter 24. Examples: Techniques and Programming for Backup and Recovery

This chapter includes several different techniques that you can use to assist with and manage your backup and recovery processes.

---

### Examples: Backup and Recovery

Following are several examples of programs for working with backup and recovery.

#### Using the Retrieve Journal Entry (RTVJRNE) Command in a Program

Use the Retrieve Journal Entry (RTVJRNE) command in a control language program to retrieve a journal entry and place it in variables in the program. You can retrieve the following:

- Sequence number
- Journal code
- Entry type
- Journal receiver name
- Library name for the journal receiver
- Journal entry-specific data

For example, you can use this command to automate your recovery procedures or to change the journal receivers and then save them.

In Figure 35, the RTVJRNE command determines when job 000666/QPGMR/WORKST01 last opened file ORDEntp:

```
PGM
DCL &SEQ# TYPE(*DEC) LEN(10 0)
DCL &JRNE TYPE(*CHAR) LEN(200)
DCL &DATE TYPE(*CHAR) LEN(6)
DCL &TIME TYPE(*CHAR) LEN(6)
RTVJRNE JRN(DSTJRN/JRNLA) FILE(DSTPRODLIB/ORDENTP) +
        RCVRNG(DSTJRN/RCV30 DSTJRN/RCV27) FROMENT(*LAST) +
        TOENT(*FIRST) SEARCH(*DESCEND) +
        JRNCDE(F) ENTTYP(OP) JOB(000666/QPGMR/WORKST01) +
        RTNSEQNBR(&SEQ#) RTNJRNE(&JRNE)
CHGVAR &DATE (%SST(&JRNE 19 6))
CHGVAR &TIME (%SST(&JRNE 25 6))
ENDPGM
```

Figure 35. Program for Retrieving Journal Entries

#### CL Program to Handle Escape Conditions

You normally use the APYJRNCHG command to perform object recovery. However, usable journal receivers are needed to successfully use this command. If usable journal receivers are not found, an escape message is sent. Figure 36 on page 440 demonstrates how this escape condition can be handled in a CL program by prompting for restoration of the required receiver. This example uses database files. You can extend this example to use the APYJRNCHG command with all object types that support journaling.

```

FILERECOV: PGM
:
:
APYJRNCHG JRN(JRNLIB/JRNA) FILE((LIBA/FILEA)) +
RVRNG(RCVLIB/RCV1 *CURRENT)
MONMSG MSGID(CPF7053 CPF9801) +
EXEC(CALL PGM(FIXLIB/RSTRCV) PARM(FILERECOV))
:
:
ENDPGM
:
:
RSTRCV: PGM PARM(&PGMNM)
/* Recover a nonexistent or unusable receiver */
/* in RVRNG by prompting for a restore of */
/* receiver. */
DCL *PGMNM TYPE(*CHAR) LEN(10) /* name of program */
/* calling RSTRCV */
/* that received */
/* CPF7053 or */
/* CPF9801 */
DCL &MSGDATA TYPE(*CHAR) LEN(22) /* variable for */
/* CPF7053 or */
/* CPF9801 */
DCL &MSGDID TYPE(*CHAR) LEN(7) /* escape message */
/* ID */
DCL &RCVNAME TYPE(*CHAR) LEN(10) /* name of */
/* receiver to */
/* restore */
DCL &RCVLIB TYPE(*CHAR) LEN(10) /* library name */
/* of receiver to */
/* restore */
DCL &RCODE TYPE(*CHAR) LEN(2) VALUE(x'0001')
/* reason code 1 of CPF7053 */
RCVMSG PGMQ(*SAME &PGMNM) MSGTYPE(*EXCP) WAIT(0) +
RMV(*NO) MSGDTA(&MSGDATA) MSGID(&MSGID)

```

Figure 36. Example Program Prompts for Restoring the Required Receiver For an APYJRNCHG (Part 1 of 2)

```

IF COND(&MSGID *EQ 'CPF9801') THEN(DO) /* CPF9801 occurred */
CHGVAR &RCVNAME (%SST(&MSGDATA 1 10)) /* get receiver */
/* from message */
/* data */
CHGVAR &RCVLIB (%SST(&MSGDATA 11 10)) /* get library */
/* name from */
/* message data */
? RSTOBJ OBJ(&RCVNAME) SAVLIB(&RCVLIB) OBJTYPE(*JRNRCV)
/* display RSTOBJ prompt */
ENDDO
ELSE DO
IF COND((&MSGID *EQ 'CPF7053') & (%SST(&MSGDATA 1 2) +
*EQ &RCODE)) THEN(DO) /*CPF7053 RC(1) occurred*/
CHGVAR &RCVNAME (%SST(&MSGDATA 3 10)) /* get receiver */
/* name from */
/* message data */
CHGVAR &RCVLIB (%SST(&MSGDATA 13 10)) /* get library */
/* name from */
/* message data */
? RSTOBJ OBJ(&RCVNAME) SAVLIB(&RCVLIB) OBJTYPE(*JRNRCV)
/* display restore prompt */
ENDDO
ELSE
.
.
ENDDO
ENDPGM

```

Figure 36. Example Program Prompts for Restoring the Required Receiver For an APYJRNCHG (Part 2 of 2)

## Writing Output to Save Media Using the Receive Journal Entry Command

**Note:** You may want to consider using the remote journal function to transfer your journal receiver data to another server instead of the following. See the Journal Management topic in the iSeries Information Center (<http://www.ibm.com/eserver/series/infocenter>) for more information.

Figure 37 on page 442 shows an RPG program that is being used as the exit program for the Receive Journal Entry (RCVJRNE) command. This example writes output onto tape media. See “Journal Entries Written to an ICF File” on page 443 for a discussion of changing the sample to write output to an i5/OS-ICF file. See the Journal Management topic in the iSeries Information Center (<http://www.ibm.com/eserver/series/infocenter>) for a discussion of how to use the RCVJRNE command.

```

SEQNBR *... .. 1 ... .. 2 ... .. 3 ... .. 4 ... .. 5 ... .. 6 ... .. 7

1.00   FTAPE   0   F   300           SEQ
2.00   IJRNENT      DS                300
3.00   I                1   50JOENTL
4.00   C                *ENTRY   PLIST
5.00   C                PARM       JRNENT
6.00   C                PARM       CALLCD  1
7.00   C                CALLCD   IFEQ '1'           Entry rcvd
8.00   C* Ensure journal entry is not being truncated
9.00   C                JOENTL   CABGT300   RETURN   H1   If GT output
10.00  C                ADD 1       OUTRCD  70       Bump ctr
11.00  C                EXCPTOUTPUT           Output
12.00  C                END           Entry rcvd
13.00  C                CALLCD   IFEQ '0'           Rdy to wait
14.00  C                EXSR FORCE           Force out
15.00  C                END           Rdy to wait
16.00  C                SHTDN           31         Test shtdwn
17.00  C  31           DO           If shtdwn
18.00  C                EXSR FORCE           Force out
19.00  C                MOVE '9'       CALLCD           Set to end
20.00  C                SETON           LR         Set LR
21.00  C                END           If shtdwn
22.00  C                RETURN  TAG       Return tag
23.00  C                RETRN           Return
24.00  C                FORCE   BEGSR           Force out
25.00  C                OUTRCD  IFNE *ZERO       If rcds
26.00  C                FEOD TAPE           FEOD
27.00  C                Z-ADDO       OUTRCD       Reset
28.00  C                END           If rcds
29.00  C                ENDSR           End subr
30.00  OTAPE   E                OUTPUT
31.00  0                JRNENT

```

Figure 37. Program for writing RCVJRNE output to save media

## Considerations When Writing to Tape

A separate job must be in continuous operation and dedicated to converting entries to tape. Before issuing the RCVJRNE command, your job should issue an OVRTAPF command, specifying fixed-length blocked records, to direct the RPG file TAPE to a tape device.

You should not consider this approach with a streaming tape device. A user auxiliary storage pool (ASP) is a preferred solution instead of a tape. However, this approach is similar to writing journal entries to a communications line.

The RPG program is written assuming that the largest journal entry to be passed is 300 bytes. This is the size that is given to the data structure JRNENT. It allows a record size of 175 bytes plus the 125 bytes of journal entry identifier information and qualifier information. A check is made in the program to ensure that the record image is not being truncated:

- If a code of 1 is passed from the RCVJRNE command, the program ensures that the journal entry does not exceed 300 bytes. If it does, the program sets on the H1 indicator and returns. The program adds 1 to the counter and writes the record to the tape output file. Because this is an output-only file, RPG automatically blocks the records within the RPG program.

When full, the block is passed to tape data management, where additional blocking can occur and double-buffering to the tape device is provided. This ensures that the tape performance is optimal. Because the records are not written directly to tape when the program requests the output, there can be some interval of time before the records are written to the external media.

- When a code of 0 is passed from the RCVJRNE command, no more entries exist in the journal. On the return to the RCVJRNE command, the DELAY parameter value specified on the RCVJRNE command is used to wait before checking for additional entries. To avoid keeping the records in the various buffers while the delay occurs, the program forces the records to the tape device by using the force end-of-data operation (FEOD).

This causes all records in either the RPG or tape data management buffers to be written to the tape device, and a device completion notification to be received before proceeding to the next instruction. If there is less than a full block of records, a short block is written to tape. Tape data management correctly handles the short block if the tape is read in a subsequent program. When the return occurs to the RCVJRNE command, the delay time occurs whether or not any journal entries have arrived since the last time the exit program was called.

The RPG program increments a counter each time a record is written and resets it when the FEOD operation is used. The program issues the FEOD operation only if a record has been written which avoids calling tape data management when there are no records to be written. (If tape data management has no records in its buffers when the FEOD operation occurs, no empty block is written, but system overhead occurs.)

The RPG program uses the SHTDN operation code to check for requests to end the job from external functions such as an End Job (ENDJOB) or End Subsystem (ENDSBS) command with OPTION(\*CNTRLD). If end-of-job is requested, the program forces the records from the buffers, sets the counter to 9 (which tells the RCVJRNE command to complete normally, and sets the LR indicator on). The RETRN operation is then issued and:

- If LR is on, the program's working storage is returned to the system.
- If LR is off, the program remains active and waits to be called again by the RCVJRNE command.

Writing to tape occurs either by the buffers being full or when the FEOD operation is used. This trade-off allows good performance when many journal entries are written and minimizes the number of times the FEOD operation is used to ensure that the entries are actually on the tape. With the sample program, the value of the DELAY parameter and the work management specifications for your job (for example, pool size and priority) are the major factors controlling the frequency with which the entries are written and the performance implications on the system for this function.

If the system ends abnormally while the job is running, so that a successful end-of-file indication is not written, the subsequent reading of the tape can produce results that cannot be predicted. Blocks that were successfully written can be correctly read. The last block and any subsequent data that is on the tape from a previous use can produce results that cannot be predicted. Copy the tape to a database file and examine the contents before using the data.

The journal sequence numbers are in ascending sequence (unless they have been reset) and can be used to determine where the logical end-of-file exists. To avoid confusion, delete the tapes used for this type of approach.

Assume, for example, that the largest record size journaled was 175 bytes and the tape record size 300 bytes, as in Figure 37 on page 442. If you need to increase the tape record size, change the value of 300 in the RPG file description specification, the input specification, and factor 2 of the CABGT operation code. If there are some significantly larger records being journaled, consider how much excess media is used. An alternative would be to examine the individual fields (*JOENTL*) and write two or more small records for each large record.

## Journal Entries Written to an ICF File

This topic discusses the differences in programming when you use an ICF file instead of a tape file as output for the RCVJRNE command. Refer to the program in Figure 37 on page 442.

If you use an ICF file to transmit journal entries to another system, the FEOD operation does not apply. Instead, there are data description specifications (DDS) words (for example, FRCDTA) to force records from the buffers.

Usually the number of blocks transmitted to tape by records less than 175 bytes is a minimal performance consideration. On communications lines, however, this number can be significant. To avoid sending unnecessary trailing blanks, consider decreasing the length of the record being transmitted by the variable length function (VARLEN DDS keyword). For a discussion of the variable length function, see the *Intrasystem Communications Programming*.

If binary synchronous equivalence link (BSC<sub>CEL</sub>) is used, trailing blanks will be truncated automatically if the TRUNC parameter is specified on the Add ICF Device Entry (ADDICFDEVE) or the Override ICF Device Entry (OVRICFDEVE) command. Refer to the *BSC Equivalence Link Programming* book for more information about the function of the TRUNC parameter.

---

## Appendix A. Licensed Internal Code Installation Error Displays

One of the following three screens may be displayed if you chose option 1 (restore) on the install selection menu and the selected disk is not currently a load source disk. In this case, the restore cannot be done. If the selected disk is the correct one to install to, return to the selection menu and choose the correct install option 2, 3, 4, or 5 to initialize the disk and perform an installation. If the selected disk is not the correct one, or if an existing load source disk should have been found, follow the appropriate procedures to determine why the correct disk did not report in, or was not recognized.

If there is information about a missing disk(s) (second or third of the following three screens), it indicates what the last load source disk was on this system. If that disk should still exist (it has not been removed or replaced), determine why it was not found. If that disk has been removed or replaced, then this is just informational and may not indicate an error.

Restore Licensed Internal Code

Disk selected to write the Licensed Internal Code to:

| Serial Number | Type  | Model | I/O Bus | Controller | Device |
|---------------|-------|-------|---------|------------|--------|
| _____         | _____ | _____ | _____   | _____      | _____  |

The disk selected has not previously been a load source. The restore of the Licensed Internal Code cannot be done.

Press Enter to return to the Install Licensed Internal Code screen.

Restore Licensed Internal Code

Disk selected to write the Licensed Internal Code to:

| Serial Number | Type  | Model | I/O Bus | Controller | Device |
|---------------|-------|-------|---------|------------|--------|
| _____         | _____ | _____ | _____   | _____      | _____  |

The load source disk could not be found (see disk information below).

Missing load source disk:

| Serial Number | Type  | Model | I/O Bus | Controller | Device |
|---------------|-------|-------|---------|------------|--------|
| _____         | _____ | _____ | _____   | _____      | _____  |

The disk selected has not previously been a load source. The restore of the Licensed Internal Code cannot be done.

Press Enter to return to the Install Licensed Internal Code screen.

Restore Licensed Internal Code

Disk selected to write the Licensed Internal Code to:  
Serial Number    Type    Model    I/O Bus    Controller    Device  
\_\_\_\_\_    \_\_\_\_\_    \_\_\_\_\_    \_\_\_\_\_    \_\_\_\_\_    \_\_\_\_\_

The load source disk and its mirrored pair could not be found  
(see disk information below).

Missing load source disk:  
Serial Number    Type    Model    I/O Bus    Controller    Device  
\_\_\_\_\_    \_\_\_\_\_    \_\_\_\_\_    \_\_\_\_\_    \_\_\_\_\_    \_\_\_\_\_

The disk selected has not previously been a load source. The  
restore of the Licensed Internal Code cannot be done.

Press Enter to return to the Install Licensed Internal Code  
screen.

The following screen can be displayed if you chose option 1 (restore) on the install selection menu, but the release level of the Licensed Internal Code on the install media cannot be restored over the current release level on disk. Verify that you have the correct install media (version/release/modification level). If the level is correct, then you must do an initialize and install to get the new LIC installed over the existing LIC on the disk.

Restore Licensed Internal Code

Disk selected to write the Licensed Internal Code to:  
Serial Number    Type    Model    I/O Bus    Controller    Device  
\_\_\_\_\_    \_\_\_\_\_    \_\_\_\_\_    \_\_\_\_\_    \_\_\_\_\_    \_\_\_\_\_

The release level of the Licensed Internal Code on the distribution  
media cannot be restored over the existing release level on the  
selected disk.

Press Enter to return to the Install Licensed Internal Code  
screen.

The following screen can be displayed if you chose option 1 (restore) on the install selection menu and the selected disk is currently a load source disk, but the pertinent data on the disk cannot be read and, therefore, a restore cannot be done. You must do an initialize and installation to install the new LIC on this disk.

Restore Licensed Internal Code

Disk selected to write the Licensed Internal Code to:  
Serial Number    Type    Model    I/O Bus    Controller    Device  
\_\_\_\_\_    \_\_\_\_\_    \_\_\_\_\_    \_\_\_\_\_    \_\_\_\_\_    \_\_\_\_\_

The selected disk cannot be read. The restore of the Licensed  
Internal Code cannot be done.

Press Enter to return to the Install Licensed Internal Code  
screen.

The following screen can be displayed if two load source disks are detected on your system. The *best* disk was selected for the restore or installation. The data about the other disk is informational so you can



verify that the correct disk was selected. If the correct disk was not selected, follow the appropriate procedures to disable or remove the selected disk, so that the other disk is selected when you rerun the task.

```

Install Licensed Internal Code - Warning

Disk selected to write the Licensed Internal Code to:
Serial Number  Type  Model  I/O Bus  Controller  Device
-----
Warning:
Another load source disk has also been found on this system.
If you continue the restore or install, the disk listed
above will be used.

Additional load source disk:
Serial Number  Type  Model  I/O Bus  Controller  Device
-----

Press Enter to continue the restore or install on the selected
disk.
```

The following screen is displayed if mirroring is active but one disk of the load source mirrored pair cannot be found. The restore or installation can still continue on the selected disk, but will not be mirrored until the missing disk becomes again active. You may want to follow the appropriate procedures to determine why one of the disks were not found.

```

Install Licensed Internal Code - Warning

Disk selected to write the Licensed Internal Code to:
Serial Number  Type  Model  I/O Bus  Controller  Device
-----
Warning:
The mirrored unit for this load source was not found (see
disk information below). The restore or install can continue
on the selected load source. The missing mirrored unit will
be suspended when the restore or install is complete.

Missing load source disk:
Serial Number  Type  Model  I/O Bus  Controller  Device
-----

Press Enter to continue the restore or install on the selected
disk.
```

The following two screens are displayed if the disk selected for the install to is not the same disk that was previously the load source on this system. If the missing disk should still exist (it has not been removed or replaced), determine why it was not found. If the disk was removed or replaced, this data is just informational and may not indicate an error.

Install Licensed Internal Code - Warning

Disk selected to write the Licensed Internal Code to:

| Serial Number | Type | Model | I/O Bus | Controller | Device |
|---------------|------|-------|---------|------------|--------|
| _____         | ___  | ___   | ___     | ___        | ___    |

Warning:

The load source disk could not be found (see disk information below).

Missing load source disk:

| Serial Number | Type | Model | I/O Bus | Controller | Device |
|---------------|------|-------|---------|------------|--------|
| _____         | ___  | ___   | ___     | ___        | ___    |

Press Enter to continue the initialize and install on the selected disk.

Install Licensed Internal Code - Warning

Disk selected to write the Licensed Internal Code to:

| Serial Number | Type | Model | I/O Bus | Controller | Device |
|---------------|------|-------|---------|------------|--------|
| _____         | ___  | ___   | ___     | ___        | ___    |

Warning:

The load source disk and its mirrored pair could not be found (see disk information below).

Missing load source disk:

| Serial Number | Type | Model | I/O Bus | Controller | Device |
|---------------|------|-------|---------|------------|--------|
| _____         | ___  | ___   | ___     | ___        | ___    |
| _____         | ___  | ___   | ___     | ___        | ___    |

Press Enter to continue the initialize and install on the selected disk.

The following screen is displayed if mirroring is active and the active load source disk can not be found. One unit of the load source mirrored pair was found but is not currently active. You can install to it, but you will not be allowed to IPL past DST with it. You may want to follow the appropriate procedures to determine why the active load source disk can not be found.

Install Licensed Internal Code - Warning

Disk selected to write the Licensed Internal Code to:

| Serial Number | Type | Model | I/O Bus | Controller | Device |
|---------------|------|-------|---------|------------|--------|
| _____         | ___  | ___   | ___     | ___        | ___    |

Warning:

A load source disk could not be found (see disk information below).

The disk selected to be the load source (see above) is suspended. You may install to it and perform an IPL from it to get to DST and perform DASD diagnostics. However, you will not be able to perform an IPL past DST with it.

Missing load source disk:

| Serial Number | Type | Model | I/O Bus | Controller | Device |
|---------------|------|-------|---------|------------|--------|
| _____         | ___  | ___   | ___     | ___        | ___    |

Press Enter to continue the restore or install on the selected disk.

One of the following three screens is displayed if no disk can be found. That is, no disk reported in, or was recognized by the system.

If information is supplied about a missing disk(s) (second and third of the three screens), it indicates what was the last load source disk on this system. If that disk should still exist (it has not been removed or replaced), then determine why it was not found. If that disk has been removed or replaced, then this data is just informational and may not be the reason for the error.

Install Licensed Internal Code - Error

Error:

A disk could not be selected to be the load source.  
You can return to the Dedicated Service Tools display and run diagnostics to determine why a disk could not be selected.

Correct the problem and install the Licensed Internal Code again.

Press Enter to return to the Dedicated Service Tools display.

Install Licensed Internal Code - Error

Error:

The load source disk could not be found (see disk information below).

Missing load source disk:

| Serial Number | Type | Model | I/O Bus | Controller | Device |
|---------------|------|-------|---------|------------|--------|
| _____         | ___  | ___   | ___     | ___        | ___    |

A disk could not be selected to be the load source.  
You can return to the Dedicated Service Tools display and run diagnostics to determine why a disk could not be selected.

Correct the problem and install the Licensed Internal Code again.

Press Enter to return to the Dedicated Service Tools display.

Install Licensed Internal Code - Error

Error:

The load source disk and its mirrored pair could not be found (see disk information below).

Missing load source disk:

| Serial Number | Type | Model | I/O Bus | Controller | Device |
|---------------|------|-------|---------|------------|--------|
| _____         | ___  | ___   | ___     | ___        | ___    |

A disk could not be selected to be the load source.  
You can return to the Dedicated Service Tools display and run diagnostics to determine why a disk could not be selected.

Correct the problem and install the Licensed Internal Code again.

Press Enter to return to the Dedicated Service Tools display.

One of the following two screens is displayed if a disk is found, but it is not at a valid address to be the load source.

If there is information about a missing disk(s) (the second screen), it indicates what the last load source disk was on this system. If that disk should still exist (it has not been removed or replaced), determine why it was not found. If it has been removed or replaced, this is just informational and may not be the reason for the error.

```

Install Licensed Internal Code - Error

Error:
  A disk was found, but it is not at a valid address to be the
  load source device.

Selected disk:
  Serial Number  Type  Model  I/O Bus  Controller  Device
  _____  ___  ___  _____  _____  _____

The install cannot be done. Press Enter to return to the Dedicated
Service Tools display.

```

```

Install Licensed Internal Code - Error

Error:
  A disk was found, but it is not at a valid address to be the
  load source device.

Selected disk:
  Serial Number  Type  Model  I/O Bus  Controller  Device
  _____  ___  ___  _____  _____  _____

The following disk was a load source previously, but could not be
found.

Missing load source disk:
  Serial Number  Type  Model  I/O Bus  Controller  Device
  _____  ___  ___  _____  _____  _____

The install cannot be done. Press Enter to return to the Dedicated
Service Tools display.

```

The following screen is displayed if an existing load source disk is found, but is not at a valid address to be the load source. If it was intentionally moved, determine why no other disk could be found to which to install. If this is the correct disk, determine why it is not at a valid address.

```

Install Licensed Internal Code - Error

Error:
  The following disk was a load source previously, but it is not
  currently at a valid address to be the load source device.

Selected disk:
  Serial Number  Type  Model  I/O Bus  Controller  Device
  _____  ___  ___  _____  _____  _____

The install cannot be done. Press Enter to return to the Dedicated
Service Tools display.

```

The following screen is displayed if an existing load source disk was found and:

- Is not at a valid address to be the load source.
- Is one unit of a mirrored pair.
- Is currently not the active load source.

Information about the previously active load source is also listed. If this load source should still be available to install to, use the appropriate procedures to determine why it could not be found.

Install Licensed Internal Code - Error

Error:

The following disk was a load source, but it is not currently active, and it is not at a valid address to be the load source device.

Selected disk:

| Serial Number | Type | Model | I/O Bus | Controller | Device |
|---------------|------|-------|---------|------------|--------|
| _____         | ___  | ___   | ___     | ___        | ___    |

The following disk was the previously active load source, but it could not be found.

Missing load source disk:

| Serial Number | Type | Model | I/O Bus | Controller | Device |
|---------------|------|-------|---------|------------|--------|
| _____         | ___  | ___   | ___     | ___        | ___    |

The install cannot be done. Press Enter to return to the Dedicated Service Tools display.



---

## Appendix B. Example Disaster Recovery Plan

The objective of a disaster recovery plan is to ensure that you can respond to a disaster or other emergency that affects information systems and minimize the effect on the operation of the business. This topic provides you with guidelines for the kind of information and procedures that you need to recover from a disaster. When you have prepared the information described in this topic, store your document in a safe, accessible location off site.

---

### Section 1. Example: Major Goals of a Disaster Recovery Plan

The major goals of this plan are the following:

- To minimize interruptions to the normal operations.
- To limit the extent of disruption and damage.
- To minimize the economic impact of the interruption.
- To establish alternative means of operation in advance.
- To train personnel with emergency procedures.
- To provide for smooth and rapid restoration of service.

---

### Section 2. Example: Personnel

| Data Processing Personnel |          |         |           |
|---------------------------|----------|---------|-----------|
| Name                      | Position | Address | Telephone |
|                           |          |         |           |
|                           |          |         |           |
|                           |          |         |           |
|                           |          |         |           |
|                           |          |         |           |

| Data Processing Personnel |          |         |           |
|---------------------------|----------|---------|-----------|
| Name                      | Position | Address | Telephone |
|                           |          |         |           |
|                           |          |         |           |
|                           |          |         |           |
|                           |          |         |           |
|                           |          |         |           |

| Data Processing Personnel |          |         |           |
|---------------------------|----------|---------|-----------|
| Name                      | Position | Address | Telephone |
|                           |          |         |           |
|                           |          |         |           |
|                           |          |         |           |
|                           |          |         |           |
|                           |          |         |           |

## Organization Chart

Include a copy of the organization chart with your plan.

---

## Section 3. Example: Application Profile

Use the Display Software Resources (DSPSFWRSC) command to complete this table.

| Application Profile |                      |                         |              |          |
|---------------------|----------------------|-------------------------|--------------|----------|
| Application Name    | Critical<br>Yes / No | Fixed Asset<br>Yes / No | Manufacturer | Comments |
|                     |                      |                         |              |          |
|                     |                      |                         |              |          |
|                     |                      |                         |              |          |
|                     |                      |                         |              |          |
|                     |                      |                         |              |          |

**Comment Legend:**

1. Runs daily.
2. Runs weekly on \_\_\_\_\_.
3. Runs monthly on \_\_\_\_\_.

---

## Section 4. Example: Inventory Profile

Use the Work with Hardware Products (WRKHDWPRD) command to complete this table:

| Application Profile |             |       |                  |                  |      |
|---------------------|-------------|-------|------------------|------------------|------|
| Manufacturer        | Description | Model | Serial<br>Number | Own or<br>Leased | Cost |
|                     |             |       |                  |                  |      |
|                     |             |       |                  |                  |      |
|                     |             |       |                  |                  |      |
|                     |             |       |                  |                  |      |
|                     |             |       |                  |                  |      |

**Notes:**

1. This list should be audited every \_\_\_\_\_ months.
2. This list should include:
 

|                           |                            |
|---------------------------|----------------------------|
| Processing units          | System printer             |
| Disk units                | Tape and optical devices   |
| Models                    | Controllers                |
| Workstation controllers   | I/O Processors             |
| Personal computers        | General data communication |
| Spare workstations        | Spare displays             |
| Telephones                | Racks                      |
| Air conditioner or heater | Humidifier or dehumidifier |





## Disaster Action Checklist

1. Plan Initiation
  - a. Notify senior management
  - b. Contact and set up disaster recovery team
  - c. Determine degree of disaster
  - d. Implement proper application recovery plan dependent on extent of disaster (see Section 7. Recovery Plan—Mobile Site)
  - e. Monitor progress
  - f. Contact backup site and establish schedules
  - g. Contact all other necessary personnel—both user and data processing
  - h. Contact vendors—both hardware and software
  - i. Notify users of the disruption of service
2. Follow-Up Checklist
  - a. List teams and tasks of each
  - b. Obtain emergency cash and set up transportation to and from backup site, if necessary
  - c. Set up living quarters, if necessary
  - d. Set up eating establishments, as required
  - e. List all personnel and their telephone numbers
  - f. Establish user participation plan
  - g. Set up the delivery and the receipt of mail
  - h. Establish emergency office supplies
  - i. Rent or purchase equipment, as needed
  - j. Determine applications to be run and in what sequence
  - k. Identify number of workstations needed
  - l. Check out any off-line equipment needs for each application
  - m. Check on forms needed for each application
  - n. Check all data being taken to backup site before leaving and leave inventory profile at home location
  - o. Set up primary vendors for assistance with problems incurred during emergency
  - p. Plan for transportation of any additional items needed at backup site
  - q. Take directions (map) to backup site
  - r. Check for additional magnetic tapes, or optical media if required
  - s. Take copies of system and operational documentation and procedural manuals.
  - t. Ensure that all personnel involved know their tasks
  - u. Notify insurance companies

## Recovery Start-up Procedures for Use after Actual Disaster

1. Notify \_\_\_\_\_ Disaster Recovery Services of the need to utilize service and of recovery plan selection.

**Note:** Guaranteed delivery time countdown begins at the time \_\_\_\_\_ is notified of recovery plan selection.

- a. Disaster notification numbers

\_\_\_\_\_ or \_\_\_\_\_

These telephone numbers are in service from \_\_\_\_\_ am until \_\_\_\_\_ pm Monday through Friday.

2. Disaster notification number

\_\_\_\_\_

This telephone number is in service for disaster notification after business hours, on weekends, and during holidays. Please use this number only for the notification of the actual disaster.

3. Provide \_\_\_\_\_ with an equipment delivery site address (when applicable), a contact, and an alternate contact for coordinating service and telephone numbers at which contacts can be reached 24 hours a day.
4. Contact power and telephone service suppliers and schedule any necessary service connections.
5. Notify \_\_\_\_\_ immediately if any related plans should change.

---

## Section 7. Recovery Plan—Mobile Site

1. Notify \_\_\_\_\_ of the nature of the disaster and the need to select the mobile site plan.
2. Confirm in writing the substance of the telephone notification to \_\_\_\_\_ within 48 hours of the telephone notification.
3. Confirm all needed backup media are available to load the backup machine.
4. Prepare a purchase order to cover the use of backup equipment.
5. Notify \_\_\_\_\_ of plans for a trailer and its placement (on \_\_\_\_\_ side of \_\_\_\_\_). (See “Mobile Site Setup Plan.”)
6. Depending on communication needs, notify telephone company (\_\_\_\_\_) of possible emergency line changes.
7. Begin setting up power and communications at \_\_\_\_\_.
  - a. Power and communications are prearranged to hook into when trailer arrives.
  - b. At the point where telephone lines come into the building (\_\_\_\_\_), break the current linkage to the administration controllers (\_\_\_\_\_). These lines are rerouted to lines going to the mobile site. They are linked to modems at the mobile site.

The lines currently going from \_\_\_\_\_ to \_\_\_\_\_ would then be linked to the mobile unit via modems.
  - c. This could conceivably require \_\_\_\_\_ to redirect lines at \_\_\_\_\_ complex to a more secure area in case of disaster.
8. When the trailer arrives, plug into power and do necessary checks.
9. Plug into the communications lines and do necessary checks.
10. Begin loading system from backups (see “Section 9. Restoring the Entire System” on page 458).
11. Begin normal operations as soon as possible:
  - a. Daily jobs
  - b. Daily saves
  - c. Weekly saves
12. Plan a schedule to back up the system in order to restore on a home-base computer when a site is available. (Use regular system backup procedures).
13. Secure mobile site and distribute keys as required.
14. Keep a maintenance log on mobile equipment.

### Mobile Site Setup Plan

Attach the mobile site setup plan here.

## Communication Disaster Plan

Attach the communication disaster plan, including the wiring diagrams.

## Electrical Service

Attach the electrical service diagram here.

---

## Section 8. Recovery Plan—Hot Site

The disaster recovery service provides an alternate hot site. The site has a backup system for temporary use while the home site is being reestablished.

1. Notify \_\_\_\_\_ of the nature of the disaster and of its desire for a hot site.
2. Request air shipment of modems to \_\_\_\_\_ for communications. (See \_\_\_\_\_ for communications for the hot site.)
3. Confirm in writing the telephone notification to \_\_\_\_\_ within 48 hours of the telephone notification.
4. Begin making necessary travel arrangements to the site for the operations team.
5. Confirm that you have enough save media and that it is packed for shipment to restore on the backup system.
6. Prepare a purchase order to cover the use of the backup system.
7. Review the checklist for all necessary materials before departing to the hot site.
8. Make sure that the disaster recovery team at the disaster site has the necessary information to begin restoring the site. (See “Section 12. Disaster Site Rebuilding” on page 461).
9. Provide for travel expenses (cash advance).
10. After arriving at the hot site, contact home base to establish communications procedures.
11. Review materials brought to the hot site for completeness.
12. Start to load the system from the save media.
13. Begin normal operations as soon as possible:
  - a. Daily jobs
  - b. Daily saves
  - c. Weekly saves
14. Plan the schedule to back up the hot-site system in order to restore on the home-base computer.

## Hot-Site System Configuration

Attach the hot-site system configuration here.

---

## Section 9. Restoring the Entire System

To get your system back to the way it was before the disaster, use the procedures in “Recovering your entire system after a complete system loss—Checklist 20” on page 85.

**Before You Begin:** Find the following save media, equipment, and information from the on-site tape vault or the off-site storage location:

- If you install from the alternate installation device, you need both your save media and the CD-ROM media containing the Licensed Internal Code.
- All save media from the most recent complete save operation

- The most recent save media from saving security data (SAVSECDTA or SAVSYS)
- The most recent save media from saving your configuration, if necessary
- All save media that contains journals and journal receivers that you saved since the most recent daily save operation
- All save media from the most recent daily save operation
- PTF list (stored with the most recent complete save media, weekly save media, or both)
- Save media list from most recent complete save operation
- Save media list from most recent weekly save operation
- Save media list from daily saves
- History log from the most recent complete save operation
- History log from the most recent weekly save operation
- History log from the daily save operations
- The *Install, upgrade, or delete i5/OS and related software* book
- The *Backup and Recovery* book
- Telephone directory
- Modem manual
- Tool kit

---

## Section 10. Rebuilding Process

The management team must assess the damage and begin the reconstruction of a new data center.

If the original site must be restored or replaced, the following are some of the factors to consider:

- What is the projected availability of all needed computer equipment?
- Will it be more effective and efficient to upgrade the computer systems with newer equipment?
- What is the estimated time needed for repairs or construction of the data site?
- Is there an alternative site that more readily could be upgraded for computer purposes?

Once the decision to rebuild the data center has been made, go to “Section 12. Disaster Site Rebuilding” on page 461.

---

## Section 11. Testing the Disaster Recovery Plan

In successful contingency planning, it is important to test and evaluate the plan regularly. Data processing operations are volatile in nature, resulting in frequent changes to equipment, programs, and documentation. These actions make it critical to consider the plan as a changing document.

Table 78 should be helpful for conducting a recovery test.

*Table 78. Checklist for Testing the Disaster Recovery Plan*

| Item                              | Yes | No | Applicable | Not Applicable | Comments |
|-----------------------------------|-----|----|------------|----------------|----------|
| <i>Conducting a Recovery Test</i> |     |    |            |                |          |

Table 78. Checklist for Testing the Disaster Recovery Plan (continued)

| Item                                                                                                                                                                                                                                                                                                                                                                                                                                                                                                                                                                                                                                                                                                                                                                                                                                                                                                                                                                                                 | Yes | No | Applicable | Not Applicable | Comments |
|------------------------------------------------------------------------------------------------------------------------------------------------------------------------------------------------------------------------------------------------------------------------------------------------------------------------------------------------------------------------------------------------------------------------------------------------------------------------------------------------------------------------------------------------------------------------------------------------------------------------------------------------------------------------------------------------------------------------------------------------------------------------------------------------------------------------------------------------------------------------------------------------------------------------------------------------------------------------------------------------------|-----|----|------------|----------------|----------|
| <ol style="list-style-type: none"> <li>1. Select the purpose of the test. What aspects of the plan are being evaluated?</li> <li>2. Describe the objectives of the test. How will you measure successful achievement of the objectives?</li> <li>3. Meet with management and explain the test and objectives. Gain their agreement and support.</li> <li>4. Have management announce the test and the expected completion time.</li> <li>5. Collect test results at the end of the test period.</li> <li>6. Evaluate results. Was recovery successful? Why or why not?</li> <li>7. Determine the implications of the test results. Does successful recovery in a simple case imply successful recovery for all critical jobs in the tolerable outage period?</li> <li>8. Make recommendations for changes. Call for responses by a given date.</li> <li>9. Notify other areas of results. Include users and auditors.</li> <li>10. Change the disaster recovery plan manual as necessary.</li> </ol> |     |    |            |                |          |
| <i>Areas to be Tested</i>                                                                                                                                                                                                                                                                                                                                                                                                                                                                                                                                                                                                                                                                                                                                                                                                                                                                                                                                                                            |     |    |            |                |          |

Table 78. Checklist for Testing the Disaster Recovery Plan (continued)

| Item                                                                                                                                                                                                                                                                                                                                                                                                                                                                                                                                                                                                                                                                                                                                                                                                                                                                                                                                                                                                                                                                                                                                                                                                                                                                                                                                                                                                                                                                                                                                                                                                                                                                                                                                          | Yes | No | Applicable | Not Applicable | Comments |
|-----------------------------------------------------------------------------------------------------------------------------------------------------------------------------------------------------------------------------------------------------------------------------------------------------------------------------------------------------------------------------------------------------------------------------------------------------------------------------------------------------------------------------------------------------------------------------------------------------------------------------------------------------------------------------------------------------------------------------------------------------------------------------------------------------------------------------------------------------------------------------------------------------------------------------------------------------------------------------------------------------------------------------------------------------------------------------------------------------------------------------------------------------------------------------------------------------------------------------------------------------------------------------------------------------------------------------------------------------------------------------------------------------------------------------------------------------------------------------------------------------------------------------------------------------------------------------------------------------------------------------------------------------------------------------------------------------------------------------------------------|-----|----|------------|----------------|----------|
| <ol style="list-style-type: none"> <li>1. Recovery of individual application systems by using files and documentation stored off-site.</li> <li>2. Reloading of system save media and performing an IPL by using files and documentation stored off-site.</li> <li>3. Ability to process on a different computer.</li> <li>4. Ability of management to determine priority of systems with limited processing.</li> <li>5. Ability to recover and process successfully without key people.</li> <li>6. Ability of the plan to clarify areas of responsibility and the chain of command.</li> <li>7. Effectiveness of security measures and security bypass procedures during the recovery period.</li> <li>8. Ability to accomplish emergency evacuation and basic first-aid responses.</li> <li>9. Ability of users of real-time systems to cope with a temporary loss of on-line information.</li> <li>10. Ability of users to continue day-to-day operations without applications or jobs that are considered noncritical.</li> <li>11. Ability to contact the key people or their designated alternates quickly.</li> <li>12. Ability of data entry personnel to provide the input to critical systems by using alternate sites and different input media.</li> <li>13. Availability of peripheral equipment and processing, such as printers and scanners.</li> <li>14. Availability of support equipment, such as air conditioners and dehumidifiers.</li> <li>15. Availability of support: supplies, transportation, communication.</li> <li>16. Distribution of output produced at the recovery site.</li> <li>17. Availability of important forms and paper stock.</li> <li>18. Ability to adapt plan to lesser disasters.</li> </ol> |     |    |            |                |          |

## Section 12. Disaster Site Rebuilding

- Floor plan of data center.
- Determine current hardware needs and possible alternatives. (See “Section 4. Example: Inventory Profile” on page 454.)
- Data center square footage, power requirements and security requirements.
  - Square footage \_\_\_\_\_
  - Power requirements \_\_\_\_\_
  - Security requirements: locked area, preferably with combination lock on one door.
  - Floor-to-ceiling studding
  - Detectors for high temperature, water, smoke, fire and motion
  - Raised floor

## Vendors

## Floor Plan

Include a copy of the proposed floor plan here.

---

## Section 13. Record of Plan Changes

Keep your plan current. Keep records of changes to your configuration, your applications, and your backup schedules and procedures. For example, you can get print a list of your current local hardware, by typing:

```
DSPLCLHDW OUTPUT(*PRINT)
```



---

## Appendix C. Recovering Your Server

This section provides instructions to completely recover your entire system. Use these steps if you need to recover your system to the same system (restore to the same system with the same serial number). Use these recovery instructions ONLY if you saved your entire system by using either of the following options:

- Save menu Option 21
- Equivalent Save Commands as Save menu Option 21:
  - SAVSYS
  - SAVLIB LIB(\*NONSYS) ACCPTH(\*YES)
  - SAVDLO DLO(\*ALL) SAVFLR(\*ANY)
  - SAV DEV('/QSYS.LIB/tape-device-name.DEVD') OBJ('//\*')  
('/QSYS.LIB' \*OMIT) ('/QDLS' \*OMIT)) UPDHST(\*YES)

### Important

Use "Recovering your entire system after a complete system loss—Checklist 20" on page 85 for any of the following cases.

- System has Logical Partitions.
- System uses the Alternate Installation Device Setup feature that you can define through DST for D-IPL.<sup>1</sup>
- System has mounted User-Defined File Systems prior to save.

Use "Recovering your entire system after a complete system loss including independent ASPs—Checklist 21" on page 88 if your recovery includes independent ASPs.

If you are recovering to a different system (system with a different serial number), use Appendix D, "Recovering Your Server to a Different Server," on page 477.

Check off each item as you complete the task.

- 1. If you use the Operations Console with LAN connectivity, you may need to manually reset the service tools device ID password on the server to be the same as the iSeries device ID, in order to connect to the Operations Console. After you begin the step, you must continue until you have performed the IPL from SAVSYS media. Do not perform this as a preliminary step. If you are using V5R4 Operations Console, you only have to reset the service tools device ID password on the server. The client will automatically attempt a signon using the reset device ID password for Operations Console. See the Operations Console topic in the iSeries Information Center at <http://www.ibm.com/eserver/series/infocenter> for more information.
- 2. If you are using Operations Console, LAN or direct connect, disconnect from your server and close Operations Console. Restart Operations Console and reconnect by using the user ID of 1111111 and password of 1111111 to sign on to your server.
- 3. IPL the system from the first SAVSYS media.
  - a. Mount the first SAVSYS media on the alternate IPL device. Wait for the **READY** status.
  - b. At the CPU control panel, place the system in **MANUAL** mode.
  - c. Press the Function Select switch (or buttons) to display 02 (IPL) in the Function display.

---

1. Refer to Chapter 17, "Using an Alternate Installation Device," on page 347.

- \_\_\_ d. Press **Enter**.
  - \_\_\_ e. Press the Function Select switch (or buttons) to display D (IPL from tape or CD-ROM) in the Data display.
  - \_\_\_ f. Press **Enter**.
  - \_\_\_ g. If the system is powered down, press the power button on the system to power the system on. Skip to Step 4. Otherwise, continue with Step 3h.
  - \_\_\_ h. If the system is powered on, press the Function Select switch (or buttons) to display 03 (continue the IPL) in the Function display.
  - \_\_\_ i. Press **Enter**.
- \_\_\_ 4. On the *Install Licensed Internal Code* screen, select 1, **Install Licensed Internal Code**.

```

Install Licensed Internal Code

Select one of the following:

1. Install Licensed Internal Code
2. Work with Dedicated Service Tools (DST)
3. Define alternate installation device

Selection
1

```

- \_\_\_ 5. On the *Install Licensed Internal Code (LIC)* screen, select 2, **Install Licensed Internal Code and Initialize System**, to start a "Scratch Install" of the Licensed Internal Code.

```

Install Licensed Internal Code (LIC)

Disk selected to write the Licensed Internal Code to:

Serial Number  Type  Model  I/O Bus  Controller  Device
xx-xxxxxxx    xxxx   xxx    x        x          x

Select one of the following:

1. Restore Licensed Internal Code
=>2. Install Licensed Internal Code and Initialize System
3. Install Licensed Internal Code and Recover Configuration
4. Install Licensed Internal Code and Restore Disk Unit Data
5. Install Licensed Internal Code and Upgrade Load Source

Selection
2

```

- \_\_\_ 6. On the *Install LIC and Initialize System - Confirmation* screen, press **F10** to confirm the initialization and to continue the install.

Install LIC and Initialize System - Configuration

Warning:

All data on this system will be destroyed and the Licensed Internal Code will be written to the selected disk if you choose to continue the initialize and install.

Return to the install selection screen and choose one of the other options if you want to perform some type of recovery after the install of the Licensed Internal Code is complete.

Press F10 to continue the install.  
Press F12 (Cancel) to return to the previous screen.  
Press F3 (Exit) to return to the install selection screen.

- \_\_ a. The *Initialize the Disk - Status* screen appears.

Initialize the Disk - Status

The load source disk is being initialized.

Estimated time to initialize in minutes: xx  
Elapsed time in minutes . . . . .: 0.0

- \_\_ b. The *Install Licensed Internal Code - Status* screen appears.

Install Licensed Internal Code - Status

Install the Licensed Internal Code in progress

Percent Complete . . . . . 0%      8.5 minutes

- \_\_ 7. You may see the *Accept Console* screen. If it appears, press F10 to accept the current console. On the *Accept And Set New Console Type On This IPL* press Enter to continue.
- \_\_ 8. On the *Disk Configuration Attention Report* screen, press F10 to accept any problems and to continue.

Disk Configuration Attention Report

Type option, press Enter  
5=Display Detailed Report

Press F10 to accept all the following problems and continue.  
The system will attempt to correct them.

OPT Problem  
\_ New disk configuration

F3=Exit                      F10=Accept the problems and continue

- \_\_ 9. On the *IPL or Install the System* screen, select 3, **Use Dedicated Service Tools (DST)**.

IPL or Install the System

Select one of the following:

1. Perform an IPL
2. Install the operating system
3. Use Dedicated Service Tools (DST)
4. Perform automatic installation of the operating system
5. Save Licensed Internal Code

Selection  
3

- \_\_\_ 10. Sign on to DST as service tools user, QSECOFR, with the password for the QSECOFR service tools user ID.

Dedicated Service Tools (DST) Sign On

Type choices, press Enter.

Service tools user . . . . . QSECOFR  
Service tools password . . . . . QSECOFR

- \_\_\_ a. The password for the service tools profile QSECOFR is shipped in the expired state and must be changed at first use. If you see the Change Service Tools User Password screen, enter in all uppercase letters the current password QSECOFR and a new password, along with the verification password.

Change Service Tools User Password

Service tools user profile name . . . . : QSECOFR  
Password last changed . . . . . : mm/dd/yy

Type choices, press Enter.

Current password . . . . . : QSECOFR  
New password . . . . . : \_\_\_\_\_  
New password (to verify). . . . . : \_\_\_\_\_

- \_\_\_ b. Select option 4, **Work with Disk Units**.
- \_\_\_ c. Select option 1, **Work with Disk Configuration**.
- \_\_\_ d. Select option 3, **Work with ASP Configuration**.
- \_\_\_ e. Select option 3, **Add Units to ASPs**.
- \_\_\_ 11. On the *Specify ASPs to Add Units to* screen, enter "1" for each unit that needs to be in the System ASP (ASP 1).
  - \_\_\_ a. If you require more than one ASP, enter the corresponding ASP number on each selected unit.

Specify ASPs to Add Units to

Specify the ASP to add each unit to.

| Specify ASP | Serial Number | Type | Model | Capacity | Resource Name |
|-------------|---------------|------|-------|----------|---------------|
| 1           | 00-0103706    | 6602 | 030   | 1031     | DD031         |
| 1           | 00-1000341    | 9337 | 211   | 542      | DD012         |
| 1           | 00-5000341    | 9337 | 211   | 542      | DD015         |
| 1           | 00-7000341    | 9337 | 211   | 542      | DD011         |
| 1           | 00-3000341    | 9337 | 211   | 542      | DD014         |
| 1           | 00-2000341    | 9337 | 211   | 542      | DD013         |
| 1           | 00-61300      | 6603 | 074   | 1475     | DD006         |
| 1           | 00-52262      | 6606 | 074   | 1475     | DD008         |
| 1           | 00-86978      | 6606 | 050   | 1967     | DD009         |
| 2           | 00-95744      | 6603 | 074   | 1475     | DD005         |
| 2           | 00-47657      | 6606 | 074   | 1475     | DD007         |
| -           | 00-0238703    | 6602 | 074   | 773      | DD051         |
| -           | 00-0128350    | 6602 | 074   | 773      | DD051         |

\_\_ b. After you complete all units, press **Enter**.

\_\_ c. If the list of units is correct, press **Enter** to start initializing the units.

\_\_ 12. On the *Problem Report* screen, press F10, **Ignore problems and continue**.

Problem Report

Note: Some action for the problems listed below may need to be taken. Please select a problem to display more detailed information about the problem and to see what possible action may be taken to correct the problem.

Type option, press Enter.

5=Display Detailed Report

OPT Problem

\_ Unit possibly configured for Power PC AS

F3=Exit

F10=Ignore problems and continue

F12=Cancel

\_\_ 13. On the *Confirm Add Units* screen, press **Enter** to confirm the selected units.

Confirm Add Units

Add will take several minutes for each unit. The system will have the displayed protection after the unit(s) are added.

Press Enter to confirm your choice for 1=Add units.  
 Press F9=Capacity Information to display the resulting capacity.  
 Press F12=Cancel to return and change your choice.

| ASP | Unit | Serial Number | Type | Model | Resource Name | Protection    |
|-----|------|---------------|------|-------|---------------|---------------|
| 1   | 1    | 00-0103706    | 6602 | 030   | DD031         | Unprotected   |
|     | 2    | 00-1000341    | 9337 | 211   | DD012         | Unprotected   |
|     | 3    | 00-5000341    | 9337 | 211   | DD015         | Unprotected   |
|     | 4    | 00-7000341    | 9337 | 211   | DD011         | Unprotected   |
|     | 5    | 00-3000341    | 9337 | 211   | DD014         | Device Parity |
|     | 6    | 00-2000341    | 9337 | 211   | DD013         | Device Parity |
|     | 7    | 00-61300      | 6603 | 074   | DD006         | Device Parity |
|     | 8    | 00-52262      | 6606 | 074   | DD008         | Device Parity |
|     | 9    | 00-86978      | 6606 | 050   | DD009         | Device Parity |
| 2   | 10   | 00-95744      | 6603 | 074   | DD005         | Device Parity |
|     | 11   | 00-47657      | 6606 | 074   | DD007         | Device Parity |

- \_\_\_ a. The *Function Status* screen displays the percentage of completion.
- \_\_\_ b. The "*Selected units have been added successfully*" message appears when the system completes the **Add Units** process.
- \_\_\_ c. Press F12 to return to the *Work with Disk Configuration* screen.
- \_\_\_ d. If your system requires mirrored protection, continue to Step 13e. If your system does not require mirrored protection, press **F3** until you see the *Exit Dedicated Service Tools (DST)* screen. Select 1 to exit DST and press Enter and continue to Step 13g.
- \_\_\_ e. To start mirrored protection for your system, follow these instructions:
  - \_\_\_ 1) On the *Work with Disk Configuration* screen, select 4, **Work with Mirrored Protection**.
  - \_\_\_ 2) On the *Work with Mirrored Protection* screen, select 2, **Start Mirrored Protection**.
  - \_\_\_ 3) Select an ASP by placing a "1" next to it. Press **Enter** to start mirrored protection.
  - \_\_\_ 4) On the *Confirm Continuation* screen, press **Enter**.
  - \_\_\_ 5) On the *Confirm Start Mirrored Protection* screen, press **Enter**.
  - \_\_\_ 6) The *Function Status* screen displays the completion status of the Start Mirrored Protection request.
  - \_\_\_ 7) The *Start mirroring completed successfully* message appears on the *Disk Configuration Information Report* screen.
  - \_\_\_ 8) Press **Enter** to continue.
- \_\_\_ f. To allow system value security changes during your recovery, follow these steps:
  - 1) On the *IPL or Install the System* screen, select 3, **Use Dedicated Service Tools (DST)**. Press **Enter** to continue.
  - 2) Sign on to DST using your DST user name and password.
  - 3) Select option 13 (Work with system security).
  - 4) Type 1 in the **Allow system value security changes** field and press **Enter**.
  - 5) Press **F3** or **F12** to get back to the *IPL or Install the System* screen.
- \_\_\_ g. If you use the Operations console, follow these instructions to switch from the current console, or to verify the console mode value:
  - \_\_\_ 1) On the *IPL or Install the System* screen, select 3, **Use Dedicated Service Tools (DST)**. Press **Enter** to continue.

- |           \_\_ 2) Sign on to DST as DST User, QSECOFR, with your new QSECOFR password.
- |           \_\_ 3) On the *Use Dedicated Service Tools (DST)* screen, select 5, **Work with DST environment**. Press **Enter** to continue.
- |           \_\_ 4) On the *Work with DST Environment* screen, select 2, **System Devices**. Press **Enter** to continue.
- |           \_\_ 5) On the *Work with System Devices* screen, select 6, **Console Mode**. Press **Enter** to continue.
- |           \_\_ 6) On the *Select Console Type* screen, select 2, **Operations Console**. Press **Enter** to continue.
- |           \_\_ 7) Press **F3** or **F12** to get back to the *IPL or Install the System* screen.
- \_\_ 14. On the *IPL or Install the System* screen, select 2, **Install the Operating System**.

IPL or Install the System

Select one of the following:

1. Perform an IPL
2. Install the Operating System
3. Use Dedicated Service Tools (DST)
4. Perform automatic installation of the Operating System
5. Save Licensed Internal Code

Selection  
2

- \_\_ a. On the *Confirm Install of i5/OS* screen, press **Enter**.
- \_\_ b. Make a selection on the *Install Device Type Selection* display and press **Enter**
- \_\_ c. The *Select a Language Group* screen displays the primary language feature that is currently on your save media. Press **Enter** to accept this value.

Select a Language Group

Note: The language feature shown is the language feature installed on the system.

Type choice, press Enter.

Language feature . . . . . 2924

- \_\_ d. The *Confirm Language Feature Selection* screen appears. Press **Enter** to continue.
- \_\_ 15. On the *Add All Disk Units to the System* screen, select option 1, **Keep the current disk configuration**.

Add All Disk Units to the System

Select one of the following:

1. Keep the current disk configuration
2. Perform disk configuration using DST
3. Add all units to the system auxiliary storage pool (ASP)
4. Add all units to the system ASP and balance data

Selection  
1

**Note:** This screen does not appear if you selected all disk units that are known to the system on Step 11 on page 466.

\_\_\_ 16. The *Licensed Internal Code IPL in Progress* screen displays the IPL progress.

```

                                Licensed Internal Code IPL in Progress

IPL:
Type . . . . . : Attended
Start date and time . . . . . : xx/xx/xx xx:xx:xx
Previous system end . . . . . : Abnormal
Current step / total . . . . . : 16 16
Reference code detail . . . . . : C6004065

Ipl step                                Time Elapsed  Time Remaining
Commit Recovery                          xx:xx:xx      xx:xx:xx
Data Base Initialization                  xx:xx:xx      xx:xx:xx
Journal IPL Clean up                       xx:xx:xx      xx:xx:xx
Commit Initialization                      xx:xx:xx      xx:xx:xx
>Start the operating system                xx:xx:xx      xx:xx:xx

Item:
Current / Total . . . . . :

Sub Item:
Identifier . . . . . : Searching tape for install media
Current / Total . . . . . :

Wait for next display or press F16 for DST main menu

```

\_\_\_ 17. On the *Install the Operating System* screen, select option 1, **Take defaults**. Make sure that the values for Date and Time are correct. Press **Enter** to continue.

```

                                Install the Operating System

Type options, press Enter.

Install
option . . . . . 1      1=Take defaults (No other
                        options are displayed)
                        2=Change install options

Date
Year . . . . . 99      00-99
Month . . . . . 08      01-12
Day . . . . . 22       01-31

Time
Hour . . . . . 16      00-23
Minute . . . . . 45     00-59
Second . . . . . 00     00-59

```

\_\_\_ 18. The **i5/OS Installation Status** screen displays the installation status of the required i5/OS Installation Profiles and Libraries.





IPL Options

Type choices, press Enter.

|                                            |          |             |
|--------------------------------------------|----------|-------------|
| System date . . . . .                      | 08/01/04 | MM/DD/Y     |
| System time . . . . .                      | 16:58:00 | HH:MM:S     |
| System time zone . . . . .                 | Q0000UTC | F4 for list |
| Clear job queues . . . . .                 | N        | Y=Yes, N=No |
| Clear output queues . . . . .              | N        | Y=Yes, N=No |
| Clear incomplete job logs . . . . .        | N        | Y=Yes, N=No |
| Start print writers . . . . .              | N        | Y=Yes, N=No |
| Start system to restricted state . . . . . | Y        | Y=Yes, N=No |
| Set major system options . . . . .         | Y        | Y=Yes, N=No |
| Define or change system at IPL . . . . .   | Y        | Y=Yes, N=No |

- \_\_ a. On the *Set Major System Options* screen, select **N** to disable automatic configuration.

Set Major System Options

Type choices, press Enter.

|                                          |        |               |
|------------------------------------------|--------|---------------|
| Enable automatic configuration . . . . . | N      | Y=Yes, N=No   |
| Device configuration naming . . . . .    | NORMAL | *NORMAL, *S36 |
| *DEVADR                                  |        |               |
| Default special environment . . . . .    | *NONE  | *NONE, *S36   |

- \_\_ 22. The *Define or Change the System at IPL* screen appears.
  - \_\_ a. Select 3, **System Value Commands**.
  - \_\_ b. On the *Change System Value Commands* screen, select 3, **Work with System Values**.
  - \_\_ c. On the *Work with System Values* screen, select the System Value that you plan to change by placing a "2" next to it. Press **Enter** ONLY after you select all the values.
    - | Update the following System Values. Write down the existing values so you can update
    - | them after the recovery, if necessary.
    - | • QALWOBJRST to \*ALL
    - | • QFRCCVNRST to 0
    - | • QIPLTYPE to 2
    - | • QINACTITV to \*NONE
    - | • QJOBMSGQFL to \*PRTWRAP
    - | • QJOBMSGQMX to minimum of 30 with a recommendation of 64
    - | • QLMTDEVSSN to 0
    - | • QLMTSECOFR to 0
    - | • QMAXSIGN to \*NOMAX
    - | • QPFRADJ to 2
    - | • QPWDEXPITV to \*NOMAX
    - | • QSCANFSCTL add \*NOPOSTRST
    - | • QVFOBJRST to 1
  - \_\_ d. After the system changes the system values, press F3 twice to return to the *Define or Change the System at IPL* screen.
  - \_\_ e. On the *Define or Change the System at IPL* screen, press F3 to exit and continue the IPL.
- \_\_ 23. On the *Change Password* screen, type QSEC0FR as the current password. Enter a new password. Re-enter the password to verify and press **Enter**. (New password cannot be QSEC0FR.)

```

Change Password

Password last changed . . . . . xx/xx/xx

Type choices, press Enter.

Current password . . . . . QSECOFR
New password . . . . . _____
New password (to verify) . . . . . _____

```

\_\_ 24.

- \_\_ 25. To configure tape units that are 3490 Model E or F use the following instructions:
- a. Use the Work with Hardware Resource (WRKHDWRSC) command to determine tape controller name.  
WRKHDWRSC TYPE(\*STG)
  - b. Locate the tape controller on the Work with Hardware Resources display.
  - c. Type a 9 (Work with resource) next to tape controller name and press the Enter key.

**Note:** If the tape controller is not listed on the display, you need to select other resources, such as disk storage controllers. For some server models, tape units are now attached through combined-function IOPs. Look through the resources until you find the tape unit you want.

- d. Locate the resource name for the tape unit (for example, TAP01).
- e. Enter a 5 (Work with Configuration Descriptions) in the *Opt* column next to the tape resource name and press the Enter key.  
You are shown the Work with Configuration Descriptions display.
- f. Type a 1 (Create) in the *Opt* field and a tape device description name (for example, TAP01) in the *Description* field. Press the Enter key. You are shown the Create Device Description (Tape) display.
- g. Change any values that you want to change, then press the Enter key (twice) to create the device description. You are shown the Work with Configuration Descriptions display again. The device that you created should appear on the display.
- h. Type an 8 (Work with configuration status) in front of the new device description. You are shown the Work with Configuration Status display.
- i. Type a 1 (Vary on or Make available) in front of the new device. If the status does not change to Varied On or Available, wait a few minutes. Then press F5 (Refresh). If the status still does not change to Varied On or Available, follow normal problem analysis for the device.
- j. Press F3 until you return to the main menu.

```

i5/OS Main Menu

Select one of the following:

  1. User tasks
  2. Office tasks
  3. General system tasks
  4. Files, libraries, and folders
  5. Programming
  6. Communications
  7. Define or change the system
  8. Problem handling
  9. Display a menu
 10. Information Assistant options
 11. iSeries Access tasks

 90. Sign off

Selection or command

```

- \_\_\_ 26. On the *i5/OS Main Menu* screen, type the command, WRKRPYLE, and check to see if CPA3709 is there. If it is not, determine an available sequence number and then Press F6 to add MSGID(CPA3709) RPY(G) by using the available sequence number. Press F5 to Refresh and verify that you added CPA3709.
  - \_\_\_ a. Type the command CHGJOB INQMSGRPY(\*SYSRPLY) to update the current job to use the system reply list for inquiry messages.
- \_\_\_ 27. On the *i5/OS Main Menu* screen, type G0 RESTORE to access the *i5/OS Restore* screen.
  - \_\_\_ a. On the *Restore* screen, select option 21, **Restore System and User Data**.
  - \_\_\_ b. Press **Enter** to continue.
- \_\_\_ 28. On the *Specify Command Defaults* screen, enter the name of the tape drive that you are using for the restore.
  - \_\_\_ a. Set **Prompt for command** to N.
  - \_\_\_ b. Set **Message queue delivery** to \*NOTIFY.

```

                                Specify Command Defaults

Type choices, press Enter.

Tape devices . . . . . TAP01      Names
Prompt for commands. . . . . N      Y=Yes, N=No
Message queue delivery . . . . . *NOTIFY *BREAK, *NOTIFY
Restore to different system. . . . . N      Y=Yes, N=No
```

- \_\_\_ c. Press **Enter** to continue ending the subsystems. The restore process starts to run unattended. The restore process stops only if the system requires a tape mount for the restore process to continue. The restore process should run to completion.
- \_\_\_ 29. If you receive message CPF3204, "Cannot find object needed for file xxxx in xxx," during the restore of your libraries, the necessary based-on physical files were not yet restored when the logical files were attempting to restore. You will need to perform the restore of logical files after the physical files have been restored using one of the following options:
  - | • Run this command to restore only the logical files that were not restored previously.
  - | RSTLIB SAVLIB(\*NONSYS) DEV(*media-device-name*)
  - | OPTION(\*NEW) MBROPT(\*ALL) ALWOBJDIF(\*ALL)
  - | • Run this command for each library that has logical files which need to be restored.
  - | RSTLIB SAVLIB(*library-name*) DEV(*media-device-name*)
  - | OPTION(\*NEW) MBROPT(\*ALL) ALWOBJDIF(\*ALL)
  - | • Run this command for each logical file that needs to be restored.
  - | RSTOBJ OBJ(*logical-file-name*) SAVLIB(*library-name*)
  - | DEV(*media-device-name*) OBJTYPE(\*FILE) MBROPT(\*ALL) ALWOBJDIF (\*ALL)
- \_\_\_ 30. Update Program Temporary Fix information for all PTF save files in library QGPL by typing: UPDPTFINF.
- \_\_\_ 31. Reapply any PTFs that you applied since the last time that you saved your system data.
  - \_\_\_ a. Locate the most recent cumulative PTF (program temporary fix) tape.
  - \_\_\_ b. From a command-line, enter G0 PTF to access the PTF menu.
  - \_\_\_ c. Select 8, **Install program temporary fix package**, on the PTF menu.
 

This installs all of the PTFs in the cumulative PTF package for the licensed programs that are installed on your system. Refer to the *i5/OS PTF Shipping Information Letter* for required special instructions.

**Notes:**

- 1) If you want to restore individual PTFs, see the *Systems Operation* publication for more information about applying individual PTFs.

2) If you do not have the PTFs that you need, order them and apply them later.

- \_\_\_ 32. If necessary, change the system values back to the original values that you wrote down in step 22c, by using the WRKSYSVAL command.
- \_\_\_ 33. If you do not know the password for the restored QSECOFR profile, change the password before signing off. Type the following command: CHGUSRPRF USRPRF(QSECOFR) PASSWORD(new-password).
- \_\_\_ 34. To place scheduled jobs on hold, type WRKJOBSCDE and select option 3 to hold any scheduled jobs. You need to release the jobs in Step 41 after you complete the restore.
- \_\_\_ 35. Type the command, SIGNOFF \*LIST or DSPJOBLOG \* \*PRINT. Check the job log to ensure that the job restored all objects. To verify if the job restored all objects, spool the job log for printing along with any remaining spooled job output. Check for any error messages. Correct the errors and restore those objects from media.
- \_\_\_ 36. Perform an IPL of the system.
  - \_\_\_ a. On the CPU control panel, select the **NORMAL** setting.
  - \_\_\_ b. Type the following command:

```
PWRDWSYS OPTION(*IMMED)
RESTART(*YES *FULL) IPLSRC(B)
```

- \_\_\_ 37. If you installed **Content Manager OnDemand for iSeries (5769-RD1)** on your system, restart the journaling for **Content Manager OnDemand for iSeries (5769-RD1)** by typing the following commands:

```
CALL QRDARS/QRLCSTRJ PARM('RLC')
CALL QRDARS/QRLCSTRJ PARM('RLR')
CALL QRDARS/QRLCSTRJ PARM('RLO')
```

- \_\_\_ 38. If you installed **iSeries Integration for Windows Server (5722-WSV)** on your system and you saved with your network servers in a VARIED ON setting, perform the following steps:
  - \_\_\_ a. Vary off any network servers that are varied on by using the WRKCFGSTS \*NWS command. Select option 2.
  - \_\_\_ b. Create any needed Network Storages by using the CRTNWSSTG command.
  - \_\_\_ c. Add the storage links by using the ADDNWSSTGL command.
  - \_\_\_ d. Vary on your network servers by using the WRKCFGSTS \*NWS command. Select option 1.
  - \_\_\_ e. Restore **iSeries Integration for Windows Server (5722-WSV)** data by typing RST OBJ('/QNTC').
  - \_\_\_ f. Press **Enter**.
  - \_\_\_ g. Follow the instructions in Step 35 to check for error messages, verify your restore, and correct any errors.

- \_\_\_ 39. If you installed **iSeries Integration for Windows Server (5722-WSV)** on your system and you saved with your network server in a VARIED OFF setting, perform the following steps:
  - \_\_\_ a. Add the links for the server descriptions. Type the following for each server description:

```
ADDNWSSTGL NWSSTG(Storage_Name) NWS(Description)
```

- \_\_\_ b. Vary on your network servers by typing WRKCFGSTS \*NWS and by selecting option 1 to vary on each network server.

- | \_\_\_ 40. If you have 4764 Cryptographic Coprocessor Hardware recover 5733-CY1 CCA Device Manager by typing CALL QCCAEDEV/QCCAELOAD.
- | \_\_\_ 41. Release the jobs that you previously held in Step 34.



---

## Appendix D. Recovering Your Server to a Different Server

This section provides instructions to completely recover your entire AS/400 or iSeries server. Use these steps if you need to recover your server to a different server (for example, a server with a different serial number).

**Note:** If you are performing a system migration you must also refer to the **Migration** topic in the iSeries Information Center (<http://www.ibm.com/eserver/iserries/infocenter>).

Use these recovery instructions **only** if you saved your entire system by using either of the following options:

- Save menu Option 21
- Equivalent Save Commands as Save menu Option 21:
  - SAVSYS
  - SAVLIB LIB(\*NONSYS) ACCPTH(\*YES)
  - SAVDLO DLO(\*ALL) SAVFLR(\*ANY)
  - SAV DEV('/QSYS.LIB/tape-device-name.DEVD') OBJ(('/\*'  
('/QSYS.LIB' \*OMIT) ('/QDLS' \*OMIT)) UPDHST(\*YES)

### Important

Use "Recovering your entire system after a complete system loss—Checklist 20" on page 85 for any of the following cases

- System has Logical Partitions.
- System has mounted User-Defined File Systems prior to save.

Use "Recovering your entire system after a complete system loss including independent ASPs—Checklist 21" on page 88 if your recovery includes independent ASPs.

If a tape or optical device other than the primary installation device is to be used for the recovery, refer to Chapter 17, "Using an Alternate Installation Device," on page 347.

Check off each item as you complete the task.

1. If you use Operations Console with LAN connectivity, you must disconnect Operations Console from the server, resynchronize your PC device ID, then connect to Operations Console, to be the same as the iSeries device ID. After you begin this step, you must continue until you have performed the IPL from SAVSYS media. Do not perform this as a preliminary step. If you are resynchronizing V5R3 Operations Console, use the following instructions. If you are resynchronizing a previous release of Operations Console, see the Operations Console topic in the iSeries Information Center at <http://www.ibm.com/eserver/iserries/infocenter>.
  - a. If Operations Console is connected to the server, select the connection name in Operations Console that you will be making the change for, then click **Connection --> Disconnect**.
  - b. In Operations Console select the connection name that you will be making the change for, then click **Connection --> Properties**.
  - c. Select the **Device ID** page.
  - d. Click **Reset**.
  - e. Specify the correct **Access password** and click **OK**.
  - f. Click **OK**.
  - g. Select the connection name that you the changed, then click **Connection --> Connect**.

- \_\_\_ 2. If you are using Operations Console, LAN or direct connect, disconnect from your server and close Operations Console. Restart Operations Console and reconnect by using the user ID of 11111111 and password of 11111111 to sign on to your server.
- \_\_\_ 3. IPL the system from the first SAVSYS media.
  - \_\_\_ a. Mount the first SAVSYS media on the alternate IPL device. Wait for the **READY** status.
  - \_\_\_ b. At the CPU control panel, place the system in **MANUAL** mode.
  - \_\_\_ c. Press the Function Select switch (or buttons) to display 02 (IPL) in the Function display.
  - \_\_\_ d. Press **Enter**.
  - \_\_\_ e. Press the Function Select switch (or buttons) to display D (IPL from tape or CD-ROM) in the Data display.
  - \_\_\_ f. Press **Enter**.
  - \_\_\_ g. If the system is powered down, press the power button on the system to power the system on. Skip to Step 4. Otherwise, continue with Step 3h.
  - \_\_\_ h. If the system is powered on, press the Function Select switch (or buttons) to display 03 (continue the IPL) in the Function display.
  - \_\_\_ i. Press **Enter**.
- \_\_\_ 4. On the *Install Licensed Internal Code* screen, select 1, **Install Licensed Internal Code**.

```

Install Licensed Internal Code

Select one of the following:

  1. Install Licensed Internal Code
  2. Work with Dedicated Service Tools (DST)
  3. Define alternate installation device

Selection
1

```

- \_\_\_ 5. On the *Install Licensed Internal Code (LIC)* screen, select 2, **Install Licensed Internal Code and Initialize System**, to start a "Scratch Install" of the Licensed Internal Code.

```

Install Licensed Internal Code (LIC)

Disk selected to write the Licensed Internal Code to:

  Serial Number  Type  Model  I/O Bus  Controller  Device
  xx-xxxxxxx    xxxx   xxx    x        x          x

Select one of the following:

  1. Restore Licensed Internal Code
=>2. Install Licensed Internal Code and Initialize System
  3. Install Licensed Internal Code and Recover Configuration
  4. Install Licensed Internal Code and Restore Disk Unit Data
  5. Install Licensed Internal Code and Upgrade Load Source

Selection
2

```

- \_\_\_ 6. On the *Install LIC and Initialize System - Confirmation* screen, press **F10** to confirm the initialization and to continue the install.



Install LIC and Initialize System - Configuration

Warning:

All data on this system will be destroyed and the Licensed Internal Code will be written to the selected disk if you choose to continue the initialize and install.

Return to the install selection screen and choose one of the other options if you want to perform some type of recovery after the install of the Licensed Internal Code is complete.

Press F10 to continue the install.  
Press F12 (Cancel) to return to the previous screen.  
Press F3 (Exit) to return to the install selection screen.

- \_\_ a. The *Initialize the Disk - Status* screen appears.

Initialize the Disk - Status

The load source disk is being initialized.

Estimated time to initialize in minutes: xx  
Elapsed time in minutes . . . . .: 0.0

- \_\_ b. The *Install Licensed Internal Code - Status* screen appears.

Install Licensed Internal Code - Status

Install the Licensed Internal Code in progress

Percent Complete . . . . . 0%      8.5 minutes

- \_\_ 7. You may see the *Accept Console* screen. If it appears, press F10 to accept the current console. On the *Accept And Set New Console Type On This IPL* press Enter to continue.
- \_\_ 8. On the *Disk Configuration Attention Report* screen, press F10 to accept any problems and to continue.

Disk Configuration Attention Report

Type option, press Enter  
5=Display Detailed Report

Press F10 to accept all the following problems and continue.  
The system will attempt to correct them.

OPT Problem  
\_ New disk configuration

F3=Exit                      F10=Accept the problems and continue

- \_\_ 9. On the *IPL or Install the System* screen, select 3, **Use Dedicated Service Tools (DST)**.

IPL or Install the System

Select one of the following:

1. Perform an IPL
2. Install the operating system
3. Use Dedicated Service Tools (DST)
4. Perform automatic installation of the operating system
5. Save Licensed Internal Code

Selection

3

- \_\_ 10. Sign on to DST as service tools user, QSECOFR, with the password for the QSECOFR service tools user ID.

Dedicated Service Tools (DST) Sign On

Type choices, press Enter.

Service tools user . . . . . QSECOFR  
Service tools password . . . . . QSECOFR

- \_\_ a. The password for the service tools profile QSECOFR is shipped in the expired state and must be changed at first use. If you see the Change Service Tools User Password screen, enter in all uppercase letters the current password QSECOFR and a new password, along with the verification password.

Change Service Tools User Password

Service tools user profile name . . . . : QSECOFR  
Password last changed . . . . . : mm/dd/yy

Type choices, press Enter.

Current password . . . . . : QSECOFR  
New password . . . . . : \_\_\_\_\_  
New password (to verify). . . . . : \_\_\_\_\_

- \_\_ b. Select option 4, **Work with Disk Units**.
- \_\_ c. Select option 1, **Work with Disk Configuration**.
- \_\_ d. Select option 3, **Work with ASP Configuration**.
- \_\_ e. Select option 3, **Add Units to ASPs**.
- \_\_ 11. On the *Specify ASPs to Add Units to* screen, enter 1 for each unit that needs to be in the System ASP (ASP 1).
- \_\_ a. If you require more than one ASP, enter the corresponding ASP number on each selected unit.

Specify ASPs to Add Units to

Specify the ASP to add each unit to.

| Specify ASP | Serial Number | Type | Model | Capacity | Resource Name |
|-------------|---------------|------|-------|----------|---------------|
| 1           | 00-0103706    | 6602 | 030   | 1031     | DD031         |
| 1           | 00-1000341    | 9337 | 211   | 542      | DD012         |
| 1           | 00-5000341    | 9337 | 211   | 542      | DD015         |
| 1           | 00-7000341    | 9337 | 211   | 542      | DD011         |
| 1           | 00-3000341    | 9337 | 211   | 542      | DD014         |
| 1           | 00-2000341    | 9337 | 211   | 542      | DD013         |
| 1           | 00-61300      | 6603 | 074   | 1475     | DD006         |
| 1           | 00-52262      | 6606 | 074   | 1475     | DD008         |
| 1           | 00-86978      | 6606 | 050   | 1967     | DD009         |
| 2           | 00-95744      | 6603 | 074   | 1475     | DD005         |
| 2           | 00-47657      | 6606 | 074   | 1475     | DD007         |
| -           | 00-0238703    | 6602 | 074   | 773      | DD051         |
| -           | 00-0128350    | 6602 | 074   | 773      | DD051         |

\_\_ b. After you complete all units, press **Enter**.

\_\_ c. If the list of units is correct, press **Enter** to start initializing the units.

\_\_ 12. On the *Problem Report* screen, press F10, **Ignore problems and continue**.

Problem Report

Note: Some action for the problems listed below may need to be taken. Please select a problem to display more detailed information about the problem and to see what possible action may be taken to correct the problem.

Type option, press Enter.

5=Display Detailed Report

OPT Problem

\_ Unit possibly configured for Power PC AS

F3=Exit

F10=Ignore problems and continue

F12=Cancel

\_\_ 13. On the *Confirm Add Units* screen, press **Enter** to confirm the selected units.

Confirm Add Units

Add will take several minutes for each unit. The system will have the displayed protection after the unit(s) are added.

Press Enter to confirm your choice for 1=Add units.  
Press F9=Capacity Information to display the resulting capacity.  
Press F12=Cancel to return and change your choice.

| ASP | Unit | Serial Number | Type | Model | Resource Name | Protection    |
|-----|------|---------------|------|-------|---------------|---------------|
| 1   | 1    | 00-0103706    | 6602 | 030   | DD031         | Unprotected   |
|     | 2    | 00-1000341    | 9337 | 211   | DD012         | Unprotected   |
|     | 3    | 00-5000341    | 9337 | 211   | DD015         | Unprotected   |
|     | 4    | 00-7000341    | 9337 | 211   | DD011         | Unprotected   |
|     | 5    | 00-3000341    | 9337 | 211   | DD014         | Device Parity |
|     | 6    | 00-2000341    | 9337 | 211   | DD013         | Device Parity |
|     | 7    | 00-61300      | 6603 | 074   | DD006         | Device Parity |
|     | 8    | 00-52262      | 6606 | 074   | DD008         | Device Parity |
|     | 9    | 00-86978      | 6606 | 050   | DD009         | Device Parity |
| 2   | 10   | 00-95744      | 6603 | 074   | DD005         | Device Parity |
|     | 11   | 00-47657      | 6606 | 074   | DD007         | Device Parity |
|     |      |               |      |       |               | Unprotected   |

- \_\_\_ a. The *Function Status* screen displays the percentage of completion.
- \_\_\_ b. The "*Selected units have been added successfully*" message appears when the system completes the **Add Units** process.
- \_\_\_ c. Press F12 to return to the *Work with Disk Configuration* screen.
- \_\_\_ d. If your system requires mirrored protection, continue to Step 13e. If your system does not require mirrored protection, press **F3** until you see the *Exit Dedicated Service Tools (DST)* screen. Select 1 to exit DST and press Enter and continue to Step 13g.
- \_\_\_ e. To start mirrored protection for your system, follow these instructions:
  - \_\_\_ 1) On the *Work with Disk Configuration* screen, select 4, **Work with Mirrored Protection**.
  - \_\_\_ 2) On the *Work with Mirrored Protection* screen, select 2, **Start Mirrored Protection**.
  - \_\_\_ 3) Select an ASP by placing a "1" next to it. Press **Enter** to start mirrored protection.
  - \_\_\_ 4) On the *Confirm Continuation* screen, press **Enter**.
  - \_\_\_ 5) On the *Confirm Start Mirrored Protection* screen, press **Enter**.
  - \_\_\_ 6) The *Function Status* screen displays the completion status of the Start Mirrored Protection request.
  - \_\_\_ 7) The *Start mirroring completed successfully* message appears on the *Disk Configuration Information Report* screen.
  - \_\_\_ 8) Press **Enter** to continue.
- \_\_\_ f. To allow system value security changes during your recovery, follow these steps:
  - 1) On the *IPL or Install the System* screen, select 3, **Use Dedicated Service Tools (DST)**. Press **Enter** to continue.
  - 2) Sign on to DST using your DST user name and password.
  - 3) Select option 13 (Work with system security).
  - 4) Type 1 in the **Allow system value security changes** field and press **Enter**.
  - 5) Press **F3** or **F12** to get back to the *IPL or Install the System* screen.
- \_\_\_ g. If you use Operations Console, follow these instructions to switch working from 'local console' to 'operations console':
  - \_\_\_ 1) On the *IPL or Install the System* screen, select 3, **Use Dedicated Service Tools (DST)**. Press **Enter** to continue.

- \_\_\_ 2) Sign on to DST as DST User, QSEC0FR, and your new password.
  - \_\_\_ 3) On the *Use Dedicated Service Tools (DST)* screen, select 5, **Work with DST environment**. Press **Enter** to continue.
  - \_\_\_ 4) On the *Work with DST Environment* screen, select 2, **System Devices**. Press **Enter** to continue.
  - \_\_\_ 5) On the *Work with System Devices* screen, select 6, **Console Mode**. Press **Enter** to continue.
  - \_\_\_ 6) On the *Select Console Type* screen, select 2, **Operations Console**. Press **Enter** to continue.
  - \_\_\_ 7) Press **F3** or **F12** to get back to the *IPL or Install the System* screen.
- \_\_\_ 14. On the *IPL or Install the System* screen, select 2, **Install the Operating System**.

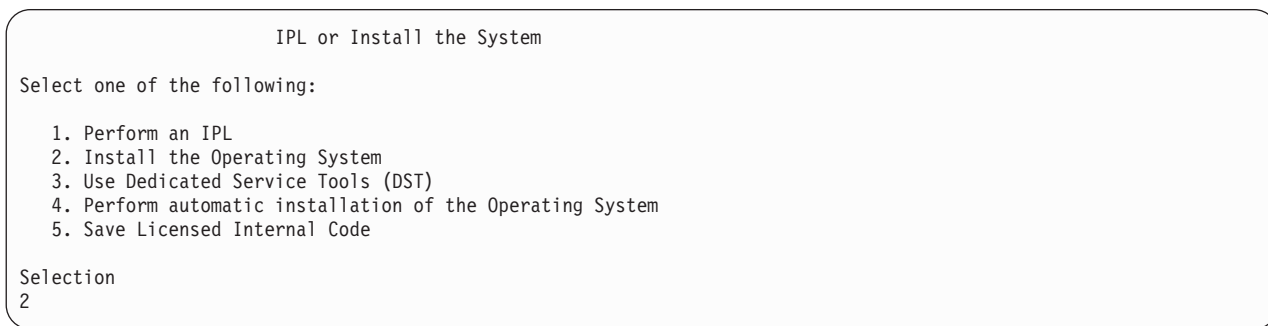

- \_\_\_ a. Make a selection on the *Install Device Type Selection* screen and press **Enter**.

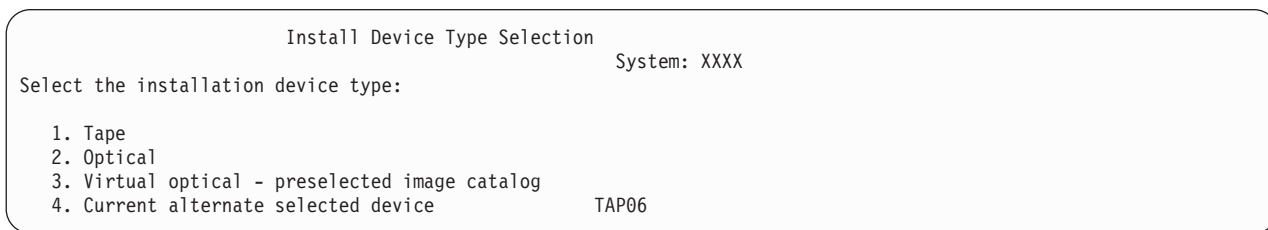

- \_\_\_ b. On the *Confirm Install of i5/OS* screen, press **Enter**.
- \_\_\_ c. The *Select a Language Group* screen displays the primary language feature that is currently on your save media. Press **Enter** to accept this value.

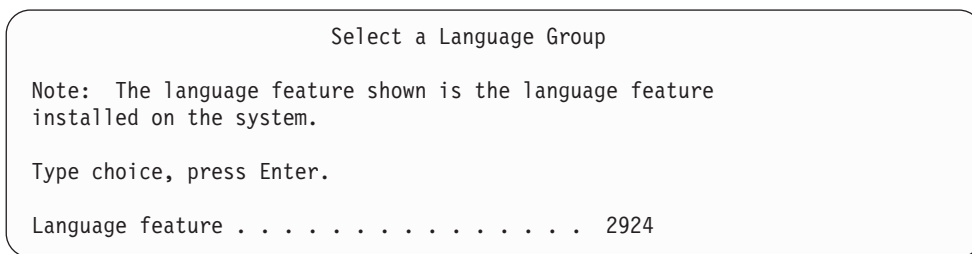

- \_\_\_ d. The *Confirm Language Feature Selection* screen appears. Press **Enter** to continue.
- \_\_\_ 15. On the *Add All Disk Units to the System* screen, select option 1, **Keep the current disk configuration**.

Add All Disk Units to the System

Select one of the following:

1. Keep the current disk configuration
2. Perform disk configuration using DST
3. Add all units to the system auxiliary storage pool (ASP)
4. Add all units to the system ASP and balance data

Selection

1

**Note:** This screen does not appear if you selected all disk units that are known to the system on Step 11 on page 480.

\_\_\_ 16. The *Licensed Internal Code IPL in Progress* screen displays the IPL progress.

Licensed Internal Code IPL in Progress

IPL:

Type . . . . . Attended  
Start date and time . xx/xx/xx xx:xx:xx  
Previous system end . Normal

IPL Step . . . . . : Storage Management Recovery

\_\_\_ 17. On the *Install the Operating System* screen, select option 2, **Change install options**. This allows you to select to restore your network attributes from your save media. If the date and time are not correct, type new values. Press **Enter** to continue.

Licensed Internal Code IPL in Progress

IPL:

Type . . . . . : Attended  
Start date and time . . . . . : xx/xx/xx xx:xx:xx  
Previous system end . . . . . : Abnormal  
Current step / total . . . . . : 16 16  
Reference code detail . . . . . : C6004065

| Ipl step                    | Time Elapsed | Time Remaining |
|-----------------------------|--------------|----------------|
| Commit Recovery             | xx:xx:xx     | xx:xx:xx       |
| Data Base Initialization    | xx:xx:xx     | xx:xx:xx       |
| Journal IPL Clean up        | xx:xx:xx     | xx:xx:xx       |
| Commit Initialization       | xx:xx:xx     | xx:xx:xx       |
| >Start the operating system | xx:xx:xx     | xx:xx:xx       |

Item:

Current / Total . . . . . :

Sub Item:

Identifier . . . . . : Searching tape for install media  
Current / Total . . . . . :

Wait for next display or press F16 for DST main menu

\_\_\_ 18. On the **Specify Install Options** screen, specify the following installation options.



Message ID . . . : CPI2070

i5/OS Installation Status

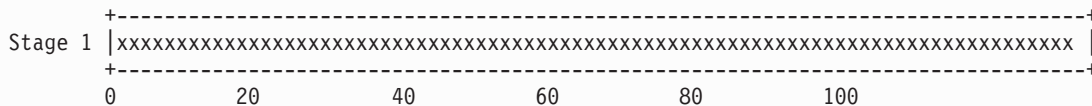

| Installation Stage                               | Completed | Objects Restored |
|--------------------------------------------------|-----------|------------------|
| 1 Creating needed profiles and libraries . . . : | x         |                  |
| 2 Restoring programs to library QSYS . . . . . : | x         | 09               |
| 3 Restoring language objects to library QSYS . : | x         | 03               |
| 4 Updating program table . . . . . :             | x         |                  |
| 5 Installing database files . . . . . :          | x         |                  |
| 6 Completing i5/OS installation . . . . . :      |           |                  |

- \_\_ 22. On the *Sign On* screen, logon as user QSEC0FR. You do not need to enter a password at this time.
- \_\_ 23. On the *IPL options* screen, enter correct values for the system date, time, and time zone. Only the following options should be set to Y:
  - Start system to restricted state
  - Set major system options
  - Define or change the system at IPL

IPL Options

Type choices, press Enter.

```

System date . . . . . 08/01/04 MM/DD/Y
System time . . . . . 16:58:00 HH:MM:S
System time zone . . . . . Q0000UTC F4 for list
Clear job queues . . . . . N Y=Yes, N=No
Clear output queues . . . . . N Y=Yes, N=No
Clear incomplete job logs . . . . . N Y=Yes, N=No
Start print writers . . . . . N Y=Yes, N=No
Start system to restricted state . . . . . Y Y=Yes, N=No

Set major system options . . . . . Y Y=Yes, N=No
Define or change system at IPL . . . . . Y Y=Yes, N=No

```

- \_\_ a. On the *Set Major System Options* screen, select **Y** to enable automatic configuration.

**Note:** If you are using these instructions during a data migration, select **N** so that automatic configuration is not enabled.

Set Major System Options

Type choices, press Enter.

```

Enable automatic configuration . . . . . Y Y=Yes, N=No
Device configuration naming . . . . . *NORMAL *NORMAL, *S36
*DEVADR
Default special environment . . . . . *NONE *NONE, *S36

```

- \_\_ 24. The *Define or Change the System at IPL* screen appears.
  - \_\_ a. Select 3, **System Value Commands**.
  - \_\_ b. On the *System Value Commands* screen, select 3, **Work with System Values**.



- \_\_\_ c. On the *Work with System Values* screen, select the System Value that you plan to change by placing a "2" next to it. Press **Enter** ONLY after you select all the values.
- Update the following System Values. Write down the existing values so you can update them after the recovery, if necessary.
- QALWOBJRST to \*ALL
  - QFRCCVNRST to 0
  - QIPLTYPE to 2
  - QINACTITV to \*NONE
  - QJOBMSGQFL to \*PRTWRAP
  - QJOBMSGQMX to minimum of 30 with a recommendation of 64
  - QLMTDEVSSN to 0
  - QLMTSECOFR to 0
  - QMAXSIGN to \*NOMAX
  - QPFRADJ to 2
  - QPWDEXPITV to \*NOMAX
  - QSCANFCTL add \*NOPOSTRST
  - QVfyOBJRST to 1
- \_\_\_ d. After the system changes the system values, press F3 twice to return to the *Define or Change the System at IPL* screen.
- \_\_\_ e. On the *Define or Change the System at IPL* screen, press F3 to exit and continue the IPL.
- \_\_\_ 25. On the *Change Password* screen, type QSECOFR as the current password. Enter a new password. Re-enter the password to verify and press **Enter**. (New password cannot be QSECOFR.)
- If you are performing a data migration and you set Enable automatic configuration to **NO**, use the following steps to create a tape device to perform the restore. If you set Enable automatic configuration to **YES**, skip to step 28 on page 488
- \_\_\_ 26.
- \_\_\_ 27. To configure tape units that are 3490 Model E or F, or that are not models 34xx, use the following instructions:
- a. Use the *Work with Hardware Resource (WRKHDWRSC)* command to determine tape controller name.  
WRKHDWRSC TYPE(\*STG)
  - b. Locate the tape controller on the *Work with Hardware Resources* display.
  - c. Type a 9 (*Work with resource*) next to tape controller name and press the Enter key.
- Note:** If the tape controller is not listed on the display, you need to select other resources, such as disk storage controllers. For some server models, tape units are now attached through combined-function IOPs. Look through the resources until you find the tape unit you want.
- d. Locate the resource name for the tape unit (for example, TAP01).
  - e. Enter a 5 (*Work with Configuration Descriptions*) in the *Opt* column next to the tape resource name and press the Enter key.  
You are shown the *Work with Configuration Descriptions* display.
  - f. Type a 1 (*Create*) in the *Opt* field and a tape device description name (for example, TAP01) in the *Description* field. Press the Enter key. You are shown the *Create Device Description (Tape)* display.
  - g. Change any values that you want to change, then press the Enter key (twice) to create the device description. You are shown the *Work with Configuration Descriptions* display again. The device that you created should appear on the display.

- h. Type an 8 (Work with configuration status) in front of the new device description. You are shown the Work with Configuration Status display.
  - i. Type a 1 (Vary on or Make available) in front of the new device. If the status does not change to Varied On or Available, wait a few minutes. Then press F5 (Refresh). If the status still does not change to Varied On or Available, follow normal problem analysis for the device.
  - j. Press F3 until you return to the main menu.
- \_\_\_ 28. On the *i5/OS Main Menu* screen, type the command, WRKRPYLE, and check to see if CPA3709 is there. If it is not, determine an available sequence number and then Press F6 to add MSGID(CPA3709) RPY(G) by using the available sequence number. Press F5 to Refresh and verify that you added CPA3709.
- \_\_\_ a. Type the command CHGJOB INQMSGRPY(\*SYSRPYL) to update the current job to use the system reply list for inquiry messages.
- \_\_\_ 29. On the *i5/OS Main Menu* screen, type G0 RESTORE to access the *Restore* screen.
- \_\_\_ a. On the *Restore* screen, select option 21, **Restore System and User Data**.
  - \_\_\_ b. Press **Enter** to continue.
- \_\_\_ 30. On the *Specify Command Defaults* screen, enter the name of the tape drive that you are using for the restore.
- \_\_\_ a. Set **Prompt for command** to N.
  - \_\_\_ b. Set **Message queue delivery** to \*NOTIFY.
  - \_\_\_ c. Set **Restore to different system** to Y.
  - \_\_\_ d. Press **Enter** to continue ending the subsystems. The restore process starts to run unattended. The restore process stops only if the system requires a tape mount for the restore process to continue. The restore process should run to completion.
- \_\_\_ 31. If a controller or device no longer has a valid resource on the system, use the Work with Hardware Product (WRKHDP) command to correct the hardware resource names. See **Migration -> Data migration -> Perform the migration -> Complete the migration -> fix hardware resource names after a recovery** in the iSeries Information Center at <http://www.ibm.com/eserver/iseres/infocenter> for instructions.
- \_\_\_ 32. If you receive message CPF3204, "Cannot find object needed for file xxxx in xxx," during the restore of your libraries, the necessary based-on physical files were not yet restored when the logical files were attempting to restore. You will need to perform the restore of logical files after the physical files have been restored using one of the following options:
- Run this command to restore only the logical files that were not restored previously.  

```
RSTLIB SAVLIB(*NONSYS) DEV(media-device-name)
OPTION(*NEW) MBROPT(*ALL) ALWOBJDIF(*ALL)
```
  - Run this command for each library that has logical files which need to be restored.  

```
RSTLIB SAVLIB(library-name) DEV(media-device-name)
OPTION(*NEW) MBROPT(*ALL) ALWOBJDIF(*ALL)
```
  - Run this command for each logical file that needs to be restored.  

```
RSTOBJ OBJ(logical-file-name) SAVLIB(library-name)
DEV(media-device-name) OBJTYPE(*FILE) MBROPT(*ALL) ALWOBJDIF (*ALL)
```
- \_\_\_ 33. Update Program Temporary Fix information for all PTF save files in library QGPL by typing: UPDPTFFINE.
- \_\_\_ 34. Reapply any PTFs that you applied since the last time that you saved your system data.
- \_\_\_ a. Locate the most recent cumulative PTF (program temporary fix) tape/CD.
  - \_\_\_ b. From a command-line, enter G0 PTF to access the PTF menu.
  - \_\_\_ c. Select 8, **Install program temporary fix package**, on the PTF menu.  
This installs all of the PTFs in the cumulative PTF package for the licensed programs that are installed on your system. Refer to the *i5/OS PTF Shipping Information Letter* for required special instructions.

**Notes:**

- 1) If you want to restore individual PTFs, see the *Systems Operation* publication for more information about applying individual PTFs.
- 2) If you do not have the PTFs that you need, order them and apply them later.

- \_\_\_ 35. If necessary, change the system values back to what they were in step 22c by using the WRKSYSVAL command.
- \_\_\_ 36. If you do not know the password for the restored QSECOFR profile, change the password before signing off. Type the following command and press **Enter**:  
CHGUSRPRF USRPRF(QSECOFR) PASSWORD(new-password)
- \_\_\_ 37. To place scheduled jobs on hold, type WRKJOBSCDE and select option 3 to hold any scheduled jobs. You need to release the jobs in Step 44 after you complete the restore.
- \_\_\_ 38. Type the command, SIGNOFF \*LIST or DSPJOBLOG \* \*PRINT. Check the job log to ensure that the job restored all objects. To verify if the job restored all objects, spool the job log for printing along with any remaining spooled job output. Check for any error messages. Correct the errors and restore those objects from media.
- \_\_\_ 39. Perform an IPL of the system.
- \_\_\_ a. On the CPU control panel, select the **NORMAL** setting.
  - \_\_\_ b. Type the following command and press **Enter**:  
  
PWRDWSYS OPTION(\*IMMED) RESTART(\*YES  
\*FULL) IPLSRC(B)
- \_\_\_ 40. If you installed **IBM Content Manager OnDemand for iSeries (5769-RD1)** on your system, restart the journaling for **IBM Content Manager OnDemand for iSeries (5769-RD1)** by typing the following commands:  
  
CALL QRDARS/QRLCSTRJ PARM('RLC')  
CALL QRDARS/QRLCSTRJ PARM('RLR')  
CALL QRDARS/QRLCSTRJ PARM('RLO')
- \_\_\_ 41. If you installed **iSeries Integration for Windows Server (5722-WSV)** on your system and you saved with your network servers in a VARIED ON setting, perform the following steps:
- \_\_\_ a. Vary off any network servers that are varied on by using the WRKCFGSTS \*NWS command. Select option 2.
  - \_\_\_ b. Create any needed Network Storages by using the CRTNWSSTG command.
  - \_\_\_ c. Add the storage links by using the ADDNWSSTGL command.
  - \_\_\_ d. Vary on your network servers by using the WRKCFGSTS \*NWS command. Select option 1.
  - \_\_\_ e. Restore **iSeries Integration for Windows Server (5722-WSV)** data by typing RST OBJ('/QNTC').
  - \_\_\_ f. Press **Enter**.
  - \_\_\_ g. Follow the instructions in Step 38 to check for error messages, verify your restore, and correct any errors.
- \_\_\_ 42. If you installed **iSeries Integration for Windows Server (5722-WSV)** on your system and you saved with your network servers in a VARIED OFF setting, perform the following steps:
- \_\_\_ a. Add the links for the server descriptions. Type the following for each server description:  
  
ADDNWSSTGL NWSSTG(Storage\_Name) NWS(D(Description))
  - \_\_\_ b. Vary on your network servers by typing WRKCFGSTS \*NWS and by selecting option 1 to vary on each network server.
- \_\_\_ 43. If you have 4764 Cryptographic Coprocessor Hardware recover 5733-CY1 CCA Device Manager by typing CALL QCCAEDEV/QCCAELOAD.
- \_\_\_ 44. Release the jobs that you previously held in Step 37. You have completed the recovery.



---

## Appendix E. Notices

This information was developed for products and services offered in the U.S.A.

IBM may not offer the products, services, or features discussed in this document in other countries. Consult your local IBM representative for information on the products and services currently available in your area. Any reference to an IBM product, program, or service is not intended to state or imply that only that IBM product, program, or service may be used. Any functionally equivalent product, program, or service that does not infringe any IBM intellectual property right may be used instead. However, it is the user's responsibility to evaluate and verify the operation of any non-IBM product, program, or service.

IBM may have patents or pending patent applications covering subject matter described in this document. The furnishing of this document does not grant you any license to these patents. You can send license inquiries, in writing, to:

IBM Director of Licensing  
IBM Corporation  
North Castle Drive  
Armonk, NY 10504-1785  
U.S.A.

For license inquiries regarding double-byte (DBCS) information, contact the IBM Intellectual Property Department in your country or send inquiries, in writing, to:

IBM World Trade Asia Corporation  
Licensing  
2-31 Roppongi 3-chome, Minato-ku  
Tokyo 106-0032, Japan

**The following paragraph does not apply to the United Kingdom or any other country where such provisions are inconsistent with local law:** INTERNATIONAL BUSINESS MACHINES CORPORATION PROVIDES THIS PUBLICATION "AS IS" WITHOUT WARRANTY OF ANY KIND, EITHER EXPRESS OR IMPLIED, INCLUDING, BUT NOT LIMITED TO, THE IMPLIED WARRANTIES OF NON-INFRINGEMENT, MERCHANTABILITY OR FITNESS FOR A PARTICULAR PURPOSE. Some states do not allow disclaimer of express or implied warranties in certain transactions, therefore, this statement may not apply to you.

This information could include technical inaccuracies or typographical errors. Changes are periodically made to the information herein; these changes will be incorporated in new editions of the publication. IBM may make improvements and/or changes in the product(s) and/or the program(s) described in this publication at any time without notice.

Any references in this information to non-IBM Web sites are provided for convenience only and do not in any manner serve as an endorsement of those Web sites. The materials at those Web sites are not part of the materials for this IBM product and use of those Web sites is at your own risk.

IBM may use or distribute any of the information you supply in any way it believes appropriate without incurring any obligation to you.

Licensees of this program who wish to have information about it for the purpose of enabling: (i) the exchange of information between independently created programs and other programs (including this one) and (ii) the mutual use of the information which has been exchanged, should contact:

IBM Corporation

Software Interoperability Coordinator, Department YBWA  
3605 Highway 52 N  
Rochester, MN 55901  
U.S.A.

Such information may be available, subject to appropriate terms and conditions, including in some cases, payment of a fee.

- | The licensed program described in this information and all licensed material available for it are provided
- | by IBM under terms of the IBM Customer Agreement, IBM International Program License Agreement,
- | IBM License Agreement for Machine Code, or any equivalent agreement between us.

Any performance data contained herein was determined in a controlled environment. Therefore, the results obtained in other operating environments may vary significantly. Some measurements may have been made on development-level systems and there is no guarantee that these measurements will be the same on generally available systems. Furthermore, some measurements may have been estimated through extrapolation. Actual results may vary. Users of this document should verify the applicable data for their specific environment.

Information concerning non-IBM products was obtained from the suppliers of those products, their published announcements or other publicly available sources. IBM has not tested those products and cannot confirm the accuracy of performance, compatibility or any other claims related to non-IBM products. Questions on the capabilities of non-IBM products should be addressed to the suppliers of those products.

All statements regarding IBM's future direction or intent are subject to change or withdrawal without notice, and represent goals and objectives only.

All IBM prices shown are IBM's suggested retail prices, are current and are subject to change without notice. Dealer prices may vary.

This information is for planning purposes only. The information herein is subject to change before the products described become available.

This information contains examples of data and reports used in daily business operations. To illustrate them as completely as possible, the examples include the names of individuals, companies, brands, and products. All of these names are fictitious and any similarity to the names and addresses used by an actual business enterprise is entirely coincidental.

#### COPYRIGHT LICENSE:

This information contains sample application programs in source language, which illustrate programming techniques on various operating platforms. You may copy, modify, and distribute these sample programs in any form without payment to IBM, for the purposes of developing, using, marketing or distributing application programs conforming to the application programming interface for the operating platform for which the sample programs are written. These examples have not been thoroughly tested under all conditions. IBM, therefore, cannot guarantee or imply reliability, serviceability, or function of these programs.

Each copy or any portion of these sample programs or any derivative work, must include a copyright notice as follows:

© (your company name) (year). Portions of this code are derived from IBM Corp. Sample Programs. © Copyright IBM Corp. \_enter the year or years\_. All rights reserved.

If you are viewing this information softcopy, the photographs and color illustrations may not appear.

---

## Trademarks

The following terms are trademarks of International Business Machines Corporation in the United States, other countries, or both:

- | AIX
- | AS/400
- | Balance
- | CICS
- | Current
- | Domino
- | eServer
- | i5/OS
- | IBM
- | iSeries
- | Language Environment
- | Notes
- | OpenPower
- | OS/400
- | PowerPC
- | RPG/400
- | System/36
- | System/38
- | WebSphere
- | xSeries

- | Intel<sup>®</sup>, Intel Inside (logos), MMX<sup>™</sup>, and Pentium<sup>®</sup> are trademarks of Intel Corporation in the United States, other countries, or both.

Microsoft<sup>®</sup>, Windows, Windows NT<sup>®</sup>, and the Windows logo are trademarks of Microsoft Corporation in the United States, other countries, or both.

Java and all Java-based trademarks are trademarks of Sun Microsystems, Inc. in the United States, other countries, or both.

- | Linux is a trademark of Linus Torvalds in the United States, other countries, or both.

UNIX<sup>®</sup> is a registered trademark of The Open Group in the United States and other countries.

Other company, product, and service names may be trademarks or service marks of others.

---

## Terms and conditions

Permissions for the use of these publications is granted subject to the following terms and conditions.

**Personal Use:** You may reproduce these publications for your personal, noncommercial use provided that all proprietary notices are preserved. You may not distribute, display or make derivative works of these publications, or any portion thereof, without the express consent of IBM.

**Commercial Use:** You may reproduce, distribute and display these publications solely within your enterprise provided that all proprietary notices are preserved. You may not make derivative works of these publications, or reproduce, distribute or display these publications or any portion thereof outside your enterprise, without the express consent of IBM.

Except as expressly granted in this permission, no other permissions, licenses or rights are granted, either express or implied, to the publications or any information, data, software or other intellectual property contained therein.

IBM reserves the right to withdraw the permissions granted herein whenever, in its discretion, the use of the publications is detrimental to its interest or, as determined by IBM, the above instructions are not being properly followed.

You may not download, export or re-export this information except in full compliance with all applicable laws and regulations, including all United States export laws and regulations.

IBM MAKES NO GUARANTEE ABOUT THE CONTENT OF THESE PUBLICATIONS. THE PUBLICATIONS ARE PROVIDED "AS-IS" AND WITHOUT WARRANTY OF ANY KIND, EITHER EXPRESSED OR IMPLIED, INCLUDING BUT NOT LIMITED TO IMPLIED WARRANTIES OF MERCHANTABILITY, NON-INFRINGEMENT, AND FITNESS FOR A PARTICULAR PURPOSE.



---

## Bibliography

This topic lists publications that provide additional information about topics described or referred to in this book.

- *Are You Saving the Right Stuff?*, G325-6153.

This poster is a visual reminder of the methods available for saving and restoring information on your system. It also highlights the software, hardware, people, and service offerings that are available to help you with backup, recovery, and availability.

- *Storage Solutions*

This iSeries Information Center topic describes how objects are stored on your iSeries™ server . You can access the Information Center at the following Web site:  
<http://www.ibm.com/eserver/iseries/infocenter>

- *Backup Recovery and Media Services for iSeries*, SC41-5345-05.

This book provides information about developing and implementing a backup and recovery strategy using the Backup Recovery and Media Services/400 licensed program. It describes how to create and maintain the policies that govern your backup strategy.

- *CL Programming*, SC41-5721-06.

This book provides the application programmer or programmer with a wide range discussion of the iSeries server programming topics.

- *Communications Configuration*, SC41-5401-00.

This book contains general configuration information, including detailed descriptions of network interfaces, network servers, line, controller, device, mode, NetBIOS, and class-of-service descriptions, configuration lists, and connection lists.

- *Hierarchical Storage Management*, SC41-5351-01

This book provides an overview of hierarchical storage management principles. It also describes considerations for planning for the use of dynamic retrieval that is supplied with Backup Recovery and Media Services for iSeries. The book also provides information on the implementation of hierarchical storage management.

- *ILE Concepts*, SC41-5606-07.

This book describes concepts and terminology for the Integrated Language Environment® (ILE) architecture of the i5/OS operating system. Topics covered include module creation, binding, how to run and debug programs, and exception handling.

- *Local Device Configuration*, SC41-5121-00.

This book provides the system operator or system administrator with information on how to do an initial configuration and how to change the configuration. This book also contains conceptual information about device configuration.

- *OptiConnect for OS/400*, SC41-5414-04.

This book provides information about OptiConnect which is a combination of hardware and software that allows you to connect multiple high-end servers using a high-speed, fiber-optic bus. OptiConnect allows applications to perform intersystem database accesses across a high-performance interface.

- *Optical Support*, SC41-5310-04.

This book provides information on how to attach optical devices to your system. It describes the commands that can be used to work with optical devices.

- *Performance Tools for iSeries*, SC41-5340-01.

This book provides the programmer with the information needed to collect data about the system, job, or program performance. Other performance data: tips for printing and analyzing performance data to identify and correct inefficiencies that might exist. Information about the manager and agent feature is included.

- *Printer Device Programming*, SC41-5713-06.

This book provides information to help you understand and control printing. It provides specific information on printing elements and concepts of the iSeries server, printer file and print spooling support for printing operations, and printer connectivity.

It includes considerations for using personal computers, other printing functions such as Business Graphics Utility (BGU), advanced function printing\* (AFP\*), and examples of working with the iSeries server printing elements such as how to move spooled output files from one output queue to a different output queue. It also includes an appendix of control language (CL) commands used to manage printing workload.

- *iSeries Security Reference*, SC41-5302-09.

This book provides the programmer (or someone who is assigned the responsibilities of a security officer) with information about system security concepts, planning for security, and setting up security on the system. This guide does not describe security for specific licensed programs, languages, and utilities.

- *Simple Network Management Protocol (SNMP) Support*, SC41-5412-00.

This book provides the system operator, programmer, or system administrator with information for configuring the iSeries server to use the simple network management protocol (SNMP) support.

- *SNA Distribution Services*, SC41-5410-01.

This book provides information about the function and administration of Systems Network Architecture distribution services.

- *Install, upgrade, or delete i5/OS and related software*, SC41-5120-09.

This book provides the system operator or system administrator with step-by-step procedures for initially installing, installing licensed programs, program temporary fixes (PTFs), and secondary languages from IBM.

This guide is also for users who already have an iSeries server with an installed release and want to upgrade to a new release.

- Basic system operations.

This iSeries Information Center topic provides information such as handling messages, working with jobs and printer output, devices communications, working with support functions, and cleaning up your system.

- Networking

This iSeries Information Center topic provides information for configuring TCP/IP support and applications. The applications included are TELNET, File Transfer Protocol (FTP), Simple Mail Transfer Protocol (SMTP), line printer requester (LPR), and line printer daemon (LPD).

- *Tips and Tools for Securing Your iSeries*, SC41-5300-07.

This book provides a set of practical suggestions for using the security features of the iSeries server and for establishing operating procedures that are security-conscious. The recommendations in this book apply to an installation with average security requirements and exposures.

- *Work Management*, SC41-5306-03.

This book provides the programmer with information about how to create a work management environment and how to change it.

---

# Index

## Special characters

- (CHGASPA) Change ASP Attribute command 420
- \*ALLOBJ (all object) special authority
  - correcting after restoring 331, 334, 336, 337
- \*ALLOBJ (all-object) special authority
  - restoring 205

## Numerics

- 34xx tape units
  - creating tape configuration 320, 473, 487

## A

- A900 2000 SRC (system reference code)
  - recovery 152
- abbreviated install
  - definition 136
- abend 51
- abnormal end
  - definition 51, 155
  - restarting system 155
- abnormal IPL (initial program load) 155
- access path
  - editing rebuild during IPL 159
  - recovery times
    - restoring 144
  - restoring 233
- access path recovery time
  - recovering 201
- accessing
  - dedicated service tools (DST) 366
  - system service tools 368
- action
  - mirrored protection recovery 269, 275
- active disk unit status 373
- addressability
  - recovering 170
- adopted authority object
  - allowing restore operation 40
- all object (\*ALLOBJ) special authority
  - correcting after restoring 331, 334, 336, 337
- all-object (\*ALLOBJ) special authority
  - restoring 205
- allow object differences (ALWOBJDIF)
  - parameter
    - authorization lists 206
    - effect 32
    - purpose 32
- allow object restore operation (QALWOBJRST) system value 40
- allow user domain objects (QALWUSRDMN) system value 37

- allowing
  - restore
    - adopted authority objects 40
    - sensitive objects 40
    - system-state programs 40
- alternate installation device 347
  - how to verify and select, during a manual installation 350
- ALWOBJDIF (allow object difference)
  - parameter
    - database file 229
    - member 229
- ALWOBJDIF (allow object differences)
  - parameter
    - authorization lists 206
    - effect 32
    - purpose 32
- APIs
  - QsrRestore 249
- Apply Journaled Changes (APYJRNCHG)
  - command
    - broken receiver chain 266
    - unbroken receiver chain 266
  - applying
    - journaled changes
      - broken receiver chain 266
      - determining whether to 264
      - QAOSDIAJRN journal 267
      - unbroken receiver chain 266
- APYJRNCHG (Apply Journaled Changes)
  - command
    - broken receiver chain 266
    - unbroken receiver chain 266
- ASP
  - independent 126
- ASP (auxiliary storage pool)
  - See also* auxiliary storage pool (ASP)
  - overflowed
    - moving journal receivers 391
    - resetting journal 391
- ASP group
  - definition 51
- audit (QAUDJRN) journal
  - creating during restore 46
- authority
  - private 206
  - restoring 206
- authority holder
  - restoring 205
- authorization list
  - restoring 205
  - restoring link 206
- automatic configuration
  - enabling
    - during recovery 148
- automatic IPL after power restored (QPWRRSTIPL) system value 155
- auxiliary storage (ASP)
  - high percentage used 163

- auxiliary storage configuration
  - checklist
    - adding disk to IOA 358
    - adding disk units without device
      - parity protection 356
    - adding input/output adapter 359
    - adding input/output adapter 359
    - deleting auxiliary storage pool (ASP) 362
    - moving disk units 360, 361
    - new system 355
    - removing disk units 363, 364, 365
  - interpreting 372
- auxiliary storage pool
  - definition 51
- auxiliary storage pool (ASP)
  - calculating space requirements 385
  - changing threshold 377, 378
  - creating objects 389
  - deleting 362, 384
  - independent 52
  - moving disk unit 380
  - moving folder 388
  - moving library 387
  - overflowed
    - moving journal receivers 391
    - resetting journal 391
  - primary 52
  - removing disk unit 382
  - secondary 52
  - status 372
  - system
    - removing failed unit 81
  - transferring journals 388
  - transferring objects 386
  - UDFS ASP 52
- user
  - adding disk units 375
  - calculating space requirements 385
  - changing threshold 377, 378
  - creating 375
  - creating document library objects (DLOs) 390
  - creating objects 389, 393
  - deleting 362, 384
  - displaying objects 385
  - journal receivers 390
  - moving disk unit 380
  - removing disk unit 382
  - transferring objects 386

## B

- Backup Recovery and Media Services
  - synchronization 339
- broken receiver chain
  - applying journaled changes 266
- bus failure 276
- busy disk unit status 372

## C

- calculating
    - disk space 385
  - calendar server (QCALSRV) subsystem
    - ending 35
  - CD-ROM
    - restoring i5/OS licensed program 136
  - Change ASP Attribute (CHGASPA)
    - command 420
  - Change Service Tools User Password
    - display 127
  - changed object
    - duplicating on another system 21
    - restoring 21
      - by library 262
      - by object 262
      - cumulative 262
      - directories 263
      - not cumulative 262
    - saving 21
  - changing
    - auxiliary storage pool (ASP)
      - storage threshold 377
    - storage threshold
      - auxiliary storage pool (ASP) 377
      - system auxiliary storage pool (ASP) 378
    - system auxiliary storage pool (ASP)
      - storage threshold 378
  - changing system
    - at IPL
      - during recovery 148
  - checklist
    - disk configuration
      - adding disk to IOA 358
      - adding disk units without device parity protection 356
      - adding input/output adapter 359
      - deleting auxiliary storage pool (ASP) 362
      - moving disk units 360, 361
      - new system 355
      - removing disk units 363, 364, 365
  - cleaning up
    - hardware configuration 219
  - clearing
    - job queue
      - during recovery 144
    - output queue
      - during recovery 144
  - command, CL
    - Apply Journalized Changes (APYJRNCHG)
      - broken receiver chain 266
      - unbroken receiver chain 266
    - APYJRNCHG (Apply Journalized Changes)
      - broken receiver chain 266
      - unbroken receiver chain 266
    - CHGASPA (Change ASP Attribute) 420
    - Display Database Relations (DSPDBR) 237
    - DSPDBR (Display Database Relations) 237
  - command, CL (*continued*)
    - Edit Check Pending Constraint (EDTCCPST) 161
    - EDTCCPST (Edit Check Pending Constraint) 161
    - End Subsystem (ENDSBS)
      - QCALSRV (calendar server) subsystem 35
      - QSYSWRK (subsystem monitor) subsystem 35
      - restricted state 35
      - using 35
    - ENDSBS (End Subsystem)
      - QCALSRV (calendar server) subsystem 35
      - QSYSWRK (subsystem monitor) subsystem 35
      - restricted state 35
      - using 35
    - QRYDOCLIB (Query Document Library) 186
    - Query Document Library (QRYDOCLIB) 186
    - RCLDLO (Reclaim Document Library Object) 246
    - RCLSTG (Reclaim Storage)
      - duplicate names in QRCL 37
      - object ownership 37
      - procedure 36, 171
    - QALWUSRDMN (allow user domain objects) system value 37
    - recovering user ASP 171
    - user domain object 37
    - what system does 37
    - why to run 163
  - RCVJRNE (Receive Journal Entry)
    - writing output to save media 441
  - Receive Journal Entry (RCVJRNE)
    - writing output to save media 441
  - Reclaim Document Library Object (RCLDLO) 246
  - Reclaim Storage (RCLSTG)
    - duplicate names in QRCL 37
    - object ownership 37
    - procedure 36, 171
  - QALWUSRDMN (allow user domain objects) system value 37
  - recovering user ASP 171
  - user domain object 37
  - what system does 37
  - why to run 163
- Rename Directory Entry (RNMDIRE)
  - restoring mail 248
- Rename Document Library Object (RNMDLO)
  - restoring documents 248
- Restore (RST)
  - changed objects 263
  - how to use 248
- Restore (RST) command
  - restrictions 256
  - restrictions when restoring documents 259
- Restore Authority (RSTAUT) 206
  - non-restricted state system 207
- command, CL (*continued*)
  - Restore Configuration (RSTCFG) 218
  - Restore Document Library Object (RSTDLO)
    - maximum number of DLOs 246
    - media error 48
    - output 245
    - overview 244
    - renaming document 247
    - restoring authority 247
    - restoring descriptive information 247
    - restoring ownership 247
    - user ASP 186
  - Restore Library (RSTLIB)
    - \*ALLUSR libraries 223
    - \*IBM libraries 223
    - \*NONSYS libraries 223
    - media error 47
    - multiple concurrent 224
    - OPTION parameter 223
    - overview 223
    - user ASP 184, 188
  - Restore Licensed Program (RSTLICPGM) 244
  - Restore Object (RSTOBJ) 225
    - multiple concurrent 225
  - Restore User Profiles (RSTUSRPRF) 202
  - Retrieve Journal Entry (RTVJRNE)
    - using in program 439
  - RNMDIRE (Rename Directory Entry)
    - restoring mail 248
  - RNMDLO (Rename Document Library Object)
    - restoring documents 248
  - RST (Restore)
    - changed objects 263
    - how to use 248
  - RST (Restore) command
    - restrictions 256
    - restrictions when restoring documents 259
  - RSTAUT (Restore Authority) 206
    - non-restricted state system 207
  - RSTCFG (Restore Configuration) 218
  - RSTDLO (Restore Document Library Object)
    - maximum number of DLOs 246
    - media error 48
    - output 245
    - overview 244
    - renaming document 247
    - restoring authority 247
    - restoring descriptive information 247
    - restoring ownership 247
    - user ASP 186
  - RSTLIB (Restore Library)
    - \*ALLUSR libraries 223
    - \*IBM libraries 223
    - \*NONSYS libraries 223
    - media error 47
    - multiple concurrent 224
    - OPTION parameter 223
    - overview 223
    - user ASP 184, 188

- command, CL (*continued*)
  - RSTLICPGM (Restore Licensed Program) 244
  - RSTOBJ (Restore Object) 225
    - multiple concurrent 225
  - RSTUSRPRF (Restore User Profiles) 202
  - RTVJRNE (Retrieve Journal Entry)
    - using in program 439
  - Save Library (SAVLIB)
    - determining what command was used 287
  - Save/Restore (SAVRST) 21
  - Save/Restore Changed Objects (SAVRSTCHG) 21
  - Save/Restore Configuration (SAVRSTCFG) 21
  - Save/Restore Document Library Object (SAVRSTDLO) 21
  - Save/Restore Library (SAVRSTLIB) 21
  - Save/Restore Object (SAVRSTOBJ) 21
  - SAVLIB (Save Library)
    - determining what command was used 287
  - SAVRST (Save/Restore) 21
  - SAVRSTCFG (Save and Restore Configuration) 21
  - SAVRSTCHG (Save/Restore Changed Objects) 21
  - SAVRSTDLO (Save/Restore Document Library Object) 21
  - SAVRSTLIB (Save/Restore Library) 21
  - SAVRSTOBJ (Save/Restore Object) 21
- compression recovery policy 420
- concurrent add
  - disk unit 355
- configuration
  - cleaning up 219
  - duplicating on another system 21
  - errors for mirrored protection 413
  - restoring 21, 218
    - problems with SRM
      - information 219
  - rules for mirrored protection 411
  - saving 21
- configuration list
  - recovering 201
- configuration object
  - restoring to a different system 219
- configuring
  - disk
    - adding disk to IOA 358
    - adding disk units without device parity protection 356
    - adding input/output adapter 359
    - deleting auxiliary storage pool (ASP) 362
    - moving disk units 360, 361
    - new system 355
    - removing disk units 363, 364, 365
- Confirm Delete ASP Data display 192
- Confirm Move of Unit display 381
- Confirmation Continuation display 381

- considerations
  - mirrored protection 275
- console
  - problem
    - during recovery 152
- console type
  - changing during restore 221
- constraint
  - pending
    - editing during IPL 161
- conversion
  - program 241
    - when restoring programs 242
- CPA3388 message 245
- CPF0975 message
  - during recovery 152
- CPF7088 message 46
- CPF8113 message 163
- CPFAD84 message 22
- CPI0953 message 179
- CPI0954 message 179
- creating
  - document library objects (DLOs)
    - user ASP 390
  - objects
    - user ASP 389, 393
  - tape configuration
    - for 34xx tape units 320, 473, 487
    - for non-34xx tape units 152
  - user ASP 375
- creation date
  - database file
    - restoring 229
- current release-to-previous release support
  - installing previous release
    - compiler 299
  - using TGTRLS (target release) parameter 299

## D

- damaged
  - database file 37, 164
  - document
    - restoring 246
  - folder
    - restoring into 247
  - IBM-supplied user profile 163
  - job description 163
  - job queue 163
  - journal 166
  - journal receiver 166
  - journalized object 167
  - object 167
    - without library 37, 163
  - operating system object 163
  - output queue 163
  - QAOSS (text index) database files 163
  - damaged object
    - recovery 162
- DASD configuration
  - checklist
    - adding disk to IOA 358
    - adding disk units without device parity protection 356

- DASD configuration (*continued*)
  - checklist (*continued*)
    - adding input/output adapter 359
    - adding input/output adapter 359
    - deleting auxiliary storage pool (ASP) 362
      - moving disk units 360, 361
      - new system 355
      - removing disk units 363, 364, 365
    - interpreting 372
  - DASD failure
    - pump 53
    - recovery strategy 53
    - recovery with device parity protection 81
    - recovery with mirrored protection 80
  - data
    - restoring save file 242
  - data area
    - journalized
      - restoring 226
      - restoring 226
        - objects being journalized 226
  - data queue
    - journalized
      - restoring 226
      - restoring 226
        - objects being journalized 226
  - database
    - restoring
      - referential constraints 235
      - trigger program 237
  - database file
    - constraint
      - editing during IPL 161
    - damaged 37, 163, 164
    - deleting 237
    - journalized
      - damaged 167
      - not synchronized 167
    - member
      - damaged 163
    - multiple members
      - example 228
  - QAOSS (text index)
    - damaged 163
  - renaming
    - during restore 229
  - restoring
    - access paths 233
    - ALWOBJDIF (allow object difference) parameter 229
    - considerations 228
    - creation date 229
    - different member set 231
    - files being journalized 226
    - MAXMBRS (maximum members) parameter 231
    - MBROPT (member option) parameter 231
    - member locking 229
    - members, list of 231
    - shared formats 235
  - database relations
    - displaying 237
  - dedicated service tools (DST)
    - definition 51

- dedicated service tools (DST) *(continued)*
    - options 366
    - starting 366
    - stopping 368
  - Dedicated Service Tools (DST) Sign On display 127
  - default
    - owner (QDFTOWN) user profile restoring objects 206
  - define or change system at IPL during recovery 148
  - Define or Change the System at IPL menu 148
  - defining system
    - at IPL during recovery 148
  - deleting
    - auxiliary storage pool (ASP) 362
    - journal 238
    - journal receiver 240
    - physical file 237
    - user ASP 384
  - dependent file restoring 235
  - device
    - recovering after restore operation 220
    - starting during recovery 148
  - device configuration restoring 218
  - device error
    - recovery actions 269
    - unrecoverable 276
  - device parity protection
    - displaying status 408
    - excluding disk unit 407
    - including disk unit 406
    - recovery steps 81
    - starting 397
    - stopping 399
    - working with 397
  - directory
    - restoring
      - changed objects 263
      - restoring objects 248
  - directory entry
    - renaming restoring mail 248
  - disaster recovery
    - sample plan 453
  - disk
    - adding while system active 355
    - concurrent add 355
    - recovering configuration 130
    - understanding configuration status 368
  - disk compression 417
  - considerations 417
  - disk unit capacity 418
  - disk unit full considerations 419
  - error codes 431
    - SRC 6xxx 7051 431
    - SRC 6xxx 7052 432
  - restrictions 417
  - SRC A6xx 0277 420
  - starting 424
- disk compression *(continued)*
    - stopping 426
  - disk configuration
    - checklist
      - adding disk to IOA 358
      - adding disk units without device parity protection 356
      - adding input/output adapter 359
      - adding input/output adapter 359
      - deleting auxiliary storage pool (ASP) 362
      - moving disk units 360, 361
      - new system 355
      - removing disk units 363, 364, 365
    - definition 51
    - interpreting 372
    - recovering 130
  - DISK CONFIGURATION ATTENTION REPORT display 127
  - Disk Configuration Error Report display 155
  - disk configuration status
    - displaying 368
    - printing 368
    - understanding 368
  - disk failure
    - pump 53
    - recovery with device parity protection 81
    - recovery with mirrored protection 80
  - disk pool
    - See* auxiliary storage pool (ASP)
  - disk protection
    - configuration sequences 428
    - adding a storage controller 428
  - disk space
    - calculating 385
  - disk unit
    - adding to system 356
    - assigning to auxiliary storage pool (ASP) 375
    - device parity protection
      - including 406
    - excluding in device parity protection 407
    - failure
      - load source unit before IPL 276
      - moving 380
    - nonconfigured status 375
    - reasons 140
    - removing
      - from ASP 382
    - resuming status 373
    - status 372
    - suspended status 373
    - unprotected status 373
  - disk unit failure
    - recovery strategy 53
  - disk unit full
    - system response 420
  - disk unit number
    - definition 372
  - disk unit status
    - active 373
    - busy 372
    - DPY/Active 373
    - DPY/Failed 372
- disk unit status *(continued)*
    - DPY/Rebuilding 372
    - DPY/Resyncing 373
    - DPY/Unknown 373
    - DPY/Unprotected 372
    - not operational 372
    - not ready 372
    - operational 372
    - performance degraded 372
    - read/write protected 372
    - redundant failure 372
    - suspended 373
    - write protected 372
  - Display Access Path Status display 160
  - Display Constraint Status display 161
  - Display Database Relations (DSPDBR) command 237
  - Display Disk Configuration Capacity display 180, 181
  - displaying
    - database relations 237
    - device parity protection status 408
  - object
    - user ASP 385
  - distribution media
    - restoring i5/OS licensed program 136
    - restoring Licensed Internal Code 113
  - distribution services (QAOSDIAJRN) journal
    - applying journaled changes 267
  - DLO (document library object)
    - creating
      - user ASP 390
    - maximum number on RSTDLO command 246
    - reclaiming 246
    - renaming
      - restoring documents 248
    - restoring
      - descriptive information 247
      - media error 48
      - overview 244
      - renaming document 247
      - user ASP 186
      - using RST (Restore) command 259
    - restoring authority 247
    - restoring ownership 247
  - document
    - restoring
      - damaged 246
      - overview 244
  - document library
    - querying 186
  - document library object
    - duplicating on another system 21
    - saving
      - and restoring 21
  - document library object (DLO)
    - creating
      - user ASP 390
    - maximum number on RSTDLO command 246
    - reclaiming 246
    - renaming
      - restoring documents 248

- document library object (DLO)
  - (continued)
  - restoring
    - descriptive information 247
    - media error 48
    - overview 244
    - renaming document 247
    - user ASP 186
    - using RST (Restore)
      - command 259
  - restoring authority 247
  - restoring ownership 247
- Domino server
  - recovering 252
- DPY/Active disk unit status 373
- DPY/Failed disk unit status 372
- DPY/Rebuilding disk unit status 372
- DPY/Resyncing disk unit status 373
- DPY/Unknown disk unit status 373
- DPY/Unprotected disk unit status 372
- DSPDBR (Display Database Relations)
  - command 237
- DST (dedicated service tools)
  - definition 51
  - options 366
  - starting 366
  - stopping 368
- duplicating 21
  - changed objects 21
  - configuration 21
  - document library objects 21
  - object 21
  - object in directory 21

## E

- Edit Check Pending Constraint (EDTCPCST) command 161
- Edit Check Pending Constraints
  - display 151, 161
- edit description
  - recovering 201
  - restoring 145
- Edit Rebuild of Access Paths
  - display 150, 159
- EDTCPCST (Edit Check Pending Constraint) command 161
- enabling
  - automatic configuration
    - during recovery 148
- End Subsystem (ENDSBS) command
  - QCALSRV (calendar server)
    - subsystem 35
  - QSYSWRK (subsystem monitor)
    - subsystem 35
  - restricted state 35
  - using 35
- ending
  - dedicated service tools (DST) 368
  - mirrored protection 414
  - subsystem
    - QCALSRV (calendar server)
      - subsystem 35
    - QSYSWRK (subsystem monitor)
      - subsystem 35
    - restricted state 35
    - using 35

- ending (continued)
  - system service tools 368
- ENDSBS (End Subsystem) command
  - QSYSWRK (subsystem monitor)
    - subsystem 35
  - restricted state 35
  - using 35
- entire system
  - restore operation
    - unattended 197
  - restoring 196
- error
  - mirrored protection
    - configuration 413
  - permanent read 276
  - restore operation
    - not recoverable 47
    - recoverable 46
  - SRM (system resource management)
    - information 219
  - unrecoverable device 276
- error handling
  - mirrored protection
    - disk 276
- error message 275
- error screens
  - LIC 445
  - licensed internal code
    - installation 445
- escape condition
  - handling with program 439
- example
  - database file
    - multiple members 228
  - handling escape conditions 439
  - using Retrieve Journal Entry (RTVJRNE) command in program 439
- excluding
  - disk unit in device parity
    - protection 407

## F

- failure
  - active mirrored load source 278
  - bus 276
  - I/O processor 276
  - load source unit
    - before IPL 276
- file
  - constraint
    - editing during IPL 161
  - database
    - shared formats 235
  - journaled
    - restoring 226
  - restoring 228
  - logical 232
- file system
  - QNetWare
    - restoring 252
- folder
  - creating
    - user ASP 390
  - restoring
    - damaged 247

- folder (continued)
  - restoring (continued)
    - overview 244
    - procedure 246
  - transferring
    - different ASP 388

## H

- hard link
  - restoring 249
- hardware
  - configuration
    - cleaning up 219
  - hardware resource
    - definition 372
  - human error
    - recovery strategy 53

## I

- i5/OS Integration for Novell NetWare (QNetWare) file system
  - restoring 252
- i5/OS licensed program
  - restoring
    - choosing procedure 136
    - manual IPL 137
    - overview 135
    - preparation 135
    - reasons 135
    - selecting install options 142
    - steps 137
    - using distribution media 136
- IBM-supplied user profile
  - damaged 163
- ICF file
  - writing journal entries 443
- IFS object
  - journaled
    - damaged 167
    - not synchronized 167
    - restoring 226
  - restoring
    - IFS objects being journaled 226
- IMPI (internal microprogramming interface) system
  - restoring programs 242
- including
  - disk unit in device parity
    - protection 406
- independent ASP
  - definition 52
  - recovering disk configuration after complete system loss 126
- independent ASP (auxiliary storage pool)
  - recovering 187
  - recovery procedures
    - complete data loss 84
    - no data loss 82
    - some data loss 83
- initial program load (IPL)
  - after abnormal end 155
  - disk related failure of load source unit 276

- initial program load (IPL) *(continued)*
  - editing check pending
    - constraints 161
  - editing rebuild of access paths 159
  - options
    - during recovery 148
  - performing normal 49
  - restoring operating system 137
  - selecting options
    - restoring operating system 146
- Input/OutputAdapter
  - adding 359
- install options
  - selecting
    - restoring operating system 142
- Install the Operating System display 130
- installation
  - abbreviated
    - definition 136
- installation device
  - alternate 347
- installation error screens
  - licensed internal code 445
- internal microprogramming interface (IMPI) system
  - restoring programs 242
- interpreting
  - disk configuration 372
- IOA
  - adding disk 358
- IPL (initial program load)
  - after abnormal end 155
  - disk related failure of load source
    - unit 276
  - editing check pending
    - constraints 161
  - editing rebuild of access paths 159
  - normal 49
  - options
    - during recovery 148
  - performing normal 49
  - restoring operating system 137
  - selecting options
    - restoring operating system 146
- IPL Options display 133, 147, 158, 319, 472, 486

## J

- job description
  - damaged 163
- job number
  - resetting counter
    - during recovery 144
- job queue
  - clearing during recovery 144
  - damaged 163
- journal
  - damaged 166
  - deleting 238
  - overflowed
    - resetting 391
  - recovering from QRCL library 173
  - restoring 238
  - transferring into user ASP 388

- journal entry
  - RTVJRNE (Retrieve Journal Entry)
    - command 439
  - transmitting to another system 443
  - writing to ICF file 443
- journal receiver
  - damaged 166
  - deleting 240
  - directory
    - correcting 240
  - moving
    - from overflowed ASP 391
  - placing in nonlibrary user ASP 394
  - placing in user ASP 390
  - recovering from QRCL library 173
  - restoring 238
- journalized changes
  - applying
    - broken receiver chain 266
    - determining whether to 264
    - unbroken receiver chain 266
- journalized file
  - restoring 226
- journalized IFS object
  - restoring 226
- journalized object
  - damaged 167
  - not synchronized 167
- journaling
  - applying changes 264

## L

- library
  - duplicating on another system 21
  - locking during restore procedure 44
  - moving
    - different ASP 387
  - restoring 21
    - \*ALLUSR libraries 223
    - \*IBM libraries 223
    - \*NONSYS libraries 223
    - media error 47
    - OPTION parameter 223
    - overview 223
    - user ASP 184, 188
  - saving 21
    - determining what command was used 287
- library list
  - changing
    - during recovery 148
- library user ASP
  - definition 52
- LIC
  - error screens 445
  - installation error screens 445
- licensed internal code
  - installation error screens 445
- Licensed Internal Code
  - definition 52
  - restoring
    - preparation 112
    - starting 112
    - steps 113
    - using distribution media 113

- Licensed Internal Code *(continued)*
  - restoring using function code 23
    - SRC (system reference) codes 118
- Licensed Internal Code IPL in Progress
  - display 129
- licensed programs
  - restoring 244
- link
  - restoring 249
- load source
  - failure
    - active mirrored 278
    - unknown status 280
- load source unit
  - definition 52
  - recovery procedure
    - complete data loss, no user ASP 57
    - complete data loss, user ASP not overflowed 58
    - no data loss 55
    - some data loss 56
- locking
  - database members
    - during restore 229
  - restore processing 44
- logical file
  - restoring 232
- logical partitions
  - restoring 222
- lost object 37, 163

## M

- main storage dump 155
- major system options
  - setting
    - during recovery 148
    - setting during recovery 148
- manual IPL (initial program load)
  - restoring operating system 137
- maximum members (MAXMBRS)
  - parameter
    - exceeding during restore 231
- MAXMBRS (maximum members)
  - parameter
    - exceeding during restore 231
- MBROPT (member option)
  - parameter 231
- media error
  - during RSTDLO procedure 48
  - during RSTLIB procedure 47
  - restoring storage 296
- member
  - damaged 163
  - locking
    - during restore 229
  - renaming
    - during restore 229
  - restoring
    - ALWOBJDIF (allow object difference) parameter 229
    - creation date 229
- member option (MBROPT)
  - parameter 231
- message
  - CPA3388 245



- message (*continued*)
  - CPF7088 46
  - CPF8113 163
  - CPFAD84 22
  - CPI0953 179
  - CPI0954 179
- message reply list
  - restoring 145
- microcode
  - restoring 112
- mirrored protection
  - active disk unit status 373
  - active load source failure 278
  - configuration errors 413
  - configuration rules 411
  - device error
    - recovery actions 269
  - disk error handling 276
  - ending 414
  - I/O processor or bus failure 276
  - missing disk units 276
  - nonconfigured unit
    - using for replacement 273
  - permanent read error
    - recovery actions 269
  - recovery actions
    - errors and failures 269
    - performed by the service representative 275
  - recovery steps 80
  - replacing unit 271
  - resuming 275
  - resuming status 373
  - starting 411
  - stopping 414
  - suspended disk unit status 373
  - suspended status 373
  - unknown load source status 280
  - using spare nonconfigured unit 273
  - working with 411
- mirrored unit
  - replacing 271
  - resuming 271
  - suspending 270
- mirroring
  - device error
    - recovery actions 269
  - permanent read error
    - recovery actions 269
- moving
  - disk unit 380
  - disk units 360, 361
  - folder
    - different ASP 388
  - journal receiver
    - overflowed ASP (auxiliary storage pool) 391
  - library
    - different ASP 387
  - object
    - different ASP 393
  - user profile
    - different system 205

## N

- network
  - database 235
  - restoring 235
- network attribute
  - recovering 201
  - resetting when restoring to a different system 149
- new system
  - configuring disk 355
- non-34xx tape units
  - creating tape configuration 152
- nonconfigured disk unit
  - definition 375
  - reasons 140
- nonconfigured unit
  - mirrored protection 273
- nonlibrary user ASP
  - definition 52
  - placing journal receivers 394
  - working with 393
- nonload source unit
  - recovery procedure
    - complete data loss, no user ASP 67
    - complete data loss, user ASP not overflowed 68
    - complete data loss, user ASP overflowed 72
    - no data loss 66
- normal initial program load (IPL) 49
- not operational disk unit status 372
- not ready disk unit status 372
- not synchronized
  - journaled file 167

## O

- object
  - creating
    - user ASP 389, 393
  - damaged 167
  - duplicating on another system 21
  - lost owner 37
  - ownership
    - restoring 206
  - primary group
    - restoring 206
  - restore sequence 34
  - restoring 21
    - RSTOBJ (Restore Object) command 225
  - saving 21
    - previous release system 299
  - transferring
    - between ASPs 386
    - different ASP 393
  - user ASP
    - displaying 385
    - without library 37, 163
- object in directory
  - duplicating on another system 21
  - restoring 21, 248
  - saving 21

- object ownership
  - ALWOBJDIF (allow object differences) parameter 206
- ObjectConnect
  - components 18
  - list of commands 18
  - problem determination 21
- operating system
  - damaged object 163
  - restoring
    - choosing procedure 136
    - manual IPL 137
    - overview 135
    - preparation 135
    - reasons 135
    - selecting install options 142
    - steps 137
    - using distribution media 136
- Operational Assistant
  - backup
    - recovering 106
- operational disk unit status 372
- OptiConnect
  - communications requirements 18
  - how system runs commands 19
  - job flow 19
  - overview 18
  - setting up 19
- order
  - restoring objects 34
- output
  - RSTDLO (Restore Document Library Object) command 245
- output queue
  - clearing during recovery 144
  - damaged 163
- overflowed object
  - deleting 182
- overflowed status
  - definition 179
- overflowed user ASP
  - deleting objects 182
  - determining status 180
  - displaying 180, 181
  - recovering 179
  - resetting 179, 180
- ownership
  - ALWOBJDIF (allow object differences) parameter 206
  - restoring 206

## P

- parallel restore operations 49
- parent file
  - restoring 235
- pending constraint
  - editing during IPL 161
- performance degraded disk unit status 372
- permanent error 269
- permanent read error
  - mirrored protection
    - recovery actions 269, 276
- physical file
  - deleting 237

- power failure
  - recovery strategy 52
- PowerPC based system
  - restoring programs 242
- previous release system
  - saving objects 299
- previous release-to-current release support
  - considerations when restoring
    - configuration objects 307
  - restoring data to current release system 307
  - saving data on previous release system 307
- primary ASP
  - definition 52
- primary group
  - ALWOBJDIF (allow object differences) parameter 206
  - restoring 206
- printer writer
  - starting
    - during recovery 147
- private authority
  - restoring 206
- problem determination
  - ObjectConnect 21
- profile
  - QDFTOWN (default owner) restoring objects 206
- program
  - conversion 241
  - recreation 241
  - restoring 241
    - different release 242
  - translation 241
  - validation value 241
- program failure
  - recovery strategy 53
- program temporary fix (PTF)
  - restoring 259
- programming example
  - handling escape conditions 439
  - using Retrieve Journal Entry (RTVJRNE) command in program 439
- PTF (program temporary fix)
  - restoring 259
- pump (disk pump) 53

## Q

- QALWOBJRST (allow object restore operation) system value 40
- QALWUSRDMN (allow user domain objects) system value 37
- QAOSDIJRN (distribution services) journal
  - applying journaled changes 267
- QAPZ files
  - attempting to restore 45
- QAUDJRN (audit) journal
  - creating during restore 46
- QCALSrv (calendar server) subsystem
  - ending 35
- QCMN (communications) subsystem
  - OptiConnect 18

- QDFTOWN (default owner) user profile
  - assigning ownership during reclaim storage procedure 37
  - restoring objects 206
- QNetWare
  - restoring 252
- QNTC file system
  - restoring 250
- QPWRRSTIPL (automatic IPL after power restored) system value 155
- QRCL (recovery) library
  - duplicate names 37
  - journal 173
  - journal receiver 173
  - using for recovery 173
- QRYDOCLIB (Query Document Library) command 186
- QSOC (OptiConnect) subsystem
  - OptiConnect 18
- QSOCCT mode description
  - OptiConnect 19
- QSR (OptiConnect) library 18
- QsrRestore API 249
- QSYSMSG message queue
  - error messages 275
- QSYSOPR message queue
  - error messages 275
- QSYSWRK (subsystem monitor) subsystem
  - ending 35
- Query Document Library (QRYDOCLIB) command 186
- querying
  - document library 186
- QUSER user profile
  - OptiConnect 19
- QVFYOBJRST (verify object on restore) system value 40

## R

- RCLDLO (Reclaim Document Library Object) command 246
- RCLSTG (Reclaim Storage) command
  - duplicate names in QRCL 37
  - object ownership 37
  - procedure 36, 171
  - QALWUSRDMN (allow user domain objects) system value 37
  - recovering user ASP 171
  - user domain object 37
  - what system does 37
  - why to run 163
- RCVJRNE (Receive Journal Entry) command
  - writing output to save media 441
- read error 276
- read/write protected disk unit
  - status 372
- Receive Journal Entry (RCVJRNE) command
  - writing output to save media 441
- receiver
  - restoring 238
- receiver chain
  - broken
    - applying journaled changes 266

- receiver chain (*continued*)
  - definition 240
  - unbroken
    - applying journaled changes 266
- receiver directory
  - correcting 240
- Reclaim Document Library Object (RCLDLO) command 246
- Reclaim Storage (RCLSTG) command
  - duplicate names in QRCL 37
  - object ownership 37
  - procedure 36, 171
  - QALWUSRDMN (allow user domain objects) system value 37
  - recovering user ASP 171
  - user domain object 37
  - what system does 37
  - why to run 163
- reclaiming
  - document library object (DLO) 246
  - storage
    - duplicate names in QRCL 37
    - procedure 36, 171
    - QALWUSRDMN (allow user domain objects) system value 37
    - recovering user ASP 171
    - user domain object 37
    - what the system does 37
    - why to run 163
- recoverable error
  - restore operation 46
- recovering
  - access path recovery times 144, 201
  - addressability
    - user ASP 170
  - configuration lists 201
  - damaged database files 164
  - database file
    - damaged 164
  - devices that will not vary on 220
  - disk configuration 130
  - Domino server 252
  - edit descriptions 145, 201
  - i5/OS licensed program
    - choosing procedure 136
    - manual IPL 137
    - overview 135
    - preparation 135
    - reasons 135
    - selecting install options 142
    - steps 137
    - using distribution media 136
  - independent ASP
    - stand-alone 187
  - Licensed Internal Code
    - preparation 112
    - starting 112
    - steps 113
    - using distribution media 113
  - message reply list 145
  - network attributes 201
  - overflowed user ASP 179, 180
  - reply list entries 201
  - restoring
    - preparation 112
    - starting 112

- recovering (*continued*)
  - restoring (*continued*)
    - steps 113
    - using distribution media 113
  - service attributes 144
  - system information 144, 201
  - system management objects 144
  - system reply list 145
  - system values 144, 201
  - System/36 environment 221
  - tape controller 220
  - unsuccessful restore operation 46
  - user ASP
    - addressability 170
    - after system ASP 170
    - overflowed 179, 180
    - stand-alone 183
  - user information
    - choosing procedure 95
    - using Operational Assistant backup 106
    - using Restore menu option 21 100
    - using Restore menu options 22 and 23 103
  - using changed objects 261
  - using journaling 261
  - using SAVSTG (save storage) media 289
  - Windows server 256
- recovery
  - common terminology 51
  - considerations for mirrored protection 275
  - damaged objects 162
  - disaster
    - sample plan 453
  - mirrored protection 275
  - unreadable sectors 162
- recovery (QRCL) library
  - duplicate names 37
  - journal 173
  - journal receiver 173
  - using for recovery 173
- recovery actions
  - mirrored protection 269, 275
  - performed by the service representative
    - mirrored protection 275
- recovery checklist
  - complete system loss 85
    - including independent ASP 88
  - device parity protection 81
  - independent ASP
    - complete data loss 84
    - no data loss 82
    - some data loss 83
  - load source unit
    - complete data loss, no user ASP 57
    - complete data loss, user ASP not overflowed 58
    - complete data loss, user ASP overflowed 62
    - no data loss 55
    - some data loss 56
  - mirrored protection 80
  - non-load source unit
    - complete data loss, no user ASP 67
    - complete data loss, user ASP not overflowed 68
    - complete data loss, user ASP overflowed 72
    - no data loss 66
    - some data loss 66
  - system ASP
    - complete data loss, no user ASP 67
    - complete data loss, user ASP not overflowed 68
    - complete data loss, user ASP overflowed 72
    - no data loss 66
    - some data loss 66
- recovery checklist (*continued*)
  - non-load source unit
    - complete data loss, no user ASP 67
    - complete data loss, user ASP not overflowed 68
    - complete data loss, user ASP overflowed 72
    - no data loss 66
    - some data loss 66
  - system ASP
    - complete data loss, no user ASP 67
    - complete data loss, user ASP not overflowed 68
    - complete data loss, user ASP overflowed 72
    - removing failed unit 81
    - some data loss 66
  - user ASP
    - complete data loss, not overflowed 76
    - complete data loss, overflowed 78
    - no data loss 66
    - some data loss 76, 94
  - user information
    - using commands 97
    - using Restore menu option 21 100
    - using Restore menu options 22 and 23 103
- recovery from unreadable sectors during disk failure 162
- recovery procedure 463, 477
  - complete system loss 85
    - including independent ASP 88
  - device parity protection 81
  - independent ASP
    - complete data loss 84
    - no data loss 82
    - some data loss 83
  - load source unit
    - complete data loss, no user ASP 57
    - complete data loss, user ASP not overflowed 58
    - complete data loss, user ASP overflowed 62
    - no data loss 55
    - some data loss 56
  - mirrored protection 80
  - non-load source unit
    - complete data loss, no user ASP 67
    - complete data loss, user ASP not overflowed 68
    - complete data loss, user ASP overflowed 72
    - no data loss 66
    - some data loss 66
  - system ASP
    - complete data loss, no user ASP 67
    - complete data loss, user ASP not overflowed 68
    - complete data loss, user ASP overflowed 72
    - removing failed unit 81
    - some data loss 66
  - user ASP
    - complete data loss, not overflowed 76
    - complete data loss, overflowed 78
    - no data loss 66
    - some data loss 76, 94
  - user information
    - using commands 97
    - using Restore menu option 21 100
    - using Restore menu options 22 and 23 103
- recovery procedure (*continued*)
  - system ASP (*continued*)
    - removing failed unit 81
    - some data loss 66
  - user ASP
    - complete data loss, not overflowed 76
    - complete data loss, overflowed 78
    - no data loss 66
    - some data loss 76, 94
  - user information
    - using commands 97
    - using Restore menu option 21 100
    - using Restore menu options 22 and 23 103
- recovery steps 463, 477
  - complete system loss 85
    - including independent ASP 88
  - device parity protection 81
  - independent ASP
    - complete data loss 84
    - no data loss 82
    - some data loss 83
  - load source unit
    - complete data loss, no user ASP 57
    - complete data loss, user ASP not overflowed 58
    - complete data loss, user ASP overflowed 62
    - no data loss 55
    - some data loss 56
  - mirrored protection 80
  - non-load source unit
    - complete data loss, no user ASP 67
    - complete data loss, user ASP not overflowed 68
    - complete data loss, user ASP overflowed 72
    - no data loss 66
    - some data loss 66
  - system ASP
    - complete data loss, no user ASP 67
    - complete data loss, user ASP not overflowed 68
    - complete data loss, user ASP overflowed 72
    - removing failed unit 81
    - some data loss 66
  - user ASP
    - complete data loss, not overflowed 76
    - complete data loss, overflowed 78
    - no data loss 66
    - some data loss 76, 94
  - user information
    - using commands 97
    - using Restore menu option 21 100
    - using Restore menu options 22 and 23 103
- recovery strategy
  - disk failure 53
  - human error 53

- recovery strategy (*continued*)
  - power failure 52
  - program failure 53
  - selecting 51
  - system failure 53
- redundant failure disk unit status 372
- referential constraint
  - pending
    - editing during IPL 161
    - restoring 235
- release-to-release support 299
- removing
  - disk unit
    - from ASP 382
  - disk units 363, 364, 365
  - failed disk unit 190
  - failed unit
    - system ASP 81
- Rename Directory Entry (RNMDIRE)
  - command
    - restoring mail 248
- Rename Document Library Object (RNMDLO) command
  - restoring documents 248
- renaming
  - database file
    - during restore 229
  - directory entry
    - restoring mail 248
  - document library object
    - restoring documents 248
- reply list
  - restoring 145
- reply list entry
  - recovering 201
- resetting
  - job number counter 144
  - journal
    - overflowed status 391
    - overflowed user ASP 179, 180
- resource not detected status
  - correcting 219
- resource, hardware
  - definition 372
- Restore (RST) command
  - changed objects 263
  - how to use 248
  - restrictions 256
  - restrictions when restoring
    - documents 259
- Restore Authority (RSTAUT)
  - command 206
  - non-restricted state system 207
- Restore Configuration (RSTCFG)
  - command 218
- Restore Document Library Object (RSTDLO) command
  - maximum number of DLOs 246
  - media error 48
  - output 245
  - overview 244
  - renaming document 247
  - restoring authority 247
  - restoring descriptive information 247
  - restoring ownership 247
  - user ASP 186
- Restore Library (RSTLIB) command
  - \*ALLUSR libraries 223
  - \*IBM libraries 223
  - \*NONSYS libraries 223
  - media error 47
  - multiple concurrent 224
  - OPTION parameter 223
  - overview 223
  - user ASP 184, 188
- Restore Licensed Program (RSTLICPGM)
  - command 244
- restore menu
  - option 21 (entire system) 196
  - option 22 (system data only) 196
  - option 23 (all user data) 196
- Restore menu
  - commands run by menu options 195
  - using 195
- Restore Object (RSTOBJ) command 225
  - multiple concurrent 225
- restore operations
  - parallel 49
- restore strategy
  - disk failure 53
  - human error 53
  - power failure 52
  - program failure 53
  - selecting 51
  - system failure 53
- Restore User Profiles (RSTUSRPRF)
  - command 202
- restoring
  - \*ALLOBJ (all object) special
    - authority 331, 334, 336, 337
  - \*ALLOBJ (all-object) special
    - authority 205
  - access path recovery times 144
  - access paths 233
  - allowing sensitive programs 40
  - ALWOBJDIF (allow object differences)
    - parameter 206
  - authority
    - document library object 247
  - authority holders 205
  - authorization list link 206
  - authorization lists 205
  - changed objects
    - by library 262
    - by object 262
    - cumulative 262
    - not cumulative 262
  - changing console type 221
  - configuration 21, 218
    - problems with system resource
      - management (SRM)
        - information 219
  - correct sequence 34
  - damaged document 246
  - database file
    - ALWOBJDIF (allow object
      - difference) parameter 229
    - creation date 229
    - different member set 231
    - how to 228
  - MAXMBRS (maximum members)
    - parameter 231
- restoring (*continued*)
  - database file (*continued*)
    - MBROPT (member option)
      - parameter 231
      - member locking 229
      - renaming 229
  - determining tape contents 287
  - different system
    - network attributes 149
  - DLO (document library object)
    - maximum number 246
  - DLOs (document library objects)
    - overview 244
  - document library object
    - descriptive information 247
    - media error 48
  - document library object (DLO)
    - renaming document 247
    - user ASP 186
  - document library objects (DLOs)
    - overview 244
  - documents
    - media error 48
    - overview 244
  - Domino server 252
  - edit descriptions 145
  - entire system 196
    - unattended 197
  - error is not recoverable 47
  - error is recoverable 46
  - file with trigger program 237
  - files being journaled 226
  - folders
    - overview 244
    - procedure 246
  - hard link 249
  - i5/OS licensed program
    - choosing procedure 136
    - manual IPL 137
    - overview 135
    - preparation 135
    - reasons 135
    - selecting install options 142
    - steps 137
    - using distribution media 136
  - IFS objects being journaled 226
  - into damaged folder 247
  - journal receivers 238
  - journals 238
  - libraries
    - \*ALLUSR libraries 223
    - \*IBM libraries 223
    - \*NONSYS libraries 223
    - OPTION parameter 223
    - overview 223
  - library
    - media error 47
    - user ASP 184, 188
  - Licensed Internal Code
    - preparation 112
    - starting 112
    - steps 113
    - using distribution media 113
  - licensed programs 244
  - link 249
  - list of members 231
  - locking objects 44

- restoring (*continued*)
  - logical files 232
  - logical partitions 222
  - member
    - renaming 229
  - message reply list 145
  - object
    - how to 225
    - multiple names 249
  - object authority 206
  - object in directory 21
  - objects in directories 248
  - objectss being journaled 226
  - ownership
    - document library object 247
  - parts of system 30
  - program
    - different release 242
  - program temporary fixes (PTF) 259
  - programs 241
  - PTF (program temporary fixes) 259
  - QAPZ files 45
  - QGPL (general purpose) library
    - QAPZ files 45
  - QNetWare file system 252
  - QUSRSYS (user system) library
    - QAPZ files 45
  - referential constraints 235
  - related objects 34
  - Restore System Information 260
  - RSTSYSINF 260
  - save file data 242
  - Save System Information 260
  - SAVSYSINF 260
  - security considerations 40
  - security information
    - object authorities 206
    - object ownership 206
    - ownership 206
    - primary group 206
    - private authorities 206
    - sequence 201
    - user profiles 202
  - service attributes 144
  - shared formats 235
  - soft link 249
  - storage
    - resuming 296
  - symbolic link 249
  - system information 144
  - system management objects 144
  - system reply list 145
  - system values 144
  - unit 277
  - unsuccessful 46
  - user profile
    - different system 205
    - procedure 202
  - using Restore menu 195
  - verifying success 45
  - Windows server 256
- restoring logical partitions 222
- restricted state
  - definition 35
  - starting 35
- Resulting Capacity display 382
- resuming
  - mirror protection 275
  - mirrored unit 271
  - restore storage 296
- resuming status 373
- retranslation 241, 242
- Retrieve Journal Entry (RTVJRNE)
  - command
    - using in program 439
- RNMDIRE (Rename Directory Entry)
  - command
    - restoring mail 248
- RNMDLO (Rename Document Library Object) command
  - restoring documents 248
- RST (Restore) command
  - changed objects 263
  - how to use 248
  - restrictions 256
  - restrictions when restoring documents 259
- RSTAUT (Restore Authority)
  - command 206
  - non-restricted state system 207
- RSTCFG (Restore Configuration)
  - command 218
- RSTDLO (Restore Document Library Object) command
  - maximum number of DLOs 246
  - media error 48
  - output 245
  - overview 244
  - renaming document 247
  - restoring authority 247
  - restoring descriptive information 247
  - restoring ownership 247
  - user ASP 186
- RSTLIB (Restore Library) command
  - \*ALLUSR libraries 223
  - \*IBM libraries 223
  - \*NONSYS libraries 223
  - media error 47
  - multiple concurrent 224
  - OPTION parameter 223
  - overview 223
  - user ASP 184, 188
- RSTLICPGM (Restore Licensed Program)
  - command 244
- RSTOBJ (Restore Object) command 225
  - multiple concurrent 225
- RSTUSRPRF (Restore User Profiles)
  - command 202
- RTVJRNE (Retrieve Journal Entry)
  - command
    - using in program 439
- Save/Restore (SAVRST) command 21
- Save/Restore Changed Objects (SAVRSTCHG) command 21
- Save/Restore Configuration (SAVRSTCFG) command 21
- Save/Restore Document Library Object (SAVRSTDLO) command 21
- Save/Restore Library (SAVRSTLIB)
  - command 21
- Save/Restore Object (SAVRSTOBJ)
  - command 21
- saving
  - changed objects 21
  - configuration 21
  - determining tape contents 287
  - library 21
    - determining what command was used 287
  - object 21
    - previous release system 299
  - object in directory 21
  - unit 277
- saving and restoring
  - document library objects 21
- SAVLIB (Save Library) command
  - determining what command was used 287
- SAVRST (Save/Restore) command 21
- SAVRSTCFG (Save/Restore Configuration) command 21
- SAVRSTCHG (Save/Restore Changed Objects) command 21
- SAVRSTDLO (Save/Restore Document Library Object) command 21
- SAVRSTLIB (Save/Restore Library)
  - command 21
- SAVRSTOBJ (Save/Restore Object)
  - command 21
- SAVSTG (save storage) media
  - using in recovery 289
- SAVSYS (Save System) media
  - definition 112
- screens
  - LIC error 445
  - licensed internal code installation error 445
- secondary ASP
  - definition 52
- sector damage 53
- security information
  - components 201
  - restoring 202
  - sequence 201
  - sequence
    - restoring 201
- security-relevant object
  - allowing restore operation 40
- Select ASP to Delete Data From display 192
- Select DST Console Mode display 128
- Select Product to Work with PTFs display 147, 158
- selecting
  - install options
    - restoring operating system 142
- sensitive object
  - allowing restore 40

- sequence
    - restoring objects 34
  - service attribute
    - restoring 144
  - service representative
    - mirrored protection recovery
      - action 275
  - set major system options
    - during recovery 148
  - Set Major System Options display 148
  - setting
    - major system options
      - during recovery 148
  - setting up
    - OptiConnect 19
  - soft link
    - restoring 249
  - space, disk
    - calculating 385
  - spare nonconfigured unit
    - using 273
  - special authority
    - \*ALLOBJ (all-object)
      - restoring 205
  - Specify ASP to Move Disk Units
    - display 381
  - Specify Install Options display 143
  - Specify Restore Options display 144
  - SRC (system reference code)
    - A6xx 0277 420
    - A900 2000
      - recovery 152
    - restoring Licensed Internal Code
      - using 23 118
  - SRM (system resource management)
    - information
      - correcting problems 219
  - SST (system service tools)
    - definition 52
    - options 366
    - starting 368
    - stopping 368
  - starting
    - dedicated service tools (DST) 366
    - device
      - during recovery 148
    - device parity protection 397
    - mirrored protection 411
    - printer writer
      - during recovery 147
    - system
      - after abnormal end 155
      - system service tools 368
  - starting system
    - Disk Configuration Error Report
      - display 155
    - Work with Current Main Storage
      - Dump display 156
  - status
    - auxiliary storage pool (ASP) 372
    - disk
      - understanding 368
    - disk unit 372
    - unknown load source 280
  - stopping
    - dedicated service tools (DST) 368
    - device parity protection 399
  - stopping (*continued*)
    - mirrored protection 414
    - system service tools 368
  - storage
    - reclaiming
      - duplicate names in QRCL 37
      - procedure 36, 171
      - QALWUSRDMN (allow user domain objects) system
        - value 37
      - recovering user ASP 171
      - user domain object 37
      - what the system does 37
      - why to run 163
    - unit
      - not operational 276
  - storage unit
    - not operational 276
  - subsystem
    - ending
      - QCALSrv (calendar server)
        - subsystem 35
      - QSYSWRK (subsystem monitor)
        - subsystem 35
        - restricted state 35
        - using 35
    - subsystem monitor (QSYSWRK)
      - subsystem
        - ending 35
    - suspended disk unit status 373
    - suspended status 373
    - suspending
      - mirrored units 270
    - symbolic link
      - restoring 249
    - synchronization
      - Backup Recovery and Media
        - Services 339
      - recovery considerations 275
    - synchronizing
      - system
        - methods overview 328
        - planning and procedures 327
  - system
    - parts 30
  - system ASP (auxiliary storage pool)
    - definition 52
    - recovery procedures
      - complete data loss, no user ASP 67
      - complete data loss, user ASP not overflowed 68
      - complete data loss, user ASP overflowed 72
      - removing failed unit 81
      - some data loss 66
      - removing failed unit 81
    - system data
      - restoring 196
    - system failure
      - recovery strategy 53
    - system information
      - recovering 201
      - restoring 144
    - system management object
      - restoring 144
  - system reference code (SRC)
    - A900 2000
      - recovery 152
    - restoring Licensed Internal Code
      - using 23 118
  - system reply list
    - restoring 145
  - system resource management (SRM)
    - information
      - correcting problems 219
  - system service tools (SST)
    - definition 52
    - options 366
    - starting 368
    - stopping 368
  - system state program
    - allowing restore operation 40
  - system status display
    - auxiliary storage
      - high percentage used 163
  - system value
    - allow object restore operation (QALWOBJRST) 40
    - allow user domain objects (QALWUSRDMN) 37
    - automatic IPL after power restored (QPWRRSTIPL) 155
    - changing
      - during recovery 148
    - QALWOBJRST (allow object restore operation) 40
    - QALWUSRDMN (allow user domain objects) 37
    - QPWRRSTIPL (automatic IPL after power restored) 155
    - QSCANFSTCL (scan control) 43
    - QVFYOBJRST (verify object on restore) 40
    - recovering 201
    - restoring 144
    - scan control (QSCANFSTCL) 43
  - System/36 environment
    - during recovery 148
    - recovering 221
- ## T
- tape
    - save
      - determining what command was used 287
  - tape configuration
    - creating
      - for 34xx tape units 320, 473, 487
      - for non-34xx tape units 152
  - tape controller
    - recovering after restore 220
  - target release (TGTRLS) parameter
    - valid values 299
  - temporary error 269
  - terminology
    - recovery 51
  - TGTRLS (target release) parameter
    - valid values 299
  - threshold
    - auxiliary storage pool (ASP)
      - changing 377

- threshold (*continued*)
  - system auxiliary storage pool (ASP)
    - changing 378
- time-out disk error 276
- transferring
  - existing journals into a user ASP 388
  - folder
    - different ASP 388
  - library
    - different ASP 387
  - object
    - different ASP 393
  - objects between ASPs 386
  - user profile
    - different system 205
- translation 242
- trigger
  - restoring 237
- trigger program
  - restoring 237

## U

- unattended restore operation 197
- unbroken receiver chain
  - applying journaled changes 266
- unit
  - mirrored
    - resuming 271
    - suspending 270
  - missing mirrored disk 276
  - not operational storage 276
  - restoring 277
  - saving 277
  - spare nonconfigured 273
- unit number
  - definition 372
- unprotected status 373
- unreadable sectors 53
  - recovery 162
- unrecoverable device error 276
- unrecoverable error
  - restore operation 47
- unsuccessful
  - restore operation 46
- Use Dedicated Service Tools (DST)
  - display 128
- user ASP (auxiliary storage pool)
  - definition 52
  - determining overflowed status 180
  - overflowed
    - deleting objects 182
    - recovering 179
    - resetting 179, 180
  - recovering 183
  - recovery procedure
    - load source unit loss, not
      - overflowed 58
    - load source unit loss,
      - overflowed 62
  - recovery procedures
    - complete data loss, not
      - overflowed 76
    - complete data loss, overflowed 78
    - no data loss 66
    - some data loss 76, 94
- user auxiliary storage pool (ASP)
  - adding disk units 375
  - calculating space requirements 385
  - changing threshold 377, 378
  - creating 375
  - creating document library objects (DLOs) 390
  - creating objects 389, 393
  - deleting 362, 384
  - displaying objects 385
  - journal receivers 390
  - moving disk unit 380
  - removing disk unit 382
  - transferring objects 386
- user data
  - restoring 196
- user domain object
  - reclaiming 37
- user information
  - recovering
    - choosing procedure 95
    - using commands 97
    - using Operational Assistant
      - backup 106
- user profile
  - \*ALLOBJ (all-object) special authority
    - restoring 205
  - IBM-supplied
    - damaged 163
  - moving to different system 205
  - restoring 202
- user-defined file system (UDFS) ASP
  - definition 52
- User-Defined File Systems
  - restoring 175

## V

- validation value 241
- verify object on restore (QVfyOjRST)
  - system value 40
- verifying
  - successful restore 45

## W

- Windows server
  - recovering 256
- Work with Current Main Storage Dump
  - display 156
- working with
  - device parity protection 397
  - Disk Configuration Error Report
    - display 155
  - mirrored protection 411
  - nonlibrary user ASPs 393
  - Work with Current Main Storage
    - Dump display 156
- write protected disk unit status 372
- writing
  - output using RCVJRNE (Receiver Journal Entry) command 441





---

## Readers' Comments — We'd Like to Hear from You

IBM Systems - iSeries  
Backup and Recovery  
Version 5 Revision 4

Publication No. SC41-5304-08

Overall, how satisfied are you with the information in this book?

|                      | Very Satisfied           | Satisfied                | Neutral                  | Dissatisfied             | Very Dissatisfied        |
|----------------------|--------------------------|--------------------------|--------------------------|--------------------------|--------------------------|
| Overall satisfaction | <input type="checkbox"/> | <input type="checkbox"/> | <input type="checkbox"/> | <input type="checkbox"/> | <input type="checkbox"/> |

How satisfied are you that the information in this book is:

|                          | Very Satisfied           | Satisfied                | Neutral                  | Dissatisfied             | Very Dissatisfied        |
|--------------------------|--------------------------|--------------------------|--------------------------|--------------------------|--------------------------|
| Accurate                 | <input type="checkbox"/> | <input type="checkbox"/> | <input type="checkbox"/> | <input type="checkbox"/> | <input type="checkbox"/> |
| Complete                 | <input type="checkbox"/> | <input type="checkbox"/> | <input type="checkbox"/> | <input type="checkbox"/> | <input type="checkbox"/> |
| Easy to find             | <input type="checkbox"/> | <input type="checkbox"/> | <input type="checkbox"/> | <input type="checkbox"/> | <input type="checkbox"/> |
| Easy to understand       | <input type="checkbox"/> | <input type="checkbox"/> | <input type="checkbox"/> | <input type="checkbox"/> | <input type="checkbox"/> |
| Well organized           | <input type="checkbox"/> | <input type="checkbox"/> | <input type="checkbox"/> | <input type="checkbox"/> | <input type="checkbox"/> |
| Applicable to your tasks | <input type="checkbox"/> | <input type="checkbox"/> | <input type="checkbox"/> | <input type="checkbox"/> | <input type="checkbox"/> |

Please tell us how we can improve this book:

Thank you for your responses. May we contact you?  Yes  No

When you send comments to IBM, you grant IBM a nonexclusive right to use or distribute your comments in any way it believes appropriate without incurring any obligation to you.

---

Name

---

Address

---

Company or Organization

---

Phone No.



Fold and Tape

Please do not staple

Fold and Tape



NO POSTAGE  
NECESSARY  
IF MAILED IN THE  
UNITED STATES

# BUSINESS REPLY MAIL

FIRST-CLASS MAIL PERMIT NO. 40 ARMONK, NEW YORK

POSTAGE WILL BE PAID BY ADDRESSEE

IBM CORPORATION  
ATTN DEPT 542 IDCLERK  
3605 HWY 52 N  
ROCHESTER MN 55901-7829



Fold and Tape

Please do not staple

Fold and Tape





Printed in USA

SC41-5304-08

