

IBM

@server

iSeries

Basic System operations





@server

iSeries

Basic System operations

Contents

Basic system operations	1
What's new for V5R2	1
Print this topic	1
iSeries basic operations	2
Using iSeries interfaces	2
Character-based interface	2
Work with devices	3
Work with printer output	4
Work with storage	5
Using removable media	5
Using tapes and tape units	6
Using 1/4-Inch Cartridges	8
Loading 1/4-Inch Tape Cartridges	10
Unloading 1/4-Inch Cartridges	10
Status Lights for MLR3 or MLR1 Tape Units	11
Cleaning the 1/4-Inch Tape Unit	14
Protecting Data Stored on 1/4-Inch Tape Cartridges	14
Status Lights for 8MM Tape Units	16
Tape Unit with Automatic Cartridge Loader	19
Sharing Systems with a 3480, 3490, 3490E, or 3590 Tape Unit	19
1/2-Inch and Magstar MP Tape Unit Addressing	20
Backing Up and Restoring Data with the 1/2-Inch and Magstar MP Tape Unit	20
Cleaning the 3480, 3490, 3490E, and 3590 Tape Unit	20
Cleaning the 3490 Fxx, 3494, and 3570 Tape Units	21
Using 1/2-Inch and Magstar MP Tape Cartridges	21
Using 1/2-Inch tape reels	22
Tapes	22
Reels	22
Preparing a Tape Leader	23
Loading the 1/2-Inch Tape Reel	23
Protecting Data Stored on the 1/2-Inch Tape Reel	24
Cleaning the 1/2-Inch Tape Reel Unit	24
General Tape Usage Information	25
Storage Device Ready Conditions	28
Tape Drive Environment and Use	29
Using CD-ROM Storage	31
Start and stop the iSeries	33
Start up the system	33
Start the system without making changes (unattended IPL)	34
Change the system during IPL (attended IPL)	35
Attended IPL displays	35
Set major system options	35
Define or change the system at IPL	36
Edit access paths during attended IPL	36
Edit check pending constraints during attended IPL	37
Change your system IPL from the system control panel	37
Changing the IPL Start-Up Program	37
Schedule a system shutdown and restart	39
Display the power on and off schedule	39
Change power on and off schedule defaults	39
Change a Day in the Power On and Off Schedule	40
Solve problems with the automatic power schedule	40
System reference codes and primary partitions	40

System reference codes and secondary partitions	42
Causes of abnormal IPLs	44
Signing on to the iSeries	44
Change the system password	45
Stop the system	46
Powering off the system immediately	47
Using the power pushbutton	47
Use the control panel	48
Control panel concepts	48
Types of control panels	49
Physical control panel	49
Remote control panel	49
Virtual control panel	49
Control panel functions	50
Control panel buttons, lights, and indicators	53
Set up your control panel	55
Access control panel functions	56
Instructions and descriptions for control panel functions	57
Normal control panel functions	58
Extended control panel functions	65
Low-level debug panel functions 57 through 70	66
Use remote control panel APIs	67
Power on the system	68
Perform panel lamp test	69
Clear panel lamp test	69
Power off the system	69
Set IPL mode to manual	69
Set IPL mode to normal	70
Set IPL mode to auto	70
Set IPL mode to secure	70
Set IPL type to A	71
Set IPL type to B	71
Set IPL type to C	71
Set IPL type to D	72
Start an IPL	72
Set IPL speed to fast	73
Set IPL speed to slow	73
Set IPL speed to system default	73
Start DST on the primary or alternative console	74
Start a Main Storage Dump	74
Disable CPM	75
Is CPM present?	75
Is CPM enabled?	75
Is the key inserted?	76
Is the power on?	76
Is the attention light lit?	76
Is SPCN present?	77
Get the IPL mode	77
Get the IPL type	77
Get the IPL speed	77
Get type and model information	78
Get the SPCN SRC	78
Get all SRCs 1 - 9	78
System Values That Control IPL	79
OS/400 concepts	82
Messages	83

OS/400 commands	83
Security and user authority	84
Authority to access objects	85
Security levels	85
User profiles	86
Authorization lists	87
Files and file systems	87
Jobs	87
Subsystems, queues and memory pools	88
Objects	89
Log and journals	89
Software fixes	90
Analyze and report system problems	90
Analyze a new problem	90
Getting help with system operation problems	91
Reporting hardware and software problems	92
Manually report problems	92
Automatic problem reporting	92
Query problem status	93
Send a service request immediately.	93
Send a service request later	94
Report problems by voice	95
Add notes to your problem record	95
Find a previously reported problem	95

Basic system operations

The iSeries server is a versatile, powerful and easy-to-use system. However, many of the functions and features of this environment are specific to IBM and the iSeries, and may not be familiar to people who are more familiar with a Windows or UNIX-based environment. This topic introduces some of the key concepts and tasks required for iSeries basic operations. Many of these topics provide an introduction and example, and then suggest further resources for more detailed or advanced information.

What's new in V5R2

Find a summary of the updates and changes to this information in V5R2.

Print this

Access or print this document in PDF format.

iSeries basic operations

Use this topic to find procedures and supporting information for common system tasks.

OS/400 concepts

Learn about the essential components of the iSeries server, including the basics of work management, how to interact with OS/400, and system maintenance.

Analyze and report system problems

Find information to help you solve some basic system problems, and references for getting additional help.

What's new for V5R2

The Basic Operations articles have significant changes for V5R2. This release, information has been added to introduce new users to the fundamental concepts and basic operational tasks for the iSeries servers. In particular, this topic helps users with Microsoft Windows experience work on the iSeries by illustrating common tasks and concepts using iSeries Navigator, and by providing an introduction to CL and the character-based interface. Also new this release, the instructions for analyzing and reporting basic system problems has been streamlined.

In V5R1, this topic was titled Getting started with iSeries. This release, much of the system administration and planning information has been moved. To find this information, refer to:

- Plan for hardware and software
- Hardware
- Installation, upgrades, and migration

Print this topic

To view or download the PDF version, select Basic Operations  (about 677 KB or 189 pages).

To save a PDF on your workstation for viewing or printing:

1. Open the PDF in your browser (click the link above).
2. In the menu of your browser, click **File**.
3. Click **Save As...**
4. Navigate to the directory in which you would like to save the PDF.
5. Click **Save**.

If you need Adobe Acrobat Reader to view or print these PDFs, you can download a copy from the Adobe Web site (www.adobe.com/prodindex/acrobat/readstep.html) .

iSeries basic operations

The iSeries server is built to require only minimal effort to keep it running reliably, and most of the routine operations are performed quickly and easily once you are familiar with them. Use the following topics to help you with some of the common system tasks.

Use iSeries interfaces

Depending on the type of connection to the iSeries server, and the task you need to perform, there are several options available for iSeries interfaces. Learn how to access and use iSeries Navigator, the character-based interface, and the wireless clients.

Work with devices

Most of the peripheral equipment attached to the iSeries server is considered a device. Use this information to set up and configure devices, and to learn about your system's configuration.

Work with printer output

Many jobs on the iSeries server result in printer output. Learn how to find, track, and manage printer output across the iSeries server.

Work with storage

The iSeries server offers many options for fixed and removable storage media. Use this topic to help you configure and maintain storage media like disks, disk pools, tape cartridges and CD-ROMs.

Start and stop the iSeries

The iSeries server is well known for rarely needing to be stopped or restarted. However, some maintenance items or system changes may require that the iSeries server stop processing and go through an initial program load (IPL). Stopping and starting the iSeries should be done carefully. Use this topic to review requirements and options for this process.

Using iSeries interfaces

There are several ways to access the iSeries server, from character based interfaces on an attached console or emulator session to the Windows-style interface in iSeries Navigator. The interface you should use depends on the type of connection with the iSeries server and the task you need to perform. The following topics will help you understand the differences between these interface options, and provide some instructions for how to use them effectively.

Connecting to the iSeries

There are many interfaces available for iSeries servers, and the interface you use depends on the type of connection, and the functions you require. This topic includes instructions and requirements for using consoles, wireless interfaces, and iSeries Navigator.

Character-based interface

The character-based interface available from most emulator sessions or consoles may seem unfamiliar to people without iSeries experience. This topic explains how to navigate the OS/400 menus and provides some suggestions for learning to use this interface.

Character-based interface

The character-based interface is available from most consoles and emulator sessions connected to an iSeries server, and allows more functions than any other interface. While this type of interface may be unfamiliar at first, it includes several easy methods for helping new users, and a menu-based hierarchy of tasks to make finding specific functions simple

The character-based interface includes three primary displays: navigational, input, and informational. The navigation display usually consists of a list of menu options and a command line. You can use this to find information or tasks on the iSeries, and to enter CL commands. Input displays are available when OS/400 requires information from you. Use this display to enter or change information. Informational displays convey system information, and do not allow any interaction.

Finding functions or tasks

All iSeries tasks are organized into categories accessible through the main menu. You can enter menu selections to move through this hierarchy until you find the task you are looking for. Different users may have different menu options available to them, depending on the security strategy, restrictions set by the system administrator, and the active user profile. Once you have found a menu option you would like to use, you can enter commands at the **Selection or Command** prompt located at the bottom of the display. Many menu displays have a name listed in the top-left corner of the display. This name allows you to access it using the **GO** command followed by the name of the menu. For example, **GO JOB** instructs OS/400 to display the job menu:

```
Session A - [24 x 80]
JOB                               Jobs                               System:
Select one of the following:
    1. Work with jobs
    2. Work with all active job statistics
    3. Work with spooled output files
    4. Work with printers
    5. Work with job queues
    6. Work with active subsystems
    7. Submit a job
    20. Control job environment
    60. More job options
    70. Related commands
Selection or command
==>
F3=Exit  F4=Prompt  F9=Retrieve  F12=Cancel  F13=Information Assistant
F16=AS/400 Main menu
(C) COPYRIGHT IBM CORP. 1980, 2002.
a
20/007
Connected to remote
```

Getting help

The character based interface provides several methods for assisting users. First, online help is available for most displays by pressing the **help** or **F1** key. You can often get help with a particular field or item by placing your cursor on it and then pressing the **help** or **F1** key. When you are entering data, you can also get help by entering a **?** in a data field. Finally, the amount and type of information displayed on the display can be controlled by changing the assistance level using the function key indicated at the bottom of the display. Newer users should select **Basic** to get the most help, while more advanced users may prefer the **advanced** level because it allows users to move through displays and commands more quickly.

Work with devices

A device is a piece of equipment that is connected to your system. Most hardware, including internal processors, ports and adapters, drives, communications hardware, workstations, and printers are considered devices. To manage these devices, OS/400 organizes devices by their type, such as workstation or optical drive (CD-ROMs), and identifies specific devices by their resource name. For most internal devices, like processors, adapters and ports, OS/400 automatically assigns the resource name. For most external devices, and some internal storage devices, the iSeries manages communication with

the device through a device controller. Most devices managed through a controller have resource names defined by their device description. You can use the devices type to learn its resource name, physical location, current status, and other information.

Every device in the system has a current status that describes whether it is turned on, and if it is currently communicating with the system. Before a device can function, both it and all devices connecting it to the iSeries server must be varied on (Operational) and functioning. For example, if a communication line or network adapter are varied off, any devices attached to the iSeries server through those devices will not function.

Most devices may have the following possible types of status:

Status	Description
Varied off	OS/400 has disabled the device, and it must be varied on again before communicating with the iSeries server
Varied on (Operational)	OS/400 has enabled communications with the device, and is waiting for communications.
Pending	OS/400 is attempting to enable communications with the device.
Active	The device is currently busy communicating with the iSeries server, and cannot be varied off.

Other types of status are possible for some specific device types, or to indicate a specific problem. For example, a workstation that is waiting for a user to sign on will have a status of Signon display, and a device that OS/400 is unable to locate will have a status of Resource not detected.

View and manage devices

iSeries Navigator allows you to display the current status, physical location, and configuration information for devices. To work with devices in iSeries Navigator, expand **Configuration and service** and select **Hardware**. You can display detailed information about the device, including its model, type and serial number, physical location in the iSeries server, and logical address by right-clicking on the device and selecting **properties**. Additionally, iSeries Navigator provides many functions for managing disk units and pools. Refer to the online help in iSeries Navigator for more information.

To change the status or properties of a device, you should use the character-based interface and type `go device` from any command line. For detailed information on configuring devices for the iSeries server, refer to the **Local Device Configuration**  manual.

Work with printer output

Many jobs generate output that requires printing. OS/400 handles this by creating spooled files that contain the document data and processing instructions for the print job. Once created, OS/400 sends the spooled files to an output queue. Similar to a job queue, output queues hold many spooled files until a printer becomes available. The output queue that OS/400 sends the spooled file to varies, according to the job attributes, user profile, and workstation settings. Before any of the spooled files can be printed, a printer device must be varied on, and a print writer started. The print writer is an OS/400 function that runs for each active printer on the system. When started, the print writer will watch the specified output queue (or queues) and send the spooled files to its printer.

Work with printer output

iSeries Navigator allows you to find and manage printer output. To see a list of spooled files waiting for printing, expand **Basic Operations**, and then click **Printer Output**. This displays all spooled files associated with the current user. You can work with other print jobs by selecting **View** → **Customize this**

view —> **Include** from the iSeries Navigator menu. Right-click on a spooled file to hold, release, move, or delete the print job, or convert it to a PDF. Additionally, you can select **Properties** to change many of the spooled files attributes.

Starting printers

To start an iSeries printer, make sure that:

- The printer is turned on and ready
- The printer or print method has been configured in OS/400.
- The printer has been varied on:
 1. Enter WRKCFGSTS *DEV command. The Work with Configuration Status display shows a list of devices.
 2. Enter a 1 next to the printer device description to vary on the printer.
- Use the Start Print Writer (STRPRTWTR) command to start the print writer, and specify the printer and output queue (or queues) that the writer will service.

Related information

Configuring and managing iSeries printing can be a complex task. Refer to the following resources for additional information:

Printing

Use this information to learn about iSeries printing solutions and how to configure them.

Printer Device Programming

Find detailed procedures for working with printers and print functions in OS/400.

Printing Redbook

Learn about the printing capabilities of the iSeries server, and find practical configuration recommendations.

Work with storage

The iSeries servers offer a wide variety of options for storing system data. Internally, the iSeries includes disk units that may be distributed across several expansion units (or towers). As a system operator, you may need to work with these disk units and track their usage across your business. Additionally, there are many options for working with removable media like CD-ROMs (Optical disks) and tapes. These storage devices are frequently used for backing up the system and archiving data.

Managing disk units and disk pools

Use this topic to learn how to track and manage towers or expansion units, disks and disk pools.

Removable media

You may need to use CD-ROMs to load or distribute Licensed Programs or other data. Also, iSeries tape units provide an efficient choice for archiving saved versions of your system. Use this topic to learn how to work with and maintain CD-ROMs and tape drives.

For more information, refer to the Storage topic.

Using removable media

To ensure a successful backup, it is important to handle and maintain the media properly. The iSeries uses the following media for saving or restoring data:

- Using Tapes and Tape Units
- Using CD-ROM

- Using Optical Media Libraries

Using tapes and tape units: There are several types of tape cartridges and tape units that are commonly used on the iSeries server:

- Using quarter-inch cartridges
- Using 1/2-Inch and Magstar MP Tape Cartridges
- Using 1/2-Inch and Magstar MP Tape Units
- Using 8-Millimeter Tape Units
- Using 1/2-Inch tape reels

Term	Description
Tape Cartridge	A tape cartridge is a case containing a reel of magnetic tape that can be put into a tape unit without stringing the tape between reels.
Tape Reel	A tape reel is a round device on which magnetic tape is wound.
Tape Drive	A tape drive is a device that is used to move the tape and read and write information on magnetic tapes.
Tape Unit	A tape unit is a physical enclosure that contains the tape drive.
Tape Library	The complete collection of tapes available for use on the system (including all new, scratch, used tape cartridges, or reels) is a tape library.

For background information on using tapes and tape drives, refer to:

- General Tape Usage Information
- Tape drive environment and use

For all tapes, you need to establish a procedure for maintaining a tape library which includes:

- Assigning each tape a unique volume ID.
Each tape must have a unique volume ID to maintain the accuracy of tape volume statistics as shown in monitoring tape volume statistics . On barcoded tapes, the volume ID must match the bar code.
- Establishing a temperature and humidity controlled tape media storage area.
- Maintaining records for each tape volume including:
 - Date the tape was purchased
 - Problems encountered
 - Corrective action taken

Regardless of the type of tape you are using, follow these guidelines to avoid damage and loss of the data on the tape.

- Leave the reels or cartridges in their protective container until you use them.
- Place reels or cartridges in the computer room for 24 hours before using them.
- Remove the reel or cartridge from the tape unit when it is not in use.
- Store reels or cartridges in the protective container.
- Copy and then throw away reels and cartridges that have a high number of temporary errors. See monitoring tape volume statistics for information on how to obtain the number of errors.
- Operate tape units in a relatively clean, dust-free environment. Storing and operating tape media and tape devices in a dirty environment may cause errors and early life failures.
- 8mm 160-meter tapes must have media recognition system (MRS), or the tapes will not load.

Apply an external label to the outside of each reel or cartridge and to the protective container when you store data on a tape. These labels can be ordered separately. Record information such as:

- Name or number of the reel or cartridge

- Type of data stored on the reel or cartridge
- Date the data was stored on the tape
- Tape volume ID

Do not:

- Carry cartridges loosely in a box or basket because the leader blocks can catch on other tapes and become unlatched.
- Stack more than six cartridges on top of each other.
- Open a cartridge.
- Release the leader block and pull the tape from the cartridge.
- Touch any exposed tape.
- Expose the tape to direct sunlight, moisture, or high magnetic fields.
- Drop the tape reel or cartridge.
- Apply an external label to the outside top of the cartridge or reel. This could interfere with the drive or media operation.

Tapes, tape units, and diskettes are used primarily for saving and restoring system data. A tape unit is the physical enclosure that holds the tape drive.

Verifying that your tape unit works correctly

To verify that your tape unit is working correctly, do the following:

1. Remove the reel or cartridge from the tape unit.
2. Type **WRKCFGSTS *DEV *TAP** on any command line and make the tape unit unavailable to the iSeries (vary off).
3. Clean the tape unit. Refer to the cleaning instructions for the tape unit you are using.
4. Type the Verify Tape (VFYTAP) command on any command line and press **Enter** .

Errors That Can Occur with Tape Units

If an error message appears during tape usage, you can put the cursor under the message, and press **F1** or **HELP** . Then follow the instruction in the online help information to resolve the problem.

Using 1/4-Inch Tape Units

The iSeries server supports the following 1/4-inch tape units:

- Internal tape features
- 7207 Model 122

For more information about the 7207 Model 122, refer to the following publication: *SA37-0400, 7207 Model 122 4GB External SLR5 Quarter-Inch Cartridge Tape Drive Setup, Operator, and Service Guide* .

Note: The tape unit installed in the 7207 Model 122 is functionally the same as the internal feature identified as QIC-4GB-DC.

Using 1/4-Inch Cartridges

The image below shows a 1/4-inch tape cartridge and the box used for storage.

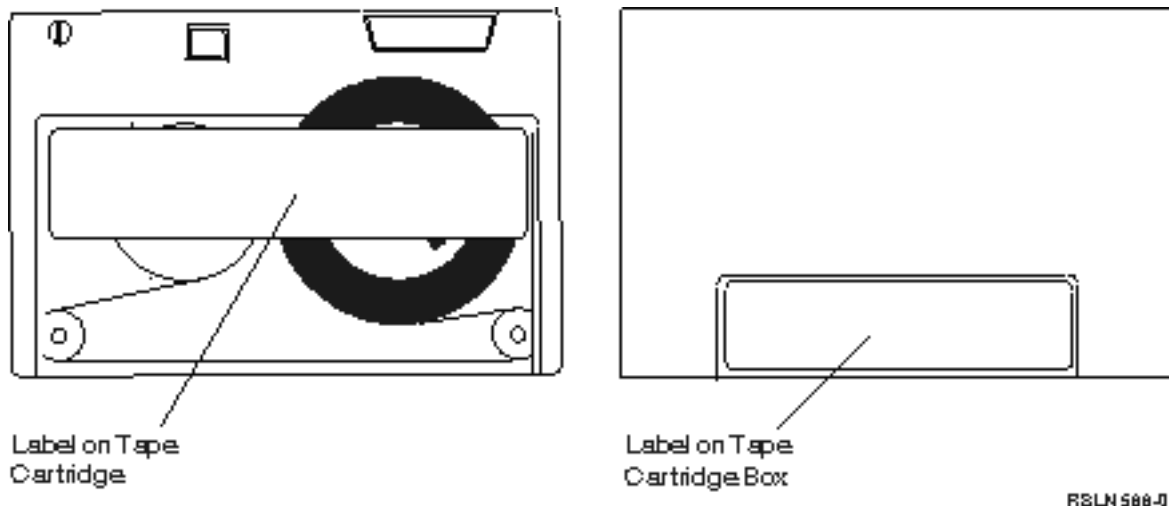

Attention: Do not attach labels to the edges of the 1/4-inch tape cartridges; this may interfere with the cartridge sensors and cause the tape to run off the end of the spools.

Tape Cartridge and 1/4-Inch Tape Unit Compatibility:

For full read/write capability, follow the guidelines in the table below to determine which tape cartridges to use for each tape unit.

Compatibility Between Tape Cartridges and Tape Units

Capacity and Date Rate by Media Type/Format				Read/Write Support by Tape Unit Feature Code Number ^{1,2}					
Media Type (IBM P/N)	iSeries Format (density)	Data Compaction ³	Capacity and Data Rate ⁴	6380 6480	6381 6481	4482 4582 6382 6482	4483 4583 6383 6483	6385 6485	4486 4586 6386 6486
MLR3-25GB (59H4128)	MLR3	Yes	25GB 2.0MB/s	No	No	No	No	No	R/W
MLR1-16GB (59H4175)	QIC5010	Yes	16GB 1.5MB/s	No	No	No	R/W	R/W	R/W
DC5010 (16G8574)	QIC5020	Yes	13GB 1.5MB/s	No	No	No	R/W	R/W	R/W
SLR5-4GB (59H3660)	QIC4DC	Yes*	8GB 760KB/s	No	No	R/W	R	No	R
SLR5-4GB (59H3660)	QIC4GB	No	4GB 380KB/s	No	No	R/W	R	No	R
DC9250 (16GB8436)	QIC2DC	Yes*	5GB 600KB/s	No	R/W	R/W	R	No	R
DC9200 (16G88541)	QIC2DC	Yes*	4GB 600KB/s	No	R/W	R/W	R	No	R

Capacity and Data Rate by Media Type/Format				Read/Write Support by Tape Unit Feature Code Number ^{1,2}					
Media Type (IBM P/N)	iSeries Format (density)	Data Compaction ³	Capacity and Data Rate ⁴	6380 6480	6381 6481	4482 4582 6382 6482	4483 4583 6383 6483	6385 6485	4486 4586 6386 6486
DC9250 (16G8436)	QIC2GB	No	2.5GB 300KB/s	R/W	R/W	R/W	R	R/W	R
DC9200 (16G8541)	QIC2GB	No	2GB 300KB/s	R/W	R/W	R/W	R	R/W	R
DC9120 (21F8730)	QIC1000	No	1.2GB 300KB/s	R/W	R/W	R/W	No	R/W	No
DC9100 (16G8539)	QIC1000	No	1GB 300KB/s	R/W	R/W	R/W	No	R/W	No
DC6525 (21F8597)	QIC525	No	525MB 200KB/s	R/W	R/W	R/W	No	R/W	No
DC6320 (21F8583)	QIC525	No	320MB 200KB/s	R/W	R/W	R/W	No	R/W	No
DC6150 (21F8578)	QIC120	No	120MB 120KB/s	R/W	R/W	R/W	No	R/W	No
DC6150 (21F8578)	QIC24	No	60MB 92KB/s	R	R	No	No	No	No

1. Refer to Recommended cleaning cartridges to correlate the tape unit feature code number to the tape unit front bezel label.
2. In the Tape Unit Feature Code # columns, "R/W" indicates both read and write support of the associated media type and format. An "R" indicates read only. "No" indicates that the media type and format is not supported.
3. Data Compaction is a term used to describe a data recording option for compacting (or compressing) data prior to writing to the tape media. Selecting the data compaction option will usually result in an increase in both capacity and data transfer rate. The typical compaction ratio is 2:1, but is dependent upon the type of data. **A "Yes" in the Data Compaction column means that the associated media type and format supports data compaction.** The OS/400 **SAVE** command parameter COMPACT is used to select the data compaction option, except for those cases identified by a "Yes*". **A "Yes*" indicates that the compaction option is controlled entirely by the format (density) that is selected during the tape initialization operation.** The OS/400 **SAVE** command parameter COMPACT will have **No effect** in these cases.
 - QIC2DC is a compaction format (density) for the DC9250 and DC9200 media type.
 - QIC4DC is a compaction format (density) for the SLR5-4GB media type.
4. Cartridge capacities and data transfer rates shown are for non-compacted data, except for the QIC4DC and QIC2DC cases. For the QIC4DC and QIC2DC formats (densities), the capacities and the data transfer rates shown assume a typical 2:1 data compaction. See Note 2.

If the QIC format and the tape cartridge are not compatible, an error message displays. Errors that can occur are:

- Selecting a QIC format that cannot be written on the tape. For example, inserting a DC6150 tape cartridge and specifying a QIC1000 format.
- Attempting to process a high density tape cartridge in a low density tape unit. For example, you try to process an SLR5-4GB cartridge in a 6381 tape unit.
- Attempting to add a file and selecting a QIC format different from the format previously recorded on the tape. For example, inserting a tape cartridge recorded in QIC525 format and specifying a QIC120 format.

Note: When purchasing non-IBM tape cartridges, purchase a small quantity to verify the tape quality. Quality tape reduces the possibility of tape cartridge problems.

Loading 1/4-Inch Tape Cartridges

To load a 1/4-inch tape cartridge in a QIC-4GB-DC, QIC-2GB(DC), or QIC-2GB tape unit:

1. Push the pushbutton on the tape unit door to release the door.
2. Pull the tape unit door out, then push it down.
3. Insert the tape cartridge into the tape unit.

The cartridge should be inserted firmly until it cannot go any further into the tape unit. About 10-mm (3/8 inch) of the cartridge remains outside the tape unit.

4. Lift up the tape unit door, then push it closed. The cartridge does not go all the way into the tape unit until the tape unit door is closed. Use moderate force to close the door. Slamming the door shut may damage the tape unit.

Push the door until the latch holds the door closed.

To load a 1/4-inch tape cartridge in an MLR3 or an MLR1 tape unit, insert a tape cartridge through the cover door until the loading mechanism pulls the cartridge into the drive. This allows the door to close.

For older tape cartridge types, the 1/4-inch tape units run a retension operation whenever a tape cartridge is loaded. The tape unit will also run a retension operation if a tape cartridge is in the tape unit when the door is closed. Retension means that the tape unit moves the tape to the end-of-tape position and rewinds it to the beginning-of-tape position. The retension operation is part of the load sequence. When using MLR3-25GB, DC5010, and MLR1-16GB tape cartridges, the tape units run the retension operation only when necessary (as determined by the tape unit) to maintain correct tape tension. The approximate retension times are as follows:

Retension Times for 1/4-Inch Tape Cartridges

Tape Cartridge	Approximate Retension Time
MLR3-25GB	Less than 8 minutes
MLR1-16GB	Less than 8 minutes
DC5010	Less than 6 minutes
SLR5-4GB	Less than 8 minutes
DC9250	Less than 4 minutes
DC9120	Less than 4 minutes
DC6525	Less than 4 minutes
DC6320	Less than 3 minutes
DC6150	Less than 3 minutes

Unloading 1/4-Inch Cartridges

Important:

For the QIC-4GB-DC, QIC-2GB(DC), or QIC-2GB tape unit, do not remove a tape cartridge if the tape unit status light is green. For the MLR3 and MLR1 tape units, do not remove a tape cartridge if the tape unit activity light is on. Only a cleaning cartridge can be removed when the status light is green or the activity light is on.

If you remove a tape cartridge while the status light is green, or the activity light is on, you may have the following problems:

- A system message indicates that an error has occurred and the tape job must be repeated.
- You may not be able to retrieve data already on the cartridge because end-of-tape processing did not complete.

To unload the MLR3 or MLR1 1/4-inch tape unit, wait until the activity light is off. Press the unload button. The tape drive rewinds the tape, unloads and ejects the tape cartridge. If the tape cartridge cannot unload and has to be removed manually from the tape drive, contact your service representative.

To unload 1/4-inch tape cartridges from the QIC-4GB-DC, QIC-2GB(DC), or QIC-2GB tapes units:

1. Push the pushbutton on the tape unit door to release the door.
2. Pull the tape cartridge unit door out, then push it down.
Moderate force is necessary to fully open the door with the tape cartridge in the tape unit. Excessive force damages the tape unit.
3. Grasp the tape cartridge and pull the cartridge straight out of the slot. Turning the cartridge or pulling too hard may damage the door mechanism.
4. Lift up the tape unit door, then push it closed.
Little force is required to close and latch the door when the tape unit is empty. Moderate force is required when a tape cartridge is in the tape unit. Be sure to close the door on the first attempt. If the door does not close completely and pops open, the tape drive may receive two retention commands. This condition may cause an error which requires an initial program load (IPL) to recover.

If you remove the tape cartridge while the green light is on, turn the light off by:

- Inserting the cartridge again.
- Run the Check Tape (CHKTAP) command and specify *REWIND for the End of tape option (ENDOPT) parameter.

Remember: Do not remove a tape cartridge from the tape unit unless the last command was run with *REWIND or *UNLOAD specified for the End of tape option (ENDOPT) parameter.

If the last command ends with *LEAVE, the tape unit heads might be over a data area. To avoid this, specify *REWIND or *UNLOAD for the End of tape option (ENDOPT) parameter of the last tape command. You may also use the Check Tape (CHKTAP) command with *REWIND specified for the End of tape option (ENDOPT) parameter.

Tape cartridges can be left in the drive for several hours or overnight if:

- The green light is off (*REWIND is specified for the End of tape option (ENDOPT) parameter).
- The room temperature does not vary by more than 9.5 degrees C (15 degrees F).
- Humidity levels are within the range that is shown in the table in Shipping, Storage, and Operating Environments for 1/4-Inch Tape Cartridges.

Status Lights for MLR3 or MLR1 Tape Units

The MLR3 and the MLR1 tape units have three indicator lights: two green and one amber. These status lights are turned on and off in various combinations to indicate the status of the tape unit.

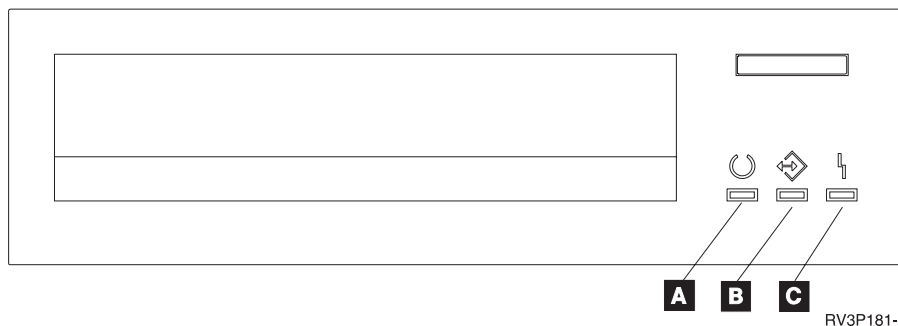

The symbols that are located next to the status lights are the International Organization for Standardization (ISO) symbols that define the general function of the status lights as follows:

(A)	<p>Ready. This light indicates the following conditions:</p> <ul style="list-style-type: none"> • Off - No cartridge installed or no fault condition • Green - Cartridge installed, loading or unloading • Green flashing - Power on self-test in progress.
(B)	<p>Activity. This light indicates the following conditions:</p> <ul style="list-style-type: none"> • Off - No cartridge installed. No activity or fault condition • Green flashing - Cartridge activity
(C)	<p>Fault. This light indicates the following conditions:</p> <ul style="list-style-type: none"> • Off - No fault condition • Amber - Cleaning required or worn tape media • Amber flashing - Fault condition

The various on/off combinations of the status lights are shown in the following chart.

Status Lights	State	Status
	On	Status light tests. (The status lights are on for 2 seconds when the power is turned on.)
	On	
	On	
	Flashing	Power up selftests. Diagnostic cartridge activity.
	Off	
	Off	
	Off	Cartridge not loaded.
	Off	
	Off	
	Off	Cartridge not loaded. Cleaning required.
	Off	
	On	
	On	Cartridge loaded. No activity.
	Off	
	Off	
	On	Cartridge loaded. Activity.
	Flashing	
	Off	
	On	Cartridge loaded. No activity. Cleaning required.
	Off	
	On	
	On	Cartridge loaded. Activity. Cleaning required.
	Flashing	
	On	
	Off	Cartridge loading or unloading
	Flashing	
	Off	
	Off	Cartridge loading or unloading. Cleaning required.
	Flashing	
	On	
	Off	Unrecoverable drive failure or microcode download failure.
	Off	
	Flashing	

RV3P182-0

Cleaning the 1/4-Inch Tape Unit

The 1/4-inch tape unit requires periodic head cleaning. Cleaning the tape unit read/write head is important. This cleaning prevents a build up of debris that could cause unrecoverable errors when writing or reading data. In general, the clean the head after every 8 hours of tape movement when using IBM tape cartridges. Other tape media may require cleaning more frequently. If using new tape cartridges it is advisable to clean the head after two (2) hours of tape movement, or before loading each new tape cartridge.

Note: System messages are posted when the tape unit determines that cleaning is required. The MLR1, MLR1-S, and MLR3 tape units also have a cleaning status light that indicates that cleaning is required. It is very important to respond to these cleaning indicators and clean the head using a recommended cleaning method.

Use the IBM Cleaning Cartridge Kits as recommended below.

Recommended IBM Cleaning Cartridges

Tape Unit Identification		Recommended IBM Cleaning Cartridges		
Front Bezel Label	Feature Code Numbers	P/N 59H4366 Note 1, 2	P/N 46G2674 Note 1	P/N 16G8572
MLR3	4486 4586 6386 6486	Yes	No	No
MLR1 QIC-5010-DC	6385 6485	Yes	Yes	No
MLR1-S QIC-5010-DC	4483 4583 6383 6483	Yes	Yes	No
QIC-4GB-DC	4482 4582 6382 6482	Yes	Yes	Yes
QIC-2GB (DC)	6381 6481	Yes	Yes	Yes
QIC-2GB	6380 6480	Yes	Yes	Yes

Notes:

- The cleaning cycle takes place automatically when the cleaning cartridge is loaded.
 - For the MLR1, MLR1-S, and MLR3 tape units, the amber activity light flashes at a rate of 2 cycles per second during the cleaning operation.
 - For the QIC-4GB-DC, QIC-2GB (DC), and QIC-2GB tape units, the status light flashes at a rate of 1 cycle per second during the cleaning operation. After the flashing stops, remove the cartridge.
- The MLR3 tape unit uses an enhanced cleaning procedure. The duration of this procedure is approximately three (3) minutes.

Protecting Data Stored on 1/4-Inch Tape Cartridges

To protect data from being overwritten:

- Set the pointer toward **SAFE** for older style tape cartridges, as shown in the first image below.

- Set the pointer toward the locked padlock icon for the newer style tape cartridges, as shown in the second image below.

To not protect the data:

- Set the pointer away from **SAFE** for the older style tape cartridges, as shown in the first image below.
- Set the pointer toward the unlocked padlock icon, for the newer style tape cartridges, as shown in the second image below.

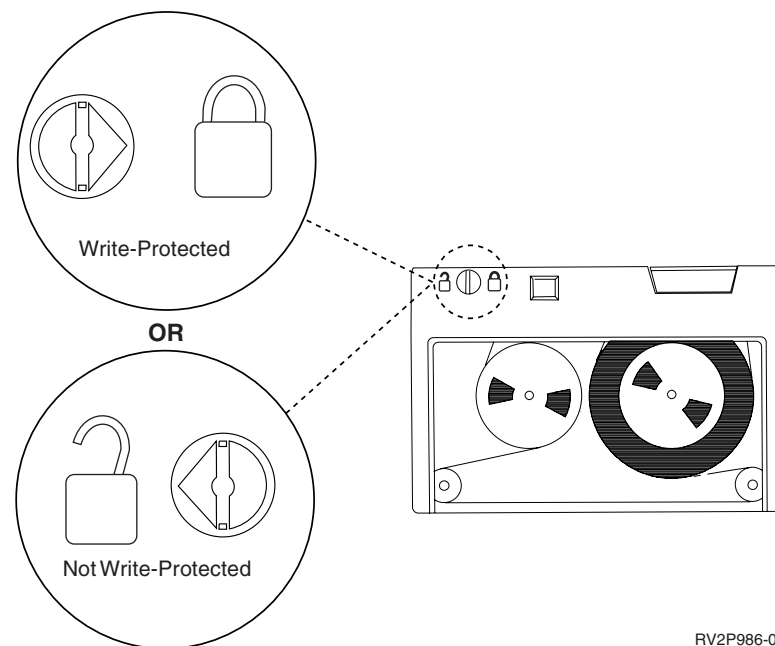
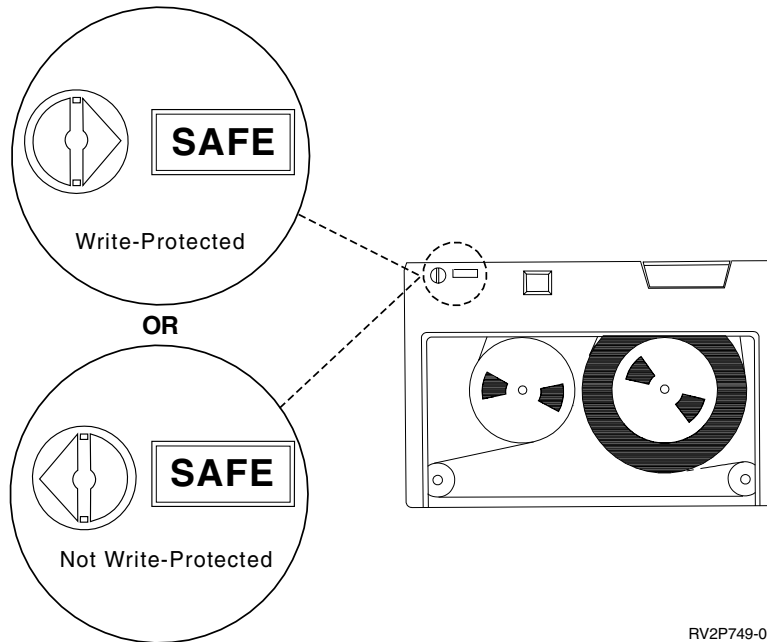

Shipping, Storage, and Operating Environments for 1/4-Inch Tape Cartridges

The recommended environment for operation, storage, and shipment of 1/4-inch tape cartridges is a temperature of 15 to 25 degrees C (59 to 77 degrees F), and a relative humidity of 40 to 60%. The table below provides maximum and minimum environmental conditions for safe shipment, storage, and use of

the tape cartridges for an iSeries tape unit. A hyphen (-) indicates that the dry bulb temperature is outside the recommended range for safe operation, storage, or shipment.

Environment Ranges for 1/4-Inch Tape Cartridges

Dry Bulb Temperature Degrees		Relative Humidity (Percent)		
Celsius	Fahrenheit	Operating	Storage	Shipping
-40	-40.2	-	-	20 to 80
10	50	20 to 80	20 to 80	20 to 80
20	68	20 to 80	20 to 80	20 to 80
30	86	20 to 55	20 to 73	20 to 73
40	104	-	20 to 32	20 to 32

Using 8-Millimeter Tape Units

The iSeries supports the following tape units:

- 7208 Models 002, 012, 222, 232, 234, and 342
- 9427 Models 210, 211
- Feature Code 6390

The 7208 Models 002, 012, 222, 232, 234, and 342 are external tape units for the iSeries System Units.

For the 7208 Model 002, refer to the following publication:

- *IBM 7208 Model 002 2.3GB External 8mm Tape Operator Guide* SA23-2675.

For the 7208 Model 012, refer to the following publication:

- *IBM 7208 5.0GB External 8mm Tape Unit Model 012 Operator Guide*, SA26-7036.

For the 7208 Model 222, refer to the following publication:

- *IBM 7208 7.0GB External 8mm Tape Unit Model 222 Operator Guide*, SA26-7117.

For the 7208 Model 232 and 234, refer to the following publication:

- *IBM 7208 External 8mm Tape Subsystem Models 232 and 234 operator's Guide*, SA26-7104.

For the 7208 Model 342, refer to the following publication:

- *IBM 7208 20GB External 8mm Tape Unit Model 342 Setup and Operator Guide*, SA37-0380.

Note:

The 7208-342 can read tapes written at the 2GB, 5GB, or 7GB formats. However, if a 20GB tape is inserted after the drive has been using a lower density tape, the 20GB tape is ejected and the drive will post a **must clean** message. The drive must be cleaned using the correct cleaning cartridge before it may be used again.

For the 9427 Models 210 and 211, refer to the following publication:

- *IBM 7208 External 8mm Tape Subsystem Models 210 and 211 operator's Guide*, SA26-7108.

The feature code 6390 is an 8mm tape unit that is internal to the iSeries.

Status Lights for 8MM Tape Units



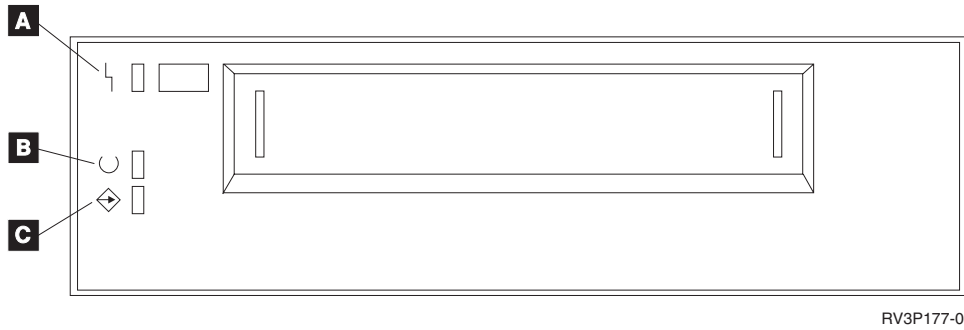









































The 8mm tape units that support the 5.0GB, 7.0GB or 20GB format have three indicator lights: two green and one amber. These status lights are turned on and off in various combinations to indicate the status of the tape units.



The symbols located next to the status lights are the International Organization for Standardization (ISO) symbols that define the general function of the status lights as follows:

(A)	Disturbance. The amber status light flashes whenever the tape unit encounters an irrecoverable fault. It is on solid whenever the tape drive requires cleaning.
(B)	Ready. The green status light is on solid whenever the tape unit is ready to receive the tape backup commands.
(C)	Read-Write. The green status light flashes whenever the tape unit is moving the tape.

The various on/off combinations of the status lights are shown in the following chart.

Status Lights	State	Status
     	On On On	The Power-on Self Test (POST) is running or the system has issued a reset to the drive. Note: The POST condition can occur either when the power is first applied or after use of the diagnostic cartridge.
     	Off Off Off	One of the following has occurred: 1. The power is off. 2. The POST has completed successfully but no tape cartridge was inserted.
     	Off Off Flashing	A tape cartridge has been inserted and the tape drive is performing a tape load/unload operation.
     	Off On Off	The tape load operation has completed and the tape drive is ready to receive commands from the system.
     	Off On Flashing	The tape is in motion and the tape drive is busy running a device operation.
     	Flashing Off Off	The flash rate is fast (4 flashes per second) when using the test cartridge. The flash rate is slow (1 flash per second) when the tape drive has detected an internal fault that requires corrective action. Refer to your Service Guide or contact your service representative.
    or    or 	On Off or On Off or Flashing	The tape path requires cleaning.

RV3P176-1

Using 1/2-Inch and Magstar MP Tape Units

The iSeries supports the following 1/2-inch tape units:

- 3480
- 3490
- 3490E
- 3494
- 3590

The iSeries supports the following Magstar MP tape units:

- 3570

Tape Unit with Automatic Cartridge Loader

There are two ways that tape cartridges can be loaded with the automatic cartridge loader:

Manual Mode : You insert tape cartridges one at a time by pressing the Start key.

Auto Mode : You can preload multiple tape cartridges. The tape cartridges will automatically load when the previous cartridge is unloaded.

Note: For the 3570, 3490Fxx, 3590, and 3494, the tape device supports a random mode of operation. In random mode, the tape device operates as a tape library. Tape libraries require special considerations. For more information, see the following book: Manage tape libraries.

Sharing Systems with a 3480, 3490, 3490E, or 3590 Tape Unit

The 3480, 3490, 3490E, or 3590 tape units can be attached to:

- One or two input/output processors on the same iSeries server.
- Two iSeries servers.
- An iSeries server and a System/390*.

You can choose whether or not you want your 3480, 3490, 3490E, or 3590 tape unit assigned to an iSeries server when the tape unit is varied on (made available for intended use). Assigning a tape unit reserves the tape unit specifically for one system.

To assign a 3480, 3490, 3490E, 3570, or 3590 Tape Unit:

1. Use the Work with Device Description (WRKDEVD *TAP) command to work with a tape device description. In the *Assign device at vary on* field and press **Enter** to assign the tape unit to the system.
Note: *YES is the default for Version 2 Release 3. For Version 2 Releases 1 and 2, the assign device at vary on parameter was not optional. For releases prior to Version 2 Release 1, the assign function did not exist.
2. Use the Vary Configuration (VRYCFG) command to vary off the tape unit.
Note: The Vary Configuration (VRYCFG) command can be run by using the VRYCFG command or by using the Work with Configuration Status (WRKCFGSTS) command. To use the Work with Configuration Status command, type WRKCFGSTS *DEV *TAP and press **Enter** .
3. Use the VRYCFG command to vary on the tape unit and assign it to the system.

If the tape unit is being used by the other system, a message is displayed that indicates the tape unit is assigned elsewhere. The tape unit must be varied off (made unavailable) at the other system before it can be varied on (made available) at a new system.

To leave a tape unit unassigned:

1. Use the Work with Device Description (WRKDEVD *TAP) command to work with a tape device description. In the *Assign device at vary on* field and press **Enter** to leave the tape unit unassigned.
Remember: A tape unit that is unassigned may be varied on to both systems. The operator must control the tape application programs so that the two systems do not interfere with each other. The results of failing to control the tape application programs may be unpredictable.
2. Use the Vary Configuration (VRYCFG) command to vary off the tape unit.
3. Use the VRYCFG command to vary on the tape unit.

Remember:

- When a tape unit is being shared by two iSeries servers, the tape unit can only be in VARY ON status on one system at a time. To use a drive, vary it on by typing the following on any command line and pressing **Enter** :

```
VRYCFG CFGOBJ(TAPxx) CFGTYPE(*DEV) STATUS(*ON)
```

- If you do not want to vary on tape units during future IPLs, type the following on any command line and press **Enter** :

```
CHGCTLAP CTLD(TAPCTLxx) ONLINE(*NO)
```

After doing an IPL, to vary on only the controller, type the following on any command line and press **Enter** :

```
VRYCFG CFGOBJ(TAPCTLxx) CFGTYPE(*CTL) STATUS(*ON) RANGE(*OBJ)
```

1/2-Inch and Magstar MP Tape Unit Addressing

For a 34xx or 35xx tape device attached to a type 6501 or 6534 IOP or a type 2729 IOA, the SCSI address must be set to 0 when the device is used for IPL. The SCSI address can be set to any address except 7 when the device is not being used for initial program load.

For a 34xx tape device attached to a type 2644 IOP, the controller address must be set to address 7. The device address must be set to address 0 when the device is used for IPL. Address 8 can be used when there is no device at address 0. The controller and device can be set to any value when the device is not being used for IPL.

Backing Up and Restoring Data with the 1/2-Inch and Magstar MP Tape Unit

The 3480, 3490, 3490E, 3570, or 3590 attached tape unit is most often used to back up and restore data. You can use multiple tape units to back up and restore data plus the automatic cartridge load function to do an unattended backup. When using multiple tape units, the sequence of tape media used is across the tape units: the first tape is on tape unit 1, and the second on tape unit 2.

For example, if you use the 3490 tape unit (model D32) with the automatic cartridge load function to back up the data, 12 cartridges can be loaded using the automatic cartridge load function. When the job is complete, tapes 1, 3, 5, 7, 9, and 11 are in tape unit 1. Tapes 2, 4, 6, 8, 10, and 12 will be in tape unit 2. To restore the data, the odd-numbered tapes must be loaded into tape unit 1 and the even-numbered tapes in tape unit 2.

Before backing up data, all tapes should be initialized on the model and type of tape unit that will be used to do the backup. Tapes that are initialized on other tape units may not be recognized by the system. Tapes that are initialized on a 3490 D3x tape unit cannot be used on 3490E D4x or Cxx tape units.

Cleaning the 3480, 3490, 3490E, and 3590 Tape Unit

On the average, clean the tape path on each drive every seven days. If you use an unusually large amount of tape, clean the tape path more often. If the drive displays a *CLEAN message, clean the tape unit path as soon as possible. You should also clean the tape path after each initial program load (IPL), after a drive is reset, or whenever the power on the tape drive has been interrupted.

To clean the tape path, insert the special cleaning cartridge as you would a normal tape cartridge. The part number for the 3490 cleaning cartridge is 4780527. The part number for the 3590 cleaning cartridge is 05H4435. Keep track of the number of uses on the label provided with each cleaning cartridge and then throw the cartridge away after 500 uses.

Tip :

1. Do not use a grease pencil on the label.
2. The cleaning cartridge should be undamaged and clean when it is inserted into a tape unit.

If your tape unit has the automatic cartridge loader feature, put the cartridge into the feed position and press the start pushbutton. The cleaning cartridge can also be put into the input stack, and the cleaning procedure takes place whenever the cleaning cartridge is loaded into the drive. If you start cleaning during a job, an inquiry message is displayed. After responding to the message, the drive threads the cleaning tape, cleans the read/write head, and then rewinds and unloads the cleaning cartridge. When the cartridge has been unloaded, remove it and mark the usage label.

Cleaning the 3490 Fxx, 3494, and 3570 Tape Units

These tape units provide random access to the tape cartridges. When the device detects that cleaning is needed, the tape unit will perform the cleaning operation automatically, if the cleaning cartridge is in the internal cell (known only to the Random Access Cartridge Loader). The tape unit keeps track of the number of cleaning operations performed by the cleaning cartridge and ejects the cleaning cartridge through the priority cell when the cleaning cycles allowed for the cleaning cartridge have been used up. The part number for the 3590 Tape Cleaning Cartridge is 05H4435. The part number for the 3570 Tape Cleaning Cartridge is 05H2463.

Using 1/2-Inch and Magstar MP Tape Cartridges Before You Start:

Inspect the cartridge and do not use it if:

- The cartridge case is cracked or broken.
- The leader block or the latch is broken.
- The file-protect selector is damaged.
- The cartridge case contains any liquid.
- The cartridge case has any other obvious damage.
- The tape is wound completely out of the cartridge onto the machine reel and then reattached to the cartridge reel by the service representative. This repair is temporary and permits the cartridge to be loaded one time so that the data can be copied on a replacement cartridge.

Note: If you have a damaged cartridge, substitute a backup version of the data from another cartridge. If the cartridge has a detached leader block but no other damage, you can repair the cartridge with the *IBM Leader Block Repair Kit*.

If dirt appears on the external surface of a cartridge, lightly moisten a lint-free cloth (IBM part 2108930) with IBM cleaning fluid (IBM part 8493001), or its equivalent, and wipe the outside surfaces.

Important: Do not allow anything wet, including the cleaning fluid, to contact the tape.

Make sure all cartridge surfaces are dry and the leader block is snapped into place before you load the tape cartridge.

Protecting Data Stored on 1/2-Inch Tape Cartridge

To protect the data, roll the thumbwheel selector on the side of the cartridge left or right until it is in the correct position.

The 3570 and 3590 data cartridges are preformatted with data servo tracks. These cartridges should not be bulk erased. The 3570 and 3590 tape devices have control data at the beginning of each cartridge. The device updates (writes) this region every time a cartridge is loaded. As a result, the device display will state **writing** even if you have file protected the cartridge. This data is separate from the user data.

Note: For more detailed information about using 1/2-inch tape cartridges, see *Care and Handling of the IBM Magnetic Tape CartridgeGA32-0047*

Protecting Data Stored on Magstar MP Tape Cartridge

To protect the data, slide the file protect selector on the end of the cartridge until it is in the correct position.

Note: For more detailed information about using Magstar MP tape cartridges, see the *IBM 3570 Magnetic Tape Subsystem Operator's Guide*

Using 1/2-Inch tape reels: Use the following tape and reel recommendations for maximum performance and reliability:

Tapes: 1.5 mil thick
A maximum of 733.7 meters (2400 feet)

Reels: 15.24 cm (6.0 inches)
17.78 cm (7.0 inches)
21.58 cm (8.5 inches)
26.67 cm (10.5 inches)

Using tapes that are longer than 2400 feet is not recommended. Using these tapes will cause the tape unit head to wear incorrectly. You could have an increase in read and write errors.

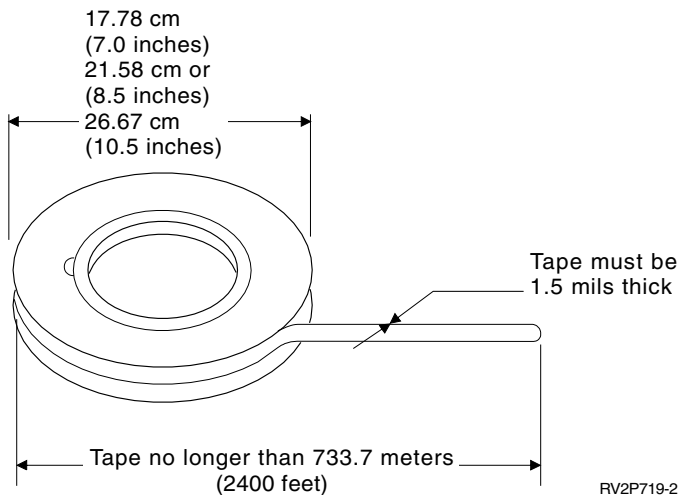

Follow these tips to ensure that your tape reels are used correctly:

Important:

- Secure the end of the tape with a tape end fastener when not in use.
- Keep the reel protected with a locking collar when not in use.
- Store tapes in a vertical position.

Do Not:

- Squeeze the outer flanges of the reels when handling and loading tape. Hold the tape evenly around the outer edge by the palm of your hand.
- Allow tape ends to drag on the floor and get dirty.
- Touch the tape surface.

Preparing a Tape Leader: A tape leader that is square or damaged can cause the tape to load incorrectly in units that automatically load tapes. When using this type of tape unit, ensure that the tape loads correctly by:

- Preparing the tape leader with the tape leader tool (IBM part 2512063).
- Pressing hard when cutting the tape. This prevents static problems on the tape leader.

The figure below shows how to correctly prepare a tape leader.

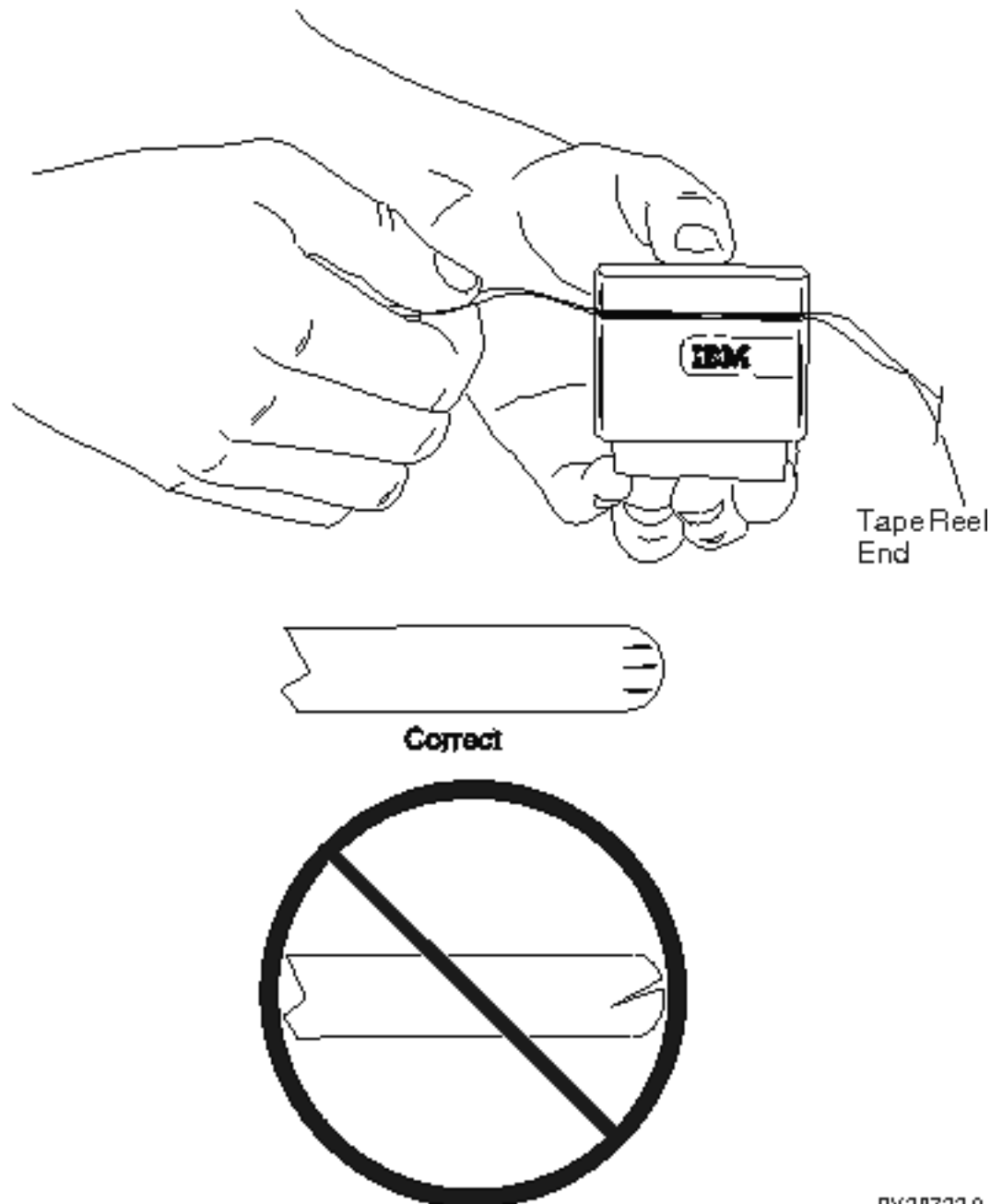

RV2P722-0

Loading the 1/2-Inch Tape Reel: When loading 6-inch and 10-inch reels of tape on the 9348, carefully place the tape reel on the center of the hub.

When loading a tape reel, ensure that the loose end of the tape is on the tape reel and not under the reel.

Protecting Data Stored on the 1/2-Inch Tape Reel: To prevent the drive from writing data, remove the write enable ring (shown below). To allow the drive to write on the tape, install the write enable ring.

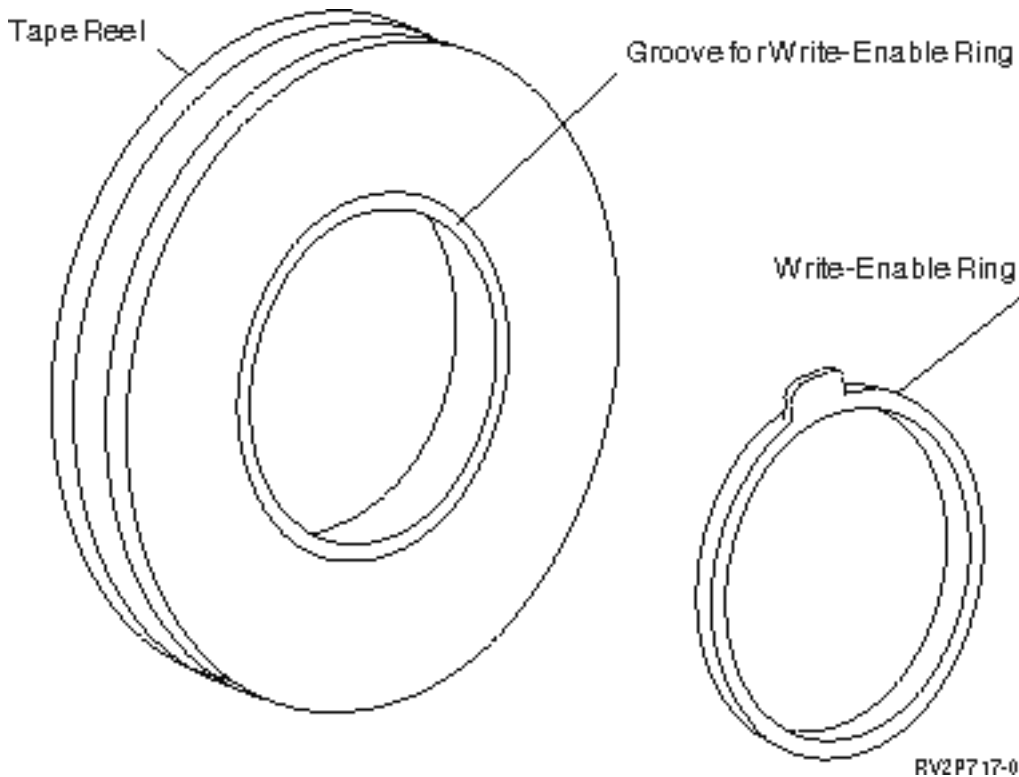

Cleaning the 1/2-Inch Tape Reel Unit: Use the table below as a guide to establish how often to clean your tape reel unit.

Cleaning the 1/2-Inch Tape Reel Unit

When:	Clean the tape path:
Less than ten reels are used in eight hours.	Every eight hours.
More than 10 reels are used in eight hours.	Every one to two hours of running.
Particles appear on the tape path or you are using new or seldom used tapes.	After each reel.

Use the following cleaning supplies:

- Tape cleaning kit, IBM part 352465 or equivalent
- Cleaning fluid, IBM part 8493001, 13F5647, or equivalent
- Lint-free cloth, IBM part 2108930
- Rigid cleaning tool, IBM part 2200574 or equivalent

To clean the tape reel unit:

1. Set the power switch to the Off position.
2. Clean the following areas using a lint-free cloth or swab and cleaning fluid:
 - Read/write head
 - Tape cleaner block

- Tape guides
- General tape path

Pay particular attention to the read/write head and tape cleaner block. Push hard against the read/write head. Dry the areas with a lint-free cloth until the cloth comes away clean.

If the tape unit is cleaned thoroughly and a particular tape is causing errors, discard the tape.

General Tape Usage Information:
Tape Volume, Initialization, and Volume ID

A **volume** is a tape reel, a tape cartridge, or a diskette. Each volume must be initialized before data files can be recorded on the tape (or diskette) magnetic medium. A tape **volume ID** is a name or number identification that is recorded in a standard volume label at the beginning of the tape when a tape is initialized.

Initializing Tape

Use the Initialize Tape (INZTAP) command to initialize a tape. When you run this command, a standard volume label is recorded at the beginning of the magnetic tape medium.

- When a tape is initialized, any information previously recorded on the tape medium is erased and written over with new information. Information is also written over when new data files are appended to the newly recorded volume label.

Note: Do not reuse an old tape volume if permanent read or write errors have been detected more than two times. Also do not reuse an old tape volume if temporary read or write errors for that volume are excessive. To determine if temporary errors are excessive, see Monitoring Tape Volume Statistics .

Commonly Used Parameters of the INZTAP Command

The most commonly used INZTAP parameters are:

- New volume identifier (Volume ID)
- Check for active files
- Tape density

New Volume Identifier (Volume ID)

Use the new volume identifier parameter to provide a unique volume identification (ID) for a tape being initialized for use as a standard labeled tape. This parameter is required for tape cartridges. This option is not required by 1/2-inch tape reels.

- On the Initialize Tape display, type the volume identifier of your choice in the new volume identifier parameter. The identifier can be no longer than six characters in length and should not start with a *.

Check for Active Files

An active file has an expiration date that is equal to or later than the current date.

Select one of three options to complete the parameter:

- Type ***YES** in the check for active files parameter if you want all data files on the tape to be checked before the tape is initialized. If an active file is found, the tape volume is not initialized and you receive an error message.

Important: Check for active files=*YES is the default option. The processing of tapes that have a large file, or tapes that have many files, may take a long time. The processing of 8-millimeter tapes may take up to 3.5 hours.

- Type ***NO** in the check for active files parameter if you want the tape to be initialized immediately without checking for active files. Use ***NO** when:
 - The tape or data cartridge is new.
 - You are sure you want the volume initialized and you want the INZTAP processing to complete in the minimum amount of time.
 - You are sure you want the volume initialized and the INZTAP command failed when you entered ***YES** or ***FIRST** in the parameter field.

IMPORTANT: If you type ***NO** in the Check for active files parameter, the system writes over all data that is on your tape. Make sure the tape cartridge you are using is new. If the tape you are using is not new, be certain that you want the tape volume initialized regardless of the data that is on the tape.
- Type ***FIRST** in the check for active files parameter if you want to check only the first file on the tape. If this file is active, the tape volume is not initialized. The processing time for this parameter option depends on the size of the first file on the tape.

Tape Density

The tape density parameter determines the amount of data recorded per inch of tape. The choice of density also changes the format of 1/4-inch and 8-mm tape cartridges.

If you are initializing two or more reels or cartridges for a multi-volume SAVE operation, the density and format of all volumes must be the same.

Clear

The clear parameter is used to erase all of the data on the tape medium that follows the standard volume label record at the beginning of the tape. The Magstar MP, 1/2-inch, and all 1/4-inch tape drives except the QIC-5010 tape drive have an erase head that erases all data tracks in one pass. The QIC-5010 1/4-inch tape drive and the 8-mm tape drive erases at the normal write speed. This can take a very long time.

Note: Using the clear parameter to erase QIC-5010 1/4-inch tapes and 8-mm tapes is not recommended because the process time for erasing 8-mm tapes can be up to 3.5 hours.

Copying Tapes

To copy a tape:

1. You must have two tape drives.
2. Make sure the tape units are turned on.
3. Load the tape to be copied into one tape unit.
4. Load the tape receiving the information in the other tape unit.

Note: If the tape that receives the information is new, you must initialize it before continuing. See Tape Volume, Initialization, and Volume ID for information on how to initialize a tape.
5. Enter the Duplicate Tape (DUPTAP) command and press **F4** (Prompt).
6. Specify the name of the tape unit from which the information is to be copied in the From device (FROMDEV) parameter.
7. Specify the name of the tape unit to which the information is to be copied in the To device (TODEV) parameter.
8. Press **Enter** . A message is displayed when it is time to insert a new tape.

Monitoring Tape Volume Statistics

To ensure that your tapes are in good condition, you should monitor the tape volume statistics on your iSeries server.

1. Use the Start System Service Tools (STRSST) command.
2. Select option 1 (Start a service tool) on the System Service Tools menu.
3. Select option 1 (Product Activity Log) on the Start a Service Tool menu.
4. Select option 4 (Work with removable media lifetime statistics) on the Product Activity Log menu.
5. Select the type of removable media for which you want data on the Select Media Option display. The Work with Lifetime Statistics display appears.

```

+-----+
|                                     |
|                               Work with Lifetime Statistics |
|                                     |
| Removable media . . . . . : 1/4 inch cartridge tape |
|                                     |
| Type options, press Enter. |
| 4=Delete entry  6=Print entry |
|                                     |
| Option  Volume  --Temporary Errors---  -----K Bytes----- |
|           ID      Read      Write      Read      Written |
| PHB021    23452450    23450    23457123    97689690 |
| THB021           2           0     14307           0 |
| AIPLT           0           3    214494    137546 |
| AD0000           0           0           3           0 |
| AIPL           0           0           2    27620 |
| IVIHE           0           0           1           0 |
| MM           0           0          361           0 |
| PHB031           0           0           2           0 |
| PTFFIX           0           0           3          432 |
|                                     |
| F3=Exit          F5=Refresh          F10=Delete all |
| F11=Print all    F12=Cancel |
|                                     |
| (C) COPYRIGHT IBM CORP. |
|                                     |
+-----+

```

6. If you see the following symbols preceding the volume ID on the Work with Lifetime Statistics display, take the appropriate action:

Symbol	Explanation	Action to take
>>	Media replacement recommended	Copy the contents of the media to a new tape and discard the old tape.
>	Media approaching replacement criteria	<ul style="list-style-type: none"> • Replace the tape if the tape format is: <ul style="list-style-type: none"> – QIC-120 – 7208 2.3GB – 6250 bpi density • If the tape format does not fulfill the above conditions, continue to monitor this tape to ensure that media replacement is not necessary.

Note: To ensure accurate statistics, each tape cartridge or reel must have a unique volume ID.

When to Clean

After 400 MB of data transfers have occurred for the volume ID, the Error Log Utility uses the following guidelines to determine whether a particular tape should no longer be used.

- Discard tape reels and tape cartridges that have a permanent read or write error.
- If all tapes used in a single drive exceed the criteria that follows this list, the read/write head are probably dirty and should be cleaned.
- If a specific tape exceeds the criteria that follows this list, copy the contents to a new tape and discard the old tape.

Storage Device Ready Conditions: Use the table below if you are having trouble making a device ready. All the conditions listed for each device must be correct for the device to be ready.

If you are not able to make a device ready, contact your service representative.

Storage Device Ready Conditions

Tape Unit	Ready Description	Reference Information
2440	<ul style="list-style-type: none"> • Power light is on • Tape is loaded • Status display shows A 0 • Online light is on 	<i>IBM 2440 Magnetic Tape Subsystem Operator's Manual</i> G571-0149.
1/4-inch	<ul style="list-style-type: none"> • Tape cartridge is inserted. <ul style="list-style-type: none"> – The tape cartridge must be changed or, to reuse the same cartridge, the tape cartridge must be reloaded under the following conditions: <ul style="list-style-type: none"> - The tape unit was made unavailable (varied off). - The tape application program ended with the *UNLOAD option. 	
7208/6390 8mm	<ul style="list-style-type: none"> • Power light is on • Tape cartridge is inserted • Ready light is on 	See the appropriate operator's guide for your specific model.
9348	<ul style="list-style-type: none"> • Power light is on • Tape is loaded • Status display shows 00 A002 • Online light is on 	<i>9348 Customer Information</i> , SA21-9567.
3422/3430	<ul style="list-style-type: none"> • Power light is on • Enable/Disable switch is set to the Enable position • Tape is loaded • Ready light is on 	<i>IBM 3422 Magnetic Tape Subsystem Operator's Guide</i> , GA32-0090.

Tape Unit	Ready Description	Reference Information
3480/3490/3490E	<ul style="list-style-type: none"> • Power light is on • DC Power light is on • Control unit Online switch is set to the Online position • Control unit Normal/Test switch is set to the Normal position • Control unit channel Enable/Disable switch is set to the Enable position • Tape unit Online/Offline switch is set to the Online position • Tape is loaded • Tape unit displays Ready U or Ready F 	See the appropriate operator's guide for your specific model.
3570/3590	<ul style="list-style-type: none"> • Tape is loaded • Tape unit displays Ready 	

Tape Drive Environment and Use: IBM's goal is to provide you with a product that you can configure and use reliably. Tape drives require specific maintenance and environmental conditions to operate well over time. Using high quality, data grade media, handling and storing this media properly, operating the tape drive in a clean environment and keeping the tape drive properly cleaned can help you to avoid problems with your IBM tape drive.

Media Grades

IBM uses two different grades of media. We supply program temporary fixes (PTF) on a tape that is designed to be written to only once and read from a few times. This tape is designed for limited use, not as a backup medium. IBM also sells media that are designed for storage use.

IBM supports the tape that we sell. If analysis by IBM service personnel indicates a problem with non-IBM media, it may be necessary for the customer to replace the media.

Tape Handling and Storage

Most tape arrives in a sealed cartridge so that the tape will remain in a clean environment. Opening the cartridge allows dirt and airborne particles to enter and then become a source of contamination. Only the tape drive should open the cartridge; not an operator. Inside the cartridge, the tape is under proper tension. If the cartridge is dropped, this tension will be relaxed. Inserting a dropped cartridge into a tape drive can cause incorrect loading and result in a jam. This will ruin the tape and can cause physical damage if the cartridge is not removed properly.

To store the tapes properly, put them in their protective containers and store them on their ends. The storage area must be clean, dry, normal room temperature and away from any magnetic fields.

Environmental Issues

Tape drives are designed to operate in a clean environment. Problem factors are dirt, dust, fibers, and airborne particles. Airborne particles are the most difficult to address. When you install a tape in the tape drive, the clearance between the heads and the tape is measured in microns. Particles can damage the tape or the head if they come in contact with either. IBM offers a tape drive filter enclosure for some

systems to solve this problem. The enclosure draws air in through a filter and supplies the tape drive with clean air. Customers are responsible to provide a clean operating environment for the tape drive and system.

Tape Drive Cleaning

Dirt may build up on the heads of any tape drive, no matter how clean the environment. Every time tape motion occurs, some of the media surface comes off on the heads. Over time, this builds up and causes errors in reading and writing.

We only recommend that you use IBM cleaning cartridges for IBM tape drives, and that you follow the following recommendations:

QIC Drive Type	Wet cleaning cartridge	Dry cleaning cartridge
120 MB	Best choice	Not recommended
525 MB		
1.2 GB	OK	Best Choice
2.5 GB		
2.5/5.0 GB		
4/8 GB		
Newer drives (13/26, 16/32, 25/50, and 50/100 GB)	Do not use	

You can use cleaning cartridges a limited number of times. Once a cleaning cartridge has been used to its maximum number of times, the usefulness of the cartridge expires. When cartridges expire, replace them. Never reuse an expired cleaning cartridge. Doing so allows previously removed dirt to be reintroduced to the tape drive. When you have cleaned the tape drive, mark the usage on the cartridge in order to best determine when your IBM cleaning cartridge has expired.

Microcode Updates

IBM constantly works to provide the best possible tape drive products. To make certain that the drives work their very best, IBM occasionally releases changed microcode for the tape drives. When a microcode change is developed, IBM makes it available to you through the service organization or by electronic delivery.

Microcode changes are also available by downloading and installing fixes using Electronic Customer Support , or by ordering and installing cumulative fix packages from IBM Global Services.

Summary

Install your tape drive in the cleanest possible environment. IBM tape drives require high quality, data grade tapes, and cleaning on a regular basis. Store and handle media properly. Improper use, storage, or handling of tape drives or media may void your IBM warranty, or service agreement.

If a tape drive stops functioning due to a component failure during the tape drive warranty or maintenance time, IBM will replace the tape drive unit. IBM will replace any defective tape drive under the terms and

conditions of the IBM warranty or service agreement. It is our objective to work with you to identify the cause of any tape drive problems and provide a solution.

Using CD-ROM Storage: The CD-ROM drive is a read-only drive. The feature code for the iSeries CD-ROM drive is 6320 or 6321. The figure below shows the CD-ROM drives on the 9402/9404 Models 4xx and 9404/9406 Models 5xx.

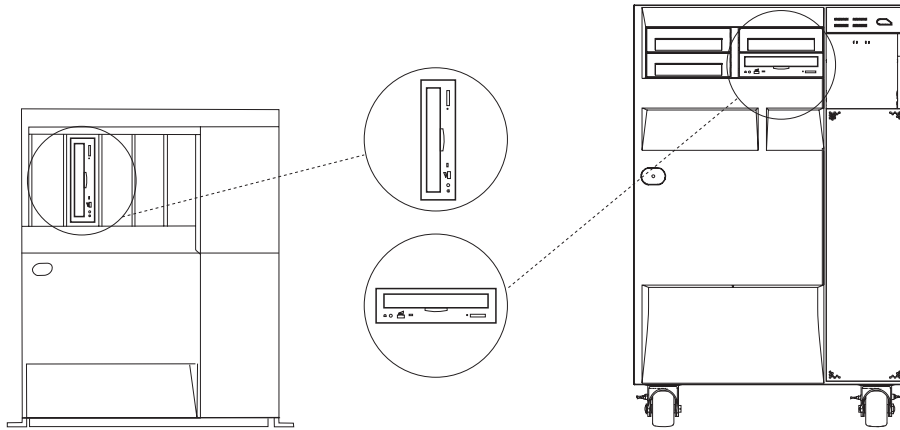

RV3P171-2

Note: The CD-ROM drive on the iSeries server is not enabled for the digital audio disc.

Loading and unloading a CD

1. Remove the CD from the protective case.

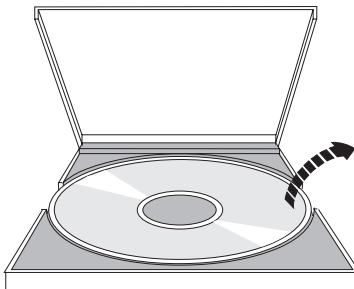

RV3P172-0

2. Slide the CD into the CD tray with the label side showing. If your CD-ROM is vertically positioned, make sure that the CD is secured by the two tabs at the bottom of the CD tray as shown on the left in the following illustration.

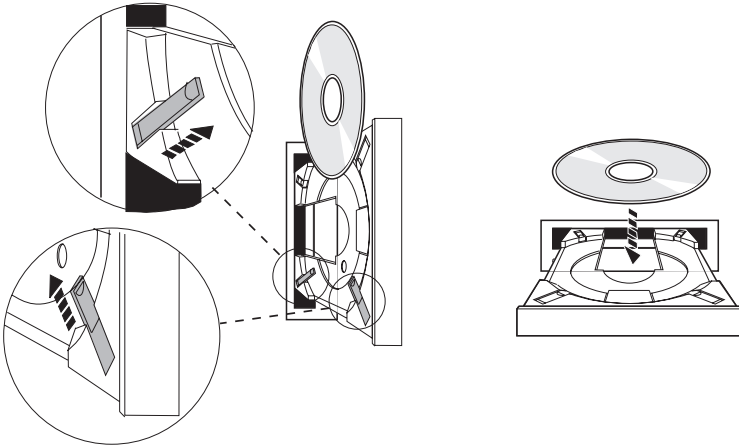

RV3P173-2

3. When you have properly positioned the CD in the CD tray, press the Eject button or push the tray into the CD-ROM drive.

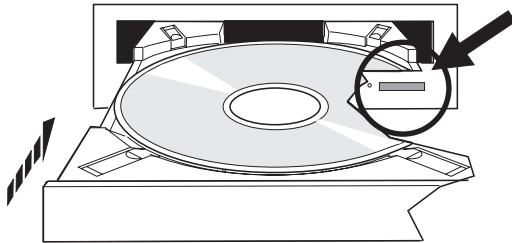

RV3P174-0

4. To remove the CD from the CD-ROM drive, press the Eject button.

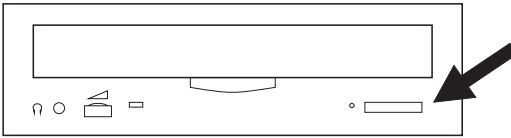

RV3P175-0

Cleaning

No preventive maintenance is necessary for the CD-ROM drive. Always handle discs by the edges to avoid finger prints. Discs can be wiped with a soft lint-free cloth or lens tissue. Always wipe in a straight line from the inner hub to the outer rim.

Verify Optical Device

The Verify Optical(VFYOPT) command can be used to detect hardware errors, or verify whether a problem has been resolved. This function can be used to verify a CD-ROM drive or a directly attached optical media library device.

To use this function, do the following:

1. On any command line, type
`VFYOPT DEV(xxxxxxxxxx)`

where xxxxxxxxxxxx is the device name.

- A display is shown with instructions on how to perform verification test.
2. Follow the instructions, and press the Enter key. The verification test is run.
If the test completes successfully, you will receive a message about the successful completion. If hardware errors occur during the test, you will receive an error message.

Using Optical Media Libraries

The IBM 3995 Optical Library Dataserver is a storage device for the iSeries server that provides removable and permanent storage of information on optical media. The 3995 Optical Library lets you access data right at your work station. It is an alternative to retrieving data that is traditionally kept on paper, stored on diskette, stored on microfilm, or stored on magnetic tape.

If you are using the 3995 Optical Media Library and would like more information, see the following manuals:

- IBM 3995 AS/400 Optical Library Dataserver: Operator's Guide Models 142 and 042, GA32-0140
- Optical Support 

Start and stop the iSeries

Starting and stopping the iSeries requires careful planning in order to prevent data loss and to protect system integrity. Also, the iSeries provides several methods for starting the system to allow for various amounts of interaction with the user. Refer to the following procedures for help starting up the system or safely shutting it down.

Start the system

Use this topic to select a method for starting your system and handling problems with the initial program load (IPL).

Sign on to the system

Use this topic to access functions on the iSeries after startup.

Stop the system

Use this topic to safely shut down the system and plan for controlled system restarts.

Use the control panel

Use this topic learn to how to use the iSeries control panel, including set up and configuration tasks, and how to use the virtual and remote control panel.

Several system values determine the available options for starting and stopping the iSeries. For more information, refer to system values that control IPL.

Start up the system

Some changes to the system settings or hardware configuration require the iSeries server to go through a startup sequence called an initial program load (IPL). During an IPL, system programs load from the system auxiliary storage and the system hardware is checked. The iSeries server control panel will display a series of codes that indicate its current status, and warn you of any problems. When the IPL is finished, the character-based interface presents the sign-on display, and users will be able to sign on with iSeries Navigator.

There are several options for starting an iSeries server. Refer to the following topics for procedures and recommendations for performing an IPL.

Start the system without making configuration changes (unattended IPL)

This is the most common way to start the iSeries server. Refer to this topic for instruction on how to start your system during normal operation.

Change your system configuration during IPL (Attended IPL)

Some situations may require you to enter information or change system values during an IPL. Refer to this topic for instructions for performing a manual IPL.

Change the type of IPL from your system control panel

You can specify the type of IPL you would like to perform from the system control panel. Refer to this topic for instructions.

Change the IPL startup program

You can create a startup program that will change the system resources, and the resources and attributes assigned to them, that are started during an IPL. Typically, subsystems, writers and the Operational Assistant are launched by this program.

Schedule a system shutdown and restart

You can set up a schedule that automatically powers your system on and off. You can determine the time of day you want the system powered on and off. You can also specify special circumstances that change the normal daily schedule, such as a holiday or special closing.

During the IPL, the control panel displays a series of codes indicating the current system activity. For more information see:

- System reference codes and primary partitions
- System reference codes and secondary partitions

If you encounter problems during an IPL, refer to Causes of abnormal IPLs for help with troubleshooting.

Start the system without making changes (unattended IPL)

Unattended IPLs reset system storage and recognize any configuration changes automatically. The amount of time required for any IPL depends on the size and complexity of the system, ranging from a few minutes to several hours. When the unattended IPL is complete, the Sign On display appears on the display station.

Note: If you are working on a system that has logical partitions, refer to the documentation on Starting and stopping logically partitioned systems.

Before you start

This procedure assumes the iSeries is running, and requires that several additional conditions be met before you begin an IPL. While most of these settings are the default values, you should verify them if you are unsure.

- The IPL mode for the iSeries server must be set to **Normal** (unattended IPL).
- The QIPLTYPE system value must be set to 0 (unattended IPL). See System values that control IPL for information on how to set this system value.
- Turn on any devices, such as display stations, printers, and tape devices, and controllers you or others may want to use.

To do an unattended IPL

1. Type **ENDSYS** or **ENDSBS *ALL** on any command line and press **Enter**.
2. Type **PWRDWSYS *IMMED RESTART(*YES)** on any command line and press **Enter**.

When the unattended IPL is done, the sign on display appears on the display station.

Change the system during IPL (attended IPL): If you want to change initial program load (IPL) options, install the operating system, use dedicated service tools, work with logical partitions, or recover from a system failure, you need to perform an attended IPL. This IPL mode requires that you respond to several prompts during the startup sequence.

Before you start

This procedure assumes the iSeries is running, and requires that several additional conditions be met before you begin an IPL. Most of these settings are the default values, but you should verify them if you are unsure of the current setting.

- The IPL mode for the iSeries server must be set to **Manual** (attended IPL).
- The QIPLTYPE system value must be set to 1 (attended IPL). See system values that control IPL for information on how to set this system value.
- Turn on any devices, such as display stations, printers, tape devices, and controllers that you or others may want to use.

To do an attended IPL

1. Type **ENDSYS** or **ENDSBS *ALL** on any command line and press **Enter**.
2. Type **PWRDWSYS *IMMED RESTART(*YES)** on any command line and press **Enter**.

After you begin the attended IPL, the system displays the IPL options display, and allow you to choose which options to work with during the IPL. During the IPL, the system displays any options that you selected, or that are required due to system changes. For more information, refer to Attended IPL displays.

Attended IPL displays: During an attended IPL, your display station or console displays any required or selected displays.

The following displays will appear during the IPL if you select them on the IPL options display

Set major system options

Set major system options allows you to configure and name new devices and to specify options for the operating environment.

Define or change the system

Define or change the system allows you to change system values and other system attributes during the IPL.

The following displays appear if system changes require them

Edit access paths

Applications use access paths to determine the order of records in a database file. If the access paths have changed, use this display to reconstruct them.

Edit check pending constraints

Some physical files may have restrictions placed on them that need to be verified during an IPL. This display allows you to verify the status of these physical files.

Set major system options: The Set Major System Options display allows you to select automatic configuration, the type of device configuration naming, and the special environment in which you want to run.

1. Using the following information, type the new values over the existing values in the following fields:
 - Enable automatic configuration

- **Y** (Yes) automatically configures local devices.
- **N** (No) indicates no automatic configuration.
- Device configuration naming
 - ***NORMAL** uses a naming convention unique to the iSeries, for example, DSP01 and PRT01 for displays and printers, TAP01 and DKT01 for tape and diskette devices.
 - ***S36** uses a naming convention similar to System/36(TM), for example, W1 for workstations, P1 for printers, and T1 and I1 for tape and diskette devices.
 - ***DEVADR** uses a naming convention which is obtained from the device resource name, for example, DSP010203 for a display station, PRT010203 for a printer, TAP01 and DKT01 for tape and diskette devices.
- Default special environment
 - ***NONE** indicates there is no special environment.
 - ***S36** sets up the System/36 environment.

2. Press **Enter** .

Define or change the system at IPL: On the Define or Change the System at IPL display, you can change the system configuration, system values, network attributes, user profiles, and object or file attributes. This display is shown when you type Y (Yes) in the Define or change the system at IPL field on the IPL Options display.

1. select any of the following options:
 - To change the way the system starts, select option 3 (System value commands. Refer to Changing System Values During IPL for more information).
 - To change any of the other options, select them before exiting and continuing the IPL.
2. When you are finished using the options on this display, press **F3** (Exit and continue IPL) to continue the IPL.

Edit access paths during attended IPL: Access paths define the order that records in a database file are organized for processing by a program. If there are access paths to rebuild, the Edit Rebuild of Access Paths display is shown after the IPL Options display.

Tip: Use the online help information on this display to get more information about each column and field.

A message notifies you that a journal should perform an access path recovery. A journal is a system object. It is used to record entries in a journal receiver when a change is made to the database files associated with the journal. Any access path that is recoverable because it was recorded is not shown on this display. The IPL threshold indicates that access paths with a sequence less than or equal to the number specified will be rebuilt at IPL time. It is a value from 1 through 99 that you can set (the default is 50). If the IPL threshold changes, all access paths with a status of IPL and AFTIPL changes to reflect the new status of the IPL threshold.

- To change the sequence of access paths that are rebuilt:
 - Make any changes to the Seq column.
 - Press **Enter** .
- If you do not want to change the sequence, press **Enter** and the Display Access Path Status display is shown if there are access paths left to be rebuilt.

Tip: Press **Enter** to continue with the IPL from the Edit Rebuild of Access Paths display.

If no access paths need to be rebuilt, the IPL continues.

If you press **F3** (Exit and continue IPL) the access paths are rebuilt while the IPL continues. If you press **F12** (Cancel), you return to the Edit Rebuild of Access Paths display.

Every 5 seconds, the display is updated with the current run time. After all the access paths have been rebuilt (access paths with a sequence less than or equal to the IPL threshold), the IPL continues.

Edit check pending constraints during attended IPL: During an attended IPL, the Edit Check Pending Constraints display is shown if there are constraints to be verified. A constraint is an attribute that places restriction or limitation on a physical file.

Tip: Use the online help information on this display to get more information about each column and field.

On the Edit Check Pending Constraints display, you can change the sequence (1 through 99) of the constraints to be verified. If the constraint has a sequence less than or equal to the IPL threshold, it is verified during the IPL. If a constraint has a sequence greater than the IPL threshold, it is verified after IPL. The sequence *HLD indicates that the constraint is not verified until it is changed to a number from 1 through 99. When the IPL threshold changes, all constraints with a status of IPL or AFTIPL are changed to reflect the new status of the IPL threshold.

- To change the sequence of check pending constraints:
 1. Make any changes to the Seq column
 2. Press **Enter**.
- If you do not want to change the sequence, press **Enter**. The Display Constraint Status display is shown if there are constraints left to be verified.

If you press **F3** (Exit and continue IPL) the constraints are verified while the IPL continues. Every five seconds, the display is updated with the current run time. After all constraints with IPL status have been verified, the IPL continues. If you press **F12** (Cancel), you return to the Edit Check Pending Constraints display.

Change your system IPL from the system control panel: The Increment/Decrement buttons are used to change the initial program load (IPL) type and mode on systems without a mode button. Use Function 02 to select the IPL type (A, B, or D) and Mode (Normal, Manual). To select IPL type and mode do the following:

1. Use the Increment/Decrement buttons to select Function 02, and press the Enter pushbutton.
2. Use the Increment/Decrement buttons to select the IPL type and mode you want, and then press the Enter pushbutton to save.
3. You can also specify a fast or slow IPL that can only be set one time at the console panel when the system is powered off. Select Function 02 and press **Enter** twice. Then, use the Increment/Decrement buttons to select F(Fast), S(Slow), or V(Value from IPL attributes).

The IPL attribute determines the type of subsequent IPLs. *MIN is the recommended setting, however, if you anticipate any hardware problems, specify *ALL on the Hardware diagnostics parameter. Use the Change IPL Attributes (CHGIPLA) command to change the IPL attribute.

Changing the IPL Start-Up Program: The autostart job in the controlling subsystem transfers control to the program that is specified in the system value QSTRUPPGM. You can tailor this program.

You can create your own program and change the QSTRUPPGM system value to that program name. Or, you can use the shipped program QSTRUP in QSYS as a base to create your own program. To do this:

1. Retrieve the source of the shipped program by using the RTVCLSRC command (for example, **RTVCLSRC PGM(QSYS/QSTRUP) SRCFILE(YOURLIB/YOURFILE)**).
2. Change the program.
3. Create the program by using the CRTCLPGM command, putting it into your own library.
4. Test the program to ensure that it works.
5. Change the system value QSTRUPPGM to the program name and library you specified on the CRTCLPGM command.

Source for CL Start-up Program

Object	Command	CL Program Source
QSTRUP	CRTCLPGM	<pre> PGM DCL VAR(&STRWTRS) TYPE(*CHAR) LEN(1) DCL VAR(&CTLSBSD) TYPE(*CHAR) LEN(20) DCL VAR(&CPYR) TYPE(*CHAR) LEN(90) VALUE('+ 5769-SS1 (C) COPYRIGHT IBM CORP 1980, 1999. + LICENSED MATERIAL - PROGRAM PROPERTY OF IBM') QSYS/STRSBS SBSDB(QSPL) MONMSG MSGID(CPF0000) QSYS/STRSBS SBSDB(QSERVER) MONMSG MSGID(CPF0000) QSYS/STRSBS SBSDB(QUSRWRK) MONMSG MSGID(CPF0000) QSYS/RLSJOBQ JOBQ(QGPL/QS36MRT) MONMSG MSGID(CPF0000) QSYS/RLSJOBQ JOBQ(QGPL/QS36EVOKE) MONMSG MSGID(CPF0000) QSYS/STRCLNUP MONMSG MSGID(CPF0000) QSYS/RTVSYSVAL SYSVAL(QCTLSBSD) RTNVAR(&CTLSBSD) IF ((&CTLSBSD *NE 'QCTL QSYS ') + *AND (&CTLSBSD *NE 'QCTL QGPL ')) GOTO DONE QSYS/STRSBS SBSDB(QINTER) MONMSG MSGID(CPF0000) QSYS/STRSBS SBSDB(QBATCH) MONMSG MSGID(CPF0000) QSYS/STRSBS SBSDB(QCMN) MONMSG MSGID(CPF0000) DONE QSYS/RTVSYSVAL SYSVAL(QSTRPRTWTR) RTNVAR(&STRWTRS) IF (&STRWTRS = '0') GOTO NOWTRS CALL PGM(QSYS/QWCSWTRS) MONMSG MSGID(CPF0000) NOWTRS RETURN CHGVAR VAR(&CPYR) VALUE(&CPYR) /* Needed to include CPYR variable in program. */ ENDPGM </pre>

QSTRUPPGM System Value

QSTRUPPGM is the start-up program. This value specifies the name of the program that is called from an autostart job when the controlling subsystem is started. This program performs setup functions, such as starting subsystems and printers. This system value can only be changed by the security officer or by someone with security officer authority. A change to this system value takes effect the next time an IPL is performed. QSTRUPPGM can have the values:

- 'QSTRUP QSYS': The program that is specified is run as a result of a transfer of control to it from the autostart job in the controlling subsystem.
- '*NONE': The autostart job ends normally without calling a program.

The default startup program QSYS/QSTRUP does the following:

- Starts the QSPL subsystem for spooled work
- Starts the QSERVER subsystem for file server work
- Starts the QUSRWRK subsystem for user work
- Releases the QS36MRT and QS36EVOKE job queues if they were held (these are used by the System/36 environment)
- Starts Operational Assistant cleanup, if allowed
- Starts all printer writers unless user specified not to on the IPL Options display
- If the controlling subsystem is QCTL, it starts the QINTER, QBATCH, and QCMN subsystems

Type	Length	Shipped Value CL
Character	20	'QSTRUP QSYS'

Schedule a system shutdown and restart: For some systems, you may want to regularly schedule routine shutdowns and startups. The iSeries supports this function by allowing you to define a schedule that alerts users to an upcoming shutdown, and then waits a predefined amount of time to allow users to finish their work and sign off. For example, you can define a schedule that would shut down your system Friday night, and start it again Monday morning. The schedule also allows you to define a message sent to any logged on users, and to specify how long to wait between sending the message and beginning the shutdown sequence.

To work with a schedule, type `go power` at any command line. The following topics provide procedures for working with shutdown and startup schedules:

Display the power OFF/ON schedule

Display the current settings for your power schedule.

Change power OFF/ON schedule defaults

Change the current settings for your power schedule.

Change the power OFF/ON schedule for a single event

Create a one time scheduled shutdown and startup, without adjusting the default schedule.

Solve problems with the power OFF/ON schedule

Address potential problems with the power OFF/ON schedule.

Display the power on and off schedule: The power on and off schedule ensures that the system is powered on and off at specific times during the day or night. To view this schedule:

1. On any command line, type `go power` and press **Enter**.
2. Select option 1 (Display power on and off schedule) on the Power On and Off Tasks menu.

The power on and off schedule shows the date, day, and time (using the 24-hour clock) that the system will be powered on and off. The Description column includes comments about those days that have been changed from the system's regular schedule. Any user can display this schedule.

Change power on and off schedule defaults: To set up your own power on and off schedule, select option 2 (Change power on and off schedule) on the Power On and Off Tasks (POWER) menu. On the Change Power On/Off Schedule display, press **F10** (Change power on/off defaults).

On this display, you can change the first day of the week by typing a number in the First day of week field. Also, the system automatically sends users a message telling them when the system will be powered off. You can indicate how many minutes before power off you want the system to send this message in the Minutes before power off to send field.

When the system sends the power off message, you can delay the scheduled time for powering off from 30 minutes to 3 hours when you reply to the message. Then the system will wait the time specified before powering off. You do not have another chance to delay the time.

For example, if you want the system powered on Mondays at 5:30 a.m. and off on Fridays at 11:00 p.m., and on Saturdays and Sundays you want the system powered on at 7:30 a.m. and off at 8:00 p.m., type the new times in the Default Power On and Default Power Off columns next to Saturday and Sunday. When you press **Enter**, your changes are shown on the Display Power On/Off Schedule and the Change Power On/Off Schedule displays.

Change a Day in the Power On and Off Schedule: The Change Power On/Off Schedule display allows you to change the power on and off schedule for a single day.

For example, to change the power on and off time for the plant's company picnic on Wednesday, May 3:

1. Type 14:30 in the Power Off column to power the system off at 2:30 p.m. so the employees can attend the picnic.
2. Type the reason for the change, Closing - Company picnic, in the Description column across from the date and time and press **Enter** .
3. Type the start time 5:30 in the Power On column to power the system back on Thursday, May 4.

To display the schedule starting on a different date, type the date you want to start with in the Start list at field and press **Enter** . The information that is displayed begins with the date you specify.

Solve problems with the automatic power schedule: If the power schedule is not working:

- Make sure that the Start Cleanup (STRCLNUP) command is part of your startup program.
- The automatic power scheduler uses a job called QSYSSCD to process the requests for schedule changes. The Start Cleanup (STRCLNUP) command must be run to start the QSYSSCD job. The IBM-supplied startup program includes the Start Cleanup (STRCLNUP) command. If you have your own startup program from a previous release, it may not contain the Start Cleanup (STRCLNUP) command.
- Make sure that you specify Yes on the Change Cleanup (CHGCLNUP) command to allow automatic cleanup. The QSYSSCD job will not start if you do not allow automatic cleanup.
- Make sure that the Start Cleanup (STRCLNUP) command submits the QSYSSCD job to the job queue specified in the Change Cleanup (CHGCLNUP) command.
- Check to see if the QSYSSCD job is running; it could be on a held job queue.
- Make sure that the job queue that the Start Cleanup (STRCLNUP) command is submitted to has the maximum jobs parameter set to *NOMAX or a number greater than 1. Because the QSYSSCD job always runs, the other jobs that perform automatic cleanup and power off functions are not able to start if the maximum jobs parameter is set to 1. To change the maximum jobs parameter, use the Change Subsystem Description (CHGSBSD) command.
- Make sure the mode is set to Normal or Auto.

System reference codes and primary partitions: The figure below shows the system reference codes that are displayed on the control panel, and approximately how long they remain displayed while the IPL (initial program load) is progressing on the primary partition. If you notice a code displayed longer than it should or a code not listed, see handling system problems and getting help .

Note: In the diagram, X can be any number 0 through 9 or letter A through F.

C1XX	BXXX	Input/Output processor(s) testing (1-5 minutes)
C1XX	1XXX	Input/Output processor(s) loading (1-10 minutes)
C3XX	3XXX	System processor testing(s) (2-10 minutes)
C1XX	2XXX	System processor loading(s) (2-10 minutes)
C1XX	202E	Testing system main storage (30 seconds-10 minutes, depending on size of main storage)
C1XX	D009	System power hardware ready (10 seconds)
C1XX	2034	IPL control passed to system processor (10 seconds)
C6XX	4XXX	Testing system configuration (1-10 minutes)

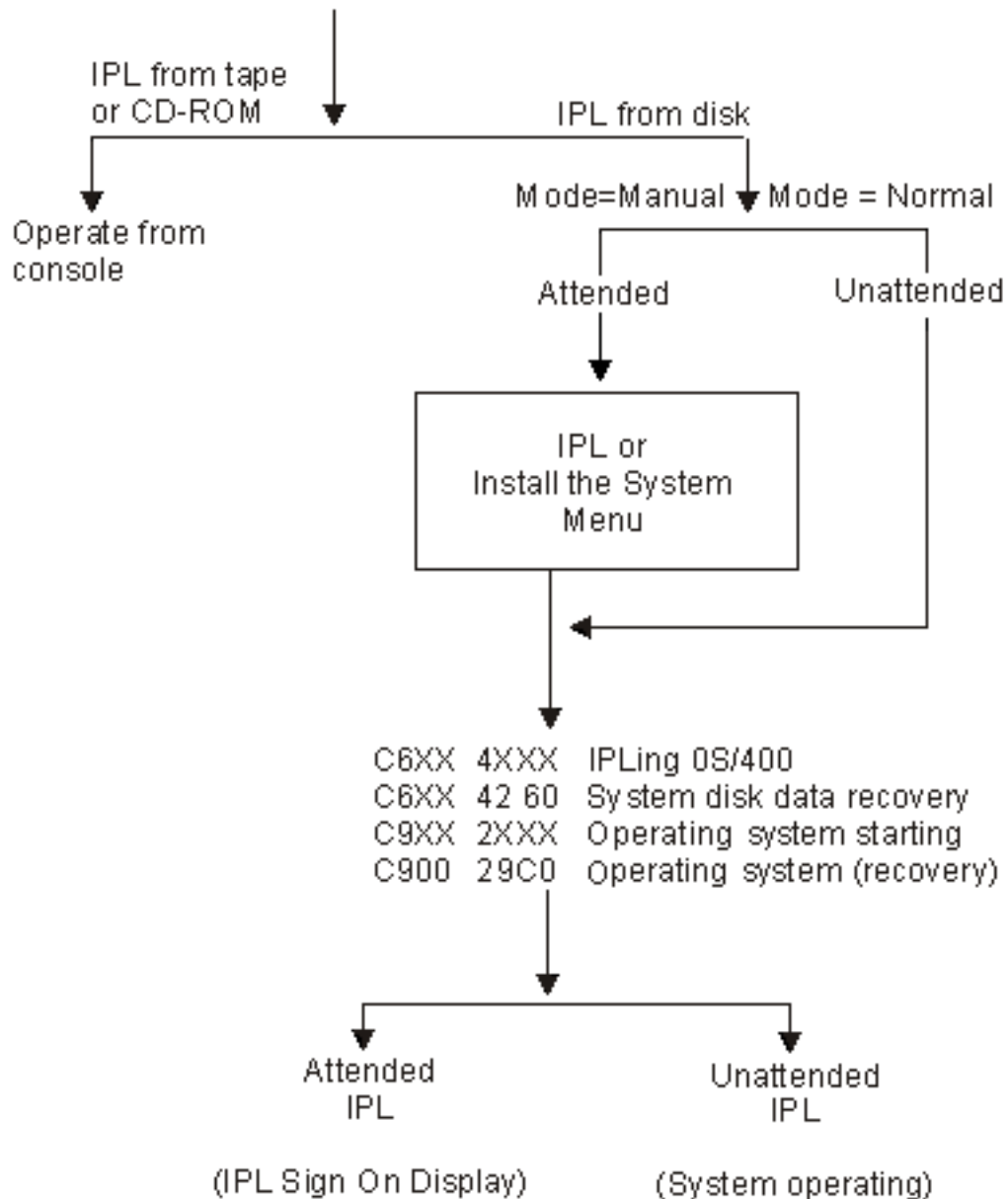

After the Sign-on display or command entry display appears, the IPL may still be completing some processing in the background. The IPL is considered complete, but the system may be performing asynchronous clean up. Some functions, such as accessing folders and document library objects (DLOs) may not be available until this clean up is complete.

You should allow sufficient time for an IPL to complete before attempting such functions. The time of completion for an IPL depends on such factors as your system model and configuration.

System reference codes and secondary partitions: The figure below shows the system reference codes that are displayed on the Work with Partition Status display while the IPL (initial program load) is progressing on secondary partitions. The figure also shows approximately how long the codes remain displayed. If you notice a code displayed longer than it should or a code not listed see handling system problems and getting help .

Note: In the diagram, X can be any number 0 through 9 or letter A through F.

C2XX	3XXX	Bus unit initial ISL (1-30 minutes)
C2XX	4XXX	Load source device connect (1-10 minutes)
C2XX	5XXX	Main store dump (0-15 minutes)
C2XX	6XXX	Load SLIC from load source (1-15 minutes)
C2XX	7XXX	Load source device disconnect (1-10 minutes)
C2XX	8XXX	Start processors (1-5 minutes)
C6XX	4XXX	Testing system configuration (1-10 minutes)

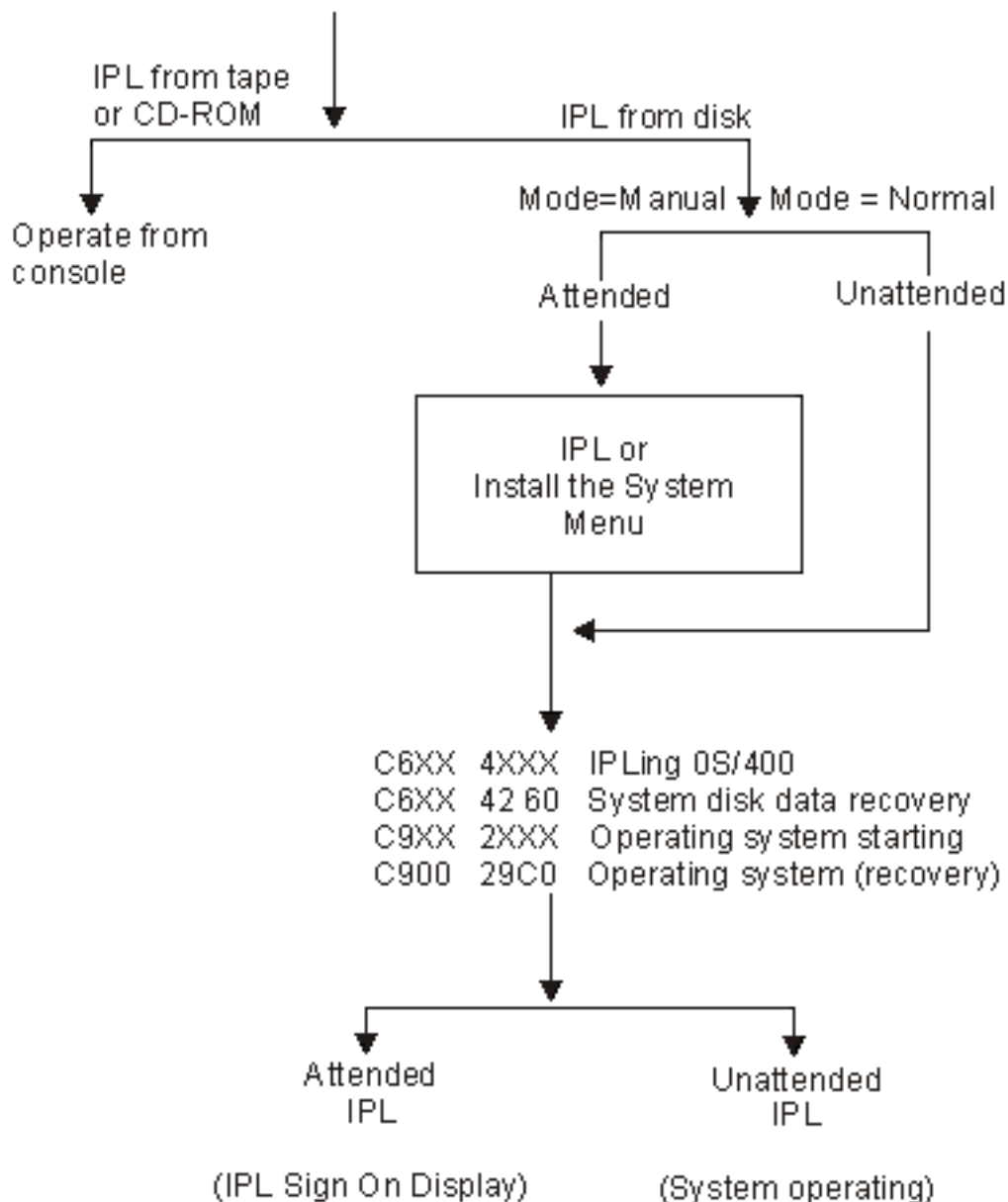

After the Sign-on display or command entry display appears, the IPL may still be completing some processing in the background. The IPL is considered complete, but the system may be performing asynchronous clean up. Some functions, such as accessing folders and document library objects (DLOs) may not be available until this clean up is complete.

You should allow sufficient time for an IPL to complete before attempting such functions. The time of completion for an IPL depends on such factors as your system model and configuration.

Causes of abnormal IPLs: An abnormal IPL (initial program load) can be caused by any of the following:

- Using the End Job Abnormal (ENDJOBABN) command. To see if this command has been used, look for message CPC1124 in the job log.
- Using option 7 (Start a service tool), then option 7 (Operator panel function) on the Dedicated Service Tool (DST) menu.
- Using the Power pushbutton instead of the PWRDWNSYS command.
- A power failure occurring before all data is written from main storage to disk.
- Any B900 xxxx system reference code (where xxxx is any number or letter) during the start of the operating system phase of the IPL.
- A Power Down System (PWRDWNSYS) command that did not complete, ending with a system reference code of B900 3F10.
- Any function check in the controlling subsystem causing the system to end.
- For all active secondary partitions, any failure of the primary partition.
- Issuing a PWRDWNSYS command in the primary partition without first powering down secondary partitions.
- The system going down when database recovery has not completed during the IPL.

Note: If the End Job Abnormal (ENDJOBABN) command was issued, message CPI0990 will be in QHST. For all other reasons, message CPI091D will be in QHST stating why the IPL was abnormal.

Signing on to the iSeries

The iSeries requires users to sign-on to the system before gaining access to any system functions. This provides both an important measure of security and allows for each user's session to be customized. In addition to simply checking the password, OS/400 uses the sign-on to access the specified user profile. OS/400 uses this profile to customize the displays, providing consideration for the user's language and available functions.

To sign on the system:

1. Type your user ID, your password (if security is active), and fill in any of the optional entry fields you want to use. Use the Tab key to move the cursor from field to field on the display.

Notes:

- The Password field is displayed only if password security is active on the system.
- The top right corner of the Sign On displays the name of the system you are using, the subsystem the system is using, and the display station identifier (ID).

2. Press **Enter**.

If this is an unattended IPL (initial program load), one or more of the following occurs, depending on what options you select on this display or what is defined in your user profile:

- The Main Menu is displayed.
- Another menu is displayed.
- A program or procedure is run.
- A current library is inserted into your library list.

If you specify a program or procedure to run and a menu to be displayed, the program or procedure is run first and then the menu is shown.

After signing on, you may Change your system password .

Now that your system is up and running be aware that:

- The Operational Assistant displays are now the default.
- The system cleanup functions are automatically started with default values.
- The Attention key program defaults to display the Operational Assistant (ASSIST) menu.

Change the system password: When you install the OS/400 licensed program, the licensed program runs a check to detect system model changes, certain service conditions, and ownership changes. If the licensed program detects these changes or conditions, you are prompted to enter the system password before the IPL (initial program load) can continue. If no changes or conditions are recognized, the IPL continues without a request for the system password.

You must enter the correct system password to complete the IPL on the primary partition. If the system password is not available, you or your service representative may temporarily bypass entering the system password for a limited time. When the bypass period starts, immediately contact your marketing representative, who will have IBM send you the correct system password. To order the system password, ask your marketing representative to order nonstandard RPQ S40345 if you are in the United States, Asia Pacific, Canada, Latin America, or Japan. If you are in Europe, Middle East, or Asia, request nonstandard RPQ S40346.

To change the system password

- If you have just installed new hardware, you may need to change the system password during the first IPL. To do this:
 1. Select option 1 (Change the system password) on the Verification of System Password Failed display.
 2. The following system information on the Change the System Password display is shown:
 - System serial number
 - System type number
 - System model number
 - System password version
 - Processor card serial number

If you do not know the system password, use F12 (Cancel) and select option 2 (Bypass the system password) on the Verification of System Password Failed display.

3. Type the password in the blank field and press **Enter**.
- To change the system password when your system is operational:
 1. Perform an attended IPL.
 2. Select option 1 (Change the system password) on the Verification of System Password Failed display.
 3. Type the password in the blank field and press **Enter**.

Bypassing the system password

Use the Verification of System Password Failed display to bypass the system password when:

- You do not know or cannot find the system password.
 - You guess the system password and get a message stating that the password you entered is incorrect.
- Note:** If you type the password incorrectly five times, you must do the IPL again.

To bypass the system password during the first IPL:

1. Select option 2 (Bypass the system password) on the Verification of System Password Failed display.
2. Read the information on the Bypass the System Password display. Remember to contact your marketing representative immediately to obtain the system password before the bypass period runs out.

3. Press **F9** (Bypass) to continue the IPL.

When the IPL has finished, you will receive hourly messages that tell how much time is left in the bypass period.

When you receive the password, you can enter it by doing the following:

- Do an attended IPL and select option 1 (Change the system password) on the Verification of System Password Failed display.
- Do an attended IPL and select option 1 (Change the system password) on the Bypass Period has Ended display.

Stop the system

Turning off your system takes careful attention. If you turn off the system without completing the tasks below, you may cause damage to data or cause the system to behave in unpredictable ways. The iSeries provides several ways to safely power down your system.

- You can stop the system using the Power On and Off Tasks (POWER) menu. To get to the Power On and Off Tasks (POWER) menu, type **go power** on any command line and press **Enter**.
- You can set up a schedule that automatically powers your system on and off. You can determine the time of day you want the system powered on and off. You can also specify special circumstances that change the normal daily schedule, such as a holiday or special closing.
- You can also use the POWERDWN SYS command to powering off the system immediately.
- In emergencies you can stop the system by using the power pushbutton. However, using the Power pushbutton may cause errors with your data files and other objects on the system.

Before you power down your system, you should complete the following tasks:

Make sure all batch jobs are finished and users are signed off the system:

1. Send a message that interrupts all users signed on the system telling them to sign off.
 - a. Type **GO MANAGESYS** and press **Enter**.
 - b. Select option 12 (Work with signed-on users) on the Manage Your System, Users, and Devices (MANAGESYS) menu.
Note: if the Work with User Jobs display is shown, you need to switch to basic assistance level using F21.
 - c. Press **F10** (Send message to all) on the Work with Signed-On Users display.
 - d. Type the message in the Message text field on the Send a Message display and press **F10** (Send).
2. Wait for the users to sign off.
3. Check to make sure all users have signed off by pressing **F5** (Refresh) on the Work with Signed-On Users display. When everyone is signed off the system, the display will show only your job. To sign someone off the system, use option 4 (Sign off).
Note: if you have separate interactive subsystems, other than the controlling subsystem, you may want to stop the interactive subsystems once the users have signed off. This prevents them from signing on again before you have stopped the system. See Working with Subsystems for information on how to end a subsystem.

Check the status of any batch jobs that might be affected if the system is powered down:

1. On any command line, type **go managesys** and press **Enter**.
2. Select option 11 (Work with jobs) on the Manage Your System, Users, and Devices (MANAGESYS) menu.
Note: if the Work with User Jobs display is shown, you need to switch to basic assistance level using F21.
3. Press **F14** (Select other jobs) on the Work with Jobs display.
4. Type ***all** in the User field.

5. Type an **N** in every field except the Message waiting, Running, and Running job held fields. The Work with Jobs display is shown again with the batch jobs listed.
6. If any job queues have jobs waiting to run, press **F22** (Work with job queues) to see the Work with Job Queues display.
7. Hold any job queues that have jobs waiting to run on the Work with Job Queues display. Release these job queues when you start the system again.
8. Press **F12** (Cancel) to return to the Work with Jobs display.
9. Press **F5** (Refresh) every few minutes until all batch jobs have completed processing.

Check for removable media

1. Check to see if there are any tapes in any of the tape units or diskettes in any of the diskette units.
2. Remove any tapes or diskettes currently in the unit.

For more information about shutting down an iSeries server, including using Uninterruptable Power Supplies and other emergency shutdown methods, refer to Controlled shutdown concepts .

Powering off the system immediately: You can stop the system by using the Power Down System (PWRDWNSYS) command on any command line when the system is in any mode. Type **PWRDWNSYS** and press **F4** to view the power down options. You must have QSYSOPR authority to use the Power Down System (PWRDWNSYS) command. If this command does not work on your system, use the following methods.

To power off the system immediately:

1. Type **go power** on any command line to display the Power on and Off Tasks (POWER) menu.
2. Select option 3 (Power off the system immediately) if you want to keep the power off until the next time the system is scheduled to power on.
3. Press **F16** (Confirm) to confirm your choice to power off the system immediately. An immediate power down occurs that causes the subsystems to end all active jobs.

To power off the system and restart immediately:

1. Select option 4 (Power off the system immediately and then power on) on the Power On and Off Tasks (POWER) menu.
2. Press **F16** (Confirm) to confirm your choice. The system stops running and then starts again automatically.

Note: Don't turn the modem on or off when the system is turned off and is made ready for remote IPL (initial program load). Otherwise, the system may start unexpectedly, although it turns itself off in a few minutes.

Note: If you stop the system using the automatic power schedule or one of the options on the Power On and Off Tasks (POWER) menu, the IPL date and time system value (QIPLDATTIM) is checked and, if necessary, reset to the next scheduled power-on time. This checking does not occur if you power off in another way, so the system may not power on automatically. To force the power schedule to update the QIPLDATTIM system value, enter the following command on any command line: **CHGPWRSCDE DAY(*TODAY) PWRONTIME(*SAME) PWROFFTIME(*SAME)**

Using the power pushbutton: If you cannot use option 3 (Power off the system immediately) or option 4 (Power off the system immediately and then power on) on the Power On and Off Tasks (POWER) menu to stop the system, you can turn the power off using the Power pushbutton to turn off the system when the mode is set to Manual.

Note: Using the power pushbutton to turn off the system may cause results that cannot be predicted in your data files, and the next IPL (initial program load) will take longer to complete. Using the Power pushbutton to turn off the system will power down all partitions.

Make sure that there are no tapes in the tape units or diskettes in the diskette units, and that the mode is set to Manual.

Do not turn the modem on or off when the system is turned off and is made ready for remote IPL. Otherwise, the system may start unexpectedly, although it turns itself off in a few minutes.

To turn the power off using the Power Pushbutton, do the following:

1. Press the Power pushbutton. The Function/Data display blinks with 0 (the international power off symbol).
2. Press the Power pushbutton again. The Power On light blinks as the system is being powered off. When power off is complete, the light goes off.

If the system does not turn the power off within 30 minutes, wait for the System Attention light to come on. When the System Attention light comes on, go to Analyzing and reporting system problems and follow the steps necessary to solve the problem.

Use the control panel

The control panel is your initial interface to your iSeries server. From the control panel, you can process system functions such as the following:

- Power on or off the system
- Perform an initial program load (IPL)
- Display and read status or error codes to analyze problems
- Determine processor activity

The following topics provide information for you to set up the virtual control panel or the remote control panel, access control panel functions, and use APIs to operate your remote control panel with a user-written program.

Control panel concepts

This information explains the differences between control panel options. It also provides details about functions that the control panel can perform.

Set up your control panel

These instructions provide detailed information that you can use to get the remote control panel and the virtual control panel up and running.

Access control panel functions

This information provides steps that explain how to access the control panel functions.

Instructions and descriptions for control panel functions

This information describes each control panel function, the uses and procedures for each function, and when you should use each function.

Use remote control panel APIs

Use these APIs to write a program that can access the control panel remotely. Your program can access many commands and queries using these APIs.

Control panel concepts: The following information explains the difference between the virtual control panel, remote control panel, and the physical control panel. It also provides detailed information about the functions that the control panel can perform.

Types of control panels

This information compares and contrasts the virtual control panel, remote control panel, and physical control panel.

Control panel functions

This information provides a table that shows each control panel function and whether or not each type of control panel supports it.

Control panel buttons, lights, and indicators

This information describes the interface for each type of control panel.

Types of control panels: You can use the physical control panel, remote control panel, and virtual control panel to perform almost all of the same functions. The remote control panel and virtual control panel provide a way to perform control panel functions from a PC.

The following topics have more information about control panel options.

- Physical control panel
- Remote control panel
- Virtual control panel

Physical control panel: The physical control panel is your initial interface with the iSeries server. You can use the physical control panel to perform functions such as IPL, power on, and power off. Control panel functions range in complexity from functions that simply display status (such as IPL speed) to low-level service functions that only service representatives should access.

For information on using the physical control panel see Access control panel functions. See Control panel buttons, lights, and indicators for a description of the interface for the physical control panel.

Remote control panel: The remote control panel is a way to use control panel functions through a PC. The graphical user interface of the remote control panel looks similar to the physical control panel. The following are characteristics of the remote control panel:

- The remote control panel installs through Operations Console.
- You can use the interface for the remote control panel to restart and power off the server. Also, the remote control panel can power up the server if it is cabled directly to the server. It cannot power up the server if it is connected through a LAN. You can use the remote control panel to perform most of the same functions as the physical control panel.
- You can use the remote control panel through a direct connection using a serial port or a parallel port, depending on your server model. You can also use the remote control panel through a LAN or remotely with a modem connection.
- You can use remote control panel APIs to automate control of the remote control panel through a user-created program.
- If your server uses a keystick, the **mode** button works with the same functions as the physical control panel, depending on whether or not the keystick is inserted.

See Set up your control panel for information on setting up the remote control panel. For information on using the remote control panel see Access control panel functions. See Control panel buttons, lights, and indicators for a description of the interface for the remote control panel.

Virtual control panel: The virtual control panel is an alternative to the remote control panel for parallel cable. Like the remote control panel, the virtual control panel is a way to use control panel functions through a PC. The graphical user interface for the virtual control panel is identical to the remote control panel. Also, the virtual control panel can perform most of the same functions as the remote control panel. If your server uses a keystick, the **mode** button works with the same functions as the physical control panel, depending on whether or not the keystick is inserted.

The biggest functional difference between the remote control panel and the virtual control panel is that the virtual control panel cannot power on the server. As an alternative, if you need to power on the system at a later time, you can use the IPL scheduling function in Operational Assistant, by pressing the **Attention** key. You can also use the GO POWER command and select option 2 (Change power on and off schedule).

Considerations for the virtual control panel

If you use the virtual control panel, you should be aware of the following considerations:

- The virtual control panel must have a direct connection to the server from Operations Console using the serial console cable.
- The virtual control panel is only available while the Operations Console is connected.
- You cannot use the virtual control panel remotely through a dial up connection.
- There are prerequisites to installing the virtual control panel such as PTFs for the server and service packs for the client.
- If the PC has a parallel cable connection for a remote control panel, you must remove it before you can install and use your virtual control panel.
- A unique service tools device profile must exist for each virtual control panel connection.
- You cannot use an existing network name.
- More than one virtual control panel and remote control panel can be active at the same time.
- The service tools user profile used to authenticate the connection must have the Partition remote panel key privilege in order to use the mode function provided by the virtual control panel.

How to choose between the virtual control panel and remote control panel

The following table shows which server models are recommended for the virtual control panel and which models are recommended for the remote control panel.

Virtual control panel	Remote control panel
270	170
820	250
830	6xx
840	7xx
890	Sxx

For information such as prerequisites, setup instructions, and configuration instructions for the virtual control panel, see the iSeries Access  Web site.

For information on using the virtual control panel see Access control panel functions. See Control panel buttons, lights, and indicators for a description of the interface for the virtual control panel.

Control panel functions: There are few functional differences among the remote control panel, virtual control panel, and physical control panel. The main difference is that the physical control panel and the remote control panel, when it is cabled directly to the server, can power up the iSeries server. The virtual control panel and the remote control panel, if it is connected through a LAN, cannot power up the server.

The following table describes all of the control panel functions and whether or not the virtual control panel and remote control panel support them.

The following table lists the code for the control panel functions and the descriptions of the control panel functions.

Notes:

1. Some control panel functions might not be available on all system types.
2. The x can be any number 0 through 9, any letter A through F, or a blank.
3. If you have selected a function, find the selected function in the table below and verify that you have completed the correct function.
4. If you cannot change the *Function/Data* display or complete the selected function, go to "Starting Point for All Problems" in your system's Problem Analysis information.

Control panel (32-character) function codes

Function code	Remote control panel code	Virtual control panel function?	Function description
01	01	Yes	<ol style="list-style-type: none"> 1. Displays the currently selected IPL type (and logical key mode on some system types). 2. Displays the currently selected IPL speed override for the next IPL.
02	02	Yes	Selects the IPL type, logical key mode, and IPL speed.
03	03	Yes	Starts an IPL to load the system. The IPL uses the selected IPL options.
04	04	Yes	Lamp test all displays and indicators will be switched on.
05	05	No	System power control network (SPCN) system reference code (SRC). Displays an SRC on the control panel.
07	Not applicable	Not applicable	Allows you to perform SPCN service functions.
08	08	Yes	Fast power off. To perform a fast power off, see "Powering Off and Powering On the System" in the Problem Analysis information for your system.
09 through 10	Not applicable	Not applicable	Reserved.
11 through 19	11 through 19	Yes	System reference code (SRC) displays an SRC on the control panel.
20	20	Yes	Displays the machine type, model, processor feature code, processor class indicator, and IPL path description.

Function code	Remote control panel code	Virtual control panel function?	Function description
21	21	Yes	Causes the Use Dedicated Service Tool (DST) display to appear on the system console. To exit DST, select the <i>Resume operating system display</i> option.
22	22	Yes	Forces system main storage dump.
23	Not applicable	Not applicable	Reserved.
24	Not applicable	Not applicable	Reserved.
25	25	Yes	Uses Service switches 1 and 2 to enable or disable functions 50 through 70.
26	26	Yes	Uses Service switches 1 and 2 to enable or disable functions 50 through 70.
27 through 32	Not applicable	Not applicable	Reserved.
33	33	Yes	Reorders SPCN addressing.
34	34	Yes	Retries (MSD) IPL.
35 through 49	Not applicable	Not applicable	Reserved.
50	Not applicable	Not applicable	System processing unit stop.
51	Not applicable	Not applicable	System processing unit status displays the following values: B0 register contents, Next Instruction Address (NIA), and current Task Dispatching Element (TDE) contents
52	Not applicable	Not applicable	System processing unit start.
53 through 56	Not applicable	Not applicable	Reserved.
57	Not applicable	Not applicable	Displays area addresses for system data.
58	Not applicable	Not applicable	Sets the first character of the base address for the function 62 display.
59	Not applicable	Not applicable	Sets the second character of the base address for the function 62 display.
60	Not applicable	Not applicable	Sets the third character of base address for function 62 display.
61	Not applicable	Not applicable	Sets the fourth character of base address for function 62 display.
62	Not applicable	Not applicable	Displays service processor storage.

Function code	Remote control panel code	Virtual control panel function?	Function description
63	Not applicable	Not applicable	System status SRC trace.
64	Not applicable	Not applicable	Service processor diagnostic status SRC trace.
65	65	Yes	Deactivates remote service.
66	66	Yes	Activates remote service.
67	67	Yes	Disk unit IOP reset/reload is enabled only by specific disk unit SRCs.
68	68	Yes	Concurrent maintenance power domain Power Off.
69	69	Yes	Concurrent maintenance power domain Power On.
70	70	No	Dump service processor control storage.
Power button	Power button in graphical interface — for powering on and off the server. (LAN connected remote control panels cannot power on the server.)	Power button in graphical interface — for powering off the server only.	OFF = Delayed power off ON = Immediate power on (can be timed power on)
Keystick	See note.	See note.	IPL keylock - Manual, Auto, Normal, Secure
Attention light	Graphical attention light	Yes	Attention state LED
Power Indicator	Power indicator in graphical interface	Power indicator in graphical interface	Lit when power is fully operational
Note: The remote control panel and virtual control panel recognize the presence of a keystick. If your server uses a keystick, the mode button works with the same functions as the physical control panel, depending on whether or not the keystick is inserted. LAN connected remote control panels need special authority to use the mode button.			

If you cannot find the function code in the previous table, the customer support for added features or devices might not have been available when this information was produced. Look for any supplemental unit function code information for the function code you displayed on the control panel.

For more details about the functions, see Instructions and descriptions for control panel functions.

Control panel buttons, lights, and indicators: This topic describes the buttons, lights, and indicators for the control panel. It also describes the interface for the virtual control panel and remote control panel. The interface for the virtual control panel and remote control panel are identical.

The following figures show:

- The remote control panel or virtual control panel
- A control panel without a keystick
- A control panel with a key stick

Remote control panel and virtual control panel

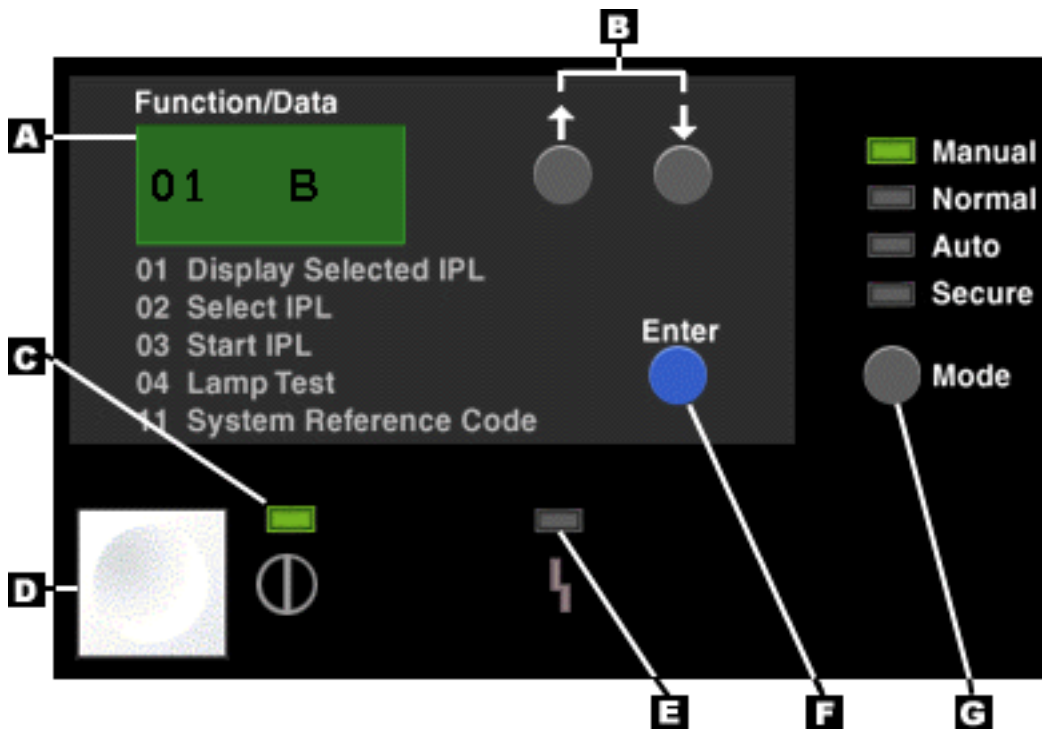

- (A) Function/Data display
- (B) Increment and Decrement buttons
- (C) Power on indicator
- (D) Power button
- (E) System Attention light
- (F) Enter button
- (G) Mode button

Physical control panel without a keystick

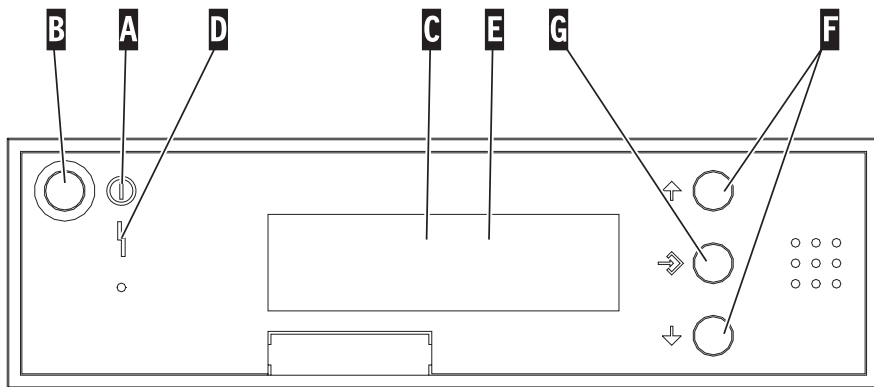

RV5B002-4

- (A) Power On Light
 - A blinking light indicates power to the unit.
 - A constant light indicates that the unit is up and is working.
- (B) Power button
- (C) Processor Activity
- (D) System Attention
- (E) Function/Data Display

- (F) Increment and Decrement buttons
- (G) Enter button

Physical control panel with a keystick

A keystick gives the operator security control over the control panel functions and control over data that is accessible from the control panel. The keystick for the electronic keylock activates the Mode button.

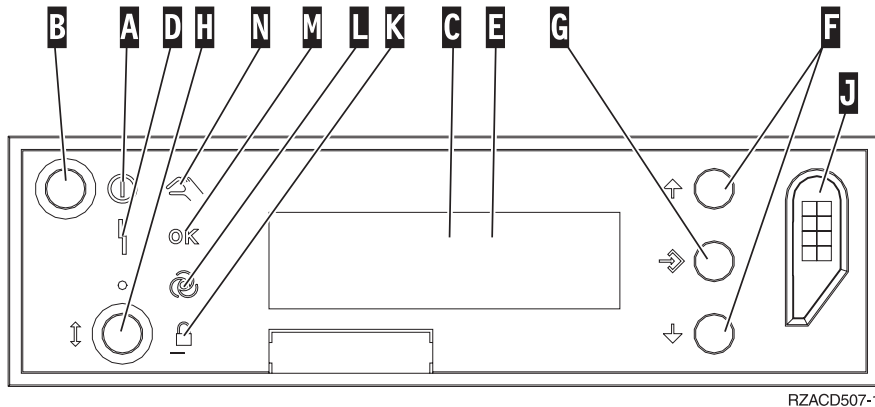

RZACD507-1

- (A) Power On Light
 - A blinking light indicates power to the unit.
 - A constant light indicates that the unit is up and is working.
- (B) Power button
- (C) Processor Activity
- (D) System Attention
- (E) Function/Data Display
- (F) Increment and Decrement buttons
- (G) Enter button
- (H) Mode button
- (J) Electronic Keystick Slot
- (K) Secure
- (L) Auto
- (M) Normal
- (N) Manual

Set up your control panel: Both the remote control panel and the virtual control panel are set up through an Operations Console configuration. You will need to install Operations Console and configure a remote control panel or a virtual control panel to receive control panel functions. For more specific setup instructions:

Set up your remote control panel

In order to set up the remote control panel, you will need to install Operations Console. During the configuration wizard, you will be given the option to select the remote control panel function.

Considerations for configuring a remote control panel configuration:

- You are required to have a special remote control panel cable to support your configuration. See Installing Operations Console cables for specific requirements.

- A local console through dial-up support does not support the remote control panel functions. A remote console through dial-up support only supports the remote control panel functions if the local console it connects to has the cable installed and configured.

Set up your virtual control panel

The iSeries Access  web site has specific set up instructions for setting up your virtual control panel. You must have a local console directly attached to the server configured in order for the virtual control panel to function. In order to set up a local console directly attached to the server configuration, you will need to follow the set up instructions in Operations Console. The use of virtual control panel functions has some limitations and restrictions so be sure to look at those in the installation instructions.

See Troubleshoot Operations Console connections for information on troubleshooting the remote control panel or virtual control panel.

Access control panel functions: These instructions apply to the physical control panel, remote control panel, or virtual control panel. If you are using the virtual control panel or remote control panel, click the button where the instructions say press. To use the control panel, perform the following steps.

1. If your physical control panel has a keystick, insert the keystick and press the Mode button to select manual mode. You must do this step even if you are using the remote control panel or virtual control panel.
2. To select a function number, press (or click) the Increment (^) or Decrement (V) button on the control panel until the desired function number is in the display.
3. Press (or click) the Enter button.

Control panel with a keystick

Note: Control panel buttons, lights, and indicators describes the interface for the virtual control panel and remote control panel.

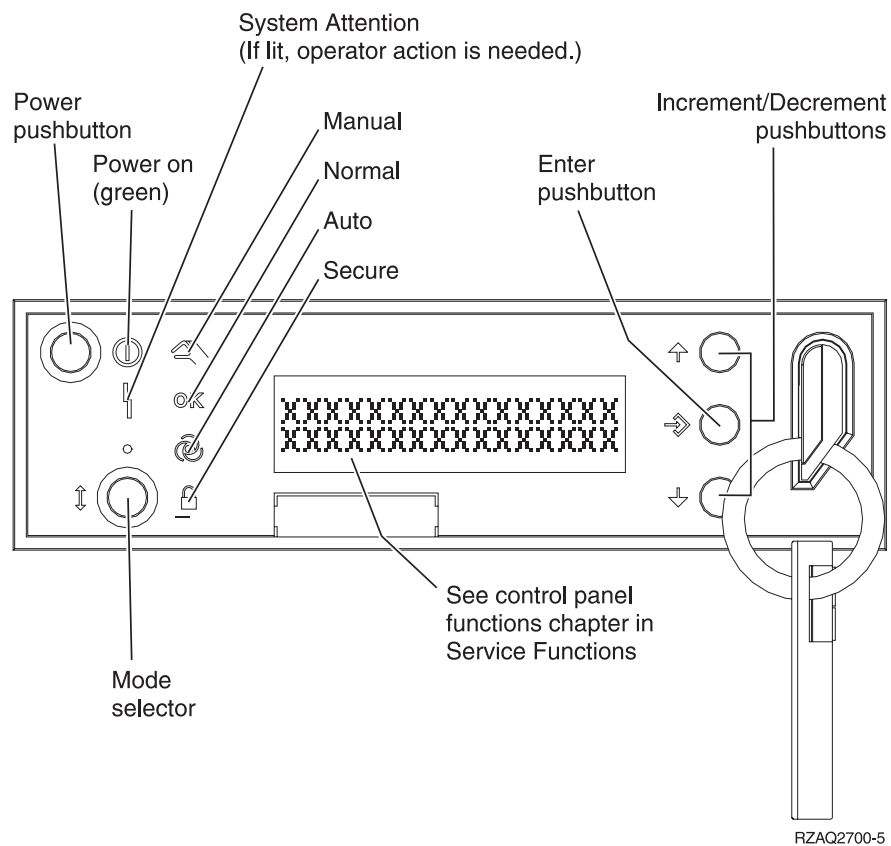

This graphic shows these items on the control panel:

- Power On Indicator
- Power button
- Processor Activity or Processor Active light
- System Attention light
- Function/Data display
- Increment and Decrement buttons
- Enter button
- Mode button
- Electronic keystick slot
- Cycle/Hold button

Instructions and descriptions for control panel functions: This topic has detailed information that describes all of the control panel functions and how to use them. The remote control panel and virtual control panel can perform most of these functions. The physical control panel can perform all of them.

You can think of control panel functions in three categories:

Normal control panel functions.

Normal control panel functions are functions that are performed the most often. They include functions such as displaying IPL speed and forcing the server to perform an IPL. They also include functions such as forcing DST and forcing a main storage dump. These functions are 01 through 49.

Extended control panel functions.

Extended control panel functions are performed less often. They are functions that only support service representatives should perform. Extended functions are 50 through 70.

Low-level debug panel functions

These are functions 57 through 70 and should only be performed by support service representatives.

Note: The examples in the following topics show control panels with a 4-word (32 character) display. Control panels with a 1-word (8 character) display only show the first word (8 characters) of each function.

The following topics have detailed information and instructions to use the control panel functions:

- Normal control panel functions
- Extended control panel functions
- Low-level debug panel functions

Normal control panel functions: Following are instructions to use function 01 through 49. Functions 21 through 49 are available when you select manual mode.

The instructions you follow for function 01 or function 02 depends on whether or not your server uses a keystick. Also, the instructions for function 01 and 02 alternate between servers with a keystick and servers without a keystick.

To determine how to activate functions 01 and 02 on a control panel, do the following:

1. Does the control panel have an electronic keylock (a keystick)?

Yes Go to the next step.

No The system displays the IPL key mode (M or N only). The IPL key modes, Auto and Secure, are not supported. Follow function 01 and 02 procedures for **system without a keystick**.

2. Insert the keystick.

Press the Mode-selection button to select the IPL mode. Follow function 01 and 02 procedures for **systems with a keystick**.

Note: The function that is displayed is not activated until you press Enter on the control panel.

To select a function number, press the Increment (^) or Decrement (V) button on the control panel. To activate the function, press Enter on the control panel while the system displays the desired function number.

Function 01-Display Selected IPL Type and IPL Speed (on Systems with a Keystick)

This function allows you to display the selected type and speed for the next IPL.

1. Display IPL types (A, B, C, or D).
2. Display IPL speed (F, S, SE, V=F, or V=S).

When selected, function 01 displays the currently selected IPL type and IPL speed values (where each () represents 1 character):

The following table shows a function 01 example with a keystick.

Function 01 on systems with a keystick

Function/data	Action or description
0 1 _ _ _ _ _ _ _ _ _ _ _ _ _ _ _ _	Use the Increment or Decrement buttons to scroll to function 01.

Function/data	Action or description
0 1 _ _ A _ _ _ _ _ V = F _ _ _ _ _ _ _ _	Valid IPL types are A, B, C, and D. Valid IPL speed displays are F, S, SE, V=F, or V=S.
0 1 _ _ _ _ _ _ _ _ _ _	Use the Increment or Decrement buttons to scroll through the control panel functions.

Function 01-Display Selected IPL Type, Logical Key Mode, and IPL Speed (on Systems without a Keystick)

This function allows you to display the selected IPL type, logical key mode, and speed for the next IPL.

1. Display IPL types (A, B, C, or D).
2. Display the valid logical key modes (M or N).
3. Display IPL speed (F, S, SE, V=F, or V=S).

The following table shows a function 01 example on systems without a keystick.

Function 01 on systems without a keystick

Function/data	Action or description
0 1 _ _ _ _ _ _ _ _ _ _	Use the Increment or Decrement buttons to scroll to function 01.
0 1 _ _ A _ _ M _ _ V = F _ _ _ _ _ _ _ _	Valid IPL types are A, B, C, and D. Valid logical key modes are M and N. Valid IPL speed displays are F, S, SE, V=F, or V=S.
0 1 _ _ _ _ _ _ _ _ _ _	Use the Increment or Decrement buttons to scroll through the control panel functions.

Function 02 with a keystick - Select IPL Type and IPL Speed Override (on Systems with a Keystick)

Before you can use function 02, you must have the system in Manual mode. You can make selection changes to IPL types with the system powered on or off. However, to select the IPL speed override, you must power off the system.

The following table shows the sequence used to select the IPL type on iSeries servers that are powered on.

Function 02 selects IPL type on powered-on systems with a keystick

Function/data	Action or description
0 2 _ _ _ _ _ _ _ _ _ _	Use the Increment or Decrement buttons to scroll to function 02.
0 2 _ _ A < _ _ _ _ _ _ _ _ _ _	Press Enter to start function 02. The current IPL type is displayed with a pointer.
0 2 _ _ B < _ _ _ _ _ _ _ _ _ _	Use the Increment or Decrement buttons to scroll through the IPL types.
0 2 _ _ _ _ _ _ _ _ _ _	Press Enter to select the IPL type and exit function 02.

Function/data	Action or description
0 1 _ _ _ _ _ _ _ _ _ _	Use the Increment or Decrement buttons to scroll through the control panel functions.

The following table shows the sequence used to select the IPL type and IPL speed on iSeries 400 systems that are powered off.

Function 02 selects IPL type and IPL speed on powered-off systems with a keystick

Function/Data	Action or Description
0 2 _ _ _ _ _ _ _ _ _ _	Use Increment or Decrement buttons to scroll to function 02.
0 2 _ _ A < _ _ _ _ _ V _ _ _ _ _ _ _ _	Press Enter to start function 02: <ul style="list-style-type: none"> The current IPL type is displayed with pointer. The current IPL speed is displayed.
0 2 _ _ B < _ _ _ _ _ V _ _ _ _ _ _ _ _	Use the Increment or Decrement buttons to scroll through the IPL types and speeds.
0 2 _ _ B _ _ _ _ _ V _ < _ _ _ _ _ _	Press Enter to select the IPL type. <ul style="list-style-type: none"> The current IPL type is displayed. The current IPL speed is displayed with a pointer.
0 2 _ _ B _ _ _ _ _ S _ < _ _ _ _ _ _	Use the Increment or Decrement buttons to scroll through the IPL speeds.
0 2 _ _ _ _ _ _ _ _ _ _	Press Enter to select the IPL speed and exit function 02.
0 1 _ _ _ _ _ _ _ _ _ _	Use the Increment or Decrement buttons to scroll through the control panel functions.

Function 02 without a keystick-Select IPL Type, IPL Speed Override, and Logical Key Mode (on Systems without a Keystick.)

You can use function 02 in either normal mode or manual mode. With the system either powered on or off, this function allows you to select the IPL type and logical key mode. Before you can select the IPL speed override, you must power off the system.

Powered-on systems

For powered-on systems without a keystick, function 02 is used to select the IPL mode and logical key mode. The following table shows an example of the function 02 IPL type and logical key mode selection sequence for a powered-on system that does not have a keystick.

Function 02 selects IPL type and logical key mode on powered-on systems without a keystick

Function/data	Action or description
0 2 _ _ _ _ _ _ _ _ _ _	Use the Increment or Decrement buttons to scroll to function 02.
0 2 _ _ A < _ M _ _ _ _ _ _ _ _ _ _	Press Enter to start function 02. <ul style="list-style-type: none"> The current IPL type is displayed with a pointer. The current logical key mode is displayed.

Function/data	Action or description
0 2 _ _ B < _ M _ _ _ _ _ _ _ _ _ _ _ _ _ _ _ _ _ _	Use the Increment or Decrement buttons to scroll through the IPL types.
0 2 _ _ B _ _ M < _ _ _ _ _ _ _ _ _ _ _ _ _ _ _ _ _ _	Press Enter to select the IPL type.
0 2 _ _ B _ _ N < _ _ _ _ _ _ _ _ _ _ _ _ _ _ _ _ _ _	Use the Increment or Decrement buttons to scroll through the logical key modes.
0 2 _	Press Enter to select the logical key mode and exit function 02.
0 1 _	Use the Increment or Decrement buttons to scroll through the control panel functions.

Powered-off systems

For powered-off systems without a keystick, function 02 is used to select the IPL type, logical key mode, and IPL speed indicators. The following table shows an example of the function 02 IPL type, logical key mode, and IPL speed selection sequence for a powered-off system that does not have a keystick.

Function 02 selects IPL type, logical key mode, and IPL speed on powered-off systems without a keystick

Function/data	Action or description
0 2 _	Use the Increment or Decrement buttons to scroll to function 02.
0 2 _ _ A < _ M _ _ _ _ V _ _ _ _ _ _ _ _ _ _ _ _ _ _ _	Press Enter to start function 02. <ul style="list-style-type: none"> The current IPL type is displayed with a pointer. The current logical key mode is displayed. The current IPL speed is displayed.
0 2 _ _ B < _ M _ _ _ _ V _ _ _ _ _ _ _ _ _ _ _ _ _ _ _	Use the Increment or Decrement buttons to scroll through the IPL types.
0 2 _ _ B _ _ M < _ _ _ V _ _ _ _ _ _ _ _ _ _ _ _ _ _ _	Press Enter to select the IPL type. <ul style="list-style-type: none"> The current IPL type is displayed. The current logical key mode is displayed with a pointer. The current IPL speed is displayed.
0 2 _ _ B _ _ N < _ _ _ V _ _ _ _ _ _ _ _ _ _ _ _ _ _ _	Use the Increment or Decrement buttons to scroll through the logical key modes.
0 2 _ _ B _ _ N _ _ _ V _ < _ _ _ _ _ _ _ _ _ _ _ _ _ _	Press Enter to select the logical key mode. <ul style="list-style-type: none"> The current IPL type is displayed. The current logical key mode is displayed. The current IPL speed is displayed with a pointer.
0 2 _ _ B _ _ N _ _ _ S _ < _ _ _ _ _ _ _ _ _ _ _ _ _ _	Use the Increment or Decrement buttons to scroll through the IPL speeds.
0 2 _	Press Enter to select the IPL speed and exit function 02.
0 1 _	Use the Increment or Decrement buttons to scroll through the control panel functions.

Function 03-Start IPL

The system enables function 03 only when the key mode is in manual and the system power is on.

This function starts an IPL of the selected IPL type when you press the Enter button. The system will load all the Licensed Internal Code.

Attention: The system does not perform a system shutdown before the IPL. The use of this function can cause loss of data.

Function 04-Lamp Test

This function shows whether any control panel indicators are burned out and whether characters that are displayed on the control panel *Function/Data* display are valid. When you activate this test, all the control panel lights and indicators flash on and off.

The lamp test continues on the system control panel until you perform another control panel function or a power procedure. The lamp test for the expansion unit control panel is active for 25 seconds and does not flash.

Use this procedure to verify that the lights on the system control panel are working correctly. If you cannot complete these steps, go to the "Starting Point for All Problems" in the Problem Analysis information for your system to start problem analysis.

1. Power on the system.
2. Press the Increment (^) or Decrement (V) buttons on the control panel to display Function 04. Press Enter on the control panel.
3. Do all of the lights and indicators on the system control panel flash on and off?

Yes Proceed to the next step.

No Exchange the control panel or the replaceable unit that contains the control panel function (system unit backplane (MB1) or tower card (CB1)). See "Removal and Installation Procedures" in the Problem Analysis information for your system.

4. Do all the control panel lights on the expansion unit come on?

Yes End.

No Exchange the control panel on the expansion unit.

The lights on the system control panel are working correctly.

Function 05-SPCN SRC

Function 05 displays information about power faults and provides informational reference codes during disk-unit concurrent maintenance procedures. The format for this function is as follows:

SPCN SRC formats

Formats
13, 17
Function IOP SRC

05	1RRU rrrr
----	-----------

RR = The frame number where the failing unit is installed
U = The SPCN port to which the failing unit is connected
rrrr = Unit reference code (URC)

RBAFH500-0

Function 07

Function 07 is only used during service by authorized IBM service representatives.

Function 08-Fast Power Off

Function 08 is enabled only when the key mode is in manual mode and the system power is on.

Use this function when the system is suspended and you cannot perform a power down.

The first time that you select function 08 and press Enter, the system displays an attention SRC, 11 A1xx 8008. This SRC indicates that you selected function 08. The second time that you select function 08 and press Enter, you confirm the request to power off. To perform a fast power off, see "Powering Off and Powering On the System" in the Problem Analysis information for your system.

Attention: No system shutdown is performed before the IPL. The use of this function can cause loss of data.

Attention: If the system password was changed at the most recent IPL, performing a fast power off might cause that new password information to be lost.

Functions 09 to 10-Reserved

These functions are reserved for future control panel operations.

Functions 11 to 19 - System Reference Code (SRC)

Functions 11 through 19, if enabled, represent the words of the SRC.

You should record SRC information for error reporting.

To use the SRC for problem analysis, go to the "Starting Point for All Problems" in the Problem Analysis information for your system.

Function 20-System Type, Model, Feature Code, Hardware Level, and IPL Path Description

This function displays the machine type, model, processor feature code, hardware level, and IPL path description in the following format:

```
t m m m c c c c _ _ _ _ _ _ _ _  
h h h h _ _ _ _ i i i i i i i i
```

Values for *t* indicate the machine type:

1	9401
2	9402
4	9404
6	4069

Values for *m* indicate the model:

mmm Model number (for example, 820)

Values for *c* indicate the system processor feature code:

cccc Processor feature code (for example, 23A4)

Values for *hhhh* indicate the system processor hardware level:

hhhh Processor hardware level (for example, 1025)

Values for *iiiiiii* indicate the description of the system power on or restart path:

iiiiiii The restart path description (for example, 00000001 indicates that the system was powered on by using the white button on the control panel).

You should record this information with the SRC.

Function 21-Make DST Available

This function makes DST available on the system console display. The *Use Dedicated Service Tools (DST)* display appears on the primary or alternative console.

To exit DST and return to the operating system, select the *Resume operating system display* option on the *Use Dedicated Service Tools (DST)* display.

Function 22-Dump Main Storage

This function dumps main storage and processor data to the disk.

Note: Prior to pressing function 22, determine whether function 34 is available (00 shows in the panel after you select function 34). If it is available, then the system is attempting to run a main storage dump IPL. Using function 34 attempts to retry the IPL such that the original dump is not lost. If function 34 is not enabled, (>FF shows in the panel after you select function 34), go back and start function 22.

The first time that you select function 22 and press Enter, the system displays attention SRC 11 A1xx 3022. This indicates that you selected function 22. To dump main storage and system processor data to the disk, you must select function 22 again and press Enter.

Use this function only when a main storage dump is necessary, for example, after a suspended (system hang) condition or after an operating system failure.

Attention: No system shutdown is performed before the main storage dump. The use of this function can cause loss of data.

Functions 25 and 26-Service Switches 1 and 2

In function 25, the service representative switch 1 is set. Function 25 is the first step necessary to set the service function range (50 to 99).

In function 26, the service representative switch 2 is set. Function 26 is the second step necessary to set the service function range (50 to 99).

Function 33-Reorder SPCN Addressing

This function puts the rack addresses in the correct order to show their position in the system power control network (SPCN). Use it when you have added racks to or removed them from the system.

Function 34-Retry MSD IPL

Function 34 is enabled only for main storage dump IPLs. You can use it when the system is hung during the (MSD) IPL to retry the IPL without losing the original dump information.

Extended control panel functions: The system enables service functions 50 through 70 when you select manual mode and enter function 25 (service switch 1), then function 26 (service switch 2). You use **subfunctions** with Functions 51 and 57 through 64.

Notes:

1. When a function has no data to display, FF is shown.
2. Some upper functions, 50 through 70, are not supported using the remote control panel and virtual control panel, depending on connectivity.
3. Non-supported functions for the remote control panel and virtual control panel display FF.

To enable functions 50 through 70:

1. Select function 25 and press Enter. The display reads 25 00.
2. Use the Increment button to select function 26 and press Enter. The display briefly reads 26 00. Then it usually displays 01 B when the upper functions have activated.

Functions 50 through 70 are now available.

You can disable the service functions by selecting and entering either function 25 (service switch 1) or function 26 (service switch 2).

To disable functions 50 through 70, select function 25 and press Enter. Functions 50 through 70 are then no longer available.

Using Subfunctions

To work with subfunctions, do the following:

1. Use the Increment or Decrement button to select the appropriate function and press Enter. The function number appears with asterisks (**); for example, 57**. The two asterisks indicate that subfunctions are available.
2. Press the Increment button. The first subfunction number appears; for example, 5700.
3. As the subfunction number is displayed, press Enter. The system displays data associated with the subfunction number.
4. Press the Increment button. The next subfunction number appears; for example, 5701.
5. As the subfunction number is displayed, press Enter. The system displays the data associated with the new subfunction number.
6. Repeat these steps to gather all the data that is associated with the subfunction.
7. Use the Increment or Decrement button to return to the function display with asterisks; for example 57**.
8. Press Enter to exit the subfunctions.

Function 50-System Processor Stop

This function stops the system processor.

Attention: This function might cause the system to end abnormally. Use only when directed by your next level of support.

Function 51-System Processor Status

This function displays the following values:

- Next instruction address (NIA)
- Current task dispatching element (TDE) address

The data can be displayed 8 digits at a time. Select and enter a subfunction number to display each word of data from 00 to 0F.

The following table is an example of a subfunction data display that shows NIA and TDE information.

Subfunction data display example

Function	Subfunction	Data Display
51	**	Subfunction mode entered
51	00, 01	NIA (8 bytes)
51	02, 03	Current TDE (8 bytes)

Function 52-System Processor Start

This function starts the system processor (after it has stopped).

Low-level debug panel functions 57 through 70: You can enable these functions by selecting manual mode and selecting Functions 25 and 26. The following is a list of all the low-level debug panel functions and a description of each:

Function 57 - Display Service Processor Diagnostic Data Area Addresses. These addresses can be used to display debug data in function 62.

Function 58 - Setting First Character of the Base Address for the Function 62 Display.

Function 59 - Setting Second Character of the Base Address for the Function 62 Display.

Function 60 - Setting Third Character of Address for Function 62 Display.

Function 61 - Setting Fourth Character of Address for Function 62 Display.

Function 62 - Display Service Processor Storage. This function displays service processor storage starting at the address that has been set with functions 58 through 61.

Function 63 - System Status SRC Trace. The system status SRC trace is a copy of the last 25 status SRCs (those that are usually associated with the IPL sequence or the power-off sequence). Enter a subfunction between hexadecimal 00 and 18 to look at the status SRCs in sequential order. The most recent SRC (the last status SRC) appears at subfunction hexadecimal 18.

Function 64-Diagnostic Status SRC Trace. The diagnostic status SRC trace is a copy of the last 25 status SRCs (those that are usually associated with the service processor function of problem analysis and main storage dump). Enter a subfunction between hexadecimal 00 and 18 to look at the status SRCs in sequence. You can see the most recent SRC (the last status SRC) at subfunction hexadecimal 18 and the extended SRC words for this SRC at subfunctions 19 through 1A.

Function 65-Deactivate Remote Service. Use this function to deactivate a remote service session or Operations Console. This function releases the communications port that was in use for a remote service session or Operations Console.

Function 66 - Activate Remote Service. Use this function to activate a remote service session or Operations Console. This function activates the communications port that is used by a remote service session or Operations Console.

Function 67 - Disk Unit IOP Reset/Reload. Function 67 is not available for all system types. Use this function to initiate an IOP dump and a disk unit IOP reset/reload. The function is enabled only when specific SRCs are displayed on the control panel and the associated IOP supports a reset/reload function.

Function 68 - Power off Disk Unit IOP/IOA Power Domain. Function 68 is enabled only by specific disk-unit system reference codes (SRCs) such as disk-unit attention SRCs.

Function 69 - Power on Disk Unit IOP/IOA Power Domain. Function 69 is enabled when the power domain is powered off.

Function 70 - Dump Service Processor Control Storage. This function saves the contents of the service processor control storage into nonvolatile storage for potential use from an error log.

Use remote control panel APIs: The remote control panel function of Operations Console provides a set of APIs (application program interfaces) that system administrators can use to control the server through programs. The APIs allow custom programs to interface with the system control panel and perform many common system control panel functions.

You can only use these APIs if you are using the remote control panel that is connected with the serial console cable. You cannot use these APIs with the virtual control panel or remote control panel connected with a parallel cable.

The interface to the remote control panel APIs is established through a standard TCP/IP socket connection. The socket connection can be implemented in any programming language that supports sockets on the Windows platform (Java, C/C++, Visual Basic to name a few).

To use the remote control panel APIs you need to follow these steps:

1. Start Operations Console with the remote control panel function.
2. From a custom program open a socket connection to port 2150 on the same PC.
3. Send a supported command from the set of commands that are described below.
4. Receive the byte stream that is sent back on the same socket connection.
5. Repeat steps 3 and 4 as necessary on the same socket connection.
6. Close the socket connection when done.

Your program will need to interpret the byte stream sent back from the server. The returned byte stream consists of a predefined format which is the same for all commands. The byte stream will be at least 4 bytes long. Some commands will return additional bytes.

The first two bytes (0 and 1) will return the command status, usually successful or unsuccessful. The next two bytes (2 and 3) will be a 16-bit number N, which tells how many additional bytes will follow these first 4 bytes. If N is nonzero, then there will be additional information in bytes 4 through 4 + N.. This information will be additional data related to the command, such as TRUE or FALSE.

Note: If the command sent is not one of the command strings defined below, then the return code in bytes 0 and 1 of the return value will be 32 (0x20). This means Command not Supported.

Your programs can perform the following control panel functions by using the following APIs.

System power and test APIs:

- Power on the system (PowerOn)
- Perform panel lamp test (DoLampTest)

- Clear panel lamp test (ClearLampTest)
- Power off the system (PowerOff)

IPL-related APIs:

- Set IPL mode to manual (SetIPLModeManual)
- Set IPL mode to normal (SetIPLModeNormal)
- Set IPL mode to auto (SetIPLModeAuto)
- Set IPL mode to secure (SetIPLModeSecure)
- Set IPL type to A (SetIPLTypeA)
- Set IPL type to B (SetIPLTypeB)
- Set IPL type to C (SetIPLTypeC)
- Set IPL type to D (SetIPLTypeD)
- Start an IPL (Start IPL)
- Set IPL speed to fast (SetIPLSpeedFast)
- Set IPL speed to slow (SetIPLSpeedSlow)
- Set IPL speed to system default (SetIPLSpeedDefault)

Other system function APIs:

- Start dedicated service tools (DST) on the primary or alternative console (StartDST)
- Start a main storage dump (StartMSD)
- Disable continuously powered main storage (CPM) (DisableCMP)

APIs that question system status:

- Is CPM present? (GetCPMPresent)
- Is CPM enabled? GetCPMEnabled
- Is the key inserted? (GetKeyInserted)
- Is the power on? (GetPowerOn)
- Is the attention light lit? (GetAttentionLight)
- Is system powered control network (SPCN) present? (GetSPCNPresent)
- Get the IPL mode (GetIPLMode)
- Get the IPL type (GetIPLType)
- Get the IPL speed (GetIPLSpeed)
- Get type information and model information (GetType&Model)
- Get the SPCN SRC if available (GetSPCNSRC)
- Get all SRCs 1 - 9 if available (GetSRCs)

Power on the system: To have your program power on the system, use the API **PowerOn** (use the uppercase and lowercase shown).

There are no restrictions on the use of this command.

This API returns the following information:

Bytes 0 and 1	Bytes 2 and 3	Bytes 4 through 4+N
16-bit return code 0 = Command successful 1 = Command unsuccessful	16-bit additional data length N = 0	N/A

Perform panel lamp test: To have your program perform the panel lamp test, use the API **DoLampTest** (use the uppercase and lowercase shown).

There are no restrictions on the use of this command.

This API returns the following information:

Bytes 0 and 1	Bytes 2 and 3	Bytes 4 through 4+N
16-bit return code 0 => Command successful 1 => Command unsuccessful	16-bit additional data length N = 0	N/A

Clear panel lamp test: To have your program clear the panel lamp test results, use the API **ClearLampTest** (use the uppercase and lowercase shown).

There are no restrictions on the use of this command.

This API returns the following information:

Bytes 0 and 1	Bytes 2 and 3	Bytes 4 through 4+ N
16-bit return code 0 => Command successful 1 => Command unsuccessful	16-bit additional data length N = 0	N/A

Power off the system: To have your program power off the system, use the API **PowerOff** (use the uppercase and lowercase shown).

To use this command, you must insert the keystick in the electronic keystick slot (on systems with a keystick).

This API returns the following information:

Bytes 0 and 1	Bytes 2 and 3	Bytes 4 through 4+ N
16-bit return code 0 => Command successful 1 => Command unsuccessful 2 => Key not inserted	16-bit additional data length N = 0	N/A

Set IPL mode to manual: To have your program set the system IPL mode to manual, use the API **SetIPLModeManual** (use the uppercase and lowercase shown).

To use this command:

- You must insert a key to use this command (on systems with a keystick).

This API returns the following information:

Bytes 0 and 1	Bytes 2 and 3	Bytes 4 through 4+N
16-bit return code 0 => Command successful 1 => Command unsuccessful 2 => Key not inserted	16-bit additional data length N = 0	N/A

Set IPL mode to normal: To have your program set the system IPL mode to normal, use the API **SetIPLModeNormal** (use the uppercase and lowercase shown).

To use this command:

- You must insert a key to use this command (on systems with a keystick).

This API returns the following information:

Bytes 0 and 1	Bytes 2 and 3	Bytes 4 through 4+N
16-bit return code 0 => Command successful 1 => Command unsuccessful 2 => Key not inserted	16-bit additional data length N = 0	N/A

Set IPL mode to auto: To have your program set the system IPL mode to automatic, use the API **SetIPLModeAuto** (use the uppercase and lowercase shown).

To use this command:

- You must insert a key to use this command (on systems with a keystick).

This API returns the following information:

Bytes 0 and 1	Bytes 2 and 3	Bytes 4 through 4+N
16-bit return code 0 => Command successful 1 => Command unsuccessful 2 => Key not inserted	16-bit additional data length N = 0	N/A

Set IPL mode to secure: To have your program set the system IPL mode to secure, use the API **SetIPLModeSecure** (use the uppercase and lowercase shown).

To use this command:

- You must insert a key to use this command (on systems with a keystick).

This API returns the following information:

Bytes 0 and 1	Bytes 2 and 3	Bytes 4 through 4+N
16-bit return code 0 => Command successful 1 => Command unsuccessful 2 => Key not inserted	16-bit additional data length N = 0	N/A

Set IPL type to A: To have your program set the system IPL type to A, use the API **SetIPLTypeA** (use the uppercase and lowercase shown).

To use this command:

- You must insert a key to use this command (on systems with a keystick).
- The system must be in manual mode.

This API returns the following information:

Bytes 0 and 1	Bytes 2 and 3	Bytes 4 through 4+N
16-bit return code 0 => Command successful 1 => Command unsuccessful 2 => Key not inserted 4 => Not in Manual mode	16-bit additional data length N = 0	N/A

Set IPL type to B: To have your program set the system IPL type to B, use the API **SetIPLTypeB** (use the uppercase and lowercase shown).

To use this command:

- You must insert a key to use this command (on systems with a keystick).
- The system must be in manual mode.

This API returns the following information:

Bytes 0 and 1	Bytes 2 and 3	Bytes 4 through 4+N
16-bit return code 0 => Command successful 1 => Command unsuccessful 2 => Key not inserted 4 => Not in Manual mode	16-bit additional data length N = 0	N/A

Set IPL type to C: To have your program set the system IPL type to C, use the API **SetIPLTypeC** (use the uppercase and lowercase shown).

To use this command:

- You must insert a key to use this command (on systems with a keystick).

- The system must be in manual mode.

This API returns the following information:

Bytes 0 and 1	Bytes 2 and 3	Bytes 4 through 4+ N
16-bit return code 0 => Command successful 1 => Command unsuccessful 2 => Key not inserted 4 => Not in Manual mode	16-bit additional data length N = 0	N/A

Set IPL type to D: To have your program set the system IPL type to D, use the API **SetIPLTypeD** (use the uppercase and lowercase shown).

To use this command:

- You must insert a key to use this command (on systems with a keystick).
- The system must be in manual mode.

This API returns the following information:

Bytes 0 and 1	Bytes 2 and 3	Bytes 4 through 4+N
16-bit return code 0 => Command successful 1 => Command unsuccessful 2 => Key not inserted 4 => Not in Manual mode	16-bit additional data length N = 0	N/A

Start an IPL: To have your program start a system IPL, use the API **StartIPL** (use the uppercase and lowercase shown).

To use this command:

- You must insert a key to use this command (on systems with a keystick).
- The system must be in manual mode.
- You must power on the system.

This API returns the following information:

Bytes 0 and 1	Bytes 2 and 3	Bytes 4 through 4+N
16-bit return code 0 => Command successful 1 => Command unsuccessful 2 => Key not inserted 4 => Not in Manual mode 16 => System powered Off	16-bit additional data length N = 0	N/A

Set IPL speed to fast: To have your program set the system IPL speed to fast, use the API **SetIPLSpeedFast** (use the uppercase and lowercase shown).

To use this command:

- You must insert a key to use this command (on systems with a keystick).
- The system must be in manual mode.
- You must power off the system.

This API returns the following information:

Bytes 0 and 1	Bytes 2 and 3	Bytes 4 through 4+N
16-bit return code	16-bit additional data length N = 0	N/A
0 => Command successful		
1 => Command unsuccessful		
2 => Key not inserted		
4 => Not in Manual mode		
8 => System powered On		

Set IPL speed to slow: To have your program set the system IPL speed to slow, use the API **SetIPLSpeedSlow** (use the uppercase and lowercase shown).

To use this command:

- You must insert a key to use this command (on systems with a keystick).
- The system must be in manual mode.
- You must power off the system.

This API returns the following information:

Bytes 0 and 1	Bytes 2 and 3	Bytes 4 through 4+N
16-bit return code	16-bit additional data length N = 0	N/A
0 => Command successful		
1 => Command unsuccessful		
2 => Key not inserted		
4 => Not in Manual mode		
8 => System powered On		

Set IPL speed to system default: To have your program set the system IPL speed to the default value, use the API **SetIPLSpeedDefault** (use the uppercase and lowercase shown).

To use this command:

- You must insert a key to use this command (on systems with a keystick).
- The system must be in manual mode.
- You must power off the system.

This API returns the following information:

Bytes 0 and 1	Bytes 2 and 3	Bytes 4 through 4+N
16-bit return code 0 => Command successful 1 => Command unsuccessful 2 => Key not inserted 4 => Not in Manual mode 8 => System powered On	16-bit additional data length N = 0	N/A

Start DST on the primary or alternative console: You can have your program start the dedicated service tool (DST) on the primary or alternative console. To do this, use the API **StartDST** (use the uppercase and lowercase shown).

To use this command:

- You must insert a key to use this command (on systems with a keystick).
- The system must be in manual mode.
- You must power on the system.

This API returns the following information:

Bytes 0 and 1	Bytes 2 and 3	Bytes 4 through 4+N
16-bit return code 0 => Command successful 1 => Command unsuccessful 2 => Key not inserted 4 => Not in Manual mode 16 => System powered Off	16-bit additional data length N = 0	N/A

Start a Main Storage Dump: To have your program start a main store dump, use the API **StartMSD** (use the uppercase and lowercase shown).

To use this command:

- You must insert a key to use this command (on systems with a keystick).
- The system must be in manual mode.
- You must power on the system.

This API returns the following information:

Bytes 0 and 1	Bytes 2 and 3	Bytes 4 through 4+N
16-bit return code 0 => Command successful 1 => Command unsuccessful 2 => Key not inserted 4 => Not in Manual mode 16 => System powered Off	16-bit additional data length N = 0	N/A

Disable CPM: To have your program disable the continuously powered main storage (CPM) on the system, use the API **DisableCPM** (use the uppercase and lowercase shown).

To use this command:

- You must insert a key to use this command (on systems with a keystick).
- The system must be in manual mode.
- You must power off the system.

This API returns the following information:

Bytes 0 and 1	Bytes 2 and 3	Bytes 4 through 4+N
16-bit return code 0 => Command successful 1 => Command unsuccessful 2 => Key not inserted 4 => Not in Manual mode 8 => System powered On	16-bit additional data length N = 0	N/A

Is CPM present?: You can have your program find out if the continuously powered main storage (CPM) is present on the system. To do this, use the API **GetCPMPresent** (use the uppercase and lowercase shown).

There are no restrictions on the use of this command.

This API returns the following information:

Bytes 0 and 1	Bytes 2 and 3	Bytes 4 through 4+N
16-bit return code 0 => Command successful 1 => Command unsuccessful	16-bit additional data length N N = size of ASCII return value (does not count end of string NULL)	True or False

Is CPM enabled?: You can have your program find out if the system has continuously powered main storage (CPM) enabled. To do this, use the API **GetCPMEnabled** (use the uppercase and lowercase shown).

There are no restrictions on the use of this command.

This API returns the following information:

Bytes 0 and 1	Bytes 2 and 3	Bytes 4 through 4+N
16-bit return code 0 => Command successful 1 => Command unsuccessful	16-bit additional data length N N = size of ASCII return value (does not count end of string NULL)	True or False

Is the key inserted?: To have your program find out if the system has a keystick inserted, use the API **GetKeyInserted** (use the uppercase and lowercase shown).

There are no restrictions on the use of this command.

This API returns the following information:

Bytes 0 and 1	Bytes 2 and 3	Bytes 4 through 4+N
16-bit return code 0 => Command successful 1 => Command unsuccessful	16-bit additional data length N N = size of ASCII return value (does not count end of string NULL)	True or False

Is the power on?: To have your program find out whether you have the system powered on, use the API **GetPowerOn** (use the uppercase and lowercase shown).

There are no restrictions on the use of this command.

This API returns the following information:

Bytes 0 and 1	Bytes 2 and 3	Bytes 4 through 4+N
16-bit return code 0 => Command successful 1 => Command unsuccessful	16-bit additional data length N N = size of ASCII return value (does not count end of string NULL)	True or False

Is the attention light lit?: To have your program find out if the attention light is on, use the API **GetAttentionLight** (use the uppercase and lowercase shown).

There are no restrictions on the use of this command.

This API returns the following information:

Bytes 0 and 1	Bytes 2 and 3	Bytes 4 through 4+N
16-bit return code 0 => Command successful 1 => Command unsuccessful	16-bit additional data length N N = size of ASCII return value (does not count end of string NULL)	True or False

Is SPCN present?: You can have your program find out if the system powered control network (SPCN) is present on the system. To do this, use the API **GetSPCNPresent** (use the uppercase and lowercase shown).

There are no restrictions on the use of this command.

This API returns the following information:

Bytes 0 and 1	Bytes 2 and 3	Bytes 4 through 4+N
16-bit return code 0 => Command successful 1 => Command unsuccessful	16-bit additional data length N N = size of ASCII return value (does not count end of string NULL)	True or False

Get the IPL mode: To have your program find out the system IPL mode, use the API **GetIPLMode** (use the uppercase and lowercase shown).

There are no restrictions on the use of this command.

This API returns the following information:

Bytes 0 and 1	Bytes 2 and 3	Bytes 4 through 4+N
16-bit return code 0 => Command successful 1 => Command unsuccessful	16-bit additional data length N N = size of ASCII return value (does not count end of string NULL)	Manual or Normal or Auto or Secure

Get the IPL type: To have your program find out the system IPL type, use the API **GetIPLType** (use the uppercase and lowercase shown).

There are no restrictions on the use of this command.

This API returns the following information:

Bytes 0 and 1	Bytes 2 and 3	Bytes 4 through 4+N
16-bit return code 0 => Command successful 1 => Command unsuccessful	16-bit additional data length N N = size of ASCII return value (does not count end of string NULL)	A or B or C or D

Get the IPL speed: To have your program find out the system IPL speed, use the API **GetIPLSpeed** (use the uppercase and lowercase shown).

There are no restrictions on the use of this command.

This API returns the following information:

Bytes 0 and 1	Bytes 2 and 3	Bytes 4 through 4+N
16-bit return code 0 => Command successful 1 => Command unsuccessful	16-bit additional data length N N = size of ASCII return value (does not count end of string NULL)	Slow or Fast or V=Slow or V=Fast NOTE: The responses with "V=" indicate the default IPL speed.

Get type and model information: To have your program find out the system type and model numbers, use the API **GetType&Model** (use the uppercase and lowercase shown).

There are no restrictions on the use of this command.

This API returns the following information:

Bytes 0 and 1	Bytes 2 and 3	Bytes 4 through 4+N
16-bit return code 0 => Command successful 1 => Command unsuccessful	16-bit additional data length N N = size of ASCII return value (does not count end of string NULL)	ZZZZZZZZ (ASCII string with type and model information.)

Get the SPCN SRC: To have your program return the system powered control network (SPCN) SRC, if available, use the API **GetSPCNSRC** (use the uppercase and lowercase shown).

There are no restrictions on the use of this command.

This API returns the following information:

Bytes 0 and 1	Bytes 2 and 3	Bytes 4 through 4+N
16-bit return code 0 => Command successful 1 => Command unsuccessful	16-bit additional data length N N = size of Hex return value (does not count end of string NULL)	0x'XXXXXXXX' NOTE: Hex return data will be 4 bytes available by SRC

Get all SRCs 1 - 9: To have your program return all the SRCs in word 1 through word 9, if available, use the API **GetSRCs** (use the uppercase and lowercase shown).

Note: On V4R4 and earlier systems, words 1 through 9 correspond to functions 11 through 19.

There are no restrictions on the use of this command.

This API returns the following information:

Bytes 0 and 1	Bytes 2 and 3	Bytes 4 through 4+N
16-bit return code 0 => Command successful 1 => Command unsuccessful	16-bit additional data length N N = size of Hex return value (does not count end of string NULL)	0x'XXXXXXXX' NOTE: Hex return data will be 4 bytes available by SRC

System Values That Control IPL

The system values listed below let you control the type of (initial program load) IPL and the way the system does an IPL. Change these system values using option 2 (Change) on the Work with System Values (WRKSYSVAL) display.

QIPLDATTIM

The IPL date and time system value lets you specify the IPL date and time for starting the system automatically. The default value *NONE indicates that no timed automatic IPL is desired.

You can set this system value independently in each partition. If the primary partition is powered down at the time an automatic IPL should occur in a secondary partition, the IPL will not occur. When the primary partition does IPL, the secondary partition is IPLed if its IPL date and time is past due. The secondary partition will not IPL if it is configured with an IPL action of hold.

The date format used by your system for date and time is defined in the system value QDATFMT. You need to know your system date format for step 1. Use option 5 (Display) to determine the format.

To specify the IPL date and time:

1. Type the new date over the current date as follows:

- MM/DD/YY where MM is the month, DD is the day, and YY is the year.
For example, to start the system on June 26, 1997, type 06/26/97.
- YY/MM/DD where YY is the year, MM is the month, and DD is the day.
For example, to start the system on June 26, 1997, type 97/06/26.
- DD/MM/YY where DD is the day, MM is the month, and YY is the year.
For example, to start the system on June 26, 1997, type 26/06/97.
- YY/DDD where YY is the year and DDD is the Julian date.
For example, to start the system on June 26, 1997, type 97/178. June 26 is the 178th day of the year.

Note: The format is set with the system value QDATFMT. The separator is set with the system value QDATSEP. The separator is optional.

2. Type the time in the format HH:MM:SS where HH is the hour, MM is the minute, and SS is the second. Use the 24-hour clock.

For example, if you want to start the system at 8:16 a.m., type **08:16:00** , or if you want to start the system at 8:16 p.m., type **20:16:00** .

Note:

1. The time separator format is set with the system value QTIMSEP. The separator is optional.
2. If you are using the automatic power schedule, you can force the power schedule to update the QIPLDATTIM system value by entering the following command on any command line.

```
CHGPWRSCDE DAY(*TODAY) PWRONTIME(*SAME) PWROFFTIME(*SAME)
```

QIPLSTS

The IPL status system value displays the way the system did the last IPL. You cannot change this system value. Use option 5 (Display) on the Work with System Values display to display it.

0	An IPL from the control panel of the system unit or from dedicated service tool (DST) for a secondary partition.
1	An unattended IPL automatically after a power failure (QPWRRSTIPL set to 1).

2	An unattended IPL after using the Power Down System (PWRDWNSYS) command with the Restart after power down (RESTART) parameter set to *YES.
3	A unattended scheduled IPL (QIPLDATTIM set to the date and time for the IPL to occur).
4	An unattended remote IPL from another location (QRMTIPL set to 1).

QIPLTYPE

The IPL type system value defines the type of IPL the system does from the control panel.

0	An unattended IPL. Start the system without an operator (see Normal Operations (Unattended IPL)). If the mode is set to Manual, an attended IPL is performed instead.
1	An attended IPL with Dedicated Service Tools (DST) Start the system with an operator (see Changing Your System During IPL (Attended IPL)). An unattended IPL is done if it is done remotely, by date and time, or after power failure.
2	An attended IPL in debug mode. Start the system with an operator. The console description, QCONSOLE, is left varied on. You should only use this for problem analysis because it prevents other devices on the work station controller from being used.

QPWRRSTIPL

The automatic IPL system value allows the system to start automatically when power is restored after a power failure. On a partitioned system, change this system value from the primary partition only. The QPWRRSTIPL system value controls only the primary partition.

The IPL action configuration value for the secondary partition determines whether a secondary partition will IPL at the same time as the primary partition. For details on configuring logical partitions on your iSeries server, go to Planning and Setting Up under the Logical Partitions topic in the iSeries Information Center.

0	Does not do an automatic IPL after a power failure.
1	Does an automatic IPL after a power failure.

QRMTIPL

The remote IPL system value allows you to start the remote system by using your telephone and a modem or the SPCN signal.

0	Does not allow a remote IPL.
1	Allows a remote IPL.

Note: If you are using a modem eliminator, your system will power up every time PWRDWN SYS RESTART(*NO) is issued.

QUPSDLYTIM

The uninterruptible power supply delay time system value controls the length of time the system will wait, before saving main storage and power down the system. If utility power is restored before the time ends, the system ends the timer. If the timer ends first, the system begins to save main storage or goes into CPM.

On a partitioned system, change this system value from the primary partition only.

There are three choices for the QUPSDLYTIM value.

*BASIC or *CALC	The default value for QUPSDLYTIM is *CALC. Leaving QUPSDLYTIM set to *CALC may defeat the purpose of having a UPS. *BASIC or *CALC provide the same function in systems using PowerPC ^(R) technology. After a fixed interval delay (typically 45 seconds), high end systems enter CPM, while entry systems equipped with a UPS perform a controlled shutdown. Users with a UPS who prefer a shorter IPL may wish to use a numeric value.
*NOMAX	*NOMAX is used when a user supplied program is controlling the power down of the system or a generator is providing unlimited UPS power.
0	Automatic system power down when the system utility power fails.
1 — 99999	Specifies delay time in seconds before the system powers down.

See the Uninterruptible power supply delay time system value (QUPSDLYTIM) for more detailed information about QUPSDLYTIM.

QUPSMMSGQ

The uninterruptible power supply message queue system value allows you to specify where you want your messages sent when the power to the system is interrupted.

Note: The SCPF job clears the message queue specified for the system value QUPSMMSGQ.

QSYS/QSYSOPR

This sends the messages to the system operator's message queue when power to the system is interrupted.

message queue	Specifies another message queue (in addition to the system operator's message queue) where messages are sent when power to the system is interrupted.
----------------------	---

library	Specifies the library where the other message queue is located.
----------------	---

OS/400 concepts

OS/400 is the operating system for the iSeries servers. It manages hardware and software resources, and provides an interface that allows you to work with iSeries server. To best use OS/400, you should be familiar with the following system concepts.

Operation concepts

Messages

Messages are communications sent from another user, OS/400 or an application. Learn about the different kinds of messages and how to interpret and respond to them.

OS/400 commands

OS/400 uses Control Language (CL) commands to interpret instructions from users. Learn the basic rules for using CL, and how to get detailed help for any CL command.

Security and user authority

OS/400 determines which resources a user may access based on information in their user profile and the security strategy implemented for this system. Learn about security settings and how to manage user authorities efficiently.

Files and file systems

OS/400 stores and tracks data differently than other operating systems. However, the integrated file system (IFS) in iSeries Navigator provides a familiar method for accessing and manipulating files on the iSeries server. Learn about the IFS, and how to use it.

Basic work management

Jobs

All work done by the iSeries server is divided into units called jobs. Learn about the types of jobs, and how to find, monitor, and work with them on the iSeries server.

Subsystems, queues, and memory pools

Control work on iSeries servers by manipulating the resources used to process jobs.

Objects

Everything on the system that can be worked with is considered an object. Objects provide a common interface for working with system components. Learn about the different kinds of objects and how to work with them.

System maintenance

Logs and journals

Record keeping is an important way for the iSeries to protect data and track system problems. Learn what logs and journals are for and how to use them.

Software fixes

Recent versions of iSeries software add functions and solve known problems. Learn how to install and manage software and software updates.

Additional reference information can be found in the IBM glossary.

Messages

Messages are communications that are sent from a person, program or the iSeries server to a message queue. Every user profile and workstation has a message queue associated with it. All message queues are named after the user or workstation they are associated with, and get created automatically when the user signs onto the system for the first time, or when the workstation is first defined. The message queue for the QSYSOPR profile is particularly important, because the iSeries server sends many messages about job completion and system status there. For more information, see Message queues.

Work with messages

iSeries Navigator allows you to display, reply to, and send messages. To work with messages, expand **Basic Operations**, and click on **Messages**. iSeries Navigator displays all the messages for either your message queue, or the message queue associated with the Workstation. To reply to or view the details for a specific message, right click on the message and select the desired action. To send a message, right-click on **Messages** in the iSeries Navigator hierarchy, and select **Send a message**.

Also, your system administrator can set up a message monitor in Management Central to watch for and handle messages. For an example, see Scenario: Message monitor.

OS/400 commands

OS/400 control language (CL) provides a powerful and flexible means of entering commands on the iSeries server. You can use CL to control most of the iSeries functions by entering them from the character-based interface, including them in programs, or by sending commands in iSeries Navigator. While the iSeries menu system and CL commands may be unfamiliar at first, they follow an easy-to-use syntax, and OS/400 includes many features to help you use them successfully. The CL topic includes a complete CL reference and a CL finder to look up specific CL commands.

CL command syntax

CL commands consist of a verb, an OS/400 object, and sometimes an adjective. For example: **WRKACTJOB**

Verb	Adjective	Object
WRK	ACT	JOB
Work	Active	Job

One of the important features of CL syntax is that it is consistent. For example, regardless of the object or command you want to work with, using the verb **WRK** in the command will bring up a menu allowing you to perform the available actions on the specified object. See Commands operating on OS/400 objects for a reference of common commands.

Entering CL commands

You can enter CL commands from iSeries Navigator by selecting **Run a command** from the task pad. Alternatively you can enter CL commands from any command line and most displays on the iSeries character-based interface. See Using the character based interface for more information about working with this interface and the OS/400 menu structure.

Every command has a set of required and optional parameters. For example, **CRTLLIB** (Ccreate Library) requires, at a minimum, that you specify the name of the library you would like to create. The syntax for more complex CL commands is: command name parameter, value. For example, **CRTLIB LIB(FRED)** enters the verb "create," on the object type "library," and specifies that the required parameter **LIB**, the library name, should have the value "FRED." This command would cause OS/400 to create a library called FRED.

If you are not already familiar with the parameters associated with a CL command, you can simply enter the command with the parameters you already know, place the cursor on the command, and press **F4**. OS/400 then displays the available options for the command. Entering a command without any parameters also causes the system to prompt you for any required fields, making field-level help available. For example, entering **CRTLIB** causes OS/400 to display the following display:

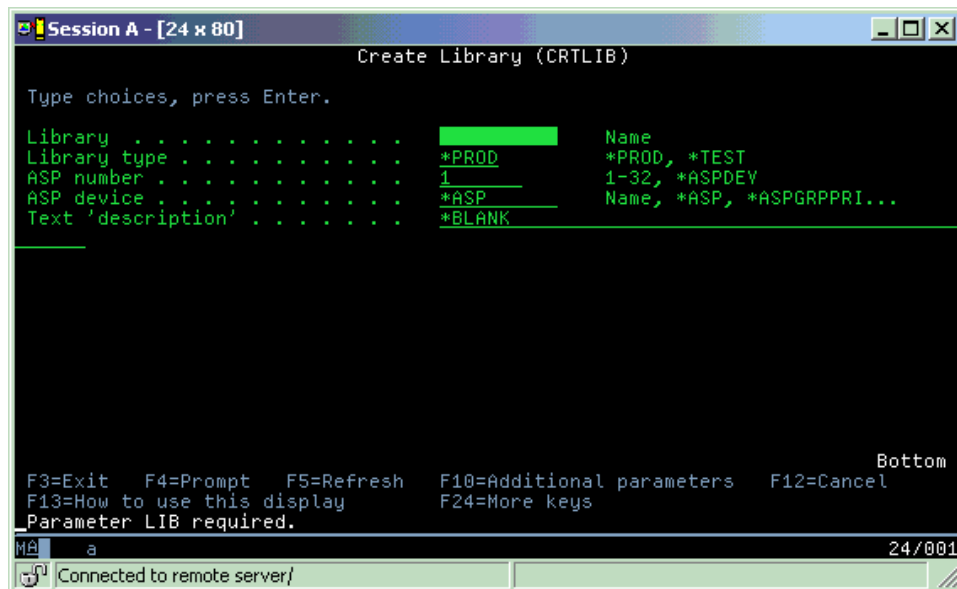

Entering a ? in any field brings up detailed help for that parameter.

Getting help with CL commands

OS/400 provides several methods for helping users access and enter CL commands. The Command Entry program provides a useful interface and additional help. You can start this program by entering **CALL QCMD** from a command line. The CL finder in the Information Center can also help you find a specific command. Most importantly, remember that entering a command without any parameters, or pressing **F4** (Prompt) while your cursor is over the command, displays a menu with detailed help for all associated parameters.

Security and user authority

Security is a critical piece of iSeries operations. It is built into OS/400, and impacts nearly every function on the system. The iSeries security environment determines the commands and functions available to users, and the objects they may access.

Usually the security strategy restricts the objects a user can access. For systems with object-level security, there are several ways to provide authority to access to objects. Often, user profiles will explicitly grant types of access to specific objects. To simplify the task of managing all these permissions, authorization lists can specify groups of objects, and users can be given access to these list. Accessing these lists then provides access to all of the objects the list specifies.

The level of iSeries server security, and other more detailed security practices, often impact system operations. The following concepts are important for understanding user requirements in various security environments.

Security levels

OS/400 operates in one of several predefined levels of security. The security level currently in effect determines the level of detail user profiles must provide in order to grant appropriate access to

system resources. This level of detail may range from simple password management to explicitly providing a level of access to each object a user may read or change.

Security system values

Many more detailed aspects of system security are set by iSeries system values. These system values set the iSeries security level, and grant or restrict options like adopted authority.

User profiles

The iSeries user profile contains most of the authorizations and preferences for individual users or groups. iSeries Navigator allows you to create and manage users and groups across the iSeries server.

Authorization lists

Granting each user authority to every separate object they need access to can be time-consuming and complex. You can simplify this process by creating authorization lists that specify groups of objects. Users and groups can then be authorized to this list, granting them authority to everything that list contains.

For more information about iSeries security, refer to Basic system security and planning. Also, security settings regarding policies and authorization lists are available in iSeries Navigator under **Security**.

Authority to access objects

Depending on the security level and other security settings, users may be given several levels of access to objects on the system.

Access	Description
All Object	Grants unrestricted access to every object on the system.
Object	Grants access to specified objects.
Object data	Grants access to the data contained in specified objects.
public	Grants default access to public objects

For example, a user needs authorization to add, change and delete data in a database, but does not need to delete tables or the database itself. He or she could be granted **object data** level authority, rather than **object level** authority.

Note:

Adopted authority will grant users access to objects called by an object they are working with. Administrators can allow or restrict adopted authority with security system values.

Security levels

Security on your system is arranged in a series of levels or classes, each offering a greater degree of security and protection of your data than the previous. Select the level that best meets the needs of your organization.

You can use iSeries Navigator to change these settings on a single system, and Management Central to alter them across multiple systems.

Level 20

This level is referred to as password security. That is, users must have a password and user ID that is recognized by your system in order to gain access to the system. Both the user ID and initial password are created for users by the system administrator.

This level of security offers all users on the system total authority to do anything they want. That means they can access all data, files, objects, and so on, on your system. This may be appropriate for small businesses where internal security is a low priority, but would likely be inappropriate for larger businesses that do not want every employee to be able to access confidential payroll files, for example.

Level 30

This level is referred to as resource security. That is, users must have a valid user ID and password defined for them by the system administrator, and no longer have automatic access to everything on the system. User access is limited by the security policies of the business.



Level 40

This level is referred to as system integrity security. That is, at this level, the system itself is protected against users. User-written programs cannot directly access the internal control blocks through pointer manipulation.

Level 40 is the default security level for every new installation.

Level 50

This level is referred to as enhanced system integrity security. Level 50 is the recommended level of security for most businesses, because it offers the highest level of security currently possible. Not only is the system protected against user-written programs, but it ensures that users only have access to data on the system, rather than information about the system itself. This offers greater security against anyone attempting to learn about your system.

For more information about system security settings, refer to the security Tips and Tools  manual, and the Security Reference  guide.

User profiles

User profiles contain the information the iSeries server requires to allow users to sign on to a system, to access their own customized session, including their own message and output queue, and to access functions and objects to which they have been granted authority.

A user profile includes:

- A system user profile name
- The user's privileges and limitations
- A list of objects the user owns or is authorized to use
- A reference to a message queue
- A reference to an output queue
- Information about which groups the user is a member of (up to 16)
- Information on the user's last sign on
- Job attributes, such as description and priority, the initial program to call, and the initial library list
- National language settings
- Other attributes, such as the user id (UID), group ID (GID), and home directory

User profiles may be included in group profiles. In this way, all group members share attributes, share access to specific objects, and share ownership of objects. Group profiles can simplify many user administration tasks by allowing you to apply a single change to many users.

Management Central's user administration function provides convenient ways to manage users and groups across the iSeries system. For specific security recommendations on creating profiles, refer to Planning user profiles and Planning user groups.

Working with user profiles

iSeries Navigator allows you to create and manage user profiles and groups if your own profile has the required authority. Expand **Users and groups** to create and manage user profiles. Additionally, this function allows you to perform some common actions on a selected user, such as sending a message, and working with their jobs and objects.

Authorization lists

Providing each user with explicit access to every object they need to work with would create a great deal of duplicated effort, since many users need to access the same group of objects. A much easier way to provide this access is to create authorization lists. Authorization lists consist of a list of users or groups, the type of authority (use, change, and exclude) for each user or group, and a list of objects that this list provides access to.

To work with authorization lists, open **Security** in iSeries Navigator and select **Authorization lists**.

For example, an authorization list can be created to contain a list of objects related to an inventory database. A user responsible for ordering new inventory items could be granted authority to see the contents of the database objects. Additionally, a user group in shipping and receiving needs to update this database as parts come in and out of stock. This group can have authority to modify the contents of the objects.

Files and file systems

Files in OS/400 are significantly different from their counterparts in UNIX or Windows. In OS/400, a file is another kind of object on your system. Each file has a description that describes its characteristics and how the data associated with the file is organized. Whenever OS/400 processes a file, it uses this description.

In addition to differences in handling files, OS/400 also uses unique structures to store the files and other objects on the system. However, the integrated file system (IFS) in iSeries Navigator will look familiar to people who are used to a Windows-based hierarchy. UNIX users will recognize some elements of this hierarchy, as well as the presence of file pointers.

Work with the integrated file system (IFS)

You can access the IFS in iSeries Navigator. The IFS will allow you to find, change, and copy files and libraries on your system by navigating through a hierarchy that is similar to Windows Explorer. You can use the IFS to copy data files onto your client PC.

For more information about how to use files and the integrated file system, refer to File systems and management.

Jobs

Jobs are how OS/400 organizes, tracks and processes work. A job typically includes all of the information the system requires to complete a specific task. This information may include data files, programs, and instructions for processing and tracking the job throughout its execution. Jobs vary greatly in their complexity, ranging from simple tasks like printing a specified document to complex procedures like generating reports based on information spread throughout the iSeries server. Tracking and managing jobs on the iSeries is an important part of normal system operation.

Jobs are an essential part of iSeries work management. To learn more about how jobs are processed, including working with subsystems and job queues, refer to Structure of your system. For an example of how jobs move through the iSeries server, refer to A job's life.

Work with jobs

You can work with jobs in iSeries Navigator. **Jobs** under **Basic Operations** displays all the jobs associated the current user. To display other jobs, right-click on the jobs container, and select **Properties**. From the Properties panel, you can choose which jobs to display. Alternately, you can see the jobs submitted by the iSeries server by clicking Server jobs, or the jobs currently being processed by clicking Active jobs. The following display shows the jobs display in iSeries Navigator.

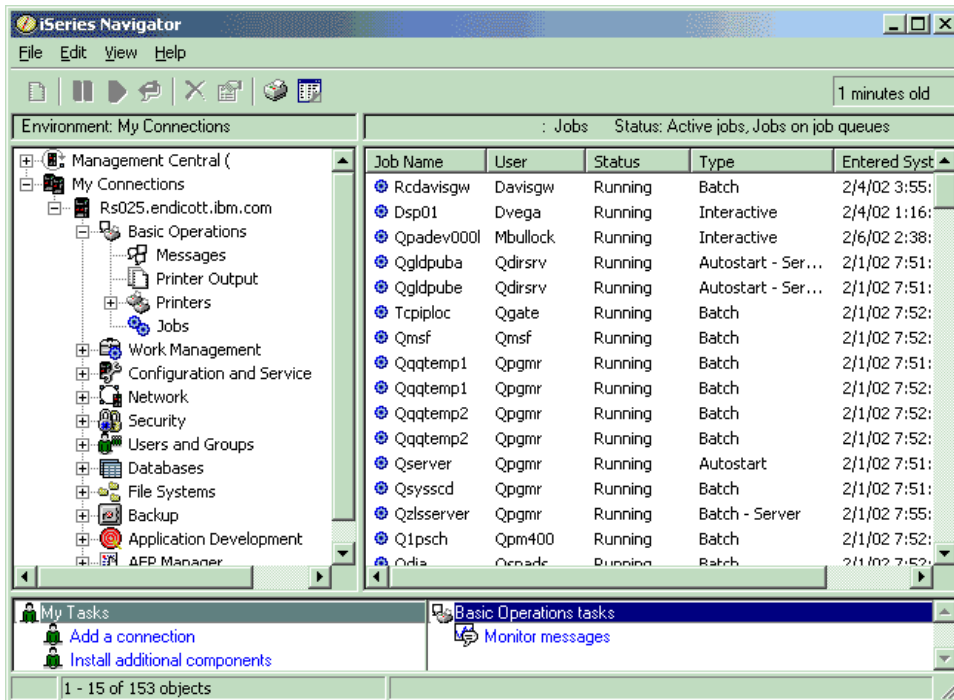

After finding the jobs want to work with, you can display their attributes or change their queue, priority, messages, and other features by right-clicking on the job and selecting **properties**. For more information about working with the jobs on your system, refer to Managing jobs. Additionally, your system administrator may decide to setup a job monitor to work with some jobs. For more information, refer to Create a job monitor.

Subsystems, queues and memory pools

Subsystems, queues and memory pools are the basic pieces of iSeries work management. Working with subsystems and queues to manage specific jobs or to adjust the system’s work flow are important system operations.

To efficiently use system resources, different types of jobs require different processing instructions and system resources. To meet this need, OS/400 creates unique operating environments called subsystems. Each subsystem has a set of system resources, especially a memory pool, that determine how quickly it can process jobs. Subsystems also have unique processing instructions and at least one associated job queue. The job queues hold incoming jobs from the users or applications until an associated subsystem has available resources. The job then moves from its queue into the subsystem where it is processed based on the instructions and resources available to that subsystem. Finally, any output that results from job processing gets handled and routed according to the instructions in the job description. For a description of how work moves through the iSeries server, refer to Structure of your system. For an example of how jobs move through the iSeries server, refer to A job’s life.

During this process, you may want to monitor a job’s progress or adjust it’s priority. Also, if the iSeries server is having trouble processing certain types of jobs, you may need to adjust the subsystems resources.

Work with subsystems, queues and memory pools

iSeries Navigator allows you to display and change subsystems and their associated job queues and memory pools. These functions are available under **Work Management** in iSeries Navigator. However, some subsystem commands are only available from the character-based interface.

For a detailed description of subsystems on the iSeries server, refer to Subsystems in the Work Management topic. For more information about working with subsystems, see Manage subsystems.

Objects

One of the differences between iSeries servers and other platforms is the concept of objects. Anything that you can change in OS/400 is a type of object. For example, data files, programs, libraries, queues, user profiles, and device descriptions are all types of objects. By treating everything as an object OS/400 can provide all of these items with an interface that defines what actions users may perform, and how OS/400 should treat the encapsulated data. Additionally, this interface allows for standardized commands across very different system elements; the commands for working with user profiles and data files are similar.

One important type of object is a library. Libraries are essentially containers, or organizational structures for other objects, and you can use them to reference other objects on your system. Libraries may contain many objects, and may be associated with a specific user profile or application. The only library that may contain other libraries is called QSYS. It contains all other libraries on the system.

There are many different types of objects in OS/400. You will need to understand how to find objects and how to perform actions on them are a basic function of system operations. For a more detailed description of object types and their default locations, refer to OS/400 objects. For a description of the commands used to work with objects, refer to Commands operating on OS/400 objects.

Log and journals

Protecting the data and resources on the iSeries server is a critical part of OS/400. One important way the iSeries servers accomplish that goal is to keep detailed records of any changes to system resources. These records, called logs or journals, can help solve system problems or recover damaged data.

Logs

A log is a database file that contains the history of backup, archive, recovery, and media management operations that may be displayed online or printed for future reference. Logs are used in backup and recovery situations. Logs can also contain information about jobs and problems.

For more information about logs, refer to:

Log	Description
Job logs	Track the description, status, and action of jobs performed by the system.
History logs	Get general system information, like device changes, operator messages, job completion and other activities.
Problem logs	Retrieve records of system problems that occurred on an iSeries system.

Journals

A journal is a system object that contains information about changes made to another system object, such as a database or a security-related object. The journal can be used to recover a database. Regular journaling speeds up database management tasks such as save operations.

For more information about journaling, refer to:

Software fixes

The operating system for the iSeries server is OS/400. IBM supports several different releases of OS/400, and businesses may have several iSeries servers running different versions. This may cause some system operations to be more complex; different versions of OS/400 may contain new or changed functions and features. Moreover, IBM provides updates to the operating system and other programs between releases in sets of program temporary fixes (PTFs). The PTFs that have been applied to an iSeries server may also affect system operations. Fortunately, Management Central provides ways to manage the software and fixes across a business.

For more information, including finding and applying fixes, refer to iSeries software and licensed programs. For immediate access to current iSeries PTFs, refer to the IBM service document Fix maintenance strategy .

Analyze and report system problems

iSeries server problems are carefully tracked and managed in OS/400. Familiarity with this process, and the ability to perform basic troubleshooting and problem handling procedures, are a basic part of iSeries server operations. For an overview of iSeries problem management, refer to How your server manages problems.

Once OS/400 detects a problem, it will generate a problem record and send a message to the system operator message queue, QSYSOPR. For help with analyzing, resolving and reporting these problems, or ones you've identified yourself see:

- Analyze a new problem
- Reporting system problems

For more information about resolving problems on the iSeries server, and for help contacting and working with IBM service, refer to Troubleshooting and service.

Analyze a new problem

A new problem is one that you detect while using the system and which has not been recorded in the problem log, or one that is in the problem log with a status of opened.

If the system is logically partitioned, references to the system, system console, displays, system commands, and system values are relative to the partition having a problem. When reporting problems electronically, use the same contact information for each partition on the system.

To analyze a new problem that has not been recorded in the problem log:

1. Use the Analyze Problem (ANZPRB) command.
2. Select the option that most closely corresponds to the problem you have encountered on the Analyze a New Problem display. A series of steps then guides you through problem analysis. As you progress, a symptom string is built from your responses.

If you encounter the Problem Analysis display while you are building your symptom string, contact IBM service before continuing. See Getting help with problems for more information on who to call.

3. When you complete problem analysis, the collected information is placed in the problem log.

To analyze a problem that has been recorded in the problem log with opened status:

1. Type **DSPMSG QSYSOPR** on any command line and press **Enter** to see the system operator messages.

- If the message is highlighted, use option 5 (Display details and reply) for the message. On the Additional Message Information display, press **F14** (Work with problem).
 - If the message has an asterisk (*) next to it, press **F14** (Work with problem) on the Display Messages display.
2. Select option 8 (Work with problem), and then option 1 (Analyze problem). As you progress through problem analysis, a symptom string is built from your responses.
 3. When you complete problem analysis, the collected information is placed in the problem log.

You can also use the following method to analyze a problem with open status in the problem log:

1. Enter the Work with problem (WRKPRB) command on any command line.
2. Select option 8 (Work with problem) for the problem, and then option 1 (Analyze problem).

Getting help with system operation problems

The following table shows an overview of the system support structure and gives you guidelines on who to call for your specific problem. Before calling for help, fill out the appropriate problem summary form. Your service representative may need the information you have filled in to further analyze the problem.

For up-to-date contact information, visit the IBM web site. 

Then, print this page and use information from the site to complete the table below. Refer to the page whenever you need contact information.

Type of Problem	Call	Telephone Numbers
Question <ul style="list-style-type: none"> • Advice • Migrating • "How to" • Operating • Configuring • Ordering • Performance • General information 	<ul style="list-style-type: none"> • IBM iSeries Support Line or IBM Business Partner • iSeries Marketing Specialist or IBM Direct Support Line or IBM Business Partner 	<ul style="list-style-type: none"> • 1-800-237-5511 • 1-800-IBM-CALL • 1-800-IBM-4YOU
Software <ul style="list-style-type: none"> • Fix information • Operating system problem • IBM application program • Loop, hang, or message 	IBM Software Service	1-800-237-5511
Hardware <ul style="list-style-type: none"> • IBM system hardware broken • Hardware system reference code (SRC) • IBM input/output (I/O) problem • Upgrade 	IBM Hardware Service	1-800-IBM-SERV

Reporting hardware and software problems

For hardware failures that do not disable system operation, electronic customer support provides a fast, electronic method for requesting the assistance of an IBM service representative with replacement parts. Using this method, you may report failures occurring on your system and selected input or output devices.

For problems with software or Licensed Internal Code, you should notify the IBM service system of the failure and related symptoms. The problems that are detected by the system can be reported either manually or automatically. The system searches a file of known problems and, if available, sends a fix to your system for installation.

If a problem is new, a problem management record (PMR) is created by the IBM service system. The PMR number is returned to your iSeries system. Depending on your contract with IBM, you may or may not be entitled to voice support (telephone). If you have voice support, IBM service center personnel will contact you, if requested, and work with you to resolve the problem. If you do not have voice support, you may view the service centers response by using the Query Problem Status (QRYPRBSTS) command. For more information on the QRYPRBSTS command, see Querying problem status.

To send a service request or log a problem, go to one of the following:

- Sending a service request immediately
- Sending a service request later
- Reporting problems by voice
- Adding notes to your problem record

For information on how to find a problem, see Finding a previously reported problem.

Manually report problems

The system problem log allows you to display a list of all the problems recorded on the system. You can also display detailed information about a specific problem. For example, you can see the product type and serial number of the device that had the problem, the date and time of the problem, the part that failed, where the part is found, and the problem status. You can also analyze and report a problem, or determine any service activity.

To report a problem that has an entry in the problem log, do the following:

1. Type **WRKPRB** on any command line and press **Enter**. The Work with Problems (WRKPRB) display appears.
2. If you have a problem ID, look for an entry with the same ID on the Work with Problems display. Select option 8 (Work with problem) for the problem you want to work with. Press **Enter** and the Work with Problems display appears.
3. Select option 2 (Report problem) on the Work with Problems display. Press **Enter** and the Verify Contact Information display appears.
4. To change any fields that appear on the Verify Contact Information display, type over the current information and press **Enter**. The system includes the new information in the service request.
5. Select the severity level that closely relates to the severity of the problem on the Select Problem Severity display.
6. Select who should receive and process your request on the Select Service Provider display.
7. Select when and how you want to send the service request on the Select Reporting Option display.

Automatic problem reporting

The automated problem analysis function runs problem analysis routines automatically when the system detects a problem. The problem reporting function notifies the service provider of the software problem. To run these functions, the appropriate service attributes must be set to *YES. If these attributes are set to *NO, you will need to run the problem analysis manually. The default value for service attributes is *NO.

Use the Display Service Attribute (DSPSRVA) command to display the service attributes, or use the Change Service Attributes (CHGSRVA) command to change the service attributes.

To change service attributes, fill in the appropriate information in the fields. Specify *YES in the Analyze problem field to automatically run problem analysis at the time of the failure. Problem analysis includes programs that attempt to isolate or correct the problems. Automated problem analysis applies mostly to hardware problems, and some software problems in Licensed Internal Code. To determine which problems are analyzed automatically and which ones are not, use the Work with Problem (WRKPRB) command. If the status is Opened, it indicates that the problem has not been analyzed. For problems that are not analyzed automatically, you can use the Work with Problems (WRKPRB) command to run the problem analysis manually.

When *YES is specified in the Report problem automatically field, software problems are reported automatically to the service provider. Your service provider is specified in the Control point name field. For hardware problem reporting, contact your service provider.

Query problem status

To retrieve the latest status of a previously reported problem, use one of the following methods:

Method 1:

1. On any command line, type QRYPRBSTS on any command line, and press **F4**. The Query Problem Status (QRYPRBSTS) display appears.

Note:

Currently, the QRYPRBSTS command is not enabled to query hardware problems.

2. If you know the problem management record (PMR) number, type *PMR in the Problem identifier field and press **Enter**. Additional fields appear on the display. Type the PMR number in the Service number field and press **Enter**. If you know the WRKPRB problem ID number, type the 10-digit ID number for the problem in the Problem identifier field and press **Enter**. If you don't know the problem ID number, see Previously reported problems Finding a previously reported problem for instructions on how to find this 10-digit number.
3. After the query is complete, enter: WRKPRB xxxxxxxxxxxx where xxxxxxxxxxxx is the 10-digit problem ID number. The Work with Problem display appears.
4. Type Option 12 (Enter text) next to the problem entry and press **Enter**. The Select Text Type display appears.
5. Select Option 10 (Query Status text). The Query results are shown.

Method 2:

1. On any command line, type WRKPRB and press **Enter**. The Work with Problems display appears.
2. Find the problem entry for which you want to query the status. To start a query, the problem entry must have a status of Answered or Sent.
3. Type Option 8 (Work with problem) next to the problem entry. The Work with Problem menu appears.
4. Select Option 41 (Query problem status text). The Results of the query are shown.

Note:

The QRYPRBSTS command does not apply to problem entries that have a Fix request specified in the problem description column of the Work with Problem display.

Send a service request immediately

If you decide to send a service request now, select option 1 (Send service request now) on the Select Reporting Option display. The system packages the problem log entry as a service request. Then your iSeries server automatically dials the IBM service provider system, and the system transmits the problem to the service provider.

The service provider determines whether the request is for hardware or software service, and takes the appropriate action that is described below.

Hardware Service:

If the service provider is IBM, and if no fixes are found that match your problem symptoms, one of the following happens:

- Your request is sent to an IBM service representative.
- An IBM Customer Assistance Group representative calls you to assist in further problem definition. The connection to the service provider system ends, and the status of the problem in the problem log is changed to SENT.

Software Service:

- A search is performed against the database of fixes by using the symptom string you created during problem analysis.
- If the service provider is IBM, a match is found, and a fix is available, IBM transmits the fix to you electronically. Or, IBM sends a fix tape to you through normal mail channels. The size of the fix and its requisites determine whether IBM sends the fix electronically or through the mail. The fixes that you receive electronically are placed in the QGPL library with a file name of the fix number that is preceded by a Q and a file type of SAVF.
- If a match is not found or the fix is not available, you see the Save APAR Data display. This display saves the following information about your problem:
 - History log
 - Job information
 - Hardware and software resources
 - Error log entries
 - Vertical Licensed Internal Code log entries
 - Problem log entries
 - Pictures of displays

You can then forward this information to the IBM Software Support Center to help you solve your problem.

The connection to the service provider ends when you receive a fix or when your problem is opened for further investigation. The system changes the status of the problem to SENT or to ANSWERED in the problem log.

Note:

Whenever you use electronic customer support, the iSeries needs to dial out to the IBM system. Remember to have the electronic customer support modem available and powered on.

Send a service request later

If you decide to send a service request later, select option 2 (Do not send service request) on the Select Reporting Option display. The status of the problem in the problem log changes to PREPARED.

To submit a problem with PREPARED status, follow the directions in Reporting problems detected by the system. When the system reports the problem, the problem log entry is packaged as a service request. Then your system automatically dials the service provider system, and the system transmits the problem to the service provider.

To report all problems in the problem log that have a status of PREPARED, do one of the following:

1. On the Work with Problems display, press **F16** (Report prepared problems).

2. On any command line, type SNDSRVRQS *PREPARED and press **Enter**.

The connection to the service provider system ends when you receive a fix or when your problem is opened for further investigation. The system changes the status of the problem to SENT or to ANSWERED in the problem log.

Note:

Whenever you use electronic customer support, the iSeries needs to dial out to the IBM system. Remember to have the electronic customer support modem available and powered on.

Report problems by voice

If you find that you are not connected to a telephone line, or your communications lines are down, you can report a problem with your system by voice (telephone). To report the problem by telephone, follow the directions in Reporting problems detected by the system. When you get to the Select Reporting Option display, select option 3 (Report service request by voice). The Report Service Request by Voice display gives you the telephone number of the service provider for your specific problem.

Note:

If the service provider is IBM, IBM assigns a service number to the problem. To put this number in the problem log, press F14 (Specify service-assigned number) on the Report Service Request by Voice display.

Add notes to your problem record

To attach a note or add to an existing note in the problem record, do the following:

1. Use the Work with Problem (WRKPRB) command.
2. Select option 12 (Enter text) on the Work with Problems display. The Select Text Type display appears.
3. Select Option 1 (Problem description) to enter problem description. Only the text that is entered with this option is sent to the service provider along with the problem.

Notes should be typed in the following format to keep a chronological record of events.

- On the first line, type a brief description of the problem.
- On the second line, type the current date.
- On the third line, type in the note that you want to send. Use as many additional lines (up to 20) as you need.

Include the following information in your notes:

- Any recent release update that you have applied to the system
- Any changes you made in the system configuration
- Any new program or feature that you are using
- Anything that may be different since the last time the program was run

Find a previously reported problem

To find a previously reported problem, you need to know the IBM Service-assigned number, also known as the problem management record (PMR).

Once you have this number, type the following on any command line:

```
WRKPRB SRVID(XXXXX)
```

where XXXXX is the PMR number, then press the Enter key.

If you do not have the PMR number, use the Work with Problem (WRKPRB) command and search the list for the problems with a status of SENT, VERIFIED, ANSWERED, and CLOSED.



Printed in U.S.A.