

IBM System Storage SAN Volume Controller



Command-Line Interface User's Guide

Version 4.2.1

IBM System Storage SAN Volume Controller



Command-Line Interface User's Guide

Version 4.2.1

Note:

Before using this information and the product it supports, read the information in **Notices**.

This edition applies to the IBM System Storage SAN Volume Controller, release 4.2.1, and to all subsequent releases and modifications until otherwise indicated in new editions. This edition replaces SC26-7903-01 and all previous versions of SC26-7544.

© Copyright International Business Machines Corporation 2003, 2007. All rights reserved.

US Government Users Restricted Rights – Use, duplication or disclosure restricted by GSA ADP Schedule Contract with IBM Corp.

Contents

Tables	xix
-------------------------	------------

About this guide	xxi
-----------------------------------	------------

Who should use this guide	xxi
-------------------------------------	-----

Summary of Changes	xxi
------------------------------	-----

Summary of changes for SC26-7903-02 SAN	
---	--

Volume Controller Command-Line Interface	
--	--

Guide	xxi
-----------------	-----

Summary of changes for SC26-7903-01 SAN	
---	--

Volume Controller Command-Line Interface	
--	--

Guide	xxii
-----------------	------

Emphasis	xxiv
--------------------	------

SAN Volume Controller library and related	
---	--

publications	xxiv
------------------------	------

Related Web sites	xxviii
-----------------------------	--------

How to order IBM publications	xxviii
---	--------

How to send your comments	xxviii
-------------------------------------	--------

Syntax diagrams	xxix
---------------------------	------

Terminology	xxxi
-----------------------	------

CLI special characters	xxxi
----------------------------------	------

Using wildcards in the SAN Volume Controller	
--	--

CLI	xxxi
---------------	------

Data types and value ranges	xxxii
---------------------------------------	-------

CLI parameters	xxxviii
--------------------------	---------

CLI flags	xxxviii
---------------------	---------

CLI messages	xxxviii
------------------------	---------

Chapter 1. Preparing the SSH client system for the CLI	1
---	----------

Preparing the SSH client system to issue CLI	
--	--

commands	2
--------------------	---

Chapter 2. Secure Shell	3
--	----------

Configuring a Secure Shell client system other than	
---	--

PuTTY	4
-----------------	---

Generating an SSH key pair using PuTTY	4
--	---

Configuring the PuTTY session for the CLI	5
---	---

Adding subsequent SSH public keys to the SAN	
--	--

Volume Controller	6
-----------------------------	---

Adding SSH keys for hosts other than the master	
---	--

console	7
-------------------	---

Chapter 3. Copying the SAN Volume Controller software upgrade files using PuTTY scp	9
--	----------

Chapter 4. Audit log commands	11
--	-----------

catauditlog	11
-----------------------	----

dumppauditlog	13
-------------------------	----

lsauditlogdumps	14
---------------------------	----

Chapter 5. Role-based security commands	17
--	-----------

mkauth	18
------------------	----

rmauth	19
------------------	----

lsaauth	20
-------------------	----

Chapter 6. E-mail and inventory event notification commands	23
--	-----------

chemail	23
-------------------	----

chemailuser	25
-----------------------	----

lsemailuser	26
-----------------------	----

mkemailuser	28
-----------------------	----

rmemailuser	29
-----------------------	----

sendinventoryemail	30
------------------------------	----

setemail	31
--------------------	----

startemail	32
----------------------	----

stopemail	33
---------------------	----

testemail	33
---------------------	----

Chapter 7. Cluster commands	37
--	-----------

addnode	37
-------------------	----

chcluster	40
---------------------	----

chiogrp	43
-------------------	----

chnode	46
------------------	----

cleardumps	47
----------------------	----

cpdumps	48
-------------------	----

detectmdisk	50
-----------------------	----

rmnode	51
------------------	----

setclustertime	56
--------------------------	----

setpwdreset	57
-----------------------	----

settimezone	58
-----------------------	----

startstats	58
----------------------	----

stopcluster	60
-----------------------	----

stopstats	63
---------------------	----

Chapter 8. Backup and restore commands	65
---	-----------

backup	65
------------------	----

clear	66
-----------------	----

help	66
----------------	----

restore	67
-------------------	----

Chapter 9. Cluster diagnostic and service-aid commands	71
---	-----------

addnode	71
-------------------	----

applysoftware	73
-------------------------	----

cherrstate	75
----------------------	----

clearerrlog	76
-----------------------	----

dumpperlog	76
----------------------	----

finderr	77
-------------------	----

rmnode	78
------------------	----

setevent	83
--------------------	----

setlocale	84
---------------------	----

svqueryclock	85
------------------------	----

writesernum	85
-----------------------	----

Chapter 10. Host commands 87

addhostiogrps	87
addhostport	88
chhost	89
mkhost	91
rmhost	93
rmhostiogrps	94
rmhostport	95

Chapter 11. Virtual disk commands . . . 97

chvdisk	97
expandvdisksize	100
mkvdisk	102
mkvdiskhostmap	107
rmvdisk	109
rmvdiskhostmap	111
shrinkvdisksize	112

Chapter 12. Managed disk group commands 115

addmdisk	115
chmdiskgrp	116
mkmdiskgrp	117
rmmdisk	118
rmmdiskgrp	120

Chapter 13. Managed disk commands 123

chmdisk	123
includemdisk	123
setquorum	124

Chapter 14. FlashCopy commands 127

chfcconsistgrp	127
chfcmap	127
mkfcconsistgrp	129
mkfcmap	130
prestartfcconsistgrp	133
prestartfcmap	135
rmfcconsistgrp	136
rmfcmap	137
startfcconsistgrp	138
startfcmap	140
stopfcconsistgrp	141
stopfcmap	143

Chapter 15. Metro Mirror and Global Mirror commands 145

chpartnership	145
chrconsistgrp	146
chrrelationship	146
mkpartnership	148
mkrconsistgrp	150
mkrrelationship	151
rmpartnership	154
rmrconsistgrp	154
rmrrelationship	156
starttrconsistgrp	157
starttrrelationship	159
stoptrconsistgrp	161

stoptrrelationship	162
switchrconsistgrp	164
switchrrelationship	165

Chapter 16. Migration commands. . . 167

migrateexts	167
migratetoimage	169
migratevdisk	170

Chapter 17. Tracing commands. . . . 173

setdisktrace	173
settrace	174
starttrace	176
stoptrace	177

Chapter 18. Attributes of the -filtervalue parameters 179**Chapter 19. Overview of the list dump commands 185****Chapter 20. Information commands 187**

caterrlog	187
caterrlogbyseqnum	189
ls2145dumps	190
lscopystatus	191
lscluster	192
lsclustercandidate	195
lscontroller	196
lsdiscoverystatus	199
lserrlogbyfcconsistgrp	200
lserrlogbyfcmap	201
lserrlogbyhost	203
lserrlogbyiogrps	204
lserrlogbymdisk	206
lserrlogbymdiskgrp	207
lserrlogbynode	208
lserrlogbyrconsistgrp	210
lserrlogbyrrelationship	211
lserrlogbyvdisk	213
lserrlogdumps	214
lsfabric	215
lsfcconsistgrp	217
lsfcmap	220
lsfcmapcandidate	222
lsfcmapprogress	223
lsfcmapdependentmaps	224
lsfeaturedumps	225
lsfreeextents	227
lshbaportcandidate	228
lshost	229
lshostiogrps	231
lshostvdiskmap	232
lsiogrps	234
lsiogrphost	236
lsiogrpcandidate	237
lsiostatsdumps	239
lsiotracedumps	240
lslicense	241

lsmdisk	242
lsmdiskcandidate	246
lsmdiskextent	248
lsmdiskgrp	250
lsmdiskmember	252
lsmigrate	254
lsnode	255
lsnodecandidate	257
lsnodevpd	258
lsrconsistgrp	262
lsrrelationship	265
lsrrelationshipcandidate	268
lsrrelationshipprogress	269
lssoftware.dumps	270
lsshkeys	271
lstimezones	272
lsvdisk	273
lsvdiskdependentmaps	276
lsvdiskextent	277
lsvdiskfcmappings	279
lsvdiskhostmap	280
lsvdiskmember	281
lsvdiskprogress	283
showtimezone	284
Chapter 21. Error log commands . . . 287	
finderr	287
dumperrlog	287
clearerrlog	288
cherrstate	289
setevent	290
Chapter 22. Featurization commands 293	
chlicense	293
dumpinternallog	294
Chapter 23. Secure Shell key commands . . . 297	
addsshkey	297
rmallsshkeys	298
rmsshkey	299
Chapter 24. Service mode commands 301	
applysoftware	301
cleardumps	302
dumperrlog	303
exit	304
Chapter 25. Service mode information commands . . . 307	
ls2145dumps	307
lsclustervpd	308
lserrlogdumps	309
lsfeaturedumps	310
lsiostatsdumps	311
lsiotracedumps	312
lsnodes	313
lsnodevpd	314
lssoftware.dumps	317

Chapter 26. Controller command . . . 319
chcontroller 319

Chapter 27. Command-line interface messages 321

CMMVC5000I No message was found for major rc <i>MAJOR_RC</i> , minor rc <i>MINOR_RC</i> , for action/view id <i>ACTION_VIEW_ID</i> 321
CMMVC5700E The parameter list is not valid. 321
CMMVC5701E No object ID was specified. . . 321
CMMVC5702E [%1] is below the minimum level. 322
CMMVC5703E The value, or list starting with, [%1] is above the maximum permitted for that value or has exceeded the number of items allowed in a list. 322
CMMVC5704E [%1] is not divisible by the permitted step value. 322
CMMVC5705E A required parameter is missing. 322
CMMVC5706E An invalid argument has been entered for the [%1] parameter. 323
CMMVC5707E Required parameters are missing. 323
CMMVC5708E The %1 parameter is missing its associated arguments. 323
CMMVC5709E [%1] is not a supported parameter. 323
CMMVC5711E [%1] is not valid data. 323
CMMVC5712E Required data is missing. . . . 324
CMMVC5713E Some parameters are mutually exclusive. 324
CMMVC5714E The parameter list is empty. . . 324
CMMVC5715E The parameter list does not exist.. 324
CMMVC5716E Non-numeric data was entered for a numeric field ([%1]). Enter a numeric value.. 324
CMMVC5717E No match was found for the specified unit. 325
CMMVC5718E An unexpected return code was received. 325
CMMVC5719E A value of %2 requires the parameter %1 to be specified. 325
CMMVC5721E [%1] is not a valid time-stamp format. The valid format is MMDDHhmmYYYY. . . 325
CMMVC5722E [%1] is not a valid month.. . . 326
CMMVC5723E [%1] is not a valid day.. . . . 326
CMMVC5724E [%1] is not a valid hour. . . . 326
CMMVC5725E [%1] is not a valid minute. . . 326
CMMVC5726E [%1] are not valid seconds. . . 326
CMMVC5727E [%1] is not a valid filter. . . . 327
CMMVC5728E [%1] should be in the format minute:hour:day:month:weekday.. 327
CMMVC5729E One or more components in the list is not valid. 327
CMMVC5730E %1 is only valid when %2 has a value of %3. 327
CMMVC5731E %1 can only be entered when %2 has been entered. 327
CMMVC5732E The shared-memory interface is not available, return code %1.. 328
CMMVC5733E Enter at least one parameter. 328

CMMVC5734E A combination of values was entered that is not valid.	328	CMMVC5764E The mode change request is invalid - internal error.	334
CMMVC5735E The name entered is not valid. Enter an alphanumeric string that does not start with a number.	328	CMMVC5765E The object specified is no longer a candidate - a change occurred during the request.	334
CMMVC5737E The parameter %1 has been entered multiple times. Enter the parameter only one time..	329	CMMVC5767E One or more of the parameters specified are invalid or a parameter is missing..	334
CMMVC5738E The argument %1 contains too many characters.	329	CMMVC5769E The requested operation requires all nodes to be online - one or more nodes are not online..	335
CMMVC5739E The argument %1 does not contain enough characters.	329	CMMVC5770E The ssh key file supplied is invalid..	335
CMMVC5740E The filter flag %1 is not valid.	329	CMMVC5771E The operation requested could not complete, usually due to child objects existing. To force the operation, specify the force flag..	335
CMMVC5741E The filter value %1 is not valid..	329	CMMVC5772E The operation requested could not be performed because software upgrade is in progress.	335
CMMVC5742E A specified parameter is out of its valid range..	330	CMMVC5773E The object selected is in the wrong mode to perform the requested operation..	336
CMMVC5743E A specified parameter does not comply with the step value..	330	CMMVC5774E The userid supplied is not valid..	336
CMMVC5744E Too many objects were specified in the command.	330	CMMVC5775E The directory attribute specified is not valid.	336
CMMVC5745E Too few objects were specified in the request.	330	CMMVC5776E The directory listing could not be retrieved.	336
CMMVC5746E The requested operation cannot be applied to the object specified.. . . .	330	CMMVC5777E The node could not be added to the IO Group, because the other node in the IO Group is in the same power domain.	336
CMMVC5747E The action requested is invalid - internal error.	331	CMMVC5778E Cannot create another cluster, a cluster already exists.	337
CMMVC5748E The action requested is invalid - internal error.	331	CMMVC5780E The action could not be completed using the Remote Cluster name. Use the Remote Cluster Unique ID instead. . . .	337
CMMVC5749E The dump filename specified already exists.	331	CMMVC5781E The cluster ID specified is invalid..	337
CMMVC5750E The dump file could not be created - the filesystem is probably full. .	331	CMMVC5782E The object specified is offline.	337
CMMVC5751E The dump file could not be written to..	331	CMMVC5783E The information is not available to complete this command.	337
CMMVC5752E Request failed. The object contains child objects, these must be deleted first..	332	CMMVC5784E The cluster name specified is not unique, specify the cluster using the cluster ID..	338
CMMVC5753E The specified object does not exist or is not a suitable candidate. . . .	332	CMMVC5785E The filename specified contains an illegal character.	338
CMMVC5754E The specified object does not exist, or the name supplied does not meet the naming rules.	332	CMMVC5786E The action failed because the cluster is not in a stable state.	338
CMMVC5755E Cannot create as the sizes of the specified objects do not match.. . . .	332	CMMVC5787E The cluster was not created because a cluster already exists.	338
CMMVC5756E Cannot perform the request as the object id is already mapped to another object or is the subject of an FC or RC relationship.	332	CMMVC5788E The service IP address is not valid..	338
CMMVC5757E Self Defining Structure (SDS) defaults not found - internal error. . . .	333	CMMVC5789E The cluster was not modified because the IP address, subnet mask, service address, SNMP address, or gateway address is not valid.	339
CMMVC5758E Object filename already exists.	333	CMMVC5790E The node was not added to the cluster because the maximum number of nodes has been reached.	339
CMMVC5759E An internal error has occurred - memory could not be allocated..	333		
CMMVC5760E Failed to add the node to the cluster member list.	333		
CMMVC5761E Failed to delete the node from the cluster member list..	333		
CMMVC5762E The request did not complete before the timeout period expired.	334		
CMMVC5763E The node failed to go online.	334		

CMMVC5791E The action failed because an object that was specified in the command does not exist.	339	CMMVC5809E The tracing of I/O operations was not started because it is already in progress.	343
CMMVC5792E The action failed because the I/O group is used for recovery.	339	CMMVC5810E The quorum index number for the managed disk (MDisk) was not set because the MDisk is offline.	344
CMMVC5793E The node was not added to the cluster because the I/O group already contains a pair of nodes.	340	CMMVC5811E The quorum index number for the managed disk (MDisk) was not set because the quorum disk does not exist.	344
CMMVC5794E The action failed because the node is not a member of the cluster.	340	CMMVC5812E The quorum index number for the managed disk (MDisk) was not set because the MDisk is in the wrong mode.	344
CMMVC5795E The node was not deleted because a software upgrade is in progress.	340	CMMVC5813E The quorum index number for the managed disk (MDisk) was not set because the MDisk has a sector size that is not valid.	344
CMMVC5796E The action failed because the I/O group that the node belongs to is unstable.	340	CMMVC5814E The quorum index number for the managed disk (MDisk) was not set because the unique identifier (UID) type is not valid.	345
CMMVC5797E The node was not deleted because this is the last node in the I/O group and there are virtual disks (VDisks) associated with the I/O group.	340	CMMVC5815E The managed disk (MDisk) group was not created because an entity that was specified in the command does not exist.	345
CMMVC5798E The action failed because the node is offline.	341	CMMVC5816E The action failed because an entity that was specified in the command does not exist.	345
CMMVC5799E The shut down was not successful because there is only one online node in the I/O group.	341	CMMVC5817E The specified managed disk (MDisk) group was invalid.	345
CMMVC5800E The action failed because an entity that was specified in the command does not exist.	341	CMMVC5818E The managed disk (MDisk) group was not deleted because there is at least one MDisk in the group.	345
CMMVC5801E The upgrade of the cluster software could not proceed because every node in the cluster must be online. Either delete the node that is offline or bring the node online and resubmit the command	341	CMMVC5819E The managed disk (MDisk) was not added to the MDisk group because the MDisk is part of another MDisk group.	346
CMMVC5802E The upgrade of the cluster software could not proceed because there is an I/O group in the cluster that contains only one node. The software upgrade requires that each node in an I/O group be shut down and restarted. If there is only one node in an I/O group, I/O operations could be lost if I/O operations are not stopped before beginning the software upgrade.	342	CMMVC5820E The managed disk (MDisk) was not added to the MDisk group because an entity that was specified in the command does not exist.	346
CMMVC5803E The entry in the error log was not marked because the error is already fixed or unfixed, or the sequence number could not be found.	342	CMMVC5821E The managed disk (MDisk) was not added to the MDisk group because not enough MDisks were included in the list.	346
CMMVC5804E The action failed because an object that was specified in the command does not exist.	342	CMMVC5822E The managed disk (MDisk) was not added to the MDisk group because too many MDisks were included in the list.	346
CMMVC5805E The progress information was not returned because the FlashCopy statistics are not ready yet.	342	CMMVC5823E The managed disk (MDisk) was not deleted from the MDisk group because the MDisk is part of another MDisk group.	347
CMMVC5806E action failed because an object that was specified in the command does not exist.	343	CMMVC5824E The managed disk (MDisk) was not deleted from the MDisk group because it does not belong to the MDisk group.	347
CMMVC5807E The action failed because the managed disk (MDisk) cannot be changed to the specified mode.	343	CMMVC5825E The managed disk (MDisk) was not deleted from the MDisk group because a virtual disk (VDisk) is allocated from one or more of the specified MDisks. A forced deletion is required.	347
CMMVC5808E The action failed because the managed disk (MDisk) does not exist.	343	CMMVC5826E The virtual disk (VDisk) was not created because an entity that was specified in the command does not exist.	347
		CMMVC5827E The command failed as a result of either an inconsistency between two or more of the entered parameters, or an inconsistency between a parameter and the requested action.	348

CMMVC5828E The virtual disk (VDisk) was not created because the I/O group contains no nodes..	348	CMMVC5847E The virtual disk (VDisk) was not migrated because its associated managed disk (MDisk) is already in the MDisk group.. . . .	353
CMMVC5829E The image-mode or sequential-mode virtual disk (VDisk) was not created because more than one managed disk (MDisk) is specified.	348	CMMVC5848E The action failed because the virtual disk (VDisk) does not exist or it is being deleted..	353
CMMVC5830E The image-mode virtual disk (VDisk) was not created because no managed disk (MDisk) was specified in the command.	348	CMMVC5849E The migration failed because some or all of the extents are already being migrated.	353
CMMVC5831E The virtual disk (VDisk) was not created because the preferred node for I/O operations is not part of the I/O group.	349	CMMVC5850E The extent was not migrated because there is a problem with the source extents.	353
CMMVC5832E The property of the virtual disk (VDisk) was not modified because an entity that was specified in the command does not exist..	349	CMMVC5851E The extent was not migrated because there is a problem with the target extents.	353
CMMVC5833E The property of the virtual disk (VDisk) was not modified because there are no nodes in the I/O group.	349	CMMVC5852E The migration failed because there are too many migrations in progress.	354
CMMVC5834E The I/O group for the virtual disk (VDisk) was not modified because the group is a recovery I/O group. To modify the I/O group, use the force option.	349	CMMVC5853E The action failed because there was a problem with the group.	354
CMMVC5835E The virtual disk (VDisk) was not expanded because an entity that was specified in the command does not exist..	350	CMMVC5854E The extent information was not returned because the extent is not used or does not exist.	354
CMMVC5836E The virtual disk (VDisk) was not shrunk because it is locked.	350	CMMVC5855E The extent information was not returned because the managed disk (MDisk) is not used by any virtual disk (VDisk).	354
CMMVC5837E The action failed because the virtual disk (VDisk) is part of a FlashCopy mapping.	350	CMMVC5856E The action failed because the virtual disk (VDisk) does not belong to the specified managed disk (MDisk) group.	355
CMMVC5838E The action failed because the virtual disk (VDisk) is part of a Remote Copy mapping.	350	CMMVC5857E The action failed because the managed disk (MDisk) does not exist or it is not a member of the managed disk (MDisk) group..	355
CMMVC5839E The virtual disk (VDisk) was not shrunk because an object that was specified in the command does not exist..	351	CMMVC5858E The action failed because the virtual disk (VDisk) is in the wrong mode, the managed disk (MDisk) is in the wrong mode, or both are in the wrong mode..	355
CMMVC5840E The virtual disk (VDisk) was not deleted because it is mapped to a host or because it is part of a FlashCopy or Remote Copy mapping, or is involved in an image mode migrate.	351	CMMVC5859E The migration did not complete because an error occurred during the migration of the last extent on an image-mode virtual disk (VDisk).	355
CMMVC5841E The virtual disk (VDisk) was not deleted because it does not exist.	351	CMMVC5860E The action failed because there were not enough extents in the managed disk (MDisk) group..	356
CMMVC5842E The action failed because an object that was specified in the command does not exist.	351	CMMVC5861E The action failed because there were not enough extents on the managed disk (MDisk)..	356
CMMVC5843E The virtual disk (VDisk)-to-host mapping was not created because the VDisk does not have a capacity greater than zero bytes.	352	CMMVC5862E The action failed because the virtual disk (VDisk) is being formatted..	356
CMMVC5844E The virtual disk (VDisk)-to-host mapping was not created because the SCSI Logical unit number (LUN) ID is not valid.	352	CMMVC5863E The migration failed because there are not enough free extents on the target managed disk (MDisk).	356
CMMVC5845E The extent was not migrated because an object that was specified in the command does not exist.	352	CMMVC5864E The extent information was not returned because the source extent is not used.	357
CMMVC5846E The virtual disk (VDisk) was not migrated because an object that was specified in the command does not exist..	352	CMMVC5865E The action failed because the extent is out of range for the managed disk (MDisk) or virtual disk (VDisk) specified.	357
		CMMVC5866E The action failed because the extent contains internal data..	357

CMMVC5867E The action failed because the worldwide port name is already assigned or is not valid.	357	CMMVC5887E The FlashCopy mapping was not created because the source or target virtual disk (VDisk) must not be in router mode.	362
CMMVC5868E The action failed because an entity that was specified in the command does not exist.	358	CMMVC5888E The action failed because an entity that was specified in the command does not exist.	362
CMMVC5869E The host object was not renamed because the host ID or name is not valid.	358	CMMVC5889E The FlashCopy mapping was not deleted because an entity that was specified in the command does not exist.	363
CMMVC5870E The host object was not deleted because an entity that was specified in the command does not exist.	358	CMMVC5890E The FlashCopy mapping or consistency group was not started because starting consistency group 0 is not a valid operation.	363
CMMVC5871E The action failed because one or more of the configured worldwide port names is in a mapping.	358	CMMVC5891E The FlashCopy consistency group was not created because the name is not valid.	363
CMMVC5872E The port (WWPN) was not added to the host object because an object that was specified in the command does not exist.	359	CMMVC5892E The FlashCopy consistency group was not created because it already exists.	363
CMMVC5873E No matching WWPN.	359	CMMVC5893E The action failed because an entity that was specified in the command does not exist.	364
CMMVC5874E The action failed because the host does not exist.	359	CMMVC5894E The FlashCopy consistency group was not deleted because you are trying to delete consistency group 0 or the name of the consistency group is not valid.	364
CMMVC5875E The action failed because the virtual disk (VDisk) does not exist.	359	CMMVC5895E The FlashCopy consistency group was not deleted because it contains mappings. To delete this consistency group, a forced deletion is required.	364
CMMVC5876E The virtual disk (VDisk)-to-host mapping was not created because the maximum number of mappings has been reached.	359	CMMVC5896E The FlashCopy mapping was not deleted because the mapping or consistency group is in the preparing state. The mapping or consistency group must be stopped first.	364
CMMVC5877E The virtual disk (VDisk)-to-host mapping was not created because the maximum number of SCSI LUNs has been allocated.	360	CMMVC5897E The FlashCopy mapping was not deleted because the mapping or consistency group is in the prepared state. The mapping or consistency group must be stopped first.	365
CMMVC5878E The virtual disk (VDisk)-to-host mapping was not created because this VDisk is already mapped to this host.	360	CMMVC5898E The FlashCopy mapping was not deleted because the mapping or consistency group is in the copying state. The mapping or consistency group must be stopped first.	365
CMMVC5879E The virtual disk (VDisk)-to-host mapping was not created because a VDisk is already mapped to this host with this SCSI LUN.	360	CMMVC5899E The FlashCopy mapping was not deleted because the mapping or consistency group is in the stopped state. To delete the mapping, a forced deletion is required.	365
CMMVC5880E The virtual disk was not created because a capacity of zero bytes is not allowed for image mode disks.	360	CMMVC5900E The FlashCopy mapping was not deleted because the mapping or consistency group is in the suspended state. The mapping or consistency group must be stopped first.	365
CMMVC5881E The FlashCopy mapping was not created because an entity that was specified in the command does not exist.	361	CMMVC5901E The FlashCopy mapping was not prepared because the mapping or consistency group is already in the preparing state.	366
CMMVC5882E The FlashCopy mapping was not created because a mapping for the source or target virtual disk (VDisk) already exists.	361	CMMVC5902E The FlashCopy mapping was not prepared because the mapping or consistency group is already in the prepared state.	366
CMMVC5883E The FlashCopy mapping was not created because the recovery I/O group is associated with the source or target virtual disk (VDisk).	361	CMMVC5903E The FlashCopy mapping was not prepared because the mapping or consistency group is already in the copying state.	366
CMMVC5884E The FlashCopy mapping was not created because the source or target virtual disk (VDisk) cannot be a member of a Remote Copy mapping.	361	CMMVC5904E The FlashCopy mapping was not prepared because the mapping or consistency group is already in the suspended state.	366
CMMVC5885E The FlashCopy mapping was not created because this source or target virtual disk (VDisk) cannot be a member of a FlashCopy mapping.	362		
CMMVC5886E The FlashCopy mapping was not created because the source or target virtual disk (VDisk) is associated with the recovery I/O group.	362		

CMMVC5905E The FlashCopy mapping or consistency group was not started because the mapping or consistency group is in the idle state. The mapping or consistency group must be prepared first.	367	CMMVC5921E The properties of the FlashCopy mapping were not modified because the consistency group is not idle.. . . .	370
CMMVC5906E The FlashCopy mapping or consistency group was not started because the mapping or consistency group is in the preparing state.. . . .	367	CMMVC5922E The FlashCopy mapping was not created because the destination virtual disk (Vdisk) is too small.. . . .	371
CMMVC5907E The FlashCopy mapping or consistency group was not started because the mapping or consistency group is already in the copying state.. . . .	367	CMMVC5923E The FlashCopy mapping was not created because the I/O group is offline. . . .	371
CMMVC5908E The FlashCopy mapping or consistency group was not started because the mapping or consistency group is in the stopped state. The mapping or consistency group must be prepared first.	367	CMMVC5924E The FlashCopy mapping was not created because the source and target virtual disks (VDisks) are different sizes.. . . .	371
CMMVC5909E The FlashCopy mapping or consistency group was not started because the mapping or consistency group is in the suspended state.. . . .	368	CMMVC5925E The remote cluster partnership was not created because it already exists. . . .	371
CMMVC5910E The FlashCopy mapping or consistency group was not stopped because the mapping or consistency group is in the idle state.. . . .	368	CMMVC5926E The remote cluster partnership was not created because there are too many partnerships.	372
CMMVC5911E The FlashCopy mapping or consistency group was not stopped because the mapping or consistency group is in the preparing state.. . . .	368	CMMVC5927E The action failed because the cluster ID is not valid.. . . .	372
CMMVC5912E The FlashCopy mapping or consistency group was not stopped because the mapping or consistency group is already in the stopped state.. . . .	368	CMMVC5928E The action failed because the cluster name is a duplicate of another cluster..	372
CMMVC5913E The properties of the FlashCopy mapping were not modified because the mapping or consistency group is in the preparing state.. . . .	369	CMMVC5929E The Remote Copy partnership was not deleted because it has already been deleted..	372
CMMVC5914E The properties of the FlashCopy mapping were not modified because the mapping or consistency group is in the prepared state..	369	CMMVC5930E The Remote Copy relationship was not created because an object that was specified in the command does not exist.. . . .	372
CMMVC5915E The properties of the FlashCopy mapping were not modified because the mapping or consistency group is in the copying state. .	369	CMMVC5931E The Remote Copy relationship was not created because the master or auxiliary virtual disk (Vdisk) is locked.	373
CMMVC5916E The properties of the FlashCopy mapping were not modified because the mapping or consistency group is in the suspended state.. . . .	369	CMMVC5932E The Remote Copy relationship was not created because the master or auxiliary virtual disk (Vdisk) is a member of a FlashCopy mapping.	373
CMMVC5917E The FlashCopy mapping was not created because there is no memory in which to create the bitmap.	370	CMMVC5933E The Remote Copy relationship was not created because the master or auxiliary virtual disk (Vdisk) is in the recovery I/O group..	373
CMMVC5918E The FlashCopy mapping was not prepared because the I/O group is offline. . .	370	CMMVC5934E The Remote Copy relationship was not created because the master or auxiliary virtual disk (Vdisk) is in the router mode.. . . .	373
CMMVC5919E The FlashCopy mapping or consistency group was not started because the I/O group is offline.	370	CMMVC5935E The action failed because an object that was specified in the command does not exist.	374
CMMVC5920E The FlashCopy mapping was not created because the consistency group is not idle.	370	CMMVC5936E The action failed because an object that was specified in the command does not exist.	374
		CMMVC5937E The action failed because an object that was specified in the command does not exist.	374
		CMMVC5938E The Remote Copy consistency group was not deleted because the consistency group contains relationships. To delete the consistency group, the force option is required.	374
		CMMVC5939E The action failed because the cluster is not in a stable state.	375
		CMMVC5940E The cluster that contains the auxiliary virtual disk (Vdisk) is unknown. . .	375

CMMVC5941E The cluster that contains the master virtual disk (Vdisk) has too many consistency groups.	375	CMMVC5969E The Remote Copy relationship was not created because the I/O group is offline.	381
CMMVC5942E The cluster that contains the auxiliary virtual disk (Vdisk) has too many consistency groups.	375	CMMVC5970E The Remote Copy relationship was not created because there is not enough memory.	381
CMMVC5943E The specified relationship is not valid.	375	CMMVC5971E The operation was not performed because the consistency group contains no relationships.	381
CMMVC5944E The specified consistency group is not valid.	376	CMMVC5972E The operation was not performed because the consistency group contains relationships.	381
CMMVC5945E The specified master cluster is not valid.	376	CMMVC5973E The operation was not performed because the consistency group is not synchronized.	382
CMMVC5946E The specified auxiliary cluster is not valid.	376	CMMVC5974E The operation was not performed because the consistency group is offline.	382
CMMVC5947E The specified master virtual disk (Vdisk) is not valid.	376	CMMVC5975E The operation was not performed because the cluster partnership is not connected.	382
CMMVC5948E The specified auxiliary virtual disk (Vdisk) is not valid.	376	CMMVC5976E The operation was not performed because the consistency group is in the freezing state.	382
CMMVC5949E The specified relationship is unknown.	377	CMMVC5977E The operation was not performed because it is not valid given the current consistency group state.	382
CMMVC5950E The specified consistency group is unknown.	377	CMMVC5978E The operation was not performed because the relationship is not synchronized.	383
CMMVC5951E The operation cannot be performed because the relationship is not a stand-alone relationship.	377	CMMVC5980E The operation was not performed because the master and auxiliary clusters are not connected.	383
CMMVC5952E The relationship and consistency group have different master clusters.	377	CMMVC5981E The operation was not performed because the relationship is in the freezing state.	383
CMMVC5953E The relationship and group have different auxiliary clusters.	377	CMMVC5982E The operation was not performed because it is not valid given the current relationship state.	383
CMMVC5954E The master and auxiliary virtual disks (VDisks) are different sizes.	378	CMMVC5983E dump file was not created. This may be due to the file system being full.	384
CMMVC5955E The maximum number of relationships has been reached.	378	CMMVC5984E The dump file was not written to disk. This may be due to the file system being full.	384
CMMVC5956E The maximum number of consistency groups has been reached.	378	CMMVC5985E The action failed because the directory that was specified was not one of the following directories: /dumps, /dumps/iostats, /dumps/iotrace, /dumps/feature, /dumps/configs, /dumps/elog, or /home/admin/upgrade.	384
CMMVC5957E The master virtual disk (Vdisk) is already in a relationship.	378	CMMVC5986E The tracing of I/O operations was not started because the virtual disk (Vdisk) or managed disk (MDisk) failed to return any statistics.	385
CMMVC5958E The auxiliary virtual disk (Vdisk) is already in a relationship.	378	CMMVC5987E %l is not a valid command line option.	385
CMMVC5959E There is a relationship that already has this name on the master cluster.	379	CMMVC5988E command should not be run by the root userid. Use the admin userid.	385
CMMVC5960E There is a relationship that already has this name on the auxiliary cluster.	379	CMMVC5989E The operation was not performed because the relationship is offline.	385
CMMVC5961E There is a consistency group that already has this name on the master cluster.	379	CMMVC5990E The FlashCopy consistency group was not stopped as there are no FlashCopy mappings within the group.	386
CMMVC5962E There is a consistency group that already has this name on the auxiliary cluster.	379		
CMMVC5963E No direction has been defined.	379		
CMMVC5964E The copy priority is not valid.	380		
CMMVC5965E The virtual disks (VDisks) are in different I/O groups on the local cluster.	380		
CMMVC5966E The master virtual disk (Vdisk) is unknown.	380		
CMMVC5967E The auxiliary virtual disk (Vdisk) is unknown.	380		
CMMVC5968E The relationship cannot be added because the states of the relationship and the consistency group do not match.	380		

CMMVC5991E The Remote Copy consistency group was not stopped as there are no Remote Copy relationships within the group.	386	CMMVC6017E A parameter or argument contains invalid characters. Ensure that all characters are ASCII.	391
CMMVC5992E The Remote Copy consistency group was not stopped as there are no Remote Copy relationships within the group.	386	CMMVC6018E The software upgrade pre-install process failed.	391
CMMVC5993E The specified upgrade package does not exist.	386	CMMVC6019E The software upgrade failed as a node pended as the upgrade was in progress.. . . .	392
CMMVC5994E Error in verifying the signature of the upgrade package.	386	CMMVC6020E The software upgrade failed as the system was unable to distribute the software package to all nodes..	392
CMMVC5995E Error in unpacking the upgrade package.	387	CMMVC6021E The system is currently busy performing another request. Try again later.	392
CMMVC5996E The specific upgrade package cannot be installed over the current version.	387	CMMVC6022E The system is currently busy performing another request. Try again later.	392
CMMVC5999W Featurization for this facility has not been enabled.	387	CMMVC6023E The system is currently busy performing another request. Try again later.	392
CMMVC6000W Featurization for this facility has not been enabled.	387	CMMVC6024E The auxiliary VDisk entered is invalid.	393
CMMVC6001E The FlashCopy consistency group was not started as there are no FlashCopy mappings within the group.	388	CMMVC6025E The RC consistency group Master cluster is not the local cluster.	393
CMMVC6002E This command can only be run on a node that is in service mode.	388	CMMVC6026E The RC consistency group is not in the stopped state.	393
CMMVC6003E This command can not be run on a node that is in service mode.	388	CMMVC6027E The RC consistency group is not the primary master..	393
CMMVC6004E The delimiter value, %1, is invalid.	388	CMMVC6028E This upgrade package cannot be applied to the current software level because it contains changes to the cluster state and there are remote cluster partnership defined.	394
CMMVC6005E The view request failed as the specified object is not a member of an appropriate group.	388	CMMVC6029E All nodes must have identical code level before a concurrent code upgrade can be performed.	394
CMMVC6006E The managed disk (MDisk) was not deleted because the resource was busy..	389	CMMVC6030E The operation was not preformed because the FlashCopy mapping is part of a consistency group. The action must be performed at the consistency group level.	394
CMMVC6007E The two passwords that were entered do not match.	389	CMMVC6031E The operation was not performed because the FlashCopy consistency group is empty..	394
CMMVC6008E The key already exists.	389	CMMVC6032E The operation was not performed because one or more of the entered parameters is invalid for this operation..	395
CMMVC6009E Unable to malloc a block of memory in which to copy the returned data.	389	CMMVC6033E The action failed due to an internal error.	395
CMMVC6010E Unable to complete the command as there are insufficient free extents, or the command requested an expansion of 0 size.	389	CMMVC6034E The action failed because the maximum number of objects has been reached..	395
CMMVC6011E This cluster is part of a remote cluster partnership. Because this upgrade package will make changes to the cluster state, it cannot be applied to the current code level until all remote cluster partnerships are deleted.	390	CMMVC6035E The action failed as the object already exists.	395
CMMVC6012W The virtualized storage capacity is approaching the amount that you are licensed to use.	390	CMMVC6036E An invalid action was requested.	395
CMMVC6013E The command failed because there is a consistency group mismatch on the aux cluster.	390	CMMVC6037E The action failed as the object is not empty.	396
CMMVC6014E The command failed because the requested object is either unavailable or does not exist.	390	CMMVC6038E The action failed as the object is empty.	396
CMMVC6015E A delete request is already in progress for this object.	391	CMMVC6039E The action failed as the object is not a member of a group..	396
CMMVC6016E The action failed as there would be, or are, no more disks in the MDisk group.	391	CMMVC6040E The action failed as the object is not a parent.	396
		CMMVC6041E The action failed as the cluster is full..	396
		CMMVC6042E The action failed as the object is not a cluster member.	397

CMMVC6043E The action failed as the object is a member of a group.	397	CMMVC6073E The maximum number of files has been exceeded.. . . .	403
CMMVC6044E The action failed as the object is a parent.	397	CMMVC6074E The command failed as the extent has already been assigned.	403
CMMVC6045E The action failed, as the -force flag was not entered.	397	CMMVC6075E The expand failed as the last extent is not a complete extent.. . . .	403
CMMVC6046E The action failed as too many candidates were selected.	397	CMMVC6076E The command failed because the virtual disk cache is not empty. Either wait for the cache to flush or use the force flag to discard the contents of the cache.	403
CMMVC6047E The action failed as too few candidates were selected.	398	CMMVC6077E WARNING - Unfixed errors should be fixed before applying software upgrade. Depending on the nature of the errors, they might cause the upgrade process to fail. It is highly recommended to fix these errors before proceeding. If a particular error cannot be fixed, contact the support center.	404
CMMVC6048E The action failed as the object is busy.	398	CMMVC6078E The action failed because the object is in an invalid mode.	404
CMMVC6049E The action failed as the object is not ready.	398	CMMVC6079E Metadata recovery could not complete the operation because a parameter is invalid.	404
CMMVC6050E The action failed as the command was busy.	398	CMMVC6081E Metadata Recovery is busy processing the previous operation.	404
CMMVC6051E An unsupported action was selected.	398	CMMVC6082E The attempt to abort metadata recovery failed because the previous operation has completed.. . . .	404
CMMVC6052E The action failed as the object is a member of a FlashCopy mapping.	399	CMMVC6083E Metadata recovery could not find a valid dumpfile required for the rebuild operation.	405
CMMVC6053E An invalid WWPN was entered.	399	CMMVC6084E Metadata recovery could not create/open/write the scan file, the disk might be full.. . . .	405
CMMVC6054E The action failed as not all nodes are online.	399	CMMVC6085E Metadata recovery could not create/open/write the dump file, the disk might be full.. . . .	405
CMMVC6055E The action failed as an upgrade is in progress.	399	CMMVC6086E Metadata recovery could not create/open/write the progress file, the disk might be full.. . . .	405
CMMVC6056E The action failed as the object is too small.	399	CMMVC6087E Metadata recovery could not map the buffers necessary to complete the operation.	405
CMMVC6057E The action failed as the object is the target of a FlashCopy mapping.	400	CMMVC6088E The lba at which metadata recovery was requested does not contain metadata.	405
CMMVC6058E The action failed as the object is in the recovery HWS.	400	CMMVC6089E The metadata at the requested lba is flagged as invalid.	406
CMMVC6059E The action failed as the object is in an invalid mode..	400	CMMVC6090E The metadata header checksum verification failed.	406
CMMVC6060E The action failed as the object is being deleted.	400	CMMVC6091E The metadata region checksum verification failed.	406
CMMVC6061E The action failed as the object is being resized.	400	CMMVC6092E The metadata recovery operation was aborted.	406
CMMVC6062E The action failed as the object is being moved between HWS.	401	CMMVC6093E Metadata recovery internal error - (read only)	406
CMMVC6063E The action failed as there are no more disks in the group.	401	CMMVC6095E Metadata recovery encountered the end of the disk.	406
CMMVC6064E The action failed as the object has an invalid name.	401	CMMVC6096E Metadata recovery encountered an error from a lower layer - (vl no resource).	406
CMMVC6065E The action failed as the object is not in a group.	401	CMMVC6097E Metadata recovery encountered an error from a lower layer - (vl failure).. . . .	406
CMMVC6066E The action failed as the system is running low on memory.	401		
CMMVC6067E The action failed as the SSH key was not found..	402		
CMMVC6068E The action failed as there are no free SSH keys.	402		
CMMVC6069E The action failed as the SSH key is already registered..	402		
CMMVC6070E An invalid or duplicated parameter, unaccompanied argument, or incorrect argument sequence has been detected. Ensure that the input is as per the help.	402		
CMMVC6071E The virtual disk (VDisk)-to-host mapping was not created because the VDisk is already mapped to a host.	402		

CMMVC6098E The copy failed as the specified node is the configuration node.	407	CMMVC6134E No argument for -option	414
CMMVC6100E -option not consistent with action.	407	CMMVC6135E Argument value for -option is not valid	414
CMMVC6101E -option not consistent with -option	407	CMMVC6136W No SSH key file file-name	414
CMMVC6102E -option and -option are alternatives	407	CMMVC6137W No SSH key file file-name; key not restored	415
CMMVC6103E Problem with file-name: details	407	CMMVC6138E -option is required	415
CMMVC6104E Action name not run	408	CMMVC6139E Incorrect XML tag nesting in filename	415
CMMVC6105E Different names for source (name) and target (name) clusters	408	CMMVC6140E No default name for type type	415
CMMVC6106W Target cluster has non-default id_alias alias.	408	CMMVC6141E -option does not contain any argument	415
CMMVC6107E x io_grp objects in target cluster; y are required	408	CMMVC6142E Existing object-type object-name has a non-default name.	416
CMMVC6108I Disk controller system with a WWNN of wwnn found.	408	CMMVC6143E Required configuration file file-name does not exist.	416
CMMVC6109E Disk controller system with a WWNN of wwnn not available.	409	CMMVC6144W Object with default name name restored as substitute-name.	416
CMMVC6110E Bad code level	409	CMMVC6145I Use the restore -prepare command first	416
CMMVC6111E Cluster code_level could not be determined from level	409	CMMVC6146E Problem parsing object-type data: line	417
CMMVC6112W object-type object-name has a default name	409	CMMVC6147E type name has a name beginning with prefix.	417
CMMVC6113E Command failed with return code: details	410	CMMVC6148E Target cluster has n-actual objects of type type instead of n-required	417
CMMVC6114E No help for action action.	410	CMMVC6149E An action is required.	417
CMMVC6115W Feature property mismatch: value1 expected; value2 found	410	CMMVC6150E The action, action, is not valid	417
CMMVC6116I Feature match or property	410	CMMVC6151E The -option option is not valid	418
CMMVC6117E fix-or-feature is not available	410	CMMVC6152E vdisk name instance number instance is not valid	418
CMMVC6118I type with property value [and property value] found	411	CMMVC6153E object not consistent with action.	418
CMMVC6119E type with property value [and property value] not found	411	CMMVC6154E Required object-type property property-name has a null value.	418
CMMVC6120E Target is not the configuration node	411	CMMVC6155I SVCCONFIG processing completed successfully	418
CMMVC6121E No cluster id or id_alias in backup configuration	411	CMMVC6156W SVCCONFIG processing completed with errors	419
CMMVC6122E No type with property value present in table.	411	CMMVC6164E The SVCCONFIG CRON job, which runs overnight on a daily overnight, has failed.	419
CMMVC6123E No property for type name	412	CMMVC6165E Target is not the original configuration node with WWNN of value.	419
CMMVC6124E No type with property value	412	CMMVC6166E A property of an object has changed during svcconfig restore -execute.	419
CMMVC6125E No unique ID for type name	412	CMMVC6181E The target cluster contains an object that has a counterpart in the configuration to be restored, and has the correct ID.	420
CMMVC6126E No type with unique ID value	412	CMMVC6182W An object that does not contribute to the fabric of the configuration cannot be restored because its configuration does not permit it to be created.	420
CMMVC6127I SSH key identifier for user already defined; will not be restored	412	CMMVC6186W An IO group was restored with a different ID value.	420
CMMVC6128W details.	413	CMMVC6200E The action failed because of incompatible software.	420
CMMVC6129E vdisk-to-host map objects have vdisk_UID values that are not consistent.	413	CMMVC6201E The node could not be added, because of incompatible software: status code STATUS_CODE.	421
CMMVC6130W Inter-cluster property will not be restored.	413		
CMMVC6131E No location cluster information	413		
CMMVC6132E An object of a given type has a property with an incorrect value. The operation cannot proceed until the property has the correct value. Take administrative action to change the value and try again.	414		
CMMVC6133E Required type property property not found	414		

CMMVC6202E The cluster was not modified because the IP address is not valid.	421	CMMVC6223E The host does not belong to one or more of the IO groups specified or inferred.	426
CMMVC6203E The action failed because the directory that was specified was not one of the following directories: /dumps, /dumps/iostats, /dumps/iotrace, /dumps/feature, /dumps/config, /dumps/elogs, /dumps/ec or /dumps/pl.	421	CMMVC6224E The host already belongs to one or more of the IO groups specified.	426
CMMVC6204E The action failed as the resulting disk size would be less than, or equal to, zero.	421	CMMVC6225E An IO group cannot be removed from a host because of one or more associated vdisks.	426
CMMVC6205E Metadata recovery can not use the provided mdisk id - invalid or destroyed.	422	CMMVC6226E The action was not completed because the cluster has reached the maximum number of extents in MDisk Groups.	427
CMMVC6206E The software upgrade failed as a file containing the software for the specified MCP version was not found.	422	CMMVC6227I The package installed successfully.	427
CMMVC6207E The action failed because the virtual disk (VDisk) is part of a Remote Copy mapping.	422	CMMVC6228E The cluster was recovered and the CLI functionality is limited until the cause of the failure is determined and any corrective action taken. Contact IBM technical support for assistance.	427
CMMVC6208E The action failed because the virtual disk (VDisk) is part of a FlashCopy mapping.	422	CMMVC6229E The action failed as the SSH key has been revoked.	427
CMMVC6209E The FlashCopy mapping or consistency group could not be started in a reasonable time. The mapping or group is instead being prepared.	422	CMMVC6230E The action failed as the SSH key index (SSH_LABEL_ID) is invalid.	427
CMMVC6210E The command failed as a result of a migrated disk IO medium error.	423	CMMVC6231E The action failed as the audit table is full.	427
CMMVC6211E The command failed as a migrate to image was in progress.	423	CMMVC6232E This operation cannot be performed because the cluster is currently aborting the previous software upgrade command.	428
CMMVC6212E The command failed because data in the cache has not been committed to disk.	423	CMMVC6233E This operation cannot be performed because, either a software upgrade has not been started, or a software upgrade is in progress but is not in a state where it can be aborted.	428
CMMVC6213E You are trying to recover region data that was created by a code level different from the one you are currently running on the node.	423	CMMVC6234E The upgrade cannot be aborted because at least one node has already committed to a new code level.	428
CMMVC6214E Failed to recreate the cluster you are trying to rebuild.	423	CMMVC6235E An invalid response has been entered. The command has not been executed. Input is case sensitive. Enter either yes or no.	428
CMMVC6215E The FlashCopy mapping was not created or modified because the consistency group already contains the maximum number of mappings.	424	CMMVC6236E The command has not completed. A limited availability parameter has been entered without the required environment setting being set.	429
CMMVC6216E The Remote Copy relationship was not created because the master or auxiliary virtual disk (VDisk) is a member of a Remote Copy mapping.	424	CMMVC6237E The command failed as the remote cluster does not support global mirror.	429
CMMVC6217E The maximum number of hosts for the cluster is already configured.	424	CMMVC6238E The copy type differs from other copies already in the consistency group.	429
CMMVC6218E The maximum number of host/IO group pairs for the cluster is already configured.	424	CMMVC6239E The FlashCopy mapping was not prepared because the mapping or consistency group is in the stopping state.	429
CMMVC6219E The maximum number of WWPNs for the cluster is already configured.	425	CMMVC6240E The properties of the FlashCopy mapping were not modified because the mapping or consistency group is in the stopping state.	429
CMMVC6220E The maximum number of hosts for one or more IO groups is already configured.	425	CMMVC6241E The FlashCopy mapping was not deleted because the mapping or consistency group is in the stopping state. The mapping or consistency group must be stopped first.	430
CMMVC6221E The maximum number of WWPNs for one or more IO groups is already configured.	425		
CMMVC6222E The maximum number of WWPNs for the host is already configured.	426		

CMMVC6242E The FlashCopy mapping or consistency group was not started because the mapping or consistency group is in the stopping state.	430	CMMVC6300E The create failed because the source and target VDisks are members of FlashCopy mappings that belong to different I/O groups.	435
CMMVC6243E The FlashCopy mapping or consistency group was not stopped because the mapping or consistency group is already in the stopping state.	430	CMMVC6301E The create failed because the specified consistency group does not exist.	435
CMMVC6244E The FlashCopy mapping was not created because the source virtual disk (VDisk) cannot be the target for a FlashCopy mapping.	431	CMMVC6302E The create failed because the resulting tree of FlashCopy mappings would exceed the upper limit.	436
CMMVC6245E The FlashCopy mapping was not created because the source virtual disk (VDisk) is already in the maximum number of FlashCopy mappings.	431	CMMVC6303E The create failed because the source and target VDisks are the same.	436
CMMVC6246E The FlashCopy mapping was not created because the target virtual disk (VDisk) is already a source vdisk in a FlashCopy mapping.	431	CMMVC6304E The create failed because the source VDisk does not exist.	436
CMMVC6247E The FlashCopy mapping was not created because the target virtual disk (VDisk) is already a target vdisk in a FlashCopy mapping.	432	CMMVC6305E The create failed because the target VDisk does not exist.	437
CMMVC6248E The command failed because the authorization table is full.	432	CMMVC6306E The create failed because the source VDisk is the member of a FlashCopy mapping whose grain size is different to that specified.	437
CMMVC6249E The command failed because the authorization record was not found or is already set to the default role.	432	CMMVC6307E The create failed because the target VDisk is the member of a FlashCopy mapping whose grain size is different to that specified.	437
CMMVC6250E The command failed because the authorization record is not set to the default role. Use rmath to set the default role.	432	CMMVC6308E The create failed because the source VDisk is the member of a FlashCopy mapping whose IO group is different to that specified.	438
CMMVC6251E The command failed because the specified role was not found.	432	CMMVC6309E The create failed because the target VDisk is the member of a FlashCopy mapping whose IO group is different to that specified.	438
CMMVC6252E The command failed authorization because the session ssh key is invalid or was deleted.	433	CMMVC6310E The modify failed because the specified FlashCopy mapping does not exist.	438
CMMVC6253E The command failed authorization because the session ssh key does not have the requisite role.	433	CMMVC6311E The command failed because the source VDisk is the target of a FlashCopy mapping that is in the specified consistency group.	439
CMMVC6254E The command failed because the specified ssh key was not found. NOTE This command must specify an admin key.	433	CMMVC6312E The command failed because the target VDisk is the source of a FlashCopy mapping that is in the specified consistency group.	439
CMMVC6255E The command can not set the authorization record to the default role. Use rmath to set the default role.	433	CMMVC6313E The command failed because the specified background copy rate is invalid.	439
CMMVC6263E The command failed because the ssh key already exists or there is a duplicate ssh key.	433	CMMVC6314E The command failed because the specified cleaning rate is not valid.	440
CMMVC6296E One or more managed disks (MDisks) have failed validation tests, first failing mdisk id [%1].	434	CMMVC6315E The command failed because the specified grain size is not valid.	440
CMMVC6297E One or more managed disks (MDisks) have timed out during validation tests, first failing mdisk id [%1].	434	CMMVC6500E The action failed because the source and destination vdisk are the same.	440
CMMVC6298E The command failed because a target VDisk has dependent FlashCopy mappings.	434	CMMVC6501E The action failed because the node hardware is incompatible with the current I/O group member.	440
CMMVC6299E The create failed because the source and target VDisks are members of FlashCopy mappings that have different grain sizes.	435	CMMVC6502E The FlashCopy mapping was not prepared because preparing consistency group 0 is not a valid operation.	440
		CMMVC6503E The FlashCopy mapping or consistency group was not stopped because starting consistency group 0 is not a valid operation.	441
		Accessibility.	443

Notices 445
Trademarks 447

Glossary 449

Index 459

Tables

I	1. Memory required for each copy service	45	7. svcinfo lsnode attribute values	256
	2. stoprconsistgrp consistency group states	162	8. lsrconsistgrp command output values	263
	3. stoprrelationship consistency group states	163	9. lsrrelationship command attributes and	
	4. Valid filter attributes	179	values	267
	5. Attribute values.	193	10. lsvdisk attribute values	275
	6. MDisk output	244		

About this guide

The IBM System Storage SAN Volume Controller *Command-Line Interface User's Guide* provides information that helps you configure and use the IBM System Storage SAN Volume Controller.

Who should use this guide

This guide is intended for system administrators or others who install and use the SAN Volume Controller.

Before you use the SAN Volume Controller, you should have an understanding of storage area networks (SANs), the storage requirements of your enterprise, and the capabilities of your storage units.

Summary of Changes

This document contains terminology, maintenance, and editorial changes.

Technical changes or additions to the text and illustrations are indicated by a vertical line to the left of the change. This summary of changes describes new functions that have been added to this release.

Summary of changes for SC26-7903-02 SAN Volume Controller Command-Line Interface Guide

The Summary of changes provides a list of new, modified, and changed information since the last version of this guide.

New information

This topic describes the changes to this guide since the previous edition, SC26-7903-01. The following sections summarize the changes that have since been implemented from the previous version.

This version includes the following new information:

- Adding the following new SAN Volume Controller topics:
 - Information commands
 - lsvdiskdependentmaps

Changed information

This section lists the updates that were made in this document.

The following topics have been updated:

- addnode
- addmdisk
- applysoftware
- chemail
- chemailuser
- chfcmmap

- chiogrp
- chvdisk
- detectmdisk
- lsfcconsistgrp
- lsfcmap
- lsfcmapcandidate
- lsfcmapdependentmaps
- lsiogrp
- lsnodevpd
- lsvdiskprogress
- mkemailuser
- mkfcmap
- mkhost
- mkmdiskgrp
- mkvdisk
- rmmdiskgrp
- rmpartnership
- rmvdisk
- setemail
- setevent
- setlocale
- testemail

Summary of changes for SC26-7903-01 SAN Volume Controller Command-Line Interface Guide

The Summary of changes provides a list of new, modified, and changed information since the last version of this guide.

New information

This topic describes the changes to this guide since the previous edition, SC26-7903-00. The following sections summarize the changes that have since been implemented from the previous version.

This version includes the following new information:

- Adding the following new SAN Volume Controller topics:
 - Role-based security commands
 - mkauth
 - rmath
 - lsauth
 - E-mail and inventory notification commands
 - chemail
 - chemailuser
 - lsemailuser
 - mkemailuser
 - sendinventoryemail
 - rmemailuser

- setemail
- startemail
- stopemail
- testemail
- lsfcmapdependentmaps

Changed information

This section lists the updates that were made in this document.

The following topics have been updated:

- lsfcmap
- lsfcmapcandidate
- lsfcmapprogress
- lshost
- lsiogrp
- lsmdisk
- lsmdiskgrp
- lsnode
- lsrconsistgrp
- lsvdisk
- mkhost
- chhost
- mkvdisk
- mkrrelationship
- addsshkey
- rmsshkey
- rmallsshkeys
- lshbaportcandidate
- cleardumps
- cpdumps
- lscluster
- lscontroller
- lsconsistgrp
- rmmdiskgrpapplysoftware
- lsauditlogdumps
- chcluster

In addition, 140 plus commands were updated for the addition of 2 new messages associated with the role-based security commands.

The *IBM System Storage Master Console for SAN Volume Controller: Installation and User's Guide* and the *IBM System Storage Master Console for SAN Volume Controller Information Center* are no longer updated and distributed. Instead, all pertinent information from those information units has been incorporated into other SAN Volume Controller publications.

The *IBM System Storage SAN Volume Controller Configuration Guide* is now titled *IBM System Storage SAN Volume Controller: Software Installation and Configuration Guide*.

The *IBM System Storage SAN Volume Controller Installation Guide* is now titled *IBM System Storage SAN Volume Controller: Hardware Installation Guide*.

Emphasis

Different typefaces are used in this guide to show emphasis.

The following typefaces are used to show emphasis:

Boldface	Text in boldface represents menu items and command names.
<i>Italics</i>	Text in <i>italics</i> is used to emphasize a word. In command syntax, it is used for variables for which you supply actual values, such as a default directory or the name of a cluster.
Monospace	Text in monospace identifies the data or commands that you type, samples of command output, examples of program code or messages from the system, or names of command flags, parameters, arguments, and name-value pairs.

SAN Volume Controller library and related publications

A list of other publications that are related to this product are provided to you for your reference.

The tables in this section list and describe the following publications:

- The publications that make up the library for the IBM System Storage SAN Volume Controller
- Other IBM publications that relate to the SAN Volume Controller

SAN Volume Controller library

The following table lists and describes the publications that make up the SAN Volume Controller library. Unless otherwise noted, these publications are available in Adobe portable document format (PDF) from the following Web site:

<http://www.ibm.com/storage/support/2145>

Title	Description	Order number
<i>IBM System Storage SAN Volume Controller: CIM Agent Developer's Reference</i>	This reference guide describes the objects and classes in a Common Information Model (CIM) environment.	SC26-7904
<i>IBM System Storage SAN Volume Controller: Command-Line Interface User's Guide</i>	This guide describes the commands that you can use from the SAN Volume Controller command-line interface (CLI).	SC26-7903

Title	Description	Order number
<i>IBM System Storage SAN Volume Controller: Software Installation and Configuration Guide</i>	This guide provides guidelines for configuring your SAN Volume Controller.	SC23-6628
<i>IBM System Storage SAN Volume Controller: Host Attachment Guide</i>	This guide provides guidelines for attaching the SAN Volume Controller to your host system.	SC26-7905
<i>IBM System Storage SAN Volume Controller: Hardware Installation Guide</i>	This guide includes the instructions that the IBM service representative uses to install the SAN Volume Controller.	GC27-2132
<i>IBM System Storage SAN Volume Controller: Planning Guide</i>	This guide introduces the SAN Volume Controller and lists the features you can order. It also provides guidelines for planning the installation and configuration of the SAN Volume Controller.	GA32-0551
<i>IBM System Storage SAN Volume Controller: Service Guide</i>	This guide includes the instructions that the IBM service representative uses to service the SAN Volume Controller.	GC26-7901
<i>IBM Systems Safety Notices</i>	This guide contains translated caution and danger statements. Each caution and danger statement in the SAN Volume Controller documentation has a number that you can use to locate the corresponding statement in your language in the <i>IBM Systems Safety Notices</i> document.	G229-9054

Other IBM publications

The following table lists and describes other IBM publications that contain additional information that is related to the SAN Volume Controller.

You can download IBM eServer xSeries, IBM xSeries, and IBM System x publications from the following Web site:

<http://www-304.ibm.com/jct01004c/systems/support/>

Title	Description	Order number
<i>IBM System Storage Multipath Subsystem Device Driver: User's Guide</i>	This guide describes the IBM System Storage Multipath Subsystem Device Driver Version 1.6 for TotalStorage Products and how to use it with the SAN Volume Controller. This publication is referred to as the <i>IBM System Storage Multipath Subsystem Device Driver: User's Guide</i> .	GC27-2122
<i>IBM TotalStorage DS4300 Fibre Channel Storage Subsystem Installation, User's, and Maintenance Guide</i>	This guide describes how to install and configure the IBM TotalStorage DS4300 Fibre-Channel Storage Subsystem.	GC26-7722
<i>IBM eServer xSeries 306m (Types 8849 and 8491) Installation Guide</i>	This guide describes how to install the IBM eServer xSeries 306m, which is the hardware delivered for some versions of the hardware master console.	MIGR-61615
<i>IBM xSeries 306m (Types 8849 and 8491) User's Guide</i>	This guide describes how to use the IBM eServer xSeries 306m, which is the hardware delivered for some versions of the hardware master console.	MIGR-61901
<i>IBM xSeries 306m (Types 8849 and 8491) Problem Determination and Service Guide</i>	This guide can help you troubleshoot and resolve problems with the IBM eServer xSeries 306m, which is the hardware delivered for some versions of the hardware master console.	MIGR-62594
<i>IBM eServer xSeries 306 (Type 8836) Installation Guide</i>	This guide describes how to install the IBM eServer xSeries 306, which is the hardware delivered for some versions of the hardware master console.	MIGR-55080
<i>IBM eServer xSeries 306 (Type 8836) User's Guide</i>	This guide describes how to use the IBM eServer xSeries 306, which is the hardware delivered for some versions of the hardware master console.	MIGR-55079
<i>IBM eServer xSeries 306 (Types 1878, 8489 and 8836) Hardware Maintenance Manual and Troubleshooting Guide</i>	This guide can help you troubleshoot problems and maintain the IBM eServer xSeries 306, which is the hardware delivered for some versions of the hardware master console.	MIGR-54820

Title	Description	Order number
<i>IBM eServer xSeries 305 (Type 8673) Installation Guide</i>	This guide describes how to install the IBM eServer xSeries 305, which is the hardware delivered for some versions of the hardware master console.	MIGR-44200
<i>IBM eServer xSeries 305 (Type 8673) User's Guide</i>	This guide describes how to use the IBM eServer xSeries 305, which is the hardware delivered for some versions of the hardware master console.	MIGR-44199
<i>IBM eServer xSeries 305 (Type 8673) Hardware Maintenance Manual and Troubleshooting Guide</i>	This guide can help you troubleshoot problems and maintain the IBM eServer xSeries 305, which is the hardware delivered for some versions of the hardware master console.	MIGR-44094
<i>IBM TotalStorage 3534 Model F08 SAN Fibre Channel Switch User's Guide</i>	This guide introduces the IBM TotalStorage SAN Switch 3534 Model F08.	GC26-7454
<i>IBM System x3250 (Types 4364 and 4365) Installation Guide</i>	This guide describes how to install the IBM System x3250, which is the hardware delivered for some versions of the hardware master console.	MIGR-5069761
<i>IBM System x3250 (Types 4364 and 4365) User's Guide</i>	This guide describes how to use the IBM System x3250, which is the hardware delivered for some versions of the hardware master console.	MIGR-66373
<i>IBM System x3250 (Types 4364 and 4365) Problem Determination and Service Guide</i>	This guide can help you troubleshoot and resolve problems with the IBM System x3250, which is the hardware delivered for some versions of the hardware master console.	MIGR-66374
<i>IBM TotalStorage SAN Switch 2109 Model F16 User's Guide</i>	This guide introduces the IBM TotalStorage SAN Switch 2109 Model F16.	GC26-7439
<i>IBM TotalStorage SAN Switch 2109 Model F32 User's Guide</i>	This guide introduces the IBM TotalStorage SAN Switch 2109 Model F32. It also describes the features of the switch and tells you where to find more information about those features.	GC26-7517

Title	Description	Order number
<i>IBM System Storage Productivity Center Introduction and Planning Guide</i>	This guide introduces the IBM System Storage Productivity Center hardware and software.	SC23-8824
<i>IBM System Storage Productivity Center Hardware Installation and Configuration Guide</i>	This guide describes how to install and configure the IBM System Storage Productivity Center hardware.	SC23-8822
<i>IBM System Storage Productivity Center Software Installation and User's Guide</i>	This guide describes how to install and use the IBM System Storage Productivity Center software.	SC23-8823

Some related publications are available from the following SAN Volume Controller support Web site:

<http://www.ibm.com/storage/support/2145>

Related Web sites

The following Web sites provide information about the SAN Volume Controller or related products or technologies.

Type of information	Web site
SAN Volume Controller support	http://www.ibm.com/storage/support/2145
Technical support for IBM storage products	http://www.ibm.com/storage/support/

How to order IBM publications

The IBM publications center is a worldwide central repository for IBM product publications and marketing material.

The IBM publications center offers customized search functions to help you find the publications that you need. Some publications are available for you to view or download free of charge. You can also order publications. The publications center displays prices in your local currency. You can access the IBM publications center through the following Web site:

<http://www.ibm.com/shop/publications/order/>

How to send your comments

Your feedback is important to help us provide the highest quality information. If you have any comments about this book or any other documentation, you can submit them in one of the following ways:

- e-mail

Submit your comments electronically to the following e-mail address:

starpubs@us.ibm.com

Be sure to include the name and order number of the book and, if applicable, the specific location of the text you are commenting on, such as a page number or table number.

- Mail

Fill out the Readers' Comments form (RCF) at the back of this book. If the RCF has been removed, you can address your comments to:

International Business Machines Corporation
 RCF Processing Department
 Department 61C
 9032 South Rita Road
 Tucson, Arizona 85775-4401
 U.S.A.

Syntax diagrams

A syntax diagram uses symbols to represent the elements of a command and to specify the rules for using these elements.

This explains how to read the syntax diagrams that represent the command-line interface (CLI) commands. In doing so, it defines the symbols that represent the CLI command elements.

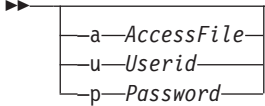
Element	Syntax	Description
Main path line	>>><>() () ()	>>Begins on the left with double arrowheads (>>) and ends on the right with two arrowheads facing each other (()). If a diagram is longer than one line, each line to be continued ends with a single> arrowhead () and the next line begins with a single arrowhead. Read the diagrams from left-to-right, top-to-bottom, following the main path line.
Keyword	▶▶—esscli—▶▶	Represents the name of a command, flag, parameter, or argument. A keyword is not in italics. Spell a keyword exactly as it is shown in the syntax diagram.
Required keywords	▶▶  ▶▶	Indicate the parameters or arguments you must specify for the command. Required keywords appear on the main path line. Mutually exclusive required keywords are stacked vertically.

Element	Syntax	Description
Optional keywords		Indicate the parameters or arguments you can choose to specify for the command. Optional keywords appear below the main path line. Mutually exclusive optional keywords are stacked vertically.
Default value		Appears above the main path line.
Repeatable keyword or value		Represents a parameter or argument that you can specify more than once. A repeatable keyword or value is represented by an arrow returning to the left above the keyword or value.
Variable		Represents the value you need to supply for a parameter or argument, such as a file name, user name, or password. Variables are in italics.
Space separator		Adds a blank space on the main path line to separate keywords, parameters, arguments, or variables from each other.
Quotation mark delimiters		Indicates the start and end of a parameter or argument that contains multiple values. Enclose one or more name-value pairs in a set of double quotation marks for a particular parameter or argument. If the value of a parameter or name-value pair contains a blank or white space, enclose the entire value in a set of single quotation marks.
Equal-sign operator		Separates a name from its value in a name-value pair.
Syntax fragment		Breaks up syntax diagrams that are too long, too complex, or repetitious. The fragment name is inserted in the main diagram, and the actual fragment is shown below the main diagram.

Terminology

These are abbreviations that are most commonly used for the command-line interface operations.

The table below shows the abbreviations that are most commonly used for the command-line interface operations.

Name	Object type
Host	host
Virtual disk	vdisk
Managed disk	mdisk
Managed disk group	mdiskgrp
I/O group	iogrp
Node	node
Cluster	cluster
Controller	controller
FlashCopy [®] mapping	fcmap
FlashCopy consistency group	fcconsistgrp
Metro Mirror or Global Mirror relationship	rcrelationship
Metro Mirror or Global Mirror consistency group	rcconsistgrp
Unsupported/unknown object	unknown

CLI special characters

The following special characters are used in the command-line interface (CLI) command examples.

- minus (-) sign. Flags are prefixed with a - (minus) sign. Flags define the action of a command or modify the operation of a command. You can use multiple flags, followed by parameters, when you issue a command. The - character cannot be used as the first character of an object name.
- vertical bar (|). A vertical bar signifies that you choose only one value. For example, [a | b] in brackets indicates that you can choose a, b, or nothing. Similarly, { a | b } in braces indicates that you must choose either a or b.

Using wildcards in the SAN Volume Controller CLI

You can use wildcards in the SAN Volume Controller Command-Line Interface.

The SAN Volume Controller allows the use of the asterisk (*) as a wildcard within the arguments of certain parameters. There are some behavioral issues that must be considered when using wildcards in order to prevent unexpected results. These behavioral issues and the ways to avoid them are described below.

1. Running the command while logged onto the node.

The shell will attempt to interpret any of the special characters if they are not escaped (preceded with a backslash character). Wildcards will be expanded into a list of files if any files exist that match the wildcards. If no matching files exist, the wildcard is passed to the SAN Volume Controller command untouched.

To prevent expansion, issue the following command in one of its formats:

`svctask cleardumps -prefix '/dumps/*.txt'` with single quotation marks ('), or

`svctask cleardumps -prefix /dumps/*.txt` using a backslash (\), or

`svctask cleardumps -prefix "/dumps/*.txt"` with double quotation marks ("").

2. Running the command through SSH, for example from a host.

This is slightly more complicated since the host shell will process the command line before it is passed through SSH to the shell on the cluster. This means an extra layer of protection is required around the wildcard as the host shell will strip off any protecting quotes and if the wildcard is exposed to the cluster shell, then this will result in the wildcard being expanded in the cluster shell.

To prevent expansion, issue the following command in one of its formats:

`svctask cleardumps "'/dumps/*.txt'"` with single quotation marks (') inside of double quotation marks (""), or

`svctask cleardumps '/dumps/*.txt'` using a backslash (\) inside of single quotation marks ('), or

`svctask cleardumps "'/dumps/*.txt'"` with double quotation marks (") inside of single quotation marks (').

Data types and value ranges

The maximum length of any single parameter that is entered into the command line is 2176 bytes.

Note: If you do not specify a name when you are creating a new object, the cluster assigns a default name. This name is made from the object type as the prefix and the object ID as the suffix. For example, a new virtual disk (VDisk) is created with ID 5. This object is given the default name of vdisk5. Because the system assigns these names, it does not allow you to create an object and call it vdiskx where x is the integer. This is because the cluster reserves these names (for example, object_type_prefix integer) for default.

Data types	Value ranges
filename_arg	<p>This is a (optionally fully qualified) file name. Maximum length is 169 characters. Valid characters consist of the following:</p> <ul style="list-style-type: none">• .• /• -• _• a - z• A - Z• 0 - 9 <p>The field must not contain two consecutive '.', or start with a '.', or end with a '.'.</p>

Data types	Value ranges
directory_or_file_filter	<p>Specifies a directory and or filename filter within the specified directory. Valid directory values consist of the following:</p> <ul style="list-style-type: none"> • /dumps • /dumps/audit • /dumps/configs • /dumps/elogs • /dumps/feature • /dumps/iostats • /dumps/iotrace • /dumps/software <p>The filename filter can be any valid filename with or without the wildcard '*'. The filename filter can be appended to the end of one of the previous directory values. Maximum length is 128 characters. Valid characters consist of the following:</p> <ul style="list-style-type: none"> • * • . • / • - • _ • a - z • A - Z • 0 - 9 <p>The field must not contain two consecutive '.', or start with a '.', or end with a '.'.</p>
filename_prefix	<p>This is a prefix to be used when naming a file. Maximum length is 128 characters. Valid characters consist of the following:</p> <ul style="list-style-type: none"> • a - z • A - Z • 0 - 9 • - • _

Data types	Value ranges
name_arg	<p>Names can be specified or changed using the create and modify functions. The view commands allow you to see both the name and ID of an object.</p> <p>A string of 1 - 15 characters is allowed, composed of characters A - Z, a - z, 0 - 9, - (dash), and _ (underscore).</p> <p>The first character of a <i>name_arg</i> must not be numeric. The first character of an object name cannot be a - (dash) because the CLI interprets it as being the next parameter.</p> <p>When creating a name for an object, the name must not consist of the object type followed only by an integer. The exception is Metro or Global Mirror relationships, which can be named anything as long as the names are unique across the two clusters. This naming convention is used by the system to generate default names. You can not use one of the following reserved words followed by an integer:</p> <ul style="list-style-type: none"> • cluster • controller • fccstgrp • fcmmap • host • io_grp • mdisk • mdiskgrp • node • rccstgrp • rcmap <p>The cluster name is set when the cluster is created.</p>
password	<p>This is a user-defined password. A password must meet the following requirements:</p> <ul style="list-style-type: none"> • Can use a - z, A - Z, 0 - 9 in any sequence • Can use - (dash) but not as the first character • Can use _ (underscore) • Can contain a maximum of 15 characters
serial_number	<p>The format of this number conforms to IBM® standard C-S 1-1121-018 1999-06 Serial Numbering for IBM products. The serial number is 7 digits, the first two of which define the manufacturing location, leaving 5 digits for the product. The standard defines a way to extend the serial number using letters in the place of numbers in the 5-digit field.</p>

Data types	Value ranges
ip_address_arg	The decimal, dotted quad notation, standard rules.
dns_name	Dotted domain name for the subnet that the cluster is in. For example, <code>ibm.com[®]</code> .
hostname	<p>The hostname that is assigned to the cluster. This can be different from the cluster name and you can change the hostname at any time.</p> <p>A combination of the hostname and the <code>dns_name</code> that is used to access the cluster, for example:</p> <p><code>https://hostname.ibm.com/</code></p>
capacity_value	<p>A value with a range of 512 bytes up to 2 petabytes (PB). The value can be expressed in multiples of 1 MB, ranging from 16 MB to 2 PB.</p> <p>Note: The capacity can be specified as MB, KB, GB, or PB. When MB is used, the value is specified in multiples of 512 bytes. A capacity of 0 is valid for a striped/sequential VDisk. The smallest number of supported bytes is 512.</p>
delay_arg	Unassigned integer ranging from 1 to 65535 (minutes for battery test).
node_id	<p>Node IDs differ from other IDs as they are a unique node ID that is assigned when the node is initialized. Node IDs are expressed as 64-bit hexadecimal numbers. For example:</p> <p><code>1A2B30C67AFFE47B</code></p> <p>Node IDs, like other IDs, cannot be modified by user commands.</p>

Data types	Value ranges
xxx_id	<p>All objects are referred to by unique integer IDs that are assigned by the system when the objects are created. All IDs are represented internally as 32-bit integers. Node IDs are an exception.</p> <p>IDs in the following ranges are used to identify the various types of objects:</p> <ul style="list-style-type: none"> • node_id: 1 - 32 • mdisk_grp_id: 0 - 127 • io_grp_id: 0 - 3 (See Note.) • mdisk_id: 0 - 4095 • vdisk_id: 0 - 8191 • host_id: 0 - 127 • flash_const_grp_id: 0 - 255 • remote_const_grp_id: 0 - 255 • fcmapi_id: 0 - 4095 • rcrel_id: 0 - 8191 • controller_id: 0-63 <p>Note: io_group 4 exists but is used only in certain error recovery procedures.</p> <p>These IDs, like node IDs, cannot be modified by user commands.</p> <p>Note: IDs are assigned at run-time by the system and cannot be relied upon to be the same after, for example, the configuration restoration. Use object names in preference to IDs when you are working with objects.</p>
xxx_list	A colon-delimited list of values of type <i>xxx</i> .
wwpn_arg	<p>The fibre channel worldwide port name (WWPN). This is expressed as a 64-bit hexadecimal number, for example:</p> <p>1A2B30C67AFFE47B</p> <p>These numbers must consist of the characters 0 - 9, a - f, and A - F. A command fails if you enter WWPN 0 in the command string.</p>
panel_name	A string of up to 6 characters that correspond to the number on the printed label below the APA display on the front panel of a node in the cluster.
sequence_number	A 32-bit unsigned integer, expressed in decimal.
csi_num_arg	A 32-bit unsigned integer, expressed in decimal.
percentage_arg	An 8-bit unsigned integer, expressed in decimal 0 to 100.
extent_arg	A 32-bit unsigned integer, expressed in decimal.

Data types	Value ranges
num_extents_arg	A 32-bit unsigned integer, expressed in decimal.
threads_arg	An 8-bit unsigned integer, expressed in decimal, valid values, 1, 2, 3, or 4.
velocity_arg	The fabric speed in GBps. Valid values are 1 or 2.
timezone_arg	The ID as detailed in the output of the svcinfolstimezones command.
timeout_arg	The command timeout period. An integer from 0 to 600 (seconds).
stats_time_arg	The frequency at which statistics are gathered. 15 - 60 minutes in increments of 1 minute.
directory_arg	<p>Specifies a directory and or filename filter within the specified directory. The following directory values are valid:</p> <ul style="list-style-type: none"> • /dumps • /dumps/audit • /dumps/configs • /dumps/elogs • /dumps/feature • /dumps/iostats • /dumps/iotrace • /home/admin/upgrade <p>The filename filter can be any valid filename with or without the wildcard <i>'*'</i>.</p> <p>The filename filter can be appended to the end of one of the previous directory values.</p>
locale_arg	<p>The cluster locale setting. Valid values are 0 - 9.</p> <ul style="list-style-type: none"> • 0 US English (default) • 1 Chinese (simplified) • 2 Chinese (traditional) • 3 Japanese • 4 Korean • 5 French • 6 German • 7 Italian • 8 Spanish • 9 Portuguese (Brazilian)
key_arg	A user-defined identifier for an SSH key. A string of up to 30 characters.
user_arg	Specifies the user, either admin or service.
copy_rate	A numeric value of 0 - 100.
copy_type	Specifies the Mirror copy type: Metro or Global.

The maximum number of values that can be entered into a colon-separated list is 128. If more than 128 items are entered into a list an error is returned.

CLI parameters

CLI parameters are found within the syntax diagram.

CLI parameters can be entered in any order except:

1. The first argument following the command name must be the action that is to be performed.
2. Where you are performing an action against a specific object, the object ID or name must be the last argument in the line.

A valid parameter meets the following requirements:

- Parameters can be entered in any order.
- If a parameter has an associated argument, the argument must *always* follow the parameter.
- A parameter *must* start with a '-'; otherwise, it is assumed to be an argument.
- The maximum length of any single parameter that can be entered into the CLI is 128 bytes.
- An argument can contain multiple data items. The maximum number of data items that you can enter into such a list is 128. For a component list, separate the individual items by a colon.

CLI flags

The flags that are listed below are common to all command-line interface (CLI) commands.

- **-?** or **-h**. Print help text. For example, issuing **svcinfo lscluster -h** will provide a list of the actions available with the **svcinfo lscluster** command.
- **-nomsg**. When used, this flag will prevent the display of the successfully created output. For example, if you issue the following:

```
svctask mkmdiskgrp -ext 16
```

it will display:

```
MDisk Group, id [6], successfully created
```

However, if the **-nomsg** parameter had been added, for example:

```
svctask mkmdiskgrp -ext 16 -nomsg
```

then the following would have been displayed:

```
6
```

This parameter can be entered for any command, but is only acted upon by those commands that generate the successfully created outputs. All other commands will ignore this parameter.

CLI messages

Ensure that you are familiar with the command-line interface (CLI) messages.

When some commands complete successfully, textual output is normally provided. However, some commands do not provide any output. The phrase `No feedback` is used to indicate that no output is provided. If the command does not complete successfully, an error is generated. For example, if the command has failed as a result of the cluster being unstable, the following output is provided:

- `CMMVC5786E` The action failed because the cluster is not in a stable state.

Chapter 1. Preparing the SSH client system for the CLI

Before you can issue command-line interface (CLI) commands from the host to the cluster, you must prepare the Secure Shell (SSH) client system.

Microsoft® Windows® operating systems

The master console for the SAN Volume Controller includes the PuTTY client program, which is a Windows SSH client program. The PuTTY client program can be installed on your master console system in one of the following ways:

- If you purchased the master console hardware option from IBM, the PuTTY client program has been preinstalled on the hardware.
- You can use the master console software installation CD to install the PuTTY client program. The master console hardware option and the software-only master console both provide this CD.
- You can use the separate PuTTY client program installation wizard, **putty-<version>-installer.exe**, which is included as part of the SAN Volume Controller Console zip file. You can download the SAN Volume Controller Console zip file from the following Web site:

<http://www.ibm.com/storage/support/2145>

Note: Before you install the PuTTY client program, ensure that your Windows system meets the system requirements. See the *IBM System Storage SAN Volume Controller: Planning Guide* for system requirements.

If you want to use an SSH client other than the PuTTY client, the following Web site offers SSH client alternatives for Windows:

<http://www.openssh.org/windows.html>

AIX® operating systems

For AIX 5L™ 5.1 and 5.2 on Power architecture, you can obtain the OpenSSH client from the Bonus Packs, but you also must obtain its prerequisite, OpenSSL, from the AIX toolbox for Linux® applications for Power Systems. For AIX 4.3.3, you can obtain the software from the AIX toolbox for Linux applications.

You can also obtain the AIX installation images from IBM DeveloperWorks at the following Web site:

<http://oss.software.ibm.com/developerworks/projects/openssh>

Linux operating systems

The OpenSSH client is installed by default on most Linux distributions. If it is not installed on your system, consult your Linux installation documentation or visit the following Web site:

<http://www.openssh.org/portable.html>

The OpenSSH client can run on a variety of additional operating systems. For more information about the openSSH client, visit the following Web site:

Preparing the SSH client system to issue CLI commands

To issue command-line interface (CLI) commands to the cluster from a host, you must prepare the Secure Shell (SSH) client on the host so that the host is accepted by the SSH server on the cluster.

To use a host that requires a different type of SSH client—for example, OpenSSH—follow the instructions for that software.

Perform the following steps to enable your host to issue CLI commands:

1. For the master console and Windows hosts:
 - a. Generate an SSH key pair using the PuTTY key generator.
 - b. Store the SSH clients public key on the cluster (using a browser that points to the SAN Volume Controller Console).
 - c. Configure the PuTTY session for the CLI.
2. For other types of hosts:
 - a. Follow the instructions that are specific to the SSH client to generate an SSH key pair.
 - b. Store the SSH clients public key on the cluster (using a Web browser to point to the SAN Volume Controller Console or the CLI from an already established host).
 - c. Follow the instructions that are specific to the SSH client to establish an SSH connection to the SAN Volume Controller cluster.

Chapter 2. Secure Shell

Secure Shell (SSH) is a client-server network application.

Overview

The SAN Volume Controller cluster acts as the SSH server in this relationship. The SSH client provides a secure environment in which to connect to a remote machine. It uses the principles of public and private keys for authentication.

SSH keys are generated by the SSH software. This includes a public key, which is uploaded and maintained by the cluster and a private key that is kept private to the host that is running the SSH client. These keys authorize specific users to access the administration and service functions on the cluster. Each key is associated with a user-defined ID string that can consist of up to 40 characters. Up to 100 keys can be stored on the cluster. You can also add new IDs and keys or delete unwanted IDs and keys.

Attention: The SAN Volume Controller does not support running multiple SSH sessions concurrently against a single cluster. This can cause the system to lose access to data and cause data to be lost. To avoid running multiple SSH sessions concurrently against a single cluster, do not run scripts that create child processes that run in the background and invoke SAN Volume Controller commands.

Secure Shell (SSH) is a communication vehicle between the host system and the following components:

- The SAN Volume Controller
- The system on which the SAN Volume Controller Console is installed

Authenticating SSH logins

When you are using AIX hosts, SSH logins are authenticated on the cluster using the RSA-based authentication that is supported in the OpenSSH client that is available for AIX. This scheme is based on public-key cryptography, using an algorithm known commonly as RSA.

Note: The authentication process for non-AIX hosts systems is similar.

With this scheme (as in similar OpenSSH systems on other host types), the encryption and decryption is done using separate keys. This means that it is not possible to derive the decryption key from the encryption key.

Because physical possession of the private key allows access to the cluster, the private key must be kept in a protected place, such as the .ssh directory on the AIX host, with restricted access permissions.

When SSH client (A) attempts to connect to SSH server (B), the key pair authenticates the connection. The key consists of two halves: the public keys and private keys. The SSH client public key is put onto SSH Server (B) using some means outside of the SSH session. When SSH client (A) tries to connect, the private key on SSH client (A) is able to authenticate with its public half on SSH server (B).

Connecting the SAN Volume Controller Console to additional clusters

The master console includes the preinstalled the SAN Volume Controller Console Web server and Common Information Model (CIM) Object manager software. This software uses the PuTTY Secure Shell (SSH) client function for the SAN Volume Controller Console to programmatically access the SAN Volume Controller cluster. The master console comes with preinstalled PuTTY SSH keys. You can generate new PuTTY SSH keys that are unique to your master console, copy the private SSH key to the SAN Volume Controller Console directory and store the public SSH key on all clusters that are connected to the SAN Volume Controller Console.

You can also install the SAN Volume Controller Console on a Windows 2000 server system that you provide. If you intend to install the SAN Volume Controller Console on a host that you supply, you must install PuTTY first, which is a prerequisite for the SAN Volume Controller Console.

Configuring a Secure Shell client system other than PuTTY

If you use a Secure Shell (SSH) client system other than the PuTTY client, you must configure that client system before you can access the command-line interface (CLI).

Perform the tasks that are equivalent to the following steps to configure your non-PuTTY SSH client system:

1. Install the SSH client software on the computer that will host the master console. This step is not required for a master console that has the preinstalled PuTTY client.
2. Generate SSH keys on the SSH client system.
3. Configure the PuTTY session, if required, on the SSH client system.
4. If the client system is the master console, copy the private key into the SAN Volume Controller installation directory. If the client system is not the master console, store the private key on the SSH client system.

Attention: Do not run scripts that create child processes that run in the background and invoke SAN Volume Controller commands. This can cause the system to lose access to data and to cause data to be lost.

5. Copy the SSH public key to the master console.
6. Store the SSH client public key on the SAN Volume Controller cluster.

You perform step 6 to store the SSH client public key on the SAN Volume Controller when you complete the creation of the SAN Volume Controller cluster. Once you have defined a cluster to the SAN Volume Controller Console and therefore have enabled SSH communication to the cluster, you can store additional SSH client public keys on the cluster. You can store additional keys through the SAN Volume Controller Console or the CLI.

Generating an SSH key pair using PuTTY

You must generate a Secure Shell (SSH) key pair to use the SAN Volume Controller Console and the command-line interface (CLI).

Perform the following steps to generate SSH keys on the master console using the PuTTY key generator (PuTTYgen):

1. Start PuTTYgen by clicking **Start** → **Programs** → **PuTTY** → **PuTTYgen**. The PuTTY Key Generator panel is displayed.
2. Click **SSH-2 RSA** as the type of key to generate.

Note: Leave the number of bits in a generated key value at 1024.

3. Click **Generate** and then move the cursor around the blank area of the Key section to generate the random characters that create a unique key. When the key has been completely generated, the information about the new key is displayed in the Key section.

Attention: Do not modify the Key fingerprint or the Key comment fields; this can cause your key to no longer be valid.

4. (Optional) If you are generating SSH keys for a computer other than the master console, enter a passphrase in the Key passphrase and Confirm passphrase fields. The passphrase encrypts the key on the disk; therefore, it is not possible to use the key without first entering the passphrase.

Attention: If you are generating the key pair for the master console, do not enter anything in the Key passphrase or the Confirm passphrase fields.

5. Save the public key by performing the following steps:
 - a. Click **Save public key**. You are prompted for the name and location of the public key.
 - b. Type `icat.pub` as the name of the public key and specify the location where you want to save the public key.

Note: For AIX, store the key in the `$HOME/.ssh` directory.

- c. Click **Save**.
6. Save the private key by performing the following steps:
 - a. Click **Save private key**. The PuTTYgen Warning panel is displayed.
 - b. Click **Yes** to save the private key without a passphrase.
 - c. Type `icat` as the name of the private key, and specify the location where you want to save the private key.
 - d. Click **Save**.
 - e. For AIX, store the key in the `$HOME.ssh/identity` file, which is in the `$HOME/.ssh` directory. In the simplest cases, you can replace the contents of the identity file with the contents of the key file. However, when you are using multiple keys, all of these keys must appear in the identity file.
 7. Close the PuTTY Key Generator window.

After the SSH key pair is generated, you must configure the SAN Volume Controller Console to use them. For the private key, you must copy the private key to the directory that is used by the IBM CIM Object Manager. For example, `C:\Program Files\IBM\svconsole\cimom`. For the public key, you use the Add SSH Public Key panel in the SAN Volume Controller Console when you create the cluster.

Configuring the PuTTY session for the CLI

You must configure the PuTTY session using the Secure Shell (SSH) key pair that you have generated before you can use the command-line interface (CLI).

Attention: Do not run scripts that create child processes that run in the background and invoke SAN Volume Controller commands. This can cause the system to lose access to data and cause data to be lost.

Perform the following steps to configure a PuTTY session for the CLI:

1. Select **Start** → **Programs** → **PuTTY** → **PuTTY**. The PuTTY Configuration window opens.
2. Click **Session** in the Category navigation tree. The Basic options for your PuTTY session are displayed.
3. Click **SSH** as the Protocol option.
4. Click **Only on clean exit** as the Close window on exit option. This ensures that connection errors are displayed.
5. Click **Connection** → **SSH** in the Category navigation tree. The options controlling SSH connections are displayed.
6. Click **2** as the Preferred SSH protocol version.
7. Click **Connection** → **SSH** → **Auth** in the Category navigation tree. The Options controller SSH authentication are displayed.
8. Click **Browse** or type the fully-qualified file name and location of the SSH client and private key in the **Private key file for authentication** field. The file that you specify in this field is the one that you stored in the SAN Volume Controller software (for example, C:\Program Files\IBM\svconconsole\cimom\icat.ppk).
9. Click **Session** in the Category navigation tree. The Basic options for your PuTTY session are displayed.
10. Click **Default Settings** and then click **Save**.
11. Type the name or IP address of the SAN Volume Controller cluster in the **Host Name (or IP Address)** field.
12. Type **22** in the **Port** field. The SAN Volume Controller cluster uses the standard SSH port.
13. Type the name that you want to use to associate with this session in the **Saved Sessions** field. For example, you can name the session SAN Volume Controller Cluster 1.
14. Click **Save**.

You have now configured a PuTTY session for the CLI.

Adding subsequent SSH public keys to the SAN Volume Controller

You can add subsequent Secure Shell (SSH) public keys to the SAN Volume Controller from the SSH Public Key Maintenance panel.

This task assumes that you are at the Welcome panel for the SAN Volume Controller Console.

The SSH key allows the master console (where the SAN Volume Controller Console is running) to access the cluster.

During the cluster creation wizard, you added a SSH key to the cluster. You can add additional SSH keys to grant SSH access to other servers.

Perform the following steps to add additional SSH keys:

1. Click **Clusters** in the portfolio.
2. Click the cluster whose SSH keys you want to maintain.
3. Select **Maintain SSH Keys** from the task list and click **Go**. The SSH Public Key Maintenance panel is displayed.

4. Follow the instructions that are on the SSH Public Key Maintenance panel.
5. Click Add Key when you have completed the SSH Public Key Maintenance panel.

After the initial configuration of the cluster has been performed using the SAN Volume Controller Console and at least one SSH client key has been added, the remainder of the configuration can either be performed using the SAN Volume Controller Console or the command-line interface.

Adding SSH keys for hosts other than the master console

You can add Secure Shell (SSH) keys on other hosts.

Perform the following steps to add SSH keys on hosts other than the master console:

1. Generate the public-private key pair on each host that you want to use the SAN Volume Controller command-line interface. See the information that came with your SSH client for specific details about using the key generation program that comes with your SSH client.
2. Copy the public keys from each of these hosts to the master console.
3. Use the PuTTY secure copy function to copy these public keys from the master console to the cluster.
4. Repeat 3 for each public key copied onto the master console in step 2.

Chapter 3. Copying the SAN Volume Controller software upgrade files using PuTTY scp

PuTTY scp (pscp) provides a file transfer application for secure shell (SSH) to copy files either between two directories on the configuration node or between the configuration node and another host.

To use the pscp application, you must have the appropriate permissions on the source and destination directories on your respective hosts.

The pscp application is available when you install an SSH client on your host system. You can access the pscp application through a command prompt.

Perform the following steps to use the pscp application:

1. Start a PuTTY session.
2. Configure your PuTTY session to access your SAN Volume Controller cluster.
3. Save your PuTTY configuration session. For example, you can name your saved session SVCPUTTY.
4. Open a command prompt.
5. Issue the following command to set the path environment variable to include the PuTTY directory:

```
set path=C:\Program Files\putty;%path%
```

Where *Program Files* is the directory where PuTTY is installed.

6. Issue the following command to copy the package onto the node where the CLI runs:

```
directory_software_upgrade_files pscp -load saved_putty_configuration  
software_upgrade_file_name admin@cluster_ip_address:/home/admin/upgrade
```

where *directory_software_upgrade_files* is the directory that contains the software upgrade files, *saved_putty_configuration* is the name of the PuTTY configuration session, *software_upgrade_file_name* is the name of the software upgrade file, and *cluster_ip_address* is the IP address of your cluster.

If there is insufficient space to store the software upgrade file on the cluster, the copy process fails. Perform one of the following steps to provide sufficient space:

- Issue the **svctask cleardumps** CLI command to free space on the cluster and repeat step 6.
- Issue the following command from the cluster to transfer the error logs to the master console:

```
pscp -unsafe -load saved_putty_configuration  
admin@cluster_ip_address:/dump/elogs/* your_desired_directory
```

where *saved_putty_configuration* is the name of the PuTTY configuration session, *cluster_ip_address* is the IP address of your cluster, and *your_desired_directory* is the directory where you want to transfer the error logs.

After you have transferred the error logs to the master console, repeat step 6.

Chapter 4. Audit log commands

An audit log keeps track of action commands that are issued through a Secure Shell (SSH) session or through the SAN Volume Controller Console.

The audit log entries provide the following information:

- Identity of the user who issued the action command
 - From the command-line interface, the user name (administrator or service), and the label that is associated with the user's public SSH key in the authorized keys file
 - From the native Web pages, the user's identity (admin[web] or service[web]) according to which user name the user authenticated with
 - From the SAN Volume Controller Console, the user's identity (administrator), the label that is associated with the CIMOM key in the authorized keys file, and the user name that has been recorded by the CIMOM when the SAN Volume Controller Console user authenticated with the CIMOM
- The name of the actionable command
- The timestamp of when the actionable command was issued on the configuration node
- The parameters which were issued with the actionable command

The following commands are not documented in the audit log:

- svctask dumpconfig
- svctask cpdumps
- svctask cleardumps
- svctask finderr
- svctask dumperrlog
- svctask dumpinternallog
- svcservicetask dumperrlog
- svcservicetask finderr

The following items are also not documented in the audit log:

- Commands that fail are not logged
- A result code of 0 (success) or 1 (success in progress) is not logged
- Result object ID of node type (for the addnode command) is not logged
- Views are not logged

catauditlog

Use the **catauditlog** command to display the in-memory contents of the audit log.

Syntax

```
▶▶ svcinfo — — catauditlog —————▶▶  
▶ [ -first — number_of_entries_to_return ] —————▶▶
```

Parameters

-first *number_of_entries_to_return*

(Optional) Specifies the number of most recent entries to display.

Description

This command lists a specified number of the most recently audited commands.

The in-memory portion of the audit log can hold approximately 1 MB of audit information. Depending on the command text size and the number of parameters, 1 MB records approximately 6000 commands.

Once the in-memory audit log has reached its maximum capacity, the log is written to a local file on the configuration node in the /dumps/audit directory. The **svcinfo catauditlog** command only displays the in-memory part of the audit log; the on-disk part of the audit log is in readable text format and does not need any special command to decode it.

The in-memory log entries are reset and cleared automatically, ready to start accumulating new commands. The on-disk portion of the audit log can then be analyzed at a later date.

The `lsauditlogdumps` command can be used to list the files that are on the disk.

The in-memory portion of the audit log can be transferred to an on-disk file using the **svctask dumpauditlog** command. This action clears the in-memory portion of the log.

Possible failures

- There are no error codes.

In the following example, the user has specified that they want to list the 15 most recent audit log entries.

An invocation example

```
svcinfo catauditlog -delim : -first 15
```

The resulting output

```
audit_seq_no:timestamp:cluster_user:ssh_label:icat_user:result:res_obj_id
:action_cmd
125:06031111800:admin:Joe::0::svctask rmsshkey -key label147 -user admin
126:06031111800:admin:Joe::0::svctask addsshkey -label label148 -file
/home/Joe/id_rsa.pub -user admin
127:06031111800:admin:Joe::0::svctask rmsshkey -key label148 -user admin
128:06031111800:admin:Joe::0::svctask addsshkey -label label149 -file
/home/Joe/id_rsa.pub -user admin
129:06031111800:admin:Joe::0::svctask rmsshkey -key label149 -user admin
130:060311134617:admin:Joe::0::svctask chmdisk -name ca-0 1
131:060311134617:admin:Joe::0::svctask chmdisk -name ca-1 2
132:060311134617:admin:Joe::0::svctask chmdisk -name ca-2 3
133:060311134617:admin:Joe::0::svctask chmdisk -name cb-0 4
134:060311134617:admin:Joe::0::svctask chmdisk -name cb-1 5
135:060311134617:admin:Joe::0::svctask chmdisk -name cb-2 6
136:060311134617:admin:Joe::0::svctask chmdisk -name cc-0 7
137:060311134617:admin:Joe::0::svctask chmdisk -name cc-1 8
138:060311134617:admin:Joe::0::svctask chmdisk -name cc-2 9
139:060311134632:admin:Joe::0::svctask mkmdiskgrp -name cust-mdisks -ext 512
-mdisk ca-0:ca-1:ca-2
```

dumpauditlog

Use the **dumpauditlog** command to reset or clear the contents of the in-memory audit log. The contents of the audit log are sent to a file in the `/dumps/audit` directory on the current configuration node.

Syntax

▶— svctask — — dumpauditlog — —————▶

Parameters

There are no parameters.

Description

This command dumps the contents of the audit log to a file on the current configuration node. It also clears the contents of the audit log. This command is logged as the first entry in the new audit log.

Audit log dumps are automatically maintained in the `/dumps/audit` directory. The local file system space is used by audit log dumps and is limited to 200 MB on any node in the cluster. The space limit is maintained automatically by deleting the minimum number of old audit log dump files so that the `/dumps/audit` directory space is reduced below 200 MB. This deletion occurs once per day on every node in the cluster. The oldest audit log dump files are considered to be the ones with the lowest audit log sequence number. Also, audit log dump files with a cluster ID number that does not match the current one are considered to be older than files that match the cluster ID, regardless of sequence number.

Other than by running dumps (or copying dump files among nodes), you cannot alter the contents of the audit directory. Each dump file name is generated automatically in the following format:

```
auditlog_firstseq_lastseq_timestamp_clusterid
```

where

- *firstseq* is the audit log sequence number of the first entry in the log
- *lastseq* is the audit sequence number of the last entry in the log
- *timestamp* is the timestamp of the last entry in the audit log that is being dumped
- *clusterid* is the cluster ID at the time that the dump was created

The audit log dump files names cannot be changed.

The audit log entries in the dump files contain the same information as displayed by the **svcinfo catauditlog** command; however, the **svctask dumpauditlog** command displays the information with one field per line. The **svcinfo lsauditlogdumps** command displays a list of the audit log dumps that are available on the nodes in the cluster.

Possible failures

- CMMVC5786E The action failed because the cluster is not in a stable state.
- CMMVC5983E The dump file was not created. The file system might be full.

An invocation example

```
svctask dumpauditlog
```

The resulting output

No feedback

lsauditlogdumps

The **lsauditlogdumps** command generates a list of the audit log dumps that are available on the nodes in the cluster.

Syntax

```
svcinfo -- lsauditlogdumps -- [-nohdr] -- [-delim delimiter] -- [node_id | node_name]
```

Parameters

-nohdr

(Optional) By default, headings are displayed for each column of data in a concise style view, and for each item of data in a detailed style view. The **-nohdr** parameter suppresses the display of these headings.

Note: If there is no data to be displayed, headings are not displayed even if the **-nohdr** parameter is specified.

-delim *delimiter*

(Optional) By default in a concise view, all columns of data are space separated. The width of each column is set to the maximum possible width of each item of data. In a detailed view, each item of data has its own row, and if the headers are displayed, the data is separated from the header by a space. The **-delim** parameter overrides this behavior. Valid input for the **-delim** parameter is a 1-byte character. If you enter **-delim :** on the command line, the colon character (:) separates all items of data in a concise view; for example, the spacing of columns does not occur. In a detailed view, the data is separated from its header by the specified delimiter.

node_id | *node_name*

(Optional) Specifies the node ID or name to list the available dumps of the given type. If you do not specify a node, the files on the current configuration node are displayed.

Description

This command lists the dump files that are in the **/dumps/audit** directory on the specified node, or on the configuration node if a node is not specified.

The cluster automatically creates the audit log. The audit log can also be created manually by issuing the **svctask dumpauditlog** command. The audit log comprises the files that are listed by the **svcinfo lsauditlogdumps** command. These files are limited to approximately 200 MB on each node in the cluster, at which point the oldest files are automatically deleted. When the configuration node changes to a

different node in the cluster, any old audit log files are left on the former configuration node. As with other types of dumps, you can retrieve those files using the `cpdumps` command.

Possible failures

- There are no error messages.

An invocation example

```
svcinfolsauditlogdumps
```

The resulting output

```
id auditlog_filename
0 auditlog_0_229_060311234532_0000020060013d8a
1 auditlog_230_475_060312234529_0000020060013d8a
2 auditlog_476_491_060313234527_0000020060013d8a
```

Audit log dump file contents

```
...
Auditlog Entry:23
Audit Sequence Number :138
Timestamp :Sat Mar 11 13:46:17 2006
:Epoch + 1142084777
SVC User :admin
SSH Label :Joe
ICAT User :
Result Object ID :
Result Code :0
Action Command :svctask chmdisk -name cc-2 9
Auditlog Entry:24
Audit Sequence Number :139
Timestamp :Sat Mar 11 13:46:32 2006
:Epoch + 1142084792
SVC User :admin
SSH Label :Joe
ICAT User :
Result Object ID :
Result Code :0
Action Command :svctask mkmdiskgrp -name custa-mdisks -ext
512 -mdisk ca-0:ca-1:ca-2
...
```

Chapter 5. Role-based security commands

Role-based security commands restrict an SVC user's administrative abilities by assigning one of three roles: **Administrator** (admin), **CopyOperator**, or **Monitor** (the default). Use the following three commands to manage role assignments:

mkauth

Assigns the role of **CopyOperator** or **Administrator**

rmauth

Reverts the assigned role to the default role of **Monitor**

lsauth Displays entries in the Role-based Security authorization table

The **Administrator** and **CopyOperator** roles apply only to SSH sessions that are established within the SAN Volume Controller cluster by an **Administrator**. The commands that a user can initiate are determined by the role that is associated with the SSH key that established the session.

As an **Administrator**, a user can initiate all commands, and perform configurations and backups using the **svconfig** backup and restore tool.

By default, **Administrator** users also have the role of **Monitor**. As a **Monitor**, a user can initiate the following SAN Volume Controller CLI commands and functions:

svcinfo commands

All **svcinfo** commands

svctask commands

Only the following commands: **finderr**, **dumpperrlog**, and **dumpinternallog**

svcservicetask commands

Only the following commands: **finderr** and **dumpperrlog**

svconfig backup and restore tool

A configuration backup can be performed; a configuration restore can only be performed by an **Administrator**.

An **Administrator** can also have the role of **CopyOperator**. As a **CopyOperator**, a user can initiate the following SAN Volume Controller CLI commands and functions:

svcinfo commands

All **svcinfo** commands can be initiated.

svctask commands

Only the following commands can be initiated: **finderr**, **dumpperrlog**, **dumpinternallog**, **prestartfcconsistgrp**, **startfcconsistgrp**, **stopfcconsistgrp**, **chfcconsistgrp**, **prestartfcmap**, **startfcmap**, **stopfcmap**, **chfcmap**, **startchrconsistgrp**, **stopchrconsistgrp**, **switchchrconsistgrp**, **chrconsistgrp**, **startchrrelationship**, **stopchrrelationship**, **switchchrrelationship**, **chrrelationship**, **chpartnership**

svcservicetask commands

Only the following commands can be initiated: **finderr** and **dumpperrlog**

svconfig backup and restore tool

A configuration backup can be performed; a configuration restore can only be performed by an **Administrator**.

mkauth

The **mkauth** command changes a user's authorization role from **Monitor** to **CopyOperator** or **Administrator**.

Syntax

```
svctask -- mkauth -- -label -- ssh_key_label --  
-role -- role_name --
```

Parameters

-label *ssh_key_label*

(Required) Specifies the identifier that is associated with the secure shell (SSH) key of the user whose authorization is being created. The SSH key label is the same identifier that you supplied with the **-label** parameter in the **svctask addsshkey** command.

-role *role_name*

(Required) Specifies the name of the role that is assigned to the user, either **CopyOperator** or **Administrator**.

Description

The **mkauth** command allows you to change the default role of **Monitor** to either **CopyOperator** or **Administrator**. The roles that are assigned by the **mkauth** command apply only to SSH sessions that have been established within the SAN Volume Controller cluster by an **Administrator**. The commands that you can initiate in an assigned role are determined by the role that is associated with the SSH key that established the session.

Note: Only one non-default role is supported for each SSH key. If the specified SSH key already has a non-default role, the **mkauth** command fails.

The **CopyOperator** role allows a user to initiate the following SAN Volume Controller CLI commands and functions:

svcinfo commands

All **svcinfo** commands

svctask commands

Only the following commands: **finderr**, **dumperrlog**, **dumpinternallog**, **prestartfcconsistgrp**, **startfcconsistgrp**, **stopfcconsistgrp**, **chfconsistgrp**, **prestartfcmap**, **startfcmap**, **stopfcmap**, **chfcmmap**, **startrcconsistgrp**, **stoprcconsistgrp**, **switchrcconsistgrp**, **chrconsistgrp**, **startrcrelationship**, **stoprcrelationship**, **switchrcrelationship**, **chrrelationship**, **chpartnership**

svcservicetask commands

Only the following commands: **finderr** and **dumperrlog**

svconfig backup and restore tool

A configuration backup can be performed; a configuration restore can only be performed by an **Administrator**.

As an **Administrator**, a user can initiate all commands, and perform configurations and backups using the **svconfig** backup and restore tool.

Possible failures

- CMMVC6238E The command failed because the authorization table is full.
- CMMVC6241E The command failed because the specified role was not found.
- CMMVC6244E The command failed because the specified SSH key was not found.

Note: This command must specify an admin key.

- CMMVC6245E The command cannot set the authorization record to the default role. Use **rmauth** to set the default role.
- CMMVC6252E The command failed authorization because the session SSH key is not valid or was deleted.
- CMMVC6253E The command failed authorization because the session SSH key does not have the requisite role.

An invocation example

In the following example, the user who uses an SSH key with the label “rob” is assigned the role of **CopyOperator**.

```
svctask mkauth -label rob -role CopyOperator
```

The resulting output

```
[No feedback]
```

rmauth

The **rmauth** command removes the authorization that is assigned to **CopyOperator** and **Administrator** users.

Syntax

```
▶▶ svctask — — rmauth — — -label — ssh_key_label —————▶▶
```

Parameters

-label *ssh_key_label*

(Required) Specifies the identifier that is associated with the secure shell (SSH) key of the user whose role authorization is being removed. The SSH key label is the same identifier that is supplied with the **-label** parameter in the **svctask addsshkey** command.

Description

The **rmauth** command removes the explicit authorization that is associated with the SSH key when the role of **CopyOperator** or **Administrator** is assigned. The specified SSH key reverts to the default **Monitor** authorization.

The **Monitor** default role allows a user to initiate the following SAN Volume Controller CLI commands and functions:

svcinfo commands

All **svcinfo** commands.

svctask commands

Only the following commands: **finderr**, **dumperrlog**, and **dumpinternallog**

svcservicetask commands

Only the following commands: **finderr** and **dumperrlog**

svconfig backup and restore tool

A configuration backup can be performed; a configuration restore can only be performed by an **Administrator**.

Possible failures

- CMMVC6239E The command failed because the authorization record was not found or is already set to the default role.
- CMMVC6252E The command failed authorization because the session SSH key is not valid or was deleted.
- CMMVC6253E The command failed authorization because the session SSH key does not have the requisite role.
- CMMVC6244E The command failed because the specified SSH key was not found.

Note: This command must specify an admin key.

An invocation example

In the following example, the authorization user who uses an SSH key with the label “rob” is removed. The authorization level for this user reverts to Monitor.

```
svctask rmath -label rob
```

The resulting output

[No feedback]

lsauth

The **lsauth** command generates a report that lists the default and non-default authorizations for the **admin** user SSH keys. A list of these authorizations also reside in the Role Based Security authorization table.

Syntax

```
svcinfol -lsauth [-label ssh_key_label] [-role Administrator CopyOperator Monitor] [-nohdr] [-delim delimiter]
```

Parameters

-label *ssh_key_label*

(Optional) Specifies the identifier that is associated with the secure shell (SSH) key. The SSH key label is the same identifier that you supplied with the **-label** parameter in the **svctask addsshkey** command.

Note: You cannot use the **-label** and **-role** parameters together.

-role Administrator | CopyOperator | Monitor

(Optional) Generates a report that displays a specific role. You can only specify one role at a time. You must use the capitalization that is specified in the syntax diagram for the designated roles.

You cannot use the **-role** and **-label** parameters together.

-nohdr

(Optional) By default, headings are displayed for each column of data (in a concise style view), and for each item of data (in a detailed style view). Using the **-nohdr** parameter suppresses the display of these headings.

Note: If there is no data to be displayed (an empty view is returned), no headings are displayed even if the **-nohdr** parameter was not used.

-delim delimiter

(Optional) By default in a concise view, all columns of data are separated with spaces. The width of each column is set to the maximum possible width of each item of data. In a detailed view, each item of data has its own row, and if the headers are displayed, the data is separated from the header by a space. Using the **-delim** parameter overrides this behavior. Valid input for the **-delim** parameter is a one-byte character. If you entered `-delim :`, a colon character (:) separates all items of data in a concise view (the spacing of columns does not occur). In a detailed view, the data is separated from its header by the colon character (:).

Description

The **lsauth** command generates a report that displays the entries that are found in the Role Based Security authorization table. If either the **-label** or the **-role** parameter is specified, the output consists only of entries that match the specified criteria.

Possible failures

- CMMVC6241E The command failed because the specified role was not found.
- CMMVC6244E The command failed because the specified SSH key was not found.

Note: This command must specify an admin key.

An invocation example

```
svcinfo lsauth
```

The resulting output

```
id  ssh_label  Role
0   key0       Administrator
1   key1       CopyOperator
2   key2       Monitor
```

Chapter 6. E-mail and inventory event notification commands

This section contains commands for enabling your system for e-mail and inventory event notification. You must supply the IP address of the server that receives the notifications, and you must ensure that the server is running (SAN Volume Controller does perform this type of a check). You can have up to twelve recipients of the notifications.

The following commands are a part of the e-mail and inventory function:

chcluster

Enables the inventory notification function by specifying how often notifications are sent to recipients.

chemail

Modifies settings that are used by the e-mail notification function.

chemailuser

Allows you to modify the e-mail recipient's information.

lscluster

Provides information about the addition of e-mail notification recipients to the cluster.

lsemailuser

Generates a report that lists the users (by user ID or type of user [local or support]) who are receiving e-mail and inventory notifications.

mkemailuser

Allows you to specify the user, the receiving server address, the type of e-mail notification, and to enable inventory notification in the e-mail notification function.

rmemailuser

Removes an existing e-mail recipient from the e-mail notification function.

setemail

Configures your system to use the e-mail notification function.

startemail

Starts the e-mail notification function.

stopemail

Disables the e-mail notification function.

testemail

Sends a test e-mail to a specified user or to all users using the e-mail notification function.

chemail

The **chemail** command allows you to modify the settings that are used by the e-mail notification function. To process this command, at least one of the optional parameters must be specified.

Syntax

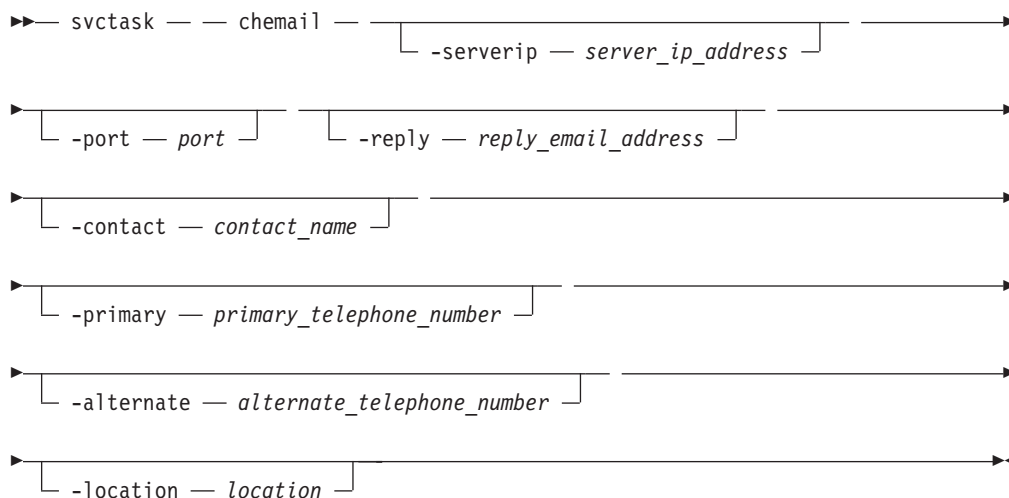

Parameters

-serverip *server_ip_address*
 (Optional) Specifies the IP address of the SMTP e-mail server that is used for the e-mail notification function.

-port *port*
 (Optional) The port number that is used for the server IP address.

-reply *reply_email_address*
 (Optional) Specifies the e-mail address to which a reply is sent.

-contact *contact_name*
 (Optional) Specifies the name of the person to receive the e-mail.

-primary *primary_telephone_number*
 (Optional) Specifies the primary contact telephone number.

-alternate *alternate_telephone_number*
 (Optional) Specifies the alternate contact telephone number that is used when you cannot reach the primary contact on the primary phone.

-location *location*
 (Optional) Specifies the physical location of the system that is reporting the error. The *location* value must not contain punctuation or any other characters that are not alphanumeric or spaces.

Description

This command modifies the specified settings that are used by the e-mail notification function. This command can be run only if the **setemail** command has been run previously. Issue the **lscluster** command to see the state of the e-mail notification function. If a state of stopped or running is displayed, you can successfully process the **chemail** command. If a state of invalid is displayed, you cannot process the **chemail** command, but you can use the **setemail** command instead.

Possible failures

- CMMVC5786E The action failed because the cluster is not in a stable state.
- CMMVC6252E The command failed authorization because the session SSH key is wrong or was deleted.

- CMMVC6253E The command failed authorization because the session SSH key does not have the requisite role.

An invocation example

```
svctask chemail -serverip 9.20.153.255 -port 26 -primary 0441234567
-contact 'fred blogs' -reply fblogs@yahoo.com
-location 'room 256 floor 1 Lampoon House'
```

The resulting output

[No feedback]

chemailuser

The **chemailuser** command modifies the settings that are defined for an e-mail recipient. The *userid* | *username* parameter is required.

Syntax

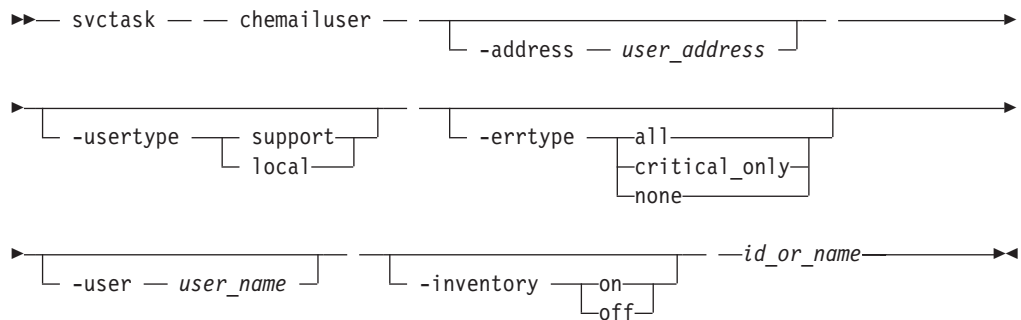

Parameters

-address *user_address*

(Optional) Specifies the e-mail address of the person receiving the e-mail and or inventory notifications.

-usertype **support** | **local**

(Optional) Specifies the type of user, either local or support, based on the following definitions:

support

Address of the support organization that provides vendor support. You cannot specify **support** if the **-errtype** parameter is specified as **all**.

local All other addresses.

-errtype **all** | **critical_only** | **none**

(Optional) Specifies the types of error for which a recipient receives e-mail notification. Recipients can receive the following types of e-mail notifications:

all The recipient receives an e-mail for all errors and events that are logged. You cannot specify this error type if you have specified that the user type is **support**.

critical_only

The recipient receives an e-mail only for critical errors. (Warning and informational errors are not included in the e-mail.)

none No e-mails are sent to this recipient.

-user *user_name*

(Optional) Specifies the name of the person that is the recipient of e-mail notifications. The user name must be unique. If you do not specify a user name, the system automatically assigns a user name in the format of **emailuser*n***, where *n* specifies a number beginning with 1: **emailuser1**, **emailuser2**, and so forth.

The *user_name* value must not contain spaces.

The name **emailuser*n***, where *n* is a number, is reserved and cannot be specified as one of your user names.

-inventory on | off

(Optional) Specifies whether this recipient receives inventory e-mail notifications.

id_or_name

(Required) Specifies the e-mail recipient for whom you are modifying settings.

Description

This command modifies the settings that are established for an e-mail recipient. Standard rules regarding names apply; therefore, it is not possible to change a name to **emailuser*n***, where *n* is a number. Support users must have the error type set to **Critical_only**. If the wrong error type is assigned to a user type, the command fails.

Possible failures

- CMMVC5786E The action failed because the cluster is not in a stable state.
- CMMVC6252E The command failed authorization because the session SSH key is wrong or was deleted.
- CMMVC6253E The command failed authorization because the session SSH key does not have the requisite role.

An invocation example

The following example modifies e-mail settings for e-mail recipient **fblogs**:
svctask chemailuser -usertype service fblogs

The resulting output

[no feedback]

lsemailer

The **lsemailer** command generates a report that lists the e-mail notification settings for all e-mail recipients, an individual e-mail recipient, or a specified type (local or support) of e-mail recipient.

Syntax

```
svctask lsemailer [-type support | local]
```

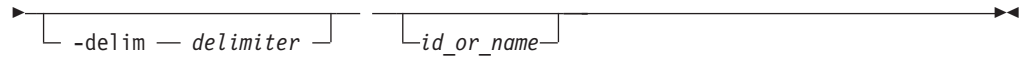

Parameters

-type support | local

(Optional) Specifies the types of e-mail recipients you want to view, either customer or support based as determined by the following definitions:

support

Address of the support organization that provides vendor support. You cannot specify **support** if the **-errtype** parameter is specified as **all**.

local All other addresses.

You cannot use this parameter with the *id_or_name* parameter.

-delim delimiter

(Optional) By default in a concise view, all columns of data are space separated. The width of each column is set to the maximum possible width of each item of data. In a detailed view, each item of data has its own row, and if the headers are displayed the data is separated from the header by a space. The **-delim** parameter overrides this behavior. Valid input for the **-delim** parameter is a one-byte character. If you enter `-delim :` on the command line, a colon separates all items of data in a concise view; the spacing of columns does not occur. In a detailed view, the data is separated from its header by a colon.

id_or_name

(Optional) Specifies the user ID or user name of the e-mail recipient for whom you want to see the e-mail notification settings. You cannot use this parameter with the **-type** parameter.

Description

When you issue this command, a report is displayed that lists the e-mail notification settings for all e-mail recipients, an individual e-mail recipient, or a specified type (local or support) of e-mail recipient. The concise and detailed views report the same information.

Possible failures

- CMMVC5786E The action failed because the cluster is not in a stable state.
- CMMVC6252E The command failed authorization because the session SSH key is wrong or was deleted.
- CMMVC6253E The command failed authorization because the session SSH key does not have the requisite role.

An invocation example

The following command requests information for all e-mail recipients using the e-mail notification function:

```
svcinfo lsemailuser -delim :
```

The resulting output

```

id:name:address:err_type:user_type
1:Support:callhome1@de.ibm.com:critical_only:support
2:Fred:fred_house@my_company.co.uk:critical_only:local
3:Log:our_log@my_company.co.uk:all:local
4:Anne:anne@my_company.co.uk:none:local

```

mkemailuser

The **mkemailuser** command adds a recipient of e-mail and inventory notifications to the e-mail notification function. You can add up to twelve recipients, one recipient at a time.

Syntax

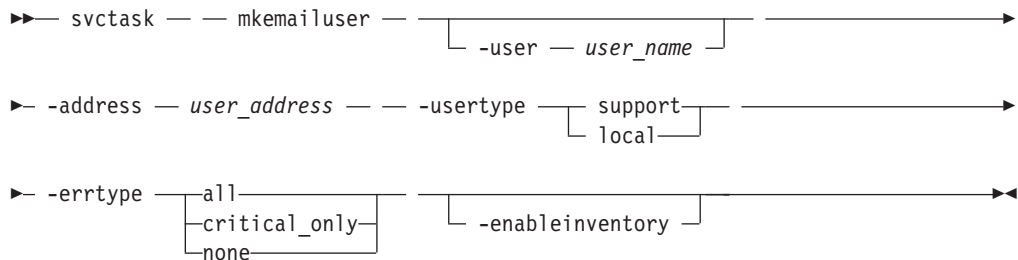

Parameters

-user *user_name*

(Optional) Specifies the name of the person that is the recipient of e-mail notifications. The user name must be unique. If you do not specify a user name, the system automatically assigns a user name in the format of **emailuser n** , where n is a number beginning with 1 (**emailuser1**, **emailuser2**, and so on).

The *user_name* value must not contain spaces.

The name **emailuser n** , where n is a number, is reserved and cannot be used as one of your user names.

-address *user_address*

(Required) Specifies the e-mail address of the person receiving the e-mail or inventory notifications, or both.

-usertype **support** | **local**

(Required) Specifies the type of user, either customer or support, based on the following definitions:

support

Address of the support organization that provides vendor support. You cannot specify **support** if the **-errtype** parameter is specified as **all**.

local All other addresses.

-errtype **all** | **critical_only** | **none**

(Required) Specifies the types of error for which a recipient receives e-mail notification. Recipients can receive the following types of e-mail notifications:

all The recipient receives an e-mail for all errors and events that are logged. You cannot specify this error type if you have specified that the user type is **support**.

critical_only

The recipient receives an e-mail only for critical errors. (Warning and informational errors are not included in the e-mail.)

none No e-mails are sent to this recipient.

-enableinventory

(Optional) Specifies that this recipient is to receive inventory e-mail notifications.

Description

This command adds e-mail recipients to the e-mail and inventory notification function. You can add up to twelve recipients, one recipient at a time. When an e-mail user is added, if a user name is not specified, a default name is allocated by the system. This default name has the form of **emailuser1**, **emailuser2**, and so on. E-mail notification starts when you process the **startemail** command.

Possible failures

- CMMVC5786E The action failed because the cluster is not in a stable state.
- CMMVC6252E The command failed authorization because the session SSH key is wrong or was deleted.
- CMMVC6253E The command failed authorization because the session SSH key does not have the requisite role.

An invocation example

In the following example, you are adding e-mail recipient **fblogs** and designating that **fblogs** receive notification e-mails that contain all error types:

```
svctask mkemailuser -address fblogs@yahoo.com -errtype all -usertype local
```

The resulting output

```
email user, id [2], successfully created
```

rmemailuser

The **rmemailuser** command allows you to remove a previously defined e-mail recipient from your system.

Syntax

```
▶▶ svctask — — rmemailuser — -force — id_or_name ▶▶
```

Parameters

-force *server_ip_address*

(Optional) Specifies that you want to remove the designated user even though the user is the last e-mail recipient in the system. If you try to remove the last recipient using the e-mail notification function and do not use the **-force** parameter, the transaction fails.

id_or_name

(Required) Specifies the user ID or user name of the e-mail recipient to remove.

Description

This command removes an existing e-mail recipient from the system. You must use the **-force** parameter to remove the last e-mail recipient from the e-mail notification function.

Possible failures

- CMMVC5786E The action failed because the cluster is not in a stable state.
- CMMVC6252E The command failed authorization because the session SSH key is wrong or was deleted.
- CMMVC6253E The command failed authorization because the session SSH key does not have the requisite role.

An invocation example

The following example removes e-mail recipient **fblogs**:

```
svctask rmailto user fblogs
```

The resulting output

[No feedback]

An invocation example

The following example removes e-mail recipient **2**:

```
svctask rmailto user 2
```

The resulting output

[No feedback]

sendinventoryemail

The **sendinventoryemail** command sends an inventory e-mail notification to all e-mail recipients that are enabled to receive inventory e-mail notifications. There are no parameters for this command.

Syntax

```
svctask — — sendinventoryemail —————>>
```

Parameters

There are no parameters for this command.

Description

This command sends an inventory e-mail notification to all e-mail recipients that are enabled to receive inventory e-mail notifications. This command fails if the **startemail** command has not been processed and at least one e-mail recipient using the e-mail and inventory notification function has not been set up to receive inventory e-mail notifications. This command also fails if the email infrastructure has not been set up using the **setemail** command.

Possible failures

- CMMVC5786E The action failed because the cluster is not in a stable state.
- CMMVC6252E The command failed authorization because the session SSH key is wrong or was deleted.
- CMMVC6253E The command failed authorization because the session SSH key does not have the requisite role.

An invocation example

In the following example, you send an inventory e-mail notification to all e-mail recipients that are enabled to receive them:

```
svctask sendinventoryemail
```

The resulting output

```
[No feedback]
```

setemail

The **setemail** command allows you to configure your system to use the e-mail notification function. It also allows you to specify which data to include in the header section of all e-mail messages and the details of the server that sends the e-mail.

Syntax

```
▶▶ svctask — — setemail — — -serverip — server_ip_address — —————▶▶
▶▶ -port — port — — -reply — reply_email_address — —————▶▶
▶▶ -contact — contact_name — — -primary — primary_telephone_number — —————▶▶
▶▶ ┌───────────────────────────────────────────────────────────────────────────────────┐ — -location — location —————▶▶
▶▶ │ -alternate — alternate_telephone_number ────────────────────────────────────┘
```

Parameters

-serverip *server_ip_address*

(Required) Specifies the IP address of the SMTP e-mail server that is used for the e-mail notification.

-port *port*

(Required) Specifies the port number that is used for the server IP address.

-reply *reply_email_address*

(Required) Specifies the e-mail address to which a reply is sent.

-contact *contact_name*

(Required) Specifies the name of the person to be contacted.

-primary *primary_telephone_number*

(Required) Specifies the primary contact telephone number.

-alternate *alternate_telephone_number*

(Optional) Specifies the alternate contact telephone number that is used when you cannot reach your primary contact on the primary phone.

-location *location*

(Optional) Specifies the physical location of the system that is reporting the error. The *location* value must not contain punctuation or any other characters that are not alphanumeric or spaces.

Description

This command initializes the settings that are used by the e-mail notification function. These settings define the SMTP server that is used to initiate the e-mail notification and the header information that is included in all e-mail. You must use this command to configure the system before you can start the e-mail notification function.

Possible failures

- CMMVC5786E The action failed because the cluster is not in a stable state.
- CMMVC6252E The command failed authorization because the session SSH key is wrong or was deleted.
- CMMVC6253E The command failed authorization because the session SSH key does not have the requisite role.

An invocation example

```
svctask setemail -serverip 9.20.153.255 -port 26 -primary 01234567890  
-contact 'fred blogs' -reply fblogs@yahoo.com  
-location 'room 256 floor 1 Lampoon House'
```

The resulting output

[No feedback]

startemail

The **startemail** command activates the e-mail and inventory notification function. There are no parameters for this command.

Syntax

▶— svctask — — startemail —————▶

Parameters

There are no parameters for this command.

Description

This command enables the e-mail error notification service. No e-mails are sent to users until the **startemail** command has been run and at least one user has been defined to the system.

Possible failures

- CMMVC5786E The action failed because the cluster is not in a stable state.
- CMMVC6252E The command failed authorization because the session SSH key is wrong or was deleted.
- CMMVC6253E The command failed authorization because the session SSH key does not have the requisite role.

An invocation example

In the following example, you are starting the e-mail error notification service.

```
svctask startemail
```

The resulting output

[No feedback]

stopemail

The **stopemail** command stops the e-mail and inventory notification function. There are no parameters for this command.

Syntax

```
▶▶ svctask — — stopemail —————▶▶
```

Parameters

There are no parameters for this command.

Description

This command stops the e-mail error notification function. No e-mails are sent to users until the **startemail** command is reissued.

Possible failures

- CMMVC5786E The action failed because the cluster is not in a stable state.
- CMMVC6252E The command failed authorization because the session SSH key is wrong or was deleted.
- CMMVC6253E The command failed authorization because the session SSH key does not have the requisite role.

An invocation example

In the following example, you have stopped the e-mail and inventory notification function:

```
svctask stopemail
```

The resulting output

[No feedback]

testemail

The **testemail** command allows you to send an e-mail notification to one user of the e-mail notification function or to all users of the e-mail notification function to ensure that the function is operating correctly.

Syntax

```
▶▶ svctask — — testemail ————  
                                |  
                                | id_or_name |  
                                |  
                                | —all— |  
                                |  
                                ▶▶
```

Parameters

id_or_name

(Required if you do not specify **-all**) Specifies the user ID or user name of the e-mail recipient that you want to send a test e-mail to. You cannot use this parameter with the **-all** parameter. The *id_or_name* value must not contain spaces.

all (Required if you do not specify *id_or_name*) Sends a test e-mail to all the e-mail recipients who are not assigned an error type of **none**, and who are assigned the use of the e-mail notification function. You cannot use this parameter with the *id_or_name* parameter.

Description

This command sends test e-mails to the specified e-mail users. The e-mail recipient expects to receive the test e-mail within a specified service time. If the e-mail is not received within the expected time period, the recipient must contact the administrator to ensure that the e-mail settings for the user are correct. If there is still a problem, you must contact the IBM Support Center.

The e-mail recipient uses the test e-mail to check that the SMTP name, the IP address, the SMTP port, and the user address are valid.

Possible failures

- CMMVC5786E The action failed because the cluster is not in a stable state.
- CMMVC6252E The command failed authorization because the session SSH key is wrong or was deleted.
- CMMVC6253E The command failed authorization because the session SSH key does not have the requisite role.
- CMMVC6269E Sendmail error EX_USAGE. A command or configuration line has been used incorrectly.
- CMMVC6270E Sendmail error EX_DATAERR. Address is wrong, or the message is too large for the mailbox.
- CMMVC6271E Sendmail error EX_NOINPUT. An input file (not a system file) did not exist or was not readable.
- CMMVC6272E Sendmail error EX_NOUSER. The sendmail command could not recognize a specified user ID.
- CMMVC6273E Sendmail error EX_NOHOST. The sendmail command could not recognize the specified host name.
- CMMVC6274E Sendmail error EX_UNAVAILABLE. A required system resource is not available.
- CMMVC6275E Sendmail error EX_SOFTWARE. An internal software error occurred (including bad arguments).
- CMMVC6276E Sendmail error EX_OSERR. A system resource error prevented the sending of an e-mail.
- CMMVC6277E Sendmail error EX_OSFILE. Failed to open a critical system file.
- CMMVC6278E Sendmail error EX_CANTCREAT. An output file could not be written to by sendmail.
- CMMVC6279E Sendmail error EX_IOERR. A system I/O error occurred during a sendmail operation. This could be due to a disk failure.
- CMMVC6280E Sendmail error EX_TEMPFAIL. The sendmail command could not create a connection to a remote system.

- CMMVC6281E Sendmail error EX_PROTOCOL. The remote system returned something that was incorrect during a protocol exchange.
- CMMVC6282E Sendmail error EX_NOPERM. The user does not have permission to perform the requested operation.
- CMMVC6283E Sendmail error EX_CONFIG. There is a fatal problem with the sendmail configuration.
- CMMVC6284E An unknown error occurred. Please ensure your SMTP server is running.
- CMMVC6285E The email command timed out. Please check your email server settings as listed on the SAN Volume Controller.
- CMMVC6286E The email service has not been enabled.
- CMMVC6287E The user specified does not exist.

An invocation example

In the following example, you have sent a test e-mail to **fblogs**:

```
svctask testemail fblogs
```

The resulting output

```
[No feedback]
```

Chapter 7. Cluster commands

SVC cluster commands are used to monitor and modify clusters. An SVC cluster consists of up to four pairs of nodes that provide a single configuration and service interface. There are a number of cluster commands available for various tasks.

addnode

Adds a new (candidate) node to an existing cluster.

chcluster

Modifies the attributes of an existing cluster.

chiogrp

Modifies the name of an I/O group or the amount of memory available for Copy Services.

chnode

Changes the name assigned to a node.

cleardumps

Cleans the various dump directories on a specified node.

cpdumps

Copies dump files from a nonconfiguration node onto the configuration node.

detectmdisk

Rescans the fibre-channel network for new managed disks.

rmnode

Deletes a node from the cluster.

setclustertime

Sets the time for the cluster.

setpwdreset

Changes the status of the password-reset feature for the display panel.

settimezone

Sets the time zone for the cluster.

startstats

Starts the collection of statistics for VDisks and MDisks.

stopcluster

Shuts down a single node or the entire cluster.

stopstats

Stops the collection of statistics for VDisks and MDisks.

addnode

You can use the **addnode** command to add a new (candidate) node to an existing cluster. You can enter this command any time after a cluster has been created. If you are adding a new node to a cluster, you must ensure that the model type of the new node is supported by the SAN Volume Controller software version of the cluster. If the model type is not supported by the cluster software, you must upgrade the cluster to a software version that supports the model type of the new node.

Syntax

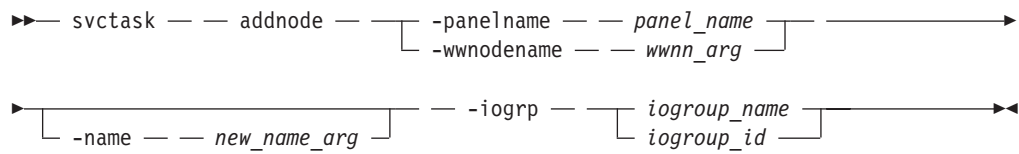

Parameters

-panelname *panel_name*

(Required if you do not specify the **-wwnodename** parameter) Specifies the node that you want to add to a cluster by the name that is displayed on the display panel. You cannot use this parameter with the **-wwnodename** parameter.

-wwnodename *wwnn_arg*

(Required if you do not specify the **-panelname** parameter) Specifies the node that you want to add to the cluster by the worldwide node name (WWNN). You cannot use this parameter with the **-panelname** parameter.

-name *new_name_arg*

(Optional) Specifies a name for the node that you want to add to the cluster.

-iogrp *iogroup_name | iogroup_id*

(Required) Specifies the I/O group to which you want to add this node.

Description

This command adds a new node to the cluster. You can obtain a list of candidate nodes (those that are not already assigned to a cluster) by typing `svcinfo lsnodecandidate`.

Before you add a node to the cluster, you must check to see if any of the following conditions are true. If the following conditions exist, failure to follow the procedures that are documented here might result in the corruption of all data that is managed by the cluster.

- Does the node being added to the cluster use physical node hardware or a slot that has previously been used for a node in the cluster?
- Does the node being added to the cluster use physical node hardware that has been used as a node in another cluster, and are both clusters recognized by the same hosts?

If any of the previous conditions are true, you must take the following actions:

1. Add the node to the same I/O group that it was previously in. You can use the command-line interface command `svcinfo lsnode` or the SAN Volume Controller Console to determine the WWNN of the cluster nodes.
2. Shut down all of the hosts that use the cluster, before you add the node back into the cluster.
3. Add the node back to the cluster before the hosts are restarted. If the I/O group information is unavailable or it is inconvenient to shut down and restart all of the hosts that use the cluster, you can do the following:
 - a. On all of the hosts that are connected to the cluster, unconfigure the fibre-channel adapter device driver, the disk device driver, and the multipathing driver before you add the node to the cluster.

- b. Add the node to the cluster and then reconfigure the fibre-channel adapter device driver, the disk device driver, and multipathing driver.

If you are adding a new node to a cluster, take the following actions:

1. Ensure that the model type of the new node is supported by the SAN Volume Controller software version of the cluster. If the model type is not supported by the cluster software, you must upgrade the cluster to a software version that supports the model type of the new node.
2. Record the node serial number, the WWNN, all WWPNs, and the I/O group to which the node has been added. You might need to use this information later. Having it available can prevent possible data corruption if the node must be removed from and readded to the cluster.

Node addition completes asynchronously; while the node is in the adding state, the WWPN is not known and displays as zeros.

If the compatibility check fails, the following message displays:

```
CMMVC6201E The node could not be added, because incompatible software: status code [%1].
```

Other considerations when you add a node to a cluster:

When you add a node to the cluster using the **svctask addnode** command or the cluster GUI, you must confirm whether the node has previously been a member of the cluster. If it has, follow one of these two procedures:

- Add the node to the same I/O group that it was previously in. You can determine the WWNN of the nodes in the cluster using the **svcinfo lsnode** command.
- If you cannot determine the WWNN of the nodes in the cluster, call the support team to add the node back into the cluster without corrupting the data.

When a node is added to a cluster, it displays a state of adding. It can take as long as 30 minutes for the node to be added to the cluster, particularly if the software version of the node has changed.

Attention: If the node remains in the adding state for more than 30 minutes, contact your support representative to assist you in resolving this issue.

Optionally, you can assign a name to the new node. You can use this name in subsequent commands to refer to the node, instead of using the node ID. If you assign a label, this label is displayed as the node name from then on. If you do not assign a label, the default label is nodeX, where X is the node ID.

Applications on a host system direct I/O operations to file systems or logical volumes that are mapped by the operating system to vpaths, which are pseudo disk objects that are supported by the SDD driver. See the *Multipath Subsystem Device Driver: User's Guide* for more information.

The SDD driver maintains an association between a vpath and a VDisk. This association uses an identifier (UID), which is unique to the VDisk and is not reused. This enables the SDD driver to unambiguously associate vpaths with VDIs.

The SDD device driver operates within a protocol stack, which also contains disk and fibre-channel device drivers that enable it to communicate with the cluster using the SCSI protocol over fibre-channel as defined by the ANSI FCS standard. The addressing scheme that is provided by these SCSI and fibre-channel device drivers uses a combination of a SCSI logical unit number (LUN) and the worldwide name for the fibre-channel node and ports.

In the event of errors, error recovery procedures (ERPs) operate at various tiers in the protocol stack. Some of these ERPs cause I/O to be redriven using the same WWNN and LUN numbers which were previously used.

The SDD device driver does not check the association of the VDisk with the vpath on every I/O operation that it performs.

Possible failures

- CMMVC5707E Required parameters are missing.
- CMMVC5786E The action failed because the cluster is not in a stable state.
- CMMVC5790E The node was not added to the cluster because the maximum number of nodes has been reached.
- CMMVC5791E The action failed because an entity that was specified in the command does not exist.
- CMMVC5792E The action failed because the I/O group is used for recovery.
- CMMVC5793E The node was not added to the cluster because the I/O group already contains a pair of nodes.
- CMMVC5777E The node was not added to the I/O group because the other node in the I/O group is in the same power domain.
- CMMVC6201E The node could not be added, because incompatible software: status code [%1].

An invocation example

```
svctask addnode -wwnodename 5005076801e08b053564 -iogrp io_grp0
```

The resulting output

```
Node, id [6], successfully added
```

chcluster

The **chcluster** command modifies the attributes of an existing cluster. You can enter this command any time after a cluster has been created. All the parameters that are associated with this command are optional. However, you must specify one or more parameters with this command.

Syntax

```

▶▶▶ svctask — — chcluster — —————▶
                                └── -clusterip — cluster_ip_address ───┘
▶ ───────────────────────────────────▶ ───────────────────────────────────▶
└── -serviceip ─── service_ip_address ───┘ └── -name — cluster_name ───┘
    └── DHCP ───────────────────────────┘

```

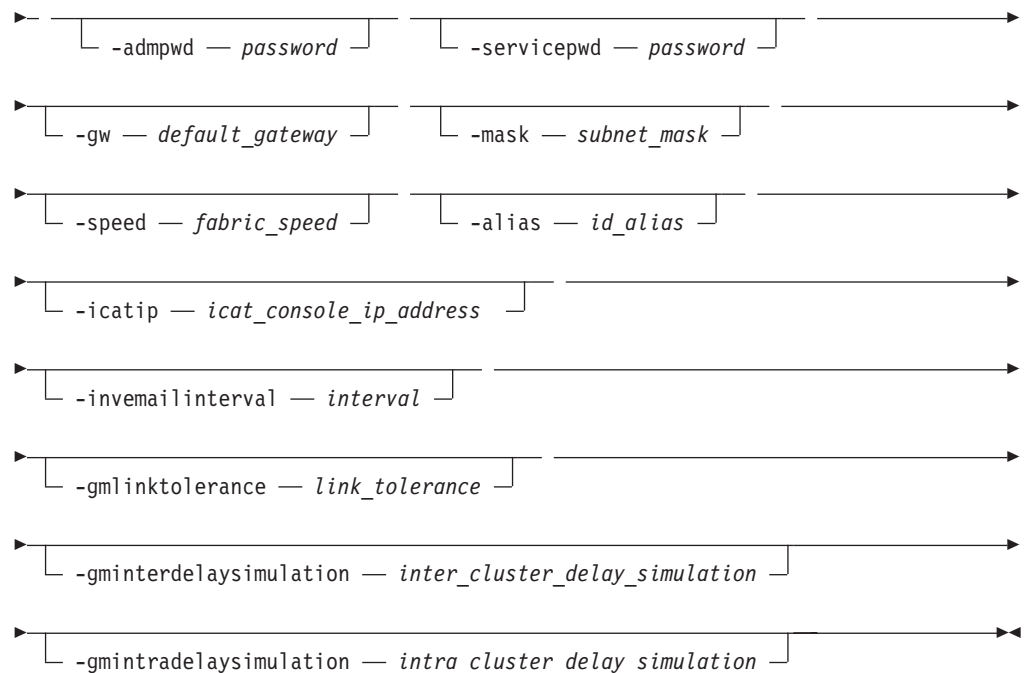

Parameters

-clusterip *cluster_ip_address*

(Optional) Specifies the new cluster IP address.

Note: After the cluster IP address is changed, you lose the open shell connection to the cluster. You must reconnect with the newly specified IP address.

-serviceip *service_ip_address*

(Optional) Specifies the new service IP address. This address is the address to use if the node must be started after it has been released from the cluster. Specify either a fixed IP address or **DHCP** to use a dynamic IP address.

-name *cluster_name*

(Optional) Specifies a new name for the cluster.

-admpwd *password*

(Optional) Specifies a new administrator password. You can specify this parameter with or without the password. If this parameter is not followed by a password, you are prompted for the password. When you type the password in response to the prompt, the password is not displayed.

Note: Only a user with administrator authority can change the password.

-servicepwd *password*

(Optional) Specifies a new service user password. You can specify this parameter with or without the password. If the parameter is not followed by a password, you are prompted for the password. When you type the password in response to the prompt, the password is not displayed.

Note: Only a user with administrator authority can change the password.

-gw *default_gateway*

(Optional) Specifies the new default gateway IP address of the cluster.

- mask** *subnet_mask*
(Optional) Specifies the new subnet mask of the cluster.
- speed** *fabric_speed*
(Optional) Specifies the speed of the fabric to which this cluster is attached. Valid values are 1 or 2 (GB).

Attention: Changing the speed on a running cluster breaks I/O service to the attached hosts. Before changing the fabric speed, stop I/O from active hosts and force these hosts to flush any cached data by demounting volumes (for UNIX host types) or by removing drive letters (for Windows host types). Some hosts might need to be rebooted to detect the new fabric speed.

The fabric speed setting applies only to the 4F2 and 8F2 model nodes in a cluster. The 8F4 nodes automatically negotiate the fabric speed on a per-port basis.
- alias** *id_alias*
(Optional) Specifies an alternate name that does not change the basic ID for the cluster, but does influence the VDisk_UID of every **vdiskhostmap**, both existing and new. These objects appear to have been created for a cluster whose ID matches the alias.
- icatip** *icat_console_ip_address*
(Optional) Specifies the new IP address that is used by this cluster. The format of this IP address must be a dotted decimal notation with the port (for example, 255.255.255.255:8080).
- invemailinterval** *interval*
(Optional) Specifies the interval at which inventory e-mails are sent to the designated e-mail recipients. The interval range is 0 to 15. The interval is measured in days. Setting the value to 0 turns the inventory e-mail notification function off.
- gmlinktolerance** *link_tolerance*
(Optional) Specifies the length of time, in seconds, for which an inadequate intercluster link is tolerated for a Global Mirror operation. The parameter accepts values from 60 to 86 400 seconds in steps of 10 seconds. The default is 300 seconds. You can disable the link tolerance by entering a value of zero (0) for this parameter.
- gminterdelaysimulation** *inter_cluster_delay_simulation*
(Optional) Specifies the intercluster delay simulation, which simulates the Global Mirror round trip delay between two clusters, in milliseconds. The default is 0; the valid range is 0 to 100 milliseconds.
- gmintradelaysimulation** *intra_cluster_delay_simulation*
(Optional) Specifies the intracenter delay simulation, which simulates the Global Mirror round trip delay in milliseconds. The default is 0; the valid range is 0 to 100 milliseconds.

Description

This command modifies specific features of a cluster. Multiple features can be changed by issuing a single command.

If the cluster IP address is changed, the open command-line shell closes during the processing of the command. You must reconnect to the new IP address.

The service IP address is not used until a node is expelled from the cluster. If this node cannot rejoin the cluster, you can bring the node up in service mode. In this mode, the node can be accessed as a stand-alone node using the service IP address.

All command parameters are optional; however, you must specify at least one parameter.

Modifying a password: To change the administrator user password, issue the **svtask chcluster -admpwd *password*** command. To change the service user password, issue the **svtask chcluster -admpwd *password*** command.

Note: If you do not want the password to display as you enter it on the command line, omit the new password. The command line tool then prompts you to enter and confirm the password without the password being displayed.

Modifying an IP address: List the IP address of the cluster by issuing the **svinfo lscluster** command. Modify the IP address by issuing the **svtask chcluster** command. You can either specify a static IP address or have the system assign a dynamic IP address.

Possible failures

- CMMVC5786E The action failed because the cluster is not in a stable state.
- CMMVC5789E The cluster was not modified because the IP address, subnet mask, service address, SNMP address, or gateway address is not valid.
- CMMVC6252E The command failed authorization because the session SSH key is wrong or was deleted.
- CMMVC6253E The command failed authorization because the session SSH key does not have the requisite role.

An invocation example

```
svtask chcluster -clusterip 9.20.165.16 -servicepwd myownpassw0rd -gw 9.13.56.87
```

The resulting output

No feedback

chiogrp

| The **chiogrp** command modifies the name of an I/O group or the amount of
| memory that is available for Copy Services operations.

Syntax

| ▶▶ svtask — — chiogrp — — [-name — *new_name*] —————▶

| [-feature [flash remote] — -size — *memory_size* [-kb]] —————▶

| [*io_group_id*] —————▶
| [*io_group_name*] —————▶

Parameters

-name *new_name*

(Optional) Specifies the name to assign to the I/O group. The **-name** parameter cannot be specified with the **-feature**, **-size**, or **-kb** parameters.

-feature **flash** | **remote**

(Optional) Specifies the Copy Services function to modify the amount of memory for. You must specify this parameter with the **-size** parameter. You cannot specify this parameter with the **-name** parameter.

Note: Specifying **remote** changes the amount of memory that is available for Metro Mirror and Global Mirror processing.

-size *memory_size*

(Optional) Specifies the amount of memory that is available for the specified Copy Services function. Valid input is 0 or any integer. The default unit of measurement for this parameter is megabytes (MB); you can use the kilobytes **-kb** parameter to override the default. You must specify this parameter with the **-feature** parameter. You cannot specify this parameter with the **-name** parameter.

-kb

(Optional) Changes the units for the **-size** parameter from megabytes (MB) to kilobytes (KB). If you specify this parameter, the **-size** *memory_size* value must be any number divisible by 4. You must specify this parameter with the **-feature** and **-size** parameters. You cannot specify this parameter with the **-name** parameter.

io_group_id | *io_group_name*

(Required) Specifies the I/O group to modify. You can modify an I/O group by using the **-name** or the **-feature** parameter.

Description

The **chiogrp** command modifies the name of an I/O group or the amount of memory that is available for Copy Services. You can assign a name to an I/O group or change the name of a specified I/O group. You can change the amount of memory that is available for Copy Services operations by specifying the **-feature** **flash** | **remote** parameter and a memory size. FlashCopy and Metro Mirror/Global Mirror memory is traded against memory that is available to the cache. The amount of memory can be decreased or increased. Consider the following memory sizes when you use this command:

- The default memory size for FlashCopy is 20 MB.
- The default memory size for Metro Mirror / Global Mirror is 20 MB.
- The maximum memory size for FlashCopy is 128 MB.
- The maximum memory size for Metro Mirror / Global Mirror is 128 MB.
- The maximum combined memory size across all features is 128 MB.

Table 1 on page 45 demonstrates the amount of memory required for each copy service. Each 1 MB of memory provides the following VDisk capacities and grain sizes:

Table 1. Memory required for each copy service

Copy Service	Grain size	1 MB of memory provides the following VDisk capacity for the specified I/O group
Metro Mirror / Global Mirror	256 KB	2 TB of total Metro Mirror / Global Mirror VDisk capacity
FlashCopy	256 KB	2 TB of total FlashCopy source VDisk capacity
FlashCopy	64 KB	512 GB of total FlashCopy source VDisk capacity
Incremental FlashCopy	256 KB	1 TB of total Incremental FlashCopy source VDisk capacity
Incremental FlashCopy	64 KB	256 GB of total Incremental FlashCopy source VDisk capacity

For multiple FlashCopy targets, you must consider the number of mappings. For example, for a mapping with a 256 KB grain size, 8 KB of memory allows one mapping between a 16 GB source VDisk and a 16 GB target VDisk. Alternatively, for a mapping with a 256 KB grain size, 8 KB of memory allows two mappings between one 8 GB source VDisk and two 8 GB target VDIs.

When you create a FlashCopy mapping, if you specify an I/O group other than the I/O group of the source VDisk, the memory accounting goes towards the specified I/O group, not towards the I/O group of the source VDisk.

Possible failures

- CMMVC5786E The action failed because the cluster is not in a stable state.
- CMMVC5800E The action failed because an entity that was specified in the command does not exist.
- CMMVC5792E The action failed because the I/O group is used for recovery.
- CMMVC6252E The command failed authorization because the session SSH key is wrong or was deleted.
- CMMVC6253E The command failed authorization because the session SSH key does not have the requisite role.
- CMMVC6288E The command failed because one of the nodes in the specified I/O group was offline when the command was issued.
- CMMVC6289E The command failed because there is not enough memory available for reservation.
- CMMVC6290E The command failed because the cluster was not stable when the command was issued.
- CMMVC6291E The specified size exceeds the maximum permitted for this feature.
- CMMVC6292E The specified size is too big. Total size of memory across all features exceeds maximum permitted.
- CMMVC6293E The specified size is too small. Total size cannot be reduced by more than the amount of free memory.

An invocation example

```
svctask chiogrp -name testiogrpone io_grp0
```

The resulting output

No feedback

An invocation example for changing the amount of FlashCopy memory in io_grp0 to 30 MB

```
svctask chiogrp -feature flash -size 30 io_grp0
```

The resulting output

No feedback

chnode

You can use the **chnode** command to change the name that is assigned to a node. The name can then be used when running subsequent commands.

Syntax

```
svctask -- chnode -- -name -- new_node_name -- [ node_name | node_id ]
```

Parameters

-name *new_node_name*

Specifies the name to assign to the node.

node_name | *node_id*

Specifies the node to be modified. The variable that follows the parameter is either:

- The node name that you assigned when you added the node to the cluster.
- The node ID that is assigned to the node (not the worldwide node name).

Description

This command changes the name of the node in question. The node name can then be used when running subsequent commands.

You can use the **chnode** command to change the name that is assigned to a node. The name can then be used when running subsequent commands.

Possible failures

- CMMVC5786E The action failed because the cluster is not in a stable state.
- CMMVC5798E The action failed because the node is offline.

An invocation example

```
svctask chnode -name testnodeone nodeone
```

The resulting output

No feedback

cleardumps

The **cleardumps** command cleans the various dump directories on a specified node.

Syntax

```
svctask --cleardumps -- -prefix -- directory_or_file_filter --
```

The diagram shows a horizontal line with arrows at both ends, representing the command syntax. Below the line, a bracket indicates that the parameters *node_id* and *node_name* are optional and can be used interchangeably.

Parameters

-prefix *directory_or_file_filter*

(Required) Specifies the directory, files, or both to be cleaned. If a directory is specified, with no file filter, all relevant dump or log files in that directory are cleaned. You can use the following directory arguments (filters):

- **/dumps** (cleans all files in all subdirectories)
- **/dumps/audit**
- **/dumps/configs**
- **/dumps/elogs**
- **/dumps/feature**
- **/dumps/iostats**
- **/dumps/iotrace**
- **/home/admin/upgrade**

In addition to the directory, you can specify a filter file. For example, if you specify `/dumps/elogs/*.txt`, all files in the **/dumps/elogs** directory that end in `.txt` are cleaned.

Note: The following rules apply to the use of wildcards with the SAN Volume Controller CLI:

- The wildcard character is an asterisk (*).
- The command can contain a maximum of one wildcard.
- With a wildcard, you must use double quotation marks (" ") around the filter entry, such as in the following entry:

```
>svctask cleardumps -prefix "/dumps/elogs/*.txt"
```

node_id | *node_name*

(Optional) Specifies the node to be cleaned. The variable that follows the parameter is either:

- The node name, that is, the label that you assigned when you added the node to the cluster
- The node ID that is assigned to the node (not the worldwide node name).

Description

This command deletes all the files that match the `directory/file_filter` argument on the specified node. If no node is specified, the configuration node is cleaned.

You can clean all the dumps directories by specifying `/dumps` as the directory variable.

You can clean all the files in a single directory by specifying one of the directory variables.

You can list the contents of these directories on the given node by using the `svcinfo lsxxxxdumps` commands.

You can use this command to clean specific files in a given directory by specifying a directory or file name. You can use the wildcard character as part of the file name.

Note: To preserve the configuration and trace files, any files that match the following wildcard patterns are not cleaned:

- `*svc.config*`
- `*.trc`
- `*.trc.old`

Possible failures

- **CMMVC5985E** The action failed because the directory that was specified was not one of the following directories: `/dumps`, `/dumps/iostats`, `/dumps/iotrace`, `/dumps/feature`, `/dumps/configs`, `/dumps/elogs`, or `/home/admin/upgrade`.

An invocation example

```
svctask cleardumps -prefix /dumps/configs
```

The resulting output

No feedback

cpdumps

The `cpdumps` command copies dump files from a nonconfiguration node onto the configuration node.

Note: In the rare event that the `/dumps` directory on the configuration node is full, the copy action ends when the directory is full and provides no indicator of a failure. Therefore, clear the `/dumps` directory after migrating data from the configuration node.

Syntax

```
svctask -- cpdumps -- -prefix [ directory | file_filter ]
[ node_name | node_id ]
```

Parameters

-prefix *directory* | *file_filter*

(Required) Specifies the directory, or files, or both to be retrieved. If a directory is specified with no file filter, all relevant dump or log files in that directory are retrieved. You can use the following directory arguments (filters):

- `/dumps` (retrieves all files in all subdirectories)
- `/dumps/audit`
- `/dumps/configs`
- `/dumps/elogs`
- `/dumps/feature`
- `/dumps/iostats`
- `/dumps/iotrace`
- `/home/admin/upgrade`

In addition to the directory, you can specify a file filter. For example, if you specified `/dumps/elogs/*.txt`, all files in the `/dumps/elogs` directory that end in `.txt` are copied.

Note: The following rules apply to the use of wildcards with the SAN Volume Controller CLI:

- The wildcard character is an asterisk (*).
- The command can contain a maximum of one wildcard.
- When you use a wildcard, you must surround the filter entry with double quotation marks (""), as follows:

```
>svctask cleardumps -prefix "/dumps/elogs/*.txt"
```

node_id | *node_name*

(Required) Specifies the node from which to retrieve the dumps. The variable that follows the parameter can be one of the following:

- The node name, or label that you assigned when you added the node to the cluster
- The node ID that is assigned to the node (not the worldwide node name).

If the node specified is the current configuration node, no file is copied.

Description

This command copies any dumps that match the directory or file criteria from the given node to the current configuration node.

You can retrieve dumps that were saved to an old configuration node. During failover processing from the old configuration node to another node, the dumps that were on the old configuration node are not automatically copied. Because access from the CLI is only provided to the configuration node, cluster files can only be copied from the configuration node. This command enables you to retrieve files and place them on the configuration node so that you can then copy them.

You can view the contents of the directories by using the `svcinfolxxxxdumps` commands.

Possible failures

- CMMVC5985E The action failed because the directory that was specified was not one of the following directories: `/dumps`, `/dumps/iostats`, `/dumps/iotrace`, `/dumps/feature`, `/dumps/configs`, `/dumps/elogs`, or `/home/admin/upgrade`.

An invocation example

```
svctask cpdumps -prefix /dumps/configs nodeone
```

The resulting output

detectmdisk

The **detectmdisk** command allows you to manually rescan the fibre-channel network for any new managed disks (MDisks) that might have been added and to rebalance MDisk access across all available controller device ports.

Syntax

```
svctask — — detectmdisk —————▶▶
```

Description

This command causes the cluster to rescan the fibre-channel network. The rescan discovers any new MDisks that have been added to the cluster and rebalances MDisk access across the available controller device ports. This command also detects any loss of controller port availability, and updates the SAN Volume Controller configuration to reflect any changes.

Note: Although it might appear that the **detectmdisk** command has completed, some extra time might be required for it to run. The **detectmdisk** is asynchronous and returns a prompt while the command continues to run in the background. You can use the **lsdiscoverystatus** command to list the discovery status.

In general, the cluster automatically detects disks when they appear on the network. However, some fibre-channel controllers do not send the required SCSI primitives that are necessary to automatically discover the new disks.

If you have attached new storage and the cluster has not detected it, you might need to run this command before the cluster detects the new disks.

When back-end controllers are added to the fibre-channel SAN and are included in the same switch zone as a cluster, the cluster automatically discovers the back-end controller and determines what storage is presented to it. The SCSI LUs that are presented by the back-end controller are displayed as unmanaged MDisks. However, if the configuration of the back-end controller is modified after this has occurred, the cluster might be unaware of these configuration changes. Run this command to rescan the fibre-channel network and update the list of unmanaged MDisks.

Note: The automatic discovery that is performed by the cluster does not write to an unmanaged MDisk. Only when you add an MDisk to an MDisk group or use an MDisk to create an image mode virtual disk is the storage actually used.

To identify the available MDisks, issue the **svctask detectmdisk** command to scan the fibre-channel network for any MDisks. When the detection is complete, issue the **svcinfo lsmdiskcandidate** command to show the unmanaged MDisks; these MDisks have not been assigned to an MDisk group. Alternatively, you can issue the **svcinfo lsmdisk** command to view all of the MDisks.

If disk controller ports have been removed as part of a reconfiguration, the SAN Volume Controller detects this change and reports error 1630 **Number of device**

logins reduced, because it cannot distinguish an intentional reconfiguration from a port failure. If the error persists and redundancy has been compromised, the more serious error 1627 **Insufficient redundancy in disk controller connectivity** is reported. You must issue the **svctask detectmdisk** command to force SAN Volume Controller to update its configuration and accept the changes to the controller ports.

Note: Only issue the **svctask detectmdisk** command when all of the disk controller ports are working and correctly configured in the controller and the SAN zoning. Failure to do this could result in errors not being reported.

Possible failures

- CMMVC5786E The action failed because the cluster is not in a stable state.
- CMMVC6252E The command failed authorization because the session SSH key is wrong or was deleted.
- CMMVC6253E The command failed authorization because the session SSH key does not have the requisite role.

An invocation example

```
svctask detectmdisk
```

The resulting output

```
No feedback
```

rmnode

The **rmnode** command deletes a node from the cluster. You can enter this command any time after a cluster has been created.

Syntax

```
▶▶ svctask — — rmnode — — [ node_name ] —————▶▶  
                             [ node_id ]
```

Parameters

node_name | *node_id*

Specifies the node to be deleted. The value for this parameter can be one of the following:

- The node name that you assigned when you added the node to the cluster
- The node ID that is assigned to the node (not the worldwide node name).

Description

This command deletes a node from the cluster. This makes the node a candidate to be added back into this cluster or into another cluster. After the node is deleted, the other node in the I/O group goes into write-through mode until another node is added back into the I/O group.

Prerequisites:

Before you issue the **rmnode** command, perform the following tasks and read the following Attention notices to avoid losing access to data:

1. Determine which virtual disks (VDisks) are still assigned to this I/O group by issuing the following command. The command requests a filtered view of the VDisks, where the filter attribute is the I/O group.

```
svcinfo lsvdisk -filtervalue IO_group_name=name
```

where *name* is the name of the I/O group.

Note: Any VDisks that are assigned to the I/O group that this node belongs to are assigned to the other node in the I/O group; the preferred node is changed. You cannot change this setting back.

2. Determine the hosts that the VDisks are mapped to by issuing the **svcinfo lsvdiskhostmap** command.
3. Determine if any of the VDisks that are assigned to this I/O group contain data that you need to access:
 - If you *do not* want to maintain access to these VDisks, go to step 5.
 - If you *do* want to maintain access to some or all of the VDisks, back up the data or migrate the data to a different (online) I/O group.
4. Determine if you need to turn the power off to the node:
 - If this is the last node in the cluster, you do not need to turn the power off to the node. Go to step 5.
 - If this is *not* the last node in the cluster, turn the power off to the node that you intend to remove. This step ensures that the Subsystem Device Driver (SDD) does not reidentify the paths that are manually removed before you issue the delete node request.
If you plan to add the node back into the cluster, see **Adding a node back into the cluster:** below.
5. Update the SDD configuration for each virtual path (vpath) that is presented by the VDisks that you intend to remove. Updating the SDD configuration removes the vpaths from the VDisks. Failure to update the configuration can result in data corruption. See the *Multipath Subsystem Device Driver: User's Guide* for details about how to dynamically reconfigure SDD for the given host operating system.
6. Quiesce all I/O operations that are destined for the node that you are deleting. Failure to quiesce the operations can result in failed I/O operations being reported to your host operating systems.

Attention:

1. Removing the last node in the cluster destroys the cluster. Before you delete the last node in the cluster, ensure that you want to destroy the cluster.
2. If you are removing a single node and the remaining node in the I/O group is online, the data can be exposed to a single point of failure if the remaining node fails.

Notes:

1. If the node you are removing is the configuration node, it can take one or two minutes to complete the command.
2. If the node you are removing is the last node in the cluster, the cluster might seem to hang for up to 3 minutes because you have removed the last access point to the cluster.

Deleting a node from a cluster:

Note:

1. If this is the last node in the I/O group or the last node in the cluster, you must force the removal.
2. If this is the last node in the cluster or if it is currently assigned as the configuration node, all connections to the cluster are lost. The user interface and any open CLI sessions are lost if the last node in the cluster is deleted. Deleting the configuration node results in CLI failover processing to another node. A time-out might occur if a command cannot be completed before the node is deleted.

Issue the **svctask rmnode** command to delete a node from the cluster. You can enter this command any time after a cluster has been created.

Adding a node back into the cluster:

If you turn the power back on to the node that has been removed while it is still connected to the same fabric or zone, the following actions occur:

1. The node attempts to join the cluster again.
2. The cluster signals the node to remove itself from the cluster.
3. The node becomes a candidate for addition to this cluster or another cluster.

If you intend to add this node back into the cluster, ensure that you add it back to the same I/O group from which you are deleting it. Otherwise, data corruption might occur.

Before you add a node back into the cluster, you need to know the following information, which should have been recorded when the node was originally added to the cluster.

- Node serial number
- WWNN
- All worldwide port names (WWPNs)
- I/O group that contains the node

If you do not have access to this information, call the service team to add the node back into the cluster without corrupting the data.

Replacing a failed node:

If a node fails, the cluster continues to operate with degraded performance until the failed node is repaired. To enhance availability, you can replace the failed node and repair the failed node offline. However, you must follow certain procedures to replace a failed node without interrupting I/O or risking data integrity when the repaired node is reconnected to the SAN fabric. The procedures include changing the worldwide node name (WWNN) of the replacement node. This procedure must be followed with care to avoid duplicate WWNNs, which are illegal and can cause data corruption.

Prerequisites:

Before replacing the failed node, you must perform the following tasks:

- Ensure that the GUI that is used to access the cluster and spare node is running at least version 1.1.1 of the software.
- Know the cluster name that contains the failing node.

- Confirm that a spare node is in the same rack as the cluster containing the failed node.
- Make a record of the last five characters of the original WWNN. This identification is needed if you decide in the future to designate the spare node as a normal node that can be assigned to any cluster. Use the `svcinfo lsnode` command to see the WWNN.

Additional Information

When you replace a node, the following process takes place:

- The node Front Panel ID changes. This is the number that is printed on the front of the node, which is used to select the node that is added to a cluster.
- The node name might change. If you permit the cluster to assign default names when you add nodes to the cluster, it creates a new name each time a node is added. If you choose to assign your own names, you must type in the node name that you want to use. If you are using scripts to perform management tasks on the cluster and those scripts use the node name, you avoid the need to make changes to the scripts following service activity on the cluster by assigning the original name to a replacement node.
- The Node ID changes. A new Node ID is assigned each time a node is added to a cluster. You can use the node ID or the node name when you perform management tasks on the cluster. However, if you use scripts to perform those tasks, use the node name, not the node ID, because the node name remains unchanged after service activity on the cluster.
- The worldwide node name (WWNN) does not change. The WWNN uniquely identifies the node and the fiber channel ports. The node replacement procedure changes the WWNN of the spare node to match that of the failed node. The node replacement procedures must be followed exactly to avoid any duplication of WWNNs.
- The worldwide port name (WWPN) of each fiber channel port does not change. The WWPNs are derived from the WWNN that is written to the replacement node as part of this procedure.

Perform the following steps to replace a node:

1. Use the command `svcinfo lsnode` to display the node name. This command prints a detailed list report containing information about all the nodes on a cluster. The failed node is offline. Record the names of the nodes for later use.
2. Use the `svcinfo lsnode` command to display the I/O Group name. Record the name of the group for later use.
3. Use the `svcinfo lsnodevpd` command to display the front panel ID. Record the ID number for later use.
4. Use the `svcinfo lsnodevpd` command to record the UPS serial number. Record this number for later use.
5. Use the front panel ID to locate the failed node. Disconnect all four fiber channel cables from the node.

Important: Do not reconnect the cables until the node is repaired and the node number has been changed to the default spare node number.
6. Connect the power/signal cable from the spare node to the UPS and use the serial number that you recorded in step 1. The signal cable can be plugged into any vacant position on the top row of serial connectors on the UPS. If no spare serial connectors are available on the UPS, disconnect the cables from the failed node. Power-on the spare node. Display the node status on the service panel.

Perform these steps to change the WWNN of the node and add the replacement node:

1. With the node status displayed on the front panel, press and hold the Down button, press and release the Select button, and release the Down button. The text “WWNN” is displayed on line-1 of the display. Line-2 of the display contains the last five characters of the WWNN.
2. With the WWNN displayed on the service panel, press and hold the Down button, press and release the Select button, and release the Down button. This switches the display into edit mode.
3. Change the displayed number to match the WWNN recorded in step1. To edit the displayed number, use the Up arrow and Down arrow buttons to increase or decrease the displayed numbers. Use the left and right buttons to move between fields. When the five characters match the number that is recorded in step1, press the select button twice to accept the number.
4. Connect the four fiber channel cables that were disconnected from the failed node to the spare node. Delete the offline node.
5. Add the spare node into the cluster. See “Adding a node back into the cluster”.
6. Use the Subsystem Device Driver management tool on the host systems to verify that all paths are now online. See the *IBM System Storage SAN Volume Controller: Service Guide* menu options for further information.

When the failed node is repaired, do not connect the fibre channel cables to it. Connecting the cables might cause data corruption. Perform these steps after the failed node is repaired:

1. Display the node status on the service panel.
2. With the status displayed on the front panel, press and hold the Down button, press and release the Select button, and release the Down button. The text “WWNN” is displayed on line-1 of the display; line-2 of the display contains the last five characters of the WWNN.
3. With the WWNN displayed on the service panel, press and hold the Down button, press and release the Select button, and release the Down button. This switches the display into edit mode.
4. Change the displayed number to “00000”. To edit the displayed number, use the Up and Down buttons to increase or decrease the displayed numbers. Use the left and right buttons to move between fields. When the number is set to “00000”, press the select button twice to accept the number. Never connect a node with a WWNN of “00000” to the cluster.

This error is not marked as fixed in the error log until the failed node has been repaired and returned to the customer. If this is not done, the service technician cannot easily find the front panel ID of the failed node.

This node can now be used as a spare node. If this node is no longer required as a spare, but is to be used for normal attachment to a cluster, you must first use the previous procedure to change the WWNN to the number saved when a spare was being created. See 53. Using any other number might cause data corruption.

Possible failures

- CMMVC5786E The action failed because the cluster is not in a stable state.
- CMMVC5791E The action failed because an entity that was specified in the command does not exist.
- CMMVC5794E The action failed because the node is not a member of the cluster.

- CMMVC5795E The node was not deleted because a software upgrade is in progress.
- CMMVC5796E The action failed because the I/O group that the node belongs to is unstable.
- CMMVC5797E The node was not deleted because this is the last node in the I/O group and there are virtual disks (VDisks) associated with the I/O group.
- CMMVC6252E The command failed authorization because the session SSH key is wrong or was deleted.
- CMMVC6253E The command failed authorization because the session SSH key does not have the requisite role.

An invocation example

```
svctask rmnode 1
```

The resulting output

No feedback

setclustertime

The **setclustertime** command allows you to set the time for the cluster.

Syntax

```
▶▶ svctask — — setclustertime — — -time — time_value —————▶▶
```

Parameters

-time *time_value*

(Required) Specifies the time to which the cluster must be set. This must be in the following format:

```
MMDDHHmmYYYY
```

Description

This command sets the time for the cluster.

Possible failures

- CMMVC5786E The action failed because the cluster is not in a stable state.
- CMMVC6252E The command failed authorization because the session SSH key is wrong or was deleted.
- CMMVC6253E The command failed authorization because the session SSH key does not have the requisite role.

An invocation example

```
svctask setclustertime -time 040509142003
```

The resulting output

No feedback

setpwdreset

Use the **setpwdreset** command to view and change the status of the password-reset feature for the display panel.

Syntax

```
svctask setpwdreset [-disable | -enable | -show]
```

Parameters

-disable

Disables the password-reset feature that is available through the front panel menu system.

-enable

Enables the password-reset feature that is available through the front panel menu system.

-show

Displays the status of the password-reset feature, which is either enabled or disabled.

Description

The front panel menu system provides an option to reset the administrator password. This option resets the password to a random string that is displayed on the front panel. You can then use this password to access the system. You can change the password at the next login.

Issue the **svctask setpwdreset** command to view and change the status of the password-reset feature for the display panel. Passwords can consist of the following characters: A - Z, a - z, 0 - 9, and underscore (_). Make a careful note of the admin password, because without it, you cannot access the cluster.

This command allows you access in case the administrator password is forgotten. If you leave this feature enabled, you can ensure adequate physical security to the cluster hardware.

You can view or change the status of this feature.

Possible failures

- There are no error codes.

An invocation example

```
svctask setpwdreset -show
```

The resulting output

```
Password status: [1]
```

This output means that the password or reset feature that is available through the front panel menu system is enabled. If the password status is [0], this feature is disabled.

settimezone

Use the **settimezone** command to set the time zone for the cluster.

Syntax

```
svctask — — settimezone — — -timezone — timezone_arg —————>
```

Parameters

-timezone *timezone_arg*
Specifies the time zone to set for the cluster.

Description

This command sets the time zone for the cluster. Use the **-timezone** parameter to specify the numeric ID of the time zone that you want to set. Issue the **svcinfolstimezones** command to list the time-zones that are available on the cluster. A list of valid time-zones settings are displayed in a list.

The time zone that this command sets will be used when formatting the error log that is produced by issuing the following command:

```
svctask dumperrlog
```

Note: If you have changed the timezone, you must clear the error log dump directory before you can view the error log through the Web application.

Issue the **svcinfolshowtimezone** command to display the current time-zone settings for the cluster. The cluster ID and its associated time-zone are displayed. Issue the **svctask setclustertime** command to set the time for the cluster.

Possible failures

- CMMVC5786E The action failed because the cluster is not in a stable state.

An invocation example

```
svctask settimezone -timezone 5
```

The resulting output

```
No feedback
```

startstats

Use the **startstats** command to start the collection of statistics for both virtual disks (VDisks) and managed disks (MDisks).

Syntax

```
svctask — — startstats — — -interval — time_in_minutes —————>
```

Parameters

-interval *time_in_minutes*

Specifies the time in minutes. This is the time interval between the gathering of statistics, between 1 and 60 minutes in increments of 1.

Description

Statistics are collected at the end of each sampling period (as specified by the **-interval** parameter). These statistics are written to a file. A new file is created at the end of each sampling period. Separate files are created for MDisks, VDisks and node statistics.

The files generated are written to the `/dumps/iostats` directory.

A maximum of 16 files are stored in the directory at any one time for each statistics file type, for example:

```
Nm_stats_nodepanelname_date_time  
Nv_stats_nodepanelname_date_time  
Nn_stats_nodepanelname_date_time  
m_stats_nodepanelname_date_time  
v_stats_nodepanelname_date_time
```

Statistics files beginning with `m_stats_*` and `v_stats_*` are not created if the specified time interval is less than 15 minutes. Statistics files beginning with `Nm_stats_*`, `Nv_stats_*` and `Nn_stats_*` are created for all time intervals.

Before the 17th file (for each type) is created, the oldest file of that type is deleted.

These files can be listed by using the **svcinfolsiostatsdumps** command.

The following naming convention is used for these files:

```
stats_type_stats_nodepanelname_date_time
```

Where *stats_type* is `m` or `Nm` for MDisks, `v` or `Nv` for VDisks, and `Nn` for node statistics. *nodepanelname* is the current configuration node panel name, *date* is in the format of `yymmdd`, and *time* is in the format of `hhmmss`.

The following are examples of MDisk file names:

```
m_stats_000229_031123_072426  
Nm_stats_000229_031123_072426
```

The following are examples of VDisk file names:

```
v_stats_000229_031123_072426  
Nv_stats_000229_031123_072426
```

The following is an example of a node statistics file name:

```
Nn_stats_000229_031123_072426
```

The statistics that are collected for each MDisk and VDisk are reported in the `m_stats_nodepanelname_date_time` and `v_stats_nodepanelname_date_time` files and include the following statistical information:

- The number of SCSI read and write commands that are processed during the sample period

- The number of blocks of data that are read and written during the sample period

Statistics are collected for each MDisk and recorded in the `Nm_stats_nodepanelname_date_time` file, including the following statistical information:

- The number of SCSI read and write commands that are processed during the sample period
- The number of blocks of data that are read and written during the sample period
- Per MDisk, cumulative read and write external response times in milliseconds
- Per MDisk, cumulative read and write queued response times

Statistics are collected for each VDisk and recorded in the `Nv_stats_nodepanelname_date_time` file, including the following statistical information:

- The total number of processed SCSI read and write commands
- The total amount of read and written data
- Cumulative read and write response time in milliseconds
- Statistical information about the read/write cache usage
- Global Mirror statistics including latency

Statistics are collected for the node from which the statistics file originated and recorded in the `Nn_stats_nodepanelname_date_time` file, including the following statistical information:

- Usage figure for the node from which the statistic file was obtained
- The amount of data transferred to and received from each port on the node to other devices on the SAN
- Statistical information about communication to other nodes on the fabric

Note: The `v_*` and `m_*` statistics are per-cluster statistics that are only collected on the configuration node. The `Nm_*`, `Nn_*` and `Nv_*` files are per-node statistics that are generated on each node.

Possible failures

- There are no error codes.

An invocation example

```
svctask startstats -interval 25
```

The resulting output

```
No feedback
```

stopcluster

The **stopcluster** command allows you to shut down a single node or the entire cluster in a controlled manner. When you issue this command, you are prompted with a confirmation of intent to process the command.

Syntax

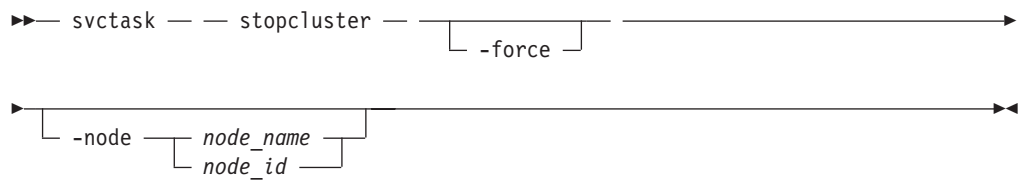

Parameters

-force

(Optional) Specifies that the node that is being shut down is the last online node in a given I/O group.

-node *node_name* | *node_id*

(Optional) Specifies the node that you want to shut down. You can specify one of the following values:

- The node name, or label that you assigned when you added the node to the cluster
- The node ID that is assigned to the node (not the worldwide node name).

If you specify **-node** *node_name* | *node_id*, only the specified node is shut down; otherwise, the entire cluster is shut down.

Description

When you enter this command with no parameters, the entire cluster is shutdown. All data is flushed to disk before the power is removed.

Attention: Ensure that you have stopped all FlashCopy, Metro or Global Mirror, or data migration operations before you attempt to shutdown a node or cluster. You must also ensure that all asynchronous deletion operations have completed prior to a shutdown operation.

When you enter this command with either a node ID or node name, the node in question is shut down. After the command completes, the remaining node in the I/O group enters write-through mode until the power to the node is returned and the node rejoins the cluster.

Attention: If you have to remove all cluster input power for more than a few minutes, you must shut down the cluster before you remove the power. If the input power is removed from the uninterruptible power supply units without first shutting down the cluster and the uninterruptible power supply units, the uninterruptible power supply units remain operational and eventually become drained of power.

When input power is restored to the uninterruptible power supply units, they begin to recharge but the nodes do not permit I/O activity on the virtual disks until the uninterruptible power supply is charged enough to enable all the data on the nodes to be saved in the event of an unexpected power loss. This might take as long as three hours. Shutting down the cluster prior to removing input power to the uninterruptible power supply units prevents the draining of battery power and makes it possible for I/O activity to resume as soon as input power is restored.

Attention: Before shutting down a node or the cluster, quiesce all I/O operations that are destined for this node or cluster. Failure to quiesce can result in failed I/O operations being reported to your host operating systems.

Begin the process of quiescing all I/O to the cluster by stopping the applications on your hosts that are using the VDisks that are provided by the cluster. Perform the following steps to quiesce all I/O to the cluster:

1. If you are unsure which hosts are using the VDisks that are provided by the cluster, determine the hosts that the VDisks are mapped to, as follows:
 - a. List the hosts that this VDisk is mapped to by issuing the following command, substituting the *vdiskname* | *id* variable with the name or ID of the VDisk:

```
svcinfolsvdiskhostmap vdiskname | id
```
 - b. In the command output, locate the host name or ID to determine which host the specified VDisk is mapped to. If no data is displayed, the VDisk is not mapped to any hosts.
2. Repeat the previous procedure for all VDisks.

Attention: If you are shutting down the entire cluster, you lose access to all VDisks that are being provided by this cluster.

When all I/O has been stopped, issue the **svctask stopcluster** to shut down a single node or the entire cluster in a controller manner. If you specify the node ID or node name, you can shut down a single node. After the command completes, the other node in the I/O group goes into write-through mode until the power to the node is returned and the node rejoins the cluster.

Attention: If this is the last node in an I/O group, you must specify the **-force** parameter. You will lose all access to the virtual disks in the I/O group. Before you enter this command, ensure that this is what you want to do.

If a shutdown command has been sent to the cluster and both cluster and uninterruptible power supply units have powered off, when input power is restored, press the power button on the uninterruptible power supply front panel to restart the uninterruptible power supply units.

Ensure that you have stopped all FlashCopy mappings and Metro or Global Mirror relationships. In addition, ensure that all data migration operations and forced deletions have completed before continuing. Entering *y* to the confirmation message processes the command. No feedback is then displayed. Entering anything other than *y* or *Y* results in the command not processing. No feedback is displayed.

Attention: If you are shutting down a single node and the other node in the I/O group is online, the cache on the partner node goes into the write-through mode and that you are exposed to a single point of failure if the partner node fails while the node is shut down. You also lose access to all VDisks being served by this I/O group.

Possible failures

- CMMVC5786E The action failed because the cluster is not in a stable state.
- CMMVC5798E The action failed because the node is offline.
- CMMVC5791E The action failed because an entity that was specified in the command does not exist.

- CMMVC5796E The action failed because the I/O group that the node belongs to is unstable.
- CMMVC5799E The shutdown was not successful because there is only one online node in the I/O group.
- CMMVC6252E The command failed authorization because the session SSH key is wrong or was deleted.
- CMMVC6253E The command failed authorization because the session SSH key does not have the requisite role.

An invocation example

```
svctask stopcluster
```

The resulting output You will be presented with the following warning:

```
Are you sure that you want to continue with the shut down?
```

stopstats

You can use the **stopstats** command to stop the collection of statistics for both VDIs and MDIs.

Syntax

```
svctask — — stopstats —————><
```

Description

This command turns off the generation of statistics, until you start them again (with the **svctask startstats**).

Possible failures

- There are no error codes.

An invocation example

```
svctask stopstats
```

The resulting output

```
No feedback
```

Chapter 8. Backup and restore commands

The following commands are used for backing up and restoring configuration information with the SAN Volume Controller.

backup

Use the **backup** command to back up your configuration. You can enter this command any time after a cluster has been created.

Syntax

```
svsconfig -- backup [-quiet] [-v on | off]
```

Parameters

-quiet

Suppresses standard output (STDOUT) messages from the console.

-v on | off

On means verbose messages are displayed. Off means normal messages (the default) are displayed.

Description

The **backup** command extracts configuration information from the cluster, allowing you to restore your configuration whenever necessary. The **backup** command produces **.xml**, **.sh**, **.log**, and **.key** files and saves them in the **/tmp** directory. The **.xml** file contains the extracted configuration information. The **.log** file contains details about command usage.

Note: If a previous **svc.config.backup.xml** file exists in **/tmp**, it is archived as **svc.config.backup.bak**; only one archive file is stored in the **/tmp** directory. Immediately archive the **.xml** file and the related **.key** files, and use the **clear** command to erase those files from the **/tmp** directory. Change all objects with default names to nondefault names; you cannot restore objects with default names.

The underscore character (**_**) prefix is reserved for backup and restore command usage; do not use the underscore character in any object names.

Note the following **backup** command limitation: **.key** SSH public key value files are not produced with the **.xml** file in **/tmp**. Warnings are nevertheless issued for the missing file or files that must be supplied. These files conform to the template **svc.config.identifier.user.key** where *identifier* and *user* are as specified for the **addsshkey** command. You are requested to supply these files if they are used with the **addsshkey** command. If they are not available, you must install a new set of keys during any future cluster restoration process.

Possible failures

- CMMVC6112W *object-type object-name* has a default name
- CMMVC6136W No SSH key file *file-name*
- CMMVC6147E *object-type object-name* has a name beginning with *prefix*

An invocation example

```
svconfig backup
```

The resulting output

```
No feedback
```

clear

Use the **clear** command to erase files in the **/tmp** directory that were previously produced by other **svconfig** commands. You can enter this command any time after a cluster has been created.

Syntax

```
▶▶ svconfig -- clear -- -all ▶▶
```

Parameters

-all

Includes **.key**, **.bak** and **.xml** files in file clearance; otherwise, clears just **.log** and **.sh** files. The **.key**, **.bak** and **.xml** files contain configuration information, whereas the others do not.

Description

This command clears some or all files in the **/tmp** directory that are produced by **svconfig**. Files conform to the template **svc.config.***.

Possible failures

- CMMVC6103E Problem file *file-name: details*

An invocation example

```
svconfig clear -all
```

The resulting output

```
No feedback
```

help

Use the **help** command to obtain summary information about the syntax of the **svconfig** command. You can enter this command any time after a cluster has been created.

Syntax

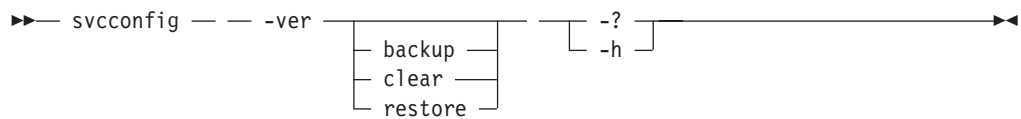

Parameters

-ver

Returns the version number for the **svcconfig** command.

(action) -h | -?

Provides command help: the possible values for (action) are backup, clear, and restore.

-h | -?

Provides general help.

Description

This command provides syntax help for **svcconfig**.

Possible failures

- CMMVC6100E *-option* not consistent with *action*
- CMMVC6101E *-option* not consistent with *-option*
- CMMVC6102E *-option* and *-option* are alternatives
- CMMVC6114E No help for action *action*
- CMMVC6134E No argument for *-option*
- CMMVC6135E Argument *value* for *-option* is not valid
- CMMVC6138E *-option* is required
- CMMVC6141E *-option* does not contain any argument
- CMMVC6149E An action is required
- CMMVC6150E The action *action* is not valid
- CMMVC6151E The option *-option* is not valid
- CMMVC6153E *object* not consistent with *action*

An invocation example

```
svcconfig -ver  
svcconfig -?  
svcconfig backup -h
```

The resulting output

The help text displays.

restore

The **restore** command uses the configuration files in the **/tmp** directory to restore the cluster to its previous configuration.

Syntax

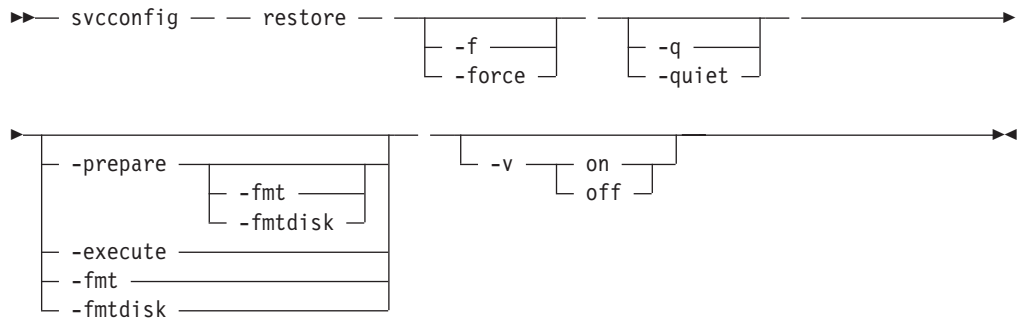

Parameters

-f | force

Forces continued processing where possible.

-q | quiet

Suppresses console output (STDOUT).

-prepare

Checks the current configuration against the information in **svc.config.backup.xml** on the configuration to be restored. Prepares commands for processing in **svc.config.restore.sh**, and produces a log of events in **svc.config.restore.prepare.log**.

-fmt | fmdisk

Includes the **-fmdisk** option on all **mkvdisk** commands to be issued.

-execute

Runs the command script **svc.config.restore.sh**. Produces a log of events in **svc.config.restore.execute.log**.

-v on | off

Produces verbose output (on); the default is regular output (off).

Description

The **restore** command restores the target cluster configuration from the **svc.config.backup.xml** file, and associated **.key** files (if present) in the configuration files directory. If neither the **-prepare** nor **-execute** option is specified, only a single event log **svc.config.restore.log** is produced.

The command pauses for 5 minutes if any nodes are added during this process. You are informed of this at run-time.

After restoration, a VDisk consists of a specific list of MDisks. If the relevant MDisk group comprises a larger list, either now or in the future, the restored VDisk cannot manage any MDisks that are not presently in its own list.

The configuration files directory is **/tmp**.

Possible failures

- CMMVC6105E Different names for source *name* and target *name* clusters
- CMMVC6106E Target cluster has non-default *id_alias value*
- CMMVC6107E *x* *io_grp* objects in target cluster; *y* are required

- CMMVC6109E Disk controller system with WWNN of *value* not available
- CMMVC6120E Target is not the configuration node
- CMMVC6139E Incorrect XML tag nesting in *file-name*
- CMMVC6142E Existing *object-type object-name* has a non-default name
- CMMVC6143E Required configuration file *file-name* does not exist
- CMMVC6146E Problem parsing *object-type* data: *line*
- CMMVC6147E *object-type object-name* has a name beginning with *prefix*
- CMMVC6148E Target cluster has *actual* object(s) of type *object-type* instead of *required*
- CMMVC6152E vdisk *name* instance number *value* is not valid
- CMMVC6155I SVCCONFIG processing completed successfully
- CMMVC6156W SVCCONFIG processing completed with errors
- CMMVC6165E Target is not the original configuration node with WWNN of *value*

Note: Messages 6155 and 6156 are only shown with **-v on**.

An invocation example

```
svcconfig restore -prepare
svcconfig restore -execute
```

The resulting output

No feedback

Chapter 9. Cluster diagnostic and service-aid commands

Cluster diagnostic and service-aid commands are designed to diagnose and find cluster problems.

The SAN Volume Controller enables you to perform service activity, such as problem determination and repair activities, with a limited set of command-line tools. When you are logged in under the administrator role, all command-line activities are permitted. When you are logged in under the service role, only those commands that are required for service are enabled. All of these commands apply under the service role.

addnode

The **addnode** command allows you to add a new (candidate) node to an existing cluster. You can enter this command any time after a cluster has been created.

Syntax

```
▶▶▶ svcserVICtask — — addnode — — [ -panelname — — panel_name ] — —▶▶▶
                                   [ -wwnodename — — wwnn_arg ]
▶ [ -name — — new_name_arg ] — — -iogrp — — [ iogroup_name ] — —▶▶▶
                                   [ iogroup_id ]
```

Parameters

-panelname *panel_name*

(Required) Specifies the node that you want to add to the cluster, by its name, that is displayed on the display panel.

Note: You cannot use the **-panelname** parameter with the **-wwnodename** parameter. However, you must use one of these parameters with the **addnode** command.

-wwnodename *wwnn_arg*

(Required) Specifies the node that you want to add to the cluster by the worldwide node name (WWNN) of the node.

Note: You cannot use the **-wwnodename** parameter with the **-panelname** parameter. However, you must use one of these parameters with the **addnode** command.

-name *new_name_arg*

(Optional) Specifies a name for the designated node.

-iogrp *iogroup_name* | *iogroup_id*

(Required) Specifies the I/O group that you want to add this node to.

Description

This command adds a new node to the cluster. You can obtain a list of candidate nodes (those that are not already assigned to a cluster) by issuing the **svcinfo lsnodecandidate** command.

The process of adding a node completes asynchronously. This means that while the node is in the adding state, the WWPN is not known and displays as zeros.

If the compatibility check fails, the following message displays:

```
CMMVC6201E The node could not be added, because incompatible
software: status code [%1].
```

Prerequisites: Before you can add a node to the cluster, check the following requirements:

- The cluster must have more than one I/O group.
- The node that is being added to the cluster must use physical node hardware that has previously been used as a node in the cluster.
- The node that is being added to the cluster must use physical node hardware that has previously been used as a node in another cluster and both clusters are recognized by the same hosts.

Attention: If the previous conditions apply, failure to follow the documented procedures can result in the corruption of all data that is managed by the cluster.

Adding a node: If you are adding the node into the cluster for the first time, you must record the node serial number, the WWNN, all WWPNs, and the I/O group to which it has been added. This can prevent possible data corruption if the node must be removed from and re-added to the cluster.

When a node is added to the cluster using the `svctask addnode` command or the cluster GUI, confirm that the node has previously been a member of the cluster. If it has, follow one of these two procedures:

- The node must be added back to the same I/O group that it was previously in. The WWNN of the nodes in the cluster can be determined using the `svcinfolnode` command. Or,
- If the WWPN of the node is not available, call the support team to add the node back into the cluster.

Optionally, you can assign a name to the new node. You can use this name in subsequent commands to refer to the node, instead of using the node ID. If you assign a label, this label is displayed as the node name from then on. If you do not assign a label, the default label is nodeX, where X is the node ID.

Applications on a host system direct I/O operations to file systems or logical volumes that are mapped by the operating system to vpaths. Vpaths are pseudo disk objects that are supported by the SDD; see the *Multipath Subsystem Device Driver: User's Guide* for more information.

The SDD maintains an association between a vpath and a VDisk. This association uses an identifier (UID), which is unique to the VDisk and is not reused. This enables the SDD to unambiguously associate vpaths with VDisks.

The SDD operates within a protocol stack, which also contains disk and fibre-channel device drivers that enable it to communicate with the cluster using the SCSI protocol over fibre-channel as defined by the ANSI FCS standard. The addressing scheme that is provided by these SCSI and fibre-channel device drivers uses a combination of a SCSI logical unit number (LUN) and the worldwide name for the fibre-channel node and ports.

In the event that errors occur, error recovery procedures (ERPs) operate at various tiers in the protocol stack. Some of these ERPs cause I/O to be redriven using the same WWNN and LUN numbers that were previously used.

The SDD does not check the association of the VDisk with the vpath on every I/O operation that it performs.

Possible failures

- CMMVC5707E Required parameters are missing.
- CMMVC5786E The action failed because the cluster is not in a stable state.
- CMMVC5790E The node was not added to the cluster because the maximum number of nodes has been reached.
- CMMVC5791E The action failed because an entity that was specified in the command does not exist.
- CMMVC5792E The action failed because the I/O group is used for recovery.
- CMMVC5793E The node was not added to the cluster because the I/O group already contains a pair of nodes.
- CMMVC5777E The node was not added to the I/O group because the other node in the I/O group is in the same power domain.
- CMMVC6201E The node could not be added, because incompatible software: status code [%1].
- CMMVC6252E The command failed authorization because the session SSH key is wrong or was deleted.
- CMMVC6253E The command failed authorization because the session SSH key does not have the requisite role.

An invocation example

```
svcservicetask addnode -wwnodename 210000e08b053564 -iogrp io_grp0
```

The resulting output

```
Node, id [6], successfully added
```

applysoftware

The **applysoftware** command upgrades the cluster to a new level of software.

Syntax

```
▶▶— svcservicetask — — applysoftware — — [ -force ] —————▶▶
▶— -file — filename — — [ -abort ] —————▶▶
```

Parameters

-force

(Optional) Specifies that the upgrade continue even if there is a node in the I/O group that is not paired. The upgrade process forces the first node in each I/O group to shut down and upgrade.

Note: If the first node in the I/O group is not paired, the cluster becomes degraded and the data is lost even with the use of the **-force** parameter.

-file *filename*

(Required) Specifies that if you are doing an upgrade, you must designate the file name of the new software package.

-abort

(Optional) Stops the upgrade and backs out to where the application was before you started the upgrade.

Note: The **-force** parameter can be used with the **-abort** parameter. If one or more nodes are offline, you must use the **-force** parameter with the **-abort** parameter.

Description

This command starts the upgrade process of the cluster to a new level of software and applies to **svcservicetask** and **svcservicemodetask** commands. The **applysoftware** command applies a level of software to the node in both service and nonservice modes. In service mode, the **applysoftware** command is applied to the specific node. In nonservice mode, the **applysoftware** command is applied to the entire cluster.

The software package as specified by the file name must first be copied on to the current configuration node in the `/home/admin/upgrade` directory. You can use the PuTTY secure copy (scp) application to copy the file. See “PuTTY scp” for detailed information on this procedure.

The actual upgrade completes asynchronously.

The **svcinfolsoftwareumps** command allows you to view the contents of the `/home/admin/upgrade` directory.

The new package is moved internally from the `/home/admin/upgrade` directory and a checksum operation is processed on it. If the package fails the checksum operation, it is deleted and the upgrade fails. Otherwise, the package is extracted from the directory and the software upgrade begins.

Possible failures

- CMMVC5801E The upgrade of the cluster software could not proceed because every node in the cluster must be online. Either delete the node that is offline or bring the node online and resubmit the command.
- CMMVC5802E The upgrade of the cluster software could not proceed because there is an I/O group in the cluster that contains only one node. The software upgrade requires that each node in an I/O group be shut down and restarted. If there is only one node in an I/O group, I/O operations could be lost if I/O operations are not stopped before beginning the software upgrade. To upgrade the cluster, the force parameter is required.
- CMMVC5993E The specific upgrade package does not exist.
- CMMVC5994E Error in verifying the signature of the upgrade package.
- CMMVC5995E Error in unpacking the upgrade package.
- CMMVC5996E The specific upgrade package cannot be installed over the current version.
- CMMVC6011E At least one remote cluster partnership has been found. This upgrade package cannot be applied to the current code level until all remote cluster partnerships are deleted.

- CMMVC6054E The action failed because not all nodes are online.
- CMMVC6206E The software upgrade failed as a file containing the software for the specified version was not found.
- CMMVC6232E This operation cannot be performed because the cluster is currently aborting the previous software upgrade command.
- CMMVC6233E This operation cannot be performed because the software upgrade is making progress.

An invocation example

```
svcservicetask applysoftware -file softwareupdate
```

The resulting output

No feedback

cherrstate

The **cherrstate** command marks an unfixed error as fixed. You can also use it to mark a fixed error as unfixed.

Syntax

```
svctask -- cherrstate -- -sequencenumber -- sequence_number --
└─┬─┘
  -unfix
```

Parameters

-sequencenumber *sequence_number*

(Required) Specifies the error log sequence numbers to mark as fixed or as unfixed.

-unfix

(Optional) Specifies that the sequence numbers be marked as unfixed. Use this parameter when you have marked the wrong sequence number as fixed.

Description

The error log entries that the sequence numbers that you entered are marked as fixed. Use this command as a manual confirmation step that you have performed a maintenance procedure on the cluster, the fabric, or the subsystems.

This step is performed as part of the directed maintenance procedures (DMPs).

Optionally, if you have wrongly marked a sequence number as fixed, you can use the **-unfix** parameter to change the entry to unfixed.

Possible failures

- CMMVC5786E The action failed because the cluster is not in a stable state.
- CMMVC5803E The entry in the error log was not marked because the sequence number was not found.
- CMMVC6252E The command failed authorization because the session SSH key is wrong or was deleted.

- CMMVC6253E The command failed authorization because the session SSH key does not have the requisite role.

An invocation example

```
svctask cherrstate -sequencenumber 2019
```

The resulting output

No feedback

clearerrlog

The **clearerrlog** command clears all entries from the error log including status events and any unfixed errors.

Syntax

```
▶▶ svctask — — clearerrlog — — [ -force ] ▶▶
```

Parameters

-force

(Optional) Specifies that the **clearerrlog** command be processed without confirmation requests. If the **-force** parameter is not supplied, you are prompted to confirm that you want to clear the log.

Description

This command clears all entries from the error log. The entries are cleared even if there are unfixed errors in the log. It also clears any status events that are in the log.

Attention: This command is destructive. Use it only use when you have either rebuilt the cluster or have fixed a major problem that has caused entries in the error log that you do not want to manually fix.

Possible failures

- CMMVC5786E The action failed because the cluster is not in a stable state.
- CMMVC6252E The command failed authorization because the session SSH key is wrong or was deleted.
- CMMVC6253E The command failed authorization because the session SSH key does not have the requisite role.

An invocation example

```
svctask clearerrlog -force
```

The resulting output

No feedback

dumperrlog

The **dumperrlog** command dumps the contents of the error log to a text file.

Syntax

```
svctask -- dumperrlog -- [-prefix -- filename_prefix]
```

Parameters

-prefix *filename_prefix*

(Optional) A file name is created from the prefix and a time stamp, and has the following format:

```
prefix_NNNNNN_YYMMDD_HHMMSS
```

where *NNNNNN* is the node front panel name.

Note: If the **-prefix** parameter is not supplied, the dump is directed to a file with a system-defined prefix of **errlog**.

Description

When run with no parameters, this command dumps the cluster error log to a file using a system-supplied prefix of **errlog**, which includes the node ID and time stamp. When a file name prefix is provided, the same operation is performed but the details are stored in the dumps directory within a file with a name that starts with the specified prefix.

A maximum of ten error-log dump files are kept on the cluster. When the 11th dump is made, the oldest existing dump file is overwritten.

Error log dump files are written to **/dumps/elogs**. The contents of this directory can be viewed using the **svcinfo lserlogdumps** command.

Files are not deleted from other nodes until you issue the **cleardumps** command.

Possible failures

- CMMVC5983E The dump file was not created. The file system might be full.
- CMMVC5984E The dump file was not written to disk. The file system might be full.

An invocation example

```
svcservicetask dumperrlog -prefix testerrorlog
```

The resulting output

No feedback

finderr

The **finderr** command analyzes the error log for the highest severity unfixed error.

Syntax

```
svctask -- finderr
```

Description

The command scans the error log for any unfixed errors. Given a priority ordering within the code, the highest priority unfixed error is returned to standard output.

You can use this command to determine the order in which to fix the logged errors.

The Web-based directed maintenance procedures (DMPs) also use this command.

Possible failures

- There are no error codes.

An invocation example

```
svctask finderr
```

The resulting output

Highest priority unfixed error code is [1010]

rmnode

The **rmnode** command deletes a node from the cluster. You can enter this command any time after a cluster has been created.

Syntax

```
▶▶— svcservicetask — — rmnode — — node_name —————▶▶  
                                └── node_id ───┘
```

Parameters

node_name | *node_id*

Specifies the node to be deleted. The value for this parameter can be one of the following:

- The node name, that is, the label that you assigned when you added the node to the cluster
- The node ID that is assigned to the node [not the worldwide node name (WWNN)].

Description

This command removes a node from the cluster. This makes the node a candidate to be added back into this cluster or into another cluster. After the node is deleted, the other node in the I/O group enters write-through mode until another node is added back into the I/O group.

Prerequisites:

Before you issue the **rmnode** command, perform the following tasks and read the following Attention notices to avoid losing access to data:

1. Determine which virtual disks (VDisks) are still assigned to this I/O group by issuing the following command. The command requests a filtered view of the VDisks, where the filter attribute is the I/O group.

```
svcinfolsvdisk -filtervalue IO_group_name=name
```

where *name* is the name of the I/O group.

Note: Any VDIsks that are assigned to the I/O group that this node belongs to, will be assigned to the other node in the I/O group; that is, the preferred node will be changed. You cannot change this setting back.

2. Determine the hosts that the VDIsks are mapped to by issuing the **svcinfolsvdiskhostmap** command.
3. Determine if any of the VDIsks assigned to this I/O group contain data that you need to maintain access to:
 - If you *do not* want to maintain access to these VDIsks, go to step 5.
 - If you *do* want to maintain access to some or all of the VDIsks, back up the data or migrate the data to a different (online) I/O group.
4. Determine if you need to turn the power off to the node:
 - If this is the last node in the cluster, you do not need to turn the power off to the node. Go to step 5.
 - If this is *not* the last node in the cluster, turn the power off to the node that you intend to remove. This step ensures that the Subsystem Device Driver (SDD) does not rediscover the paths that are manually removed before you issue the delete node request.
If you plan to add the node back into the cluster, see **Adding a node back into the cluster:** below.
5. Update the SDD configuration for each virtual path (vpath) that is presented by the VDIsks that you intend to remove. Updating the SDD configuration removes the vpaths from the VDIsks. Failure to update the configuration can result in data corruption. See the *Multipath Subsystem Device Driver: User's Guide* for details about how to dynamically reconfigure SDD for the given host operating system.
6. Quiesce all I/O operations that are destined for the node that you are deleting. Failure to quiesce the operations can result in failed I/O operations being reported to your host operating systems.

Attention: Removing the last node in the cluster destroys the cluster. Before you delete the last node in the cluster, ensure that you want to destroy the cluster.

Attention: If you delete a node and the remaining node in the I/O group is online, the cache on the remaining node enters write-through mode, which exposes the data to a single point of failure.

Note:

1. If the node you are removing is the configuration node, it may take one or two minutes to complete the command.
2. If the node you are removing is the last node in the cluster, the cluster might seem to hang for up to 3 minutes because you have removed the last access point to the cluster.

Deleting a node from a cluster: Issue the **svctask rmnode** command to delete a node from the cluster. You can enter this command any time after a cluster has been created.

Note:

1. If you are deleting the last node in the I/O group or the last node in the cluster, you are asked to force the deletion.

2. If you are deleting the last node in the cluster or a node currently assigned as the configuration node, all connections to the cluster are lost. The user interface and any open CLI sessions are lost if the last node in the cluster is deleted. Deleting the configuration node results in failover processing to another node. A time-out might occur if a command cannot be completed before the node is deleted.

Adding a node back into the cluster:

If you turn the power back on to the node that has been removed while it is still connected to the same fabric or zone, the following actions occur:

1. The node attempts to join the cluster again.
2. The cluster signals the node to remove itself from the cluster.
3. The node becomes a candidate for addition to this cluster or another cluster.

If you intend to add this node back into the cluster, ensure that you add it back to the same I/O group from which you are deleting it. Otherwise, data corruption might occur.

Before you add a node back into the cluster, you need to know the following information, which should have been recorded when the node was originally added to the cluster.

- Node serial number
- WWNN
- All worldwide port names (WWPNs)
- I/O group that contains the node

If you do not have access to this information, call the service team to add the node back into the cluster without corrupting the data.

Replacing a failed node:

If a node fails, the cluster continues to operate with degraded performance until the failed node is repaired. To enhance availability, you can replace the failed node and repair the failed node offline. However, you must follow certain procedures to replace a failed node without interrupting I/O or risking data integrity when the repaired node is reconnected to the SAN fabric. The procedures include changing the world wide node name (WWNN) of the replacement node. This procedure must be followed with care to avoid duplicate WWNNs, which are illegal and can cause data corruption.

Prerequisites:

Before replacing the failed node you must perform the following tasks:

- Ensure that the GUI that is used to access the cluster and spare node is running at least version 1.1.1 of the software.
- Know the cluster name that contains the failing node.
- Confirm that a spare node is in the same rack as the cluster containing the failed node.
- Make a record of the last five characters of the original WWNN. This identification is needed if you decide in the future to designate the spare node as a normal node that can be assigned to any cluster. Use the **svcinfo lsnode** command to see the WWNN.

Additional Information

When you replace a node, the following process takes place:

- The node Front Panel ID changes. This is the number printed on the front of the node, which is used to select the node that is added to a cluster.
- The node name might change. If you permit the cluster to assign default names when you add nodes to the cluster, it creates a new name each time a node is added. If you choose to assign your own names, you must type in the node name that you want to use. If you are using scripts to perform management tasks on the cluster and those scripts use the node name, you avoid the need to make changes to the scripts following service activity on the cluster by assigning the original name to a replacement node.
- The Node ID changes. A new Node ID is assigned each time a node is added to a cluster. You can use the node ID or the node name when you perform management tasks on the cluster. However, if you use scripts to perform those tasks, use the node name, not the node ID, because the node name remains unchanged after service activity on the cluster.
- The worldwide node name (WWNN) does not change. The WWNN uniquely identifies the node and the fiber channel ports. The node replacement procedure changes the WWNN of the spare node to match that of the failed node. The node replacement procedures must be followed exactly to avoid any duplication of WWNNs.
- The worldwide port name (WWPN) of each fiber channel port does not change. The WWPNs are derived from the WWNN that is written to the replacement node as part of this procedure.

Perform the following steps to replace a node:

1. Use the command **svcinfo lsnode** to display the node name. This command prints a detailed list report containing information about all the nodes on a cluster. The failed node is offline. Record the names of the nodes for later use.
2. Use the **svcinfo lsnode** command to display the I/O Group name. Record the name of the group for later use.
3. Use the **svcinfo lsnodevpd** command to display the front panel ID. Record the ID number for later use.
4. Use the **svcinfo lsnodevpd** command to record the UPS serial number. Record this number for later use.
5. Use the front panel ID to locate the failed node. Disconnect all four fiber channel cables from the node.
Important: Do not reconnect the cables until the node is repaired and the node number has been changed to the default spare node number.
6. Connect the power/signal cable from the spare node to the UPS and use the serial number that you recorded in step 1. The signal cable can be plugged into any vacant position on the top row of serial connectors on the UPS. If no spare serial connectors are available on the UPS, disconnect the cables from the failed node. Power-on the spare node. Display the node status on the service panel.

Perform these steps to change the WWNN of the node and add the replacement node:

1. Display the node status on the service panel.

2. Press and hold the **Down arrow** button, press and release the **Select** button, and then release the **Down arrow** button. The text **WWNN** is displayed on line-1 of the display. Line-2 of the display contains the last five characters of the WWNN.
3. With the WWNN displayed on the service panel, press and hold the Down button, press and release the Select button, release the Down button. This switches the display into edit mode.
4. Change the displayed number to match the WWNN recorded in step 2. To edit the displayed number, use the **Up arrow** and **Down arrow** buttons to increase or decrease the numbers displayed. Use the **Left arrow** and **Right arrow** buttons to move between fields. When the five characters match the number recorded in step 2, press the select button twice to accept the number.
5. Connect the four fiber channel cables that were disconnected from the failed node to the spare node. Delete the offline node.
6. Add the spare node into the cluster. See “Adding a node back into the cluster”.
7. Use the Subsystem Device Drive (SDD) management tool on the host systems to verify all paths are now online; see the *IBM System Storage SAN Volume Controller: Service Guide* menu options for further information.

When the failed node is repaired, do not connect the fibre channel cables to it. Connecting the cables might cause data corruption. Perform these steps after the failed node is repaired:

1. Display the node status on the service panel.
2. Press and hold the **Down arrow** button, press and release the **Select** button, and then release the **Down arrow** button. The text **WWNN** is displayed on line-1 of the display; line-2 of the display contains the last five characters of the WWNN.
3. Press and hold the **Down arrow** button, press and release the **Select** button, and then release the **Down arrow** button. This switches the display into edit mode.
4. Change the displayed number to **00000**. To edit the displayed number, use the **Up arrow** and **Down arrow** buttons to increase or decrease the numbers displayed. Use the **Left arrow** and **Right arrow** buttons to move between fields. Press the **Select** button twice to accept the number. Never connect a node with a WWNN of **00000** to the cluster.
5. In the error log, mark the error as fixed.

To add the repaired node to a cluster, first use the procedure described previously in the prerequisites section to change the WWNN to the number saved when the replacement node was being created. **Using any other number might cause data corruption.**

Possible failures

- CMMVC5786E The action failed because the cluster is not in a stable state.
- CMMVC5791E The action failed because an entity that was specified in the command does not exist.
- CMMVC5794E The action failed because the node is not a member of the cluster.
- CMMVC5795E The node was not deleted because a software upgrade is in progress.
- CMMVC5796E The action failed because the I/O group that the node belongs to is unstable.

- CMMVC5797E The node was not deleted because this is the last node in the I/O group and there are virtual disks (VDisks) associated with the I/O group.

An invocation example

```
svcservicetask rmnode 1
```

The resulting output

No feedback

setevent

The **setevent** command specifies how SAN Volume Controller sends SNMP traps when an error or event is logged to the error log.

Syntax

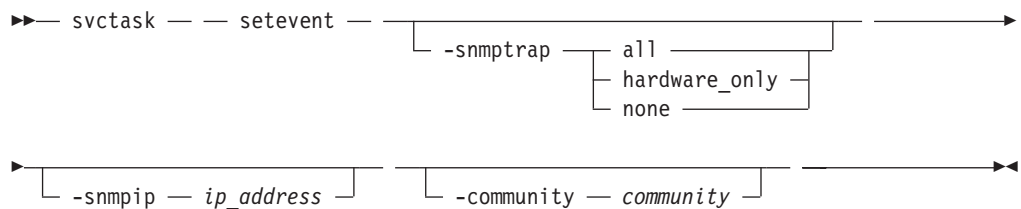

Parameters

-snmptrap *all* | *hardware_only* | *none*

(Optional) Specifies the SNMP trap setting, which specifies when to raise a trap. You can set the following values for this parameter:

all Sends an SNMP trap for all errors and state changes that are logged.

hardware_only

Sends an SNMP trap for all errors, but not for object state changes.

none Does not send any SNMP traps or errors. This is the default setting for a new cluster.

-snmpip *ip_address*

(Optional) Specifies the IP address of the host system that is running the SNMP manager software. This is a colon-separated list of values with up to six items per list.

-community *community*

(Optional) Specifies the SNMP community string. This is a colon-separated list of values with up to six items per list. The maximum length of the community string that is used in SNMP trap generation cannot be more than 60 characters.

Description

This command sets or modifies the settings that apply to the error log. These settings define how SAN Volume Controller sends SNMP traps when an error or event is logged to the error log.

You can use this command to setup SNMP traps. For SNMP, you must supply the following information:

- When to raise a trap.

- The IP address of the SNMP manager
- The SNMP community

Possible failures

- CMMVC5786E The action failed because the cluster is not in a stable state.
- CMMVC6252E The command failed authorization because the session SSH key is wrong or was deleted.
- CMMVC6253E The command failed authorization because the session SSH key does not have the requisite role.

An invocation example

```
svctask setevent -snmptrap all -snmpip 1.2.3.4
-community mysancommunity
```

The resulting output

No feedback

setlocale

The **setlocale** command changes the locale setting for the cluster. It also changes all interfaces output to the chosen language.

Syntax

```
▶▶— svcservicetask — — setlocale — — -locale — locale_id —————▶▶
```

Parameters

-locale *locale_id*
Specifies the locale ID.

Description

This command changes the language in which error messages are displayed as output from the command-line interface. Subsequently, all error messages from the command-line tools are generated in the chosen language. This command is run when you request a change of language (locale) and is generally run from the Web page. Issue the **svcservicetask setlocale** command to change the locale setting for the cluster; all interface output is changed to the chosen language. For example, to change the language to Japanese, type the following:

```
svcservicetask setlocale -locale 3
```

where **3** is the value that stands for Japanese. The possible values are:

- **0** US English (default)
- **1** Chinese (simplified)
- **2** Chinese (traditional)
- **3** Japanese
- **4** Korean
- **5** French
- **6** German
- **7** Italian

- 8 Spanish
- 9 Portuguese (Brazilian)

Notes:

1. Currently English and Japanese are the only supported locales.
2. This command does not change the front panel display panel settings.

Possible failures

- There are no error codes.

An invocation example

```
svcservicetask setlocale -locale 3
```

The resulting output

No feedback

svqueryclock

The **svqueryclock** command returns the date, time, and current time-zone of the cluster.

Syntax

```
▶▶—svqueryclock—————▶▶
```

Description

This command returns the date, time and current time-zone of the cluster.

Possible failures

- There are no error codes.

An invocation example

```
svqueryclock
```

The resulting output

```
Mon Nov 25 14:59:28 GMT 2002
```

writesernum

Use the **writesernum** command to write the node serial number into the planar NVRAM.

Syntax

```
▶▶—svcservicetask — — writesernum — — -sernum — serial_number — —▶▶
```

```
▶▶— node_id —————▶▶
   └─ node_name ─┘
```

Parameters

-sernum *serial_number*

(Required) Specifies the serial number to write to the nonvolatile memory of the system planar.

node_id | *node_name*

(Required) Specifies the node where the system planar is located. The serial number is written to this system planar. This name is not the worldwide node name (WWNN).

Description

This command writes the node serial number into the planar NVRAM and then reboots the system. You can find the serial number at the front of the node without having to remove it from the rack. The serial number is located to the left of the right-side thumbscrew that holds the node into the rack. This serial number is usually seven digits.

Note: Once you have written the serial number to the planar NVRAM, you can issue the **svcinfo lsnodevpd** command to verify that the number is correct. The `system_serial_number` field contains the serial number.

Possible failures

- CMMVC5786E The action failed because the cluster is not in a stable state.
- CMMVC5791E The action failed because an entity that was specified in the command does not exist.
- CMMVC5794E The action failed because the node is not a member of the cluster.

An invocation example

```
svcservicetask writesernum -sernum 1300027 node1
```

The resulting output

No feedback

Chapter 10. Host commands

The following commands enable you to work with host options with the SAN Volume Controller.

addhostiogr

The **addhostiogr** command enables you to map I/O groups to an existing host object.

Syntax

```
svctask -- addhostiogr -- [-iogr iogr_list] [-iograll] -- host_name | host_id
```

Parameters

-iogr *iogr_list*

(Required if you do not use **-iograll**) Specifies a colon-separated list of one or more I/O groups that must be mapped to the host. You cannot use this parameter with the **-iograll** parameter.

-iograll

(Required if you do not use **-iogr**) Specifies that all the I/O groups must be mapped to the specified host. You cannot use this parameter with the **-iogr** parameter.

host_id | *host_name*

(Required) Specifies the host to which the I/O groups must be mapped, either by ID or by name.

Description

This command allows you to map the list of I/O groups to the specified host object.

Possible failures

- CMMVC5786E The action failed because the cluster is not in a stable state.
- CMMVC5874E The action failed because the host does not exist.
- CMMVC6218E The maximum number of host I/O group pairs for the cluster is already configured.
- CMMVC6220E The maximum number of hosts for one or more I/O groups is already configured.
- CMMVC6224E The host already belongs to one or more of the I/O groups specified.
- CMMVC6252E The command failed authorization because the session SSH key is wrong or was deleted.
- CMMVC6253E The command failed authorization because the session SSH key does not have the requisite role.

An invocation example

```
svctask addhostiogrp -iogrpall testhost
```

The resulting output

No feedback

addhostport

The **addhostport** command adds worldwide port names (WWPNs) to an existing host object.

Syntax

```
svctask -- addhostport -- -hbawwpn -- wwpn_list -- [ -force ]
```



```
[ host_name | host_id ]
```

Parameters

-hbawwpn *wwpn_list*

(Required) Specifies the list of ports to add to the host.

-force

(Optional) Specifies that the list of ports be added to the host without the validation of any WWPNs.

host_id | *host_name*

(Required) Specifies the host object to add ports to, either by ID or by name.

Description

This command adds the list of HBA WWPNs to the specified host object. Only logged-in unconfigured WWPNs can be added. For a list of candidate WWPNs, see the **svcinfo lshbaportcandidate** command.

Some HBA device drivers do not log in to the fabric until they can recognize target LUNs. Because they do not log in, their WWPNs are not be recognized as candidate ports. You can specify the **-force** parameter with the **svctask addhostport** command to stop the validation of the WWPN list.

Any virtual disks that are mapped to this host object automatically map to the new ports.

Replacing an HBA in a host: List the candidate HBA ports by issuing the **svcinfo lshbaportcandidate** command. This command generates a list of the HBA ports that are available for addition to host objects. One or more of these ports should correspond with the one or more WWPNs that belong to the new HBA. Locate the host object that corresponds with the host in which you have replaced the HBA. The following command lists all the defined host objects:

```
svcinfo lshost
```

To list the WWPNs that are currently assigned to the host, issue the following command:

```
svcinfolshost hostobjectname
```

where *hostobjectname* is the name of the host object.

Add the new ports to the existing host object by issuing the following command:

```
svctask addhostport -hbawwpn one or more existing WWPNS  
separated by : hostobjectname/ID
```

where *one or more existing WWPNS separated by :* and *hostobjectname/id* correspond to those values that are listed in the previous steps.

Remove the old ports from the host object by issuing the following command:

```
svctask rmhostport -hbawwpn one or more existing WWPNS  
separated by : hostobjectname/ID
```

where *one or more existing WWPNS separated by :* corresponds to those values that are listed in the previous step that belong to the old HBA that has been replaced. Any mappings that exist between the host object and VDIs are automatically applied to the new WWPNS. Therefore, the host can recognize that the VDIs as the same SCSI LUNs as before. See the host multipathing device driver documentation for additional information about dynamic reconfiguration.

Possible failures

- CMMVC5786E The action failed because the cluster is not in a stable state.
- CMMVC5867E The action failed because the worldwide port name is already assigned or is not valid.
- CMMVC5872E The port (WWPN) was not added to the host object because an entity that was specified in the command does not exist.
- CMMVC5874E The action failed because the host does not exist.
- CMMVC5753E The object specified does not exist.
- CMMVC6252E The command failed authorization because the session SSH key is wrong or was deleted.
- CMMVC6253E The command failed authorization because the session SSH key does not have the requisite role.

An invocation example

```
svctask addhostport -hbawwpn 210100E08B251DD4 host_one
```

The resulting output

```
No feedback
```

chhost

The **chhost** command changes the name or type of a host object. This does not affect any existing virtual disk-to-host mappings.

Syntax

```
▶▶ svctask — — chhost — —————▶  
└── -type ┌── hpx ───┐  
          ├── tpgs ───┐  
          └── generic ─┘
```

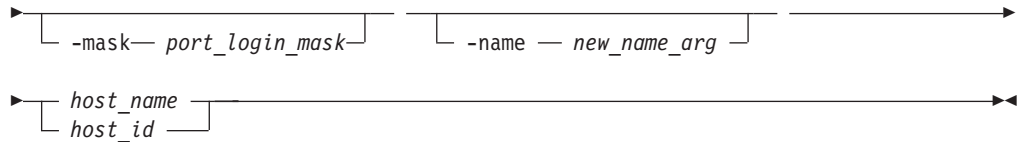

Parameters

-type *hpux* | *tpgs* | *generic*

(Optional) Specifies the type of host: **hpux**, **tpgs**, or **generic**. The default is **generic**. The **tpgs** parameter enables extra target port unit attentions. See the *IBM System Storage SAN Volume Controller: Host Attachment Guide* for more information on the hosts that require the **-type** parameter.

-name *new_name_arg*

(Optional) Specifies the new name that you want to assign to the host object.

-mask *port_login_mask*

(Optional) Specifies which node target ports that a host can access. The port mask is four binary bits and is made of a combination of 0's and 1's, where 0 indicates that the corresponding target port cannot be used and 1 indicates that it can be used. The right-most bit in the mask corresponds to the lowest numbered target port (1 not 4) on a node. Valid mask values range from **0000** (no ports enabled) to **1111** (all ports enabled). For example, a mask of **0011** enables port 1 and port 2. The default value is **1111** (all ports enabled).

host_name | *host_id*

(Required) Specifies the host object to modify, either by ID or by current name.

Description

This command can change the name of the specified host to a new name, or it can change the type of host. This command does not affect any of the current virtual disk-to-host mappings.

The port mask applies to logins from the host initiator port that are associated with the host object. For each login between a host HBA port and node port, the node examines the port mask that is associated with the host object for which the host HBA is a member and determines if access is allowed or denied. If access is denied, the node responds to SCSI commands as if the HBA port is unknown.

Possible failures

- CMMVC5786E The action failed because the cluster is not in a stable state.
- CMMVC5868E The action failed because an entity that was specified in the command does not exist.
- CMMVC5869E The host object was not renamed because the host ID or name is not valid.
- CMMVC5874E The action failed because the host does not exist.
- CMMVC6252E The command failed authorization because the session SSH key is wrong or was deleted.
- CMMVC6253E The command failed authorization because the session SSH key does not have the requisite role.

An invocation example

```
svctask chhost -name testhostlode -mask 0011 hostone
```

The resulting output

No feedback

mkhost

The **mkhost** command creates a logical host object.

Syntax

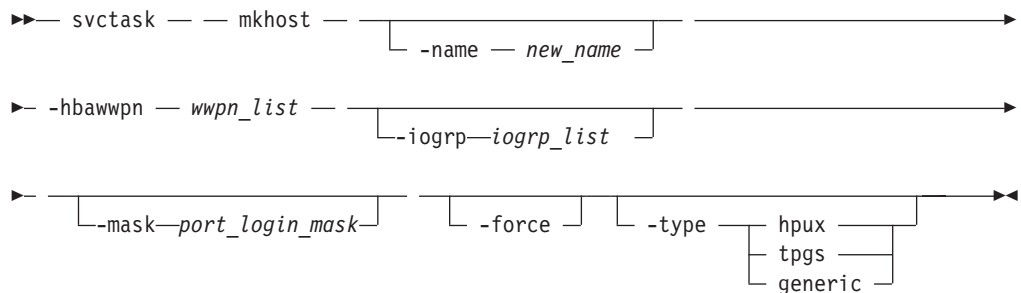

Parameters

-name *new_name*

(Optional) Specifies a name or label for the new host object.

-hbawwpn *wwpn_list*

(Required) Specifies a list of host bus adapter (HBA) worldwide port names (WWPNs) to add to the specified host object.

-iogrp *iogrp_list*

(Optional) Specifies a set of one or more I/O groups that the host can access the VDisks from. I/O groups are specified using their names or IDs, separated by a colon. Names and IDs can be mixed in the list. If this parameter is not specified, the host is associated with all I/O groups.

-mask *port_login_mask*

(Optional) Specifies which node target ports that a host can access. The port mask is four binary bits and is made up of a combination of 0's and 1's, where 0 indicates that the corresponding target port cannot be used and 1 indicates that it can be used.. The right-most bit in the mask corresponds to the lowest numbered target port (1 not 4) on a node. Valid mask values range from **0000** (no ports enabled) to **1111** (all ports enabled). For example, a mask of **0011** enables port 1 and port 2. The default value is **1111** (all ports enabled).

-force

(Optional) Specifies that a logical host object be created without validation of the WWPNs.

-type **hpux** | **tpgs** | **generic**

(Optional) Specifies the type of host: **hpux**, **tpgs**, or **generic**. The default is **generic**. The **tpgs** parameter enables extra target port unit attentions. See the *IBM System Storage SAN Volume Controller: Host Attachment Guide* for more information on the hosts that require the **-type** parameter.

Description

The **mkhost** command associates one or more HBA WWPNs with a logical host object. This command creates a new host. The ID is displayed when the command

completes. You can subsequently use this object when you map virtual disks to hosts by using the **mkvdiskhostmap** command.

Issue the **mkhost** command only once. The cluster scans the fabric for WWPNs in the host zone. The cluster itself cannot filter into the hosts to determine which WWPNs are in which hosts. Therefore, you must use the **svctask mkhost** command to identify the hosts.

After you identify the hosts, mappings are created between hosts and virtual disks. These mappings effectively present the virtual disks to the hosts to which they are mapped. All WWPNs in the host object are mapped to the virtual disks.

Some HBA device drivers do not log in to the fabric until they can see target logical unit numbers (LUNs). Because they do not log in, their WWPNs are not recognized as candidate ports. You can specify the **-force** parameter with this command to stop the validation of the WWPN list.

This command fails if you add the host to an I/O group that is associated with more host ports or host objects than is allowed by the limits within the cluster.

For additional information, see the **svctask mkvdiskhostmap** and **svcinfo lshbaportcandidate** commands.

Possible failures

- CMMVC5786E The action failed because the cluster is not in a stable state.
- CMMVC5867E The action failed because the worldwide port name is already assigned or is not valid.
- CMMVC5868E The action failed because an entity that was specified in the command does not exist.
- CMMVC5729E One or more components in the list is not valid.
- CMMVC6217E The maximum number of hosts for the cluster is already configured.
- CMMVC6218E The maximum number of host I/O group pairs for the cluster is already configured.
- CMMVC6219E The maximum number of WWPNs for the cluster is already configured.
- CMMVC6220E The maximum number of hosts for one or more I/O groups is already configured.
- CMMVC6221E The maximum number of WWPNs for one or more I/O groups is already configured.
- CMMVC6222E The maximum number of WWPNs for the host is already configured.
- CMMVC6252E The command failed authorization because the session SSH key is wrong or was deleted.
- CMMVC6253E The command failed authorization because the session SSH key does not have the requisite role.

An invocation example

```
svctask mkhost -name hostone -hbawwn 210100E08B251DD4 -force -mask 1001
```

The resulting output

```
Host id [1] successfully created.
```

rmhost

The **rmhost** command deletes a host object.

Syntax

```
svctask -- rmhost [-force] [host_name | host_id]
```

Parameters

-force

(Optional) Specifies that you want the system to delete the host object even if mappings still exist between this host and virtual disks (VDisks). When the **-force** parameter is specified, the mappings are deleted before the host object is deleted.

host_name | *host_id*

(Required) Specifies the host object to delete, either by ID or by name.

Description

The **rmhost** command deletes the logical host object. The WWPNs that were contained by this host object (if it is still connected and logged in to the fabric) are returned to the unconfigured state. When you issue the **svcinfolshbaportcandidate** command, the host objects are listed as candidate ports.

If any mappings still exist between this host and virtual disks, the command fails unless you specify the **-force** parameter. When the **-force** parameter is specified, the **rmhost** command deletes the mappings before the host object is deleted.

Possible failures

- CMMVC5786E The action failed because the cluster is not in a stable state.
- CMMVC5870E The host object was not deleted because an entity that was specified in the command does not exist.
- CMMVC5871E The action failed because one or more of the configured worldwide port names is in a mapping.
- CMMVC5874E The action failed because the host does not exist.
- CMMVC5871E The host object was not deleted because there are virtual disk to host mappings for this host. To delete this host, a forced deletion is required.
- CMMVC6252E The command failed authorization because the session SSH key is wrong or was deleted.
- CMMVC6253E The command failed authorization because the session SSH key does not have the requisite role.

An invocation example

```
svctask rmhost host_one
```

The resulting output

```
No feedback
```

rmhostiogr

The **rmhostiogr** command enables you to delete mappings between one or more I/O groups and a specified host object.

Syntax

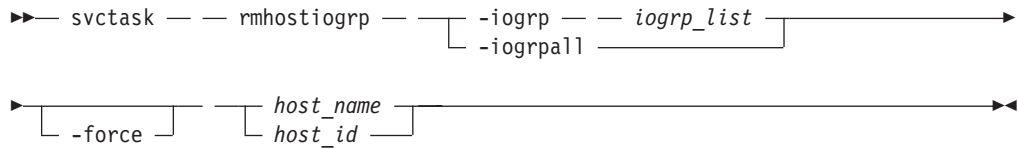

Parameters

-iogrp *iogrp_list*

(Required) Specifies a set of one or more I/O group mappings that will be deleted from the host. You cannot use this parameter with the **-iogrpall** parameter.

-iogrpall

(Optional) Specifies that all the I/O group mappings that are associated with the specified host must be deleted from the host. You cannot use this parameter with the **-iogrp** parameter.

-force

(Optional) Specifies that you want the system to remove the specified I/O group mappings on the host even if the removal of a host to I/O group mapping results in the loss of VDisk-to-host mappings.

host_id | *host_name*

(Required) Specifies the identity of the host either by ID or name from which the I/O group mappings must be deleted.

Description

The **rmhostiogr** command deletes the mappings between the list of I/O groups and the specified host object.

This command fails if any of the I/O groups that are deleted from the host contain VDisks that have host mappings to the host. To resolve this problem, do one of the following:

- Delete the VDisks-to-host mappings that are causing the error.
- Delete the VDisks or the host.
- Issue the **rmhostiogr** command with the **-force** parameter.

Possible failures

- CMMVC5786E The action failed because the cluster is not in a stable state.
- CMMVC5874E The action failed because the host does not exist.
- CMMVC6223E The host does not belong to one or more of the I/O groups specified or inferred
- CMMVC6252E The command failed authorization because the session SSH key is wrong or was deleted.
- CMMVC6253E The command failed authorization because the session SSH key does not have the requisite role.

An invocation example

```
svctask rmhostiogrp -iogrp 1:2 host0
```

The resulting output

No feedback

rmhostport

The **rmhostport** command deletes worldwide port names (WWPNs) from an existing host object.

Syntax

```
svctask -- rmhostport -- -hbawwpn -- wwpn_list -- [ -force ] --  
[ host_name | host_id ]
```

Parameters

-hbawwpn *wwpn_list*

(Required) Specifies the list of ports that you can delete from the host.

-force

(Optional) Specifies that you want the system to delete the ports that you have specified without performing the validation check. The validation check ensures that the list of ports that you want to delete are actually mapped to the specified host. When the ports are deleted, they become unconfigured WWPNs.

host_name | *host_id*

(Required) Specifies the host name or the host ID.

Description

This command deletes the list of HBA WWPNs from the specified host object. If these ports are still logged in to the fabric, they become unconfigured and are listed as candidate WWPNs. See also the **svcinfolshbaportcandidate** command.

Any virtual disks that are mapped to this host object are automatically unmapped from the ports.

Replacing an HBA in a host: List the candidate HBA ports by issuing the **svcinfolshbaportcandidate** command. A list of the HBA ports that are available to be added to host objects is displayed. One or more of these ports corresponds with one or more WWPNs that belong to the new HBA. Locate the host object that corresponds to the host in which you have replaced the HBA. The following command lists all the defined host objects:

```
svcinfolshost
```

To list the WWPNs that are currently assigned to the host, issue the following:

```
svcinfolshost hostobjectname
```

where *hostobjectname* is the name of the host object.

Add the new ports to the existing host object by issuing the following command:

```
svctask addhostport -hbawwpn one or more existing WWPNS  
separated by : hostobjectname/ID
```

where *one or more existing WWPNS separated by :* and *hostobjectname/id* correspond to those values listed in the previous steps.

Remove the old ports from the host object by issuing the following command:

```
svctask rmhostport -hbawwpn one or more existing WWPNS  
separated by : hostobjectname/ID
```

where *one or more existing WWPNS separated by :* corresponds with those WWPNS that are listed in the previous step that belong to the old HBA that has been replaced. Any mappings that exist between the host object and VDisks are automatically applied to the new WWPNS. Therefore, the host recognizes that the VDisks are the same SCSI LUNs as before. See the *Multipath Subsystem Device Driver: User's Guide* for additional information about dynamic reconfiguration.

Possible failures

- CMMVC5786E The action failed because the cluster is not in a stable state.
- CMMVC5867E The action failed because the worldwide port name is already assigned or is not valid.
- CMMVC5871E The action failed because one or more of the configured worldwide port names is in a mapping.
- CMMVC5872E The port (WWPN) was not added to the host object because an entity that was specified in the command does not exist.
- CMMVC5873E The action failed because there is no matching worldwide port name.
- CMMVC5874E The action failed because the host does not exist.
- CMMVC6252E The command failed authorization because the session SSH key is wrong or was deleted.
- CMMVC6253E The command failed authorization because the session SSH key does not have the requisite role.

An invocation example

```
svctask rmhostport -hbawwpn 210100E08B251DD4 host_one
```

The resulting output

No feedback

Chapter 11. Virtual disk commands

The following commands enable you to work with virtual disk options with the SAN Volume Controller.

chvdisk

The **chvdisk** command modifies properties of a virtual disk (one property at a time), such as the disk name, I/O group, I/O governing rate, or unit number.

Syntax

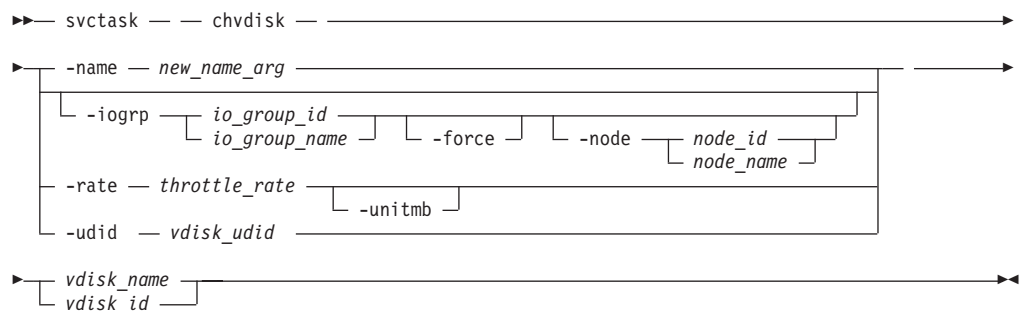

Parameters

-name *new_name_arg*

(Optional) Specifies a new name to assign to the virtual disk. You cannot use this parameter with the **-iogrp**, **-rate**, **-node**, or **-udid** parameters. This parameter is required if you do not use the **-iogrp**, **-rate**, or **-udid** parameter.

-iogrp *io_group_id* | *io_group_name*

(Optional) Specifies a new I/O group to move the virtual disk to, either by ID or name. You can use the **-force** parameter with the **-iogrp** parameter to force the removal of the VDisk to the I/O group. You can also use the **-node** parameter with the **-iogrp** parameter to specify a preferred node for the specified VDisk.

If the VDisk has a mapping to any hosts, it is not possible to move the VDisk to an I/O group that does not include any of those hosts.

You cannot use this parameter with the **-name**, **-rate**, or **-udid** parameters.

-force

(Optional) Specifies that you want to force the VDisk to be removed from an I/O group. This parameter can only be used with the **-iogrp** parameter.

Attention: The **-force** parameter can corrupt the contents of the VDisk. If the **-force** parameter is used and the cluster is unable to destage all write data from the cache, the contents of the VDisk are corrupted by the loss of the cached data.

-rate *throttle_rate* [-unitmb]

(Optional) Specifies the I/O governing rate for the VDisk, which caps the amount of I/O that is accepted. The default *throttle_rate* units are I/Os. To change the *throttle_rate* units to megabytes per second (MBps), specify the

-unitmb parameter. The governing rate for a virtual disk can be specified by I/Os or by MBps, but not both. However, you can set the rate to I/Os for some virtual disks and to MBps for others.

You cannot use this parameter with the **-name**, **-iogrp**, **-node**, or **-udid** parameters.

-udid *vdisk_udid*

(Optional) Specifies the unit number (**udid**) for the disk. The *vdisk_udid* is an identifier that is required to support OpenVMS hosts; no other systems use this parameter. Valid options are a decimal number from 0 to 32 767 or a hexadecimal number from 0 to 0x7FFF. A hexadecimal number must be preceded by 0x (for example, 0x1234). If you do not use the **-udid** parameter, the default **udid** is 0.

You cannot use this parameter with the **-name**, **-iogrp**, **-node**, or **-rate** parameters.

-node *node_id* | *node_name*

(Optional) Specifies a preferred node for the specified VDisk. When using this parameter, you must also specify the **-iogrp** parameter. You cannot use this parameter with the **-name**, **-rate**, or **-udid** parameters.

vdisk_name | *vdisk_id*

(Required) Specifies the virtual disk to modify, either by ID or by name.

Description

This command modifies a single property of a virtual disk. You can modify one property at a time. Therefore, to change the name and modify the I/O group, you must issue the command twice.

You can specify a new name or label. You can use the new name subsequently to refer to the virtual disk. To specify a preferred node for the VDisk, use the **-node** *node_id* | *node_name* parameter.

You can change the I/O group with which this virtual disk is associated. However, to change the I/O group, you must first flush the cache within the nodes in the current I/O group to ensure that all data is written to disk. Ensure that you suspend I/O operations at the host level before you perform this operation.

Attention: Do not move a VDisk to an offline I/O group under any circumstance. You must ensure that the I/O group is online before you move the VDIsks to avoid any data loss.

You can set a limit on the amount of I/O transactions that is accepted for this virtual disk. It is set in terms of I/Os per second or MBs per second. By default, no I/O governing rate is set when a virtual disk is created.

Attention: All capacities, including changes, must be in multiples of 512 bytes. An error occurs if you specify a capacity that is not a multiple of 512, which can only happen when byte units (-b) are used. However, an entire extent is reserved even if it is only partially used. The default capacity is in MB.

When the virtual disk is created, there is no throttling applied to it. Using the **-rate** parameter can change this. To change the virtual disk back to an unthrottled state, specify 0 (zero) with the **-rate** parameter.

You can migrate a VDisk to a new I/O group to manually balance the workload across the nodes in the cluster. You might end up with a pair of nodes that are overworked and another pair that are underworked. Use the following procedure to migrate a single VDisk to a new I/O group. Repeat for other VDIs as required.

Attention: This is a disruptive procedure. Access to the VDisk is lost while you follow this procedure.

Ensure that when you migrate a VDisk to a new I/O group, you quiesce all I/O operations for the VDisk. Determine the hosts that are using this VDisk. Stop or delete any FlashCopy mappings or Metro or Global Mirror relationships that use this VDisk. To check if the VDisk is part of a relationship or mapping, issue the **svcinfolsvdiskvdiskname | id** command, where *vdiskname | id* is the name or ID of the VDisk.

Look for the **FC_id** and **RC_id** fields. If these are not blank, the VDisk is part of a mapping or relationship. See “Managed disk commands” for details on how to stop or delete the mapping or relationship. Issue the following command to migrate the VDisk:

```
svctask chvdisk -iogrp newiogrpname|id vdiskname|id
```

Follow the procedure to discover the new vpaths and to check that each vpath is presenting the correct number of paths. See the *Multipath Subsystem Device Driver: User's Guide* for details on how to dynamically reconfigure SDD for the given host operating system.

Possible failures

- CMMVC5756E Cannot perform the request as the object is already mapped.
- CMMVC5786E The action failed because the cluster is not in a stable state.
- CMMVC5832E The property of the virtual disk (VDisk) was not modified because an entity that was specified in the command does not exist.
- CMMVC5833E The property of the virtual disk (VDisk) was not modified because there are no nodes in the I/O group.
- CMMVC5834E The I/O group for the virtual disk (VDisk) was not modified because the group is a recovery I/O group. To modify the I/O group, use the force option.
- CMMVC5848E The action failed because the virtual disk (VDisk) does not exist or it is being deleted.
- CMMVC5853E The action failed because there was a problem with the group.
- CMMVC5856E The action failed because the virtual disk (VDisk) does not belong to the specified managed disk (MDisk) group.
- CMMVC5857E The action failed because the managed disk (MDisk) does not exist or it is not a member of the managed disk (MDisk) group.
- CMMVC5858E The action failed because the virtual disk (VDisk) is in the wrong mode, the managed disk (MDisk) is in the wrong mode, or both are in the wrong mode.
- CMMVC5860E The action failed because there were not enough extents in the managed disk (MDisk) group.
- CMMVC5861E The action failed because there were not enough extents on the managed disk (MDisk).

- CMMVC5862E The action failed because the virtual disk (VDisk) is being formatted.
- CMMVC6076E The VDisk cache is not empty. Wait for the cache to flush or use the force flag to discard contents of the cache.
- CMMVC6032E The operation was not performed because one or more of the entered parameters is invalid for this operation.
- CMMVC6223E The host does not belong to one or more of the I/O groups specified or inferred.
- CMMVC6252E The command failed authorization because the session SSH key is wrong or was deleted.
- CMMVC6253E The command failed authorization because the session SSH key does not have the requisite role.
- CMMVC6264E The command failed because one of the nodes in the specified I/O group was offline when the command was issued.
- CMMVC6265E The command failed because there is not enough memory available for reservation.
- CMMVC6266E The command failed because the cluster was not stable when the command was issued.
- CMMVC6267E The specified size exceeds the maximum permitted for this feature.
- CMMVC6268E The specified size exceeds the maximum permitted. The total memory size across all features exceeds the maximum permitted.
- CMMVC6269E The specified size does not meet the minimum requirement. The total size cannot be reduced by more than the amount of free memory.

An invocation example

```
svctask chvdisk -rate 2040 -unitmb 6
```

The resulting output

No feedback

expandvdisksize

The **expandvdisksize** command expands the size of a VDisk by a given capacity.

Syntax

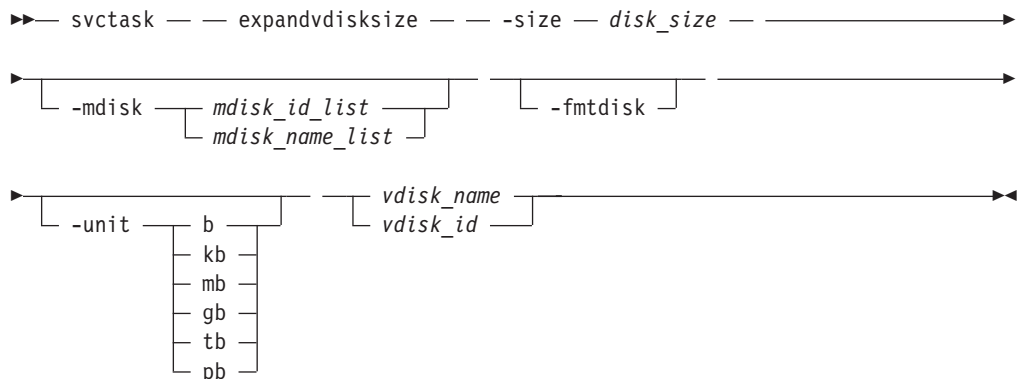

Parameters

-size *disk_size*

(Required) Specifies the capacity by which the virtual disk is expanded. Disk size is used with the value of the unit. All capacities, including changes must be in multiples of 512 bytes. An error occurs if you specify a capacity that is not a multiple of 512, which can only happen when byte units (**-unit b**) are used. However, an entire extent is reserved even if it is only partially used. The default capacity is in MB.

-mdisk *mdisk_id_list* | *mdisk_name_list*

(Optional) Specifies the list of one or more MDisks to be used as the stripe set. The extents that expand the VDisk come from the specified list of MDisks. All MDisks in the list must be part of the same MDisk group.

-fmtdisk

(Optional) Specifies that the VDisk be formatted before use. This parameter formats the new extents that have been added to the VDisk as a result of the **expandvdisksize** command. The **expandvdisksize** command completes asynchronously if you use this parameter.

-unit b | **kb** | **mb** | **gb** | **tb** | **pb**

(Optional) Specifies the data units that are used in conjunction with the capacity (-size).

vdisk_name | *vdisk_id*

(Required) Specifies the virtual disk to modify, either by ID or by name.

Description

This command expands the capacity that is allocated to the particular virtual disk by the given amount. The default capacity is in MB.

When a VDisk is expanded, the virtualization policy can change. Its mode becomes striped even if it was previously sequential. See the **svctask mkvdisk** command for details of the virtualization policies.

Possible failures

- CMMVC5756E Cannot perform the request as the object is already mapped to another object or is the subject of an FC or RC relationship.
- CMMVC5786E The action failed because the cluster is not in a stable state.
- CMMVC5808E The action failed because the managed disk (MDisk) does not exist.
- CMMVC5835E The virtual disk (VDisk) was not expanded because an object that was specified in the command does not exist.
- CMMVC5837E The action failed because the virtual disk (VDisk) is part of a FlashCopy mapping.
- CMMVC5838E The action failed because the virtual disk (VDisk) is part of a Remote Copy mapping.
- CMMVC5848E The action failed because the virtual disk (VDisk) does not exist or it is being deleted.
- CMMVC5853E The action failed because there was a problem with the group.
- CMMVC5856E The action failed because the virtual disk (VDisk) does not belong to the specified managed disk (MDisk) group.
- CMMVC5857E The action failed because the managed disk (MDisk) does not exist or it is not a member of the managed disk (MDisk) group.

- CMMVC5858E The action failed because the virtual disk (VDisk) is in the wrong mode, the managed disk (MDisk) is in the wrong mode, or both are in the wrong mode.
- CMMVC5860E The action failed because there were not enough extents in the managed disk (MDisk) group.
- CMMVC5861E The action failed because there were not enough extents on the managed disk (MDisk).
- CMMVC5862E The action failed because the virtual disk (VDisk) is being formatted.
- CMMVC5998W The virtualized storage capacity exceeds the amount that you are licensed to use.
- CMMVC6036E An invalid action was requested
- CMMVC6252E The command failed authorization because the session SSH key is wrong or was deleted.
- CMMVC6253E The command failed authorization because the session SSH key does not have the requisite role.

An invocation example

```
svctask expandvdisksize -size 2048 -unit b -mdisk
mdisk0:mdisk1 -fmtdisk vdisk1
```

The resulting output

No feedback

mkvdisk

The **mkvdisk** command creates sequential, striped, or image mode virtual disk objects. When they are mapped to a host object, these objects are seen as disk drives with which the host can perform I/O operations.

Note: The first syntax diagram depicts the creation of a sequential or striped mode virtual disk. The second syntax diagram depicts the creation of an image mode virtual disk.

Syntax

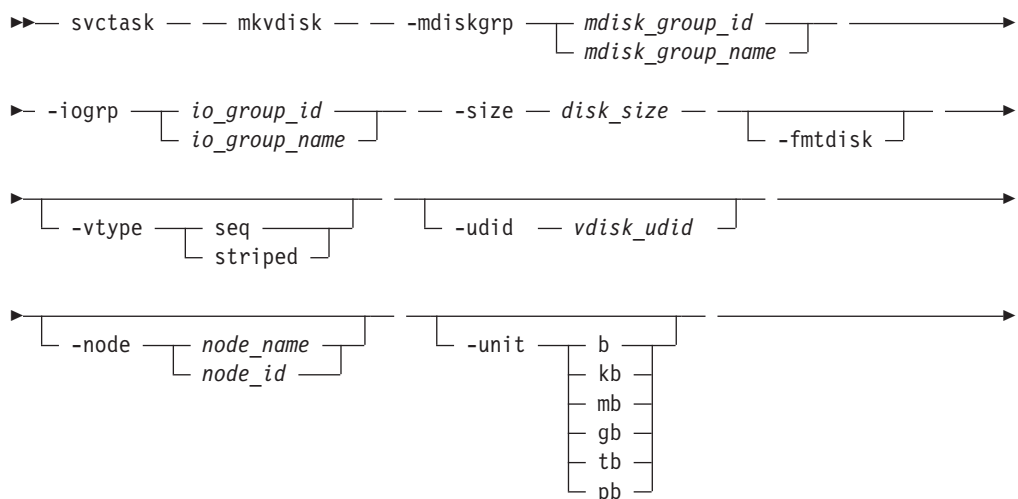

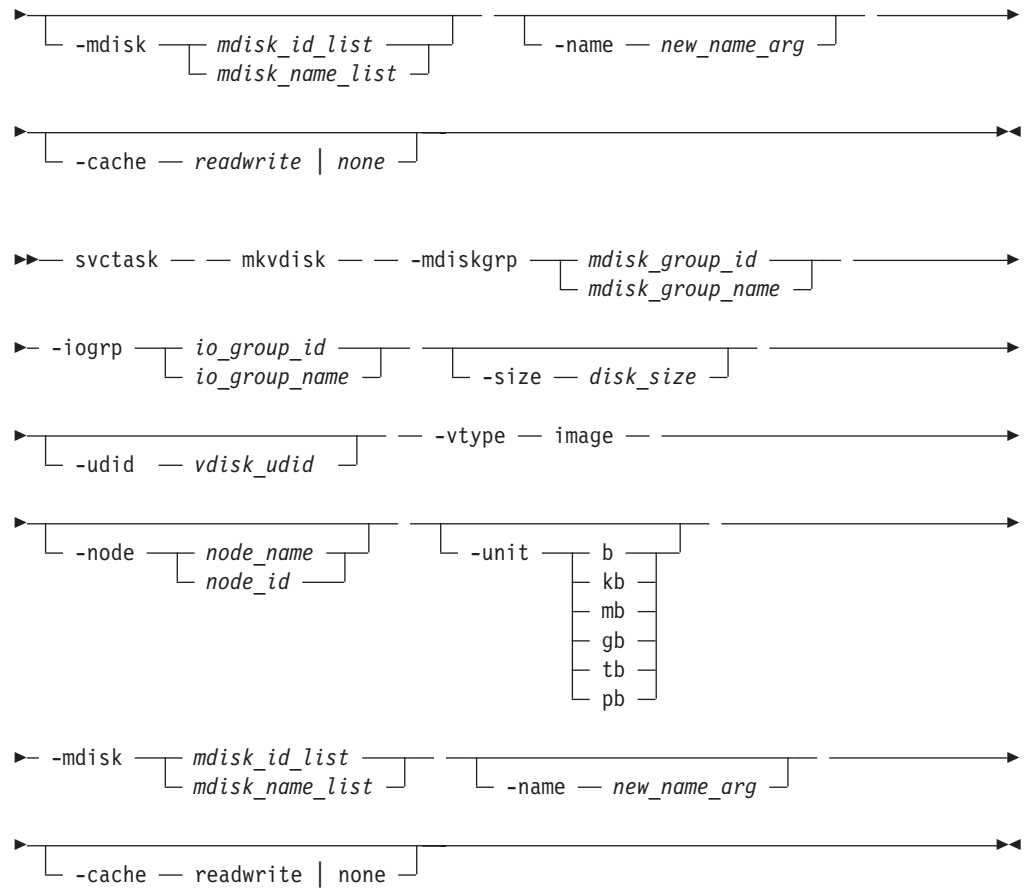

Parameters

-mdiskgrp *mdisk_group_id* | *mdisk_group_name*

(Required) Specifies the managed disk group to use when you are creating this virtual disk.

-iogrp *io_group_id* | *io_group_name*

(Required) Specifies the I/O group (node pair) with which to associate this virtual disk.

-udid *vdisk_udid*

(Optional) Specifies the unit number (**udid**) for the disk. The **udid** is an identifier that is required to support OpenVMS hosts; no other systems use this parameter. Valid options are a decimal number 0 - 32 767, or a hexadecimal number 0 - 0x7FFF. A hexadecimal number must be preceded by **0x** (for example, **0x1234**). If you do not use the **-udid** parameter, the default **udid** is **0**.

-size *disk_size*

(Required for sequential or striped VDisks creation; Optional for image VDisks creation) Specifies the capacity of the virtual disk, which is used with the value of the unit. All capacities, including changes, must be in multiples of 512 bytes. An error occurs if you specify a capacity that is not a multiple of 512, which can only happen when byte units (**-b**) are used. However, an entire extent is reserved even if it is only partially used. The default capacity is in MB. You can specify a capacity of 0. Specify the size in bytes in multiples of logical block address (LBA) sizes.

Note: If you do not specify the **-size** parameter when you create an image mode disk, the entire MDisk capacity is used.

-fmtdisk

(Optional; does not apply when you create an image mode VDisk) Specifies that the virtual disk be formatted before it can be used. The **-fmtdisk** parameter formats (sets to all zeros) the extents that make up this VDisk after it is created. If this parameter is used, the command completes asynchronously and you can query the status with the **svcinfo lsvdiskprogress** command.

-vtype seq | striped | image

(Optional for sequential or striped VDisk creation; Required for image VDisk creation) Specifies the virtualization policy. The default virtualization type is striped when you are creating a nonimage VDisk.

-node node_id | node_name

(Optional) Specifies the preferred node ID or the name for I/O operations to this virtual disk. You can use the **-node** parameter to specify the preferred access node.

Note: This parameter is required for the subsystem device driver (SDD). The cluster chooses a default if you do not supply this parameter.

-unit b | kb | mb | gb | tb | pb

(Optional) Specifies the data units to use in conjunction with the capacity that is specified by the **-size** parameter.

-mdisk mdisk_id_list | mdisk_name_list

(Optional for sequential or striped VDisk creation; required for image VDisk creation) Specifies a list of one or more managed disks. This parameter is used in conjunction with the **-vtype** parameter and has different uses depending upon the policy that you chose.

-name new_name_arg

(Optional) Specifies a name to assign to the new virtual disk.

-cache readwrite | none

(Optional) Specifies the caching options for the VDisk. Valid entries are **readwrite** or **none**. The default is **readwrite**. If you do not specify the **-cache** parameter, the default value (**readwrite**) is used.

Description

This command creates a new virtual disk object. You can use the command to create a variety of types of virtual disk objects, making it one of the most complex commands.

You must decide which managed disk group provides the storage for the VDisk. Use the **svcinfo lsmdiskgrp** command to list the available managed disk groups and the amount of free storage in each group.

Choose an I/O group for the VDisk. This determines which nodes in the cluster process the I/O requests from the host systems. If you have more than one I/O group, ensure that you distribute the VDIsks between the I/O groups so that the I/O workload is shared evenly between all nodes. Use the **svcinfo lsiogrp** command to show the I/O groups and the number of virtual disks that are assigned to each I/O group.

Note: It is normal for clusters with more than one I/O group to have MDisk groups that have VDIs in different I/O groups. FlashCopy processing can make copies of VDIs whether the source and target VDIs are in the same I/O group. If, however, you plan to use intracluster Metro or Global Mirror operations, ensure that both the master and auxiliary VDisk are in the same I/O group.

The virtualization policy controls the type of virtual disk to create. These policies include striped, sequential, and image:

Striped

This is the default policy. If the **-vtype** parameter is not specified, this policy is used in its default form. That is, all managed disks in the managed disk group are used to create the virtual disk. The striping is at an extent level; one extent from each managed disk in the group is used. For example, a managed disk group with 10 managed disks uses one extent from each managed disk, then it uses the 11th extent from the first managed disk, and so on.

If the **-mdisk** parameter is also specified, you can supply a list of managed disks to use as the stripe set. This can be two or more managed disks from the same managed disk group. The same circular algorithm is used across the striped set. However, a single managed disk can be specified more than once in the list. For example, if you enter **-m 0:1:2:1**, the extents are from the following maintenance disks: 0, 1, 2, 1, 0, 1, 2, and so forth. All MDisks that are specified in the **-mdisk** parameter must be in the managed mode.

A capacity of 0 is allowed.

Seq (Sequential)

This policy requires the **-mdisk** parameter with a single managed disk as its argument. This MDisk must be in the managed mode.

It creates the virtual disk using extents from the given managed disk (assuming there are enough free extents on the managed disk).

Image This policy allows image mode virtual disks to be created when a managed disk already has data on it, perhaps from a previrtualized subsystem. When an image mode virtual disk is created, it directly corresponds to the (previously unmanaged) managed disk that it was created from; therefore, virtual disk logical block address (LBA) x equals managed disk LBA x . You can use this command to bring a nonvirtualized disk under the control of the cluster. After it is under the control of the cluster, you can migrate the virtual disk from the single managed disk. When it is migrated, the virtual disk is no longer an image mode virtual disk.

You can add image mode VDIs to an already populated MDisk group with other types of VDIs, such as a striped or sequential.

Note: An image mode VDisk must be at least 512 bytes (capacity cannot be 0). That is, the minimum size that can be specified for an image mode VDisk must be the same as the MDisk group extent size that it is added to, with the minimum of 16 MB.

You must use the **-mdisk** parameter to specify an MDisk that has a mode of unmanaged. The **-fmtmdisk** parameter cannot be used to create an image mode VDisk.

The command returns the IDs of the newly created VDisk.

Attention:

1. Do not create a VDisk in an offline I/O group. You must ensure that the I/O group is online before you create a VDisk to avoid any data loss. This applies in particular to recreating VDIs that are assigned the same object ID.
2. To create an image mode disk, you must already have a quorum disk in the cluster because an image mode disk cannot be used to hold quorum data. See “Creating a quorum disk” in the *IBM System Storage SAN Volume Controller: Software Installation and Configuration Guide* for more details.

Possible failures

Note: If you receive an error for this command that indicates that the licensed virtualization capacity has been exceeded, then the command was still effective. However, the return code will indicate the license violation.

- CMMVC5786E The action failed because the cluster is not in a stable state.
- CMMVC5807E The action failed because the managed disk (MDisk) cannot be changed to the specified mode.
- CMMVC5808E The action failed because the managed disk (MDisk) does not exist.
- CMMVC5826E The virtual disk (VDisk) was not created because an entity that was specified in the command does not exist.
- CMMVC5827E The command failed as a result of an inconsistency between two or more of the entered parameters.
- CMMVC5828E The virtual disk (VDisk) was not created because the I/O group contains no nodes.
- CMMVC5829E The image-mode virtual disk (VDisk) was not created because the number of managed disks (MDisks) specified is greater than one.
- CMMVC5830E The image-mode virtual disk (VDisk) was not created because no managed disk (MDisk) was specified in the command.
- CMMVC5831E The virtual disk (VDisk) was not created because the preferred node for I/O operations is not part of the I/O group.
- CMMVC5857E The action failed because the managed disk (MDisk) does not exist or it is not a member of the managed disk (MDisk) group.
- CMMVC5858E The action failed because the virtual disk (VDisk) is in the wrong mode, the managed disk (MDisk) is in the wrong mode, or both are in the wrong mode.
- CMMVC5860E The action failed because there were not enough extents in the managed disk (MDisk) group.

Note: This error is also returned if a stripe set of MDisks has been specified and one or more of these MDisks does not contain enough free extents to complete the creation of the VDisk. In this case, the MDisk group is reporting that it has enough free capacity to create the VDisk. You can check the free capacity on each MDisk by issuing the **svcinfolsfreeextentsmdiskname/ID** command. Alternatively, if you do not specify a stripe set, you can allow the system to choose the free extents automatically.

- CMMVC5861E The action failed because there were not enough extents on the managed disk (MDisk).

- CMMVC6226E (Possible for image creation only) The action was not completed because the cluster has reached the maximum number of extents in MDisk Groups.
- CMMVC6252E The command failed authorization because the session SSH key is wrong or was deleted.
- CMMVC6253E The command failed authorization because the session SSH key does not have the requisite role.
-

An invocation example

```
svctask mkvdisk -mdiskgrp Group0 -size 0
-iogrp 0 -vtype striped -mdisk mdisk1 -node 1
```

The resulting output

Virtual Disk, id [1], successfully created

An invocation example for creating an image mode VDisk

```
svctask mkvdisk -mdiskgrp Group0
-iogrp 0 -vtype image -mdisk mdisk2 -node 1
```

The resulting output

Virtual Disk, id [2], successfully created

mkvdiskhostmap

The **mkvdiskhostmap** command creates a new mapping between a virtual disk and a host, which makes the virtual disk accessible for I/O operations to the specified host.

Syntax

```

▶▶ svctask — — mkvdiskhostmap — —————▶
                                └─ -force ─┘

▶ -host ──┬─ host_id ──┬────────────────────────────────▶
           └─ host_name ┘ └─ -scsi ── scsi_num_arg ──▶

▶ ┬─ vdisk_name ──▶
  └─ vdisk_id ───▶

```

Parameters

-force

(Optional) Allows multiple VDisk-to-host assignments, which are not normally allowed.

-host *host_id* | *host_name*

(Required) Specifies the host to map the virtual disk to, either by ID or by name.

-scsi *scsi_num_arg*

(Optional) Specifies the SCSI LUN ID to assign to this virtual disk on the given host. The *scsi_num_arg* parameter contains the SCSI LUN ID that is assigned to the VDisk on the given host. You must check your host system for the next available SCSI LUN ID on the given HBA. If you do not specify the **-scsi** parameter, the next available SCSI LUN ID is provided to the host.

vdisk_name | *vdisk_id*

(Required) Specifies the name of the virtual disk that you want to map to the host, either by ID or by name.

Description

This command creates a new mapping between the virtual disk and the specified host. The virtual disk is presented to the host as if the disk is directly attached to the host. It is only after this command is processed, that the host can perform I/O transactions to the virtual disk.

Optionally, you can assign a SCSI LUN ID to the mapping. When the HBA in the host scans for devices that are attached to it, it discovers all virtual disks that are mapped to its fibre-channel ports. When the devices are found, each one is allocated an identifier (SCSI LUN ID). For example, the first disk found is usually SCSI LUN 1, and so on. You can control the order in which the HBA discovers virtual disks by assigning the SCSI LUN ID, as required. If you do not specify a SCSI LUN ID, the cluster automatically assigns the next available SCSI LUN ID, if any mappings already exist with that host.

Some HBA device drivers will stop when they find a gap in the SCSI LUN IDs. For example:

- Virtual Disk 1 is mapped to Host 1 with SCSI LUN ID 1
- Virtual Disk 2 is mapped to Host 1 with SCSI LUN ID 2
- Virtual Disk 3 is mapped to Host 1 with SCSI LUN ID 4

When the device driver scans the HBA, it must stop after identifying virtual disks 1 and 2, because no SCSI LUN is mapped with ID 3. For optimal performance, ensure that the SCSI LUN ID allocation is contiguous.

You can create multiple VDisk assignments. Normally, multiple VDisk-to-host assignments are not used because corruption is likely to occur if more than one host can access a disk. However, in certain multiple path environments, such as in the IBM SAN File System, a VDisk must be mapped to more than one host. To map to more than one host, you must use the **mkvdiskhostmap** command with the **-force** parameter. For example:

```
svctask mkvdiskhostmap -host host1 -force 4  
svctask mkvdiskhostmap -host host2 -force 4
```

These commands create two host-to-VDisk mappings for VDisk 4 that map to host1 and host2. Omitting the **-force** parameter causes the mapping to fail if that VDisk is already mapped to a host.

The command also fails if the host object (to which this mapping is being made) is not associated with the I/O group containing the VDisk.

Possible failures

- CMMVC5786E The action failed because the cluster is not in a stable state.
- CMMVC5842E The action failed because an entity that was specified in the command does not exist.
- CMMVC5843E The virtual disk (VDisk)-to-host mapping was not created because the VDisk does not have a capacity greater than zero bytes.
- CMMVC5844E The virtual disk (VDisk)-to-host mapping was not created because the SCSI logical unit number (LUN) ID is not valid.

- CMMVC5862E The action failed because the virtual disk (VDisk) is being formatted.
- CMMVC5874E The action failed because the host does not exist.
- CMMVC5875E The action failed because the virtual disk (VDisk) does not exist.
- CMMVC5876E The virtual disk (VDisk)-to-host mapping was not created because the maximum number of mappings has been reached.
- CMMVC5877E The virtual disk (VDisk)-to-host mapping was not created because the maximum number of SCSI LUNs has been allocated.
- CMMVC5878E The virtual disk (VDisk)-to-host mapping was not created because this VDisk is already mapped to this host.
- CMMVC5879E The virtual disk (VDisk)-to-host mapping was not created because this VDisk is already mapped to this host with this SCSI LUN.
- CMMVC5880E The virtual disk (VDisk)-to-host mapping was not created because the VDisk has a capacity of zero bytes.
- CMMVC6071E This action will result in the creation of multiple mappings. Use the `-force` flag if you are sure that this is what you wish to do.
- CMMVC6252E The command failed authorization because the session SSH key is wrong or was deleted.
- CMMVC6253E The command failed authorization because the session SSH key does not have the requisite role.

An invocation example

```
svctask mkvdiskhostmap -host host1 -scsi 1 5
```

The resulting output

```
Virtual Disk to Host map, id [1], successfully created
```

rmvdisk

The **rmvdisk** command deletes a virtual disk (VDisk). The command fails if there are mappings between the virtual disk and hosts and you do not specify the **-force** parameter.

Syntax

```
svctask -- rmvdisk -- [-force] -- [vdisk_id | vdisk_name]
```

Parameters

-force

(Optional) Deletes the specified VDisk, even if mappings still exist between this virtual disk and one or more hosts. This parameter deletes any host-to-VDisk mappings and any FlashCopy mappings that exist for this VDisk. This parameter also deletes any Metro Mirror or Global Mirror relationships that exist for the specified VDisk. Data that is on the virtual disk is lost. Before you issue this command, ensure that the virtual disk and any data that resides on it are no longer required.

vdisk_id | *vdisk_name*

Specifies the name of the virtual disk to delete, either by ID or by name.

Description

This command deletes an existing managed mode virtual disk or an existing image mode virtual disk. The extents that made up this virtual disk are returned to the pool of free extents that are available on the managed disk group, if the VDisk is in managed mode.

Attention: Any data that was on the virtual disk is lost. Before you issue this command, ensure that the virtual disk (and any data that resides on it) is no longer required.

Deleting a managed mode virtual disk

When you use this command to delete a managed mode virtual disk, all the data on the virtual disk is deleted. The extents that make up the virtual disk are returned to the pool of free extents that are available in the managed disk group.

If FlashCopy mappings or host mappings exist for the virtual disk, the deletion fails. You can use the **-force** parameter to force the deletion. If you use the **-force** parameter, mappings are deleted and then the virtual disk is deleted. The **-force** parameter also deletes any Metro Mirror or Global Mirror relationships that exist for the specified VDisk.

Note: When you use the cascaded FlashCopy feature, it is possible to configure a VDisk to be neither the source or target for any FlashCopy mappings, and yet create a mapping that is dependent on data on the VDisk. To check for this scenario, run the **svcinfo lsvdiskdependentmaps** command. The **rmvdisk** fails in this situation unless you use the **-force** parameter.

If the virtual disk is in the process of migrating to an image mode virtual disk (using the **svctask migratetoimage** command), the deletion fails unless you use the **-force** parameter. If you use the **-force** parameter, the migration is halted and then the virtual disk is deleted. Before you issue this command, ensure that the virtual disk (and any data that resides on it) is no longer required.

Deleting an image mode virtual disk

Before you use this command to delete an image mode virtual disk, you must first wait for all fast-write data to be moved to the controller logical unit. This ensures that the data on the controller is consistent with the data on the image mode virtual disk before the VDisk is deleted. This process can take several minutes to complete, and is indicated by the *fast_write_state* state of the virtual disk being **empty**. If the **-force** parameter is specified, the fast-write data is discarded and the virtual disk is deleted immediately; the data on the controller logical unit is left inconsistent and unusable.

If there are any virtual medium errors on the virtual disk, the command fails. You can force the deletion by using the **-force** parameter; however, this can cause data integrity problems.

Note: A virtual medium error occurs when you copy data from one disk (the source) to another (the target). Reading the source indicates that there is a medium error. At that moment, you must have two identical copies of data and you must then simulate a medium error on the target disk. You can simulate a medium error on the target disk by creating a virtual medium error on the target disk.

If FlashCopy mappings or host mappings exist for the virtual disk, the deletion fails unless you use the **-force** parameter. If you use the **-force** parameter, mappings are deleted and the virtual disk is deleted. If there is any data that is not staged in the fast write cache for this virtual disk, the deletion of the virtual disk fails. When the **-force** parameter is specified, any data that is not staged in the fast write cache is deleted. Deleting an image mode virtual disk causes the managed disk that is associated with the virtual disk to be removed from the managed disk group. The mode of the managed disk is returned to “unmanaged.”

Possible failures

- CMMVC5786E The action failed because the cluster is not in a stable state.
- CMMVC5807E The action failed because the managed disk (MDisk) cannot be changed to the specified mode.
- CMMVC5840E The virtual disk (VDisk) was not deleted because it is mapped to a host or because it is part of a Remote Copy mapping.
- CMMVC5841E The virtual disk (VDisk) was not deleted because it does not exist.
- CMMVC5848E The action failed because the virtual disk (VDisk) does not exist or it is being deleted.
- CMMVC5858E The action failed because the virtual disk (VDisk) is in the wrong mode, the managed disk (MDisk) is in the wrong mode, or both are in the wrong mode.
- CMMVC5862E The action failed because the virtual disk (VDisk) is being formatted.
- CMMVC6252E The command failed authorization because the session SSH key is wrong or was deleted.
- CMMVC6253E The command failed authorization because the session SSH key does not have the requisite role.

An invocation example

```
svctask rmvdisk -force vdisk5
```

The resulting output

```
No feedback
```

rmvdiskhostmap

The **rmvdiskhostmap** command deletes an existing virtual disk-to-host mapping; the virtual disk is no longer accessible for I/O transactions on the given host.

Syntax

```

▶▶▶ svctask — — rmvdiskhostmap — — -host ———— [ host_id ] —————▶
                                     [ host_name ]
▶ [ vdisk_id ] —————▶
  [ vdisk_name ]

```

Parameters

-host *host_id* | *host_name*

(Required) Specifies the host that you want to remove from the map with the virtual disk, either by ID or by name.

vdisk_id | *vdisk_name*

(Required) Specifies the name of the virtual disk that you want to remove from the host mapping, either by ID or by name.

Description

This command deletes an existing mapping between the specified virtual disk and the host. This effectively stops the virtual disk from being available for I/O transactions on the given host.

This command also deletes a SCSI or persistent reservation that a host has on a VDisk. Once the reservation is removed, a new host is allowed to access the VDisk in the future because the original host no longer has access.

Use caution when you process this command because to the host, it seems as if the virtual disk has been deleted or is offline.

Possible failures

- CMMVC5786E The action failed because the cluster is not in a stable state.
- CMMVC5842E The action failed because an entity that was specified in the command does not exist.
- CMMVC5874E The action failed because the host does not exist.
- CMMVC5875E The action failed because the virtual disk (VDisk) does not exist.
- CMMVC6252E The command failed authorization because the session SSH key is wrong or was deleted.
- CMMVC6253E The command failed authorization because the session SSH key does not have the requisite role.

An invocation example

```
svctask rmvdiskhostmap -host host1 vdisk8
```

The resulting output

No feedback

shrinkvdisksize

The **shrinkvdisksize** command reduces the size of a VDisk by a given capacity.

Syntax

```
svctask - - shrinkvdisksize - - -size - disk_size - - -
```

Diagram illustrating the syntax of the `shrinkvdisksize` command:

- The command is `svctask - - shrinkvdisksize - - -size - disk_size - - -`.
- The `-unit` parameter is optional and can be `b`, `kb`, `mb`, `gb`, `tb`, or `pb`.
- The `vdisk_name` and `vdisk_id` parameters are optional and can be used interchangeably.

Parameters

`-size disk_size`

(Required) Specifies the size reduction for the designated virtual disk.

-unit b | kb | mb | gb | tb | pb

(Optional) Specifies the data units to be used in conjunction with the value that is specified by the **-size** parameter.

vdisk_name | *vdisk_id*

(Required) Specifies the virtual disk that you want to modify, either by ID or by name.

Description

This command reduces the capacity that is allocated to the particular virtual disk by the given amount. All capacities, including changes must be in multiples of 512 bytes. When specifying byte units (**-unit b**), you must specify a multiple of 512. An entire extent is reserved even if it is only partially used. The default capacity is in MB.

VDisks can be reduced in size, if required.

Attention: If the VDisk contains data that is being used, do not shrink the VDisk without backing up the data first.

The cluster arbitrarily reduces the capacity of the VDisk by removing a partial, one or more extents from those allocated to the VDisk. You cannot control which extents are removed and so you cannot assume that it is unused space that is removed.

Attention:

1. You must use this feature only to make target or auxiliary VDIs the same size when you create FlashCopy mappings or Metro or Global Mirror relationships. You must also ensure that the target VDisk is not mapped to any hosts prior to performing this operation.
2. If the virtual disk contains data, do not shrink the disk.
3. Some operating systems or file systems use what they consider to be the outer edge of the disk for performance reasons. This command can shrink FlashCopy target virtual disks to the same capacity as the source.
4. Validate that the VDisk is not mapped to any host objects. If the VDisk is mapped, data is displayed. You can determine the exact capacity of the source or master VDisk by issuing the **svcinfolsvdisk -bytes vdiskname** command. Shrink the VDisk by the required amount by issuing the **svctask shrinkvdisksize -size disk_size -unit b | kb | mb | gb | tb | pb vdisk_name | vdisk_id** command.

Possible failures

- CMMVC5786E The action failed because the cluster is not in a stable state.
- CMMVC5836E The virtual disk (VDisk) was not shrunk because it is locked.
- CMMVC5837E The action failed because the virtual disk (VDisk) is part of a FlashCopy mapping.
- CMMVC5838E The action failed because the virtual disk (VDisk) is part of a Remote Copy mapping.
- CMMVC5839E The virtual disk (VDisk) was not shrunk because an entity that was specified in the command does not exist.
- CMMVC5848E The action failed because the virtual disk (VDisk) does not exist or it is being deleted.

- CMMVC5862E The action failed because the virtual disk (VDisk) is being formatted.
- CMMVC6010E Unable to complete the command as there are insufficient free extents.
- CMMVC6252E The command failed authorization because the session SSH key is wrong or was deleted.
- CMMVC6253E The command failed authorization because the session SSH key does not have the requisite role.

An invocation example

```
svctask shrinkvdisksize -size 2048 -unit b vdisk1
```

The resulting output

No feedback

Chapter 12. Managed disk group commands

The following commands enable you to work with managed disk group options with the SAN Volume Controller.

addmdisk

The **addmdisk** command adds one or more managed disks to an existing managed disk group.

Syntax

```
svctask -- addmdisk -- -mdisk [ mdisk_id_list | mdisk_name_list ]  
[ mdisk_group_id | mdisk_group_name ]
```

Parameters

-mdisk *mdisk_id_list* | *mdisk_name_list*

(Required) Specifies one or more managed disk IDs or names to add to the group.

mdisk_group_id | *mdisk_group_name*

(Required) Specifies the ID or name of the managed disk group to add the disks to.

Description

This command adds the managed disks that you specify to the group. The disks can be specified in terms of the managed disk ID or the managed disk name.

The managed disks must be in unmanaged mode. Disks that already belong to a group cannot be added to another group until they have been deleted from their current group. You can delete a managed disk from a group under the following circumstances:

- If the managed disk does not contain any extents in use by a virtual disk
- If you can first migrate the extents in use onto other free extents within the group.

Possible failures

- CMMVC5786E The action failed because the cluster is not in a stable state.
- CMMVC5819E The managed disk (MDisk) was not added to the MDisk group because the MDisk is part of another MDisk group.
- CMMVC5820E The managed disk (MDisk) was not added to the MDisk group because an entity that was specified in the command does not exist.
- CMMVC5821E The managed disk (MDisk) was not added to the MDisk group because not enough MDisks were included in the list.
- CMMVC5822E The managed disk (MDisk) was not added to the MDisk group because too many MDisks were included in the list.

- CMMVC5807E The action failed because the managed disk (MDisk) cannot be changed to the specified mode.
- CMMVC5808E The action failed because the managed disk (MDisk) does not exist.
- CMMVC6296E One or more managed disks (MDisks) have failed validation tests, first failing mdisk id [%1].
- CMMVC6297E One or more managed disks (MDisks) have timed out during validation tests, first failing mdisk id [%1].

An invocation example

```
svctask addmdisk -mdisk mdisk13:mdisk14 Group0
```

The resulting output

No feedback

chmdiskgrp

Use the **chmdiskgrp** command to modify the name, or label, assigned to a managed disk group.

Syntax

```
svctask -- chmdiskgrp -- -name -- new_name_arg --
mdisk_group_id | mdisk_group_name
```

Parameters

-name *new_name_arg*

(Required) Specifies the new name of the managed disk group.

mdisk_group_id | *mdisk_group_name*

(Required) Specifies the ID or name of the managed disk group to modify.

Description

This command modifies the name, or label, assigned to a given managed disk group. Subsequently, you can use the new name to refer to the managed disk group.

Possible failures

- CMMVC5786E The action failed because the cluster is not in a stable state.
- CMMVC5816E The action failed because an entity that was specified in the command does not exist.
- CMMVC5817E The managed disk (MDisk) group was not renamed because the name was not valid.

An invocation example

```
svctask chmdiskgrp -name testmdiskgrp Group0
```

The resulting output

No feedback

mkmdiskgrp

The **mkmdiskgrp** command creates a new managed disk group.

Syntax

```
svctask -- mkmdiskgrp -- [-name new_name_arg] -- [-mdisk mdisk_id_list | mdisk_name_list] -- -ext extent_size
```

Parameters

-name *new_name_arg*

(Optional) Specifies a name to assign to the new group.

-mdisk *mdisk_id_list* | *mdisk_name_list*

(Optional) Specifies the name of the managed disk IDs or names to add to the group. You can create an empty MDisk group by not specifying the **-mdisk** parameter.

-ext *extent_size*

(Required) Specifies the size of the extents for this group in MB. The *extent_size* parameter must be one of the following values: **16, 32, 64, 128, 256, 512, 1024,** or **2048** (MB).

Description

The **mkmdiskgrp** command creates a new managed disk group and assigns the group name if specified. The ID of the new group is returned if the command is successful. Managed disk groups are collections of managed disks. Each group is divided into chunks, called extents, which are used to create virtual disks.

Optionally, you can specify a list of managed disks that will be added to this group. These managed disks cannot belong to another group, and they must have a mode of unmanaged. Use the **svcinfolsmdiskcandidate** command to get a list of suitable candidates.

Each managed disk that is a member of this group is split into extents. The storage that is available on these disks is added to a pool of extents that is available in this group. When a virtual disk is created from this group, free extents from the pool are used, in accordance with the policy used when the virtual disk was first created.

All managed disks subsequently added to this group are split into extents of the same size as the size that is assigned to the group.

When choosing an extent size, take into account the amount of storage you want to virtualize in this group. The system maintains a mapping of extents between virtual disks and managed disks. The cluster can only manage a finite number of extents (4 194 304). One cluster can virtualize the following number of extents:

- 64 TB – if all managed disk groups have extent sizes of 16 MB.
- 2 PB – if all managed disk groups have extent sizes of 512 MB.
- 8 PB – if all managed disk groups have extent sizes of 2048 MB.

Note: When an image mode VDisk is created, the MDisk group increases in capacity by the size of the image mode VDisk (not the MDisk capacity), because the image mode VDisk might be smaller than the MDisk itself. If an extent is migrated from the image mode VDisk or MDisk to elsewhere in the group, the VDisk becomes a striped VDisk (no longer image mode). At this point the available capacity might increase, because the extra capacity available on the MDisk (for example, the capacity that was not part of the image mode VDisk) becomes available.

Possible failures

- CMMVC5786E The action failed because the cluster is not in a stable state.
- CMMVC5815E The managed disk (MDisk) group was not created because an entity that was specified in the command does not exist.
- CMMVC5807E The action failed because the managed disk (MDisk) cannot be changed to the specified mode.
- CMMVC5808E The action failed because the managed disk (MDisk) does not exist.
- CMMVC5858E The action failed because the virtual disk (VDisk) is in the wrong mode, the managed disk (MDisk) is in the wrong mode, or both are in the wrong mode.
- CMMVC6296E One or more managed disks (MDisks) have failed validation tests, first failing mdisk id [%1].
- CMMVC6297E One or more managed disks (MDisks) have timed out during validation tests, first failing mdisk id [%1].

An invocation example

```
svctask mkmdiskgrp -mdisk mdisk13 -ext 512
```

The resulting output

```
MDisk Group, id [1], successfully created
```

rmmdisk

The **rmmdisk** command deletes a managed disk (MDisk) from a managed disk group.

Syntax

```

▶▶▶ svctask — — rmmdisk — — -mdisk ———— [ mdisk_id_list ] —————▶
                                     [ mdisk_name_list ]
▶ [ -force ] [ mdisk_group_id ] —————▶
                                     [ mdisk_group_name ]

```

Parameters

-mdisk *mdisk_id_list* | *mdisk_name_list*

(Required) Specifies one or more managed disk IDs or names to delete from the group.

-force

(Optional) Migrates data on the specified disks to other disks in the group, if virtual disks exist that are made from extents on one or more of the specified MDisks and if there are enough free extents in the group. If you do not specify

the **-force** parameter, and virtual disks exist that are made from extents on one or more of the specified MDisks, the command fails.

mdisk_group_id | mdisk_group_name

Specifies the ID or name of the managed disk group to delete the disks from.

Description

This command attempts to remove the managed disk or disks from the group.

Deleting a managed disk from a group can only be done if the managed disk does not contain any extents in use by a virtual disk. If there are extents in use and you do not supply the force flag, the command fails.

Attention: If this disk being removed has already been powered down, removed, or is experiencing a power outage, the migration is pending and does not complete until the MDisk comes back online. The MDisk is not removed from the list of MDisks that are contained in the group.

If the disk has been deliberately removed, the only method of removing the MDisk is to remove the entire group itself.

Ensure that you do not destroy any controller LUNs until you have deleted them from the MDisk group that they belong to.

The **rmmdisk** command fails if there are insufficient free extents on other disks in the mdisk group for the duration of the command. To avoid this problem, do not issue new commands that use extents until **rmmdisk** processing is completed.

If you do specify the force flag, an attempt will be made to migrate the extents that are in use onto other free extents within the group. If there are not enough free extents in the group, the command will fail even if the force flag is specified.

To delete the disks from the group, you have the following options:

- You can delete the virtual disk that is using the extents specified on the managed disk.
- You can add more managed disks to the group, rerun the command and specify the **-force** parameter.

When data is being migrated from the managed disk, it might take some time for the command to complete. The command itself will return with a success code, notifying you that migration is in progress. An event is logged when the migration is complete and the disk is deleted from the group at this time. You can also check the progress of any active migrations by running the **svcinfolsmigrate** command.

Possible failures

- CMMVC5786E The action failed because the cluster is not in a stable state.
- CMMVC5823E The managed disk (MDisk) was not deleted from the MDisk group because the MDisk is part of another MDisk group.
- CMMVC5824E The managed disk (MDisk) was not deleted from the MDisk group because it does not belong to the MDisk group.
- CMMVC5825E The managed disk (MDisk) was not deleted from the MDisk group because a virtual disk (VDisk) is allocated from one or more of the specified MDisks. A forced deletion is required.

- CMMVC5807E The action failed because the managed disk (MDisk) cannot be changed to the specified mode.
- CMMVC5808E The action failed because the managed disk (MDisk) does not exist.
- CMMVC6006E The managed disk (MDisk) was not deleted because the resource was busy.
- CMMVC6015E A delete request is already in progress.

An invocation example

```
svctask rmdisk -mdisk mdisk12 -force Group3
```

The resulting output

No feedback

rmdiskgrp

The **rmdiskgrp** command deletes a managed disk group so that there is no possibility to recover it.

Syntax

```
▶▶ svctask — — rmdiskgrp — — [ -force ] [ mdisk_group_id | mdisk_group_name ] ▶▶
```

Parameters

-force

(Optional) Specifies that all virtual disks and virtual disk-to-host mappings be deleted.

Attention: Use this parameter with extreme caution. When you use this parameter, all managed disks in the group are removed and the group itself is deleted.

mdisk_group_id | *mdisk_group_name*

(Required) Specifies the ID or name of the managed disk group that is to be deleted.

Description

This command completely deletes the specified managed disk group. The **-force** parameter is required if there are virtual disks that have been created from this group or if there are managed disks in the group. Otherwise, the command fails.

Deleting a managed disk group is essentially the same as deleting a cluster or part of a cluster, because the managed disk group is the central point of control of virtualization. Because virtual disks are created using available extents in the group, mapping between virtual disk extents and managed disk extents is controlled based on the group.

Attention:

1. This command partially completes asynchronously. All virtual disks, host mappings, and Copy Services relationships are deleted before the command completes. The deletion of the managed disk group then completes asynchronously.
2. Before you issue the command, ensure that you want to delete all mapping information; data that is contained on virtual disks cannot be recovered after the managed disk group has been deleted.

In detail, if you specify the **-force** parameter and the virtual disks are still using extents in this group, the following actions are initiated or occur:

- The mappings between that disk and any host objects and the associated Copy Services relationships are deleted.
- If the virtual disk is a part of a FlashCopy mapping, the mapping is deleted.

Note: If the mapping is not in the **idle_or_copied** or **stopped** states, the mapping is force-stopped and then deleted. Force-stopping the mapping might cause other FlashCopy mappings in the cluster to also be stopped. See the description for the **-force** parameter in the **stopfcmap** command for additional information.

- Any virtual disk that is in the process of being migrated into or out of the managed disk group is deleted. This frees up any extents that the virtual disk was using in another managed disk group.
- Virtual disks are deleted without first flushing the cache. Therefore, the storage controller LUNs that underlie any image mode MDisk might not contain the same data as the image mode VDisk prior to the deletion.
- If there are managed disks in the group, all disks are deleted from the group. They are returned to the unmanaged state.
- The group is deleted.

Attention: If you use the **-force** parameter to delete all the managed disk groups in your cluster, you are returned to the processing state where you were after you added nodes to the cluster. All data that is contained on the virtual disks is lost and cannot be recovered.

Possible failures

- CMMVC5786E The action failed because the cluster is not in a stable state.
- CMMVC5816E The action failed because an entity that was specified in the command does not exist.
- CMMVC5818E The managed disk (MDisk) group was not deleted because there is at least one MDisk in the group.
- CMMVC6050E The action failed because the command was busy.
- CMMVC6252E The command failed authorization because the session SSH key is not valid or was deleted.
- CMMVC6253E The command failed authorization because the session SSH key does not have the requisite role.

An invocation example

```
svctask rmmdiskgrp -force Group3
```

The resulting output

No feedback

Chapter 13. Managed disk commands

The following commands enable you to work with managed disk options with the SAN Volume Controller.

If the cluster detects an MDisk, it automatically adds it to the list of known MDisks. If you subsequently delete the RAID that corresponds to the MDisk, the cluster only deletes the MDisk from the list if the MDisk is offline and it has a mode of unmanaged (it does not belong to an MDisk group).

chmdisk

Use the **chmdisk** command to modify the name of a managed disk (MDisk).

Syntax

```
svctask -- chmdisk -- -name -- new_name_arg -- | mdisk_id |
| mdisk_name |
```

Parameters

-name *new_name_arg*

(Required) Specifies the new name to be applied to the managed disk.

mdisk_id | *mdisk_name*

(Required) Specifies the ID or name of the managed disk to modify.

Description

This command modifies the name, or label, that is assigned to a given managed disk. You can subsequently use the new name to refer to the managed disk.

Possible failures

- CMMVC5786E The action failed because the cluster is not in a stable state.
- CMMVC5806E The action failed because an entity that was specified in the command does not exist.
- CMMVC5808E The action failed because the managed disk (MDisk) does not exist.

An invocation example

```
svctask chmdisk -name testmdisk mdisk0
```

The resulting output

No feedback

includemdisk

Use the **includemdisk** command to include a disk that has been excluded by the cluster.

Syntax

```
svctask -- includemdisk -- mdisk_id | mdisk_name
```

Parameters

mdisk_id | *mdisk_name*

(Required) Specifies the ID or name of the managed disk to add back into the cluster.

Description

The specified managed disk is included in the cluster.

You might exclude a disk from the cluster because of multiple I/O failures. These failures might be caused by noisy links. Once a fabric-related problem has been fixed, the excluded disk can be added back into the cluster.

Running this command against an MDisk might change its state, whether the state is reported as excluded.

Note: If an MDisk is in the excluded state, is offline, and does not belong to an MDisk group, issuing an include command for this MDisk results in the MDisk record being deleted from the cluster.

Possible failures

- CMMVC5786E The action failed because the cluster is not in a stable state.
- CMMVC5806E The action failed because an entity that was specified in the command does not exist.
- CMMVC5808E The action failed because the managed disk (MDisk) does not exist.

An invocation example

```
svctask includemdisk mdisk5
```

The resulting output

No feedback

setquorum

Use the **setquorum** command to change the managed disks (MDisks) that are assigned as quorum candidate disks.

Syntax

```
svctask -- setquorum -- -quorum 0 | 1 | 2 mdisk_id | mdisk_name
```

Parameters

-quorum 0 | 1 | 2

(Required) Specifies the quorum index.

mdisk_id | *mdisk_name*

(Required) Specifies the ID or name of the managed disk to assign as a quorum disk.

Description

This command sets the managed disk to the specified quorum index.

The cluster uses the quorum disk as a tie breaker when exactly half of the nodes that were previously a member of the cluster is present. The use of a quorum disk prevents the cluster from being split exactly in half. Both halves either continue to operate or both halves stop. There is only *one* quorum disk; however, the cluster uses three disks as quorum candidate disks. The cluster selects the actual quorum disk from the pool of quorum candidate disks. The quorum candidate disks also hold a copy of important cluster metadata. Contiguous space in the amount of 256 MB is reserved for this purpose on each quorum candidate disk.

When you issue this command, the MDisk that currently is assigned the quorum index number is set to a nonquorum disk. The cluster automatically assigns quorum indexes.

You can use the command to ensure that a particular set of MDisks continues to be accessible following a cluster split.

Possible failures

- CMMVC5786E The action failed because the cluster is not in a stable state.
- CMMVC5806E The action failed because an entity that was specified in the command does not exist.
- CMMVC5810E The quorum index number for the managed disk (MDisk) was not set because the MDisk is offline.
- CMMVC5811E The quorum index number for the managed disk (MDisk) was not set because the quorum disk does not exist.
- CMMVC5812E The quorum index number for the managed disk (MDisk) was not set because the MDisk is in the wrong mode.
- CMMVC5814E The quorum index number for the managed disk (MDisk) was not set because the unique identifier (UID) type is not valid.

An invocation example

```
svctask setquorum -quorum 2 mdisk7
```

The resulting output

No feedback

Chapter 14. FlashCopy commands

The following commands enable you to work with FlashCopy methods and functions with the SAN Volume Controller.

chfcconsistgrp

Use the **chfcconsistgrp** command to modify the name of an existing consistency group.

Syntax

```
svctask -- chfcconsistgrp -- -name -- new_name_arg --  
└─┬─ fc_consist_group_id ─┬───────────────────────────────────────────┐  
  │ fc_consist_group_name ─┘
```

Parameters

-name *new_name_arg*

(Required) Specifies the new name to assign to the consistency group.

fc_consist_group_id | *fc_consist_group_name*

(Required) Specifies the ID or existing name of the consistency group that you want to modify.

Description

This command changes the name of the specified consistency group.

Possible failures

- CMMVC5786E The action failed because the cluster is not in a stable state.
- CMMVC5891E The name of the FlashCopy consistency group was not modified because the name is not valid.
- CMMVC5893E The action failed because an entity that was specified in the command does not exist.
- CMMVC6252E The command failed authorization because the session SSH key is wrong or was deleted.
- CMMVC6253E The command failed authorization because the session SSH key does not have the requisite role.

An invocation example

```
svctask chfcconsistgrp -name testgrp1 fcconsistgrp1
```

The resulting output

```
No feedback
```

chfcmap

The **chfcmap** command modifies attributes of an existing mapping.

Syntax

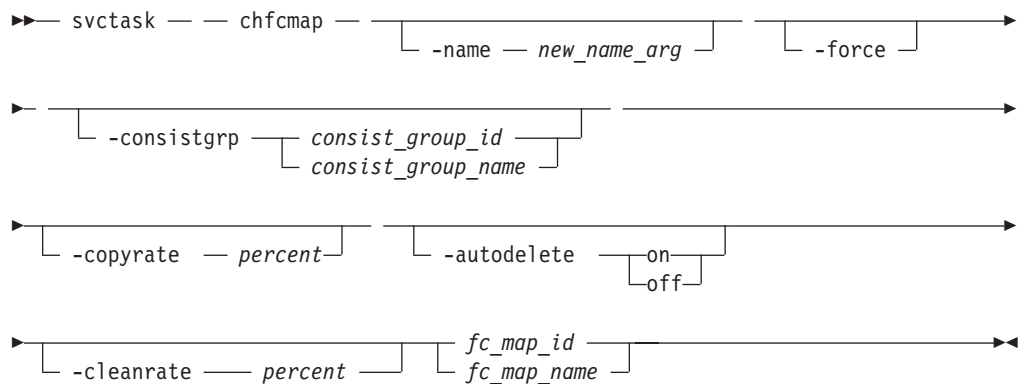

Parameters

-name *new_name_arg*

(Optional) Specifies the new name to assign to the mapping. The **-name** parameter cannot be used with any other optional parameters.

-force

(Optional) Specifies that the mapping be modified to a stand-alone mapping (equivalent to creating the mapping without a consistency group ID). You cannot specify the **-force** parameter with the **-consistgrp** parameter.

-consistgrp *consist_group_id* | *consist_group_name*

(Optional) Specifies the consistency group for which you want to modify the mapping. You cannot specify the **-consistgrp** parameter with the **-force** parameter.

Note: The consistency group cannot be modified if the specified consistency group is in the **preparing**, **prepared**, **copying**, **suspended**, or **stopping** state.

-copyrate *percent*

(Optional) Specifies the background copy rate. The *percent* value can be 0 - 100; the default is 50.

-autodelete **on** | **off**

(Optional) Specifies that the autodelete function be turned on or off for the specified mapping. When you specify the **-autodelete on** parameter, you are deleting a mapping after the background copy completes. If the background copy is already complete, the mapping is deleted immediately.

-cleanrate *percent*

(Optional) Sets the cleaning rate for the mapping. The *percent* value can be 0 - 100; the default is 50.

fc_map_id | *fc_map_name*

(Required) Specifies the ID or name of the mapping to modify.

Description

The **svctask chfcmap** command modifies attributes of an existing mapping.

If you have created several FlashCopy mappings for a group of VDisks that contain elements of data for the same application, you can assign these mappings

to a single FlashCopy consistency group. You can then issue a single prepare command and a single start command for the whole group, for example, so that all of the files for a particular database are copied at the same time.

Possible failures

- CMMVC5753E The object specified does not exist
- CMMVC5786E The action failed because the cluster is not in a stable state.
- CMMVC5888E The action failed because an entity that was specified in the command does not exist.
- CMMVC5913E The properties of the FlashCopy mapping were not modified because the mapping or consistency group is in the preparing state.
- CMMVC5914E The properties of the FlashCopy mapping were not modified because the mapping or consistency group is in the prepared state.
- CMMVC5915E The properties of the FlashCopy mapping were not modified because the mapping or consistency group is in the copying state.
- CMMVC5916E The properties of the FlashCopy mapping were not modified because the mapping or consistency group is in the suspended state.
- CMMVC5921E The properties of the FlashCopy mapping were not modified because the consistency group is not idle.
- CMMVC6215E The FlashCopy mapping was not created or modified because the consistency group already contains the maximum number of mappings.
- CMMVC6252E The command failed authorization because the session SSH key is wrong or was deleted.
- CMMVC6253E The command failed authorization because the session SSH key does not have the requisite role.
- CMMVC6240E The properties of the FlashCopy mapping were not modified because the mapping or consistency group is in the stopping state.
- CMMVC6311E The command failed because the source VDisk is the target of a FlashCopy mapping that is in the specified consistency group.
- CMMVC6312E The command failed because the target VDisk is the source of a FlashCopy mapping that is in the specified consistency group.
- CMMVC6313E The command failed because the specified background copy rate is not valid.
- CMMVC6314E The command failed because the specified cleaning rate is not valid.

An invocation example

```
svctask chfcmap -name testmap 1
```

The resulting output

```
No feedback
```

mkfcconsistgrp

The **mkfcconsistgrp** command creates a new FlashCopy consistency group and identification name.

Syntax

```
►► svctask — — mkfcconsistgrp — — [ -name — consist_group_name ] — ►►
```

Parameters

-name *consist_group_name*

(Optional) Specifies a name for the consistency group. If you do not specify a consistency group name, a name is automatically assigned to the consistency group. For example, if the next available consistency group ID is id=2, the consistency group name is fcstgrp2.

Description

This command creates a new consistency group and identification name. The ID of the new group is displayed when the command process completes.

If you have created several FlashCopy mappings for a group of VDisks that contain elements of data for the same application, you might find it convenient to assign these mappings to a single FlashCopy consistency group. You can then issue a single prepare command and a single start command for the whole group, for example, so that all of the files for a particular database are copied at the same time.

Possible failures

- CMMVC5786E The action failed because the cluster is not in a stable state.
- CMMVC5891E The FlashCopy consistency group was not created because the name is not valid.
- CMMVC5892E The FlashCopy consistency group was not created because it already exists.
- CMMVC6252E The command failed authorization because the session SSH key is wrong or was deleted.
- CMMVC6253E The command failed authorization because the session SSH key does not have the requisite role.

An invocation example

```
svctask mkfcconsistgrp
```

The resulting output

```
FlashCopy Consistency Group, id [1], successfully created
```

mkfcmap

The **mkfcmap** command creates a new FlashCopy mapping, which maps a source virtual disk to a target virtual disk for subsequent copying.

Syntax

```
svctask mkfcmap -source src_vdisk_id src_vdisk_name -target target_vdisk_id target_vdisk_name [-name new_name_arg] [-consistgrp consist_group_id consist_group_name] [-copyrate percent]
```

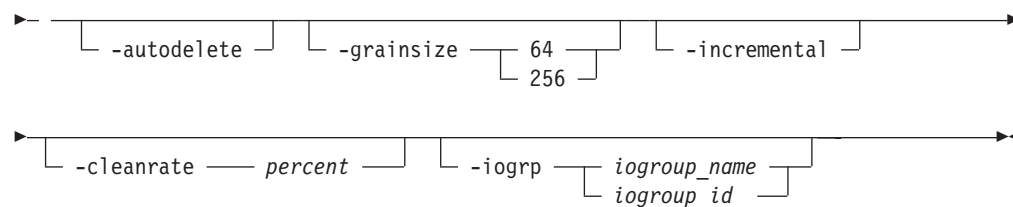

Parameters

- source** *src_vdisk_id* | *src_vdisk_name*
(Required) Specifies the ID or name of the source virtual disk.
- target** *target_vdisk_id* | *target_vdisk_name*
(Required) Specifies the ID or name of the target virtual disk.
- name** *new_name_arg*
(Optional) Specifies the name to assign to the new mapping.
- consistgrp** *consist_group_id* | *consist_group_name*
(Optional) Specifies the consistency group to add the new mapping to. If you do not specify a consistency group, the mapping is treated as a stand-alone mapping.
- copyrate** *percent*
(Optional) Specifies the background copy rate. The value is expressed as a percentage; the default is **50**. A value of **0** indicates no background copy process.
- autodelete**
(Optional) Specifies that a mapping be deleted when the background copy completes. The default, which applies if this parameter is not entered, is that **autodelete** is set to off.
- grainsize** **64** | **256**
(Optional) Specifies the grain size for the mapping. The default value is **256**. Once set, this value cannot be changed.
- incremental**
(Optional) Marks the FlashCopy mapping as an incremental copy. The default is nonincremental. Once set, this value cannot be changed.
- cleanrate** *percent*
(Optional) Sets the cleaning rate for the mapping. The value is expressed as a percentage; the default is **50**. The *percent* value can be **0 - 100**.
- iogrp** *iogroup_name* | *iogroup_id*
(Optional) Specifies the IO group for the FlashCopy bitmap. Once set, this value cannot be changed. The default IO group is either the source VDisk, if a single target map, or the IO group of the other FlashCopy mapping to which either the source or target VDIsks belong.

Description

This command creates a new FlashCopy mapping. This mapping persists until it is manually deleted, or until it is automatically deleted when the background copy completes and the **autodelete** parameter set to **on**. The source and target VDIsks must be specified on the **mkfcmmap** command. The **mkfcmmap** command fails if the source and target VDIsks are not identical in size. Issue the **svcinfor lsvdisk -bytes** command to find the exact size of the source VDisk for which you want to create a

target disk of the same size. The target VDisk that you specify cannot be a target VDisk in an existing FlashCopy mapping. A mapping cannot be created if the resulting set of connected mappings exceeds 16 connected mappings.

The mapping can optionally be given a name and assigned to a consistency group, which is a group of mappings that can be started with a single command. These are groups of mappings that can be processed at the same time. This enables multiple virtual disks to be copied at the same time, which creates a consistent copy of multiple disks. This consistent copy of multiple disks is required by some database products in which the database and log files reside on different disks.

The background copyrate specifies the priority that is given to completing the copy. If 0 is specified, background copy is disabled. The **cleanrate** parameter specifies the priority that is given to cleaning the target VDisk. The cleaning process is only active if the mapping is in the **copying** state and the background copy has completed; the mapping is in the **copying** state and the background copy is disabled; or the mapping is in the **stopping** state. You can disable cleaning when the mapping is in the **copying** state by setting the **cleanrate** parameter to 0. If the **cleanrate** is set to 0, the cleaning process runs at the default rate of 50 when the mapping is in the **stopping** state to ensure that the stop operation completes.

Possible failures

Note: If you receive an error indicating that the licensed virtualization capacity has been exceeded, then the command has completed successfully; however, the return code indicates a license violation.

- CMMVC5786E The action failed because the cluster is not in a stable state.
- CMMVC5881E The FlashCopy mapping was not created because an entity that was specified in the command does not exist.
- CMMVC5882E The FlashCopy mapping was not created because a mapping for the source or target virtual disk (VDisk) already exists.
- CMMVC5883E The FlashCopy mapping was not created because the recovery I/O group is associated with the source or target virtual disk (VDisk).
- CMMVC5884E The FlashCopy mapping was not created because the source or target virtual disk (VDisk) cannot be a member of a Metro Mirror mapping.
- CMMVC5885E The FlashCopy mapping was not created because this source or target virtual disk (VDisk) cannot be a member of a FlashCopy mapping.
- CMMVC5886E The FlashCopy mapping was not created because the source or target virtual disk (VDisk) is associated with the recovery I/O group.
- CMMVC5922E The FlashCopy mapping was not created because the target virtual disk (VDisk) is too small.
- CMMVC5923E The FlashCopy mapping was not created because the I/O group is offline.
- CMMVC5924E The FlashCopy mapping was not created because the source and target virtual disks (VDisks) are different sizes.
- CMMVC5917E The FlashCopy mapping was not created because there is no memory to create the bitmap.
- CMMVC5920E The FlashCopy mapping was not created because the consistency group is not idle.
- CMMVC6215E The FlashCopy mapping was not created or modified because the consistency group already contains the maximum number of mappings.

- CMMVC6244E The FlashCopy mapping was not created because the source virtual disk (VDisk) cannot be the target for a FlashCopy mapping.
- CMMVC6245E The FlashCopy mapping was not created because the source virtual disk (VDisk) is already in the maximum number of FlashCopy mappings.
- CMMVC6247E The FlashCopy mapping was not created because the target virtual disk (VDisk) is already a target VDisk in a FlashCopy mapping.
- CMMVC6252E The command failed authorization because the session SSH key is not valid or was deleted.
- CMMVC6253E The command failed authorization because the session SSH key does not have the requisite role.
- CMMVC6299E The create failed because the source and target VDIsks are members of FlashCopy mappings that have different grain sizes.
- CMMVC6300E The create failed because the source and target VDIsks are members of FlashCopy mappings that belong to different I/O groups.
- CMMVC6302E The create failed because the resulting tree of FlashCopy mappings would exceed the upper limit.
- CMMVC6303E The create failed because the source and target VDIsks are the same.
- CMMVC6306E The create failed because the source VDisk is the member of a FlashCopy mapping whose grain size is different to that specified.
- CMMVC6307E The create failed because the target VDisk is the member of a FlashCopy mapping whose grain size is different to that specified.
- CMMVC6308E The create failed because the source VDisk is the member of a FlashCopy mapping whose IO group is different to that specified.
- CMMVC6309E The create failed because the target VDisk is the member of a FlashCopy mapping whose IO group is different to that specified.
- CMMVC6311E The command failed because the source VDisk is the target of a FlashCopy mapping that is in the specified consistency group.
- CMMVC6312E The command failed because the target VDisk is the source of a FlashCopy mapping that is in the specified consistency group.
- CMMVC6313E The command failed because the specified background copy rate is not valid.
- CMMVC6314E The command failed because the specified cleaning rate is not valid.
- CMMVC6315E The command failed because the specified grain size is not valid.

An invocation example

```
svctask mkfcmap -source 0 -target 2 -name mapone
```

The resulting output

```
FlashCopy Mapping, id [1], successfully created
```

prestartfcconsistgrp

The **prestartfcconsistgrp** command prepares a consistency group (a group of FlashCopy mappings) so that the consistency group can be started. This command flushes the cache of any data that is destined for the source virtual disk and forces the cache into the write-through mode until the consistency group is started.

Syntax

```
svctask — — prestartfcconsistgrp — —  $\left\{ \begin{array}{l} fc\_consist\_group\_id \\ fc\_consist\_group\_name \end{array} \right.$  — —
```

Parameters

fc_consist_group_id | *fc_consist_group_name*

(Required) Specifies the name or ID of the consistency group that you want to prepare.

Description

This command prepares a consistency group (a group of FlashCopy mappings) to subsequently start. The preparation step ensures that any data that resides in the cache for the source virtual disk is first flushed to disk. This step ensures that the FlashCopy target VDisk is identical to what has been acknowledged to the host operating system as having been written successfully to the source VDisk.

You must issue the **svctask prestartfcconsistgrp** command to prepare the FlashCopy consistency group before the copy process can be started. When you have assigned several mappings to a FlashCopy consistency group, you must issue a single prepare command for the whole group to prepare all of the mappings at once.

The consistency group must be in the **idle_or_copied** or **stopped** state before it can be prepared. When you enter the **prestartfcconsistgrp** command, the group enters the preparing state. After the preparation is complete, the consistency group status changes to **prepared**. At this point, you can start the group.

If FlashCopy mappings are assigned to a consistency group, the preparing and the subsequent starting of the mappings in the group must be performed on the consistency group rather than on an individual FlashCopy mapping that is assigned to the group. Only stand-alone mappings, which are mappings that are not assigned to a consistency group, can be prepared and started on their own. A FlashCopy mapping must be prepared before it can be started.

Possible failures

- CMMVC5786E The action failed because the cluster is not in a stable state.
- CMMVC5888E The action failed because an entity that was specified in the command does not exist.
- CMMVC5890E The FlashCopy mapping was not prepared because preparing consistency group 0 is not a valid operation.
- CMMVC5901E The FlashCopy mapping was not prepared because the mapping or consistency group is already in the preparing state.
- CMMVC5902E The FlashCopy mapping was not prepared because the mapping or consistency group is already in the prepared state.
- CMMVC5903E The FlashCopy mapping was not prepared because the mapping or consistency group is already in the copying state.
- CMMVC5904E The FlashCopy mapping was not prepared because the mapping or consistency group is already in the suspended state.
- CMMVC5918E The FlashCopy mapping was not prepared because the I/O group is offline.

- CMMVC6031E The operation was not performed because the FlashCopy consistency group is empty.
- CMMVC6239E The FlashCopy mapping was not prepared because the mapping or consistency group is in the stopping state.
- CMMVC6252E The command failed authorization because the session SSH key is invalid or was deleted.
- CMMVC6253E The command failed authorization because the session ssh key does not have the requisite role.
- CMMVC6298E The command failed because a target VDisk has dependent FlashCopy mappings.

An invocation example

```
svctask prestartfcconsistgrp 1
```

The resulting output

No feedback

prestartfcmap

The **prestartfcmap** command prepares a FlashCopy mapping so that it can be started. This command flushes the cache of any data that is destined for the source virtual disk and forces the cache into the write-through mode until the mapping is started.

Syntax

```
svctask — — prestartfcmap — — [ fc_map_id ] [ fc_map_name ]
```

Parameters

fc_map_id | *fc_map_name*

(Required) Specifies the name or ID of the mapping to prepare.

Description

This command prepares a single mapping for subsequent starting. The preparation step ensures that any data that resides in the cache for the source virtual disk is first transferred to disk. This step ensures that the copy that is made is consistent with what the operating system expects on the disk.

Note: To prepare a FlashCopy mapping that is part of a consistency group, you must use the **prestartfcconsistgrp** command.

The mapping must be in the **idle_or_copied** or **stopped** state before it can be prepared. When the **prestartfcmap** command is processed, the mapping enters the **preparing** state. After the preparation is complete, it changes to the prepared state. At this point, the mapping is ready to start.

Attention: This command can take a considerable amount of time to complete.

Possible failures

- CMMVC5786E The action failed because the cluster is not in a stable state.

- CMMVC5888E The action failed because an entity that was specified in the command does not exist.
- CMMVC5890E The FlashCopy mapping was not prepared because preparing consistency group 0 is not a valid operation.
- CMMVC5901E The FlashCopy mapping was not prepared because the mapping or consistency group is already in the preparing state.
- CMMVC5902E The FlashCopy mapping was not prepared because the mapping or consistency group is already in the prepared state.
- CMMVC5903E The FlashCopy mapping was not prepared because the mapping or consistency group is already in the copying state.
- CMMVC5904E The FlashCopy mapping was not prepared because the mapping or consistency group is already in the suspended state.
- CMMVC5918E The FlashCopy mapping was not prepared because the I/O group is offline.
- CMMVC6239E The FlashCopy mapping was not prepared because the mapping or consistency group is in the stopping state.
- CMMVC6252E The command failed authorization because the session SSH key is wrong or was deleted.
- CMMVC6253E The command failed authorization because the session SSH key does not have the requisite role.

An invocation example

```
svctask prestartfcmap 1
```

The resulting output

```
No feedback
```

rmfcconsistgrp

The **rmfcconsistgrp** command deletes a FlashCopy consistency group.

Syntax

```
▶▶ svctask — — rmfcconsistgrp — [ -force ] —————▶
▶ [ fc_consist_group_id | fc_consist_group_name ] —————▶▶
```

Parameters

-force

(Optional) Specifies that all of the mappings that are associated with a consistency group that you want to delete are removed from the group and changed to stand-alone mappings. This parameter is only required if the consistency group that you want to delete contains mappings.

fc_consist_group_id | *fc_consist_group_name*

(Required) Specifies the ID or name of the consistency group that you want to delete.

Description

This command deletes the specified FlashCopy consistency group. If there are mappings that are members of the consistency group, the command fails unless you specify the **-force** parameter. When you specify the **-force** parameter, all of the mappings that are associated with the consistency group are removed from the group and changed to stand-alone mappings.

To delete a single mapping in the consistency group, you must use the **svctask rmfcmap** command.

Possible failures

- CMMVC5786E The action failed because the cluster is not in a stable state.
- CMMVC5893E The action failed because an entity that was specified in the command does not exist.
- CMMVC5894E The FlashCopy consistency group was not deleted because you are trying to delete consistency group 0 or the name of the consistency group is not valid.
- CMMVC5895E The FlashCopy consistency group was not deleted because it contains mappings. To delete this consistency group, a forced deletion is required.
- CMMVC6252E The command failed authorization because the session SSH key is wrong or was deleted.
- CMMVC6253E The command failed authorization because the session SSH key does not have the requisite role.

An invocation example

```
svctask rmfcconsistgrp fcconsistgrp1
```

The resulting output

No feedback

rmfcmap

The **rmfcmap** command deletes an existing mapping.

Syntax

```
svctask -- rmfcmap -- [-force] [fc_map_id | fc_map_name]
```

Parameters

-force

(Optional) Specifies that the target VDisk is brought online. This parameter is required if the FlashCopy mapping is in the stopped state.

fc_map_id | *fc_map_name*

(Required) Specifies the ID or name of the FlashCopy mapping to delete.

Description

The **rmfcmap** command deletes the specified mapping if the mapping is in the **idle_or_copied** or **stopped** state. If it is in the stopped state, the **-force** parameter is required. If the mapping is in any other state, you must stop the mapping before you can delete it.

Deleting a mapping only deletes the logical relationship between the two virtual disks; it does not affect the virtual disks themselves. However, if you force the deletion, the target virtual disk (which might contain inconsistent data) is brought back online.

Possible failures

- CMMVC5786E The action failed because the cluster is not in a stable state.
- CMMVC5889E The FlashCopy mapping was not deleted because an entity that was specified in the command does not exist.
- CMMVC5896E The FlashCopy mapping was not deleted because the mapping or consistency group is in the preparing state. The mapping or consistency group must be stopped first.
- CMMVC5897E The FlashCopy mapping was not deleted because the mapping or consistency group is in the prepared state. The mapping or consistency group must be stopped first.
- CMMVC5898E The FlashCopy mapping was not deleted because the mapping or consistency group is in the copying state. The mapping or consistency group must be stopped first.
- CMMVC5899E The FlashCopy mapping was not deleted because the mapping or consistency group is in the stopped state. To delete the mapping, a forced deletion is required.
- CMMVC5900E The FlashCopy mapping was not deleted because the mapping or consistency group is in the suspended state. The mapping or consistency group must be stopped first.
- CMMVC6241E The FlashCopy mapping was not deleted because the mapping or consistency group is in the stopping state. The mapping or consistency group must complete the stop operation first.
- CMMVC6252E The command failed authorization because the session SSH key is wrong or was deleted.
- CMMVC6253E The command failed authorization because the session SSH key does not have the requisite role.

An invocation example

```
svctask rmfcmap testmap
```

The resulting output

```
No feedback
```

startfcconsistgrp

The **startfcconsistgrp** command starts a FlashCopy consistency group of mappings. This command makes a point-in-time copy of the source virtual disks at the moment that the command is started.

Syntax

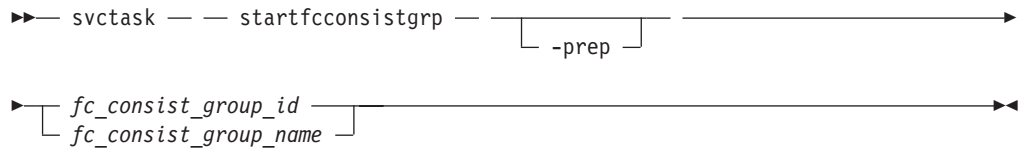

Parameters

-prep

(Optional) Specifies that the designated FlashCopy consistency group be prepared prior to starting the FlashCopy consistency group. A FlashCopy consistency group must be prepared before it can be started. When you use this parameter, the system automatically issues the **prestartfcconsistgrp** command for the group that you specify.

fc_consist_group_id | *fc_consist_group_name*

(Required) Specifies the ID or name of the consistency group mapping to start.

Description

This command starts a consistency group mapping, which results in a point-in-time copy of the source virtual disks.

Note: The **startfcconsistgrp** command can take some time to process particularly if you have specified the **-prep** parameter. If you use the **-prep** parameter, you give additional processing control to the system because the system must prepare the mapping before the mapping is started. If the prepare process takes too long, the system completes the prepare but does not start the consistency group. In this case, error message CMMVC6209E displays. To control the processing times of the **prestartconsistgrp** and **startfcconsistgrp** commands independently of each other, do not use the **-prep** parameter. Instead, first issue the **prestartfcconsistgrp** command, and then to start the copy, issue the **startfcconsistgrp** command.

Possible failures

- CMMVC5786E The action failed because the cluster is not in a stable state.
- CMMVC5888E The action failed because an entity that was specified in the command does not exist.
- CMMVC5890E The FlashCopy mapping or consistency group was not started because starting consistency group 0 is not a valid operation.
- CMMVC5905E The FlashCopy mapping or consistency group was not started because the mapping or consistency group is in the idle state. The mapping or consistency group must be prepared first.
- CMMVC5906E The FlashCopy mapping or consistency group was not started because the mapping or consistency group is in the preparing state.
- CMMVC5907E The FlashCopy mapping or consistency group was not started because the mapping or consistency group is already in the copying state.
- CMMVC5908E The FlashCopy mapping or consistency group was not started because the mapping or consistency group is in the stopped state. The mapping or consistency group must be prepared first.
- CMMVC5909E The FlashCopy mapping or consistency group was not started because the mapping or consistency group is in the suspended state.

- CMMVC5919E The FlashCopy mapping or consistency group was not started because the I/O group is offline.
- CMMVC6209E The FlashCopy mapping or consistency group could not be started in a reasonable time. The mapping or group is instead being prepared.
- CMMVC6242E The FlashCopy mapping or consistency group was not started because the mapping or consistency group is in the stopping state. The mapping or consistency group must first complete the stop operation and then be prepared.
- CMMVC6252E The command failed authorization because the session SSH key is not valid or was deleted.
- CMMVC6253E The command failed authorization because the session SSH key does not have the requisite role.
- CMMVC6298E The command failed because a target VDisk has dependent FlashCopy mappings.
- CMMVC6316E The mapping or consistency group could not be started because a source VDisk is the target of another FlashCopy mapping that is keeping the VDisk inaccessible.

An invocation example

```
svctask startfcconsistgrp -prep 2
```

The resulting output

No feedback

startfcmap

The **startfcmap** command starts a FlashCopy mapping. This command makes a point-in-time copy of the source virtual disk at the moment that the command is started.

Syntax

```
svctask -- startfcmap -- [-prep] [fc_map_id | fc_map_name]
```

Parameters

-prep

(Optional) Specifies that the designated mapping be prepared prior to starting the mapping. A mapping must be prepared before it can be started. When you use this parameter, the system automatically issues the **prestartfcmap** command for the group that you specify.

fc_map_id | *fc_map_name*

(Required) Specifies the ID or name of the mapping to start.

Description

This command starts a single mapping, which results in a point-in-time copy of the source virtual disk.

Note: The **startfcmap** command can take some time to start, particularly if you use the **-prep** parameter. If you use the **-prep** parameter, you give additional starting control to the system. The system must prepare the mapping before

the mapping is started. To keep control when the mapping starts, you must issue the **prestartfcmap** command before you issue the **startfcmap** command.

Possible failures

- CMMVC5786E The action failed because the cluster is not in a stable state.
- CMMVC5888E The action failed because an entity that was specified in the command does not exist.
- CMMVC5905E The FlashCopy mapping or consistency group was not started because the mapping or consistency group is in the idle state. The mapping or consistency group must be prepared first.
- CMMVC5906E The FlashCopy mapping or consistency group was not started because the mapping or consistency group is in the preparing state.
- CMMVC5907E The FlashCopy mapping or consistency group was not started because the mapping or consistency group is already in the copying state.
- CMMVC5908E The FlashCopy mapping or consistency group was not started because the mapping or consistency group is in the stopped state. The mapping or consistency group must be prepared first.
- CMMVC5909E The FlashCopy mapping or consistency group was not started because the mapping or consistency group is in the suspended state.
- CMMVC5919E The FlashCopy mapping or consistency group was not started because the I/O group is offline.
- CMMVC6209E The FlashCopy mapping or consistency group could not be started in a reasonable time. The mapping or group is instead being prepared.
- CMMVC6242E The FlashCopy mapping or consistency group was not started because the mapping or consistency group is in the stopping state. The mapping or consistency group must first complete the stop operation and then be prepared.
- CMMVC6252E The command failed authorization because the session SSH key is wrong or was deleted.
- CMMVC6253E The command failed authorization because the session SSH key does not have the requisite role.
- CMMVC6298E The command failed because a target VDisk has dependent FlashCopy mappings.
- CMMVC6316E The mapping or consistency group could not be started because a source VDisk is the target of another FlashCopy mapping that is keeping the VDisk inaccessible.

An invocation example

```
svctask startfcmap -prep 2
```

The resulting output

```
No feedback
```

stopfcconsistgrp

The **stopfcconsistgrp** command stops all processing that is associated with a FlashCopy consistency group that is in one of the following processing states: **prepared**, **copying**, **stopping**, or **suspended**.

Syntax

```
svctask — stopfcconsistgrp — [-force]
fc_consist_group_id | fc_consist_group_name
```

Parameters

-force

(Optional) Specifies that all processing that is associated with the mappings of the designated consistency group be stopped immediately.

Note: When you use this parameter, all FlashCopy mappings that depend on the mappings in this group (as listed by the **lsfcmapdependentmaps** command) are also stopped.

fc_consist_group_id | *fc_consist_group_name*

(Required) Specifies the name or ID of the consistency group that you want to stop.

Description

This command stops a group of mappings (in a consistency group). If the copy process is stopped, the target disks become unusable unless they already contain complete images of the source (that is, unless the map had a "progress" of 100 as shown by the **-lsfcmap** command). The target VDisk is reported as offline if it does not contain a complete image. Before you can access this VDisk, the group of mappings must be prepared and restarted.

If the consistency group is in the **idle_or_copied** state, then the **stopfcconsistgrp** command has no effect and the consistency group stays in the **idle_or_copied** state.

Note: Prior to SVC 4.2.0, the **stopfcconsistgrp** command always caused the consistency group to go to the **stopped** state, taking the target VDIsks offline.

Possible failures

- CMMVC5786E The action failed because the cluster is not in a stable state.
- CMMVC5888E The action failed because an entity that was specified in the command does not exist.
- CMMVC5890E The FlashCopy mapping or consistency group was not stopped because starting consistency group 0 is not a valid operation.
- CMMVC5911E The FlashCopy mapping or consistency group was not stopped because the mapping or consistency group is in the preparing state.
- CMMVC5912E The FlashCopy mapping or consistency group was not stopped because the mapping or consistency group is already in the stopped state.
- CMMVC6243E The FlashCopy mapping or consistency group was not stopped because the mapping or consistency group is already in the stopping state.
- CMMVC6252E The command failed authorization because the session SSH key is invalid or was deleted.

- CMMVC6253E The command failed authorization because the session SSH key does not have the requisite role.

An invocation example

```
svctask stopfcconsistgrp testmapone
```

The resulting output

No feedback

stopfcmap

The **stopfcmap** command stops all processing that is associated with a FlashCopy mapping that is in one of the following processing states: **prepared**, **copying**, **stopping**, or **suspended**.

Syntax

```
svctask -- stopfcmap -- [-force] [fc_map_id | fc_map_name]
```

Parameters

-force

(Optional) Specifies that all processing that is associated with the designated mapping be stopped immediately.

Note: When you use this parameter, all FlashCopy mappings that depend on this mapping (as listed by the **-lsfcmapdependentmaps** command) are also stopped.

fc_map_id | *fc_map_name*

(Required) Specifies the name or ID of the mapping to stop.

Description

This command stops a single mapping. If the copy process is stopped, the target disk becomes unusable unless it already contained a complete image of the source (that is, unless the map had a "progress" of 100 as shown by the **-lsfcmap** command). Before you can use the target disk, the mapping must once again be prepared and then reprocessed (unless the target disk already contained a complete image).

Only stand-alone mappings can be stopped using the **stopfcmap** command. Mappings that belong to a consistency group must be stopped using the **stopfcconsistgrp** command.

If the mapping is in the **idle_or_copied** state, the **stopfcmap** command has no effect and the mapping stays in the **idle_or_copied** state.

Note: Prior to version 4.2.0, the **stopfcmap** command would have always caused the mapping to go to the **stopped** state and take the target VDisk offline. This change can break scripts that depend on the previous behavior.

Possible failures

- CMMVC5786E The action failed because the cluster is not in a stable state.

- CMMVC5888E The action failed because an entity that was specified in the command does not exist.
- CMMVC5890E The FlashCopy mapping or consistency group was not stopped because starting consistency group 0 is not a valid operation.
- CMMVC5911E The FlashCopy mapping or consistency group was not stopped because the mapping or consistency group is in the preparing state.
- CMMVC5912E The FlashCopy mapping or consistency group was not stopped because the mapping or consistency group is already in the stopped state.
- CMMVC6030E The operation was not performed because the FlashCopy mapping is part of a consistency group. The action must be performed at the consistency group level.
- CMMVC6243E The FlashCopy mapping or consistency group was not stopped because the mapping or consistency group is already in the stopping state.
- CMMVC6252E The command failed authorization because the session SSH key is not valid or was deleted.
- CMMVC6253E The command failed authorization because the session SSH key does not have the requisite role.

An invocation example

```
svctask stopfcmap testmapone
```

The resulting output

```
No feedback
```

Chapter 15. Metro Mirror and Global Mirror commands

The following Copy Service commands enable you to work with the Metro Mirror and Global Mirror services that the SAN Volume Controller provides.

chpartnership

The **chpartnership** command modifies the bandwidth of the partnership between the local cluster and the remote cluster that is specified in the command. This affects the bandwidth that is available for background copy in a cluster partnership by either Metro Mirror or Global Mirror operations.

Syntax

▶▶▶ svctask — — chpartnership — — -bandwidth — *bandwidth_in_mbps* — —▶▶▶
▶└── *remote_cluster_id* ──▶▶▶
 └─ *remote_cluster_name* ──▶▶▶

Parameters

-bandwidth *bandwidth_in_mbps*

(Required) Specifies the new bandwidth in megabytes per second (MBps). This parameter might be set to a value that is greater than the intercluster links can sustain. If so, the actual copy rate defaults to what is available on the link. The default bandwidth is 50.

remote_cluster_id | *remote_cluster_name*

(Required) Specifies the cluster ID or name of the remote cluster. The intracluster bandwidth cannot be modified, so if you enter the local cluster name or ID, an error occurs.

Description

This command modifies the bandwidth of the partnership between the local cluster and the remote cluster that is specified in the command. This affects the bandwidth that is available for a background copy in Metro Mirror or Global Mirror relationships, in the direction from the local to the remote cluster. To modify the background copy bandwidth in the other direction (remote cluster -> local cluster), it is necessary to issue the corresponding **chpartnership** command to the remote cluster.

Possible failures

- CMMVC5786E The action failed because the cluster is not in a stable state.
- CMMVC5927E The action failed because the cluster ID is not valid.
- CMMVC6252E The command failed authorization because the session SSH key is wrong or was deleted.
- CMMVC6253E The command failed authorization because the session SSH key does not have the requisite role.

An invocation example

```
svctask chpartnership -bandwidth 20 cluster1
```

The resulting output

No feedback

chrconsistgrp

The **chrconsistgrp** command modifies the name of an existing Metro Mirror or Global Mirror consistency group.

Syntax

```
svctask -- chrconsistgrp -- -name -- new_name_arg --  
└─ rc_consist_group_name ─┬─  
   rc_consist_group_id ─┴─
```

Parameters

-name *new_name_arg*

(Required) Specifies the new name to assign to the consistency group.

rc_consist_group_name | *rc_consist_group_id*

(Required) Specifies the ID or existing name of the consistency group that you want to modify.

Description

This command changes the name of the specified consistency group.

Possible failures

- CMMVC5786E The action failed because the cluster is not in a stable state.
- CMMVC5937E The action failed because an entity that was specified in the command does not exist.
- CMMVC6252E The command failed authorization because the session SSH key is wrong or was deleted.
- CMMVC6253E The command failed authorization because the session SSH key does not have the requisite role.

An invocation example

Change the name of the consistency group called `rc_testgrp` to `rctestone`.

```
svctask chrconsistgrp -name rctestone rc_testgrp
```

The resulting output

No feedback

chrrelationship

The **chrrelationship** command enables you to modify certain attributes of an existing relationship, such as to add a relationship to a consistency group, to remove a relationship from a consistency group, and to change the name of the relationship. You can only change one attribute at a time per command submittal.

Syntax

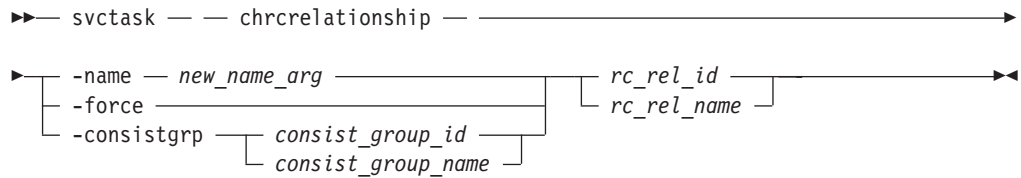

Parameters

-name *new_name_arg*

(Optional) Specifies a new label to assign to the relationship.

This parameter is required if you do not specify the **-consistgrp** or **-force** parameter.

-consistgrp *consist_group_id* | *consist_group_name*

(Optional) Specifies a new consistency group to assign the relationship to. Only relationships of the same copy type (Metro Mirror or Global Mirror) can be assigned to the same consistency group. You cannot use this parameter with the **-name**, or **-force** parameters.

This parameter is required if you do not specify the **-name** or **-force** parameter.

-force

(Optional) Specifies that you want the system to remove the relationship from a consistency group making the relationship a stand-alone relationship. You cannot use this parameter with the **-name** or **-consistgrp** parameters.

This parameter is required if you do not specify the **-name** or **-consistgrp** parameter.

rc_rel_name | *rc_rel_id*

(Required) Specifies the ID or name of the relationship.

Description

This command modifies the specified attributes of the supplied relationship, one attribute at a time; you cannot use more than one of the three optional parameters in the same command. In addition to changing the name of a consistency group, this command can be used for the following purposes.

- You can add a stand-alone relationship to a consistency group by specifying the **-consistgrp** parameter and the name or ID of the consistency group. The relationship and consistency group must be connected when the command is issued and must share the following components:
 - Master cluster
 - Auxiliary cluster
 - State (unless the group is empty)
 - Primary (unless the group is empty)
 - Type (unless the group is empty)

When the first relationship is added to an empty group, the group takes on the same state, primary (copy direction), and type (Metro or Global Mirror) as the relationship. Subsequent relationships must have the same state, copy direction, and type as the group in order to be added to it. A relationship can only belong to one consistency group.

- You can remove a relationship from a consistency group by specifying the **-force** parameter and the name or ID of the relationship. Although you do not have to specify or confirm the name of the consistency group, verify which group the relationship belongs to before you issue this command.

This form of the modify relationship command succeeds in the connected or disconnected states. If the clusters are disconnected the relationship is only removed from the consistency group on the local cluster, at the time the command is issued. When the clusters are reconnected the relationship is automatically removed from the consistency group on the other cluster. Alternatively, you can issue an explicit modify (**chrrelationship**) command to remove the relationship from the group on the other cluster while it is still disconnected.

Note: If you remove all relationships from the group, the relationship type is reset to **empty_group**. When you add a relationship to the empty group, the group again takes on the same type as the relationship.

- To move a relationship between two consistency groups, you must issue the **chrrelationship** command twice. Use the **-force** parameter to remove the relationship from its current group, and then use the **-consistgrp** parameter with the name of the new consistency group.

Possible failures

- CMMVC5786E The action failed because the cluster is not in a stable state.
- CMMVC5935E The action failed because an entity that was specified in the command does not exist.
- CMMVC6234E The copy type differs from other copies already in the consistency group.
- CMMVC6252E The command failed authorization because the session SSH key is wrong or was deleted.
- CMMVC6253E The command failed authorization because the session SSH key does not have the requisite role.

An invocation example

Change the name of the relationship rccopy1 to testrel
`svctask chrrelationship -name testrel rccopy1`

Add relationship rccopy2 to group called newgroup.
`svctask chrrelationship -consistgrp newgroup rccopy2`

Remove relationship rccopy3 from whichever consistency group it is a member of.
`svctask chrrelationship -force rccopy3`

The resulting output

No feedback

There is no feedback in any of these cases.

mkpartnership

The **mkpartnership** command establishes a one-way Metro Mirror or Global Mirror relationship between the local cluster and a remote cluster.

Syntax

To establish a fully functional Metro Mirror or Global Mirror partnership, you must issue this command to both clusters. This step is a prerequisite to creating Metro Mirror or Global Mirror relationships between VDisks on the clusters.

```
svctask -- mkpartnership -- [-bandwidth -- bandwidth_in_mbps]
remote_cluster_id | remote_cluster_name
```

Parameters

-bandwidth *bandwidth_in_mbps*

(Optional) Specifies the bandwidth that is used by the background copy process between the clusters. It adjusts the bandwidth that is used by Metro Mirror or Global Mirror for the initial background copy process. The bandwidth defaults to 50 MBps (megabytes per second) if you do not specify it. Set the bandwidth to a value that is less than or equal to the bandwidth that can be sustained by the intercluster link. If the **-bandwidth** parameter is set to a higher value than the link can sustain, the background copy process uses the actual available bandwidth. See the *IBM System Storage SAN Volume Controller: Software Installation and Configuration Guide* for more information about the effect that background copy bandwidth has on foreground I/O latency.

remote_cluster_id | *remote_cluster_name*

(Required) Specifies the cluster ID or name of the remote cluster. Issue the **svcinfolclustercandidate** command to list the remote clusters that are available. If two or more remote clusters have the same name and the name is included in this command, the command fails and it requests the ID of the cluster instead of the name.

Description

This command creates a one-way partnership between the local cluster and the remote cluster that you specify in the command. To create a two-way partnership, the equivalent **svctask mkpartnership** command must be issued from the other cluster.

Intercluster Mirror relationships can be created between primary VDisks in the local cluster and auxiliary VDisks in the remote cluster. Intracluster relationships can be created between VDisks that reside in a local cluster. The VDisks must belong to the same I/O group within the cluster.

Possible failures

- CMMVC5786E The action failed because the cluster is not in a stable state.
- CMMVC5925E The remote cluster partnership was not created because it already exists.
- CMMVC5926E The remote cluster partnership was not created because there are too many partnerships.
- CMMVC5927E The action failed because the cluster ID is not valid.
- CMMVC5928E The action failed because the cluster name specified is a duplicate of another cluster.

- | • CMMVC6252E The command failed authorization because the session SSH key is not valid or was deleted.
- | • CMMVC6253E The command failed authorization because the session SSH key does not have the requisite role.

An invocation example

```
svctask mkpartnership -bandwidth 20 cluster1
```

The resulting output

No feedback

mkrcconsistgrp

The **mkrcconsistgrp** command creates a new, empty Metro Mirror or Global Mirror consistency group. If the **-cluster** parameter is not specified, the consistency group is created on the local cluster only.

Syntax

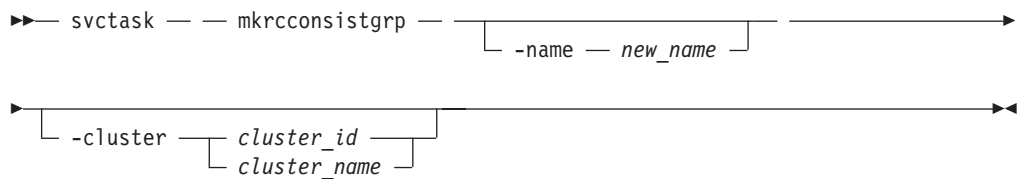

Parameters

-name *new_name*

(Optional) Specifies a name for the new consistency group.

-cluster *cluster_id* | *cluster_name*

(Optional) Specifies the name or ID of the remote cluster. If **-cluster** is not specified, a consistency group is created only on the local cluster.

Description

This command creates a new consistency group. The ID of the new group is displayed after the command processes. The name must be unique across all consistency groups that are known to the clusters within this consistency group. If the consistency group involves two clusters, the clusters must be in communication throughout the create process.

The new consistency group does not contain any relationships and will be in the empty state. You can add Metro Mirror or Global Mirror relationships to the group using the **svctask chrelationship** command.

Possible failures

- CMMVC5786E The action failed because the cluster is not in a stable state.
- CMMVC6252E The command failed authorization because the session SSH key is wrong or was deleted.
- CMMVC6253E The command failed authorization because the session SSH key does not have the requisite role.

An invocation example

```
svctask mkrconsistgrp -name rc_testgrp
```

The resulting output

```
RC Consistency Group, id [255], successfully created
```

mkcrrelationship

The **mkcrrelationship** command creates a new Metro Mirror or Global Mirror relationship with virtual disks (VDisks) in the same cluster (intracluster relationship) or in two different clusters (intercluster relationship).

Syntax

```
▶▶ svctask — — mkcrrelationship — — -master master_vdisk_id | master_vdisk_name
▶ -aux aux_vdisk_id | aux_vdisk_name — -cluster cluster_id | cluster_name
▶ — -name new_name_id — -consistgrp consist_group_id | consist_group_name
▶ — -sync — -global
```

Parameters

-master *master_vdisk_id* | *master_vdisk_name*

(Required) Specifies the ID or name of the master virtual disk.

-aux *aux_vdisk_id* | *aux_vdisk_name*

(Required) Specifies the ID or name of the auxiliary virtual disk.

-cluster *cluster_id* | *cluster_name*

(Required) Specifies the ID or name of the remote cluster.

If you are creating an intracluster relationship, enter the ID of the local cluster. The VDisks in the relationship must belong to the same I/O group within the cluster.

If you are creating an intercluster relationship, enter the ID of the remote cluster. To create a relationship in two different clusters, the clusters must be connected at the time that the **svctask mkcrrelationship** command is received.

-name *new_name_id*

(Optional) Specifies a label to assign to the relationship.

-consistgrp *consist_group_id* | *consist_group_name*

(Optional) Specifies a consistency group that this relationship joins. If you do not supply the **-consistgrp** parameter, the relationship is created as a stand-alone relationship that can be started, stopped, and switched on its own.

Note: Metro and Global Mirror relationships cannot belong to the same consistency group. When the first relationship is added to the consistency group, the group takes on the same type as the relationship. Subsequently, only relationships of that type can be added to the consistency group.

-sync

(Optional) Specifies that you want the system to create a synchronized relationship. The **-sync** parameter guarantees that the master and auxiliary disks contain identical data at the point that the relationship is created. You must ensure that the auxiliary disk is created to match the master disk and that no input transactions take place to either disk before you issue the create command. The initial background synchronization is skipped.

-global

(Optional) Specifies that you want the system to create a new Global Mirror relationship. If you do not specify the **-global** parameter, a Metro Mirror relationship is created instead.

Description

This command creates a new Metro Mirror or Global Mirror relationship. A Metro Mirror relationship defines the relationship between two virtual disks (VDisks): a master VDisk and an auxiliary VDisk. This relationship persists until it is deleted. The auxiliary virtual disk must be identical in size to the master virtual disk or the command fails, and if both VDIs are in the same cluster, they must both be in the same I/O group. The master and auxiliary cannot be in an existing relationship. Neither disk can be the target of a FlashCopy mapping. The command also returns the new relationship ID.

Metro Mirror relationships use one of the following copy types:

- A Metro Mirror copy ensures that updates are committed to both the primary and secondary VDIs before sending confirmation of I/O completion to the host application. This ensures that the secondary VDisk is synchronized with the primary VDisk in the event that a failover operation is performed.
- A Global Mirror copy allows the host application to receive confirmation of I/O completion before the updates are committed to the secondary VDisk. If a failover operation is performed, the host application must recover and apply any updates that were not committed to the secondary VDisk.

You can optionally give the relationship a name. The name must be a unique relationship name across both clusters.

The relationship can optionally be assigned to a consistency group. A consistency group ensures that a number of relationships are managed so that, in the event of a disconnection of the relationships, the data in all relationships within the group is in a consistent state. This can be important in, for example, a database application where data files and log files are stored on separate VDIs and consequently are managed by separate relationships. In the event of a disaster, the primary and secondary sites might become disconnected. As the disconnection occurs and the relationships stop copying data from the primary to the secondary site, there is no assurance that updates to the two separate secondary VDIs will stop in a consistent manner if the relationships that are associated with the VDIs are not in a consistency group.

For proper database operation, it is important that updates to the log files and the database data are made in a consistent and orderly fashion. It is crucial in this example that the logfile VDisk and the data VDisk at the secondary site are in a consistent state. This can be achieved by putting the relationships that are associated with these VDIs into a consistency group. Both Metro Mirror and

Global Mirror processing ensure that updates to both VDisks at the secondary site are stopped, leaving a consistent image based on the updates that occurred at the primary site.

If you specify a consistency group, both the group and the relationship must have been created using the same master cluster and the same auxiliary cluster. The relationship must not be a part of another consistency group. If the consistency group is *empty*, it acquires the type of the first relationship that is added to it. Therefore, each subsequent relationship that you add to the consistency group must have the same type.

If the consistency group is *not empty*, the consistency group and the relationship must be in the same state. If the consistency group is *empty*, it acquires the state of the first relationship that is added to it. If the state has an assigned copy direction, the direction of the consistency group and the relationship must match that direction.

If you do not specify a consistency group, a stand-alone relationship is created.

If you specify the **-sync** parameter, the master and auxiliary virtual disks contain identical data at the point when the relationship is created. You must ensure that the auxiliary is created to match the master and that no data movement occurs to either virtual disk before you issue the **svctask mkrrelationship** command.

If you specify the **-global** parameter, a Global Mirror relationship is created. Otherwise, a Metro Mirror relationship is created instead.

Possible failures

Note: If you receive an error for this command that indicates that the licensed virtualization capacity has been exceeded, then the command was still effective. However, the return code will indicate the license violation.

- CMMVC5786E The action failed because the cluster is not in a stable state.
- CMMVC5930E The Remote Copy relationship was not created because an entity that was specified in the command does not exist.
- CMMVC5931E The Remote Copy relationship was not created because the master or auxiliary virtual disk (VDisk) is locked.
- CMMVC5932E The Remote Copy relationship was not created because the master or auxiliary virtual disk (VDisk) is a member of a FlashCopy mapping.
- CMMVC5933E The Remote Copy relationship was not created because the master or auxiliary virtual disk (VDisk) is in the recovery I/O group.
- CMMVC5934E The specified relationship is not valid.
- CMMVC5965E The virtual disks (VDisks) are in different I/O groups on the local cluster.
- CMMVC6024E The auxiliary VDisk entered is invalid.
- CMMVC6034E The action failed because the maximum number of objects has been reached.
- CMMVC6237E The command failed as the remote cluster does not support global mirror
- CMMVC6252E The command failed authorization because the session SSH key is wrong or was deleted.
- CMMVC6253E The command failed authorization because the session SSH key does not have the requisite role.

An invocation example

```
svctask mkrcrelationship -master vdisk1 -aux vdisk2 -name rccopy1  
-cluster 0000020063432AFD
```

The resulting output

```
RC Relationship, id [28], successfully created
```

rmpartnership

The **rmpartnership** command removes a Metro Mirror or Global Mirror relationship on one cluster. Because the relationship exists on both clusters, it is necessary to run this command on both clusters to remove both sides of the relationship. If the command is run on only one cluster, the relationship enters a partially configured state and any Metro Mirror or Global Mirror activity ceases as the relationships become disconnected.

Syntax

```
svctask -- rmpartnership -- remote_cluster_id | remote_cluster_name
```

Parameters

remote_cluster_id | *remote_cluster_name*

(Required) Specifies the cluster ID or the name of the remote cluster.

Description

This command deletes one half of a relationship on a cluster. To remove the entire relationship, you must run this command twice – once on each cluster.

Possible failures

- CMMVC5786E The action failed because the cluster is not in a stable state.
- CMMVC5927E The action failed because the cluster ID is not valid.
- CMMVC5928E The action failed because the cluster name is a duplicate of another cluster.
- CMMVC5929E The Remote Copy partnership was not deleted because it has already been deleted.
- CMMVC6252E The command failed authorization because the session SSH key is wrong or was deleted.
- CMMVC6253E The command failed authorization because the session SSH key does not have the requisite role.

An invocation example

```
svctask rmpartnership cluster1
```

The resulting output

```
No feedback
```

rmrcconsistgrp

The **rmrcconsistgrp** command deletes an existing Metro Mirror or Global Mirror consistency group.

Syntax

```
svctask - - rmrconsistgrp - [-force -]
rc_consist_group_id | rc_consist_group_name
```

Parameters

-force

(Optional) Specifies that you want the system to remove all relationships belonging to a group before the consistency group is deleted. The relationships themselves are not deleted; they become stand-alone relationships.

Note: The **-force** parameter must be used to delete a consistency group when the consistency group has any Metro Mirror or Global Mirror relationships that is associated with it. If you do not use the **-force** parameter, the command fails.

rc_consist_group_id | *rc_consist_group_name*

(Required) Specifies the ID or the name of the consistency group to delete.

Description

This command deletes the specified consistency group. You can issue this command for any existing consistency group. If the consistency group is disconnected at the time that the command is issued, the consistency group is only deleted on the cluster that is connected. When the clusters reconnect, the consistency group is automatically deleted on the other cluster. Alternatively, if the clusters are disconnected, and you still want to remove the consistency group on both clusters, you can issue the **svctask rmrconsistgrp** command separately on both of the clusters.

If the consistency group is not empty, the **-force** parameter is required to delete the group. This removes the relationships from the consistency group before the group is deleted. These relationships become stand-alone relationships. The state of these relationships is not changed by the action of removing them from the consistency group.

Possible failures

- CMMVC5786E The action failed because the cluster is not in a stable state.
- CMMVC5937E The action failed because an entity that was specified in the command does not exist.
- CMMVC5938E The Remote Copy consistency group was not deleted because the consistency group contains relationships. To delete the consistency group, the force option is required.
- CMMVC6252E The command failed authorization because the session SSH key is wrong or was deleted.
- CMMVC6253E The command failed authorization because the session SSH key does not have the requisite role.

An invocation example

```
svctask rmrconsistgrp rctestone
```

The resulting output

No feedback

rmrcrelationship

The **rmrcrelationship** command deletes an existing Metro Mirror or Global Mirror relationship.

Syntax

```
svctask -- rmrcrelationship -- rc_rel_id | rc_rel_name
```

Parameters

rc_rel_id | *rc_rel_name*

(Required) Specifies the ID or the name of the relationship. A relationship cannot be deleted if it is part of a consistency group.

Description

This command deletes the relationship that is specified.

Deleting a relationship only deletes the logical relationship between the two virtual disks; it does not affect the virtual disks themselves.

If the relationship is disconnected at the time that the command is issued, the relationship is only deleted on the cluster where the command is being run. When the clusters reconnect, the relationship is automatically deleted on the other cluster. Alternatively, if the clusters are disconnected and if you still want to remove the relationship on both clusters, you can issue the **svctask rmrcrelationship** command independently on both of the clusters.

A relationship cannot be deleted if it is part of a consistency group. You must first remove the relationship from the consistency group using the **svctask chrcrelationship -force** command.

If you delete an inconsistent relationship, the secondary virtual disk becomes accessible even though it is still inconsistent. This is the one case in which Metro or Global Mirror does not inhibit access to inconsistent data.

Possible failures

- CMMVC5786E The action failed because the cluster is not in a stable state.
- CMMVC5935E The action failed because an entity that was specified in the command does not exist.
- CMMVC6252E The command failed authorization because the session SSH key is wrong or was deleted.
- CMMVC6253E The command failed authorization because the session SSH key does not have the requisite role.

An invocation example

```
svctask rmrcrelationship rccopy1
```

The resulting output

starttrconsistgrp

The **starttrconsistgrp** command starts the Metro Mirror or Global Mirror consistency group copy process, sets the direction of copy if it is undefined, and optionally marks the secondary VDisks of the consistency group as clean.

Syntax

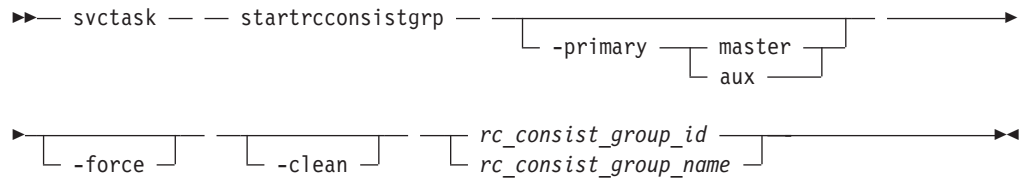

Parameters

-primary *master* | *aux*

(Optional) Specifies the copy direction by defining whether the master or auxiliary disk becomes the primary (source). This parameter is required when the primary is undefined if, for example, the consistency group is in the **Idling** state.

-force

(Optional) Specifies that you want the system to process the copy operation even if it might lead to a temporary loss of consistency while synchronization occurs. This parameter is required if the consistency group is in the **ConsistentStopped** state, but is not synchronized or is in the **Idling** state, but is not synchronized.

-clean

(Optional) Specifies that the VDisk that is to become a secondary is clean for each of the relationships belonging to the group; any changes made on the secondary VDisk are ignored, and only changes made on the clean primary VDisk are considered during synchronization of the primary and secondary disks. The consistency group must be in an **Idling** (connected) state for this parameter to work.

rc_consist_group_id | *rc_consist_group_name*

(Required) Specifies the ID or name of the consistency group to start.

Description

This command starts a Metro Mirror or Global Mirror stand-alone consistency group.

This command can only be issued to a consistency group that is connected. For a consistency group that is idling, this command assigns a copy direction (primary and secondary roles) and begins the copy process. Otherwise, this command restarts a previous copy process that was stopped either by a stop command or by an I/O error.

If the resumption of the copy process leads to a period of time when the relationship is not consistent, then you must specify the **-force** parameter when you restart the relationship. This situation can arise if the relationship had been

stopped and then further input transactions had been performed on the original primary disk of the relationship. When you use the **-force** parameter in this situation, the data on the secondary disk is not usable (because it is inconsistent) in a disaster recovery circumstance.

In the idling state, you must provide the **-primary** parameter. In other connected states, you can provide the **-primary** parameter, but it must match the existing setting.

The **-force** parameter is required if consistency would be lost by starting a copy operation. This can occur if write operations on either primary or secondary VDisks have taken place since the **ConsistentStopped** or **idling** state occurred. If the command is issued without the **-force** parameter in such circumstances, the command fails. In general, the **-force** parameter is required if the group is in one of the following states:

- Consistent_Stopped but not synchronized (sync=out_of_sync)
- Idling but not synchronized

The **-force** parameter is not required if the group is in one of the following states:

- Inconsistent_Stopped
- Inconsistent_Copying
- Consistent_Synchronized

However, the command does not fail if you specify the **-force** parameter.

The **-clean** parameter is used when a Metro Mirror or Global Mirror group is started and the secondary VDisks in this group are assumed to be clean. Clean in this sense, means that any changes that have been made at the secondary are ignored and only changes made at the primary are considered when synchronizing the primary and secondary VDisks. The **-clean** parameter can be used in the following scenario:

1. A consistency group is created with the **-synch** parameter. At this point, it does not matter if the primary and secondary contain the same data, even though the use of the **-synch** parameter implies that this is true.
2. A **stoprconsistgrp** command is issued with the **-access** parameter. This permits access to the secondary disk. Change recording begins at the primary.
3. An image of the primary disk is copied and loaded on to the secondary disk. It is permissible to allow updates to the primary disk during the image copy as this image can be only a fuzzy image of the primary disk.
4. A **starttrconsistgrp** command that specifies the **-primary master**, **-force**, and **-clean** parameters is issued. The auxiliary disk is marked as clean and changes on the master disk that have occurred since the relationship was stopped are copied to the auxiliary disk.
5. Once the background copy has completed, relationships in the group become consistent and synchronized.

Possible failures

- CMMVC5786E The action failed because the cluster is not in a stable state.
- CMMVC5936E The action failed because an entity that was specified in the command does not exist.
- CMMVC6252E The command failed authorization because the session SSH key is wrong or was deleted.

- CMMVC6253E The command failed authorization because the session SSH key does not have the requisite role.

An invocation example

```
svctask starttrconsistgrp rccopy1
```

The resulting output

No feedback

startrelationship

The **startrelationship** command starts the Metro Mirror or Global Mirror relationship copy process, sets the direction of copy if undefined, and optionally, marks the secondary VDisk of the relationship as clean. The relationship must be a stand-alone relationship.

Syntax

```
svctask -- startrelationship -- [-primary master | aux] [-force] [-clean] rc_rel_id rc_rel_name
```

Parameters

-primary *master* | *aux*

(Optional) Specifies the copy direction by defining whether the master or auxiliary disk becomes the primary (source). This parameter is required when the primary is undefined if, for example, the relationship is in the idling state.

-force

(Optional) Specifies that you want the system to process the copy operation even if it might lead to a temporary loss of consistency while synchronization occurs. This parameter is required if the relationship is in the **Consistentstopped** state, but is not synchronized or in the **Idling** state, but is not synchronized.

-clean

(Optional) Specifies that the VDisk that is to become a secondary is clean; any changes made on the secondary VDisk are ignored, and only changes made on the clean primary VDisk are considered when synchronizing the primary and secondary disks. The relationship must be in an Idling (connected) state for this parameter to work.

rc_rel_id | *rc_rel_name*

(Required) Specifies the ID or name of the relationship that you want to start in a stand-alone relationship.

Description

The **startrelationship** command starts a stand-alone relationship. The command fails if it is used to start a relationship that is part of a consistency group.

This command can only be issued to a relationship that is connected. For a relationship that is idling, this command assigns a copy direction (primary and

secondary roles) and begins the copy process. Otherwise, this command restarts a previous copy process that was stopped either by a stop command or by some I/O error.

If the resumption of the copy process leads to a period of time when the relationship is not consistent, you must specify the **-force** parameter when you restart the relationship. This situation can arise if the relationship had been stopped, and then further input transactions had occurred on the original primary of the relationship. Even though you use of the **-force** parameter in this situation, the data on the secondary is not be useful for disaster recovery purposes because the relationship is in an inconsistent state.

In the idling state, you must provide the **-primary** parameter. In other connected states, you can provide the **-primary** parameter, but it must match the existing setting.

The **-force** parameter is required if consistency would be lost by starting a copy operation. This can occur if input transactions have occurred on either the primary or secondary VDisks since the **ConsistentStopped** or **Idling** state occurred. If the **startrelationship** command is issued without the **-force** parameter in such circumstances, the command fails. In general, the **-force** parameter is required if the relationship is in one of the following states:

- **ConsistentStopped** but not synchronized
- **Idling** but not synchronized

The **-force** parameter is not required if the relationship is in one of the following states:

- **InconsistentStopped**
- **InconsistentCopying**
- **ConsistentSynchronized**

However, the command will not fail if you do specify the **-force** parameter.

The **-clean** parameter is used when a Metro Mirror or Global Mirror relationship is started and the secondary VDisk in the relationship is assumed to be clean; any changes made on the secondary VDisk are ignored, and only changes made on the clean primary VDisk are considered when synchronizing the primary and secondary disks. The **-clean** parameter can be used in the following circumstance:

1. A relationship is created with the **-synch** parameter specified. (At this point it does not matter if the primary and secondary disks contain the same data, even though the use of the **-synch** parameter implies that this is true).
2. A **svctask stoprelationship** command is issued with the **-access** parameter specified. This permits access to the secondary disk. Change recording begins at the primary disk.
3. An image of the primary disk is copied and loaded on to the secondary disk. It is permissible to allow updates to the primary disk during the image copy as this image need only be a *fuzzy* image of the primary disk.
4. A **svctask startrelationship** command that specifies the **-primary master**, **-force**, and **-clean** parameters is issued. The auxiliary disk is marked as clean and changes on the master disk that have occurred since the relationship was stopped are copied to the auxiliary disk.
5. Once the background copy has completed, the relationship becomes consistent and synchronized.

Possible failures

- CMMVC5786E The action failed because the cluster is not in a stable state.
- CMMVC5936E The action failed because an entity that was specified in the command does not exist.
- CMMVC6252E The command failed authorization because the session SSH key is wrong or was deleted.
- CMMVC6253E The command failed authorization because the session SSH key does not have the requisite role.

An invocation example

```
svctask starttrrelationship rccopy1
```

The resulting output

```
No feedback
```

stoprconsistgrp

The **stoprconsistgrp** command stops the copy process for a Metro Mirror or Global Mirror consistency group. This command can also be used to enable write access to the secondary VDisks in the group if the group is in a consistent state.

Syntax

```
▶▶ svctask — — stoprconsistgrp — — [ -access ] —————▶▶
  └── rc_consist_group_id ───┬────────────────────────────────────────▶▶
      rc_consist_group_name ─┘
```

Parameters

-access

(Optional) Allows write access to consistent secondary VDisks in the consistency group.

rc_consist_group_id | *rc_consist_group_name*

(Required) Specifies the ID or the name of the consistency group to stop all processing for.

Description

This command applies to a consistency group. You can issue this command to stop processing on a consistency group that is copying from primary VDisks to secondary VDisks.

If the consistency group is in an inconsistent state, all copy operations stop and do not resume until you issue the **svctask starttrconsistgrp** command. For a consistency group in the **ConsistentSynchronized** state, this command causes a consistency freeze.

When a consistency group is in a consistent state (for example, in the **ConsistentStopped**, **ConsistentSynchronized**, or **ConsistentDisconnected** state) you can issue the **-access** parameter with the **stoprconsistgrp** command to enable write access to the secondary virtual disks within that group. The following table show consistency group initial and final states:

Table 2. **stopprconsistgrp** consistency group states. **stopprconsistgrp** consistency group initial and final states

Initial state	Final state	Notes
InconsistentStopped	InconsistentStopped	None.
InconsistentCopying	InconsistentStopped	None.
ConsistentStopped	ConsistentStopped	-access permitted
ConsistentSynchronized	ConsistentStopped	-access permitted
Idling	ConsistentStopped	-access permitted
IdlingDisconnected	unchanged	A relationship can move to the Stopped state when the cluster is reconnected.
InconsistentDisconnected	InconsistentStopped	These states apply to the cluster issuing the svctask stopprconsistgrp command.
InconsistentDisconnected	unchanged	These states apply to the disconnected cluster.
ConsistentDisconnected	ConsistentStopped	These states apply to the cluster issuing the svctask stopprconsistgrp command; the -access parameter is permitted.
ConsistentDisconnected	unchanged	On the disconnected cluster, the -access parameter is permitted.

Possible failures

- CMMVC5786E The action failed because the cluster is not in a stable state.
- CMMVC5936E The action failed because an entity that was specified in the command does not exist.
- CMMVC6252E The command failed authorization because the session SSH key is wrong or was deleted.
- CMMVC6253E The command failed authorization because the session SSH key does not have the requisite role.

An invocation example

```
svctask stopprconsistgrp rccopy1
```

The resulting output

No feedback

stopprrelationship

The **stopprrelationship** command stops the copy process for a Metro Mirror or Global Mirror stand-alone relationship. You can also use this command to enable write access to a consistent secondary VDisk.

Syntax

```
svctask — — stopprrelationship — [ -access ] [ rc_rel_id rc_rel_name ]
```

Parameters

-access

(Optional) Specifies that the system allow write access to a consistent secondary VDisk.

rc_rel_id | rc_rel_name

(Required) Specifies the ID or the name of the relationship to stop all processing for.

Description

The **stopprrelationship** command applies to a stand-alone relationship. The command is rejected if it is addressed to a relationship that is part of a consistency group. You can issue this command to stop a relationship that is copying from primary to secondary VDIs.

If the relationship is in an inconsistent state, any copy operation stops and does not resume until you issue a **svctask startprrelationship** command. For a relationship in the **ConsistentSynchronized** state, this command causes a consistency freeze.

When a relationship is in a consistent state – in the **ConsistentStopped**, **ConsistentSynchronized**, or **ConsistentDisconnected** state – you can use the **-access** parameter to enable write access to the secondary virtual disk. The following table shows consistency group initial and final states:

Table 3. stopprrelationship consistency group states. stopprrelationship consistency group initial and final states

Initial state	Final state	Notes
InconsistentStopped	InconsistentStopped	None.
InconsistentCopying	InconsistentStopped	None.
ConsistentStopped	ConsistentStopped	The -access parameter is permitted.
ConsistentSynchronized	ConsistentStopped	The -access parameter is permitted.
Idling	ConsistentStopped	The -access parameter is permitted.
IdlingDisconnected	unchanged	A relationship can move to the stopped state when the cluster is reconnected.
InconsistentDisconnected	InconsistentStopped	These states apply to the cluster issuing the svctask stopprrelationship command.
InconsistentDisconnected	unchanged	These states apply to the disconnected cluster.
ConsistentDisconnected	ConsistentStopped	These states apply to the cluster issuing the svctask stopprrelationship command. The -access parameter is permitted.

Table 3. **stopprrelationship** consistency group states (continued). **stopprrelationship** consistency group initial and final states

Initial state	Final state	Notes
ConsistentDisconnected	unchanged	These states apply to the disconnected cluster. The -access parameter is permitted.

Possible failures

- CMMVC5786E The action failed because the cluster is not in a stable state.
- CMMVC5936E The action failed because an entity that was specified in the command does not exist.
- CMMVC6252E The command failed authorization because the session SSH key is wrong or was deleted.
- CMMVC6253E The command failed authorization because the session SSH key does not have the requisite role.

An invocation example

```
svctask stopprrelationship rccopy1
```

The resulting output

No feedback

switchrconsistgrp

The **switchrconsistgrp** command reverses the roles of the primary and secondary virtual disks (VDisks) in a Metro Mirror or Global Mirror consistency group when that consistency group is in a consistent state. All the relationships in the consistency group are affected by this change.

Syntax

```
svctask -- switchrconsistgrp -- -primary [ master | aux ]
[ rc_consist_group_id | rc_consist_group_name ]
```

Parameters

-primary master | aux

(Required) Specifies whether the master or auxiliary side of the relationships in the group will become the primary VDisks.

rc_consist_group_id | rc_consist_group_name

(Required) Specifies the ID or name of the consistency group to switch.

Description

This command applies to a consistency group. It is normally issued to reverse the roles of the primary and secondary virtual disks in a consistency group, perhaps as part of a failover process that is associated with a disaster recovery event. Write access to the former primary VDisks is lost and write access to the new primary

VDisks is acquired. This command is successful when the consistency group is in a connected, consistent state, and when reversing the direction of the relationships would not lead to a loss of consistency, for example, when the consistency group is consistent and synchronized. The consistency group must be in one of the following states in order for the **switchrcconsistgrp** command to process correctly:

- ConsistentSynchronized
- ConsistentStopped and Synchronized
- Idling and Synchronized

The consistency group moves to the ConsistentSynchronized state after the successful completion of this command. If you specify the **-primary** parameter and it is the same as the current primary, the command has no effect.

Possible failures

- CMMVC5786E The action failed because the cluster is not in a stable state.
- CMMVC5936E The action failed because an entity that was specified in the command does not exist.
- CMMVC6252E The command failed authorization because the session SSH key is wrong or was deleted.
- CMMVC6253E The command failed authorization because the session SSH key does not have the requisite role.

An invocation example

```
svctask switchrcconsistgrp -primary aux rccopy2
```

The resulting output

```
No feedback
```

switchrcrelationship

The **switchrcrelationship** command reverses the roles of primary and secondary virtual disks in a stand-alone Metro Mirror or Global Mirror relationship when that relationship is in a consistent state.

Syntax

```

▶▶— svctask — — switchrcrelationship — — -primary ——— master —————▶
                               └─ aux ─────────┘
▶└─ rc_rel_id ─────────────────────────────────────────────────────────────────▶
   └─ rc_rel_name ───────────────────────────────────────────────────────────▶

```

Parameters

-primary master | aux

(Required) Specifies whether the master disk or the auxiliary disk is to be the primary.

rc_rel_id | rc_rel_name

(Required) Specifies the ID or the name of the relationship to switch.

Description

The **switchrcrelationship** command applies to a stand-alone relationship. It is rejected if it is used to try to switch a relationship that is part of a consistency

group. It is normally issued to reverse the roles of the primary and secondary virtual disk in a relationship perhaps as part of a failover process during a disaster recovery event. Write access to the old primary disk is lost and write access to the new primary disk is acquired. This command is successful when the relationship is in a connected, consistent state, and when reversing the direction of the relationship does not lead to a loss of consistency; that is, when the relationship is consistent and synchronized. The relationship must be in one of the following states in order for the **switchrcrelationship** command to process correctly:

- ConsistentSynchronized
- ConsistentStopped and Synchronized
- Idling and Synchronized

The relationship moves to the **ConsistentSynchronized** state after the successful completion of this command. If you specify the **-primary** parameter with the current primary, the command has no effect.

Possible failures

- CMMVC5786E The action failed because the cluster is not in a stable state.
- CMMVC5936E The action failed because an entity that was specified in the command does not exist.
- CMMVC6252E The command failed authorization because the session SSH key is wrong or was deleted.
- CMMVC6253E The command failed authorization because the session SSH key does not have the requisite role.

An invocation example

```
svctask switchrcrelationship -primary master rccopy2
```

The resulting output

```
No feedback
```

Chapter 16. Migration commands

The following commands enable you to work with migration options with the SAN Volume Controller.

migrateexts

The **migrateexts** command enables you to migrate a number of extents from any one managed disk to another.

Syntax

```
svctask -- migrateexts -- -source source_mdisk_id source_mdisk_name
-- -target target_mdisk_id target_mdisk_name -- -exts number_of_extents
-- -threads number_of_threads -- -vdisk vdisk_id vdisk_name
```

Parameters

- source** *source_mdisk_id* | *source_mdisk_name*
(Required) Specifies the MDisk on which the extents currently reside.
- target** *target_mdisk_id* | *target_mdisk_name*
(Required) Specifies the MDisk onto which the extents are to be migrated.
- exts** *number_of_extents*
(Required) Specifies the number of extents to migrate.
- threads** *number_of_threads*
(Optional) Specifies the number of threads to use while migrating these extents. You can specify 1 - 4 threads. The default number of threads is 4.
- vdisk** *vdisk_id* | *vdisk_name*
(Required) Specifies the VDisk to which the extents belong.

Description

This command migrates a given number of extents from the source virtual disk and the managed disk that contains extents that are used to make up the virtual disk. The target is a managed disk within the same managed disk group.

If a large number of extents are being migrated, you can specify 1 - 4 threads. You can issue the **svcinfo lsmigrate** command to check the progress of the migration.

The **svctask migrateexts** command fails if there are insufficient free extents on the target managed disk. To avoid this problem, do not issue new commands that use extents until the extents migration is completed.

Note: Migration activity on a single managed disk is limited to a maximum of 4 concurrent operations. This limit does not take into account whether the managed disk is the source or the destination target. If more than four

migrations are scheduled for a particular managed disk, further migration operations are queued pending the completion of one of the currently running migrations. If a migration operation is stopped for any reason, a queued migration task can be started. However, if a migration is suspended, the current migration continues to use resources and a pending migration is not started. For example, the following setup is a possible initial configuration:

- MDiskGrp 1 has VDisk 1 created in it
- MDiskGrp 2 has VDisk 2 created in it
- MDiskGrp 3 has only one MDisk

With the previous configuration, the following migration operations are started:

- Migration 1 migrates VDisk 1 from MDiskGrp 1 to MDiskGrp 3, running with 4 threads.
- Migration 2 migrates VDisk 2 from MDiskGrp 2 to MDiskGrp 3, running with 4 threads.

Due to the previous limitations, the two migration operations do not always run at the same speed. MDiskGrp 3 has only one MDisk and the two migration operations have a total of 8 threads that are trying to access the one MDisk. Four threads are active. The remaining threads are in standby mode waiting to access the MDisk.

Possible failures

- CMMVC5786 The action failed because the cluster is not in stable state.
- CMMVC5845 The extent was not migrated because an object that was specified in the command does not exist.
- CMMVC5849E The migration failed because some or all of the extents are already being migrated.
- CMMVC5850E The extent was not migrated because there is a problem with the source extents.
- CMMVC5851E The extent was not migrated because there is a problem with the target extents.
- CMMVC5852E The migration failed because there are too many migrations in progress.
- CMMVC5859E The migration did not complete because an error occurred while migrating the last extent on an image-mode virtual disk (VDisk).
- CMMVC5863E The migration failed because there are not enough free extents on the target managed disk (MDisk).
- CMMVC5865E The extent specified is out of range for the mdisk or VDisk specified.
- CMMVC5866E The extent was not migrated because the extent contains internal data.
- CMMVC6252E The command failed authorization because the session SSH key is wrong or was deleted.
- CMMVC6253E The command failed authorization because the session SSH key does not have the requisite role.

An invocation example

```
svctask migrateexts -vdisk vdisk4 -source mdisk4 -exts  
64 -target mdisk6 -threads 4
```

The resulting output

No feedback

migratetoimage

The **migratetoimage** command enables you to migrate the data of the user-specified source virtual disk (either image mode or managed mode) onto the specified unmanaged disk to create an image mode VDisk. The target disk can be in the same or in a different managed disk (MDisk) group as the source disk.

Syntax

```
svctask -- migratetoimage -- -vdisk [ source_vdisk_id | source_vdisk_name ]
      -threads [ number_of_threads ]
      -mdisk [ unmanaged_target_mdisk_id | unmanaged_target_mdisk_name ]
      -mdiskgrp [ managed_disk_group_id | managed_disk_group_name ]
```

Parameters

- vdisk** *source_vdisk_id* | *name*
(Required) Specifies the name or ID of the source VDisk to be migrated.
- threads** *number_of_threads*
(Optional) Specifies the number of threads to use during the migration of extents. You can specify 1 - 4 threads. The default number of threads is 4.
- mdisk** *unmanaged_target_mdisk_id* | *name*
(Required) Specifies the name of the MDisk to which the data must be migrated. This disk must be unmanaged and large enough to contain the data of the disk that is being migrated.
- mdiskgrp** *managed_disk_group_id* | *name*
(Required) Specifies the MDisk group into which the MDisk must be placed, after the migration has completed.

Description

The **migratetoimage** command migrates the data of the user-specified source virtual disk onto the managed disk that is specified as the target. At completion of the command, the virtual disk is classified as an image mode disk.

The managed disk that is specified as the target must be in an unmanaged state at the time that the command is run. Running this command results in the inclusion of the MDisk into the user-specified MDisk group.

Possible failures

Note: If you receive an error for this command that indicates that the licensed virtualization capacity has been exceeded, then the command was still effective. However, the return code indicates the license violation.

- CMMVC5786E The action failed because the cluster is not in a stable state.
- CMMVC5842E The action failed because an entity that was specified in the command does not exist.
- CMMVC5874E The action failed because the host does not exist.
- CMMVC5875E The action failed because the virtual disk (VDisk) does not exist.
- CMMVC6252E The command failed authorization because the session SSH key is wrong or was deleted.
- CMMVC6253E The command failed authorization because the session SSH key does not have the requisite role.

The following example specifies that the user wants to migrate the data from vdisk1 onto mdisk5 and that the MDisk must be put into the MDisk group mdgrp2.

An invocation example

```
svctask migratetoimage -vdisk vdisk1 -mdisk mdisk5 -mdiskgrp mdgrp2
```

The resulting output

No feedback

migratevdisk

The **migratevdisk** command enables you to migrate an entire virtual disk from one managed disk group to another managed disk group.

Syntax

```

▶▶— svctask — — migratevdisk — — -mdiskgrp mdisk_group_id —————▶
mdisk_group_name

```

```

▶ -threads — number_of_threads — -vdisk vdisk_id —————▶
vdisk_name

```

Parameters

-mdiskgrp *mdisk_group_id* | *mdisk_group_name*

(Required) Specifies the new managed disk group ID or name.

-threads *number_of_threads*

(Optional) Specifies the number of threads to use during the migration of these extents. You can specify 1 - 4 threads. The default number of threads is 4.

-vdisk *vdisk_id* | *vdisk_name*

(Required) Specifies the virtual disk ID or name to migrate in to a new managed disk group.

Description

The **migratevdisk** command migrates the specified virtual disk into a new managed disk group; all the extents that make up the virtual disk are migrated onto free extents in the new managed disk group.

You can issue the **svcinfolsmigrate** command to view the progress of the migration.

The process can be prioritized by specifying the number of threads to use during the migration. Using only one thread puts the least background load on the system.

The **migratevdisk** command fails if there are insufficient free extents on the targeted managed disk group for the duration of the command. To avoid this problem, do not issue new commands that use extents until the VDisk migration is completed.

Possible failures

- CMMVC5786E The action failed because the cluster is not in a stable state.
- CMMVC5846E The virtual disk (VDisk) was not migrated because an entity that was specified in the command does not exist.
- CMMVC5847E The virtual disk (VDisk) was not migrated because its associated managed disk (MDisk) is already in the MDisk group.
- CMMVC5849E The migration failed because some or all of the extents are already being migrated.
- CMMVC5852E The migration failed because there are too many migrations in progress.
- CMMVC5853E The action failed because there was a problem with the MDisk group.
- CMMVC5861E The action failed because there were not enough extents on the managed disk (MDisk).
- CMMVC5863E The migration failed because there are not enough free extents on the target managed disk (MDisk).
- CMMVC6252E The command failed authorization because the session SSH key is wrong or was deleted.
- CMMVC6253E The command failed authorization because the session SSH key does not have the requisite role.

An invocation example

```
svctask migratevdisk -vdisk 4 -mdiskgrp Group0 -threads 2
```

The resulting output

No feedback

Chapter 17. Tracing commands

Tracing commands capture information that can assist you with troubleshooting managed disks and virtual disks.

setdisktrace

Use the **setdisktrace** command to set a list of disks of a given type, to include in a disk trace.

Syntax

```
svctask -- setdisktrace -- -type [ mdisk | vdisk ] [ -set | -reset ]
[ -all | -objectid id_or_name_list ] [ -objectid id_or_name_list ]
```

Parameters

-type mdisk | vdisk

(Required) Specifies the object type for the disks.

-set

(Optional) Specifies the set argument. You cannot use the **-set** parameter with the **-reset** parameter.

-reset

(Optional) Specifies the reset argument. You cannot use the **-set** parameter with the **-reset** parameter.

-all

(Optional) Traces all disks of the specified type. You cannot use the **-all** parameter with the **-objectid** parameter.

-objectid id_or_name_list

(Optional) Specifies a list of one or more disk IDs or names. You cannot use the **-objectid** parameter with the **-all** parameter.

Description

The **setdisktrace** command marks the disks to be included in the next triggered trace.

The command is used with the **svctask settrace** command, which sets the options that result in a trace file and the data that is included in the trace file.

Possible failures

- CMMVC5786E The action failed because the cluster is not in a stable state.

An invocation example

```
svctask setdisktrace -type mdisk -objectid
mdisk1:mdisk3:mdisk11:mdisk10:mdisk9:mdisk5 -reset
```

The resulting output

No feedback

settrace

The **settrace** command sets options to trace certain I/O operations through the system.

Syntax

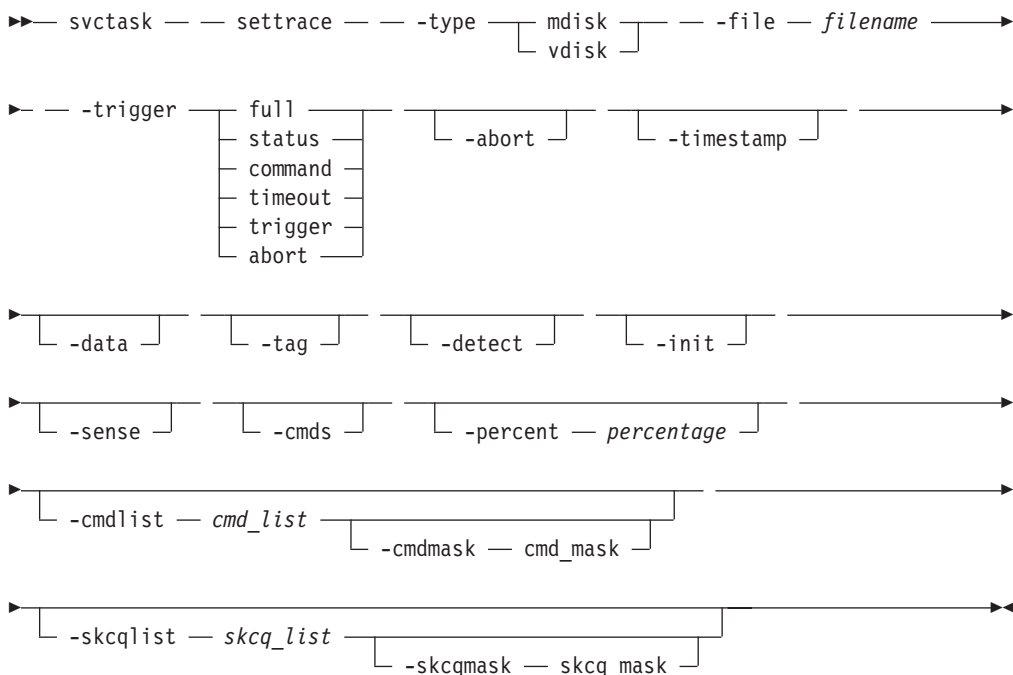

Parameters

-type mdisk | vdisk

(Required) Specifies the type of objects to trace.

-file filename

(Required) Specifies the file name prefix for the trace file.

-trigger full | status | command | timeout | trigger | abort

(Required) Specifies an action for when the trace is started (triggered).

full Specifies to stop the trace when the trace buffer is full, for MDisks and VDIs.

status Sets a trigger for when the specified SCSI status (**-skcqlist**) is reported in sense data, for MDisks and VDIs.

command

Specifies a trigger for when the given SCSI command (**-cmdlist**) is sent, for MDisks and VDIs.

timeout

Sets a trigger for when a timeout occurs, for MDisks only.

trigger

Specifies to keep running until the trigger event, for MDisks only.

abort Sets a trigger for when an abnormal end occurs, for VDIs only.

-abort

(Optional) Adds abnormal ending details to the trace, for VDIs only.

-timestamp

(Optional) Adds a time-stamp to each entry in the trace. A file name is created from the prefix plus a time-stamp. The file name is in the form *prefix_AAAAAA_YYMMDD_HHMMSS*, where *AAAAAA* is the panel name of the node generating the trace file.

-data

(Optional) Adds I/O data to the trace.

-tag

(Optional) Adds CCB tags to the trace, for MDIs only.

-detect

(Optional) Adds MDisk discovery details to the trace, for MDIs only.

-init

(Optional) Adds MDisk initialization details to the trace, for MDIs only.

-sense

(Optional) Adds SCSI sense data to the trace, for VDIs only.

-cmds

(Optional) Adds commands data to the trace, for VDIs only.

-percent

(Optional) Specifies the trigger point in the trace file, which determines the amount of data to collect after the trigger point. The default value is **50**, which places the trigger point in the middle of the trace file.

-cmdlist *cmd_list*

(Optional) Adds the commands in the *cmd_list* to the trace file.

-cmdmask *cmd_mask*

(Optional) Adds the commands in the *cmd_mask* to the trace file. The **-cmdmask** parameter must be used with the **-cmdlist** parameter.

-skcqlist *skcq_list*

(Optional) Specifies an SKCQ list, which adds only those SKCQ details to the trace file.

-skcqmask *skcq_mask*

(Optional) Specifies an SKCQ mask, which adds only those SKCQ details to the trace file. The **-skcqmask** parameter must be used with the **-skcqlist** parameter.

Description

The **settrace** command sets the various I/O tracing options for managed disks or virtual disks. When the relevant disk type trace is subsequently triggered, the options specify the data to be included in the trace file.

The file name specifies a file name prefix to use when you are generating a trace file. The system appends the node panel name and a timestamp to the file name.

A maximum of 10 trace files are kept on the cluster. When the eleventh trace is made, the oldest existing trace file is overwritten.

The directory can also hold files that are retrieved from other nodes. These files are not counted. The cluster deletes the oldest file to maintain the maximum number of files.

Possible failures

- CMMVC5786E The action failed because the cluster is not in a stable state.
- CMMVC6073E The maximum number of files has been exceeded.

An invocation example

```
svctask settrace -type vdisk -file tracedump -trigger abort  
-percent 100 -abort -timestamp
```

The resulting output

No feedback

starttrace

Use the **starttrace** command to begin tracing I/O operations that are based on the option currently set for the specified object type and the list of disks to trace.

Syntax

```
▶▶— svctask — — starttrace — — -type ————┐—————▶  
└── mdisk ─┘  
└── vdisk ─┘
```

Parameters

-type mdisk | vdisk

Specifies the object type to trigger.

Description

This command starts the collection of I/O tracing information. The trace file is generated according to the options that you specified in the **svctask settrace** command. The disks that are traced are those that are identified in the list that is set by the **svctask setdisktrace** command.

The traces are written to the **/dumps/iotrace** directory. You can view the contents of this directory using the **svcinfolsiotracedumps** command.

Possible failures

- CMMVC5786E The action failed because the cluster is not in a stable state.
- CMMVC5809E The tracing of I/O operations was not started because it is already in progress.
- CMMVC5986E The tracing of I/O operations was not started because the virtual disk (VDisk) or managed disk (MDisk) failed to return statistics.

An invocation example

```
svctask starttrace -type vdisk
```

The resulting output

No feedback

stoptrace

Use the **stoptrace** command to stop tracing operations for the specified disk type.

Syntax

```
svctask -- stoptrace -- -type [ mdisk | vdisk ]
```

Parameters

-type mdisk | vdisk

(Required) Specifies the object type to stop tracing.

Description

This command stops the tracing of I/O operations for the specified object type. A trace file is not generated if the trigger options have not been met.

Possible failures

- CMMVC5786E The action failed because the cluster is not in a stable state.

An invocation example

```
svctask stoptrace -type mdisk
```

The resulting output

No feedback

Chapter 18. Attributes of the `-filtervalue` parameters

The `-filtervalue` parameter filters a view that is based on specific attribute values that relate to each object type. You can combine multiple filters to create specific searches, for example, `-filtervalue name=fred:status=online`. The help (`-filtervalue?`) specifies the attributes that are available for each object type.

The `-filtervalue` parameter must be specified with `attrib=value`. The `-filtervalue?` and `-filtervalue` parameters cannot be specified together.

Note: The qualifier characters left bracket (<) and right bracket (>) must be enclosed within double quotation marks (""). For example, `-filtervalue vdisk_count "<"4 or port_count ">"1`. It is also valid to include the entire expression within double quotation marks. For example, `-filtervalue "vdisk_count<4"`

When an attribute requires the `-unit` parameter, it is specified after the attribute. For example, `-filtervalue capacity=24 -unit mb`. The following input options are valid for the `-unit` parameter:

- **b** (bytes)
- **mb** (Megabytes)
- **gb** (Gigabytes)
- **tb** (Terabytes)
- **pb** (Petabytes)

Table 4 provides a list of valid filter attributes, as well as descriptions, qualifiers and wildcards for each object type.

You can use the asterisk (*) character as a wildcard character, at the beginning or end of a text string, but not both.

Table 4. Valid filter attributes. Valid filter attributes for the `-filtervalue` parameter.

Object	Attribute	Valid Qualifiers	Wildcard Valid	Description
cluster	<code>cluster_name</code> or <code>name</code>	=	Yes	The cluster name.
	<code>cluster_unique_id</code> or <code>id</code>	=, <, <=, >, >=	No	The cluster ID.

Table 4. Valid filter attributes (continued). Valid filter attributes for the **-filtervalue** parameter.

Object	Attribute	Valid Qualifiers	Wildcard Valid	Description
node	<i>node_name</i> or <i>name</i>	=	Yes	The node name.
	<i>id</i>	=, <, <=, >, >=	No	The node ID.
	<i>status</i>	=	No	The status of the node. The following values are valid for node <i>status</i> : <ul style="list-style-type: none"> • adding • deleting • online • offline • pending
	<i>IO_group_name</i>	=	Yes	The I/O group name.
	<i>IO_group_id</i>	=, <, <=, >, >=	No	The I/O group ID.
	<i>hardware</i>	=	No	The following values are valid for <i>hardware</i> type: 4F2 , 8F2 , and 8F4 .
	io_grp	<i>HWS_name</i> or <i>name</i>	=	Yes
<i>HWS_unique_id</i> or <i>id</i>		=, <, <=, >, >=	No	The I/O group ID.
<i>node_count</i>		=, <, <=, >, >=	No	The number of nodes in the I/O group.
<i>host_count</i>		=, <, <=, >, >=	No	The number of hosts associated with the io_grp.
controller	<i>controller_id</i> or <i>id</i>	=, <, <=, >, >=	No	The controller ID.
mdisk	<i>name</i>	=	Yes	The name of the MDisk.
	<i>id</i>	=, <, <=, >, >=	No	The ID of the MDisk.
	<i>controller_name</i>	=	Yes	The name of the controller the MDisk belongs to.
	<i>status</i>	=	No	The status of the MDisk. <p>The following values are valid for MDisk <i>status</i>:</p> <ul style="list-style-type: none"> • online • degraded • excluded • offline
	<i>mode</i>	=	No	The mode of the MDisk. <p>The following values are valid for MDisk <i>mode</i>:</p> <ul style="list-style-type: none"> • unmanaged • managed • image
	<i>mdisk_grp_name</i>	=	Yes	The MDisk group name.
	<i>mdisk_grp_id</i>	=, <, <=, >, >=	No	The MDisk group ID.
	<i>capacity</i>	=, <, <=, >, >=	No	The capacity. Requires the -unit parameter.

Table 4. Valid filter attributes (continued). Valid filter attributes for the **-filtervalue** parameter.

Object	Attribute	Valid Qualifiers	Wildcard Valid	Description
mdiskgrp	<i>name</i>	=	Yes	The MDisk group name.
	<i>storage_pool_id</i> or <i>id</i>	=, <, <=, >, >=	No	The MDisk group ID.
	<i>mdisk_count</i>	=, <, <=, >, >=	No	The number of MDisks in the group.
	<i>vdisk_count</i>	=, <, <=, >, >=	No	The number of VDIs in the group.
	<i>status</i>	=	No	The status of the MDisk group. The valid input options are: <ul style="list-style-type: none"> • online • degraded • offline
	<i>extent_size</i>	=, <, <=, >, >=	No	The extent size. (MB)
vdisk	<i>vdisk_name</i> or <i>name</i>	=	Yes	The name of the VDisk.
	<i>vdisk_id</i> or <i>id</i>	=, <, <=, >, >=	No	The ID of the VDisk.
	<i>IO_group_name</i>	=	Yes	The name of the I/O group.
	<i>IO_group_id</i>	=, <, <=, >, >=	No	The ID of the I/O group.
	<i>status</i>	=	No	The status of the VDisk. <p>The valid input options for VDisk status are:</p> <ul style="list-style-type: none"> • online • degraded • offline
	<i>mdisk_grp_name</i>	=	Yes	The MDisk group name.
	<i>mdisk_grp_id</i>	=, <, <=, >, >=	No	The MDisk group ID.
	<i>capacity</i>	=, <, <=, >, >=	No	The capacity. Requires the -unit argument.
	<i>type</i>	=	No	The VDisk type. The valid value options are: <ul style="list-style-type: none"> • seq • striped • image
	<i>FC_name</i>	=	Yes	The FlashCopy mapping name.
	<i>FC_id</i>	=, <, <=, >, >=	No	The FlashCopy mapping ID.
	<i>RC_name</i>	=	Yes	The Metro Mirror relationship name.
	<i>RC_id</i>	=, <, <=, >, >=	No	The Metro Mirror relationship ID.
host	<i>host_name</i> or <i>name</i>	=	Yes	The host name.
	<i>host_id</i> or <i>id</i>	=, <, <=, >, >=	No	The host ID.
	<i>port_count</i>	=, <, <=, >, >=	No	The number of ports.
	<i>iogrp_count</i>	=, <, <=, >, >=	No	The number of I/O groups that are associated with the host.

Table 4. Valid filter attributes (continued). Valid filter attributes for the **-filtervalue** parameter.

Object	Attribute	Valid Qualifiers	Wildcard Valid	Description
fcmap	<i>FC_mapping_name</i> or <i>name</i>	=	Yes	The FlashCopy mapping name.
	<i>FC_id</i> or <i>id</i>	=, <, <=, >, >=	No	The FlashCopy mapping ID.
	<i>source_vdisk_name</i>	=	Yes	The source VDisk name.
	<i>source_vdisk_id</i>	=, <, <=, >, >=	No	The source VDisk ID.
	<i>target_vdisk_name</i>	=	Yes	The target VDisk name.
	<i>target_vdisk_id</i>	=, <, <=, >, >=	No	The target VDisk ID.
	<i>group_name</i>	=	Yes	The consistency group name.
	<i>group_id</i>	=, <, <=, >, >=	No	The consistency group ID.
	<i>status</i>	=	No	The mapping status. The following values are valid for <i>fcmap status</i> : <ul style="list-style-type: none"> • idle_or_copied • preparing • prepared • copying • stopped • suspended • stopping • empty
<i>copy_rate</i>	=, <, <=, >, >=	No	The background copy rate.	
fcconsistgrp	<i>name</i>	=	Yes	The consistency group name.
	<i>FC_group_id</i> or <i>id</i>	=, <, <=, >, >=	No	The consistency group ID.
	<i>status</i>	=	No	The consistency group status. The following values are valid for <i>fcconsistgrp status</i> : <ul style="list-style-type: none"> • idle_or_copied • preparing • prepared • copying • stopped • suspended • stopping • empty

Table 4. Valid filter attributes (continued). Valid filter attributes for the **-filtervalue** parameter.

Object	Attribute	Valid Qualifiers	Wildcard Valid	Description
rrelationship	<i>RC_rel_id</i> or <i>id</i>	=, <, <=, >, >=	No	The Metro Mirror relationship ID.
	<i>RC_rel_name</i> or <i>name</i>	=	Yes	The Metro Mirror relationship name.
	<i>master_cluster_id</i>	=, <, <=, >, >=	No	The master cluster ID.
	<i>master_cluster_name</i>	=	Yes	The master cluster name.
	<i>master_vdisk_id</i>	=, <, <=, >, >=	No	The master VDisk ID.
	<i>master_vdisk_name</i>	=	Yes	The master VDisk name.
	<i>aux_cluster_id</i>	=, <, <=, >, >=	No	The aux cluster ID.
	<i>aux_cluster_name</i>	=	Yes	The aux cluster name.
	<i>aux_vdisk_id</i>	=, <, <=, >, >=	No	The aux VDisk ID.
	<i>aux_vdisk_name</i>	=	Yes	The aux VDisk name.
	<i>primary</i>	=	No	The relationship primary. The following values are valid for <i>primary</i> : <ul style="list-style-type: none"> • master • aux
	<i>consistency_group_id</i>	=, <, <=, >, >=	No	The Metro Mirror consistency group ID.
	<i>consistency_group_name</i>	=	Yes	The Metro Mirror consistency group name.
	<i>state</i>	=	Yes	The relationship state. The following values are valid for <i>state</i> : <ul style="list-style-type: none"> • inconsistent_stopped • inconsistent_copying • consistent_stopped • consistent_synchronized • idling • idling_disconnected • inconsistent_disconnected • consistent_disconnected
<i>progress</i>	=, <, <=, >, >=	No	The progress of the initial background copy (synchronization) for the relationship.	

Table 4. Valid filter attributes (continued). Valid filter attributes for the **-filtervalue** parameter.

Object	Attribute	Valid Qualifiers	Wildcard Valid	Description
rcconsistgrp	<i>group_id or id</i>	=, <, <=, >, >=	No	The consistency group ID.
	<i>name</i>	=	Yes	The consistency group name.
	<i>master_cluster_id</i>	=, <, <=, >, >=	No	The master cluster ID.
	<i>master_cluster_name</i>	=	Yes	The master cluster name.
	<i>aux_cluster_id</i>	=, <, <=, >, >=	No	The aux cluster ID.
	<i>aux_cluster_name</i>	=	Yes	The aux cluster name.
	<i>primary</i>	=	No	The consistency group primary. The following values are valid for <i>primary</i> : <ul style="list-style-type: none"> • master • aux
	<i>state</i>	=	No	The consistency group state. The following values are valid for <i>state</i> : <ul style="list-style-type: none"> • inconsistent_stopped • inconsistent_copying • consistent_stopped • consistent_synchronized • idling • idling_disconnected • inconsistent_disconnected • consistent_disconnected • empty
<i>relationship_count</i>	=, <, <=, >, >=	No	The relationship count.	

Chapter 19. Overview of the list dump commands

The list dumps command returns a list of dumps in the appropriate directory. SAN Volume Controller dumps are contained in the following directory structure:

- **/dumps**
- **/dumps/audit**
- **/dumps/elogs**
- **/dumps/feature**
- **/dumps/iostats**
- **/dumps/iotrace**

Software upgrade packages are contained in the **/home/admin/upgrade** directory. These directories exist on every node in the cluster.

An audit log keeps track of action commands that are issued through an SSH session or from the SAN Volume Controller Console. To list the audit log files in the **/dumps/audit** directory on the current configuration node or on the designated node, issue the **svcinfolsauditlogdumps** command. To list a specified number of the most recently audited commands, issue the **svctask catauditlog**. To dump the contents of the audit log to a file on the current configuration node, issue the **svctask dumpauditlog** command. This command also clears the contents of the audit log.

Dumps that are contained in the **/dumps/elogs** directory are dumps of the contents of the error and event log at the time that the dump was taken. An error or event log dump is created by using the **svctask dumperrlog** command. This dumps the contents of the error or event log to the **/dumps/elogs** directory. If no file name prefix is supplied, the default **errlog_** is used. The full default file name is **errlog_NNNNNN_YYMMDD_HHMMSS**, where **NNNNNN** is the node front panel name. If the command is used with the **-prefix** parameter, the prefix value that is used instead of **errlog**. To list all dumps in the **/dumps/elogs** directory, issue the **svcinfolerrlogdumps** command.

Dumps contained in the **/dumps/feature** directory are dumps of the featurization log. A featurization log dump is created by using the **svctask dumpinternallog** command. This dumps the contents of the featurization log to the **/dumps/feature** directory to a file called **feature.txt**. Only one of these files exists, so every time the **svctask dumpinternallog** command is run, this file is overwritten. To list all dumps in the **/dumps/feature** directory, issue the **svcinfolfeaturedumps** command.

Dumps that are contained in the **/dumps/iostats** directory are dumps of the I/O statistics for disks on the cluster. An I/O statistics dump is created by using the **svctask startstats** command. As part of this command, you can specify a time interval for the statistics to be written to the file; the default is 15 minutes. Every time the time interval is encountered, the I/O statistics that have been collected are written to a file in the **/dumps/iostats** directory. The file names that are used for storing I/O statistics dumps are **m_stats_NNNNNN_YYMMDD_HHMMSS**, **m_stats_NNNNNN_YYMMDD_HHMMSS**, and **v_stats_NNNNNN_YYMMDD_HHMMSS**, where **NNNNNN** is the node front panel name, depending on whether the statistics are for MDisks or VDIsks. To list all dumps in the **/dumps/iostats** directory, issue the **svcinfoliostatsdumps** command.

Dumps that are contained in the **/dumps/iotrace** directory are dumps of I/O trace data. The type of data that is traced depends on the options specified by the **svctask settrace** command. The collection of the I/O trace data is started by using the **svctask starttrace** command. The I/O trace data collection is stopped when the **svctask stoptrace** command is used. It is when the trace is stopped that the data is written to the file. The file name is *prefix_NNNNNN_YYMMDD_HHMMSS*, where *prefix* is the value entered for the **-filename** parameter in the **svctask settrace** command, and *NNNNNN* is the node front panel name. To list all dumps in the **/dumps/iotrace** directory, issue the **svcinfo lsio tracedumps** command.

Dumps that are contained in the **/dumps** directory result from application abends. Such dumps are written to the **/dumps** directory. The default file names are **dump.NNNNNN.YYMMDD.HHMMSS**, where *NNNNNN* is the node front panel name. In addition to the dump file, there might be some trace files written to this directory, are named *NNNNNN.trc*.

To list all dumps in the **/dumps** directory, issue the **svcinfo ls2145dumps** command.

The final option available in the list dumps command series is the **svcinfo lssoftware dumps** command. This command lists the contents of the **/home/admin/upgrade** directory; files are copied to this directory during software upgrades.

All of the list dumps commands can accept a node identifier as input. If this identifier is not specified, the list of files on the current configuration node are displayed. If the node identifier is specified, the list of files on that node are displayed.

Because files can only be copied from the current configuration node (using secure copy), you can issue the **svctask cpdumps** command to copy the files from a nonconfiguration node to the current configuration node.

Chapter 20. Information commands

The following commands enable you display specific types of SAN Volume Controller information.

Note: IDs are assigned at run-time by the system and cannot be relied upon to be the same after configuration restoration. Therefore, use object names instead of IDs whenever possible.

caterrlog

The **caterrlog** command displays the contents of the cluster error log and event log.

Syntax

```
▶▶▶ svcinfo -- caterrlog -- [ -nohdr ] [ -delim delimiter ]
▶ [ -config ] [ -unfixed ] [ -first number_of_entries_to_return ]▶▶▶
```

Parameters

-nohdr

(Optional) By default, headings are displayed for each column of data in a concise style view, and for each item of data in a detailed style view. The **-nohdr** parameter suppresses the display of these headings.

Note: If there is no data to be displayed, headings are not displayed even if the **-nohdr** parameter is specified.

-delim *delimiter*

(Optional) By default in a concise view, all columns of data are space-separated. The width of each column is set to the maximum possible width of each item of data. In a detailed view, each item of data has its own row, and if the headers are displayed, the data is separated from the header by a space. The **-delim** parameter overrides this behavior. Valid input for the **-delim** parameter is a one-byte character. If you enter **-delim :** on the command line, the colon character (:) separates all items of data in a concise view; for example, the spacing of columns does not occur. In a detailed view, the data is separated from its header by the specified delimiter.

-config

(Optional) Specifies to list the configuration events.

-unfixed

(Optional) Specifies to list the unfixed errors.

-first *number_of_entries_to_return*

(Optional) Displays the first *x* number of entries in the log, where *x* is the number that is entered by the user. The value of *x* can be 1 - 256.

Description

This command displays a list of the specified error log entries. When no parameters are used, all error log entries are listed, to a maximum of 256 entries.

The list can be filtered to only include configuration events or unfixed errors by specifying the **-config** or **-unfixed** parameters.

The **-first** parameter results in the display of the first *x* number of records, where *x* is the number that is entered for the **-first** parameter.

Possible failures

- CMMVC5786E The action failed because the cluster is not in a stable state.
- CMMVC6252E The command failed authorization because the session SSH key is wrong or was deleted.
- CMMVC6253E The command failed authorization because the session SSH key does not have the requisite role.

An invocation example

```
svcinfo caterrlog -delim :
```

The resulting output

```
id:type:fixed:SNMP_trap_raised:error_type:node_name:sequence_number:
root_sequence_number:first_timestamp:last_timestamp:number_of_errors:error_code
0:cluster:no:no:6:node1:100:100:030407052547:030407052547:1:00981001
0:fc_card:no:no:1:node1:101:101:030407052547:030407052547:1:00073001
1:node:no:no:1:node1:102:102:030407052547:030407052547:1:00074001
0:cluster:no:no:6:node1:103:100:030407052547:030407052547:1:00981001
1:fc_card:no:no:1:node1:104:104:030407052632:030407052632:1:00073003
0:node:no:6:node1:105:105:030407082202:030407082217:2:00980500
2:remote:no:no:6:n/a:106:106:030407090117:030407090117:1:00985002
1:node:no:no:5:node1:0:0:030407052546:030407052546:1:00990383
0:cluster:no:no:5:node1:0:0:030407080630:030407080630:1:00990117
0:mdisk_grp:no:no:5:node1:0:0:030407081610:030407081610:1:00990148
128:mdisk_grp:no:no:5:node1:0:0:030407081610:030407081610:1:00990173
1:mdisk_grp:no:no:5:node1:0:0:030407081619:030407081619:1:00990148
0:vdisk:no:no:5:node1:0:0:030407081836:030407081836:1:00990169
1:vdisk:no:no:5:node1:0:0:030407081843:030407081843:1:00990169
0:vdisk:no:no:5:node1:0:0:030407081854:030407081854:1:00990169
0:vdisk:no:no:5:node1:0:0:030407082015:030407082015:1:00990169
0:vdisk:no:no:5:node1:0:0:030407082145:030407082145:1:00990169
0:vdisk:no:no:5:node1:0:0:030407082148:030407082148:1:00990169
0:vdisk:no:no:5:node1:0:0:030407082158:030407082158:1:00990169
1:vdisk:no:no:5:node1:0:0:030407082213:030407082213:1:00990169
0:host:no:no:5:node1:0:0:030407082441:030407082441:1:00990106
1:host:no:no:5:node1:0:0:030407082457:030407082457:1:00990106
2:host:no:5:node1:0:0:030407082523:030407082523:1:00990106
0:flash:no:no:5:node1:0:0:030407082704:030407082704:1:00990184
1:node:no:no:5:node1:0:0:030407082716:030407082716:1:00990501
1:node:no:no:5:node1:0:0:030407082722:030407082722:1:00990501
1:fc_const_grp:no:no:5:node1:0:0:030407083141:030407083141:1:00990204
2:fc_const_grp:no:no:5:node1:0:0:030407083143:030407083143:1:00990204
3:fc_const_grp:no:5:node1:0:0:030407083145:030407083145:1:00990204
0:flash:no:5:node1:0:0:030407083318:030407083318:1:00990185
0:flash:no:no:5:node1:0:0:030407083355:030407083355:1:00990185
0:flash:no:no:5:node1:0:0:030407085753:030407085753:1:00990185
1:remote:no:no:5:node1:0:0:030407085932:030407085932:1:00990225
2:vdisk:no:no:5:node1:0:0:030407085959:030407085959:1:00990169
3:vdisk:no:no:5:node1:0:0:030407090004:030407090004:1:00990169
4:vdisk:no:no:5:node1:0:0:030407090013:030407090013:1:00990169
2:remote:no:no:5:node1:0:0:030407090106:030407090106:1:00990225
```

```

255:rc_const_grp:no:no:5:node1:0:0:030407090323:030407090323:1:00990240
254:rc_const_grp:no:no:5:node1:0:0:030407090327:030407090327:1:00990240
253:rc_const_grp:no:no:5:node1:0:0:030407090333:030407090333:1:00990240
2:remote:no:no:5:node1:0:0:030407090442:030407090442:1:00990226
1:vdisk:no:no:5:node1:0:0:030407090820:030407090820:1:00990182
3:vdisk:no:no:5:node1:0:0:030407090825:030407090825:1:00990182

```

caterrlogbyseqnum

The **caterrlogbyseqnum** command displays all the errors with the sequence number or root cause number that has been specified by the user.

Syntax

```

>>> svcinfo -- caterrlogbyseqnum -- [-num -- sequence_number] [-root -- root_cause_number]
                                     |-----|
                                     |-----|
<<< [-nohdr] [-delim -- delimiter]

```

Parameters

-num *sequence_number*

(Required if **-root** is not specified) Specifies the sequence number to view.

-root *root_cause_number*

(Required if **-num** is not specified) Specifies the root sequence number. All errors that are marked with this root cause are displayed.

-nohdr

(Optional) By default, headings are displayed for each column of data in a concise style view, and for each item of data in a detailed style view. The **-nohdr** parameter suppresses the display of these headings.

Note: If there is no data to be displayed, headings are not displayed even if the **-nohdr** parameter is specified.

-delim *delimiter*

(Optional) By default in a concise view, all columns of data are space-separated. The width of each column is set to the maximum possible width of each item of data. In a detailed view, each item of data has its own row, and if the headers are displayed, the data is separated from the header by a space. The **-delim** parameter overrides this behavior. Valid input for the **-delim** parameter is a one-byte character. If you enter **-delim :** on the command line, the colon character (:) separates all items of data in a concise view; for example, the spacing of columns does not occur. In a detailed view, the data is separated from its header by the specified delimiter.

Description

This command displays a single error log entry, determined by the sequence number that is specified as the **-num** parameter.

If the **-root** parameter is used, the log is searched for all entries that are marked with a root cause sequence number, as specified. A list of all entries marked with this root cause is displayed.

Possible failures

- CMMVC5786E The action failed because the cluster is not in a stable state.
- CMMVC6252E The command failed authorization because the session SSH key is wrong or was deleted.
- CMMVC6253E The command failed authorization because the session SSH key does not have the requisite role.

An invocation example

```
svcinfcatterrlogbyseqnum -num 100 -delim :
```

The resulting output

```
id:type:fixed:SNMP_trap_raised:error_type:node_name:sequence_number:
root_sequence_number:first_timestamp:last_timestamp:number_of_errors:
error_code
0:cluster:no:no:6:node1:100:100:030407052547:030407052547:1:00981001
```

ls2145dumps

The **ls2145dumps** command obtains a list of node assert dumps and the associated output files from the **/dumps** directory.

Syntax

```
▶▶ svcinfo — ls2145dumps — [ -nohdr ] [ -delim delimiter ]
▶ [ node_id | node_name ] ▶▶
```

Parameters

-nohdr

(Optional) By default, headings are displayed for each column of data in a concise style view, and for each item of data in a detailed style view. The **-nohdr** parameter suppresses the display of these headings.

Note: If there is no data to be displayed, headings are not displayed even if the **-nohdr** parameter is specified.

-delim *delimiter*

(Optional) By default in a concise view, all columns of data are space-separated. The width of each column is set to the maximum possible width of each item of data. In a detailed view, each item of data has its own row, and if the headers are displayed, the data is separated from the header by a space. If you enter **-delim :** on the command line, the colon character (:) separates all items of data in a concise view; for example, the spacing of columns does not occur. In a detailed view, the data is separated from its header by the specified delimiter.

node_id | *node_name*

(Optional) Displays a list of the available dumps of the given type for the specified node ID or name. If you do not specify a node, the available dumps on the configuration node are listed.

Description

This command displays a list of node assert dumps and associated output files that are available. These dumps are created as a result of the assertion of a node. If you do not specify a node, the dumps that are available on the configuration node are listed. The command displays files from the `/dumps` directory.

Possible failures

- CMMVC5786E The action failed because the cluster is not in a stable state.
- CMMVC6252E The command failed authorization because the session SSH key is wrong or was deleted.
- CMMVC6253E The command failed authorization because the session SSH key does not have the requisite role.

An invocation example

```
svcinfo ls2145dumps -delim :
```

The resulting output

```
id:2145_filename
0:000108.trc.old
1:dump.000108.030328.144007
2:000108.trc
```

Iscozystatus

Use the `Iscozystatus` command to determine whether any file copies are currently in progress.

Syntax

```
▶▶ svcinfo — — Iscozystatus — — [ -nohdr ] —————▶
▶ [ -delim — delimiter ] —————▶▶
```

Parameters

-nohdr

(Optional) By default, headings are displayed for each column of data in a concise style view, and for each item of data in a detailed style view. The `-nohdr` parameter suppresses the display of these headings.

Note: If there is no data to be displayed, headings are not displayed even if the `-nohdr` parameter is specified.

-delim *delimiter*

(Optional) By default in a concise view, all columns of data are space-separated. The width of each column is set to the maximum possible width of each item of data. In a detailed view, each item of data has its own row, and if the headers are displayed, the data is separated from the header by a space. The `-delim` parameter overrides this behavior. Valid input for the `-delim` parameter is a one-byte character. If you enter `-delim :` on the command line, the colon character (`:`) separates all items of data in a concise view; for example, the spacing of columns does not occur. In a detailed view, the data is separated from its header by the specified delimiter.

Description

This command displays an indicator that shows if a file copy is currently in progress. Only one file can be copied in the cluster at a time.

Possible failures

- CMMVC5786E The action failed because the cluster is not in a stable state.
- CMMVC6252E The command failed authorization because the session SSH key is wrong or was deleted.
- CMMVC6253E The command failed authorization because the session SSH key does not have the requisite role.

An invocation example

```
svcinfo lscopystatus
```

The resulting output

```
status  
active
```

Iscluster

The **Iscluster** command provides a report that you can designate as a concise list or a detailed list of clusters. The list provides possible values that are applicable to the attributes that are displayed as data in the output views.

The list report can provide two styles of report:

- A list containing concise information about all clusters. (Each entry in the list corresponds to a single cluster.)
- The detailed information about a single, user-specified cluster.

Syntax

```
▶▶ svcinfo — — Iscluster — [ -filtervalue — attribute=value ] —▶  
▶ [ -nohdr ] [ -bytes ] [ -delim — delimiter ] —▶  
▶ [ object_id ] [ -filtervalue? ] —▶  
  [ object_name ]
```

Parameters

-filtervalue *attribute=value*

(Optional) Specifies a list of one or more filters. Only objects with a value that matches the filter attribute value are displayed. If a capacity is specified, the units must also be included.

Note: Some filters allow the asterisk character (*) when you enter the command. The following rules apply to the use of wildcard characters with the SAN Volume Controller CLI:

- The wildcard character is an asterisk (*).
- The command can contain a maximum of one wildcard.

- When you use a wildcard, you must enclose the filter entry within double quotation marks (""), as follows:

```
svcinfolcluster -filtervalue "name=md*"
```

-filtervalue?

(Optional) displays a list of filters that can be applied against this view. The following filter attributes are valid for the **lscluster** command:

- **cluster_name**
- **cluster_unique_id**
- **id**
- **name**

-nohdr

(Optional) By default, headings are displayed for each column of data in a concise style view, and for each item of data in a detailed style view. The **-nohdr** parameter suppresses the display of these headings.

Note: If there is no data to be displayed, headings are not displayed even if the **-nohdr** parameter is specified.

-bytes

(Optional) Specifies that you want the report to display all capacities as bytes.

-delim delimiter

(Optional) By default in a concise view, all columns of data are space-separated. The width of each column is set to the maximum possible width of each item of data. In a detailed view, each item of data has its own row, and if the headers are displayed, the data is separated from the header by a space. The **-delim** parameter overrides this behavior. Valid input for the **-delim** parameter is a one-byte character. If you enter **-delim :** on the command line, the colon character (:) separates all items of data in a concise view; for example, the spacing of columns does not occur. In a detailed view, the data is separated from its header by the specified delimiter.

object_id | object_name

(Optional) Specifies the name or ID of an object. When you use this parameter, the detailed view of the specific object is displayed and any value that you specified by the **-filtervalue** parameter is ignored. If you do not specify the *object_id | object_name* parameter, the concise view of all objects that match the filtering requirements that are specified by the **-filtervalue** parameter are displayed.

Description

This command displays a concise list or a detailed view of a cluster.

The following table shows the attribute values that can be displayed as output view data:

Table 5. Attribute values. lscluster command output view attribute values

Attribute	Possible Values
location	local, remote
statistics status	on, off
SNMP setting	none, all, hardware_only
email_state	running, stopped, invalid

Information about the remote cluster is reported by the **lscluster** command if the **mkpartnership** command has been issued from the local cluster to the remote cluster; for example, if the partnership has been at least partially established from the local cluster.

You can issue the **svcinfo lscluster** command to display a concise view of the cluster.

```
svcinfo lscluster -delim : 10030a007e5
```

where **10030a007e5** is the cluster name.

Concise view shows the fields described for remote clusters only; if the cluster **Location** is **local**, then **Partnership** and **Bandwidth** do not apply (and are not defined or provided). For a remote cluster, these fields indicate the following information:

- **Location:** remote
- **Partnership:**
 - partially_configured**
The **mkpartnership** command has only been issued from the local cluster to the remote cluster.
 - fully_configured**
The **mkpartnership** command has been issued in both directions.
- **Bandwidth:** MBps (the available bandwidth on the intercluster a link for background copy)

Possible failures

- CMMVC5786E The action failed because the cluster is not in a stable state.
- CMMVC5804E The action failed because an entity that was specified in the command does not exist.
- CMMVC6252E The command failed authorization because the session SSH key is wrong or was deleted.
- CMMVC6253E The command failed authorization because the session SSH key does not have the requisite role.

A concise invocation example

```
svcinfo lscluster -delim :
```

The concise resulting output

```
id:name:location:partnership:bandwidth:cluster_IP_address:  
cluster_service_ip_address:id_alias  
0000020062813ABA:clusterA:local:::9.20.247.210:1.1.1.1:0000020062813ABA  
0000020062006746:clusterB:remote:fully_configured:50:9.20.247.211:  
1.1.1.1:0000020062006746
```

A detailed invocation example

```
svcinfo lscluster -delim : 0000020064E05308
```

The detailed resulting output

```
id:0000020064E05308  
name:rc-cluster-20  
location:local  
partnership:  
bandwidth:
```

```

cluster_IP_address:9.71.50.32
cluster_service_IP_address:9.71.50.183
total_mdisk_capacity:2976.9GB
space_in_mdisk_grps::2976.9GB
space_allocated_to_vdisks:147.2GB
total_free_space:2828.7GB
statistics_status:on
statistics_frequency:15
required_memory:8192
cluster_locale:en_US
SNMP_setting:none
SNMP_community:
SNMP_server_IP_address:0.0.0.0
subnet_mask:255.255.254.0
default_gateway:9.71.50.1
time_zone:522 UTC
email_setting:none
email_id:
code_level:4.1.0.12 (build 5.13.0610240000)
FC_port_speed:2Gb
console_IP:9.71.49.176:9080
id_alias:0000020064C05308
gm_link_tolerance:300
gm_inter_cluster_delay_simulation:0
gm_intra_cluster_delay_simulation:0
email_server:8.53.26.131
email_server_port:25
email_reply:fred@mycompany.com
email_contact:Fred Higgins
email_contact_primary:01202 123456
email_contact_alternate:44-212-786543-4455
email_contact_location:London Banking
email_state:running
email_user_count:2inventory_mail_interval:0

```

Isclustercandidate

The **Isclustercandidate** command lists the clusters that are available for setting up a two-cluster partnership. This is a prerequisite for creating intercluster Metro or Global Mirror relationships.

Syntax

```

>>> svcinfo — — Isclustercandidate — [ -nohdr ] —————>
|
|<————— [ -delim — delimiter ] —————<<<

```

Parameters

-nohdr

(Optional) By default, headings are displayed for each column of data in a concise style view, and for each item of data in a detailed style view. The **-nohdr** parameter suppresses the display of these headings.

Note: If there is no data to be displayed, headings are not displayed even if the **-nohdr** parameter is specified.

-delim delimiter

(Optional) By default in a concise view, all columns of data are space-separated. The width of each column is set to the maximum possible

width of each item of data. In a detailed view, each item of data has its own row, and if the headers are displayed, the data is separated from the header by a space. The **-delim** parameter overrides this behavior. Valid input for the **-delim** parameter is a one-byte character. If you enter **-delim :** on the command line, the colon character (:) separates all items of data in a concise view; for example, the spacing of columns does not occur. In a detailed view, the data is separated from its header by the specified delimiter.

Description

This command displays a list of clusters that are available as candidate partner clusters to form a Metro or Global Mirror Partnership between two clusters.

Possible failures

- CMMVC5786E The action failed because the cluster is not in a stable state.
- CMMVC5804E The action failed because an entity that was specified in the command does not exist.
- CMMVC6252E The command failed authorization because the session SSH key is wrong or was deleted.
- CMMVC6253E The command failed authorization because the session SSH key does not have the requisite role.

An invocation example

```
svcinfo lsclustercandidate
```

The resulting output

id	configured	cluster_name
0000010034E0F430	no	ldcluster26

lscontroller

The **lscontroller** command returns a concise list, or a detailed view, of controllers that are visible to the cluster.

The list report style can be used to obtain two styles of report:

- A list containing concise information about controllers. (Each entry in the list corresponds to a single controller.)
- The detailed information about a single, user-specified controller.

Syntax

```
▶▶ svcinfo -- lscontroller -- [ -filtervalue -- attrib=value ] ▶▶
```

```
▶ [ -nohdr ] [ -delim -- delimiter ] [ object_id ] [ object_name ] ▶
```

```
▶ [ -filtervalue? ] ▶▶
```

Parameters

-filtervalue *attrib=value*

(Optional) Specifies a list of one or more filters. Only objects with a value that matches the filter attribute value are returned. If a capacity is specified, the units must also be included.

Note: Some filters allow the use of a wildcard when you enter the command. The following rules apply to the use of wildcards with the SAN Volume Controller CLI:

- The wildcard character is an asterisk (*).
- The command can contain a maximum of one wildcard, which must be the first or last character in the string.
- When using a wildcard, enclose the filter entry within double quotation marks (""), as follows:

```
svcinfo lscontroller -filtervalue "name=md*"
```

-nohdr

(Optional) By default, headings are displayed for each column of data in a concise style view, and for each item of data in a detailed style view. The **-nohdr** parameter suppresses the display of these headings.

Note: If there is no data to be displayed, headings are not displayed even if the **-nohdr** parameter is specified.

-delim *delimiter*

(Optional) By default in a concise view, all columns of data are space separated. The width of each column is set to the maximum possible width of each item of data. In a detailed view, each item of data has its own row, and if the headers are displayed the data is separated from the header by a space. The **-delim** parameter overrides this behavior. Valid input for the **-delim** parameter is a one byte character. If you enter `-delim :` on the command line, the colon character (:) separates all items of data in a concise view; for example, the spacing of columns does not occur. In a detailed view, the data is separated from its header by the specified delimiter.

object_id | object_name

(Optional) Specifies the name or ID of an object. When you use this parameter, the detailed view of the specific object is returned and any value that is specified by the **-filtervalue** parameter is ignored. If you do not specify the *object_id | object_name* parameter, the concise view of all objects matching the filtering requirements that is specified by the **-filtervalue** parameter are displayed.

-filtervalue?

(Optional) Displays the valid filter attributes. The following filter attributes for the **svcinfo lscontroller** command are valid:

- controller_id
- id

Description

This command returns a concise list, or a detailed view, of controllers visible to the cluster.

The following values are applicable to the data in the output views:

degraded

no, yes

To differentiate the name of a storage controller from the name shown on the cluster, list the storage controllers by issuing the **svcinfo lscontroller** command. Record the controller name or ID for the controller that you want to determine. For the controller in question, issue the **svcinfo lscontroller controller name | id** command, where *controller name | id* is the controller name or ID. Record the worldwide node name (WWNN) for the controller. You can use the WWNN to determine the actual storage controller by launching the native controller user interface, or by using the command line tools it provides to verify the actual controller that has the WWNN.

Each MDisk corresponds to a single RAID array or to a single partition on a given RAID array. Each RAID controller defines a LUN number for the disk. The LUN number and controller name or ID are required to determine the relationship between MDisks and RAID arrays or partitions. Take the following steps to determine the relationship between MDisks and RAID arrays or LUNs:

1. Show the detailed view of the given MDisk *mdiskname* by issuing the **svcinfo lsmdisk mdiskname** command, where *mdiskname* is the name of the MDisk. Record the controller name or controller ID and controller LUN number.
2. Show the detailed view of the controller by issuing the **svcinfo lscontroller controller name | id** command, where *controller name | id* is the name or ID of the controller. Record the vendor ID, product ID, and WWNN, and use them to determine the object that is being presented to the MDisk.
3. From the native user interface for the given controller, list the LUNs and match the LUN number to determine the exact RAID array or partition that corresponds to the MDisk.

Notes:

- The *path_count* is the number of MDisks using the controller port multiplied by the number nodes in the cluster.
- The *max_path_count* is the highest possible value that the *path_count* can reach for the controller type.

Possible failures

- CMMVC5786E The action failed because the cluster is not in a stable state.
- CMMVC5804E The action failed because an entity that was specified in the command does not exist.
- CMMVC6252E The command failed authorization because the session SSH key is wrong or was deleted.
- CMMVC6253E The command failed authorization because the session SSH key does not have the requisite role.

A concise invocation example

```
svcinfo lscontroller -delim :
```

The concise resulting output

```
id:controller_name:ctrl_s/n:vendor_id:product_id_low:product_id_high
7:controller7:3EK0J5Y8:SEAGATE :ST373405:FC
8:controller8:3EK0J6CR:SEAGATE :ST373405:FC
9:controller9:3EK0J4YN:SEAGATE :ST373405:FC
10:controller10:3EK0GKGH:SEAGATE :ST373405:FC
11:controller11:3EK0J85C:SEAGATE :ST373405:FC
```



```
12:controller12:3EK0JBR2:SEAGATE :ST373405:FC
13:controller13:3EKYNJF8:SEAGATE :ST373405:FC
14:controller14:3EK0HVTM:SEAGATE :ST373405:FC
```

A detailed invocation example

```
svcinfo lscontroller -delim = 7
```

The detailed resulting output

```
id=7
controller_name=controller7
WWNN=20000004CF2412AC
mdisk_link_count=1
max_mdisk_link_count=1
degraded=no
vendor_id=SEAGATE
product_id_low=ST373405
product_id_high=FC
product_revision=0003
ctrl_s/n=3EK0J5Y8
WWPN=22000004CF2412AC
path_count=1
max_path_count=1
WWPN=21000004CF2412AC
path_count=0
max_path_count=0
```

lsdiscoverystatus

Use the **lsdiscoverystatus** command to determine whether a discovery operation is in progress.

Syntax

```
▶▶▶ svcinfo — — lsdiscoverystatus — — [ -nohdr ] —————▶
▶ [ -delim — delimiter ] —————▶▶▶
```

Parameters

-nohdr

(Optional) By default, headings are displayed for each column of data in a concise style view, and for each item of data in a detailed style view. The **-nohdr** parameter suppresses the display of these headings.

Note: If there is no data to be displayed, headings are not displayed even if the **-nohdr** parameter is specified.

-delim *delimiter*

(Optional) By default in a concise view, all columns of data are space-separated. The width of each column is set to the maximum possible width of each item of data. In a detailed view, each item of data has its own row, and if the headers are displayed, the data is separated from the header by a space. The **-delim** parameter overrides this behavior. Valid input for the **-delim** parameter is a one-byte character. If you enter **-delim :** on the command line, the colon character (:) separates all items of data in a concise view; for example, the spacing of columns does not occur. In a detailed view, the data is separated from its header by the specified delimiter.

Description

This command displays one of the following results:

active There is a discovery operation in progress at the time that the command is issued.

inactive
There are no discovery operations in progress at the time that the command is issued.

Possible failures

- CMMVC5786E The action failed because the cluster is not in a stable state.
- CMMVC6252E The command failed authorization because the session SSH key is wrong or was deleted.
- CMMVC6253E The command failed authorization because the session SSH key does not have the requisite role.

An invocation example

```
svcinfo lsdiscovrystatus
```

The resulting output

```
status  
inactive
```

lserrlogbyfcconsistgrp

The **lserrlogbyfcconsistgrp** command displays errors and events in the log that are related to FlashCopy consistency groups.

Syntax

```
▶▶ svcinfo — — lserrlogbyfcconsistgrp — [ -nohdr ] —————▶  
  
▶ [ -delim — delimiter ] [ -count — number ] [ -config ] [ -unfixed ] —▶  
  
▶ [ fcconsistgrp_id ] [ fcconsistgrp_name ] —▶▶
```

Parameters

-nohdr

(Optional) By default, headings are displayed for each column of data in a concise style view, and for each item of data in a detailed style view. The **-nohdr** parameter suppresses the display of these headings.

Note: If there is no data to be displayed, headings are not displayed even if the **-nohdr** parameter is specified.

-delim *delimiter*

(Optional) By default in a concise view, all columns of data are space-separated. The width of each column is set to the maximum possible width of each item of data. In a detailed view, each item of data has its own

row, and if the headers are displayed, the data is separated from the header by a space. The **-delim** parameter overrides this behavior. Valid input for the **-delim** parameter is a one-byte character. If you enter **-delim :** on the command line, the colon character (:) separates all items of data in a concise view; for example, the spacing of columns does not occur. In a detailed view, the data is separated from its header by the specified delimiter.

-count *number*

(Optional) Specifies the maximum number of errors or events to list.

-config

(Optional) Lists only configuration events.

-unfixed

(Optional) Lists only unfixed errors.

fcconsistgrp_id | fcconsistgrp_name

(Optional) Specifies the object ID that filters the log.

Description

This command displays a list of the errors and events in the log that are related to FlashCopy consistency groups. The list can be filtered further by specifying an object ID or object name. The list displays only the errors and events that have been logged against the specified object. The list can also be filtered to show only the configuration events or the unfixed errors for the given object type or object ID. Similarly, the last *x* number of entries for a given object type or object ID can be listed.

Note: Although there is an object type of *unknown* is displayed in the error log, there is no command available to filter this object type.

Possible failures

- CMMVC5786E The action failed because the cluster is not in a stable state.
- CMMVC6252E The command failed authorization because the session SSH key is wrong or was deleted.
- CMMVC6253E The command failed authorization because the session SSH key does not have the requisite role.

An invocation example

```
svcinfo lserrlogbyfcconsistgrp -delim :
```

The resulting output

```
id:type:fixed:SNMP_trap_raised:error_type:node_name:sequence_number:  
root_sequence_number:first_timestamp:last_timestamp:number_of_errors:error_code  
3:fc_const_grp:no:no:5:node1:0:0:030407083145:030407083145:1:00990204  
2:fc_const_grp:no:no:5:node1:0:0:030407083143:030407083143:1:00990204  
1:fc_const_grp:no:no:5:node1:0:0:030407083141:030407083141:1:00990204
```

lserrlogbyfcmap

The **lserrlogbyfcmap** command displays a list of the errors and events in the log that are related to FlashCopy mappings.

Syntax

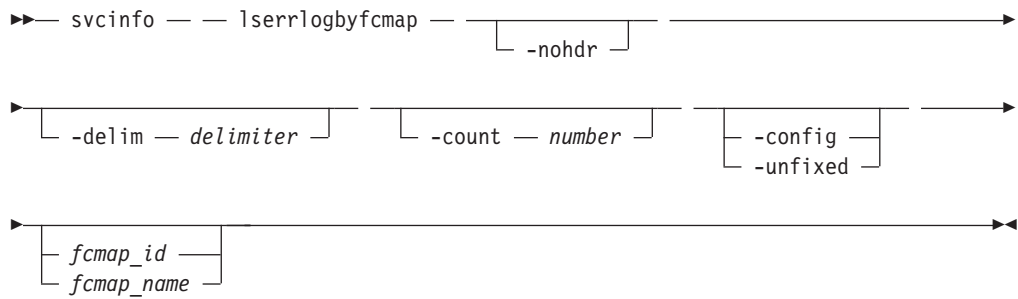

Parameters

-nohdr

(Optional) By default, headings are displayed for each column of data in a concise style view, and for each item of data in a detailed style view. The **-nohdr** parameter suppresses the display of these headings.

Note: If there is no data to be displayed, headings are not displayed even if the **-nohdr** parameter is specified.

-delim *delimiter*

(Optional) By default in a concise view, all columns of data are space-separated. The width of each column is set to the maximum possible width of each item of data. In a detailed view, each item of data has its own row, and if the headers are displayed, the data is separated from the header by a space. The **-delim** parameter overrides this behavior. Valid input for the **-delim** parameter is a one-byte character. If you enter **-delim :** on the command line, the colon character (:) separates all items of data in a concise view; for example, the spacing of columns does not occur. In a detailed view, the data is separated from its header by the specified delimiter.

-count *number*

(Optional) Specifies the maximum number of errors or events to list.

-config

(Optional) Lists only configuration events.

-unfixed

(Optional) Lists only unfixed errors.

fcmap_id | *fcmap_name*

(Optional) Specifies the object ID that filters the log.

Description

This command displays a list of the errors and events in the log that are related to FlashCopy mappings. The list can be filtered further by specifying a specific object ID or name. This list displays only the errors and events that have been logged against the specified object. The list can also be filtered to show only the configuration events or the unfixed errors for the given object type or object ID. Similarly, the last *x* entries against a given object type or object ID can be listed.

Note: Although an object type of *unknown* is displayed in the error log, there is no available command to filter this object type.

Possible failures

- CMMVC5786E The action failed because the cluster is not in a stable state.

- CMMVC6252E The command failed authorization because the session SSH key is wrong or was deleted.
- CMMVC6253E The command failed authorization because the session SSH key does not have the requisite role.

An invocation example

```
svcinfolerrlogbyfcmap -delim :
```

The resulting output

```
id:type:fixed:SNMP_trap_raised:error_type:node_name:sequence_number:
root_sequence_number:first_timestamp:last_timestamp:number_of_errors:error_code
0:flash:no:no:5:node1:0:0:030407085753:030407085753:1:00990185
0:flash:no:no:5:node1:0:0:030407083355:030407083355:1:00990185
0:flash:no:no:5:node1:0:0:030407083318:030407083318:1:00990185
0:flash:no:no:5:node1:0:0:030407082704:030407082704:1:00990184
```

Iserrlogbyhost

The **Iserrlogbyhost** command displays a list of the errors and events in the log that are related to hosts.

Syntax

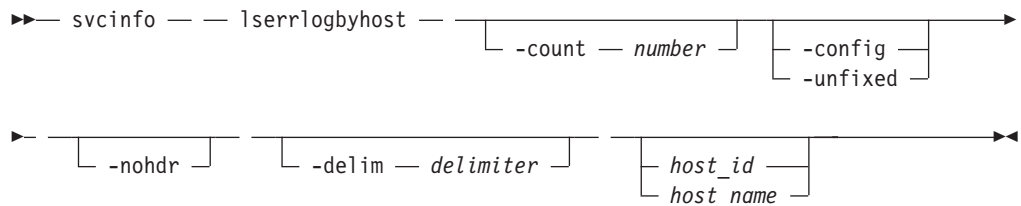

Parameters

-count *number*

(Optional) Specifies the maximum number of errors or events to list.

-config

(Optional) Lists only configuration events.

-unfixed

(Optional) Lists only unfixed errors.

-nohdr

(Optional) By default, headings are displayed for each column of data in a concise style view, and for each item of data in a detailed style view. The **-nohdr** parameter suppresses the display of these headings.

Note: If there is no data to be displayed, headings are not displayed even if the **-nohdr** parameter is specified.

-delim *delimiter*

(Optional) By default in a concise view, all columns of data are space-separated. The width of each column is set to the maximum possible width of each item of data. In a detailed view, each item of data has its own row, and if the headers are displayed, the data is separated from the header by a space. The **-delim** parameter overrides this behavior. Valid input for the **-delim** parameter is a one-byte character. If you enter **-delim :** on the command line, the colon character (:) separates all items of data in a concise

view; for example, the spacing of columns does not occur. In a detailed view, the data is separated from its header by the specified delimiter.

host_id | *host_name*

(Optional) Specifies the object ID that filters the log.

Description

This command displays a list of the errors and events in the log that are related to hosts. The list can be filtered further by specifying a specific object ID or name. This list displays only the errors and events that have been logged against the specified object. The list can also be filtered to show only the configuration events or the unfixed errors for the given object type or object ID. Similarly, the last *x* entries against a given object type or object ID can be listed.

Note: Although an object type *unknown* is displayed in the error log, there is no available command to filter this object type.

Possible failures

- CMMVC5786E The action failed because the cluster is not in a stable state.
- CMMVC6252E The command failed authorization because the session SSH key is wrong or was deleted.
- CMMVC6253E The command failed authorization because the session SSH key does not have the requisite role.

An invocation example

```
svcinfo lserrlogbyhost -delim :
```

The resulting output

```
id:type:fixed:SNMP_trap_raised:error_type:node_name:sequence_number:  
root_sequence_number:first_timestamp:last_timestamp:number_of_errors:error_code  
2:host:no:no:5:node1:0:0:030407082523:030407082523:1:00990106  
1:host:no:no:5:node1:0:0:030407082457:030407082457:1:00990106  
0:host:no:no:5:node1:0:0:030407082441:030407082441:1:00990106
```

lserrlogbyiogrp

The **lserrlogbyiogrp** command displays a list of the errors and events in the log that are related to I/O groups.

Syntax

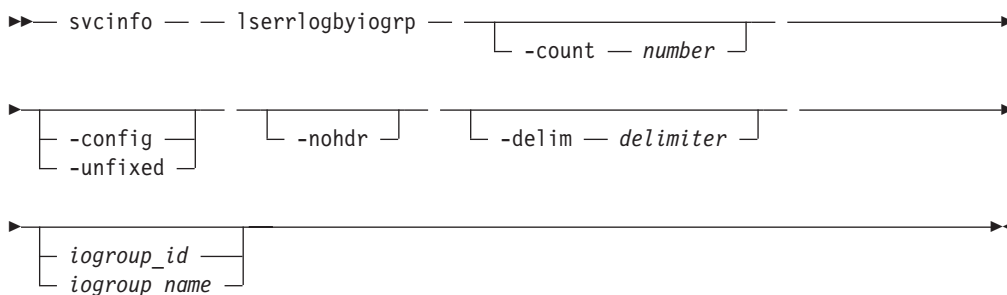

Parameters

-count *number*

(Optional) Specifies the maximum number of errors or events to list.

-config

(Optional) Lists only configuration events.

-unfixed

(Optional) Lists only unfixed errors.

-nohdr

(Optional) By default, headings are displayed for each column of data in a concise style view, and for each item of data in a detailed style view. The **-nohdr** parameter suppresses the display of these headings.

Note: If there is no data to be displayed, headings are not displayed even if the **-nohdr** parameter is specified.

-delim *delimiter*

(Optional) By default in a concise view, all columns of data are space-separated. The width of each column is set to the maximum possible width of each item of data. In a detailed view, each item of data has its own row, and if the headers are displayed, the data is separated from the header by a space. The **-delim** parameter overrides this behavior. Valid input for the **-delim** parameter is a one-byte character. If you enter **-delim :** on the command line, the colon character (:) separates all items of data in a concise view; for example, the spacing of columns does not occur. In a detailed view, the data is separated from its header by the specified delimiter.

iogroup_id | *iogroup_name*

(Optional) Specifies the object ID that filters the log.

Description

This command displays a list of the errors and events in the log that are related to I/O groups. The list can be filtered further by specifying a specific object ID or name. This list displays only the errors and events that have been logged against the specified object. The list can also be filtered to show only the configuration events or the unfixed errors for the given object type or object ID. Similarly, the last *x* entries against a given object type or object ID can be listed.

Note: Although an object type *unknown* is displayed in the error log, there is no available command to filter this object type.

Possible failures

- CMMVC5786E The action failed because the cluster is not in a stable state.
- CMMVC6252E The command failed authorization because the session SSH key is wrong or was deleted.
- CMMVC6253E The command failed authorization because the session SSH key does not have the requisite role.

An invocation example

```
svcinfo lserrlogbyiogrp -delim :
```

The resulting output

```
id:type:fixed:SNMP_trap_raised:error_type:node_name:sequence_number:
root_sequence_number:first_timestamp:last_timestamp:number_of_errors:error_code
1:io_grp:no:no:1:node1:109:109:030407094417:030407094417:1:00000001
```

Iserrlogbymdisk

The **Iserrlogbymdisk** command displays a list of the errors and events in the log that are related to a specific MDisk.

Syntax

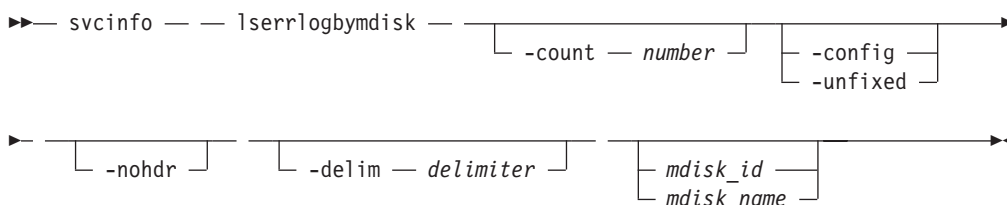

Parameters

-count *number*

(Optional) Specifies the maximum number of errors or events to list.

-config

(Optional) Lists only configuration events.

-unfixed

(Optional) Lists only unfixed errors.

-nohdr

(Optional) By default, headings are displayed for each column of data in a concise style view, and for each item of data in a detailed style view. The **-nohdr** parameter suppresses the display of these headings.

Note: If there is no data to be displayed, headings are not displayed even if the **-nohdr** parameter is specified.

-delim *delimiter*

(Optional) By default in a concise view, all columns of data are space-separated. The width of each column is set to the maximum possible width of each item of data. In a detailed view, each item of data has its own row, and if the headers are displayed, the data is separated from the header by a space. The **-delim** parameter overrides this behavior. Valid input for the **-delim** parameter is a one-byte character. If you enter **-delim :** on the command line, the colon character (:) separates all items of data in a concise view; for example, the spacing of columns does not occur. In a detailed view, the data is separated from its header by the specified delimiter.

mdisk_id | *mdisk_name*

(Optional) Specifies the object ID that filters the log.

Description

This command displays a list of the errors and events in the log that are related to a specific MDisk. The list can be filtered further by specifying a specific object ID or name. This list displays only the errors and events that have been logged against the specified object. The list can also be filtered to show only the

configuration events or the unfixed errors for the given object type or object ID. Similarly, the last *x* entries against a given object type or object ID can be listed.

Note: Although an object type *unknown* is displayed in the error log, there is no available command to filter this object type.

Possible failures

- CMMVC5786E The action failed because the cluster is not in a stable state.
- CMMVC6252E The command failed authorization because the session SSH key is wrong or was deleted.
- CMMVC6253E The command failed authorization because the session SSH key does not have the requisite role.

An invocation example

```
svcinfo lserrlogbydisk -delim :
```

The resulting output

```
id:type:fixed:SNMP_trap_raised:error_type:node_name:
sequence_number:root_sequence_number:first_timestamp:
last_timestamp:number_of_errors:error_code
11:mdisk:no:no:3:node1:108:108:030407092947:030407092947:1:00000016
11:mdisk:no:no:2:node1:107:107:030407092947:030407092947:1:00000016
```

lserrlogbydiskgrp

The **lserrlogbydiskgrp** commands display a list of the errors and events in the log that are related to MDisk groups.

Syntax

```

▶▶ svcinfo — lserrlogbydiskgrp — [ -count — number ]
[ -config ] [ -unfixed ] [ -nohdr ] [ -delim — delimiter ]
[ mdisk_group_id ] [ mdisk_group_name ]

```

Parameters

-count *number*

(Optional) Specifies the maximum number of errors or events to list.

-config

(Optional) Lists only configuration events.

-unfixed

(Optional) Lists only unfixed errors.

-nohdr

(Optional) By default, headings are displayed for each column of data in a concise style view, and for each item of data in a detailed style view. The **-nohdr** parameter suppresses the display of these headings.

Note: If there is no data to be displayed, headings are not displayed even if the **-nohdr** parameter is specified.

-delim *delimiter*

(Optional) By default in a concise view, all columns of data are space-separated. The width of each column is set to the maximum possible width of each item of data. In a detailed view, each item of data has its own row, and if the headers are displayed, the data is separated from the header by a space. The **-delim** parameter overrides this behavior. Valid input for the **-delim** parameter is a one-byte character. If you enter **-delim :** on the command line, the colon character (:) separates all items of data in a concise view; for example, the spacing of columns does not occur. In a detailed view, the data is separated from its header by the specified delimiter.

mdisk_group_id | *mdisk_group_name*

(Optional) Specifies the object ID that filters the log.

Description

The **lserrlogbymdiskgrp** command displays a list of the errors and events in the log that are related to MDisk groups. The list can be filtered further by specifying a specific object ID or name. This list displays only the errors and events that have been logged against the specified object. The list can also be filtered to show only the configuration events or the unfixed errors for the given object type or object ID. Similarly, the last *x* entries against a given object type or object ID can be listed.

Note: Although an object type *unknown* is displayed in the error log, there is no available command to filter this object type.

Possible failures

- CMMVC5786E The action failed because the cluster is not in a stable state.
- CMMVC6252E The command failed authorization because the session SSH key is wrong or was deleted.
- CMMVC6253E The command failed authorization because the session SSH key does not have the requisite role.

An invocation example

```
svcinfo lserrlogbymdiskgrp -delim :
```

The resulting output

```
id:type:fixed:SNMP_trap_raised:error_type:node_name:sequence_number:  
root_sequence_number:first_timestamp:last_timestamp:number_of_errors:error_code  
1:mdisk_grp:no:no:5:node1:0:0:030407081619:030407081619:1:00990148  
128:mdisk_grp:no:no:5:node1:0:0:030407081610:030407081610:1:00990173  
0:mdisk_grp:no:no:5:node1:0:0:030407081610:030407081610:1:00990148
```

lserrlogbynode

The **lserrlogbynode** command displays a list of the errors and events in the log that are related to nodes.

Syntax

```
▶▶ svcinfo — — lserrlogbynode — — [ -count — number ] —————▶
```

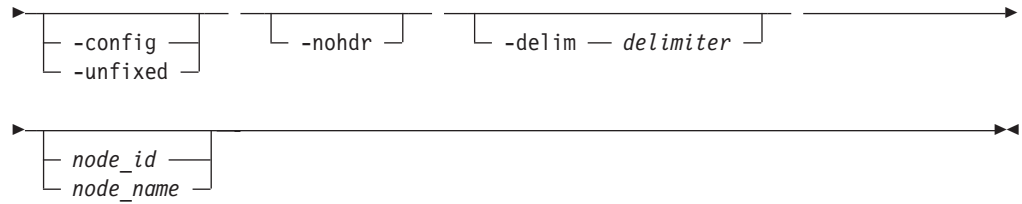

Parameters

-count *number*

(Optional) Specifies the maximum number of errors or events to list.

-config

(Optional) Lists only configuration events.

-unfixed

(Optional) Lists only unfixed errors.

-nohdr

(Optional) By default, headings are displayed for each column of data in a concise style view, and for each item of data in a detailed style view. The **-nohdr** parameter suppresses the display of these headings.

Note: If there is no data to be displayed, headings are not displayed even if the **-nohdr** parameter is specified.

-delim *delimiter*

(Optional) By default in a concise view, all columns of data are space-separated. The width of each column is set to the maximum possible width of each item of data. In a detailed view, each item of data has its own row, and if the headers are displayed, the data is separated from the header by a space. The **-delim** parameter overrides this behavior. Valid input for the **-delim** parameter is a one-byte character. If you enter `-delim :` on the command line, the colon character (`:`) separates all items of data in a concise view; for example, the spacing of columns does not occur. In a detailed view, the data is separated from its header by the specified delimiter.

node_id | *node_name*

(Optional) Specifies the object ID that filters the log.

Description

This command displays a list of the errors and events in the log that are related to nodes. The list can be filtered further by specifying a specific object ID or name. This list displays only the errors and events that have been logged against the specified object. The list can also be filtered to show only the configuration events or the unfixed errors for the given object type or object ID. Similarly, the last *x* entries against a given object type or object ID can be listed.

Note: Although an object type *unknown* is displayed in the error log, there is no available command to filter this object type.

Possible failures

- CMMVC5786E The action failed because the cluster is not in a stable state.
- CMMVC6252E The command failed authorization because the session SSH key is wrong or was deleted.

- CMMVC6253E The command failed authorization because the session SSH key does not have the requisite role.

An invocation example

```
svcinfolerrlogbynode -delim :
```

The resulting output

```
id:type:fixed:SNMP_trap_raised:error_type:node_name:sequence_number:
root_sequence_number:first_timestamp:last_timestamp:number_of_errors:error_code
1:node:no:no:5:node1:0:0:030407082722:030407082722:1:00990501
1:node:no:no:5:node1:0:0:030407082716:030407082716:1:00990501
1:node:no:no:5:node1:0:0:030407052546:030407052546:1:00990383
0:node:no:no:6:node1:105:105:030407082202:030407082717:2:00980500
1:node:no:no:1:node1:102:102:030407052547:030407052547:1:00074001
```

lerrlogbyrconsistgrp

You can use the **lerrlogbyrconsistgrp** command to display the error log by Metro or Global Mirror consistency groups.

Syntax

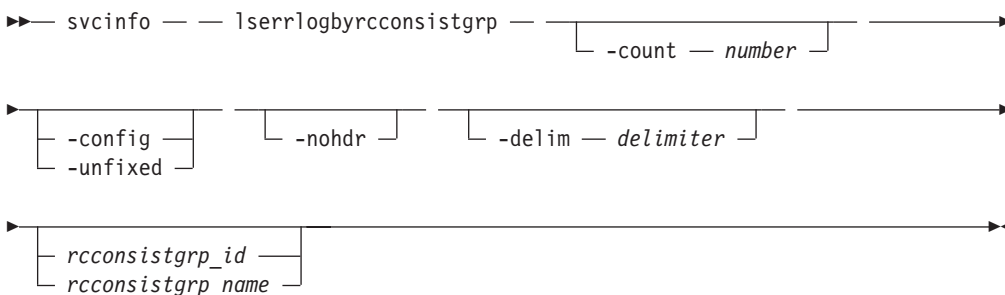

Parameters

-count *number*

(Optional) Specifies the maximum number of errors or events to list.

-config

(Optional) Lists only configuration events.

-unfixed

(Optional) Lists only unfixed errors.

-nohdr

(Optional) By default, headings are displayed for each column of data in a concise style view, and for each item of data in a detailed style view. The **-nohdr** parameter suppresses the display of these headings.

Note: If there is no data to be displayed, headings are not displayed even if the **-nohdr** parameter is specified.

-delim *delimiter*

(Optional) By default in a concise view, all columns of data are space-separated. The width of each column is set to the maximum possible width of each item of data. In a detailed view, each item of data has its own row, and if the headers are displayed, the data is separated from the header by a space. The **-delim** parameter overrides this behavior. Valid input for the **-delim** parameter is a one-byte character. If you enter **-delim :** on the

command line, the colon character (:) separates all items of data in a concise view; for example, the spacing of columns does not occur. In a detailed view, the data is separated from its header by the specified delimiter.

rcconsistgrp_id | *rcconsistgrp_name*

(Optional) Specifies the object ID that filters the log.

Description

This command displays a list of the errors and events in the log by Metro or Global Mirror consistency groups. The list can be filtered further by specifying a specific object ID or name. This displays only the errors and events that have been logged against the specified object. The list can also be filtered to show only the configuration events or the unfixed errors for the given object type or object ID. Similarly, the last *x* entries against a given object type or object ID can be listed.

Note: Although an object type *unknown* is displayed in the error log, there is no available command for this object type.

Possible failures

- CMMVC5786E The action failed because the cluster is not in a stable state.
- CMMVC6252E The command failed authorization because the session SSH key is wrong or was deleted.
- CMMVC6253E The command failed authorization because the session SSH key does not have the requisite role.

An invocation example

```
svcinfo lserrlogbyrcconsistgrp -delim :
```

The resulting output

```
id:type:fixed:SNMP_trap_raised:error_type:node_name:sequence_number:
root_sequence_number:first_timestamp:last_timestamp:number_of_errors:error_code
253:rc_const_grp:no:no:5:node1:0:0:030407090333:030407090333:1:00990240
254:rc_const_grp:no:no:5:node1:0:0:030407090327:030407090327:1:00990240
255:rc_const_grp:no:no:5:node1:0:0:030407090323:030407090323:1:00990240
```

lserrlogbyrcrelationship

The **lserrlogbyrcrelationship** command displays a list of the errors and events in the log by to Metro or Global Mirror relationships.

Syntax

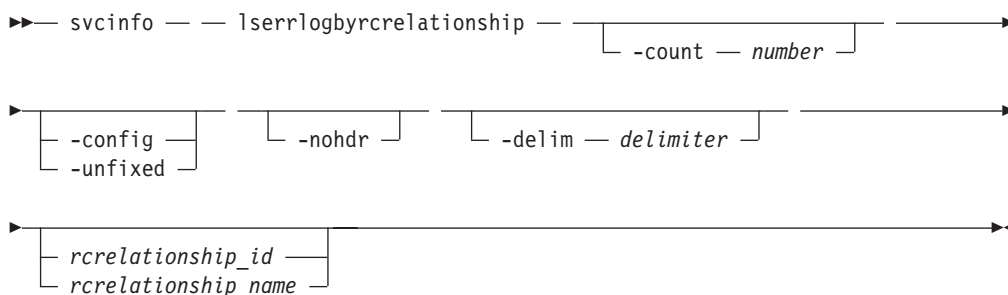

Parameters

-count *number*

(Optional) Specifies the maximum number of errors or events to list.

-config

(Optional) Lists only configuration events.

-unfixed

(Optional) Lists only unfixed errors.

-nohdr

(Optional) By default, headings are displayed for each column of data in a concise style view, and for each item of data in a detailed style view. The **-nohdr** parameter suppresses the display of these headings.

Note: If there is no data to be displayed, headings are not displayed even if the **-nohdr** parameter is specified.

-delim *delimiter*

(Optional) By default in a concise view, all columns of data are space-separated. The width of each column is set to the maximum possible width of each item of data. In a detailed view, each item of data has its own row, and if the headers are displayed, the data is separated from the header by a space. The **-delim** parameter overrides this behavior. Valid input for the **-delim** parameter is a one-byte character. If you enter **-delim :** on the command line, the colon character (:) separates all items of data in a concise view; for example, the spacing of columns does not occur. In a detailed view, the data is separated from its header by the specified delimiter.

rrelationship_id | *rrelationship_name*

(Optional) Specifies the object ID that filters the log.

Description

This command displays a list of the errors and events in the log by Metro or Global Mirror relationships. The list can be filtered further by specifying a specific object ID or name. This displays only the errors and events that have been logged against the specified object. The list can also be filtered to show only the configuration events or the unfixed errors for the given object type or object ID. Similarly the last *x* entries against a given object type or object ID can be listed.

Note: Although an object type *unknown* is displayed in the error log, there is no available command to filter this object type.

Possible failures

- CMMVC5786E The action failed because the cluster is not in a stable state.
- CMMVC6252E The command failed authorization because the session SSH key is wrong or was deleted.
- CMMVC6253E The command failed authorization because the session SSH key does not have the requisite role.

An invocation example

```
svcinfo lserrlogbyrrelationship -delim :
```

The resulting output

```

id:type:fixed:SNMP_trap_raised:error_type:node_name:sequence_number:
root_sequence_number:first_timestamp:last_timestamp:number_of_errors:error_code
2:remote:no:no:5:node1:0:0:030407090442:030407090442:1:00990226
2:remote:no:no:5:node1:0:0:030407090106:030407090106:1:00990225
1:remote:no:no:5:node1:0:0:030407085932:030407085932:1:00990225
2:remote:no:no:6:n/a:106:106:030407090117:030407090117:1:00985002

```

Iserrlogbyvdisk

The **Iserrlogbyvdisk** command displays a list of the errors and events in the log by VDIs.

Syntax

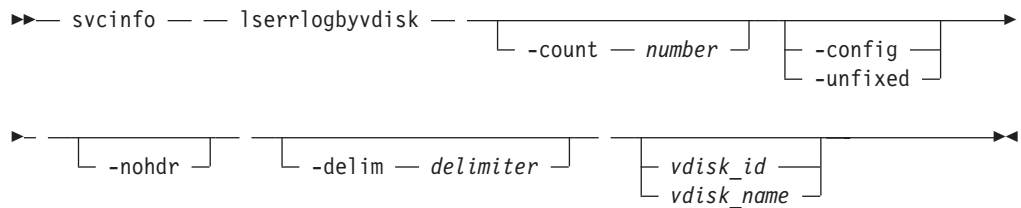

Parameters

-count *number*

(Optional) Specifies the maximum number of errors or events to list.

-config

(Optional) Lists only configuration events.

-unfixed

(Optional) Lists only unfixed errors.

-nohdr

(Optional) By default, headings are displayed for each column of data in a concise style view, and for each item of data in a detailed style view. The **-nohdr** parameter suppresses the display of these headings.

Note: If there is no data to be displayed, headings are not displayed even if the **-nohdr** parameter is specified.

-delim *delimiter*

(Optional) By default in a concise view, all columns of data are space-separated. The width of each column is set to the maximum possible width of each item of data. In a detailed view, each item of data has its own row, and if the headers are displayed, the data is separated from the header by a space. The **-delim** parameter overrides this behavior. Valid input for the **-delim** parameter is a one-byte character. If you enter **-delim :** on the command line, the colon character (:) separates all items of data in a concise view; for example, the spacing of columns does not occur. In a detailed view, the data is separated from its header by the specified delimiter.

vdisk_id | *vdisk_name*

(Optional) Specifies the object ID that filters the log.

Description

This command displays a list of the errors and events in the log by VDIs. The list can be filtered further by specifying a specific object ID or name. This list

displays only the errors and events that have been logged against the specified object. The list can also be filtered to show only the configuration events or the unfixed errors for the given object type or object ID. Similarly, the last *x* entries against a given object type or object ID can be listed.

Note: Although an object type *unknown* is displayed in the error log, there is no available command to filter this object type.

Possible failures

- CMMVC5786E The action failed because the cluster is not in a stable state.
- CMMVC6252E The command failed authorization because the session SSH key is wrong or was deleted.
- CMMVC6253E The command failed authorization because the session SSH key does not have the requisite role.

An invocation example

```
svcinfolerrlogbyvdisk -delim :
```

The resulting output

```
id:type:fixed:SNMP_trap_raised:error_type:node_name:sequence_number:
root_sequence_number:first_timestamp:last_timestamp:number_of_errors:error_code
3:vdisk:no:no:5:node1:0:0:030407090825:030407090825:1:00990182
1:vdisk:no:no:5:node1:0:0:030407090820:030407090820:1:00990182
4:vdisk:no:no:5:node1:0:0:030407090013:030407090013:1:00990169
3:vdisk:no:no:5:node1:0:0:030407090004:030407090004:1:00990169
2:vdisk:no:no:5:node1:0:0:030407085959:030407085959:1:00990169
1:vdisk:no:no:5:node1:0:0:030407082213:030407082213:1:00990169
0:vdisk:no:no:5:node1:0:0:030407082158:030407082158:1:00990169
0:vdisk:no:no:5:node1:0:0:030407082148:030407082148:1:00990169
0:vdisk:no:no:5:node1:0:0:030407082145:030407082145:1:00990169
0:vdisk:no:no:5:node1:0:0:030407082015:030407082015:1:00990169
0:vdisk:no:no:5:node1:0:0:030407081854:030407081854:1:00990169
1:vdisk:no:no:5:node1:0:0:030407081843:030407081843:1:00990169
0:vdisk:no:no:5:node1:0:0:030407081836:030407081836:1:00990169
```

lserrlogdumps

The **lserrlogdumps** commands display a list of error log dumps in the `/dumps/elogs` directory. These dumps are created as a result of the **svctask dumperrlog** command.

Syntax

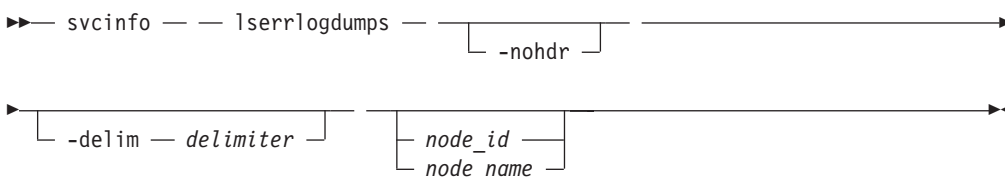

Parameters

-nohdr

(Optional) By default, headings are displayed for each column of data in a concise style view, and for each item of data in a detailed style view. The **-nohdr** parameter suppresses the display of these headings.

Note: If there is no data to be displayed, headings are not displayed even if the **-nohdr** parameter is specified.

-delim *delimiter*

(Optional) By default in a concise view, all columns of data are space-separated. The width of each column is set to the maximum possible width of each item of data. In a detailed view, each item of data has its own row, and if the headers are displayed, the data is separated from the header by a space. The **-delim** parameter overrides this behavior. Valid input for the **-delim** parameter is a one-byte character. If you enter **-delim :** on the command line, the colon character (:) separates all items of data in a concise view; for example, the spacing of columns does not occur. In a detailed view, the data is separated from its header by a colon character.

node_id | node_name

(Optional) Specifies the node ID or name to list the available dumps of the given type. If you do not specify a node, the dumps that are available on the configuration node are listed.

Description

This command displays a list of error log dumps. These dumps are created as a result of the **svctask dumperrlog** command. An error log dump describes the contents of the error log at the time that the command was issued. If you do not specify a node, the dumps that are available on the configuration node are listed. The command displays files from the **/dumps/elogs** directory.

Possible failures

- CMMVC5786E The action failed because the cluster is not in a stable state.
- CMMVC6252E The command failed authorization because the session SSH key is wrong or was deleted.
- CMMVC6253E The command failed authorization because the session SSH key does not have the requisite role.

An invocation example

```
svcinfolerrlogdumps
```

The resulting output

id	filename
0	errlog_lynn02_030327_154511
1	aaa.txt_lynn02_030327_154527
2	aaa.txt_lynn02_030327_154559
3	errlog_lynn02_030403_110628

lsfabric

The **lsfabric** command generates a report that displays the connectivity between nodes and other controllers and hosts.

Syntax

▶— `svcinfolfabric` —▶

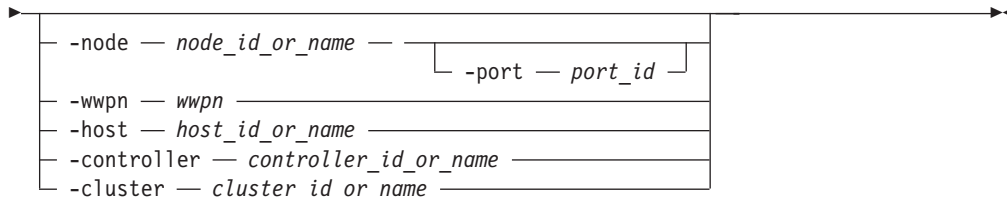

Parameters

-node *node_id_or_name*

(Optional) Specifies that you want to display the output for all ports of a specified node. You cannot use the **-node** parameter with any of the other parameters in this command except the **-port** parameter.

-port *port_id*

(Optional) Specifies a port ID. An optional parameter that can only be used together with the **-node** parameter. When the **-port** parameter is used with the **-node** parameter, a report is generated that displays a concise view of all the WWPNS that are currently logged into the designated node and port. Valid data is a number in the range 1 - 4 that matches the port with the same number in the vital product data (VPD) or the actual hexadecimal WWPNS of the local port.

-wwpn *wwpn*

(Optional) Specifies that you want to view a report that displays a list of all ports that have a login to the specified WWPNS. You cannot use the **-wwpn** parameter with any other parameter in this command.

-host *host_id_or_name*

(Optional) Specifies a host name or ID. Issuing the **lsfabric** command with the **-host** parameter is equivalent to issuing the **svcinfo lsfabric -wwpn wwpn** command for every configured WWPNS of the specified host. For example, a host with 2 ports that are zoned to 1 port of every node in a 8 node cluster produces 16 lines of output. You cannot use the **-host** parameter with any other parameter in this command.

-controller *controller_id_or_name*

(Optional) Specifies a controller ID or name. You cannot use the **-controller** parameter with any other parameter in this command. Issuing the **lsfabric** command with the **-controller** parameter is equivalent to issuing the **svcinfo lsfabric -wwpn wwpn** command for every configured WWPNS of the specified controller. For example, a controller with 4 ports connected to a 8 node cluster with 2 counter part SANs produces 64 lines of output.

-cluster *cluster_id_or_name*

(Optional) Specifies a cluster ID or name. You cannot use the **-cluster** parameter with any other parameter in this command. Issuing the **lsfabric** command with the **-cluster** parameter is equivalent to issuing the **svcinfo lsfabric -wwpn wwpn** command for every known WWPNS in the specified cluster. Output is sorted by remote WWPNS and then cluster WWPNS. This command can be used to check the state of connections within the local cluster or between the local and remote cluster. When the local cluster ID or name is specified, each node-to-node connection is listed twice: once from each end. For example, an 8 node cluster with 2 counter part SANs produces 8 nodes x 7 other nodes x 2 SANs x 4 point-to-point logins = 448 lines of output.

Description

This command can be issued with any of the parameters as described above in order to display a limited subset of information.

If the command is issued without any parameters, it provides output for every node.

Values for the type and state fields are:

state active

This value means the following depending on the item you are dealing with:

- **host** - SCSI commands were issued within the last 5 minutes.
- **node** - node ports can see other ports.
- **controllers** - commands were issued within the last 10 seconds.

state inactive

No transactions have completed within the last 5 minutes.

type One of the following values is displayed: host/node/controller/node/unknown

You can issue this command if you want to view all the information about the connections available to your cluster.

Possible failures

- CMMVC5786E The action failed because the cluster is not in a stable state.
- CMMVC5804E The action failed because an object that was specified in the command does not exist.
- CMMVC6252E The command failed authorization because the session SSH key is wrong or was deleted.
- CMMVC6253E The command failed authorization because the session SSH key does not have the requisite role.

An invocation example

```
svcinfo lsfabric -delim :
```

The resulting output Each row of output will contain the following columns:

```
remote_wwpn: remote_nportid:  
  local_wwpn: local_port:  
  local_nportid: state: name: type
```

lsfcconsistgrp

The **lsfcconsistgrp** command returns a concise list or a detailed view of FlashCopy consistency groups that are visible to the cluster. This information is useful for tracking FlashCopy consistency groups.

The list report style can be used to obtain two styles of report:

- A list containing concise information about all of the FlashCopy consistency groups on a cluster. (Each entry in the list corresponds to a single FlashCopy consistency group.)
- The detailed information about a single FlashCopy consistency group.

Syntax

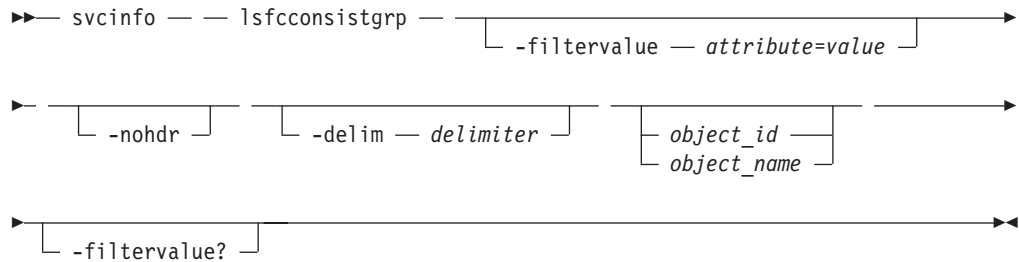

Parameters

-filtervalue *attribute=value*

(Optional) Specifies a list of one or more filters. Only objects with a value that matches the filter attribute value are returned.

Note: Some filters allow the use of a wildcard when you enter the command. The following rules apply to the use of wildcards with the SAN Volume Controller CLI:

- The wildcard character is an asterisk character (*).
- The command can contain a maximum of one wildcard, which must be the first or last character in the string.
- When using a wildcard, surround the filter entry with double quotation marks (""), as follows:

```
svcinfo lsfcconsistgrp -filtervalue "name=md*"
```

-nohdr

(Optional) By default, headings are displayed for each item of data in a concise view. The **-nohdr** parameter suppresses the display of these headings. Detailed view is not valid for this command.

Note: By default, if there is no data to be displayed, headings are not displayed.

-delim *delimiter*

(Optional) By default in a concise view, all columns of data are space-separated. The width of each column is set to the maximum possible width of each item of data. In a detailed view, each item of data has its own row, the headers are displayed, and the data is separated from the header by a space. The **-delim** parameter overrides this behavior. Valid input for the **-delim** parameter is a one byte character. If you enter **-delim :** on the command line, the colon character (:) separates all items of data in a concise view; the spacing of columns does not occur. In a detailed view, the data is separated from its header by the specified delimiter.

object_id | *object_name*

(Optional) Specifies the name or ID of an object. When you use this parameter, the detailed view of the specific object is returned and any value that is specified by the **-filtervalue** parameter returns an error message. If you do not specify the *object_id* or *object_name* parameter, the concise view of all objects matching the filtering requirements that is specified by the **-filtervalue** parameter are displayed.

-filtervalue?

(Optional) Displays the list of valid filter attributes in the report. The valid filter attributes for the `svcinfo lsfcconsistgrp` command are:

- **name**
- **id**
- **status**
- **FC_group_id**
- **empty**

Description

This command returns a concise list or a detailed view of FlashCopy consistency groups that are visible to the cluster.

The following list provides values of the *status* attribute that are displayed as data in the output views:

status **empty, idle_or_copied, preparing, prepared, copying, stopped, suspended, stopping**

Possible failures

- CMMVC5786E The action failed because the cluster is not in a stable state.
- CMMVC5804E The action failed because an entity that was specified in the command does not exist.
- CMMVC6070E A parameter that is duplicate or not valid, an unaccompanied argument, or an incorrect argument sequence has been detected. Ensure that the input is as per the help.
- CMMVC6252E The command failed authorization because the session SSH key is wrong or was deleted.
- CMMVC625 3E The command failed authorization because the session SSH key does not have the requisite role.

A concise invocation example

```
svcinfo lsfcconsistgrp -delim :
```

The concise resulting output

```
id:name:status  
1:ffccg0:empty  
2:ffccg1:idle_or_copied  
3:ffccg2:idle_or_copied
```

A detailed invocation example

```
svcinfo lsfcconsistgrp -delim : 1
```

The detailed resulting output

```
id:1  
name:ffccg0  
status:empty
```

lsfcmap

The **lsfcmap** command generates a list containing concise information about all of the FlashCopy mappings that are visible to the cluster, or detailed information for a single FlashCopy mapping.

The list report can generate two styles of report:

- A list containing concise information about all of the FlashCopy mappings that are visible to the cluster. (Each entry in the list corresponds to a single FlashCopy mapping.)
- The detailed information about a single FlashCopy Mapping.

Syntax

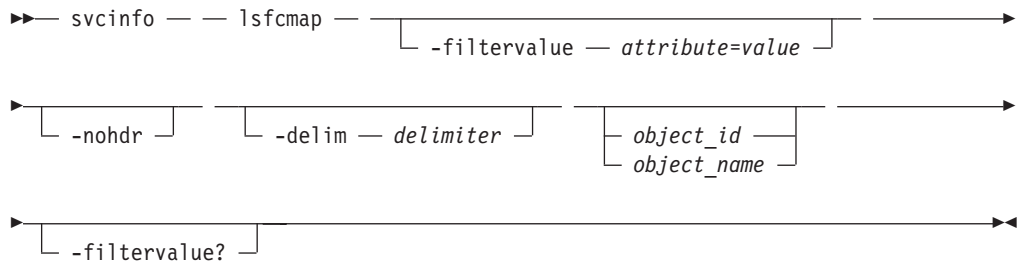

Parameters

-filtervalue *attribute=value*

(Optional) Specifies a list of one or more filters. Only objects with a value that matches the filter attribute value are displayed.

Note: Some filters allow the use of a wildcard when you enter the command. The following rules apply to the use of wildcards with the SAN Volume Controller CLI:

- The wildcard character is the asterisk (*), which must be used as the first or last character in the string.
- The command can contain a maximum of one wildcard.
- When you use a wildcard, enclose the filter entry within double quotation marks (""), as follows:

```
svcinfo lsfcmap -filtervalue "name=md*"
```

-filtervalue?

(Optional) Displays the valid filter attributes for the **-filtervalue** *attribute=value* parameter:

- name
- id
- source_vdisk_id
- source_vdisk_name
- target_vdisk_id
- target_vdisk_name
- group_name
- group_id
- status
- copy_rate

- FC_mapping_name
- FC_id
- incremental
- incremental

-nohdr

(Optional) By default, headings are displayed for each column of data in a concise style view, and for each item of data in a detailed style view. The **-nohdr** parameter suppresses the display of these headings.

Note: If there is no data to be displayed, headings are not displayed even if the **-nohdr** parameter is specified.

-delim *delimiter*

(Optional) By default in a concise view, all columns of data are space-separated. The width of each column is set to the maximum possible width of each item of data. In a detailed view, each item of data has its own row, and if the headers are displayed the data is separated from the header by a space. The **-delim** parameter overrides this behavior. Valid input for the **-delim** parameter is a one-byte character. If you enter **-delim :** on the command line, the colon character (:) separates all items of data in a concise view; for example, the spacing of columns does not occur. In a detailed view, the data is separated from its header by the specified delimiter.

object_id | *object_name*

(Optional) Specifies the name or ID of an object. When you use this parameter, the detailed view of the specific object is returned and any value that is specified by the **-filtervalue** parameter is ignored. If you do not specify the **-object_ID** or **object_name** parameter, the concise view of all objects matching the filtering requirements that is specified by the **-filtervalue** parameter are displayed.

Description

This command returns a concise list or a detailed view of FlashCopy mappings that are visible to the cluster.

The following list provides possible values that are applicable to the attributes that are displayed as data in the output views:

status idle_or_copied, preparing, prepared, copying, stopped, suspended or stopping

start_time

Displays the time that the copy was last started, in the format *YYMMDDHHMMSS*. If a copy has not been started, a blank line is displayed.

Possible failures

- CMMVC5786E The action failed because the cluster is not in a stable state.
- CMMVC5804E The action failed because an entity that was specified in the command does not exist.
- CMMVC6252E The command failed authorization because the session SSH key is not valid or was deleted.
- CMMVC6253E The command failed authorization because the session SSH key does not have the requisite role.

A concise invocation example

```
svcinfc lsfcmap -delim :
```

The concise resulting output

```
| id:name:source_vdisk_id:source_vdisk_name:target_vdisk_id:target_vdisk_name:
| group_id:group_name:status:progress:copy_rate:clean_progress:incremental
| 0:fcmap0:63:vdisk63:57:vdisk57:::idle_or_copied:0:0:100:off
| 1:fcmap1:64:vdisk64:58:vdisk58:::idle_or_copied:0:0:100:on
```

A detailed invocation example

```
svcinfc lsfcmap -delim : 0
```

The detailed resulting output

```
| id:0
| name:fcmap0
| source_vdisk_id:63
| source_vdisk_name:vdisk63
| target_vdisk_id:57
| target_vdisk_name:vdisk57
| group_id:
| group_name:
| status:idle_or_copied
| progress:0
| copy_rate:0
| start_time:
| dependent_mappings:0
| autodelete:off
| clean_progress:100
| clean_rate:50
| incremental:off
| difference:100
| grain_size:256
| IO_group_id:1
| IO_group_name:io_grp1
```

lsfcmapcandidate

The **lsfcmapcandidate** command lists all of the VDisks that are associated with fewer than 16 FlashCopy mappings.

Syntax

```
▶▶— svcinfc — — lsfcmapcandidate — — [ -nohdr ] —————▶
|
| [ -delim — delimiter ] —————▶▶
```

Parameters

-nohdr

(Optional) By default, the heading is displayed for the column of data in a concise style view, and for the item of data in a detailed style view. The **-nohdr** parameter suppresses the display of the heading.

Note: By default, if there is no data to be displayed, the heading is not displayed.

-delim *delimiter*

(Optional) By default in a concise view, all columns of data are space-separated. The width of each column is set to the maximum possible width of each item of data. In a detailed view, each item of data has its own row, and if the headers are displayed, the data is separated from the header by a space. The **-delim** parameter overrides this behavior. Valid input for the **-delim** parameter is a one-byte character. If you enter **-delim :** on the command line, a colon character (:) separates all items of data in a concise view; the spacing of columns does not occur. In a detailed view, the data is separated from its header by the specified delimiter.

Description

This command returns a list of VDisks that are associated with fewer than 16 FlashCopy mappings.

Possible failures

- CMMVC5786E The action failed because the cluster is not in a stable state.
- CMMVC5804E The action failed because an entity that was specified in the command does not exist.
- CMMVC6252E The command failed authorization because the session SSH key is wrong or was deleted.
- CMMVC6253E The command failed authorization because the session SSH key does not have the requisite role.

An invocation example

```
svcinfo lsfcmapcandidate
```

The resulting output

```
id  
2  
3  
4
```

lsfcmapprogress

The **lsfcmapprogress** command returns the progress of the background copy of a FlashCopy mapping. This is displayed as a percentage completed value.

Syntax

```
▶▶ svcinfo — — lsfcmapprogress — — [ -nohdr ] —————▶  
  
▶ [ -delim — delimiter ] [ fcmapping_id ] [ fcmapping_name ] —————▶
```

Parameters

-nohdr

(Optional) By default, headings are displayed for each item of data in a detailed style view. The **-nohdr** parameter suppresses the display of these headings.

Note: By default, if there is no data to be displayed, headings are not displayed.

-delim *delimiter*

(Optional) By default, all columns of data are space-separated. The width of each column is set to the maximum possible width of each item of data. In a detailed view, each item of data has its own row, and if the headers are displayed the data is separated from the header by a space. The **-delim** parameter overrides this behavior. Valid input for the **-delim** parameter is a one byte character. If you enter `-delim :` on the command line, the data is separated from its header by a colon character (:).

fcmap_id | *fcmap_name*

(Required) Specifies that you want the report to display the progress of the background copy for the designated FlashCopy mapping.

Description

This command reports a percentage for the progress of the background copy being done on the specified FlashCopy mapping.

Possible failures

- CMMVC5786E The action failed because the cluster is not in a stable state.
- CMMVC5804E The action failed because an entity that was specified in the command does not exist.
- CMMVC5805E The progress information was not returned because the FlashCopy statistics are not ready yet.
- CMMVC6252E The command failed authorization because the session SSH key is wrong or was deleted.
- CMMVC6253E The command failed authorization because the session SSH key does not have the requisite role.

An invocation example

```
svcinfo lsfcmapprogress 0
```

The resulting output

```
id           progress
0            0
```

lsfcmapdependentmaps

The **lsfcmapdependentmaps** command displays all the FlashCopy mappings that are dependent on the user specified mapping.

Syntax

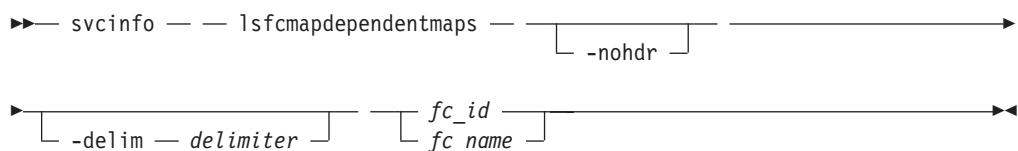

Parameters

-nohdr

(Optional) By default, headings are displayed for each column of data in a concise style view, and for each item of data in a detailed style view. The **-nohdr** parameter suppresses the display of these headings.

Note: If there is no data to be displayed, headings are not displayed even if the **-nohdr** parameter is specified.

-delim *delimiter*

(Optional) By default in a concise view, all columns of data are space-separated. The width of each column is set to the maximum possible width of each item of data. In a detailed view, each item of data has its own row, and if the headers are displayed the data is separated from the header by a space. The **-delim** parameter overrides this behavior. Valid input for the **-delim** parameter is a one byte character. If you enter **-delim :** on the command line, the colon character (:) separates all items of data in a concise view; for example, the spacing of columns does not occur. In a detailed view, the data is separated from its header by the specified delimiter.

fc_id | *fc_name*

(Required) Specifies the name or ID of the FlashCopy mapping to list the dependent maps for.

Description

This command returns a list of dependent FlashCopy mappings. This command can be used to determine the list of FlashCopy mappings that would also stop if you stopped a mapping using the **-force** parameter.

There is a `dependent_mapping_count` field in the FlashCopy map detailed view (displayed when you process the **lsfcmap** command) that you can use as an indicator as to whether there are any dependent mappings in progress. If the count is zero, there are no dependent copies.

Note: If a period time elapses between the time you process the **lsfcmap** command and the **lsfcmapdependentmaps** command, there could be a difference between the actual number of dependent mappings being processed and the number that was reported by the **lsfcmap** command.

A concise invocation example

```
svcinfc lsfcmapdependentmaps -delim : 2
```

The resulting output

```
fc_id:fc_name  
1:fcmap1  
3:fcmap3
```

lsfeaturedumps

The **lsfeaturedumps** command displays a list of dump files in the `/dumps/feature` directory. These dump files are created as a result of the **svctask dumpinternallog** command.

Syntax

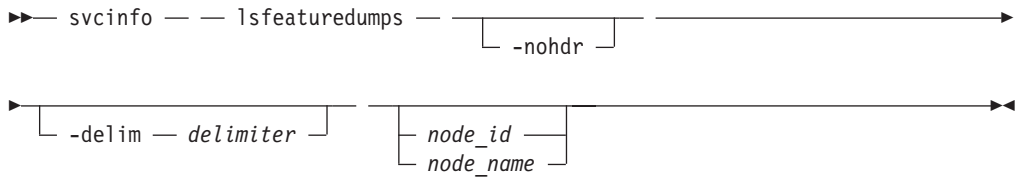

Parameters

-nohdr

(Optional) By default, headings are displayed for each column of data in a concise style view, and for each item of data in a detailed style view. The **-nohdr** parameter suppresses the display of these headings.

Note: If there is no data to be displayed, headings are not displayed even if the **-nohdr** parameter is specified.

-delim *delimiter*

(Optional) By default in a concise view, all columns of data are space-separated. The width of each column is set to the maximum possible width of each item of data. In a detailed view, each item of data has its own row, and if the headers are displayed, the data is separated from the header by a space. The **-delim** parameter overrides this behavior. Valid input for the **-delim** parameter is a one-byte character. If you enter **-delim :** on the command line, the colon character (:) separates all items of data in a concise view; for example, the spacing of columns does not occur. In a detailed view, the data is separated from its header by the specified delimiter.

node_id | *node_name*

(Optional) Specifies the node ID or node name to list the available dumps of the given type. If you do not specify a node, the dumps that are available on the configuration node are listed.

Description

This command displays a list of featurization dumps. These dumps are created as a result of issuing the **svctask dumpinternallog** command. A featurization dump file describes the contents of the featurization log at the time that the command was issued. If you do not specify a node, the dumps that are available on the configuration node are listed. The command displays files from the **/dumps/feature** directory.

Issue the **svcinfo lsfeaturedumps** command to display a list of dumps in the **/dumps/feature** destination directory. The feature log is maintained by the cluster. The feature log records events that are generated when license parameters are entered or when the current license settings have been breached.

Possible failures

- CMMVC5786E The action failed because the cluster is not in a stable state.
- CMMVC6252E The command failed authorization because the session SSH key is wrong or was deleted.
- CMMVC6253E The command failed authorization because the session SSH key does not have the requisite role.

An invocation example

```
svcinfo lsfeaturedumps
```

The resulting output

```
id           feature_filename
0            feature.txt
```

lsfreeextents

The **lsfreeextents** command lists the number of free extents that are available on a specified MDisk.

Syntax

```
svcinfo - - lsfreeextents - -nohdr - -  
-delim - delimiter - mdisk_id -  
mdisk_name -
```

Parameters

-nohdr

(Optional) By default, headings are displayed for each column of data in a concise style view, and for each item of data in a detailed style view. The **-nohdr** parameter suppresses the display of these headings.

Note: If there is no data to be displayed, headings are not displayed even if the **-nohdr** parameter is specified.

-delim *delimiter*

(Optional) By default in a concise view, all columns of data are space-separated. The width of each column is set to the maximum possible width of each item of data. In a detailed view, each item of data has its own row, and if the headers are displayed, the data is separated from the header by a space. The **-delim** parameter overrides this behavior. Valid input for the **-delim** parameter is a one-byte character. If you enter **-delim :** on the command line, the colon character (:) separates all items of data in a concise view; for example, the spacing of columns does not occur. In a detailed view, the data is separated from its header by the specified delimiter.

mdisk_id | *mdisk_name*

(Required) Specifies the ID or the name of the MDisk for which you want to know the number of free extents.

Description

This command displays a count of the number of free extents on the specified MDisk.

Possible failures

- CMMVC5786E The action failed because the cluster is not in a stable state.
- CMMVC5804E The action failed because an entity that was specified in the command does not exist.
- CMMVC6252E The command failed authorization because the session SSH key is wrong or was deleted.

- CMMVC6253E The command failed authorization because the session SSH key does not have the requisite role.

An invocation example

```
svcinfo lsfreeextents 2
```

The resulting output

```
id 2
number_of_extents 4372
```

Ishbaportcandidate

The **Ishbaportcandidate** command lists all of the unconfigured, logged in host bus adapter (HBA) ports. This information is used to find open HBA ports.

Syntax

```

>>> svcinfo -- lshbaportcandidate -- [ -nohdr ]
<<<
[ -delim delimiter ]

```

Parameters

-nohdr

(Optional) By default, headings are displayed for each column of data in a concise style view, and for each item of data in a detailed style view. The **-nohdr** parameter suppresses the display of these headings.

Note: If there is no data to be displayed, headings are not displayed even if the **-nohdr** parameter is specified.

-delim *delimiter*

(Optional) By default in a concise view, all columns of data are space-separated. The width of each column is set to the maximum possible width of each item of data. In a detailed view, each item of data has its own row, and if the headers are displayed the data is separated from the header by a space. The **-delim** parameter overrides this behavior. Valid input for the **-delim** parameter is a one-byte character. If you enter **-delim :** on the command line, the colon character (:) separates all items of data in a concise view; for example, the spacing of columns does not occur. In a detailed view, the data is separated from its header by the specified delimiter.

Description

This command returns a list of unconfigured, logged in HBA ports.

Note: The **svcinfo lshbaportcandidate** command presents a list of host HBA ports that are logged in to nodes. However, there are situations when the information that is presented might include host HBA ports that are no longer logged in or even part of the SAN fabric. For example, a host HBA port is unplugged from a switch but **svcinfo lshbaportcandidate** still shows the WWPN that is logged in to all nodes. If this occurs, the incorrect entry is removed when another device is plugged in to the same switch port that previously contained the removed host HBA port.

Possible failures

- CMMVC5786E The action failed because the cluster is not in a stable state.
- CMMVC5804E The action failed because an entity that was specified in the command does not exist.

An invocation example

```
svcinfo lshbaportcandidate
```

The resulting output

```
id  
210100E08B2520D4
```

lshost

The **lshost** command generates a list with concise information about all the hosts visible to the cluster and detailed information about a single host.

The list report style can be used to obtain two styles of report:

- A list containing concise information about all the hosts visible to the cluster. Each entry in the list corresponds to a single host.
- The detailed information about a single host.

Syntax

```
svcinfo -- lshost [ -filtervalue -- attrib=value ]  
[ -nohdr ] [ -delim -- delimiter ] [ object_id  
object_name ]  
[ -filtervalue? ]
```

Parameters

-filtervalue *attrib=value*

(Optional) Specifies a list of one or more filters. Only objects with a value that matches the filter attribute value are returned. If a capacity is specified, the units must also be included.

Note: Some filters allow the use of a wildcard when you enter the command. The following rules apply to the use of wildcards with the SAN Volume Controller CLI:

- The wildcard character is an asterisk (*).
- The command can contain a maximum of one wildcard.
- When using a wildcard character, you must enclose the filter entry within double quotation marks (" "), as follows:

```
svcinfo lshost -filtervalue "name=md*"
```

-nohdr

(Optional) By default, headings are displayed for each column of data in a concise style view, and for each item of data in a detailed style view. The **-nohdr** parameter suppresses the display of these headings.

Note: If there is no data to be displayed, headings are not displayed even if the **-nohdr** parameter is specified.

-delim *delimiter*

(Optional) By default in a concise view, all columns of data are space-separated. The width of each column is set to the maximum possible width of each item of data. In a detailed view, each item of data has its own row, and if the headers are displayed the data is separated from the header by a space. The **-delim** parameter overrides this behavior. Valid input for the **-delim** parameter is a one-byte character. If you enter **-delim :** on the command line, the colon character (:) separates all items of data in a concise view; for example, the spacing of columns does not occur. In a detailed view, the data is separated from its header by the specified delimiter.

object_id | *object_name*

(Optional) Specifies the name or ID of an object. When you use this parameter, the detailed view of the specific object is returned and any value that is specified by the **-filtervalue** parameter is ignored. If you do not specify the *object_id* | *object_name* parameter, the concise view of all objects matching the filtering requirements that is specified by the **-filtervalue** parameter are displayed.

-filtervalue?

(Optional) Specifies that you want your report to display any or all of the list of valid filter attributes. The valid filter attributes for the **svcinfo lshost** command are:

- host_name
- host_id
- port_count
- name
- id
- iogrp_count

Description

This command returns a concise list or a detailed view, of hosts visible to the cluster.

The following list provides the different states for a host:

offline

The host is offline if one or more I/O groups with VDisk mappings does not have a login for the specified WWPN.

degraded

The host is degraded if one or more nodes with VDisk mappings do not have a login for the specified WWPN.

inactive

The host is inactive if all the nodes with VDisk mappings have a login for the specified WWPN, however, no nodes have seen any SCSI commands from the WWPN in the last 5 minutes.

active The host is active if all the nodes with VDisk mappings have a login for the specified WWPN, however, at least one node has seen SCSI commands from the WWPN in the last 5 minutes.

If a host does not have any VDisk mappings, then it is either reported as offline or inactive.

Note: The `svcinfo lshost` command presents a list of host HBA ports that are logged in to nodes. However, there are situations when the information presented can include host HBA ports which are no longer logged in or even part of the SAN fabric. For example: A host HBA port is unplugged from a switch but `svcinfo lshost` still shows the WWPN logged in to all nodes. If this occurs, the incorrect entry is removed when another device is plugged in to the same switch port that previously contained the removed host HBA port.

Possible failures

- CMMVC5786E The action failed because the cluster is not in a stable state.
- CMMVC6252E The command failed authorization because the session SSH key is wrong or was deleted.
- CMMVC6253E The command failed authorization because the session SSH key does not have the requisite role.

A concise invocation example

```
svcinfo lshost -delim :
```

The concise resulting output

```
id:name:port_count:iogrp_count
0:host0:1:0
1:host1:1:0
```

A detailed invocation example

```
svcinfo lshost -delim : 1
```

The detailed resulting output

```
id:1
name:host1
port_count:1
type:generic
iogrp_count:0
mask:1111
WWPN:0000000000001AABB
node_logged_in_count:0
state:inactive
```

lshostiogrp

The `lshostiogrp` command displays a list of all the I/O groups that are associated with a specified host.

Syntax

```
➤➤➤ svcinfo — — lshostiogrp — — [ -nohdr ] [ -delim — delimiter ]
➤➤➤ [ host_id ]
➤➤➤ [ host_name ]
```

Parameters

-nohdr

(Optional) By default, headings are displayed for each column of data in a concise style view, and for each item of data in a detailed style view. The **-nohdr** parameter suppresses the display of these headings.

Note: If there is no data to be displayed, headings are not displayed even if the **-nohdr** parameter is specified.

-delim *delimiter*

(Optional) By default in a concise view, all columns of data are space-separated. The width of each column is set to the maximum possible width of each item of data. In a detailed view, each item of data has its own row, and if the headers are displayed, the data is separated from the header by a space. The **-delim** parameter overrides this behavior. Valid input for the **-delim** parameter is a one-byte character. If you enter **-delim :** on the command line, the colon character (:) separates all items of data in a concise view; for example, the spacing of columns does not occur. In a detailed view, the data is separated from its header by the specified delimiter.

host_id | host_name

(Required) The name or ID of the host for which the list of I/O groups is required.

Description

This command displays a list of all the I/O groups that are mapped to the specified host.

Possible failures

- CMMVC5786E The action failed because the cluster is not in a stable state.
- CMMVC5804E The action failed because an object that was specified in the command does not exist.
- CMMVC6252E The command failed authorization because the session SSH key is wrong or was deleted.
- CMMVC6253E The command failed authorization because the session SSH key does not have the requisite role.

An invocation example

```
svcinfo lshostiogrp -delim : hostone
```

The resulting output

```
id:name  
0:io_grp0  
1:io_grp1
```

lshostvdiskmap

You can use the **lshostvdiskmap** command to obtain a list of the virtual disks that are mapped (recognized by) to a given host. These are the virtual disks that have been mapped to the specified host, meaning they are recognized by the specified host.

Syntax

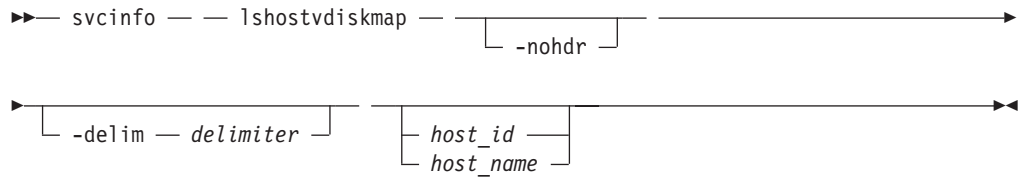

Parameters

-nohdr

(Optional) By default, headings are displayed for each column of data in a concise style view, and for each item of data in a detailed style view. The **-nohdr** parameter suppresses the display of these headings.

Note: If there is no data to be displayed, headings are not displayed even if the **-nohdr** parameter is specified.

-delim *delimiter*

(Optional) By default in a concise view, all columns of data are space-separated. The width of each column is set to the maximum possible width of each item of data. In a detailed view, each item of data has its own row, and if the headers are displayed, the data is separated from the header by a space. The **-delim** parameter overrides this behavior. Valid input for the **-delim** parameter is a one-byte character. If you enter **-delim :** on the command line, the colon character (:) separates all items of data in a concise view; for example, the spacing of columns does not occur. In a detailed view, the data is separated from its header by the specified delimiter.

host_id | *host_name*

(Optional) Specifies the host in terms of its ID or name. The command displays a list of all the virtual disks that are mapped to the specified host and the SCSI ID by which they are mapped. If neither a host ID or name are entered, the command displays a list of all recognized host-to-VDisk mappings.

Description

This command displays a list of virtual disk IDs and names. These are the virtual disks that have been mapped to the specified host; that is, they are visible to the specified host. The SCSI LUN ID is also displayed. This SCSI LUN ID is the ID by which the virtual disk is recognized by the host.

Each VDisk that is exported by the cluster is assigned a unique vpath number. This number identifies the VDisk and determines which VDisk corresponds to the volume that the hosts recognize. This procedure can only be performed using the command-line interface.

For the specified volume, find the vpath serial number by issuing the **datapath query device** command. Find the host that is defined to the cluster that corresponds with the host that you are working with.

1. The WWPNs are an attribute of the HBA. You can find these by looking at the device definitions stored by your operating system. For example, on AIX they are in the ODM, in Windows they are in the Device Manager details for the given HBA.

2. Verify which host is defined to the cluster that these ports belong to. The ports are stored as part of the detailed view, so you must list each host in turn by issuing the following command:

```
svcinfolshost host_name | host_id
```

where *host_name* | *host_id* is the name or ID of the host. Check for matching WWPNs.

Note: Name your hosts accordingly. For example, if the actual host is called **orange**, also name the host that is defined to the cluster **orange**.

When you have the *hostname* defined to the cluster and the *vpath serial number*, issue the following command:

```
svcinfolshostvdiskmap hostname
```

where *hostname* is the name of the host. A list is displayed. Look for the VDisk UID that matches the *vpath serial number* and record the VDisk name or ID.

Possible failures

- CMMVC5786E The action failed because the cluster is not in a stable state.
- CMMVC5804E The action failed because an entity that was specified in the command does not exist.
- CMMVC6252E The command failed authorization because the session SSH key is wrong or was deleted.
- CMMVC6253E The command failed authorization because the session SSH key does not have the requisite role.

An invocation example

```
svcinfolshostvdiskmap -delim : 2
```

The resulting output

```
id:name:SCSI_id:vdisk_id:vdisk_name:wwpn:vdisk_UID
2:host2:0:10:vdisk10:0000000000000000ACA:6005076801958001500000000000000A
2:host2:1:11:vdisk11:0000000000000000ACA:6005076801958001500000000000000B
2:host2:2:12:vdisk12:0000000000000000ACA:6005076801958001500000000000000C
2:host2:3:13:vdisk13:0000000000000000ACA:6005076801958001500000000000000D
2:host2:4:14:vdisk14:0000000000000000ACA:6005076801958001500000000000000E
```

Isiogrp

The **lsiogrp** command returns a concise list or a detailed view of I/O groups visible to the cluster.

The list report style can be used to obtain the following two styles of report:

- A list containing concise information about all the I/O groups that are visible to the cluster. Each entry in the list corresponds to a single I/O group.
- The detailed information about a single I/O group.

Syntax

```
▶▶ svcinfolshostvdiskmap lsiogrp [-filtervalue - attrib=value] ▶▶▶
```

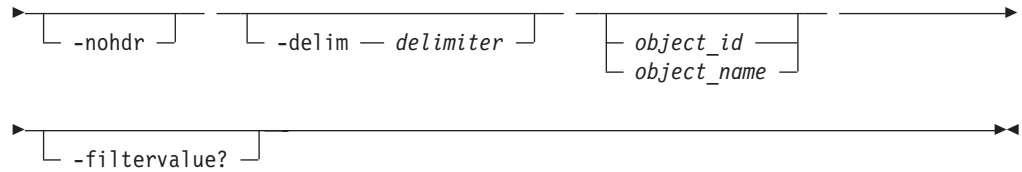

Parameters

-filtervalue *attrib=value*

(Optional) Specifies a list of one or more filters. Only objects with a value that matches the filter attribute value are returned. If a capacity is specified, the units must also be included.

Note: Some filters allow the use of a wildcard when you enter the command. The following rules apply to the use of wildcard characters with the SAN Volume Controller CLI:

- The wildcard character is an asterisk (*), which must be the first or last character in the string.
- The command can contain a maximum of one wildcard.
- When using a wildcard, enclose the filter entry within double quotation marks (""), as follows:

```
svcinfolsiogrp -filtervalue "name=md*"
```

-nohdr

(Optional) By default, headings are displayed for each column of data in a concise style view, and for each item of data in a detailed style view. The **-nohdr** parameter suppresses the display of these headings.

Note: If there is no data to be displayed, headings are not displayed even if the **-nohdr** parameter is specified.

-delim *delimiter*

(Optional) By default in a concise view, all columns of data are space-separated. The width of each column is set to the maximum possible width of each item of data. In a detailed view, each item of data has its own row, and if the headers are displayed the data is separated from the header by a space. The **-delim** parameter overrides this behavior. Valid input for the **-delim** parameter is a one byte character. If you enter `-delim :` on the command line, the colon character (:) separates all items of data in a concise view; for example, the spacing of columns does not occur. In a detailed view, the data is separated from its header by the specified delimiter.

object_id | object_name

(Optional) Specifies the name or ID of an object. When you use this parameter, the detailed view of the specific object is returned and any value that is specified by the **-filtervalue** parameter is ignored. If you do not specify the *object_id | object_name* parameter, the concise view of all objects matching the filtering requirements that is specified by the **-filtervalue** parameter are displayed.

-filtervalue?

(Optional) Displays the valid filter attributes for the **svcinfolsiogrp** command:

- **HWS_name**
- **HWS_unique_id**
- **node_count**

- **vdisk_count**
- **name**
- **id**
- **host_count**

Description

This command returns a concise list or a detailed view of I/O groups visible to the cluster.

Possible failures

- CMMVC5786E The action failed because the cluster is not in a stable state.
- CMMVC5804E The action failed because an entity that was specified in the command does not exist.
- CMMVC6252E The command failed authorization because the session SSH key is wrong or was deleted.
- CMMVC6253E The command failed authorization because the session SSH key does not have the requisite role.

A concise invocation example

```
svcinflsiogrp -delim :
```

The concise resulting output

```
id:name:node_count:vdisk_count:host_count
0:io_grp0:1:0:0
1:io_grp1:0:0:0
2:io_grp2:0:0:0
3:io_grp3:0:0:0
4:recovery_io_grp:0:0:0
```

A detailed invocation example

```
svcinflsiogrp -delim : 2
```

The detailed resulting output

```
id:2
name:io_grp2
node_count:2
vdisk_count:236
host_count:4
flash_copy_total_memory:20.0MB
flash_copy_free_memory:15.1MB
remote_copy_total_memory:30.5MB
remote_copy_free_memory:2.0MB
```

lsiogrpghost

The **lsiogrpghost** displays a list of the hosts that are mapped to a specified I/O group.

Syntax

```
svcinflsiogrpghost [-nohdr] [-delim delimiter]
```



Parameters

-nohdr

(Optional) By default, headings are displayed for each column of data in a concise style view, and for each item of data in a detailed style view. The **-nohdr** parameter suppresses the display of these headings.

Note: If there is no data to be displayed, headings are not displayed even if the **-nohdr** parameter is specified.

-delim *delimiter*

(Optional) By default in a concise view, all columns of data are space-separated. The width of each column is set to the maximum possible width of each item of data. In a detailed view, each item of data has its own row, and if the headers are displayed, the data is separated from the header by a space. The **-delim** parameter overrides this behavior. Valid input for the **-delim** parameter is a one-byte character. If you enter **-delim :** on the command line, the colon character (:) separates all items of data in a concise view; for example, the spacing of columns does not occur. In a detailed view, the data is separated from its header by the specified delimiter.

iogrp_id | *iogrp name*

(Required) The ID or name of the I/O group for which a list of all mapped hosts is required.

Description

The **lsiogrphost** command displays a list of hosts that are mapped to a specified I/O group.

Possible failures

- CMMVC5786E The action failed because the cluster is not in a stable state.
- CMMVC5804E The action failed because an object that was specified in the command does not exist.
- CMMVC6252E The command failed authorization because the session SSH key is wrong or was deleted.
- CMMVC6253E The command failed authorization because the session SSH key does not have the requisite role.

An invocation example

```
svcinfo lsiogrphost -delim : 0
```

The resulting output

```
id:name
0:hostzero
1:hostone
```

lsiogrpcandidate

Use the **lsiogrpcandidate** command to list the I/O groups that can have nodes added to them.

Syntax

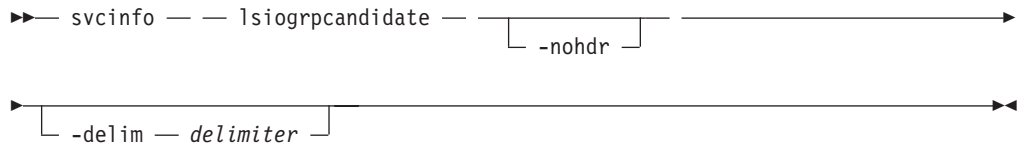

Parameters

-nohdr

(Optional) By default, headings are displayed for each column of data in a concise style view, and for each item of data in a detailed style view. The **-nohdr** parameter suppresses the display of these headings.

Note: If there is no data to be displayed, headings are not displayed even if the **-nohdr** parameter is specified.

-delim *delimiter*

(Optional) By default in a concise view, all columns of data are space-separated. The width of each column is set to the maximum possible width of each item of data. In a detailed view, each item of data has its own row, and if the headers are displayed, the data is separated from the header by a space. The **-delim** parameter overrides this behavior. Valid input for the **-delim** parameter is a one-byte character. If you enter **-delim :** on the command line, the colon character (:) separates all items of data in a concise view; for example, the spacing of columns does not occur. In a detailed view, the data is separated from its header by the specified delimiter.

Description

This command displays a list of I/O groups to which nodes can be added. Only the I/O group IDs are displayed.

Possible failures

- CMMVC5786E The action failed because the cluster is not in a stable state.
- CMMVC5804E The action failed because an entity that was specified in the command does not exist.
- CMMVC6252E The command failed authorization because the session SSH key is wrong or was deleted.
- CMMVC6253E The command failed authorization because the session SSH key does not have the requisite role.

An invocation example

```
svcinfo lsiogrpcandidate
```

The resulting output

```
id
0
1
2
3
4
```

Isiostatsdumps

The **Isiostatsdumps** command displays a list of dumps in the **/dumps/iostats** directory. Use the **svctask startstats** command to create these dumps.

Syntax

```
svcinfolsiostatsdumps [-nohdr] [-delim delimiter] [node_id | node_name]
```

Parameters

-nohdr

(Optional) By default, headings are displayed for each column of data in a concise style view, and for each item of data in a detailed style view. The **-nohdr** parameter suppresses the display of these headings.

Note: If there is no data to be displayed, headings are not displayed even if the **-nohdr** parameter is specified.

-delim *delimiter*

(Optional) By default in a concise view, all columns of data are space-separated. The width of each column is set to the maximum possible width of each item of data. In a detailed view, each item of data has its own row, and if the headers are displayed, the data is separated from the header by a space. The **-delim** parameter overrides this behavior. Valid input for the **-delim** parameter is a one-byte character. If you enter **-delim :** on the command line, the colon character (:) separates all items of data in a concise view; for example, the spacing of columns does not occur. In a detailed view, the data is separated from its header by the specified delimiter.

node_id | node_name

(Optional) Specifies the node ID or name to list the available dumps of the given type. If you do not specify a node, the dumps that are available on the configuration node are listed.

Description

This command displays a list of I/O statistics dumps. These dumps are created when you issue the **svctask startstats** command. If you do not specify a node, the dumps that are available on the configuration node are listed. The command displays files from the **/dumps/iostats** directory.

Possible failures

- CMMVC5786E The action failed because the cluster is not in a stable state.
- CMMVC6252E The command failed authorization because the session SSH key is wrong or was deleted.
- CMMVC6253E The command failed authorization because the session SSH key does not have the requisite role.

An invocation example

```
svcinfolsiostatsdumps
```

The resulting output

```
id          iostat_filename
0          v_stats_mala75_031123_072426
1          m_stats_mala75_031123_072425
```

Isiotracedumps

Use the **Isiotracedumps** command to display a list of files in the **/dumps/iotrace** directory.

Syntax

```
svcinfolsiotracedumps [-nohdr] [-delim delimiter] [node_id | node_name]
```

Parameters

-nohdr

(Optional) By default, headings are displayed for each column of data in a concise style view, and for each item of data in a detailed style view. The **-nohdr** parameter suppresses the display of these headings.

Note: If there is no data to be displayed, headings are not displayed even if the **-nohdr** parameter is specified.

-delim delimiter

(Optional) By default in a concise view, all columns of data are space-separated. The width of each column is set to the maximum possible width of each item of data. In a detailed view, each item of data has its own row, and if the headers are displayed, the data is separated from the header by a space. The **-delim** parameter overrides this behavior. Valid input for the **-delim** parameter is a one-byte character. If you enter **-delim :** on the command line, the colon character (:) separates all items of data in a concise view; for example, the spacing of columns does not occur. In a detailed view, the data is separated from its header by the specified delimiter.

node_id | node_name

(Optional) Specifies the node ID or name to list the available dumps of the given type. If you do not specify a node, the dumps that are available on the configuration node are listed.

Description

This command displays a list of I/O trace dumps. These dumps are created when you issue the **svctask settrace** command. If you do not specify a node, the dumps that are available on the configuration node are listed. The command displays files from the **/dumps/iotrace** directory.

Possible failures

- CMMVC5786E The action failed because the cluster is not in a stable state.
- CMMVC6252E The command failed authorization because the session SSH key is wrong or was deleted.

- CMMVC6253E The command failed authorization because the session SSH key does not have the requisite role.

An invocation example

```
svcinfolsiotracedumps
```

The resulting output

```
id          iotrace_filename
0           c1_mala75_030405_092155
1           c2_mala75_030405_092156
2           c3_mala75_030405_092158
3           c4_mala75_030405_092159
4           c5_mala75_030405_092201
```

lslicense

The **lslicense** command displays the current license (featurization) settings for the cluster. The settings are defined as having Copy Services status and the capacity of virtual storage that is licensed for use by this cluster.

Syntax

```
svcinfol — lslicense — [-nohdr] [-delim delimiter]
```

Parameters

-nohdr

(Optional) Suppresses the display of these headings. By default, headings are displayed for each column of data (in a concise style view providing general information about objects of a particular type) and for each item of data (in a detailed style view providing much more information about a specific object of a particular type).

Note: If there is no data to be displayed (for example, an empty view), headings are not displayed even if the **-nohdr** option was used.

-delim *delimiter*

(Optional) By default in a concise view, all columns of data are space-separated. The width of each column is set to the maximum possible width of each item of data. In a detailed view, each item of data has its own row, and if the headers are displayed, the data is separated from the header by a space. The **-delim** parameter overrides this behavior. Valid input for the **-delim** parameter is a one-byte character. If you enter **-delim :**, a colon character (:) separates all items of data in a concise view; for example, the spacing of columns does not occur. In a detailed view, the data is separated from its header by the specified delimiter.

Description

This command displays the licensed features of the cluster. That is, the settings have Copy Services status and the capacity of virtual storage that is licensed for use by this cluster.

You can issue the **svcinfol** **lslicense** command to display the current license (featurization) settings for the cluster. You can issue the **svctask** **chlicense**

command to change the licensed settings of the cluster. Because the feature settings are entered when the cluster is first created, you must update the settings only if you have changed your license. You can change the following values:

- FlashCopy: disabled or enabled
- Remote copy (Global or Metro Mirror): disabled or enabled
- Virtualization limit: number, in gigabytes (1073741824 bytes)

The displayed output lists the feature functions and displays whether they are enabled or disabled.

Possible failures

- CMMVC5786E The action failed because the cluster is not in a stable state.
- CMMVC6252E The command failed authorization because the session SSH key is wrong or was deleted.
- CMMVC6253E The command failed authorization because the session SSH key does not have the requisite role.

An invocation example

```
svcinfo lslicense
```

The resulting output

```
feature_flash on  
feature_remote on  
feature_num_gb 32
```

lsmdisk

The **lsmdisk** command returns a concise list or a detailed view of MDisks visible to the cluster. It can also list detailed information about a single managed disk.

Syntax

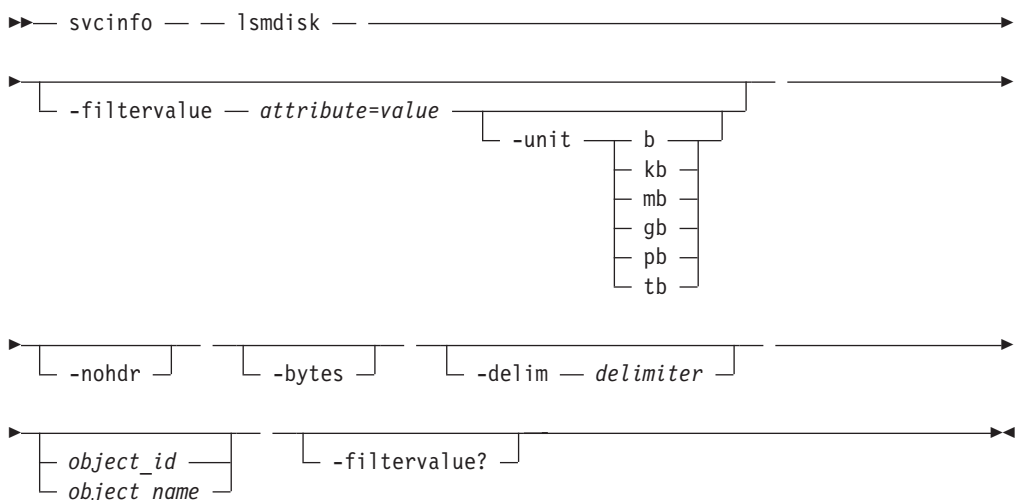

Parameters

-filtervalue attribute=value

(Optional) Specifies a list of one or more filter attributes matching the specified

values; see **-filtervalue?** for the supported attributes. Only objects with a value that matches the filter attribute value are returned. If **capacity** is specified, the units must also be included.

Note: Some filters allow the use of a wildcard when entering the command. The following rules apply to the use of wildcards with the SAN Volume Controller CLI:

- The wildcard character is an asterisk (*).
- The command can contain a maximum of one wildcard, which must be the first or last character in the string.
- When using a wildcard character, you must enclose the filter entry within double quotation marks (""), as follows:

```
svcinfolsmdisk -filtervalue "name=md*"
```

-filtervalue?

(Optional) Includes all of the valid filter attributes in the report. The following filter attributes are valid for the **svcinfolsmdisk** command:

- name
- id
- status
- mode
- mdisk_grp_id
- mdisk_grp_name
- capacity
- controller_name

Any parameters specified with the **-filtervalue?** parameter are ignored.

-nohdr

(Optional) By default, headings are displayed for each column of data in a concise style view, and for each item of data in a detailed style view. The **-nohdr** parameter suppresses the display of these headings.

Note: If there is no data to be displayed, headings are not displayed even if the **-nohdr** parameter is specified.

-bytes

(Optional) Specifies that you want the report to display all capacities as bytes.

-delim delimiter

(Optional) By default in a concise view, all columns of data are space separated. The width of each column is set to the maximum possible width of each item of data. In a detailed view, each item of data has its own row, and if the headers are displayed the data is separated from the header by a space. The **-delim** parameter overrides this behavior. Valid input for the **-delim** parameter is a one-byte character. If you enter **-delim :** on the command line, the colon character (:) separates all items of data in a concise view; for example, the spacing of columns does not occur. In a detailed view, the data is separated from its header by the specified delimiter.

object_id | object_name

(Optional) Specifies the name or ID of an object. When you use this parameter, the detailed view of the specific object is returned and any value that is specified by the **-filtervalue** parameter is ignored. If you do not specify the

-object_ID or **-object_name** parameter, the concise view of all objects matching the filtering requirements that is specified by the **-filtervalue** parameter are displayed.

Description

This command returns a concise list or a detailed view of MDisks visible to the cluster. The following table shows potential output:

Table 6. MDisk output. MDisk output attribute values

Attribute	Values
<i>status</i>	offline, excluded, degraded, online
<i>mode</i>	unmanaged, managed, image
<i>quorum index</i>	0,1,2 valid Quorum index

When back-end controllers are added to the fibre-channel SAN and are included in the same switch zone as a cluster, the cluster automatically discovers the back-end controller. The cluster determines from the controller which type of storage that it is presenting to the node. The SCSI LUs presented by the back-end controller are displayed as unmanaged MDisks. However, if the configuration of the back-end controller is modified after this has occurred, the cluster might be unaware of these configuration changes. This command allows you to re-scan the fibre-channel network to update the list of unmanaged MDisks.

Note: The automatic discovery performed by the cluster does not write anything to an unmanaged MDisk. It is only when you add an MDisk to an MDisk group, or use an MDisk to create an image mode virtual disk, that the system uses the storage.

To see which MDisks are available, issue the **svctask detectmdisk** command to manually scan the fibre-channel network for any MDisks. Issue the **svcinfolsmdiskcandidate** command to show the unmanaged MDisks. These MDisks have not been assigned to an MDisk group. Alternatively, you can issue the **svcinfolsmdisk** command to view all of the MDisks.

Each MDisk corresponds with a single RAID array, or a single partition on a given RAID array. Each RAID controller defines a LUN number for this disk. The LUN number and controller name or ID are needed to determine the relationship between MDisks and RAID arrays or partitions.

To determine the relationship between MDisks and RAID arrays or LUNs, enter the following command:

```
svcinfolsmdisk mdiskname
```

where *mdiskname* is the name of the MDisk.

Note: Record the controller name or controller ID and controller LUN number for later use.

Show the detailed view of the controller by issuing the following command:

```
svcinfolcontroller controllername
```

where *controllername* is the name of the controller.

Note: Record the vendor ID, product ID, and worldwide node name. Use these to determine what is being presented to the MDisk.
From the native user interface for the given controller, list the LUNs that the controller is presenting and match the LUN number. This value shows you the exact RAID array or partition that corresponds with the MDisk.

Possible failures

- CMMVC5786E The action failed because the cluster is not in a stable state.
- CMMVC5804E The action failed because an entity that was specified in the command does not exist.
- CMMVC6252E The command failed authorization because the session SSH key is wrong or was deleted.
- CMMVC6253E The command failed authorization because the session SSH key does not have the requisite role.

A concise invocation example

```
svcinflsmdisk -delim :
```

The concise resulting output

```
id:name:status:mode:mdisk_grp_id:mdisk_grp_name:capacity:  
ctrl_LUN_#:controller_name:UID  
0:mdisk0:online:managed:0:mdiskgrp0:68.4GB:0000000000000000:controller0:  
20000004cf2422aa000000000000000000000000000000000000000000000000  
1:mdisk1:online:managed:0:mdiskgrp0:68.4GB:0000000000000000:controller1:  
20000004cf1fd19d000000000000000000000000000000000000000000000000  
2:mdisk2:online:managed:0:mdiskgrp0:68.4GB:0000000000000000:controller2:  
20000004cf24253100000000000000000000000000000000000000000000000  
3:mdisk3:online:managed:0:mdiskgrp0:68.4GB:0000000000000000:controller3:  
20000004cf1fd7a0000000000000000000000000000000000000000000000000  
4:mdisk4:online:unmanaged:::68.4GB:0000000000000000:controller4:  
20000004cf24130800000000000000000000000000000000000000000000000  
5:mdisk5:online:unmanaged:::68.4GB:0000000000000000:controller5:  
20000004cf2412ca000000000000000000000000000000000000000000000000  
6:mdisk6:online:unmanaged:::68.4GB:0000000000000000:controller6:  
20000004cf24212300000000000000000000000000000000000000000000000  
7:mdisk7:online:unmanaged:::68.4GB:0000000000000000:controller7:  
20000004cf2412ac000000000000000000000000000000000000000000000000  
8:mdisk8:online:unmanaged:::68.4GB:0000000000000000:controller8:  
20000004cf2421de000000000000000000000000000000000000000000000000  
9:mdisk9:online:unmanaged:::68.4GB:0000000000000000:controller9:  
20000004cf1fd7cc000000000000000000000000000000000000000000000000  
10:mdisk10:online:unmanaged:::68.4GB:0000000000000000:controller10:  
20000004cf1ffe88000000000000000000000000000000000000000000000000  
11:mdisk11:online:unmanaged:::68.4GB:0000000000000000:controller11:  
20000004cf2412aa000000000000000000000000000000000000000000000000  
12:mdisk12:online:unmanaged:::68.4GB:0000000000000000:controller12:  
20000004cf24237400000000000000000000000000000000000000000000000  
13:mdisk13:online:unmanaged:::68.4GB:0000000000000000:controller13:  
20000004cf2419fe000000000000000000000000000000000000000000000000  
14:mdisk14:online:unmanaged:::68.4GB:0000000000000000:controller14:  
20000004cf24193200000000000000000000000000000000000000000000000
```

A detailed invocation example

```
svcinflsmdisk -delim : 2
```

The detailed resulting output

```
id:2  
name:mdisk2  
status:online  
mode:unmanaged
```

```

mdisk_grp_id:
mdisk_grp_name:
capacity:68.4GB
quorum_index:
block_size:512
controller_name:controller2
ctrl_type:4
ctrl_WWNN:20000004CF242531
controller_id:2
path_count:1
max_path_count:1
ctrl_LUN #:0000000000000000
UID:20000004cf24253100000000000000000000000000000000000000000000000000
preferred_WWPN:22000004CF242531
active_WWPN:22000004CF242531

```

The following define the `ctrl_type` fields:

- 0 Device that has not yet been processed.
- 1 Device is a node in which that cluster has not yet been identified.
- 2 Device is a node within this cluster.
- 3 Device is a node within a remote cluster.
- 4 Device is a back-end storage controller.
- 5 Device is a storage or other fabric device that is incompatible with the cluster.

lsmdiskcandidate

The `lsmdiskcandidate` command lists all of the unmanaged MDisks by MDisk ID.

Syntax

```

▶▶ svcinfo — lsmdiskcandidate — [ -nohdr ] —————▶
▶ [ -delim delimiter ] —————▶▶

```

Parameters

-nohdr

(Optional) By default, headings are displayed for each column of data in a concise style view, and for each item of data in a detailed style view. The `-nohdr` parameter suppresses the display of these headings.

Note: If there is no data to be displayed, headings are not displayed even if the `-nohdr` parameter is specified.

-delim *delimiter*

(Optional) By default in a concise view, all columns of data are space-separated. The width of each column is set to the maximum possible width of each item of data. In a detailed view, each item of data has its own row, and if the headers are displayed, the data is separated from the header by a space. The `-delim` parameter overrides this behavior. Valid input for the `-delim` parameter is a one-byte character. If you enter `-delim :` on the command line, the colon character (`:`) separates all items of data in a concise

view; for example, the spacing of columns does not occur. In a detailed view, the data is separated from its header by the specified delimiter.

Description

This command displays a list of MDisks that are unmanaged. Only the MDisk IDs are displayed.

When back-end controllers are added to the fibre-channel SAN and are included in the same switch zone as a cluster, the cluster automatically detects the back-end controller to determine which storage is presented to the node. The SCSI logical units that are presented by the back-end controller are displayed as unmanaged MDisks. However, if the configuration of the back-end controller is modified after this has occurred, the cluster might be unaware of these configuration changes. You can then request that the cluster rescan the fibre-channel SAN to update the list of unmanaged MDisks.

Note: The automatic detection performed by the cluster does not write anything to a unmanaged MDisk. It is only when you instruct the cluster to add an MDisk to a managed disk group or use a MDisk to create an image mode virtual disk that the storage is actually used.

Check to see which MDisks are available by issuing the **svctask detectmdisk** command to manually scan the fibre-channel network for any MDisks. Issue the **svcinfolsmdiskcandidate** command to show the unmanaged MDisks. These MDisks have not been assigned to an MDisk group. Alternatively, you can issue the **svcinfolsmdisk** command to view all of the MDisks.

Possible failures

- CMMVC5786E The action failed because the cluster is not in a stable state.
- CMMVC5804E The action failed because an entity that was specified in the command does not exist.
- CMMVC6252E The command failed authorization because the session SSH key is wrong or was deleted.
- CMMVC6253E The command failed authorization because the session SSH key does not have the requisite role.

An invocation example

```
svcinfolsmdiskcandidate
```

The resulting output

```
id  
5  
6  
7  
8  
9  
10  
11  
12  
13  
14
```

lsmdiskextent

The **lsmdiskextent** command displays the extent allocation between managed disks and virtual disks. The command displays a list, in which each entry contains a VDisk ID and the number of extents.

Syntax

```
svcinfo -- lsmdiskextent -- [-nohdr] -- [-delim delimiter] -- [mdisk_name | mdisk_id] -- [vdisk_name | vdisk_id]
```

Parameters

-nohdr

(Optional) By default, headings are displayed for each column of data in a concise style view, and for each item of data in a detailed style view. The **-nohdr** parameter suppresses the display of these headings.

Note: If there is no data to be displayed, headings are not displayed even if the **-nohdr** parameter is specified.

-delim *delimiter*

(Optional) By default in a concise view, all columns of data are space-separated. The width of each column is set to the maximum possible width of each item of data. In a detailed view, each item of data has its own row, and if the headers are displayed, the data is separated from the header by a space. The **-delim** parameter overrides this behavior. Valid input for the **-delim** parameter is a one-byte character. If you enter **-delim :** on the command line, the colon character (:) separates all items of data in a concise view; for example, the spacing of columns does not occur. In a detailed view, the data is separated from its header by the specified delimiter.

mdisk_name | *mdisk_id*

(Required) Specifies the specific object ID or name of the given type.

vdisk_name | *vdisk_id*

(Required) Specifies the specific object ID or name of the given type.

Description

The command displays a list, in which each entry contains a VDisk ID and the number of extents. These VDIsks are using extents on the specified MDisk. The number of extents being used on each MDisk is also shown.

Every VDisk is constructed from one or more MDisks. At times, you might have to determine the relationship between the two objects. The following procedure allows you to determine the relationships.

To determine the relationship between VDIsks and MDisks, issue the following command for each VDisk:

```
svcinfo lsvdiskmember vdisk_name | vdisk_id
```

where *vdisk_name* | *vdisk_id* is the name or ID of the VDisk. This displays a list of IDs that correspond to the MDisks that make up the VDisk.

To determine the relationship between VDIs and MDIs and the number of extents that are provided by each MDisk, you must use the command-line interface. For each VDisk, issue the following command:

```
svcinfo lsvdiskextent vdisk_name | vdisk_id
```

where *vdisk_name* | *vdisk_id* is the name or ID of the VDisk. This displays a table of MDisk IDs and the corresponding number of extents that each MDisk is providing as storage for the given VDisk.

To determine the relationship between MDIs and VDIs, issue the following command for each MDisk:

```
svcinfo lsmdiskmember mdisk_name | mdisk_id
```

where *mdisk_name* | *mdisk_id* is the name or ID of the MDisk. This displays a list of IDs that correspond to the VDIs that are using this MDisk.

To determine the relationship between MDIs and VDIs and the number of extents that are used by each VDisk, you must use the command-line interface. For each MDisk, issue the following command:

```
svcinfo lsmdiskextent mdisk_name | mdisk_id
```

where *mdisk_name* | *mdisk_id* is the name or ID of the MDisk. This command displays a table of VDisk IDs and the corresponding number of extents being used by each VDisk.

Possible failures

- CMMVC5786E The action failed because the cluster is not in a stable state.
- CMMVC5804E The action failed because an entity that was specified in the command does not exist.
- CMMVC5854E The extent information was not returned because the extent is not used or does not exist.
- CMMVC5855E The extent information was not returned because the managed disk (MDisk) is not used by any virtual disk (VDisk).
- CMMVC5864E The extent information was not returned because the source extent is not used.
- CMMVC5865E The extent information was not returned because the extent is out of range for the managed disk (MDisk) or virtual disk (VDisk).
- CMMVC6005E The view request failed as the specified object is not a member of an appropriate group.
- CMMVC6252E The command failed authorization because the session SSH key is wrong or was deleted.
- CMMVC6253E The command failed authorization because the session SSH key does not have the requisite role.

An invocation example

```
svcinfo lsmdiskextent 2
```

The resulting output

id	number_of_extents
1	1
2	1

lsmdiskgrp

The **lsmdiskgrp** command returns a concise list or a detailed view, of MDisk groups visible to the cluster.

The list report style can be used to obtain two styles of report:

- A list containing concise information about all the managed disk groups in a cluster. (Each entry in the list corresponds to a single managed disk group.)
- The detailed information about a single managed disk group.

Syntax

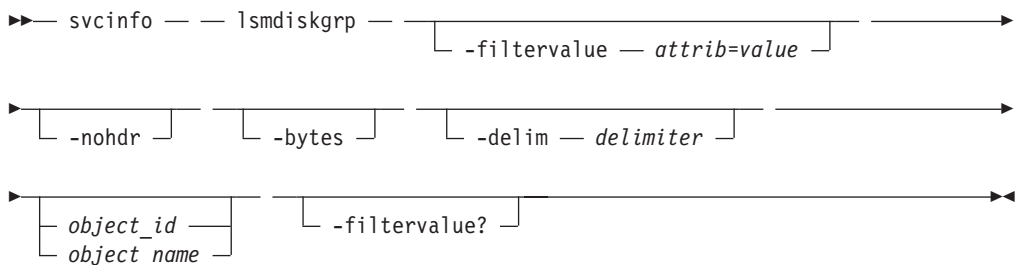

Parameters

-filtervalue *attrib=value*

(Optional) Specifies a list of one or more filters. Only objects with a value that matches the filter attribute value are returned. If a capacity is specified, the units must also be included.

Note: Some filters allow the use of a wildcard when you enter the command. The following rules apply to the use of wildcards with the SAN Volume Controller CLI:

- The wildcard character is an asterisk (*).
- The command can contain a maximum of one wildcard, which must be the first or last character in the string.
- When using a wildcard, you must enclose the filter entry within double quotation marks (""), as follows:

```
svcinfo lsmdiskgrp -filtervalue "name=md*"
```

-nohdr

(Optional) By default, headings are displayed for each column of data in a concise style view, and for each item of data in a detailed style view. The **-nohdr** parameter suppresses the display of these headings.

Note: If there is no data to be displayed, headings are not displayed even if the **-nohdr** parameter is specified.

-bytes

(Optional) Specifies that you want the report to display all capacities as bytes.

-delim *delimiter*

(Optional) By default in a concise view, all columns of data are

space-separated. The width of each column is set to the maximum possible width of each item of data. In a detailed view, each item of data has its own row, and if the headers are displayed the data is separated from the header by a space. The **-delim** parameter overrides this behavior. Valid input for the **-delim** parameter is a one byte character. If you enter `-delim :` on the command line, the colon character (`:`) separates all items of data in a concise view; for example, the spacing of columns does not occur. In a detailed view, the data is separated from its header by the specified delimiter.

object_id | object_name

(Optional) Specifies the name or ID of an object. When you use this parameter, the detailed view of the specific object is returned and any value specified by the **-filtervalue** parameter is ignored. If you do not specify the *object_id | object_name* parameter, the concise view of all objects matching the filtering requirements specified by the **-filtervalue** parameter are displayed.

-filtervalue?

Display a list of valid filter attributes. The valid filters for the **svcinfo lsmdiskgrp** command are:

- name
- storage_pool_id
- mdisk_count
- vdisk_count
- extent_size
- status
- id

Description

This command will return a concise list or a detailed view, of MDisk groups visible to the cluster.

The following list provides possible values that are applicable to the attributes that are displayed as data in the output views:

status online, degraded, offline

Possible failures

- CMMVC5786E The action failed because the cluster is not in a stable state.
- CMMVC5804E The action failed because an entity that was specified in the command does not exist.
- CMMVC6252E The command failed authorization because the session SSH key is wrong or was deleted.
- CMMVC6253E The command failed authorization because the session SSH key does not have the requisite role.

A concise invocation example

```
svcinfo lsmdiskgrp -delim :
```

The concise resulting output

```
id:name:status:mdisk_count:vdisk_count:capacity:extent_size:free_capacity
0:mdiskgrp0:online:5:0:341.8GB:16:341.8GB
1:mdiskgrp1:online:0:0:0:16:0
```

A detailed invocation example

```
svcinfo lsmdiskgrp -delim : 0
```

The detailed resulting output

```
id:0
name:mdiskgrp0
status:online
mdisk_count:5
vdisk_count:0
capacity:341.8GB
extent_size:16
free_capacity:341.8GB
```

lsmdiskmember

The **lsmdiskmember** command displays a list of VDisks that are using extents on the specified MDisk. That is, the virtual disks are using extents on the managed disk that are specified by the MDisk ID.

Syntax

```
▶▶▶ svcinfo — — lsmdiskmember — — [ -nohdr ] —————▶▶▶
▶ [ -delim — delimiter ] [ mdisk_id | mdisk_name ] —————▶▶▶
```

Parameters

-nohdr

(Optional) By default, headings are displayed for each column of data in a concise style view, and for each item of data in a detailed style view. The **-nohdr** parameter suppresses the display of these headings.

Note: If there is no data to be displayed, headings are not displayed even if the **-nohdr** parameter is specified.

-delim *delimiter*

(Optional) By default in a concise view, all columns of data are space-separated. The width of each column is set to the maximum possible width of each item of data. In a detailed view, each item of data has its own row, and if the headers are displayed, the data is separated from the header by a space. The **-delim** parameter overrides this behavior. Valid input for the **-delim** parameter is a one-byte character. If you enter **-delim :** on the command line, the colon character (:) separates all items of data in a concise view; for example, the spacing of columns does not occur. In a detailed view, the data is separated from its header by the specified delimiter.

mdisk_id | *mdisk_name*

(Required) Specifies the ID or name of the MDisk for which you want a list of VDisks that use extents of that MDisk.

Description

This command displays a list of virtual disks that use extents on the managed disk that are specified by the ID. The list displays members of the respective object and is independent of the state of the individual members; that is, if they are in offline state, they are still displayed.

Every VDisk is constructed from one or more MDisks. At times you might have to determine the relationship between the VDisk and the MDisk. The following procedure allows you to determine the relationships.

To determine the relationship between VDIsks and MDisks, issue the following command:

```
svcinfolsvdiskmember vdisk_id | vdisk_name
```

where *vdisk_id* | *vdisk_name* is the name or ID of the VDisk. This displays a list of IDs that correspond to the MDisks that make up the VDisk.

To determine the relationship between VDIsks and MDisks and the number of extents that are provided by each MDisk, you must use the command-line interface. For each VDisk *vdisk_id* | *vdisk_name*, issue the following command:

```
svcinfolsvdiskextent vdisk_id | vdisk_name
```

where *vdisk_id* | *vdisk_name* is the name or ID of the VDisk. This command displays a table of MDisk IDs and the corresponding number of extents that each MDisk provides as storage for the VDisk.

To determine the relationship between MDisks and VDIsks, issue the following command:

```
svcinfolsmdiskmember mdisk_id | mdisk_name
```

where *mdisk_id* | *mdisk_name* is the name or ID of the MDisk. This command displays a list of IDs that correspond to the VDIsks that are using this MDisk.

To determine the relationship between MDisks and VDIsks and the number of extents that are used by each VDisk, you must use the command-line interface. For each MDisk *mdisk_id* | *mdisk_name*, issue the following command:

```
svcinfolsmdiskextent mdisk_id | mdisk_name
```

where *mdisk_id* | *mdisk_name* is the name or ID of the MDisk. This command displays a table of VDisk IDs and the corresponding number of extents being used by each VDisk.

Possible failures

- CMMVC5786E The action failed because the cluster is not in a stable state.
- CMMVC5804E The action failed because an entity that was specified in the command does not exist.
- CMMVC6252E The command failed authorization because the session SSH key is wrong or was deleted.
- CMMVC6253E The command failed authorization because the session SSH key does not have the requisite role.

An invocation example

```
svcinfo lsmdiskmember 1
```

The resulting output

```
id  
0
```

lsmigrate

The **lsmigrate** command displays the progress of all current data migration operations.

Syntax

```
➔ svcinfo - - lsmigrate - [ -nohdr ] [ -delim delimiter ] ➔
```

Parameters

-nohdr

(Optional) By default, headings are displayed for each column of data in a concise style view, and for each item of data in a detailed style view. The **-nohdr** parameter suppresses the display of these headings.

Note: If there is no data to be displayed, headings are not displayed even if the **-nohdr** parameter is specified.

-delim *delimiter*

(Optional) By default in a concise view, all columns of data are space-separated. The width of each column is set to the maximum possible width of each item of data. In a detailed view, each item of data has its own row, and if the headers are displayed, the data is separated from the header by a space. The **-delim** parameter overrides this behavior. Valid input for the **-delim** parameter is a one-byte character. If you enter **-delim :** on the command line, the colon character (:) separates all items of data in a concise view; for example, the spacing of columns does not occur. In a detailed view, the data is separated from its header by the specified delimiter.

If you use multiple threads to migrate data, the progress will increment when all threads have completed the migration of an extent. For large extent sizes with many threads, this can result in quite large increments in the percentage progress.

Description

This command displays information of all the migrations that are currently in progress.

Possible failures

- CMMVC5786E The action failed because the cluster is not in a stable state.
- CMMVC5804E The action failed because an entity that was specified in the command does not exist.
- CMMVC6252E The command failed authorization because the session SSH key is wrong or was deleted.
- CMMVC6253E The command failed authorization because the session SSH key does not have the requisite role.

An invocation example

```
svcinfolsmigrate -delim :
```

The resulting output

```
migrate_type:MDisk_Group_Migration  
progress:96  
migrate_source_vdisk_index:33  
migrate_target_mdisk_grp:4  
max_thread_count:4
```

lsnode

The **lsnode** command returns a concise list or a detailed view of nodes visible to the cluster.

The list report style can be used to obtain two styles of report:

- A list containing concise information about all the nodes on a cluster. (Each entry in the list corresponds to a single node.)
- The detailed information about a single node.

Syntax

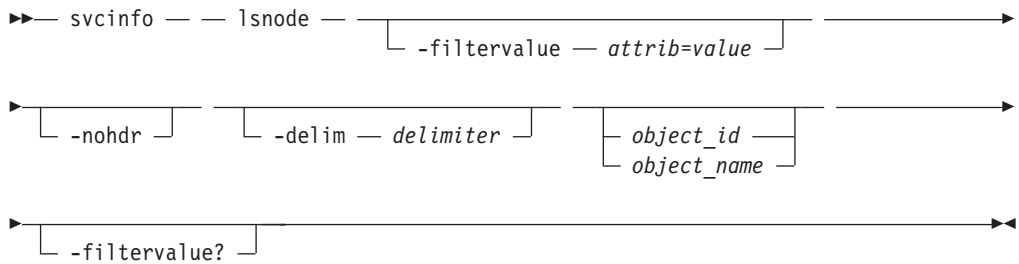

Parameters

-filtervalue *attrib=value*

(Optional) Specifies a list of one or more filters. Only objects with a value that matches the filter attribute value are returned. If a capacity is specified, the units must also be included.

Note: Some filters allow the use of a wildcard when you enter the command. The following rules apply to the use of wildcards with the SAN Volume Controller CLI:

- The wildcard character is an asterisk (*).
- The command can contain a maximum of one wildcard.
- When using a wildcard, you must enclose the filter entry within double quotation marks (""), as follows:

```
svcinfolsmnode -filtervalue "name=md*"
```

-filtervalue?

Displays a list of valid filter attributes for the **-filtervalue** *attribute=value* parameter. The valid filters for the **svcinfolsmnode** command are:

- *node_name*
- *id*
- *status*

- *IO_group_name*
- *IO_group_id*
- *name*
- *hardware*

-nohdr

(Optional) By default, headings are displayed for each column of data in a concise style view, and for each item of data in a detailed style view. The **-nohdr** parameter suppresses the display of these headings.

Note: If there is no data to be displayed, headings are not displayed even if the **-nohdr** parameter is specified.

-delim *delimiter*

(Optional) By default in a concise view, all columns of data are space-separated. The width of each column is set to the maximum possible width of each item of data. In a detailed view, each item of data has its own row, and if the headers are displayed the data is separated from the header by a space. The **-delim** parameter overrides this behavior. Valid input for the **-delim** parameter is a one-byte character. If you enter **-delim :** on the command line, the colon character (:) separates all items of data in a concise view; for example, the spacing of columns does not occur. In a detailed view, the data is separated from its header by the specified delimiter.

object_id | *object_name*

(Optional) Specifies the name or ID of an object. When you use this parameter, the detailed view of the specific object is returned and any value that is specified by the **-filtervalue** parameter is ignored. If you do not specify the *object_id* | *object_name* parameter, the concise view of all objects matching the filtering requirements that is specified by the **-filtervalue** parameter are displayed.

Description

This command returns a concise list or a detailed view of nodes visible to the cluster. The following table provides the possible values that are applicable to the attributes that are displayed as data in the output views:

Table 7. *svcinfo lsnode* attribute values. *svcinfo lsnode* command attribute values

Attribute	Value
<i>status</i>	offline flushing pending online adding deleting
<i>config_node</i>	no yes
<i>port_status</i>	active inactive not installed
<i>hardware</i>	4F2 8F2 8F4 8G4 other

To determine a node’s WWPNS, enter the following command:

```
svcinfo lsnode
```

Note: Record the node name or ID because you use this value in the next step. For the node or nodes in question, issue the following command:

```
svcinfo lsnode node_name | node_id
```

where *node_name* | *node_id* is the node name or ID.

Note: Record the four port IDs (WWPNs).

Attention: If the node is in the adding state, the WWPN is displayed as 0000000000000000. Once the node has successfully become a member of the cluster, the state changes to online and the WWPN is displayed correctly.

Possible failures

- CMMVC5786E The action failed because the cluster is not in a stable state.
- CMMVC5804E The action failed because an entity that was specified in the command does not exist.
- CMMVC6252E The command failed authorization because the session SSH key is wrong or was deleted.
- CMMVC6253E The command failed authorization because the session SSH key does not have the requisite role.

A concise invocation example

```
svcinflsnode -delim :
```

The concise resulting output

```
id:name: UPS_serial_number: WWNN:
status: IO_group_id: IO_group_name:
config_node: UPS_unique_id: hardware
1:node1: UPS_SN: 5005076801000024:
online: 0: io_grp0: yes:
1000000000000024: other
```

A detailed invocation example

```
svcinflsnode -delim:1
```

The detailed resulting output

```
id=1
name=node1
UPS_serial_number=UPS_Fake_SN
WWNN=50050768010007E5
status=online
IO_group_id=0
IO_group_name=io_grp0
partner_node_id=
partner_node_name=
config_node=yes
UPS_unique_id=10000000000007E5
port_id=50050768011007E5
port_status=active
port_speed=2
port_id=50050768012007E5
port_status=inactive
port_speed=2
port_id=50050768013007E5
port_status=not_installed
port_speed=2
port_id=50050768014007E5
port_status=not_installed
port_speed=2
hardware=8F2
```

Isnodecandidate

The **Isnodecandidate** command lists all of the nodes that are not assigned to a cluster.

Syntax

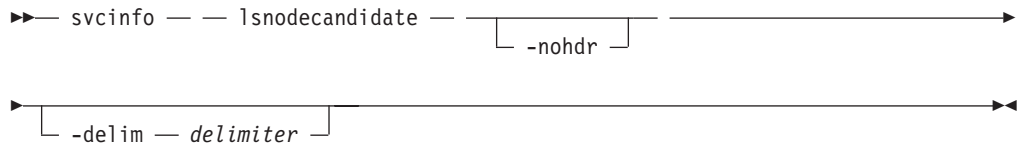

Parameters

-nohdr

(Optional) By default, headings are displayed for each column of data in a concise style view, and for each item of data in a detailed style view. The **-nohdr** parameter suppresses the display of these headings.

Note: If there is no data to be displayed, headings are not displayed even if the **-nohdr** parameter is specified.

-delim *delimiter*

(Optional) By default in a concise view, all columns of data are space-separated. The width of each column is set to the maximum possible width of each item of data. In a detailed view, each item of data has its own row, and if the headers are displayed, the data is separated from the header by a space. The **-delim** parameter overrides this behavior. Valid input for the **-delim** parameter is a one-byte character. If you enter **-delim :** on the command line, the colon character (:) separates all items of data in a concise view; for example, the spacing of columns does not occur. In a detailed view, the data is separated from its header by the specified delimiter.

Description

This command displays a list of nodes that are not assigned to a cluster.

Possible failures

- CMMVC5786E The action failed because the cluster is not in a stable state.
- CMMVC5804E The action failed because an entity that was specified in the command does not exist.
- CMMVC6252E The command failed authorization because the session SSH key is wrong or was deleted.
- CMMVC6253E The command failed authorization because the session SSH key does not have the requisite role.

An invocation example

```
svcinfo lsnodecandidate -delim :
```

The resulting output

```
id: panel_name: UPS_serial_number:  
UPS_unique_id: hardware  
50050768010000EF: oneg55:  
UPS_Fake_SN:10000000000000EF: other
```

lsnodevdpd

The **lsnodevdpd** command displays the vital product data (VPD) for each node.

Syntax

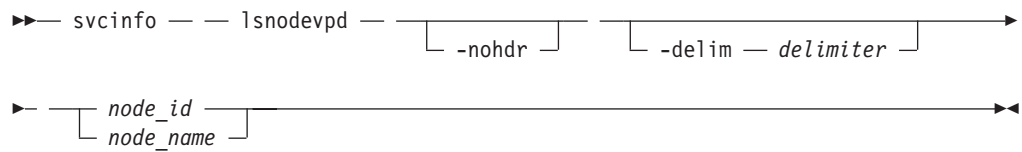

Parameters

-nohdr

(Optional) By default, headings are displayed for each column of data in a concise style view, and for each item of data in a detailed style view. The **-nohdr** parameter suppresses the display of these headings.

Note: If there is no data to be displayed, headings are not displayed even if the **-nohdr** parameter is specified.

-delim delimiter

(Optional) By default in a concise view, all columns of data are space-separated. The width of each column is set to the maximum possible width of each item of data. In a detailed view, each item of data has its own row, and if the headers are displayed, the data is separated from the header by a space. Using the **-delim** parameter overrides this behavior. Valid input for the **-delim** parameter is a one-byte character. If you enter **-delim :** on the command line, the colon character (:) separates all items of data in a concise view; for example, the spacing of columns does not occur. In a detailed view, the data is separated from its header by the specified delimiter.

node_id | node_name

(Required) Specifies the node by its ID or name.

Description

This command displays the VPD for the specified node. Each field is reported on a new line. All fields are strings. The VPD is split into sections. Each section has a section heading. The number of fields in that section follows each heading. Each section is separated by an empty line.

For example:

```
section name:3 fields
field1:value
field2:value
field3:value
```

```
new section:x fields
```

```
...
```

Some sections contain information about multiple objects of that type. Each object within the section is separated by an empty line.

For example:

```
section name:4 fields
object1 field1:value
object1 field2:value
```

object2 field1:value
object2 field2:value

new section: x fields

...

Note: For 8F4 and 8G4 nodes, the VPD displays the device serial number of the fibre-channel card as N/A.

Possible failures

- CMMVC5786E The action failed because the cluster is not in a stable state.
- CMMVC5804E The action failed because an entity that was specified in the command does not exist.
- CMMVC6252E The command failed authorization because the session SSH key is wrong or was deleted.
- CMMVC6253E The command failed authorization because the session SSH key does not have the requisite role.

An invocation example

```
svcinfo lsnodevpd 1
```

The resulting output

```
id 1
```

```
system board: 17 fields
```

```
part_number Unknown  
system_serial_number 550117N  
number_of_processors 2  
number_of_memory_slots 4  
number_of_fans 0  
number_of_FC_cards 1  
  
number_of_scsi/ide_devices 2  
BIOS_manufacturer IBM  
BIOS_version -[QAE115AUS-1.01]-  
BIOS_release_date 08/16/2001  
system_manufacturer IBM  
system_product eserver xSeries 342 -[86691RX]-  
planar_manufacturer IBM  
power_supply_part_number Unknown  
CMOS_battery_part_number Unknown  
power_cable_assembly_part_number Unknown  
service_processor_firmware N/A
```

```
processor: 6 fields  
processor_location Processor 1  
number_of_caches 2
```

```
manufacturer GenuineIntel  
version Pentium III  
speed 1000  
status Enabled  
processor cache: 4 fields  
type_of_cache Internal L1 Cache  
size_of_cache (KB) 32
```

```
type_of_cache Internal L2 Cache  
size_of_cache (KB) 256
```

```

processor: 6 fields
processor_location Processor 2
number_of_caches 2
manufacturer GenuineIntel
version Pentium III
speed 1000
status Enabled

processor cache: 4 fields
type_of_cache Internal L1 Cache
size_of_cache (KB) 32

type_of_cache Internal L2 Cache
size_of_cache (KB) 256
memory module: 16 fields
part_number 33L5039
device_location J1
bank_location Slot1 in bank 1
size (MB) 1024
part_number 33L5039
device_location J4
bank_location Slot2 in bank 1
size (MB) 1024

part_number N/A
device_location J2
bank_location Slot1 in bank 2
size (MB) 0

part_number N/A
device_location J3
bank_location Slot2 in bank 2
size (MB) 0

FC card: 5 fields
part_number 64P7783
port_numbers 1 2
device_serial_number VSI 0000AD3F4
manufacturer Agilent
device DX2
device: 15 fields
part_number Unknown
bus ide0
device 0
model LG CD-ROM CRN-8245B
revision 1.13
serial_number
approx_capacity 0
part_number Unknown
bus scsi
device 0
device_vendor IBM-ESXS
model ST318305LC !#
revision 6C48
serial_number 3JKQ93B903196C48
approx_capacity 8
software: 5 fields
code_level 00000000
node_name node1
ethernet_status 1
WWNN 0x50050768010007e5

id 1

front panel assembly: 3 fields
part_number Unknown
front_panel_id lynn02

```

```
front_panel_locale en_US
UPS: 10 fields
electronics_assembly_part_number FakElec
battery_part_number FakBatt
frame_assembly_part_number FakFram
input_power_cable_part_number FakCabl
UPS_serial_number UPS_Fake_SN
UPS_type Fake UPS
UPS_internal_part_number UPS_Fake_PN
UPS_unique_id 0x10000000000007e5
UPS_main_firmware 1.4
UPS_comms_firmware 0.0
```

lsrconsistgrp

The **lsrconsistgrp** command returns a concise list or a detailed view of Metro or Global Mirror consistency groups visible to the cluster.

The list report style can be used to obtain two styles of report:

- A list containing concise information about all the Metro or Global Mirror consistency groups visible to the cluster. (Each entry in the list corresponds to a single Metro or Global Mirror consistency group.)
- The detailed information about a single Metro or Global Mirror consistency group.

Syntax

```

>>> svcinfo -- lsrconsistgrp -- [-filtervalue -- attrib=value]
                                     |
                                     |
                                     |
<----->
|-----|-----|-----|-----|-----|-----|-----|-----|-----|-----|
| -nohdr | | -delim -- delimiter | | object_id | | object_name | | | |
|---|---|---|---|---|---|---|---|---|---|
|-----|-----|-----|-----|-----|-----|-----|-----|-----|-----|
| -filtervalue? |
|-----|-----|-----|-----|-----|-----|-----|-----|-----|-----|

```

Parameters

-filtervalue *attrib=value*

(Optional) Specifies a list of one or more filters. Only objects with a value that matches the filter attribute value are displayed. If a capacity is specified, the units must also be included.

Note: Some filters allow the use of a wildcard when you enter the command. The following rules apply to the use of wildcards with the SAN Volume Controller CLI:

- The wildcard character is an asterisk (*).
- The command can contain a maximum of one wildcard, which must be the first or last character in the string.
- When using a wildcard, you must enclose the filter entry with double quotation marks (""), as follows:

```
svcinfo lsrconsistgrp -filtervalue "name=md*"
```

-nohdr

(Optional) By default, headings are displayed for each column of data in a

concise style view, and for each item of data in a detailed style view. The **-nohdr** parameter suppresses the display of these headings.

Note: If there is no data to be displayed, headings are not displayed even if the **-nohdr** parameter is specified.

-delim *delimiter*

(Optional) By default in a concise view, all columns of data are space-separated. The width of each column is set to the maximum possible width of each item of data. In a detailed view, each item of data has its own row, and if the headers are displayed the data is separated from the header by a space. The **-delim** parameter overrides this behavior. Valid input for the **-delim** parameter is a one-byte character. If you enter **-delim :** on the command line, the colon character (:) separates all items of data in a concise view; for example, the spacing of columns does not occur. In a detailed view, the data is separated from its header by the specified delimiter.

object_id | object_name

(Optional) Specifies the name or ID of an object. When you use this parameter, the detailed view of the specific object is displayed and any value that is specified by the **-filtervalue** parameter is ignored. If you do not specify the *object_id | object_name* parameter, the concise view of all objects matching the filtering requirements that is specified by the **-filtervalue** parameter are displayed.

-filtervalue?

(Optional) Specifies that you want your report to display any or all of the list of valid filter attributes. The following filter attributes for the **lsrconsistgrp** command are valid:

- group_id
- name
- master_cluster_id
- master_cluster_name
- aux_cluster_id
- aux_cluster_name
- primary
- state
- relationship_count
- id
- copy_type

Description

This command returns a concise list or a detailed view of Metro or Global Mirror consistency groups that are visible to the cluster.

The following table provides possible values that are applicable to the attributes that are displayed as data in the output views:

Table 8. lsrconsistgrp command output values. lsrconsistgrp output data attribute values

Attribute	Value
primary	n/a, master, aux

Table 8. **lsrconsistgrp** command output values (continued). **lsrconsistgrp** output data attribute values

Attribute	Value
state	inconsistent_stopped, inconsistent_copying, consistent_stopped, consistent_synchronized, idling, idling_disconnected, inconsistent_disconnected consistent_disconnected, empty
freeze_time	The time in YY/MM/DD/HH/MM format.
status	online, primary_offline, secondary_offline
sync	in_sync, out_of_sync
copy_type	metro, global, empty_group

Note: The names of the Metro or Global Mirror relationships and consistency groups might be blank if the relationship or consistency groups are intercluster and the cluster partnership is disconnected.

Possible failures

- CMMVC5786E The action failed because the cluster is not in a stable state.
- CMMVC5804E The action failed because an entity that was specified in the command does not exist.
- CMMVC6252E The command failed authorization because the session SSH key is wrong or was deleted.
- CMMVC6253E The command failed authorization because the session SSH key does not have the requisite role.

A concise invocation example

```
svcinfo lsrconsistgrp -delim :
```

The concise resulting output

```
id:name:master_cluster_id:master_cluster_name:aux_cluster_id:aux_cluster_name:primary:state:relationship_count:copy_type
248:jdemo_BA_cons1:0000020060406746:clusterB:0000020061413ABA:clusterA:master:consistent_stopped:2:global
249:rccstgrp0:0000020061413ABA:clusterA:0000020061413ABA:clusterA::empty:0:empty_group
250:jdemo_BA_cons2:0000020060406746:clusterB:0000020061413ABA:clusterA:master:inconsistent_stopped:1:metro
251:BA_cons1:0000020060406746:clusterB:0000020061413ABA:clusterA:master:consistent_stopped:4:metro
252:AB_cons2:0000020061413ABA:clusterA:0000020060406746:clusterB::empty:0:empty_group
253:AB_cons1:0000020061413ABA:clusterA:0000020060406746:clusterB:aux:consistent_stopped:3:global
254:AA_cons2:0000020061413ABA:clusterA:0000020061413ABA:clusterA::empty:0:empty_group
255:AA_cons1:0000020061413ABA:clusterA:0000020061413ABA:clusterA:master:consistent_synchronized:2:global
```

A detailed invocation example

```
svcinfo lsrconsistgrp -delim : 254
```

The detailed resulting output

```
id:254
name:rccstgrp0
master_cluster_id:0000010030A007E5
```

```

master_cluster_name:kkk
aux_cluster_id:0000010030A007E5
aux_cluster_name:kkk
primary:master
state:inconsistent_stopped
relationship_count:1
freeze_time:
status:online
sync:
copy_type:metro
RC_rel_id:2
RC_rel_name:aaa

```

lsrcrelationship

The **lsrcrelationship** command returns a concise list or a detailed view of Metro or Global Mirror relationships visible to the cluster.

The list report style can be used to obtain two styles of report:

- A list containing concise information about all the Metro or Global Mirror relationships visible to the cluster. (Each entry in the list corresponds to a single Metro or Global Mirror relationship.)
- The detailed information about a single Metro or Global Mirror relationship.

Syntax

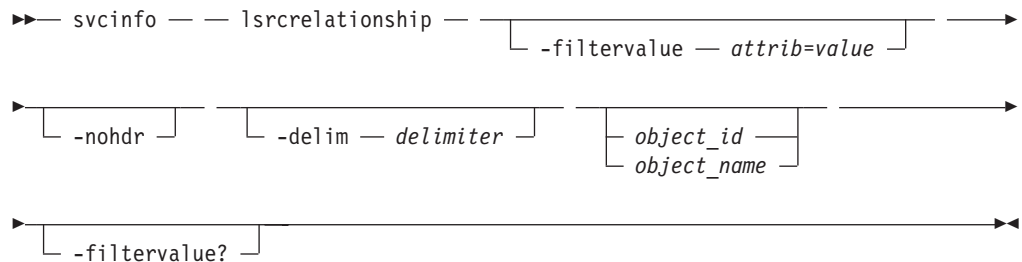

Parameters

-filtervalue *attribute=value*

(Optional) Specifies a list of one or more filters. Only objects with a value that matches the filter attribute value are returned. If a capacity is specified, the units must also be included.

Note: Some filters allow the use of a wildcard when you enter the command. The following rules apply to the use of wildcards with the SAN Volume Controller CLI:

- The wildcard character is an asterisk (*).
- The command can contain a maximum of one wildcard, which must be the first or last character in the string.
- When using a wildcard, you must enclose the filter entry with double quotation marks (" "), as follows:

```
svcinfo lsrcrelationship -filtervalue "name=md*"
```

-nohdr

(Optional) By default, headings are displayed for each column of data in a concise style view, and for each item of data in a detailed style view. The **-nohdr** parameter suppresses the display of these headings.

Note: If there is no data to be displayed, headings are not displayed even if the **-nohdr** parameter is specified.

-delim *delimiter*

(Optional) By default in a concise view, all columns of data are space-separated. The width of each column is set to the maximum possible width of each item of data. In a detailed view, each item of data has its own row, and if the headers are displayed the data is separated from the header by a space. The **-delim** parameter overrides this behavior. Valid input for the **-delim** parameter is a one-byte character. If you enter **-delim :** on the command line, the colon character (:) separates all items of data in a concise view; for example, the spacing of columns does not occur. In a detailed view, the data is separated from its header by the specified delimiter.

object_id | object_name

(Optional) Specifies the name or ID of an object. When you use this parameter, the detailed view of the specific object is returned and any value that is specified by the **-filtervalue** parameter is ignored. If you do not specify the *object_id | object_name* parameter, the concise view of all objects matching the filtering requirements that are specified by the **-filtervalue** parameter are displayed.

-filtervalue?

(Optional) Specifies that you want your report to display any or all of the list of valid filter attributes. The valid filter attributes for the **svcinfo lsrelationship** command are:

- RC_rel_id
- RC_rel_name
- master_cluster_id
- master_cluster_name
- master_vdisk_id
- master_vdisk_name
- aux_cluster_id
- aux_cluster_name
- aux_vdisk_id
- aux_vdisk_name
- primary
- consistency_group_id
- consistency_group_name
- state
- progress
- copy_type

Description

This command returns a concise list or a detailed view of Metro or Global Mirror relationships visible to the cluster.

The following table provides possible values that are applicable to the attributes that are displayed as data in the output views:

Table 9. `lsrrelationship` command attributes and values. `lsrrelationship` output data

Attribute	Value
primary	n/a, master, aux
state	inconsistent_stopped, inconsistent_copying, consistent_stopped, consistent_synchronized, idling, idling_disconnected, inconsistent_disconnected, consistent_disconnected
progress	0-100, n/a
freeze time	The time in YY/MM/DD/HH/MM format.
status	online, primary_offline, secondary_offline
sync	n/a, in_sync, out_of_sync
copy_type	metro, global

Note: The names of the Metro or Global Mirror relationships and consistency groups can be blank if the relationship or consistency groups are inter-cluster and the cluster partnership is disconnected.

Possible failures

- CMMVC5786E The action failed because the cluster is not in a stable state.
- CMMVC5804E The action failed because an entity that was specified in the command does not exist.
- CMMVC6252E The command failed authorization because the session SSH key is wrong or was deleted.
- CMMVC6253E The command failed authorization because the session SSH key does not have the requisite role.

A concise and detailed invocation example

```
svcinfo lsrrelationship -delim : -filtervalue name=j*
```

The concise and detailed resulting output

```
id:name:master_cluster_id:master_cluster_name:master_vdisk_id:master_vdisk_name:
aux_cluster_id:aux_cluster_name:aux_vdisk_id:
aux_vdisk_name:primary:consistency_group_id:consistency_group_name:state:bg_copy
_priority:progress: copy_type
45:jrel_AB1:0000020061413ABA:clusterA:45:jdisk_B8:0000020060406746:clusterB:38:j
disk_B1:master:::consistent_stopped:50:metro
48:jrel_AB2:0000020061413ABA:clusterA:48:jdisk_A4:0000020060406746:clusterB:41:j
disk_B4:master:::consistent_synchronised:50:metro
49:jrel_BA_1:0000020060406746:clusterB:42:jdisk_B5:0000020061413ABA:clusterA:49:j
disk_A5:master:248:jdemo_BA_cons1:consistent_stopped:50:metro
50:jrel_BA_2:0000020060406746:clusterB:43:jdisk_B6:0000020061413ABA:clusterA:
50:jdisk_A6:master:248:jdemo_BA_cons1:consistent_stopped:50:metro
```

A detailed invocation example

```
svcinfo lsrrelationship -delim : AB_2
```

The detailed resulting output

```
id:9
name:AB_2
master_cluster_id:0000020061413ABA
master_cluster_name:clusterA
master_vdisk_id:9
master_vdisk_name:stripe9
aux_cluster_id:0000020060406746
aux_cluster_name:clusterB
```

```

aux_vdisk_id:9
aux_vdisk_name:stripe9_b
primary:master
consistency_group_id:
consistency_group_name:
state:consistent_stopped
bg_copy_priority:50
progress:
freeze_time:2006/05/05/08/26/46
status:secondary_offline
sync:in_sync
copy_type:metro

```

lsrrelationshipcandidate

The **lsrrelationshipcandidate** command lists VDisks that are eligible to form Metro or Global Mirror relationships. You can list eligible VDisks that are on the local or remote cluster.

Syntax

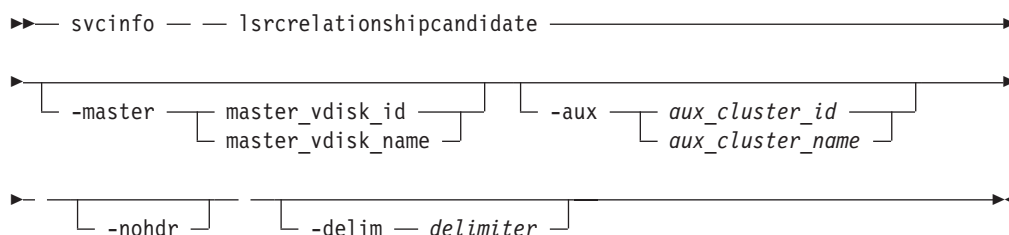

Parameters

-master *master_vdisk_id* | *master_vdisk_name*

(Required) Specifies a particular VDisk to use as the master VDisk. The command finds candidates that match the size of this VDisk. If you are requesting candidate VDisks on the local cluster, this command also matches the io_group.

-aux *aux_cluster_id* | *aux_cluster_name*

(Required) Specifies a remote cluster with VDisk candidates for an intercluster relationship. If you do not specify this parameter, the candidates on the local cluster are displayed.

-nohdr

(Optional) By default, headings are displayed for each column of data in a concise style view, and for each item of data in a detailed style view. The **-nohdr** parameter suppresses the display of these headings.

Note: If there is no data to be displayed, headings are not displayed even if the **-nohdr** parameter is specified.

-delim *delimiter*

(Optional) By default in a concise view, all columns of data are space-separated. The width of each column is set to the maximum possible width of each item of data. In a detailed view, each item of data has its own row, and if the headers are displayed, the data is separated from the header by a space. The **-delim** parameter overrides this behavior. Valid input for the **-delim** parameter is a one-byte character. If you enter **-delim :** on the command line, the colon character (:) separates all items of data in a concise

view; for example, the spacing of columns does not occur. In a detailed view, the data is separated from its header by the specified delimiter.

Description

This command displays a list of VDisks that can be either the master or the auxiliary disk for a Metro or Global Mirror relationship. VDisk IDs and names are displayed.

Possible failures

- CMMVC5786E The action failed because the cluster is not in a stable state.
- CMMVC5804E The action failed because an entity that was specified in the command does not exist.
- CMMVC6252E The command failed authorization because the session SSH key is wrong or was deleted.
- CMMVC6253E The command failed authorization because the session SSH key does not have the requisite role.

An invocation example

```
svcinfo lsrelationshipcandidate -delim :
```

The resulting output

```
id:vdisk_name  
0:vdisk0  
4:vdisk4
```

lsrelationshipprogress

You can use the **lsrelationshipprogress** command to display the progress of the background copy of a Metro Mirror or Global Mirror relationship as a percentage. When the initial background copy process for a relationship has completed, null is displayed for the progress of that relationship.

Syntax

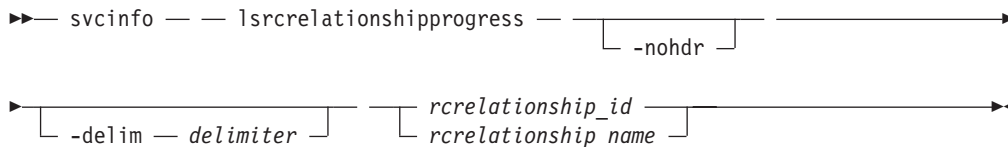
```
svcinfo -- lsrelationshipprogress -- 
```

Parameters

-nohdr

(Optional) By default, headings are displayed for each column of data in a concise style view, and for each item of data in a detailed style view. The **-nohdr** parameter suppresses the display of these headings.

Note: If there is no data to be displayed, headings are not displayed even if the **-nohdr** parameter is specified.

-delim *delimiter*

(Optional) By default in a concise view, all columns of data are space-separated. The width of each column is set to the maximum possible width of each item of data. In a detailed view, each item of data has its own

row, and if the headers are displayed, the data is separated from the header by a space. The **-delim** parameter overrides this behavior. Valid input for the **-delim** parameter is a one-byte character. If you enter **-delim :** on the command line, the colon character (:) separates all items of data in a concise view; for example, the spacing of columns does not occur. In a detailed view, the data is separated from its header by the specified delimiter.

rrelationship_id | rrelationship_name

Specifies the object ID or name of the specified type.

Description

This command displays the progress of the background copy of a Metro Mirror or Global Mirror relationship as a percentage.

Possible failures

- CMMVC5786E The action failed because the cluster is not in a stable state.
- CMMVC5804E The action failed because an entity that was specified in the command does not exist.
- CMMVC6252E The command failed authorization because the session SSH key is wrong or was deleted.
- CMMVC6253E The command failed authorization because the session SSH key does not have the requisite role.

An invocation example

```
svcinfo lsrelationshipprogress -delim : 0
```

The resulting output

```
id:progress  
0:58
```

lssoftwaredumps

Use the **lssoftwaredumps** command to display a list of software packages from the `/home/admin/upgrade` directory.

Syntax

```
▶▶ svcinfo — lssoftwaredumps — [ -nohdr ] —————▶  
  
▶ [ -delim — delimiter ] [ node_id — node_name ] —————▶▶
```

Parameters

-nohdr

(Optional) By default, headings are displayed for each column of data in a concise style view, and for each item of data in a detailed style view. The **-nohdr** parameter suppresses the display of these headings.

Note: If there is no data to be displayed, headings are not displayed even if the **-nohdr** parameter is specified.

-delim *delimiter*

(Optional) By default in a concise view, all columns of data are space-separated. The width of each column is set to the maximum possible width of each item of data. In a detailed view, each item of data has its own row, and if the headers are displayed, the data is separated from the header by a space. The **-delim** parameter overrides this behavior. Valid input for the **-delim** parameter is a one-byte character. If you enter **-delim :** on the command line, the colon character (:) separates all items of data in a concise view; for example, the spacing of columns does not occur. In a detailed view, the data is separated from its header by a colon character.

node_id | *node_name*

(Optional) Specifies the node ID or name to list the available dumps of the specific type. If you do not specify a node, the dumps that are available on the configuration node are listed.

Description

This command displays a list of software upgrade packages. These packages are copied as a result of software upgrades. If you do not specify a node, the packages that are available on the configuration node are listed. The command displays files from the `/home/admin/upgrade` directory.

Possible failures

- CMMVC5786E The action failed because the cluster is not in a stable state.
- CMMVC6252E The command failed authorization because the session SSH key is wrong or was deleted.
- CMMVC6253E The command failed authorization because the session SSH key does not have the requisite role.

An invocation example

```
svcinfo lssoftware.dumps
```

The resulting output

id	software_filename
0	s1_mala75_030405_092143
1	s2_mala75_030405_092145
2	s3_mala75_030405_092146

lssshkeys

Use the **lssshkeys** command to display a list of SSH (secure shell) keys that are available on the cluster.

Syntax

```
▶▶▶ svcinfo — — lssshkeys — — -user [ admin | service | all ] — — -nohdr ]▶▶▶
▶▶▶ [ -delim — delimiter ]▶▶▶
```

Parameters

-user *admin | service | all*

(Required) Specifies whether you want to see a list of keys that can be used by only a service user or an admin user or the list for both user types.

-nohdr

(Optional) By default, headings are displayed for each column of data in a concise style view, and for each item of data in a detailed style view. The **-nohdr** parameter suppresses the display of these headings.

Note: If there is no data to be displayed, headings are not displayed even if the **-nohdr** parameter is specified.

-delim *delimiter*

(Optional) By default in a concise view, all columns of data are space-separated. The width of each column is set to the maximum possible width of each item of data. In a detailed view, each item of data has its own row, and if the headers are displayed, the data is separated from the header by a space. The **-delim** parameter overrides this behavior. Valid input for the **-delim** parameter is a one-byte character. If you enter **-delim :** on the command line, the colon character (:) separates all items of data in a concise view; for example, the spacing of columns does not occur. In a detailed view, the data is separated from its header by a colon character.

Description

This command displays a list of all the keys that are available on the cluster for the specified user ID.

Possible failures

- CMMVC5786E The action failed because the cluster is not in a stable state.
- CMMVC6252E The command failed authorization because the session SSH key is wrong or was deleted.
- CMMVC6253E The command failed authorization because the session SSH key does not have the requisite role.

An invocation example

```
svcinflssshkeys -user all -delim :
```

The resulting output

```
id:userid_key:identifier  
1:admin:admin
```

lstimezones

The **lstimezones** command lists the time zones that are available on the cluster. Each timezone is assigned an ID that can be used in the **svctask settimezone** command to set the time zone.

Syntax

```
▶▶ svcinfl — — lstimezones — — [ -nohdr ] [ -delim — delimiter ] ▶▶
```

Parameters

-nohdr

(Optional) By default, headings are displayed for each column of data in a concise style view, and for each item of data in a detailed style view. The **-nohdr** parameter suppresses the display of these headings.

Note: If there is no data to be displayed, headings are not displayed even if the **-nohdr** parameter is specified.

-delim delimiter

(Optional) By default in a concise view, all columns of data are space-separated. The width of each column is set to the maximum possible width of each item of data. In a detailed view, each item of data has its own row, and if the headers are displayed, the data is separated from the header by a space. The **-delim** parameter overrides this behavior. Valid input for the **-delim** parameter is a one-byte character. If you enter **-delim :** on the command line, the colon character (:) separates all items of data in a concise view; for example, the spacing of columns does not occur. In a detailed view, the data is separated from its header by a colon character.

Description

This command displays a list of all the time zones that are available on the cluster. Each time zone is assigned an ID. This ID can be used in the **svctask settimezone** command.

Possible failures

- CMMVC5786E The action failed because the cluster is not in a stable state.
- CMMVC6252E The command failed authorization because the session SSH key is wrong or was deleted.
- CMMVC6253E The command failed authorization because the session SSH key does not have the requisite role.

An invocation example

```
svcinfolsttimezones
```

The resulting output

```
id timezone
0 Africa/Abidjan
1 Africa/Accra
2 Africa/Addis_Ababa
3 Africa/Algiers
4 Africa/Asmera
5 Africa/Bamako
6 Africa/Bangui
```

lsvdisk

The **lsvdisk** command displays a concise list or a detailed view of VDisks that are recognized by the cluster.

The list report style can be used to obtain two different styles of report.

- A list containing concise information about all the virtual disks that are recognized by the cluster. (Each entry in the list corresponds to a single virtual disk.)

- The detailed information about a single virtual disk.

Syntax

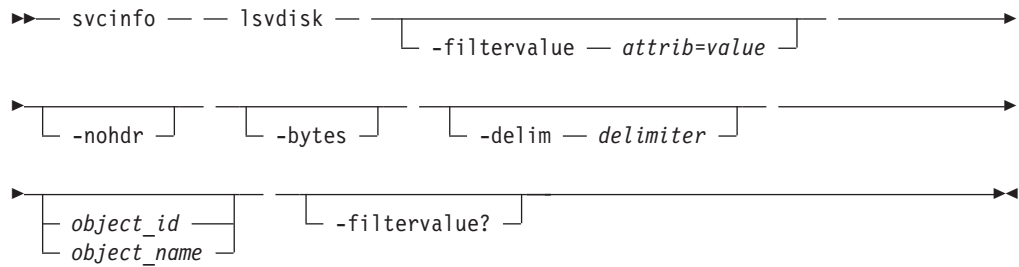

Parameters

-filtervalue *attrib=value*

(Optional) Specifies a list of one or more filters. Only objects with a value that matches the filter attribute value are displayed. If a capacity is specified, the units must also be included.

-nohdr

(Optional) By default, headings are displayed for each column of data in a concise style view, and for each item of data in a detailed style view. The **-nohdr** parameter suppresses the display of these headings.

Note: If there is no data to be displayed, headings are not displayed even if the **-nohdr** parameter is specified.

-bytes

(Optional) Displays all capacities as bytes.

-delim *delimiter*

(Optional) By default in a concise view, all columns of data are space-separated. The width of each column is set to the maximum possible width of each item of data. In a detailed view, each item of data has its own row, and if the headers are displayed, the data is separated from the header by a space. The **-delim** parameter overrides this behavior. Valid input for the **-delim** parameter is a one-byte character. If you enter **-delim :** on the command line, the colon character (:) separates all items of data in a concise view; for example, the spacing of columns does not occur. In a detailed view, the data is separated from its header by the specified delimiter.

object_id | object_name

(Optional) Specifies the name or ID of an object. When you use this parameter, the detailed view of the specific object is returned and any value that is specified by the **-filtervalue** parameter is ignored. If you do not specify the *object_id | object_name* parameter, the concise view of all objects matching the filtering requirements that is specified by the **-filtervalue** parameter are displayed.

-filtervalue?

(Optional) Displays a list of valid filter attributes. The following filters for the **svcinfo lsvdisk** command are valid:

- vdisk_name
- vdisk_id
- vdisk_UID
- IO_group_id

- IO_group_name
- status
- mdisk_grp_name
- mdisk_grp_id
- capacity
- type
- FC_id
- FC_name
- RC_id
- RC_name
- name
- id
- fcmmap_count

Description

This command displays a concise list or a detailed view of VDisks that are recognized by the cluster.

The following table provides possible values that are applicable to the attributes that are displayed as data in the output views:

Table 10. Isvdisk attribute values. Isvdisk command output view data

Attribute	Value
status	offline, online, degraded
capacity	Rounded to GB (2 decimal places) or MB if less than 1GB.
type	sequential, striped, image
formatted	no, yes
mdisk id	Not used for striped
mdisk name	Not used for striped
cache	read-write none

The VDisk is offline and unavailable if one of the following take place:

- If both nodes in the I/O group are missing
- None of the nodes in the I/O group that are present can access the VDisk.

A VDisk is reported as degraded if the following happened:

- One of the nodes in the I/O group is missing.
- One of the nodes in the I/O group cannot access all the MDisks in the MDisk group that the VDisk spans. In this case MDisks are shown as degraded and the DMPs for MDisks should be followed to resolve the problem.
- The fast write cache pins data for one or more VDisks in the I/O group and is unable to perform a failback until the situation is resolved. An error log indicating that the cache has pinned data is displayed. Follow the directed maintenance procedures for this error log to resolve the problem. The most common causes of pinned data are the following:
 - One or more VDisks in an I/O group is offline due to an asymmetric failure and has pinned data in the cache. Asymmetric failures can occur because of SAN fabric faults or misconfiguration, back-end controller faults or

misconfiguration or because repeated errors has lead to the cluster excluding access to a MDisk through one or more nodes.

- One or more VDisks in an I/O group is offline due to a problem with a FlashCopy mapping.

Possible failures

- CMMVC5786E The action failed because the cluster is not in a stable state.
- CMMVC5804E The action failed because an entity that was specified in the command does not exist.
- CMMVC6252E The command failed authorization because the session SSH key is wrong or was deleted.
- CMMVC6253E The command failed authorization because the session SSH key does not have the requisite role.

A concise invocation example

```
svcinfo lsvdisk -delim :
```

The concise resulting output

```
id:name:IO_group_id:IO_group_name:status:mdisk_grp_id:mdisk_grp_name:capacity:type:FC_id:
FC_name:RC_id:RC_name:vdisk_UID:fcmap_count
0:vdisk0:0:io_grp0:degraded:0:mdiskgrp0:16.0MB:striped::::60050768017F06BF78000000000000000
1:vdisk1:0:io_grp0:degraded:0:mdiskgrp0:16.0MB:striped::::60050768017F06BF78000000000000001
2:vdisk2:0:io_grp0:degraded:0:mdiskgrp0:16.0MB:striped::::60050768017F06BF78000000000000002
3:vdisk3:0:io_grp0:degraded:0:mdiskgrp0:16.0MB:striped::::60050768017F06BF78000000000000003
```

A detailed invocation example

```
svcinfo lsvdisk -delim : 1
```

The detailed resulting output

```
svcinfo lsvdisk -delim : 1
id:1
name:vdisk1
IO_group_id:0
IO_group_name:io_grp0
status:degraded
mdisk_grp_id:0
mdisk_grp_name:mdiskgrp0
capacity:16.0MB
type:striped
formatted:no
mdisk_id:
mdisk_name:
FC_id:
FC_name:
RC_id:
RC_name:
vdisk_UID:60050768017F06BF78000000000000001
throttling:0
preferred_node_id:1
fast_write_state:empty
cache:readwrite
udid:4326
fcmap_count:0
```

lsvdiskdependentmaps

The **lsvdiskdependentmaps** command displays all FlashCopy mappings with target virtual disks (VDisks) that are dependent upon data held on the specified VDisk.

Syntax

```
svcinfo -- lsvdiskdependentmaps [vdisk_id | vdisk_name]
```

Parameters

vdisk_id | *vdisk_name*

(Required) Specifies the name or ID of a virtual disk (VDisk).

Description

The **lsvdiskdependentmaps** command displays FlashCopy mappings that have target VDIs that are dependent upon data held on the specified *vdisk_id* | *vdisk_name*. This can be used to determine whether a FlashCopy mapping can be prepared. Issue the command for the target VDisk *vdisk_id* | *vdisk_name* of the FlashCopy mapping to be prepared. If no FlashCopy mappings are returned, the FlashCopy mapping can be prepared. Any FlashCopy mappings that are returned in the list must be stopped or be in the **idle_or_copied** state, before the new FlashCopy mapping can be prepared.

You must use this command before force deleting a VDisk. Any FlashCopy mappings that are returned in the list for the VDisk are stopped when the VDisk is force deleted.

Possible failures

- CMMVC5786E The cluster is not in a stable state.

A concise invocation example

```
svcinfo lsvdiskdependentmaps -delim : 0
```

The concise resulting output

```
id:name  
2:fcmap2  
5:fcmap5
```

lsvdiskextent

Use the **lsvdiskextent** command to list the number of extents per MDisk that make up the VDisk and to determine the number of extents that are used by each VDisk. The number of extents that are provided by each MDisk is displayed.

Syntax

```
svcinfo -- lsvdiskextent [-nohdr] [-delim delimiter] [vdisk_name | vdisk_id]
```

Parameters

-nohdr

(Optional) By default, headings are displayed for each column of data in a

concise style view, and for each item of data in a detailed style view. The **-nohdr** parameter suppresses the display of these headings.

Note: If there is no data to be displayed, headings are not displayed even if the **-nohdr** parameter is specified.

-delim *delimiter*

(Optional) By default in a concise view, all columns of data are space-separated. The width of each column is set to the maximum possible width of each item of data. In a detailed view, each item of data has its own row, and if the headers are displayed, the data is separated from the header by a space. The **-delim** parameter overrides this behavior. Valid input for the **-delim** parameter is a one-byte character. If you enter **-delim :** on the command line, the colon character (:) separates all items of data in a concise view; for example, the spacing of columns does not occur. In a detailed view, the data is separated from its header by the specified delimiter.

vdisk_name | *vdisk_id*

(Required) Specifies one or more virtual disk IDs or names.

Description

The command displays a list in which each entry contains a MDisk ID and the number of extents. These MDisks are using extents on the specified VDisk. The number of extents on each VDisk is also shown.

Every VDisk is constructed from one or more MDisks. At times, you might have to determine the relationship between the two objects. The following procedure allows you to determine the relationships.

To determine the relationship between VDIsks and MDisks, issue the following command:

```
svcinfo lsvdiskmember vdisk_name | vdisk_id
```

where *vdisk_name* | *vdisk_id* is the name or ID of the VDisk. This command displays a list of IDs that correspond to the MDisks that make up the VDisk.

To determine the relationship between VDIsks and MDisks, and the number of extents that are provided by each MDisk, you must use the command-line interface. For each VDisk,, issue the following command:

```
svcinfo lsvdiskextent vdisk_name | vdisk_id
```

where *vdisk_name* | *vdisk_id* is the name or ID of the VDisk. This command displays a table of MDisk IDs and the corresponding number of extents that each MDisk provides as storage for the given VDisk.

To determine the relationship between MDisks and VDIsks, issue the following command for each MDisk:

```
svcinfo lsmdiskmember mdisk_name | mdisk_id
```

where *mdisk_name* | *mdisk_id* is the name or ID of the MDisk. This command displays a list of IDs that corresponds to the VDIsks that are using this MDisk.

To determine the relationship between MDisks and VDisks, and the number of extents that are used by each VDisk, you must use the command-line interface. For each MDisk, issue the following command:

```
svcinfo lsmdiskextent mdisk_name | mdisk_id
```

where *mdisk_name* | *mdisk_id* is the name or ID of the MDisk. This command displays a table of VDisk IDs and the corresponding number of extents that are used by each VDisk.

Possible failures

- CMMVC5786E The action failed because the cluster is not in a stable state.
- CMMVC5804E The action failed because an entity that was specified in the command does not exist.
- CMMVC5854E The extent information was not returned because the extent is not used or does not exist.
- CMMVC5855E The extent information was not returned because the managed disk (MDisk) is not used by any virtual disk (VDisk).
- CMMVC5864E The extent information was not returned because the source extent is not used.
- CMMVC5865E The extent information was not returned because the extent is out of range for the managed disk (MDisk) or virtual disk (VDisk).
- CMMVC6252E The command failed authorization because the session SSH key is wrong or was deleted.
- CMMVC6253E The command failed authorization because the session SSH key does not have the requisite role.

An invocation example

```
svcinfo lsvdiskextent -delim : vdisk0
```

The resulting output

```
id:extent offset  
0:0
```

lsvdiskfcmappings

The **lsvdiskfcmappings** command displays a list of FlashCopy mappings to which the VDisk belongs. A VDisk can be part of up to 16 FlashCopy mappings.

Syntax

```
▶▶ svcinfo — — lsvdiskfcmappings — — vdisk_name | vdisk_id ▶▶
```

Parameters

vdisk_name | *vdisk_id*

(Required) Specifies the name or ID of the VDisk for which a list of all FlashCopy mappings is required.

Description

The **lsvdiskfcmappings** command returns a list of all FlashCopy mappings to which the VDisk is a member. The list is returned in no particular order.

An invocation example

```
svcinflsvdiskfcmappings -delim : vdisk2
```

The resulting output

```
fc_id:fc_name  
1:fcmap1  
3:fcmap3
```

lsvdiskhostmap

Use the **lsvdiskhostmap** command to list the VDisk to the host mapping. These hosts have the specified virtual disk mapped to them; the virtual disk is visible to these hosts.

Syntax

```
svcinflsvdiskhostmap [-nohdr] [-delim delimiter] vdisk_id vdisk_name
```

Parameters

-nohdr

(Optional) By default, headings are displayed for each column of data in a concise style view, and for each item of data in a detailed style view. The **-nohdr** parameter suppresses the display of these headings.

Note: If there is no data to be displayed, headings are not displayed even if the **-nohdr** parameter is specified.

-delim *delimiter*

(Optional) By default in a concise view, all columns of data are space-separated. The width of each column is set to the maximum possible width of each item of data. In a detailed view, each item of data has its own row, and if the headers are displayed, the data is separated from the header by a space. The **-delim** parameter overrides this behavior. Valid input for the **-delim** parameter is a one-byte character. If you enter **-delim :** on the command line, the colon character (:) separates all items of data in a concise view; for example, the spacing of columns does not occur. In a detailed view, the data is separated from its header by the specified delimiter.

vdisk_id | *vdisk_name*

(Required) Specifies the ID or name of the virtual disk. The cluster displays a list of all the hosts to which this virtual disk is mapped and the SCSI ID by which the virtual disk is mapped.

Description

This command displays a list of host IDs and names. These hosts have the specified virtual disk mapped to them; that is, the virtual disk is visible to these hosts. The SCSI LUN ID is also displayed. The SCSI LUN ID is the ID by which the virtual disk is recognized by the host.

Determining the host that a VDisk is mapped to: List the hosts that this VDisk is mapped to, by issuing the following command:

```
svcinfo lsvdiskhostmap vdisk_id | vdisk_name
```

where *vdisk_id* | *vdisk_name* is the name or ID of the VDisk. A list is displayed. Look for the host name or ID to determine which host this VDisk is mapped to. If no data is displayed, the VDisk is not mapped to any hosts.

Possible failures

- CMMVC5786E The action failed because the cluster is not in a stable state.
- CMMVC5804E The action failed because an entity that was specified in the command does not exist.
- CMMVC6252E The command failed authorization because the session SSH key is wrong or was deleted.
- CMMVC6253E The command failed authorization because the session SSH key does not have the requisite role.

The concise invocation example

```
svcinfo lsvdiskhostmap -delim : 3
```

The concise resulting output

```
id:name:SCSI_id:host_id:host_name:wwpn:vdisk_UID  
3:vdisk3:0:2:host2:0000000000100ABC:60050768018A00015000000000000003
```

lsvdiskmember

The **lsvdiskmember** command displays a list of MDisks that are members of the specified VDisk.

Syntax

```
▶▶ svcinfo — — lsvdiskmember — [ -nohdr ] —————▶  
  
▶ [ -delim — delimiter ] [ vdisk_id — vdisk_name ] —————▶
```

Parameters

-nohdr

(Optional) By default, headings are displayed for each column of data in a concise style view, and for each item of data in a detailed style view. The **-nohdr** parameter suppresses the display of these headings.

Note: If there is no data to be displayed, headings are not displayed even if the **-nohdr** parameter is specified.

-delim *delimiter*

(Optional) By default in a concise view, all columns of data are space-separated. The width of each column is set to the maximum possible width of each item of data. In a detailed view, each item of data has its own row, and if the headers are displayed, the data is separated from the header by a space. The **-delim** parameter overrides this behavior. Valid input for the **-delim** parameter is a one-byte character. If you enter **-delim :** on the command line, the colon character (:) separates all items of data in a concise view; for example, the spacing of columns does not occur. In a detailed view, the data is separated from its header by the specified delimiter.

vdisk_id | *vdisk_name*

(Required) Specifies the name or ID of the VDisk for the list of member MDisks.

Description

This command displays a list of managed disks, which provide extents that make up the virtual disk that is specified by the ID.

Every VDisk is constructed from one or more MDisks. At times, you might have to determine the relationship between the two objects. The following procedure allows you to determine the relationships.

If you use the **svcinfo lsmdiskmember** command, the concise view displays a list of virtual disks. These are the virtual disks that are using extents on the managed disk that is specified by the ID. The list displays the members of the respective object and is independent of the state of the individual members; that is, if they are in offline state, they are still displayed.

To determine the relationship between VDIs and MDIs, issue the following command:

```
svcinfo lsvdiskmember vdisk_id | vdisk_name
```

where *vdisk_id* | *vdisk_name* is the name or ID of the VDisk. This displays a list of IDs that correspond to the MDIs that make up the VDisk.

To determine the relationship between VDIs and MDIs, and the number of extents that are provided by each MDisk, you must use the command-line interface. Issue the following command:

```
svcinfo lsvdiskextent vdisk_id | vdisk_name
```

where *vdisk_id* | *vdisk_name* is the name or ID of the VDisk. This displays a table of MDisk IDs and the corresponding number of extents that each MDisk provides as storage for the specified VDisk.

To determine the relationship between MDIs and VDIs, issue the following command:

```
svcinfo lsmdiskmember mdisk_id | mdisk_name
```

where *mdisk_id* | *mdisk_name* is the name or ID of the MDisk. This displays a list of IDs that correspond to the VDIs that are using this MDisk.

To determine the relationship between MDisks and VDIs, and the number of extents that are used by each VDisk, you must use the command-line interface. For a specified MDisk, issue the following command:

```
svcinfo lsmdiskextent mdisk_id | mdisk_name
```

where *mdisk_id* | *mdisk_name* is the name or ID of the MDisk. This displays a table of VDisk IDs and the corresponding number of extents that are used by each VDisk.

Possible failures

- CMMVC5786E The action failed because the cluster is not in a stable state.
- CMMVC5804E The action failed because an entity that was specified in the command does not exist.
- CMMVC6252E The command failed authorization because the session SSH key is wrong or was deleted.
- CMMVC6253E The command failed authorization because the session SSH key does not have the requisite role.

An invocation example

```
svcinfo lsvdiskmember 1
```

The resulting output

```
id  
2
```

lsvdiskprogress

The **lsvdiskprogress** command tracks the progress during new virtual disk formatting.

Syntax

```
▶▶▶ svcinfo — — lsvdiskprogress — — [ -nohdr ] —————▶▶▶  
▶ [ -delim — delimiter ] [ vdisk_id — vdisk_name ] —————▶▶▶
```

Parameters

-nohdr

(Optional) By default, headings are displayed for each column of data in a concise style view, and for each item of data in a detailed style view. The **-nohdr** parameter suppresses the display of these headings.

Note: If there is no data to be displayed, headings are not displayed even if the **-nohdr** parameter is specified.

-delim *delimiter*

(Optional) By default in a concise view, all columns of data are space-separated. The width of each column is set to the maximum possible width of each item of data. In a detailed view, each item of data has its own row, and if the headers are displayed, the data is separated from the header by a space. The **-delim** parameter overrides this behavior. Valid input for the

-delim parameter is a one-byte character. If you enter `-delim :` on the command line, the colon character (`:`) separates all items of data in a concise view; for example, the spacing of columns does not occur. In a detailed view, the data is separated from its header by a colon character.

vdisk_id | *vdisk_name*

(Optional) Specifies the VDisk ID or name. If you do not specify this parameter, the progress of all VDIsks currently being formatted is displayed.

Description

This command displays the progress of the format of a new virtual disk as a completed percentage.

Possible failures

- CMMVC5786E The action failed because the cluster is not in a stable state.
- CMMVC5804E The action failed because an entity that was specified in the command does not exist.
- CMMVC5805E The progress information was not returned because the FlashCopy statistics are not ready yet.
- CMMVC6252E The command failed authorization because the session SSH key is wrong or was deleted.
- CMMVC6253E The command failed authorization because the session SSH key does not have the requisite role.

An invocation example

```
svcinfo lsvdiskprogress -delim : 0
```

The resulting output

```
id:progress  
0:58
```

showtimezone

Use the **showtimezone** command to display the current time zone settings for the cluster.

Syntax

```
▶▶ svcinfo — — showtimezone — — [ -nohdr ] —————▶  
▶ [ -delim — delimiter ] —————▶▶
```

Parameters

-nohdr

(Optional) By default, headings are displayed for each column of data in a concise style view, and for each item of data in a detailed style view. The **-nohdr** parameter suppresses the display of these headings.

Note: If there is no data to be displayed, headings are not displayed even if the **-nohdr** parameter is specified.

-delim *delimiter*

(Optional) By default in a concise view, all columns of data are space-separated. The width of each column is set to the maximum possible width of each item of data. In a detailed view, each item of data has its own row, and if the headers are displayed, the data is separated from the header by a space. The **-delim** parameter overrides this behavior. Valid input for the **-delim** parameter is a one-byte character. If you enter **-delim :** on the command line, the colon character (:) separates all items of data in a concise view; for example, the spacing of columns does not occur. In a detailed view, the data is separated from its header by the specified character.

Description

This command displays a single time zone and its associated ID. This is the current time zone setting for the cluster. A list of available time-zones can be viewed by running the **svcinfo lstimezones** command. The time zone can be changed by running the **svctask settimezone** command.

Possible failures

- CMMVC5786E The action failed because the cluster is not in a stable state.
- CMMVC6252E The command failed authorization because the session SSH key is wrong or was deleted.
- CMMVC6253E The command failed authorization because the session SSH key does not have the requisite role.

An invocation example

```
svcinfo showtimezone -delim :
```

The resulting output

```
id:timezone  
522:UTC
```

Chapter 21. Error log commands

Error log commands capture and manage error conditions for the cluster.

finderr

The **finderr** command analyzes the error log for the unfixed error with the highest severity.

Syntax

```
►►— svcservicetask — — finderr —————►►
```

Description

The command scans the error log for any unfixed errors. The highest priority unfixed error is returned.

You can use this command to determine the order in which to fix the logged errors.

The Web-based directed maintenance procedures (DMPs) also use this command.

Possible failures

There are no error codes.

An invocation example

```
svcservicetask finderr
```

The resulting output

```
Highest priority unfixed error code is [1010]
```

dumperrlog

The **dumperrlog** command dumps the contents of the error log to a text file.

Syntax

```
►►— svcservicetask — — dumperrlog —————►►  
└─ -prefix — filename_prefix ─┘
```

Parameters

-prefix *filename_prefix*

A file name is created from the prefix and a time stamp, and has the following format:

```
prefix_NNNNNN_YYMMDD_HHMMSS
```

where *NNNNNN* is the node front panel name.

Note: If the **-prefix** parameter is not supplied, the dump is directed to a file with a system-defined prefix of **errlog**.

Description

When run with no parameters, the **dumperrlog** command dumps the cluster error log to a file using a system-supplied prefix of **errlog**, which includes the node ID and time stamp. When a file name prefix is provided, the same operation is performed but the details are stored in the dumps directory within a file with a name that starts with the specified prefix.

A maximum of ten error-log dump files are kept on the cluster. When the eleventh dump is made, the oldest existing dump file is overwritten.

Error log dump files are written to **/dumps/elogs**. The contents of this directory can be viewed using the **svcsinfo lserrlogdumps** command.

Files **are not** deleted from other nodes until you issue the **cleardumps** command.

Possible failures

- CMMVC5983E The dump file was not created. The file system might be full.
- CMMVC5984E The dump file was not written to disk. The file system might be full.

An invocation example

```
svcservicetask dumperrlog -prefix testerrorlog
```

The resulting output

No feedback

clearerrlog

The **clearerrlog** command clears all entries from the error log including status events and any unfixed errors.

Syntax

```
svcservicetask -- clearerrlog -- [-force]
```

Parameters

-force

(Optional) Specifies that the function of the **clearerrlog** command be processed without confirmation requests. If the **-force** parameter is not supplied, you are prompted to confirm that you want to clear the log.

Description

This command clears all entries from the error log. The entries are cleared even if there are unfixed errors in the log. It also clears any status events that are in the log.

Attention: This command is destructive. Use it only when you have either rebuilt the cluster or have fixed a major problem that has caused entries in the error log that you do not want to manually fix.

Possible failures

- CMMVC5786E The action failed because the cluster is not in a stable state.
- CMMVC6252E The command failed authorization because the session SSH key is wrong or was deleted.
- CMMVC6253E The command failed authorization because the session SSH key does not have the requisite role.

An invocation example

```
svcservicetask clearerrlog -force
```

The resulting output

```
No feedback
```

cherrstate

The **cherrstate** command marks an unfixed error as fixed. You can also use it to mark a fixed error as unfixed.

Syntax

```
▶— svcservicetask — — cherrstate — — -sequencenumber — sequence_number —▶  
▶ — [ -unfix ] —▶
```

Parameters

-sequencenumber *sequence_number*

(Required) Specifies the error log sequence numbers to fix or mark as unfixed.

-unfix

(Optional) Specifies that the sequence numbers that are supplied be marked as unfixed. If you specify the **-unfix** parameter, the sequence numbers are marked as unfixed. Use this parameter when you have marked the wrong sequence number as fixed.

Description

This command allows you to specify error log entries as fixed or unfixed. Use this command as a manual confirmation step that you have performed a maintenance procedure on the cluster, fabric, or subsystems.

This step is performed as part of the directed maintenance procedures (DMPs).

Optionally, if you have marked the wrong sequence number as fixed, you can use the **-unfix** parameter to change the entry to unfixed.

Possible failures

- CMMVC5786E The action failed because the cluster is not in a stable state.

- CMMVC5803E The entry in the error log was not marked because the sequence number was not found.
- CMMVC6252E The command failed authorization because the session SSH key is wrong or was deleted.
- CMMVC6253E The command failed authorization because the session SSH key does not have the requisite role.

An invocation example

```
svcservicetask cherrstate -sequencenumber 2019
```

The resulting output

No feedback

setevent

The **setevent** command specifies how the SAN Volume Controller sends SNMP traps when an error or event is logged to the error log.

Syntax

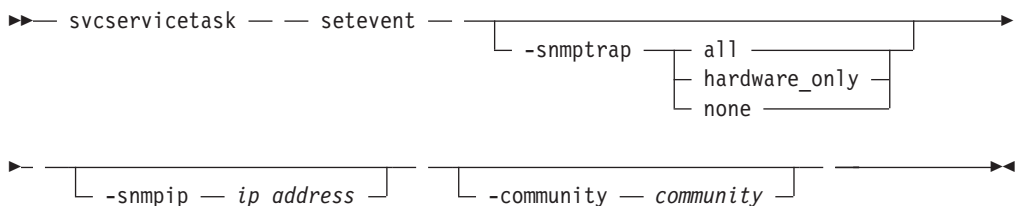

Parameters

-snmptrap *all* | *hardware_only* | *none*

(Optional) Specifies the SNMP trap setting, which specifies when to receive a message that reports a problem or significant event. You can set the following values for this parameter:

all Sends an SNMP trap for all errors and state changes that are logged.

hardware_only

Sends an SNMP trap for all errors, but not for object state changes.

none Does not send any SNMP traps or errors. This is the default setting for a new cluster.

-snmpip *ip_address*

(Optional) Specifies the IP address of the host system that is running the SNMP manager software. This is a colon-separated list of values with up to six items per list.

-community *community*

(Optional) Specifies the SNMP community string. This is a colon-separated list of values with up to six items per list. The maximum length of the community string that is used in SNMP trap generation cannot be more than 60 characters.

Description

This command sets or modifies error log settings, which define the actions to take when errors and events are logged.

You can use this command to set up SNMP traps. For SNMP, you must supply the following information:

- When to raise a trap
- The IP address of the SNMP manager
- The SNMP community

Possible failures

- CMMVC5786E The action failed because the cluster is not in a stable state.
- CMMVC6252E The command failed authorization because the session SSH key is wrong or was deleted.
- CMMVC6253E The command failed authorization because the session SSH key does not have the requisite role.

An invocation example

```
svcservicetask setevent -snmptrap all
```

The resulting output

No feedback

Chapter 22. Featurization commands

The following commands enable you to work with featurization functions with the SAN Volume Controller.

chlicense

The **chlicense** command changes the licensed settings of the cluster.

Syntax

```
svctask -- chlicense --
```

-flash	on
	off
-remote	on
	off
-size	capacity

Parameters

-flash on | off

(Optional) Specifies whether the FlashCopy feature is licensed for this cluster. The default value is **off**.

-remote on | off

(Optional) Specifies whether the Metro Mirror and Global Mirror features is licensed for this cluster. The default value is **off**.

-size capacity

(Optional) Specifies the amount of virtualization that is licensed for this cluster. The default value is **0 GB**.

Note: You cannot use any of these parameters together.

Description

This command changes the license settings for the cluster. Any change that is made is logged as an event in the featurization log.

The current feature settings for the cluster are displayed in the viewing feature log panel. These settings show whether you are licensed to use the FlashCopy, Metro Mirror, or Global Mirror feature. They also show the amount of storage that you are licensed to virtualize. Normally, the feature log contains entries because feature options must be set as part of the Web-based cluster creation process.

Note: Dumping an empty feature log produces a file that contains headers, 256 lines of formatted zeros, and two lines that includes a checksum.

By default, the Copy Services functions are disabled, but this does not stop you from creating and using copy services. However, errors are placed in the featurization log which state that you are using an unlicensed feature. The command-line tool return code also notifies you that you are using an unlicensed feature.

The total virtualized capacity can also be modified with this command. This is the number of gigabytes (GB) of virtual disk capacity that can be configured by the cluster.

When you reach 90% capacity, any attempt to create or extend virtual disks results in a message from the command-line tool. This does not stop you from creating and expanding virtual disks. When usage reaches (and exceeds) 100% capacity, errors are placed in the featurization log. Again, this does not prevent you from creating and expanding virtual disks.

Any error that is placed in the featurization log results in a generic featurization error being placed in the normal cluster error log. This occurs when you issue a command that breaks the license agreement. The return code also notifies you that you are breaking or exceeding the license settings; a return code of 1 is displayed with any commands that exceed 90% or more or that breaks the current license settings.

Possible failures

- CMMVC5786E The action failed because the cluster is not in a stable state.
- CMMVC5998W The virtualized storage capacity exceeds the amount that you are licensed to use.
- CMMVC6252E The command failed authorization because the session SSH key is wrong or was deleted.
- CMMVC6253E The command failed authorization because the session SSH key does not have the requisite role.

An invocation example

```
svctask chlicense -flash on
```

The resulting output

```
No feedback
```

dumpinternallog

The **dumpinternallog** command dumps the contents of the featurization error and event log to a file on the current configuration node.

Syntax

```
▶▶ svctask — — dumpinternallog —————▶▶
```

Description

This command dumps the contents of the internal featurization error and event log to a file on the current configuration node.

This file is always called **feature.txt** and is created (or overwritten) in the **/dumps/feature** directory on the configuration node.

This file can be requested by IBM service personnel.

Before making any entries, the featurization log contains only zeros. A dump of this log from the **svctask dumpinternallog** command results in an empty file.

Possible failures

- CMMVC5786E The action failed because the cluster is not in a stable state.
- CMMVC5983E The dump file was not created. The file system might be full.
- CMMVC6252E The command failed authorization because the session SSH key is wrong or was deleted.
- CMMVC6253E The command failed authorization because the session SSH key does not have the requisite role.

An invocation example

```
svctask dumpinternallog
```

The resulting output

No feedback

Chapter 23. Secure Shell key commands

Secure Shell (SSH) key commands manage the public and private SSH keys for a cluster.

addsshkey

The **addsshkey** command installs a new SSH key on the cluster. The key file must first be copied onto the cluster.

Syntax

```
svctask -- addsshkey -- -label -- identifier --  
-file -- filename_arg -- -user -- admin | service --
```

Parameters

-label *identifier*

(Required) Specifies a new ID to associate with this key. The maximum length of this key is 30 characters.

-file *filename_arg*

(Required) Specifies the name of the file containing the SSH key.

-user *admin | service*

(Required) Specifies which user ID that the SSH key is assigned to.

Description

To add an SSH key to a cluster, you must first copy the key file to the cluster in the **/tmp** directory using secure copy (**scp**). The **svctask addsshkey** command moves the key file from the **/tmp** directory to the required location and activates it for the designated user.

Each key is associated with an ID string that you define, up to 30 characters. Up to 100 keys can be stored on a cluster. You can add keys to provide either administrator access or service access.

When the key has been activated, you can invoke commands on the cluster over SSH using the user ID that was specified from the host for which the key was generated. Alternatively, you can run an interactive SSH session from the specified host using the user ID specified

The identifier (key label) can be used to subsequently identify the key when all keys are listed using the **svctask lsshkeys** command, or if the key is to be deleted, using the **svctask rsshkey** command. The identifier is also specified as the key label that is used in the audit log. The audit log uses the key label to identify the commands that were issued through an SSH session that was established with an associated key. If you want to use the audit log, you must ensure that there is a 1:1 ratio mapping from the key label identifier to the key for each authorized user.

You can issue the **svcinfolssshkeys** command to list the SSH keys that are available on the cluster. You can issue the **svctask rmsshkey** command to remove an SSH key from the cluster.

You can issue the **svctask rmallsshkeys** command to remove all of the SSH keys from the cluster

Possible failures

- CMMVC5786E The action failed because the cluster is not in a stable state.
- CMMVC6008E The key already exists.
- CMMVC6252E The command failed authorization because the session SSH key is wrong or was deleted.
- CMMVC6253E The command failed authorization because the session SSH key does not have the requisite role.

An invocation example

```
svctask addsshkey -user service -file /tmp/id_rsa.pub -label testkey
```

The resulting output

No feedback

rmallsshkeys

The **rmallsshkeys** command removes all the SSH keys that are specified by the **-user** parameter.

Syntax

```
svctask rmallsshkeys -user admin | service | all
```

Parameters

-user admin | service | all

(Required) Specifies which SSH keys to remove from the cluster. If you specify **-user all**, all the SSH keys in the cluster are removed.

Description

This command removes all the SSH keys that are specified by the **-user** parameter.

You can issue the **svcinfolssshkeys** command to list the SSH keys that are available on the cluster. You can issue the **svctask addsshkey** command to install a new SSH key on the cluster. The key file must first be copied onto the cluster. Each key is associated with an ID, which can consist of up to 30 characters. Up to 100 keys can be stored on a cluster. You can add keys to provide either administrator access or service access. For example, type the following:

```
svctask addsshkey -user service -file /tmp/id_rsa.pub -label testkey
```

where */tmp/id_rsa.pub* is the name of the file that the SSH key is saved in and *testkey* is the label to associate with this key.

You can issue the **svctask rmsshkey** command to remove an SSH key from the cluster.

Possible failures

- CMMVC5786E The action failed because the cluster is not in a stable state.
- CMMVC6252E The command failed authorization because the session SSH key is wrong or was deleted.
- CMMVC6253E The command failed authorization because the session SSH key does not have the requisite role.

An invocation example

```
svctask rmsshkeys -user service
```

The resulting output

No feedback

rmsshkey

The **rmsshkey** command removes a specified SSH key from the cluster.

Syntax

```
svctask -- rmsshkey -- -user [ admin | service ]
-- -key -- key_identifier
```

Parameters

-user admin | service

(Required) Specifies the user ID from which the SSH key is deleted.

-key key_identifier

(Required) Specifies the label of the key to be deleted.

Description

This command removes the specified SSH key from the cluster.

Attention: To change your SSH key, you must add your new key before you remove the old key. Within a current SSH session, once the SSH key that established the session is removed, that session is unable to issue any further commands. Adding your new key before you remove the old key prevents inaccurate audit log entries.

You can issue the **svctask lsshkeys** command to list the SSH keys that are available on the cluster.

You can issue the **svctask addsshkey** command to install a new SSH key on the cluster.

You can issue the **svctask rmsshkeys** command to remove all of the SSH keys from the cluster.

Possible failures

- CMMVC5786E The action failed because the cluster is not in a stable state.
- CMMVC6252E The command failed authorization because the session SSH key is wrong or was deleted.
- CMMVC6253E The command failed authorization because the session SSH key does not have the requisite role.

An invocation example

```
svctask rmsshkey -key testkey -user service
```

The resulting output

No feedback

Chapter 24. Service mode commands

Service mode commands perform tasks when the node is in service mode. Some of these tasks are to specify node software, to clean dump directories and to dump the contents of an error log to a file.

These commands can only be run on a node that is in service mode. Attempting to run them on a working configuration node results in the message: CMMVC5997E This command can only be run on a node that is in service mode.

Attempting to run any of the other **svctask** and **svcservicetask** commands on a node that is in service mode results in the following message: CMMVC5998E This command can not be run on a node that is in service mode.

applysoftware

The **applysoftware** command upgrades the cluster to a new level of software.

Syntax

```
▶— svcservicemodetask — — applysoftware — — — -file — filename_arg — —▶▶  
▶ -ignore —————▶▶
```

Parameters

-file *filename_arg*

(Required) Specifies the filename of the new software package.

-ignore

(Optional) Specifies that all prerequisite checking be bypassed and that all hardened data be deleted. Hardened data has been written to an auxiliary disk so that it is not lost in the event of a system failure. Use this parameter with caution.

Description

This command starts the upgrade process of the cluster to a new level of software and can be applied to **svcservicetask** and **svcservicemodetask**. The **applysoftware** command can be used to apply a level of software to the node in both service and nonservice modes. In service mode the **applysoftware** command is applied to the specific node in service mode. In nonservice mode, the command is applied to the complete cluster.

The software package as specified by the file name must first be copied on to the current configuration node in the **/home/admin/upgrade** directory. You can use PuTTY secure copy (scp) to copy the file. See “PuTTY scp” for detailed information on this procedure.

The actual upgrade completes asynchronously.

You can view the contents of the **/home/admin/upgrade** directory using the **svcinfo lssoftware.dumps** command.

Internally, the new package is moved from the `/home/admin/upgrade` directory and has a checksum performed on it. If the package fails the checksum operation, it is deleted and the upgrade fails. Otherwise, the package is extracted from the directory and the software upgrade begins.

Possible failures

- There are no error codes.

An invocation example

```
svcservicemodetask applysoftware -file newssoftware
```

The resulting output

No feedback

cleardumps

The **cleardumps** command cleans the various dump directories on a specified node.

Syntax

```
▶▶ svcservicemodetask — —cleardumps —————▶
▶ -prefix — directory_or_file_filter —————▶
                                     ┌ node_id ───┐
                                     └ node_name ───┘
```

Parameters

-prefix *directory_or_file_filter*

(Required) Specifies the directory, files, or both to be cleaned. If a directory is specified, with no file filter, all relevant dump or log files in that directory are cleaned. You can use the following directory arguments (filters):

- `/dumps` (cleans all files in all subdirectories)
- `/dumps/audit`
- `/dumps/configs`
- `/dumps/elogs`
- `/dumps/feature`
- `/dumps/iostats`
- `/dumps/iotrace`
- `/home/admin/upgrade`

In addition to the directory, you can specify a file filter. For example, if you specify `/dumps/elogs/*.txt`, all files in the **/dumps/elogs** directory that end in `.txt` are cleaned.

Note: The following rules apply to the use of wildcards with the SAN Volume Controller CLI:

- The wildcard character is an asterisk (*).
- The command can contain a maximum of one wildcard.
- When you use a wildcard, enclose the filter entry within double quotation marks (""), as follows:

```
svctask cleardumps -prefix "/dumps/elogs/*.txt"
```

node_id | *node_name*

(Optional) Specifies the node to be cleaned. The value that follows the flag is either the node name or ID:

- The node ID that is assigned to the node (not the worldwide node name).
- The node name, which is the label that you assigned when you added the node to the cluster

Description

This command deletes all the files that match the *directory/file_filter* value for the specified node. If no node is specified, the configuration node is cleaned.

You can clean all the dumps directories by specifying **/dumps** as the directory value.

You can clean all the files in a single directory by specifying one of the directory values.

You can list the contents of these directories on the given node by using the **svcinfolsexxxdumps** commands.

You can use this command to clean specific files in a given directory by specifying a directory or file name. You can use the wildcard (*) as part of your file name.

Note: To preserve the configuration and trace files, any files that match the following wildcard patterns are not cleaned:

- **svc.config**
- **.trc*
- **.trc.old*

Possible failures

- There are no error codes associated with the **svcservicemodetask cleardumps** command.

An invocation example

```
svcservicemodetask cleardumps -prefix /dumps/configs
```

The resulting output

No feedback

dumperrlog

The **dumperrlog** command dumps the contents of the error log to a text file.

Syntax

```
▶▶ svcservicemodetask — — dumperrlog — [ -prefix — filename_prefix ] ▶▶
```

Parameters

-prefix *filename_prefix*

(Optional) Creates a file name from the prefix and a time stamp, and has the following format:

prefix_NNNNNN_YYMMDD_HHMMSS

where *NNNNNN* is the node front panel name.

Note: If the **-prefix** parameter is not supplied, the dump is directed to a file with a system-defined prefix of **errlog**.

Description

With no parameters, the **svcservicemodetask dumperrlog** command dumps the cluster error log to a file using a system-supplied prefix of **errlog**, which includes the node ID and time stamp. When a file name prefix is provided, the same operation is performed, but the details are stored in the **dumps** directory within a file with a name that starts with the specified prefix.

A maximum of ten error log dump files are kept on the cluster. When the 11th dump is made, the oldest existing dump file is overwritten.

Error log dump files are written to the **/dumps/elogs** directory. You can view the contents of this directory using the **svcinfo lserrlogdumps** command.

Files are *not* deleted from other nodes until you issue the **cleardumps** command.

Possible failures

- CMMVC5983E The dump file was not created. The file system might be full.
- CMMVC5984E The dump file was not written to disk. The file system might be full.

An invocation example

```
svcservicemodetask dumperrlog -prefix testerrorlog
```

The resulting output

No feedback

exit

The **exit** command exits service mode and restarts the node.

Syntax

```
▶— svcservicemodetask — — exit —————▶
```

Description

This command causes the node to be restarted. The node powers on in standard operating mode and attempts to rejoin the cluster.

At some point during the processing of this command, the SSH (secure shell) client software and the Web server connection that accessed the node are ended as a result of the restart processing.

Possible failures

- There are no error codes.

An invocation example

```
svcservicemodetask exit
```

The resulting output

```
[SSH / webservice connections terminate so an error message to the effect of  
'connection lost' may be displayed, or 'CLIENT RECEIVED SERVER DOWN  
NOTIFICATION']
```

Chapter 25. Service mode information commands

Service mode information commands perform information gathering tasks when the node is in service mode.

These commands can only be run on a node that is in service mode. Attempting to run them on a working configuration node will result in the message:

CMMVC5997E This command can only be run on a node that is in service mode.

Attempting to run any of the other `svcin` commands on a node that is in service mode will result in the following message:

CMMVC5998E This command can not be run on a node that is in service mode.

ls2145dumps

The `ls2145dumps` command lists node assert dumps and associated output files that are located in the `/dumps` directory.

Syntax

```
svcservicemodeinfo -- ls2145dumps -- [-nohdr]
                                     [-delim delimiter]
```

Parameters

-nohdr

(Optional) By default, headings are displayed for each column of data in a concise style view, and for each item of data in a detailed style view. The **-nohdr** parameter suppresses the display of these headings.

Note: If there is no data to be displayed, headings are not displayed even if the **-nohdr** parameter is specified.

-delim *delimiter*

By default in a concise view, all columns of data are space separated. The width of each column is set to the maximum possible width of each item of data. In a detailed view, each item of data has its own row, and if the headers are displayed the data is separated from the header by a space. Using the **-delim** parameter overrides this behavior. Valid input for the **-delim** parameter is a one byte character. If you enter `-delim :` on the command line, the colon character (`:`) separates all items of data in a concise view; for example, the spacing of columns does not occur. In a detailed view, the data is separated from its header by a colon character.

Description

This command lists node assert dumps and associated output files, which are created during an assertion of a node. If you do not specify a node, the dumps that are available on the configuration node are listed. The command displays the files that are located in the **/dumps** directory.

Possible failures

There are no error codes.

An invocation example

```
svcserviceinfo ls2145dumps -delim :
```

The resulting output

```
id:2145_filename  
0:000108.trc.old  
1:dump.000108.030328.144007  
2.000108.trc
```

lsclustervpd

The **lsclustervpd** command returns the vital product data (VPD) for the cluster to which the node belonged.

Syntax

```
svcserviceinfo -- lsclustervpd -- [-nohdr] --  
[-delim delimiter]
```

Parameters

-nohdr

(Optional) By default, headings are displayed for each column of data in a concise style view, and for each item of data in a detailed style view. The **-nohdr** parameter suppresses the display of these headings.

Note: If there is no data to be displayed, headings are not displayed even if the **-nohdr** parameter is specified.

-delim *delimiter*

By default in a concise view, all columns of data are space separated. The width of each column is set to the maximum possible width of each item of data. In a detailed view, each item of data has its own row, and if the headers are displayed the data is separated from the header by a space. Using the **-delim** parameter overrides this behavior. Valid input for the **-delim** parameter is a one byte character. If you enter `-delim :` on the command line, the colon character (:) separates all items of data in a concise view; for example, the spacing of columns does not occur. In a detailed view, the data is separated from its header by a colon character.

Description

This command displays the VPD of the cluster to which the node belonged.

Possible failures

- There are no error codes.

An invocation example

```
svcservicemodeinfo lsclustervpd
```

The resulting output

```
id 000001002FF007E5
name kkk
location local
partnership
bandwidth 0
cluster_IP_address 0.0.0.0
cluster_service_IP_address 1.1.1.1
total_mdisk_capacity 0
space_in_mdisk_grps 0
space_allocated_to_vdisks 0
total_free_space 0
statistics_status off
statistics_frequency 15
required_memory 2048
cluster_locale en_US
SNMP_setting all
SNMP_community
SNMP_server_IP_address 0.0.0.0
subnet_mask 0.0.0.0
default_gateway 0.0.0.0
time_zone 522 UTC
email_setting all
email_id
code_level 00000000
FC_port_speed 1Gb
gm_link_tolerance:300
gm_inter_cluster_delay_simulation:0
gm_intra_cluster_delay_simulation:0
```

Iserrlogdumps

The **Iserrlogdumps** command lists the error log dump files in the **/dumps/elogs** directory, which are created when you run the **svctask dumperrlog** command.

Syntax

```
▶▶ svcservicemodeinfo — lserrlogdumps — [ -nohdr ] —————▶▶
[ -delim — delimiter ] —————▶▶
```

Parameters

-nohdr

(Optional) By default, headings are displayed for each column of data in a concise style view, and for each item of data in a detailed style view. The **-nohdr** parameter suppresses the display of these headings.

Note: If there is no data to be displayed, headings are not displayed even if the **-nohdr** parameter is specified.

-delim *delimiter*

By default in a concise view, all columns of data are space separated. The width of each column is set to the maximum possible width of each item of data. In a detailed view, each item of data has its own row, and if the headers are displayed the data is separated from the header by a space. Using the **-delim** parameter overrides this behavior. Valid input for the **-delim** parameter is a one byte character. If you enter **-delim :** on the command line, the colon character (:) separates all items of data in a concise view; for example, the spacing of columns does not occur. In a detailed view, the data is separated from its header by a colon character.

Description

This command lists error log dump files, which are created when you run the **svctask dumperrlog** command. An error log dump describes the contents of the error log at the time that the command was run. If you do not specify a node, the dumps that are available on the configuration node are listed. The command displays the files that are located in the **/dumps/elogs** directory.

Possible failures

- There are no error codes.

An invocation example

```
svcservicemodeinfo lserrlogdumps
```

The resulting output

id	filename
0	errlog_lynn02_030327_154511
1	aaa.txt_lynn02_030327_154527
2	aaa.txt_lynn02_030327_154559
3	errlog_lynn02_030403_110628

lsfeaturedumps

The **lsfeaturedumps** command lists the dump files in the **/dumps/feature** directory, which are created when you run the **svctask dumpinternallog** command.

Syntax

```
svcservicemodeinfo -- lsfeaturedumps -- [-nohdr]
[-delim -- delimiter]
```

Parameters

-nohdr

(Optional) By default, headings are displayed for each column of data in a concise style view, and for each item of data in a detailed style view. The **-nohdr** parameter suppresses the display of these headings.

Note: If there is no data to be displayed, headings are not displayed even if the **-nohdr** parameter is specified.

-delim *delimiter*

By default in a concise view, all columns of data are space separated. The width of each column is set to the maximum possible width of each item of data. In a detailed view, each item of data has its own row, and if the headers are displayed the data is separated from the header by a space. Using the **-delim** parameter overrides this behavior. Valid input for the **-delim** parameter is a one byte character. If you enter **-delim :** on the command line, the colon character (:) separates all items of data in a concise view; for example, the spacing of columns does not occur. In a detailed view, the data is separated from its header by the specified delimiter.

Description

This command returns a list of featurization dumps, which are created when you run the **svctask dumpinternallog** command. A featurization dump file describes the contents of the featurization log at the time that the command was executed. If you do not specify a node, the available dumps on the configuration node are listed. The command displays files from the **/dumps/feature** directory.

Issue the **svcinfolfeaturedumps** command to list the dump files in the **/dumps/feature** directory. The feature log is maintained by the cluster. The feature log records events that are generated when license parameters are entered or when the current license settings have been breached.

Possible failures

- There are no error codes.

An invocation example

```
svcserviceinfo lsfeaturedumps
```

The resulting output

```
id          feature_filename
0           feature.txt
```

lsiostatsdumps

The **lsiostatsdumps** command lists the dump files in the **/dumps/iostats** directory, which are created when you run the **svctask startstats** command.

Syntax

```
▶▶ svcserviceinfo -- lsiostatsdumps -- [ -nohdr ]
▶ [ -delim delimiter ]
```

Parameters

-nohdr

(Optional) By default, headings are displayed for each column of data in a concise style view, and for each item of data in a detailed style view. The **-nohdr** parameter suppresses the display of these headings.

Note: If there is no data to be displayed, headings are not displayed even if the **-nohdr** parameter is specified.

-delim *delimiter*

By default in a concise view, all columns of data are space separated. The width of each column is set to the maximum possible width of each item of data. In a detailed view, each item of data has its own row, and if the headers are displayed the data is separated from the header by a space. Using the **-delim** parameter overrides this behavior. Valid input for the **-delim** parameter is a one byte character. If you enter **-delim :** on the command line, the colon character (:) separates all items of data in a concise view; for example, the spacing of columns does not occur. In a detailed view, the data is separated from its header by a colon character.

Description

This command lists I/O statistics dumps, which are created when you run the **svctask startstats** command. If you do not specify a node, the available dumps on the configuration node are listed. The command displays the files located in the **/dumps/iostats** directory.

Possible failures

- There are no error codes.

An invocation example

```
svcservicemodeinfo lsiostatsdumps
```

The resulting output

id	iostat_filename
0	v_stats_mala75_031123_072426
1	m_stats_mala75_031123_072425

Isiotracedumps

The **Isiotracedumps** command lists the files that are located in the **/dumps/iotrace** directory.

Syntax

```
svcservicemodeinfo -- lsiotracedumps -- [-nohdr] -- [-delim delimiter]
```

Parameters

-nohdr

(Optional) By default, headings are displayed for each column of data in a concise style view, and for each item of data in a detailed style view. The **-nohdr** parameter suppresses the display of these headings.

Note: If there is no data to be displayed, headings are not displayed even if the **-nohdr** parameter is specified.

-delim *delimiter*

By default in a concise view, all columns of data are space separated. The width of each column is set to the maximum possible width of each item of data. In a detailed view, each item of data has its own row, and if the headers are displayed the data is separated from the header by a space. Using the **-delim** parameter overrides this behavior. Valid input for the **-delim** parameter is a one byte character. If you enter `-delim :` on the command line, the colon character (:) separates all items of data in a concise view; for example, the spacing of columns does not occur. In a detailed view, the data is separated from its header by the specified delimiter.

Description

This command lists I/O trace dumps, which are created when you run the **svctask settrace** command. If you do not specify a node, the dump files that are available on the configuration node are listed. The command displays the files that are located in the `/dumps/iotrace` directory.

Possible failures

- There are no error codes.

An invocation example

```
svcservicemodeinfo |siotracedumps
```

The resulting output

id	iotrace_filename
0	c1_mala75_030405_092155
1	c2_mala75_030405_092156
2	c3_mala75_030405_092158
3	c4_mala75_030405_092159
4	c5_mala75_030405_092201

Isnodes

The **Isnodes** command lists the cluster nodes that are in service mode.

The list report style can be used to obtain two styles of report:

- A list containing concise information about all the nodes on a cluster. (Each entry in the list corresponds to a single node.)
- The detailed information about a single node.

Syntax

```
svcservicemodeinfo -- isnodes -- [ -nohdr ] [ -delim delimiter ]
```

Parameters

-nohdr

(Optional) By default, headings are displayed for each column of data in a concise style view, and for each item of data in a detailed style view. The **-nohdr** parameter suppresses the display of these headings.

Note: If there is no data to be displayed, headings are not displayed even if the **-nohdr** parameter is specified.

-delim *delimiter*

By default in a concise view, all columns of data are space separated. The width of each column is set to the maximum possible width of each item of data. In a detailed view, each item of data has its own row, and if the headers are displayed the data is separated from the header by a space. Using the **-delim** parameter overrides this behavior. Valid input for the **-delim** parameter is a one-byte character. If you enter **-delim :** on the command line, the colon character (:) separates all items of data in a concise view; for example, the spacing of columns does not occur. In a detailed view, the data is separated from its header by a colon character.

Description

This command lists the cluster nodes that are in service mode.

Possible failures

- There are no error codes.

A concise invocation example

```
svcservicemodeinfo lsnodes -delim :
```

The concise resulting output

```
id:WWNN:front_panel_id:node_name:cluster:fabric  
1:50050768010007E5:lynn02:node1:yes:yes
```

lsnodevpd

The **lsnodevpd** command returns the vital product data (VPD) for the specified node.

Syntax

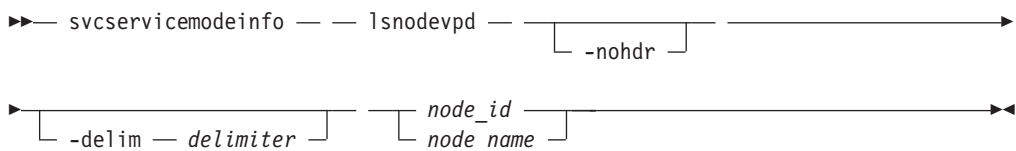

Parameters

-nohdr

(Optional) By default, headings are displayed for each column of data in a concise style view, and for each item of data in a detailed style view. The **-nohdr** parameter suppresses the display of these headings.

Note: If there is no data to be displayed, headings are not displayed even if the **-nohdr** parameter is specified.

-delim *delimiter*

(Optional) By default in a concise view, all columns of data are space separated. The width of each column is set to the maximum possible width of each item of data. In a detailed view, each item of data has its own row, and if the headers are displayed the data is separated from the header by a space.

Using the **-delim** parameter overrides this behavior. Valid input for the **-delim** parameter is a one byte character. If you enter `-delim :` on the command line, the colon character (:) separates all items of data in a concise view; for example, the spacing of columns does not occur. In a detailed view, the data is separated from its header by a colon character.

node_id | *node_name*

(Required) Specifies the node to view in terms of its node ID or name.

Description

This command returns the VPD for the specified node. Each field is reported on a new line. All fields are strings. The VPD is split into sections, each with a section heading. The number of fields in the section follows the heading. Each section is separated by an empty line. For example:

```
section name:3 fields
field1:value
field2:value
field3:value
```

```
new section:x fields
...
```

Some sections contain information about multiple objects of that type. Each object within the section is separated by an empty line. For example:

```
section name:4 fields
object1 field1:value
object1 field2:value

object2 field1:value
thanobject2 field2:value
```

```
new section: x fields
...
```

Note: For 8F4 and 8G4 nodes, the VPD displays the device serial number of the FC card as N/A.

Possible failures

- There are no error codes.

An invocation example

```
svcservicemodeinfo lsnodevdp id 1
```

The resulting output

```
id 1

system board: 17 fields

part_number Unknown
system_serial_number 550117N
number_of_processors 2
number_of_memory_slots 4
number_of_fans 0
number_of_FC_cards 1
```

number_of_scsi/ide_devices 2
BIOS_manufacturer IBM
BIOS_version -[QAE115AUS-1.01]-
BIOS_release_date 08/16/2001
system_manufacturer IBM
system_product eserver xSeries 342 -[86691RX]-
planar_manufacturer IBM
power_supply_part_number Unknown
CMOS_battery_part_number Unknown
power_cable_assembly_part_number Unknown
service_processor_firmware N/A

processor: 6 fields
processor_location Processor 1
number_of_caches 2

manufacturer GenuineIntel
version Pentium III
speed 1000
status Enabled
processor cache: 4 fields
type_of_cache Internal L1 Cache
size_of_cache (KB) 32

type_of_cache Internal L2 Cache
size_of_cache (KB) 256

processor: 6 fields
processor_location Processor 2
number_of_caches 2
manufacturer GenuineIntel
version Pentium III
speed 1000
status Enabled

processor cache: 4 fields
type_of_cache Internal L1 Cache
size_of_cache (KB) 32

type_of_cache Internal L2 Cache
size_of_cache (KB) 256
memory module: 16 fields
part_number 33L5039
device_location J1
bank_location Slot1 in bank 1
size (MB) 1024
part_number 33L5039
device_location J4
bank_location Slot2 in bank 1
size (MB) 1024

part_number N/A
device_location J2
bank_location Slot1 in bank 2
size (MB) 0

part_number N/A
device_location J3
bank_location Slot2 in bank 2
size (MB) 0

FC card: 5 fields
part_number 64P7783
port_numbers 1 2
device_serial_number VSI 0000AD3F4
manufacturer Agilent
device DX2

```

device: 15 fields
part_number Unknown
bus ide0
device 0
model LG CD-ROM CRN-8245B
revision 1.13
serial_number
approx_capacity 0
part_number Unknown
bus scsi
device 0
device_vendor IBM-ESXS
model ST318305LC    !#
revision 6C48
serial_number 3JKQ93B903196C48
approx_capacity 8
software: 5 fields
code_level 00000000
node_name node1
ethernet_status 1
WWNN 0x50050768010007e5

id 1

front panel assembly: 3 fields
part_number Unknown
front_panel_id lynn02
front_panel_locale en_US

UPS: 10 fields
electronics_assembly_part_number FakElec
battery_part_number FakBatt
frame_assembly_part_number FakFram
input_power_cable_part_number FakCabl
UPS_serial_number UPS_Fake_SN
UPS_type Fake UPS
UPS_internal_part_number UPS_Fake_PN
UPS_unique_id 0x10000000000007e5
UPS_main_firmware 1.4
UPS_comms_firmware 0.0

```

lssoftwaredumps

The **lssoftwaredumps** command lists the software packages that are located in the **/home/admin/upgrade** directory.

Syntax

```

▶▶▶ svc servicemodeinfo — — lssoftwaredumps — — [ -nohdr ] —————▶
▶ [ -delim — delimiter ] —————▶▶▶

```

Parameters

-nohdr

(Optional) By default, headings are displayed for each column of data in a concise style view, and for each item of data in a detailed style view. The **-nohdr** parameter suppresses the display of these headings.

Note: If there is no data to be displayed, headings are not displayed even if the **-nohdr** parameter is specified.

-delim *delimiter*

By default in a concise view, all columns of data are space separated. The width of each column is set to the maximum possible width of each item of data. In a detailed view, each item of data has its own row, and if the headers are displayed the data is separated from the header by a space. Using the **-delim** parameter overrides this behavior. Valid input for the **-delim** parameter is a one byte character. If you enter `-delim :` on the command line, the colon character (:) separates all items of data in a concise view; for example, the spacing of columns does not occur. In a detailed view, the data is separated from its header by a colon character.

Description

This command lists software upgrade packages, which are copied as a result of software upgrades. If you do not specify a node, the packages that are available on the configuration node are listed. The command displays files that are located in the **/home/admin/upgrade** directory.

Possible failures

- There are no error codes.

An invocation example

```
svcservicemodeinfo lsoftwareumps
```

The resulting output

id	software_filename
0	s1_mala75_030405_092143
1	s2_mala75_030405_092145
2	s3_mala75_030405_092146

Chapter 26. Controller command

The controller command modifies the name of a storage controller.

chcontroller

The **chcontroller** command modifies the name of a controller.

Syntax

```
svctask -- chcontroller -- -name -- new_name --  
└─┬─ controller_id ─┬─  
  └─ controller_name ─┘
```

Parameters

-name *new_name*

(Required) Specifies the new name to be assigned to the controller.

controller_id | *controller_name*

(Required) Specifies the controller to modify; use either the controller name or the controller ID.

Description

This command changes the name of the controller that is specified by the *controller_id* | *controller_name* parameter to the value that you specify with the **-name** *new_name* parameter.

You can add a new disk controller system to your SAN at any time. Follow the switch zoning guidelines in the section about switch zoning. Also, ensure that the controller is set up correctly for use with the cluster.

You can create one or more arrays on the controller using RAID-5, RAID-1, or RAID-0+1 (called RAID-10) for maximum redundancy and reliability. If your controller provides array partitioning, you can create a single partition from the entire capacity that is available in the array. Record the LUN number that you assign to each partition. If your disk controller system requires LUN mapping, follow the mapping guidelines to map the partitions or the arrays to the cluster ports.

To add a new disk controller system to a running configuration, ensure that the cluster has detected the new storage MDisks by issuing the **svctask detectmdisk** command. The controller has automatically been assigned a default name. If you are unsure of which controller is presenting the MDisks, issue the **svctask lscontroller** command to list the controllers. The new controller is listed with the highest numbered default name. Record the controller name and follow the instructions in the section about determining a disk controller system name.

Give this controller a unique name by issuing the following command:

```
svctask chcontroller -name newname oldname
```

List the unmanaged MDisks by issuing the following command:

```
svcinfo lsmdisk -filtervalue mode=unmanaged:controller_name=newname
```

These MDisks correspond to the RAID arrays or partitions that you have created. Record the field controller LUN number. The field controller LUN number corresponds with the LUN number that you assigned to each of the arrays or partitions.

Create a new managed disk group and add only the RAID arrays that belong to the new controller to this MDisk group. Avoid mixing RAID types; for each set of RAID array types (for example, RAID-5 or RAID-1), create a new MDisk group. Assign this MDisk group an appropriate name; if your controller is called FAST650-abc and the MDisk group contains RAID-5 arrays, assign the MDisk a name similar to **F600-abc-R5**. Issue the following command:

```
svctask mkmdiskgrp -ext 16 -name mdisk_grp_name  
-mdisk colon-separated list of RAID-x mdisks returned
```

Note: This creates a new MDisk group with an extent size of 16 MB.

Possible failures

- CMMVC5786E The action failed because the cluster is not in a stable state.
- CMMVC5816E The action failed because an entity that was specified in the command does not exist.
- CMMVC6252E The command failed authorization because the session SSH key is wrong or was deleted.
- CMMVC6253E The command failed authorization because the session SSH key does not have the requisite role.

An invocation example

```
svctask chcontroller -name newtwo 2
```

The resulting output

No feedback

Chapter 27. Command-line interface messages

The command line displays a return value upon completion of the command. If the command completes normally and without error, the return code is **0**. If the command fails, the return code is **1** and the Error Code is sent to standard error. If the command succeeds, but the cluster is operating near its licensed virtualization limit, the return code can still be **1**, and a warning Error Code is sent to standard error.

When a create command is issued, the message ID that has been assigned to the new object is returned as part of the success message sent to standard output. If the **-quiet** parameter is used, only the message ID is sent to standard output.

CMMVC5000I No message was found for major rc *MAJOR_RC*, minor rc *MINOR_RC*, for action/view id *ACTION_VIEW_ID*.

Explanation

A message is missing.

Action

Contact the support center.

CMMVC5700E The parameter list is not valid.

Explanation

You have entered a list of parameters that is not supported for the command.

Action

Specify a parameter list that is supported for the command, and resubmit the command.

CMMVC5701E No object ID was specified.

Explanation

The command that you have submitted requires that you specify an object identifier name or ID number, and you did not specify an object identifier.

Action

Specify an object ID, and resubmit the command.

CMMVC5702E [%1] is below the minimum level.**Explanation**

You entered the specified string as a value for a parameter. The parameter requires a minimum value, and the specified string is less than the required minimum value.

Action

Specify a value that is supported by the parameter, and resubmit the command.

CMMVC5703E The value, or list starting with, [%1] is above the maximum permitted for that value or has exceeded the number of items allowed in a list.**Explanation**

You have entered the specified string as a value for a parameter. The string is either a standalone value or the first value in a list of values. If the string is a standalone value, the value is greater than the supported maximum value for the parameter. If the string is the first value in a list of values, the list contains more than the supported maximum number of entries for the parameter.

Action

Specify a value or list of values that is supported by the parameter, and resubmit the command.

CMMVC5704E [%1] is not divisible by the permitted step value.**Explanation**

You have entered the specified string as a value for a parameter. The string is not a supported value for the parameter. One requirement is that the value is an even multiple of 16, and the specified string does not meet that requirement.

Action

Specify a value that is supported by the parameter, and resubmit the command.

CMMVC5705E A required parameter is missing.**Explanation**

The command that you have submitted has at least one required parameter that you have not entered.

Action

Specify all of the required parameters, and resubmit the command.

CMMVC5706E An invalid argument has been entered for the [%1] parameter.

Explanation

You have entered a value for the specified parameter and the value is not supported for the parameter. The parameter supports a specific set of values.

Action

Specify a value that is supported by the parameter, and resubmit the command.

CMMVC5707E Required parameters are missing.

Explanation

The command that you have submitted has more than one required parameter that you have not entered.

Action

Specify all of the required parameters, and resubmit the command.

CMMVC5708E The %1 parameter is missing its associated arguments.

Explanation

You have entered the specified parameter without an associated value. This parameter, like most parameters, requires an associated value.

Action

Specify the associated value, and resubmit the command.

CMMVC5709E [%1] is not a supported parameter.

Explanation

The specified string is not a supported parameter for the command that you have entered.

Action

Specify the correct parameter, and resubmit the command.

CMMVC5711E [%1] is not valid data.

Explanation

You have entered the specified string as a value for a parameter. The string is not a supported value for the parameter.

Action

Specify a value that is supported by the parameter, and resubmit the command.

CMMVC5712E Required data is missing.**Explanation**

You have entered an incomplete command.

Action

Specify command completely, and resubmit the command.

CMMVC5713E Some parameters are mutually exclusive.**Explanation**

Certain commands have two or more parameters that are mutually exclusive. You have submitted a command using at least two mutually exclusive parameters.

Action

Specify a supported combination of parameters, and resubmit the command.

CMMVC5714E The parameter list is empty.**Explanation**

Certain parameters require one or more values in a colon separated parameter list. You have specified at least one parameter without the required parameter list.

Action

Specify at least one value for all parameters that require a value, and resubmit the command.

CMMVC5715E The parameter list does not exist.**Explanation**

Certain parameters require one or more values in a colon separated parameter list. You have specified at least one parameter without the required parameter list.

Action

Specify at least one value for all parameters that require a value, and resubmit the command.

CMMVC5716E Non-numeric data was entered for a numeric field ([%1]). Enter a numeric value.**Explanation**

You have entered the specified string as a value for a parameter that supports only numeric values.

Action

Specify a numeric value in the numeric field, and resubmit the command.

CMMVC5717E No match was found for the specified unit.**Explanation**

Certain parameters allow a user to specify a data unit such as mb or kb. You have entered a data unit for a parameter that supports data units, but the data unit that you have entered is not a supported data unit for the parameter.

Action

Specify the correct data unit, and resubmit the command.

CMMVC5718E An unexpected return code was received.**Explanation**

The command has completed, but the acknowledgement of the command completion contains a return code that is not defined.

Action

Determine whether or not the command has succeeded. If the command has not succeeded, resubmit the command. If the problem persists, contact IBM technical support for assistance.

CMMVC5719E A value of %2 requires the parameter %1 to be specified.**Explanation**

Certain commands have required combinations of parameters based on either the entry of a parameter or the value for a parameter. When you enter the specified value, you must enter the specified parameter. The inclusion of %2 in the submitted command requires that parameter %1 is specified.

Action

Specify the required parameter, and resubmit the command.

CMMVC5721E [%1] is not a valid time-stamp format. The valid format is MMDDHHmmYYYY.**Explanation**

[%1] is not a valid time-stamp format. The valid format is MMDDHHmmYYYY.

Action

Follow the correct time-stamp format and reissue the command.

CMMVC5722E [%1] is not a valid month.**Explanation**

[%1] is not a valid month.

Action

Specify the correct month (MM) and reissue the command.

CMMVC5723E [%1] is not a valid day.**Explanation**

[%1] is not a valid day.

Action

Specify the correct day (DD) and reissue the command.

CMMVC5724E [%1] is not a valid hour.**Explanation**

[%1] is not a valid hour.

Action

Specify the correct hour (HH) and reissue the command.

CMMVC5725E [%1] is not a valid minute.**Explanation**

[%1] is not a valid minute.

Action

Specify the correct minute (mm) and reissue the command.

CMMVC5726E [%1] are not valid seconds.**Explanation**

[%1] are not valid seconds.

Action

Specify the correct seconds (ss) and reissue the command.

CMMVC5727E [%1] is not a valid filter.**Explanation**

You can filter the output of some views by using the `-filtervalue` parameter. The specified string that you have entered is not a supported value for the `-filtervalue` parameter in this view.

Action

Ensure that you use a supported value for the `-filtervalue` parameter, and resubmit the command.

**CMMVC5728E [%1] should be in the format
minute:hour:day:month:weekday.****Explanation**

[%1] should be in the format `minute:hour:day:month:weekday`.

Action

Follow the correct format and reissue the command.

CMMVC5729E One or more components in the list is not valid.**Explanation**

Certain parameters support one or more items of data in a colon separated list. At least one of the items in the list that you have entered is not correct.

Action

Ensure that you enter supported values in the list, and resubmit the command.

CMMVC5730E %1 is only valid when %2 has a value of %3.**Explanation**

The specified command and parameter combination that you have entered requires the specified parameter value.

Action

Ensure that you specify the correct parameter value for the command and parameter combination that you enter, and resubmit the command.

CMMVC5731E %1 can only be entered when %2 has been entered.**Explanation**

Certain commands have required combinations of parameters based either on the inclusion of a specified parameter, or on the value entered for a specified parameter. When you include the first specified string in the command, you must enter the second specified string as a parameter.

Action

Ensure that you enter a supported combination or parameters and values, and resubmit the command.

CMMVC5732E The shared-memory interface is not available, return code %1.

Explanation

You cannot submit CLI commands because the shared memory interface (SMI) is not available.

Action

Ensure that your connection to the cluster is functioning properly. If the problem persists, contact IBM technical support for assistance and report that you have received the specified message and return code.

CMMVC5733E Enter at least one parameter.

Explanation

You must specify at least one parameter for the command that you have submitted.

Action

Specify at least one parameter, and resubmit the command.

CMMVC5734E A combination of values was entered that is not valid.

Explanation

You have specified a combination of values that is not correct.

Action

Specify a supported combination of values, and resubmit the command.

CMMVC5735E The name entered is not valid. Enter an alphanumeric string that does not start with a number.

Explanation

The first character of an object name cannot be numeric.

Action

Specify an alphanumeric string that does not start with a numeric, and resubmit the command.

**CMMVC5737E The parameter %1 has been entered multiple times.
Enter the parameter only one time.**

Explanation

The specified parameter was entered more than once.

Action

Delete all duplicate parameters, and resubmit the command.

CMMVC5738E The argument %1 contains too many characters.

Explanation

The field length of the specified argument is longer than the maximum supported field length for the argument.

Action

Specify the correct argument, and resubmit the command.

CMMVC5739E The argument %1 does not contain enough characters.

Explanation

The field length of the specified argument is less than the minimum supported field length for the argument.

Action

Specify the correct argument, and resubmit the command.

CMMVC5740E The filter flag %1 is not valid.

Explanation

You can filter the output of some views by using the `-filtervalue` parameter. The specified string that you have entered is not a supported value for the `-filtervalue` parameter in this view.

Action

Ensure that you use a supported value for the `-filtervalue` parameter, and resubmit the command.

CMMVC5741E The filter value %1 is not valid.

Explanation

You can filter the output of some views by using the `-filtervalue` parameter. Each filter has an associated value. The syntax is `-filtervalue filter=value`. The specified string that you have entered is not a supported value for the `-filtervalue` filter that you specified in this view.

Action

Ensure that you use a supported value for the -filtervalue filter that you specify, and resubmit the command.

CMMVC5742E A specified parameter is out of its valid range.

Explanation

You have entered data that is not in the range of values that is supported for the parameter that you have entered.

Action

Ensure that you enter data values that are supported for the parameter that you enter, and resubmit the command.

CMMVC5743E A specified parameter does not comply with the step value.

Explanation

A parameter was specified that does not comply with the step value.

Action

Specify the correct parameter and reissue the command.

CMMVC5744E Too many objects were specified in the command.

Explanation

There were too many objects specified in the command.

Action

Specify the correct object and reissue the command.

CMMVC5745E Too few objects were specified in the request.

Explanation

There were not enough objects specified in the command.

Action

Specify the correct object and reissue the command.

CMMVC5746E The requested operation cannot be applied to the object specified.

Explanation

The requested operation is not valid for this object.

Action

Specify a valid operation and reissue the command.

CMMVC5747E The action requested is invalid - internal error.

Explanation

The operation that was requested is not valid.

Action

Specify the correct operation and reissue the command.

CMMVC5748E The action requested is invalid - internal error.

Explanation

The operation that was requested is not valid.

Action

Specify the correct operation and reissue the command.

CMMVC5749E The dump filename specified already exists.

Explanation

The dump file name that was specified already exists.

Action

Specify a different dump file name and reissue the command.

CMMVC5750E The dump file could not be created - the filesystem is probably full.

Explanation

The dump file was not created. The file system might be full.

Action

Not applicable.

CMMVC5751E The dump file could not be written to.

Explanation

The dump file could not be written to disk.

Action

Not applicable.

CMMVC5752E Request failed. The object contains child objects, these must be deleted first.

Explanation

The operation failed because the specified object contains child objects.

Action

Delete the child objects and reissue the command.

CMMVC5753E The specified object does not exist or is not a suitable candidate.

Explanation

The specified object does not exist or is not a suitable candidate.

Action

Specify the correct object and reissue the command.

CMMVC5754E The specified object does not exist, or the name supplied does not meet the naming rules.

Explanation

The specified object does not exist, or the name of the object does not meet the naming requirements.

Action

Specify the correct object name and reissue the command.

CMMVC5755E Cannot create as the sizes of the specified objects do not match.

Explanation

The sizes of the specified objects do not match.

Action

Not applicable.

CMMVC5756E Cannot perform the request as the object id is already mapped to another object or is the subject of an FC or RC relationship.

Explanation

The operation failed because the specified object is already mapped.

Action

Specify a different object and reissue the command.

CMMVC5757E Self Defining Structure (SDS) defaults not found - internal error.**Explanation**

The defaults for the self describing structure were not found.

Action

Not applicable.

CMMVC5758E Object filename already exists.**Explanation**

The object filename already exists.

Action

Specify a different object filename and reissue the command.

CMMVC5759E An internal error has occurred - memory could not be allocated.**Explanation**

The memory cannot be allocated.

Action

Not applicable.

CMMVC5760E Failed to add the node to the cluster member list.**Explanation**

The node could not be added to the cluster.

Action

Not applicable.

CMMVC5761E Failed to delete the node from the cluster member list.**Explanation**

The node could not be deleted from the cluster.

Action

Not applicable.

CMMVC5762E The request did not complete before the timeout period expired.

Explanation

The operation failed because the timeout period expired.

Action

Reissue the command.

CMMVC5763E The node failed to go online.

Explanation

The node failed to go online.

Action

Not applicable.

CMMVC5764E The mode change request is invalid - internal error

Explanation

The specified mode change is not valid.

Action

Specify a different mode and reissue the command.

CMMVC5765E The object specified is no longer a candidate - a change occurred during the request.

Explanation

The specified object is no longer a candidate. A change occurred during the request.

Action

Specify a different object and reissue the command.

CMMVC5767E One or more of the parameters specified are invalid or a parameter is missing.

Explanation

One or more of the specified parameters is not valid.

Action

Specify the correct parameter and reissue the command.

CMMVC5769E The requested operation requires all nodes to be online - one or more nodes are not online.

Explanation

The operation requires that all nodes be online. One or more nodes are not online.

Action

Check that each node is online and reissue the command.

CMMVC5770E The ssh key file supplied is invalid.

Explanation

The file for the ssh key is not valid.

Action

Specify a different file and reissue the command.

CMMVC5771E The operation requested could not complete, usually due to child objects existing. To force the operation, specify the force flag.

Explanation

The operation failed, probably, because the object contains child objects.

Action

Specify the -force flag to complete the operation and then reissue the command.

CMMVC5772E The operation requested could not be performed because software upgrade is in progress.

Explanation

The operation failed because a software upgrade is in progress.

Action

Wait for the software upgrade to complete and then reissue the command.

CMMVC5773E The object selected is in the wrong mode to perform the requested operation.

Explanation

The operation failed because the selected object is in the wrong mode.

Action

Specify the correct mode and reissue the command.

CMMVC5774E The userid supplied is not valid.

Explanation

The userid is not valid.

Action

Specify a different userid and reissue the command.

CMMVC5775E The directory attribute specified is not valid.

Explanation

The directory attribute is not valid.

Action

Specify a different directory and reissue the command.

CMMVC5776E The directory listing could not be retrieved.

Explanation

The directory listing could not be retrieved.

Action

Specify a different directory listing and reissue the command.

CMMVC5777E The node could not be added to the I/O Group, because the other node in the I/O Group is in the same power domain.

Explanation

The node was not added to the I/O group because the other node in the I/O Group is in the same power domain.

Action

Specify a different node from another I/O group and reissue the command.

CMMVC5778E Cannot create another cluster, a cluster already exists.

Explanation

The cluster was not created because one already exists.

Action

Not applicable.

CMMVC5780E The action could not be completed using the Remote Cluster name. Use the Remote Cluster Unique ID instead.

Explanation

The unique ID of the remote cluster is required for this command.

Action

Specify the unique ID of the remote cluster, and reissue the command.

CMMVC5781E The cluster ID specified is invalid.

Explanation

The cluster ID is not valid.

Action

Specify a different cluster ID and reissue the command.

CMMVC5782E The object specified is offline.

Explanation

The object is offline.

Action

Specify an object that is online and reissue the command.

CMMVC5783E The information is not available to complete this command.

Explanation

This error is only returned when the node is in service mode.

Action

None.

CMMVC5784E The cluster name specified is not unique, specify the cluster using the cluster ID.

Explanation

The cluster name is not unique.

Action

Specify the cluster using the cluster ID and reissue the command.

CMMVC5785E The filename specified contains an illegal character.

Explanation

The filename contains an illegal character.

Action

Specify a valid filename and reissue the command.

CMMVC5786E The action failed because the cluster is not in a stable state.

Explanation

The action failed because the cluster is not in a stable state.

Action

Not applicable.

CMMVC5787E The cluster was not created because a cluster already exists.

Explanation

The cluster was not created because a cluster already exists.

Action

Not applicable.

CMMVC5788E The service IP address is not valid.

Explanation

The service IP address is not valid.

Action

Specify the correct service IP address and reissue the command.

CMMVC5789E The cluster was not modified because the IP address, subnet mask, service address, SNMP address, or gateway address is not valid.

Explanation

The cluster was not modified because the IP address, subnet mask, service address, SNMP address, or gateway address is not valid.

Action

Specify all correct attributes and reissue the command.

CMMVC5790E The node was not added to the cluster because the maximum number of nodes has been reached.

Explanation

The node was not added to the cluster because the maximum number of nodes has been reached.

Action

Not applicable.

CMMVC5791E The action failed because an object that was specified in the command does not exist.

Explanation

An entity that was specified in the command does not exist, therefore the action failed.

Action

Specify the correct entity and reissue the command.

CMMVC5792E The action failed because the I/O group is used for recovery.

Explanation

The action failed because the I/O group is used for recovery.

Action

Not applicable.

CMMVC5793E The node was not added to the cluster because the I/O group already contains a pair of nodes.

Explanation

The node was not added to the cluster because the I/O group already contains a pair of nodes.

Action

Not applicable.

CMMVC5794E The action failed because the node is not a member of the cluster.

Explanation

The node is not a member of the cluster, therefore the action failed.

Action

Specify a node that is contained in the cluster and reissue the command.

CMMVC5795E The node was not deleted because a software upgrade is in progress.

Explanation

The node was not deleted because a software upgrade is in progress.

Action

Wait for the software upgrade to complete and then reissue the command.

CMMVC5796E The action failed because the I/O group that the node belongs to is unstable.

Explanation

A previous configuration command might not yet have completed.

Action

Wait for the previous command to complete and then reissue the command.

CMMVC5797E The node was not deleted because this is the last node in the I/O group and there are virtual disks (VDisks) associated with the I/O group.

Explanation

The specified node is the last node in the I/O group and there are VDisks associated with the I/O group, therefore the node could not be deleted.

Action

Not applicable.

CMMVC5798E The action failed because the node is offline.

Explanation

The action failed because the node is offline.

Action

Specify a node that is online and reissue the command.

CMMVC5799E The shut down was not successful because there is only one online node in the I/O group.

Explanation

There is only one online node in the I/O group, therefore the shut down operation was not successful.

Action

Not applicable.

CMMVC5800E The action failed because an entity that was specified in the command does not exist.

Explanation

The entity that was specified in the command does not exist, therefore the action failed.

Action

Specify a different entity and reissue the command.

CMMVC5801E The upgrade of the cluster software could not proceed because every node in the cluster must be online. Either delete the node that is offline or bring the node online and resubmit the command

Explanation

The upgrade of the cluster software could not proceed because every node in the cluster must be online.

Action

Either delete the node that is offline or bring the node online and reissue the command.

CMMVC5802E The upgrade of the cluster software could not proceed because there is an I/O group in the cluster that contains only one node. The software upgrade requires that each node in an I/O group be shut down and restarted. If there is only one node in an I/O group, I/O operations could be lost if I/O operations are not stopped before beginning the software upgrade.

Explanation

The upgrade of the cluster software could not proceed because there is an I/O group in the cluster that contains only one node. The software upgrade requires that each node in an I/O group be shut down and restarted. If there is only one node in an I/O group, I/O operations could be lost if I/O operations are not stopped before beginning the software upgrade.

Action

Either upgrade the cluster using the -force option or specify a different node and reissue the command.

CMMVC5803E The entry in the error log was not marked because the error is already fixed or unfixed, or the sequence number could not be found.

Explanation

The entry in the error log was not marked because the sequence number was not found.

Action

Not applicable.

CMMVC5804E The action failed because an object that was specified in the command does not exist.

Explanation

The entity that was specified in the command does not exist, therefore the action failed.

Action

Specify a different entity and reissue the command.

CMMVC5805E The progress information was not returned because the FlashCopy statistics are not ready yet.

Explanation

The progress information was not returned because the FlashCopy statistics are not ready yet.

Action

Not applicable.

CMMVC5806E action failed because an object that was specified in the command does not exist.

Explanation

The entity that was specified in the command does not exist, therefore the action failed.

Action

Specify a different entity and reissue the command.

CMMVC5807E The action failed because the managed disk (MDisk) cannot be changed to the specified mode.

Explanation

The action failed because the managed disk (MDisk) cannot be changed to the specified mode.

Action

Not applicable.

CMMVC5808E The action failed because the managed disk (MDisk) does not exist.

Explanation

The action failed because the managed disk (MDisk) does not exist.

Action

Specify a different MDisk and reissue the command.

CMMVC5809E The tracing of I/O operations was not started because it is already in progress.

Explanation

The tracing of I/O operations was not started because it is already in progress.

Action

Not applicable.

CMMVC5810E The quorum index number for the managed disk (MDisk) was not set because the MDisk is offline.

Explanation

The quorum index number for the managed disk (MDisk) was not set because the MDisk is offline.

Action

Either change the status of the MDisk to online or specify a different MDisk and reissue the command.

CMMVC5811E The quorum index number for the managed disk (MDisk) was not set because the quorum disk does not exist.

Explanation

The quorum index number for the managed disk (MDisk) was not set because the quorum disk does not exist.

Action

Specify a different quorum disk and reissue the command.

CMMVC5812E The quorum index number for the managed disk (MDisk) was not set because the MDisk is in the wrong mode.

Explanation

The quorum index number for the managed disk (MDisk) was not set because the MDisk is not in the managed mode.

Action

- Change the mode of the MDisk and reissue the command
- Select an MDisk with a mode of managed and reissue the command

CMMVC5813E The quorum index number for the managed disk (MDisk) was not set because the MDisk has a sector size that is not valid.

Explanation

The parameter list that was specified is not valid.

Action

Specify a different sector size for the MDisk and reissue the command.

CMMVC5814E The quorum index number for the managed disk (MDisk) was not set because the unique identifier (UID) type is not valid.

Explanation

The quorum index number for the managed disk (MDisk) was not set because the unique identifier (UID) type is not valid.

Action

Specify a different unique identifier (UID) and reissue the command.

CMMVC5815E The managed disk (MDisk) group was not created because an entity that was specified in the command does not exist.

Explanation

The managed disk (MDisk) group was not created because an entity that was specified in the command does not exist.

Action

Specify a different entity and reissue the command.

CMMVC5816E The action failed because an entity that was specified in the command does not exist.

Explanation

The action failed because an entity that was specified in the command does not exist.

Action

Specify a different entity and reissue the command.

CMMVC5817E The specified managed disk (MDisk) group was invalid.

Explanation

The managed disk (MDisk) group was not renamed because the name was not valid.

Action

Specify a different MDisk group name and reissue the command.

CMMVC5818E The managed disk (MDisk) group was not deleted because there is at least one MDisk in the group.

Explanation

The managed disk (MDisk) group was not deleted because there is at least one MDisk in the group.

Action

Not applicable.

CMMVC5819E The managed disk (MDisk) was not added to the MDisk group because the MDisk is part of another MDisk group.

Explanation

The managed disk (MDisk) was not added to the MDisk group because the MDisk is part of another MDisk group.

Action

Not applicable.

CMMVC5820E The managed disk (MDisk) was not added to the MDisk group because an entity that was specified in the command does not exist.

Explanation

The managed disk (MDisk) was not added to the MDisk group because an entity that was specified in the command does not exist.

Action

Specify a different entity and reissue the command.

CMMVC5821E The managed disk (MDisk) was not added to the MDisk group because not enough MDisks were included in the list.

Explanation

The managed disk (MDisk) was not added to the MDisk group because not enough MDisks were included in the list.

Action

Include more MDisks in the list and reissue the command.

CMMVC5822E The managed disk (MDisk) was not added to the MDisk group because too many MDisks were included in the list.

Explanation

The managed disk (MDisk) was not added to the MDisk group because too many MDisks were included in the list.

Action

Delete the extra MDisks in the list and reissue the command.

CMMVC5823E The managed disk (MDisk) was not deleted from the MDisk group because the MDisk is part of another MDisk group.

Explanation

The managed disk (MDisk) was not deleted from the MDisk group because the MDisk is part of another MDisk group.

Action

Not applicable.

CMMVC5824E The managed disk (MDisk) was not deleted from the MDisk group because it does not belong to the MDisk group.

Explanation

The managed disk (MDisk) was not deleted from the MDisk group because it does not belong to the MDisk group.

Action

Not applicable.

CMMVC5825E The managed disk (MDisk) was not deleted from the MDisk group because a virtual disk (VDisk) is allocated from one or more of the specified MDisks. A forced deletion is required.

Explanation

The managed disk (MDisk) was not deleted from the MDisk group because a virtual disk (VDisk) is allocated from one or more of the specified MDisks.

Action

Specify the `-force` option and reissue the command.

CMMVC5826E The virtual disk (VDisk) was not created because an entity that was specified in the command does not exist.

Explanation

The virtual disk (VDisk) was not created because an entity that was specified in the command does not exist.

Action

Specify a different entity and reissue the command.

CMMVC5827E The command failed as a result of either an inconsistency between two or more of the entered parameters, or an inconsistency between a parameter and the requested action.

Explanation

The command failed as a result of an inconsistency between two or more of the entered parameters.

Action

Specify one parameter and reissue the command.

CMMVC5828E The virtual disk (VDisk) was not created because the I/O group contains no nodes.

Explanation

The virtual disk (VDisk) was not created because the I/O group contains no nodes.

Action

Not applicable.

CMMVC5829E The image-mode or sequential-mode virtual disk (VDisk) was not created because more than one managed disk (MDisk) is specified.

Explanation

The image-mode or sequential-mode VDisk was not created because more than one MDisk is specified.

Action

Specify a different MDisk and reissue the command.

CMMVC5830E The image-mode virtual disk (VDisk) was not created because no managed disk (MDisk) was specified in the command.

Explanation

The image-mode virtual disk (VDisk) was not created because no managed disk (MDisk) was specified in the command.

Action

Specify a MDisk and reissue the command.

CMMVC5831E The virtual disk (VDisk) was not created because the preferred node for I/O operations is not part of the I/O group.

Explanation

The virtual disk (VDisk) was not created because the preferred node for I/O operations is not part of the I/O group.

Action

Specify a different node and reissue the command.

CMMVC5832E The property of the virtual disk (VDisk) was not modified because an entity that was specified in the command does not exist.

Explanation

The property of the virtual disk (VDisk) was not modified because an entity that was specified in the command does not exist.

Action

Specify a different entity and reissue the command.

CMMVC5833E The property of the virtual disk (VDisk) was not modified because there are no nodes in the I/O group.

Explanation

The property of the virtual disk (VDisk) was not modified because there are no nodes in the I/O group.

Action

Not applicable.

CMMVC5834E The I/O group for the virtual disk (VDisk) was not modified because the group is a recovery I/O group. To modify the I/O group, use the force option.

Explanation

The I/O group for the virtual disk (VDisk) was not modified because the group is a recovery I/O group.

Action

Specify the -force option and reissue the command.

CMMVC5835E The virtual disk (VDisk) was not expanded because an entity that was specified in the command does not exist.

Explanation

The virtual disk (VDisk) was not expanded because an entity that was specified in the command does not exist.

Action

Specify a different entity and reissue the command.

CMMVC5836E The virtual disk (VDisk) was not shrunk because it is locked.

Explanation

Commands might still be running in the background.

Action

Wait for all commands to complete. Use the `svcinfo lsmigrate` command to view any migrates running in the background.

CMMVC5837E The action failed because the virtual disk (VDisk) is part of a FlashCopy mapping.

Explanation

The action failed because the virtual disk (VDisk) is part of a FlashCopy mapping.

Action

Specify a different VDisk that is not part of a FlashCopy mapping and reissue the command.

CMMVC5838E The action failed because the virtual disk (VDisk) is part of a Remote Copy mapping.

Explanation

The action failed because the virtual disk (VDisk) is part of a Remote Copy mapping.

Action

Specify a different VDisk that is not part of a Remote Copy mapping, and resubmit the command.

CMMVC5839E The virtual disk (VDisk) was not shrunk because an object that was specified in the command does not exist.

Explanation

The virtual disk (VDisk) was not shrunk because an object that was specified in the command does not exist.

Action

Specify a different object, and resubmit the command.

CMMVC5840E The virtual disk (VDisk) was not deleted because it is mapped to a host or because it is part of a FlashCopy or Remote Copy mapping, or is involved in an image mode migrate.

Explanation

The virtual disk (VDisk) was not deleted because it is mapped to a host or because it is part of a FlashCopy or Metro Mirror mapping.

Action

Specify a different VDisk and reissue the command.

CMMVC5841E The virtual disk (VDisk) was not deleted because it does not exist.

Explanation

The virtual disk (VDisk) was not deleted because it does not exist.

Action

Specify a different VDisk and reissue the command.

CMMVC5842E The action failed because an object that was specified in the command does not exist.

Explanation

The action failed because an entity that was specified in the command does not exist.

Action

Specify a different entity and reissue the command.

CMMVC5843E The virtual disk (VDisk)-to-host mapping was not created because the VDisk does not have a capacity greater than zero bytes.

Explanation

The virtual disk (VDisk)-to-host mapping was not created because the VDisk does not have a capacity greater than zero bytes.

Action

Specify a VDisk in which its capacity is greater than zero bytes and reissue the command.

CMMVC5844E The virtual disk (VDisk)-to-host mapping was not created because the SCSI logical unit number (LUN) ID is not valid.

Explanation

The virtual disk (VDisk)-to-host mapping was not created because the SCSI logical unit number (LUN) ID is not valid.

Action

Specify the correct SCSI logical unit number (LUN) ID and reissue the command.

CMMVC5845E The extent was not migrated because an object that was specified in the command does not exist.

Explanation

The extent was not migrated because an object that was specified in the command does not exist.

Action

Specify a different object, and resubmit the command.

CMMVC5846E The virtual disk (VDisk) was not migrated because an object that was specified in the command does not exist.

Explanation

The virtual disk (VDisk) was not migrated because an object that was specified in the command does not exist.

Action

Specify a different object, and resubmit the command.

CMMVC5847E The virtual disk (VDisk) was not migrated because its associated managed disk (MDisk) is already in the MDisk group.

Explanation

The virtual disk (VDisk) was not migrated because its associated managed disk (MDisk) is already in the MDisk group.

Action

Not applicable.

CMMVC5848E The action failed because the virtual disk (VDisk) does not exist or it is being deleted.

Explanation

The action failed because the virtual disk (VDisk) does not exist or it is being deleted.

Action

Specify a different VDisk and reissue the command.

CMMVC5849E The migration failed because some or all of the extents are already being migrated.

Explanation

The migration failed because some or all of the extents are already being migrated.

Action

Not applicable.

CMMVC5850E The extent was not migrated because there is a problem with the source extents.

Explanation

The extent was not migrated because there is a problem with the source extents.

Action

Not applicable.

CMMVC5851E The extent was not migrated because there is a problem with the target extents.

Explanation

The extent was not migrated because there is a problem with the target extents.

Action

Not applicable.

CMMVC5852E The migration failed because there are too many migrations in progress.

Explanation

The migration failed because there are too many migrations in progress.

Action

Wait for the migration process to complete and reissue the command.

CMMVC5853E The action failed because there was a problem with the group.

Explanation

An attempt was made to work on a VDisk which is using an MDisk group with one of the following problems:

- The target and source MDisk groups have different extent sizes (group migrate).
- The target and source MDisk groups are the same (group migrate).
- The target and source MDisk groups are different (extents migrate).
- Target invalid group (Group Migrate).
- Source invalid group (Group Migrate).

Action

Ensure that none of the above conditions exist before reissuing the command.

CMMVC5854E The extent information was not returned because the extent is not used or does not exist.

Explanation

The extent information was not returned because the extent is not used or does not exist.

Action

Specify the correct extent and reissue the command.

CMMVC5855E The extent information was not returned because the managed disk (MDisk) is not used by any virtual disk (VDisk).

Explanation

The extent information was not returned because the managed disk (MDisk) is not used by any virtual disk (VDisk).

Action

Specify the correct MDisk and reissue the command.

CMMVC5856E The action failed because the virtual disk (VDisk) does not belong to the specified managed disk (MDisk) group.

Explanation

The action failed because the virtual disk (VDisk) does not belong to the specified managed disk (MDisk) group.

Action

Specify a different VDisk and reissue the command.

CMMVC5857E The action failed because the managed disk (MDisk) does not exist or it is not a member of the managed disk (MDisk) group.

Explanation

The action failed because the managed disk (MDisk) does not exist or it is not a member of the managed disk (MDisk) group.

Action

Specify a different MDisk and reissue the command.

CMMVC5858E The action failed because the virtual disk (VDisk) is in the wrong mode, the managed disk (MDisk) is in the wrong mode, or both are in the wrong mode.

Explanation

The action failed because the virtual disk (VDisk) is in the wrong mode, the managed disk (MDisk) is in the wrong mode, or both are in the wrong mode.

Action

Check that the VDisk and MDisk are in the correct mode and reissue the command.

CMMVC5859E The migration did not complete because an error occurred during the migration of the last extent on an image-mode virtual disk (VDisk).

Explanation

The migration did not complete because an error occurred during the migration of the last extent on an image-mode virtual disk (VDisk).

Action

Not applicable.

CMMVC5860E The action failed because there were not enough extents in the managed disk (MDisk) group.

Explanation

This error is also returned if a stripe set of MDisks has been specified and one or more of these MDisks does not contain enough free extents to complete the creation of the VDisk.

Action

In this case, the MDisk group reports that it has enough free capacity to create the VDisk. You can check the free capacity on each MDisk by issuing the `svcinfo lsfreeextents <mdiskname/ID>`. Alternatively, do not specify a stripe set and let the system choose the free extents automatically.

CMMVC5861E The action failed because there were not enough extents on the managed disk (MDisk).

Explanation

The action failed because there were not enough extents on the managed disk (MDisk).

Action

Specify another extent and reissue the command.

CMMVC5862E The action failed because the virtual disk (VDisk) is being formatted.

Explanation

The action failed because the virtual disk (VDisk) is being formatted.

Action

Wait for the VDisk to be successfully formatted and then reissue the command.

CMMVC5863E The migration failed because there are not enough free extents on the target managed disk (MDisk).

Explanation

The migration failed because there are not enough free extents on the target managed disk (MDisk).

Action

Specify another free extent and reissue the command.

CMMVC5864E The extent information was not returned because the source extent is not used.

Explanation

The extent information was not returned because the source extent is not used.

Action

Specify a different source extent and reissue the command.

CMMVC5865E The action failed because the extent is out of range for the managed disk (MDisk) or virtual disk (VDisk) specified.

Explanation

The extent information was not returned because the extent is out of range for the managed disk (MDisk) or virtual disk (VDisk).

Action

Specify a different extent which is in range for the MDisk or VDisk and reissue the command.

CMMVC5866E The action failed because the extent contains internal data.

Explanation

The extent was not migrated because the extent contains internal data.

Action

Not applicable.

CMMVC5867E The action failed because the worldwide port name is already assigned or is not valid.

Explanation

The action failed because the worldwide port name is already assigned or is not valid.

Action

Specify a different worldwide port name and reissue the command.

CMMVC5868E The action failed because an entity that was specified in the command does not exist.

Explanation

The action failed because an entity that was specified in the command does not exist.

Action

Specify a different entity and reissue the command.

CMMVC5869E The host object was not renamed because the host ID or name is not valid.

Explanation

The host object was not renamed because the host ID or name is not valid.

Action

Specify a different host ID or name and reissue the command.

CMMVC5870E The host object was not deleted because an entity that was specified in the command does not exist.

Explanation

The host object was not deleted because an entity that was specified in the command does not exist.

Action

Specify the correct entity and reissue the command.

CMMVC5871E The action failed because one or more of the configured worldwide port names is in a mapping.

Explanation

The action failed because one or more of the configured worldwide port names is in a mapping.

Action

Specify a worldwide port name that is not in a mapping and reissue the command.

CMMVC5872E The port (WWPN) was not added to the host object because an object that was specified in the command does not exist.

Explanation

The port (WWPN) was not added to the host object because an object that was specified in the command does not exist.

Action

Specify the correct object, and resubmit the command.

CMMVC5873E No matching WWPN.

Explanation

The action failed because there is no matching worldwide port name.

Action

Not applicable.

CMMVC5874E The action failed because the host does not exist.

Explanation

The action failed because the host does not exist.

Action

Specify a different host and reissue the command.

CMMVC5875E The action failed because the virtual disk (VDisk) does not exist.

Explanation

The action failed because the virtual disk (VDisk) does not exist.

Action

Specify a different VDisk and reissue the command.

CMMVC5876E The virtual disk (VDisk)-to-host mapping was not created because the maximum number of mappings has been reached.

Explanation

The virtual disk (VDisk)-to-host mapping was not created because the maximum number of mappings has been reached.

Action

Not applicable.

CMMVC5877E The virtual disk (VDisk)-to-host mapping was not created because the maximum number of SCSI LUNs has been allocated.

Explanation

The virtual disk (VDisk)-to-host mapping was not created because the maximum number of SCSI LUNs has been allocated.

Action

Not applicable.

CMMVC5878E The virtual disk (VDisk)-to-host mapping was not created because this VDisk is already mapped to this host.

Explanation

The virtual disk (VDisk)-to-host mapping was not created because this VDisk is already mapped to this host.

Action

Specify a different VDisk and reissue the command.

CMMVC5879E The virtual disk (VDisk)-to-host mapping was not created because a VDisk is already mapped to this host with this SCSI LUN.

Explanation

The virtual disk-to-host mapping was not created because this SCSI LUN is already assigned to another mapping.

Action

Specify a different SCSI LUN and reissue the command.

CMMVC5880E The virtual disk was not created because a capacity of zero bytes is not allowed for image mode disks.

Explanation

The virtual disk (VDisk)-to-host mapping was not created because the VDisk has a capacity of zero bytes.

Action

Specify a different VDisk and reissue the command.

CMMVC5881E The FlashCopy mapping was not created because an entity that was specified in the command does not exist.

Explanation

The FlashCopy mapping was not created because an entity that was specified in the command does not exist.

Action

Specify a different entity and reissue the command.

CMMVC5882E The FlashCopy mapping was not created because a mapping for the source or target virtual disk (VDisk) already exists.

Explanation

The FlashCopy mapping was not created because a mapping for the source or target virtual disk (VDisk) already exists.

Action

Specify a different source or target VDisk and reissue the command.

CMMVC5883E The FlashCopy mapping was not created because the recovery I/O group is associated with the source or target virtual disk (VDisk).

Explanation

The FlashCopy mapping was not created because the recovery I/O group is associated with the source or target virtual disk (VDisk).

Action

Specify a different recovery I/O group and reissue the command.

CMMVC5884E The FlashCopy mapping was not created because the source or target virtual disk (VDisk) cannot be a member of a Remote Copy mapping.

Explanation

The FlashCopy mapping was not created because the source or target virtual disk (VDisk) cannot be a member of a Remote Copy mapping.

Action

Specify a different source or target VDisk, and resubmit the command.

CMMVC5885E The FlashCopy mapping was not created because this source or target virtual disk (VDisk) cannot be a member of a FlashCopy mapping.

Explanation

The FlashCopy mapping was not created because this source or target virtual disk (VDisk) cannot be a member of a FlashCopy mapping.

Action

Specify a different source or target VDisk and reissue the command.

CMMVC5886E The FlashCopy mapping was not created because the source or target virtual disk (VDisk) is associated with the recovery I/O group.

Explanation

The FlashCopy mapping was not created because the source or target virtual disk (VDisk) is associated with the recovery I/O group.

Action

Specify a different source or target VDisk and reissue the command.

CMMVC5887E The FlashCopy mapping was not created because the source or target virtual disk (VDisk) must not be in router mode.

Explanation

The FlashCopy mapping was not created because the source or target virtual disk (VDisk) must not be in router mode.

Action

Specify a different source or target VDisk and reissue the command.

CMMVC5888E The action failed because an entity that was specified in the command does not exist.

Explanation

The action failed because an entity that was specified in the command does not exist.

Action

Specify the correct entity and reissue the command.

CMMVC5889E The FlashCopy mapping was not deleted because an entity that was specified in the command does not exist.

Explanation

The FlashCopy mapping was not deleted because an entity that was specified in the command does not exist.

Action

Specify a different entity and reissue the command.

CMMVC5890E The FlashCopy mapping or consistency group was not started because starting consistency group 0 is not a valid operation.

Explanation

The FlashCopy mapping or consistency group was not started because starting consistency group 0 is not a valid operation.

Action

Not applicable.

CMMVC5891E The FlashCopy consistency group was not created because the name is not valid.

Explanation

The FlashCopy consistency group was not created because the name is not valid.

Action

Specify a different name and reissue the command.

CMMVC5892E The FlashCopy consistency group was not created because it already exists.

Explanation

The FlashCopy consistency group was not created because it already exists.

Action

Not applicable.

CMMVC5893E The action failed because an entity that was specified in the command does not exist.

Explanation

The action failed because an entity that was specified in the command does not exist.

Action

Specify the correct entity and reissue the command.

CMMVC5894E The FlashCopy consistency group was not deleted because you are trying to delete consistency group 0 or the name of the consistency group is not valid.

Explanation

The FlashCopy consistency group was not deleted because the name of the consistency group is not valid or you are trying to delete consistency group 0.

Action

Specify the correct consistency group and reissue the command.

CMMVC5895E The FlashCopy consistency group was not deleted because it contains mappings. To delete this consistency group, a forced deletion is required.

Explanation

The FlashCopy consistency group was not deleted because it contains mappings.

Action

Specify that -force option to delete the consistency group.

CMMVC5896E The FlashCopy mapping was not deleted because the mapping or consistency group is in the preparing state. The mapping or consistency group must be stopped first.

Explanation

The FlashCopy mapping was not deleted because the mapping or consistency group is in the preparing state. The mapping or consistency group must be stopped first.

Action

Stop the consistency group and then reissue the command.

CMMVC5897E The FlashCopy mapping was not deleted because the mapping or consistency group is in the prepared state. The mapping or consistency group must be stopped first.

Explanation

The FlashCopy mapping was not deleted because the mapping or consistency group is in the prepared state. The mapping or consistency group must be stopped first.

Action

Stop the consistency group and then reissue the command.

CMMVC5898E The FlashCopy mapping was not deleted because the mapping or consistency group is in the copying state. The mapping or consistency group must be stopped first.

Explanation

The FlashCopy mapping was not deleted because the mapping or consistency group is in the copying state. The mapping or consistency group must be stopped first.

Action

Stop the consistency group and then reissue the command.

CMMVC5899E The FlashCopy mapping was not deleted because the mapping or consistency group is in the stopped state. To delete the mapping, a forced deletion is required.

Explanation

The FlashCopy mapping was not deleted because the mapping or consistency group is in the stopped state.

Action

Specify the `-force` option to delete the mapping.

CMMVC5900E The FlashCopy mapping was not deleted because the mapping or consistency group is in the suspended state. The mapping or consistency group must be stopped first.

Explanation

The FlashCopy mapping was not deleted because the mapping or consistency group is in the suspended state. The mapping or consistency group must be stopped first.

Action

Stop the consistency group and the reissue the command.

CMMVC5901E The FlashCopy mapping was not prepared because the mapping or consistency group is already in the preparing state.

Explanation

The FlashCopy mapping was not prepared because the mapping or consistency group is already in the preparing state.

Action

Not applicable.

CMMVC5902E The FlashCopy mapping was not prepared because the mapping or consistency group is already in the prepared state.

Explanation

The FlashCopy mapping was not prepared because the mapping or consistency group is already in the prepared state.

Action

Not applicable.

CMMVC5903E The FlashCopy mapping was not prepared because the mapping or consistency group is already in the copying state.

Explanation

The FlashCopy mapping was not prepared because the mapping or consistency group is already in the copying state.

Action

Not applicable.

CMMVC5904E The FlashCopy mapping was not prepared because the mapping or consistency group is already in the suspended state.

Explanation

The FlashCopy mapping was not prepared because the mapping or consistency group is already in the suspended state.

Action

Not applicable.

CMMVC5905E The FlashCopy mapping or consistency group was not started because the mapping or consistency group is in the idle state. The mapping or consistency group must be prepared first.

Explanation

The FlashCopy mapping or consistency group was not started because the mapping or consistency group is in the idle state.

Action

Prepare the mapping or consistency group and then reissue the command.

CMMVC5906E The FlashCopy mapping or consistency group was not started because the mapping or consistency group is in the preparing state.

Explanation

The FlashCopy mapping or consistency group was not started because the mapping or consistency group is in the preparing state.

Action

Not applicable.

CMMVC5907E The FlashCopy mapping or consistency group was not started because the mapping or consistency group is already in the copying state.

Explanation

The FlashCopy mapping or consistency group was not started because the mapping or consistency group is already in the copying state.

Action

Not applicable.

CMMVC5908E The FlashCopy mapping or consistency group was not started because the mapping or consistency group is in the stopped state. The mapping or consistency group must be prepared first.

Explanation

The FlashCopy mapping or consistency group was not started because the mapping or consistency group is in the stopped state.

Action

Prepare the mapping or consistency group and reissue the command.

CMMVC5909E The FlashCopy mapping or consistency group was not started because the mapping or consistency group is in the suspended state.

Explanation

The FlashCopy mapping or consistency group was not started because the mapping or consistency group is in the suspended state.

Action

Not applicable.

CMMVC5910E The FlashCopy mapping or consistency group was not stopped because the mapping or consistency group is in the idle state.

Explanation

The FlashCopy mapping or consistency group was not stopped because the mapping or consistency group is in the idle state.

Action

Not applicable.

CMMVC5911E The FlashCopy mapping or consistency group was not stopped because the mapping or consistency group is in the preparing state.

Explanation

The FlashCopy mapping or consistency group was not stopped because the mapping or consistency group is in the preparing state.

Action

Not applicable.

CMMVC5912E The FlashCopy mapping or consistency group was not stopped because the mapping or consistency group is already in the stopped state.

Explanation

The FlashCopy mapping or consistency group was not stopped because the mapping or consistency group is already in the stopped state.

Action

Not applicable.

CMMVC5913E The properties of the FlashCopy mapping were not modified because the mapping or consistency group is in the preparing state.

Explanation

The properties of the FlashCopy mapping were not modified because the mapping or consistency group is in the preparing state.

Action

Not applicable.

CMMVC5914E The properties of the FlashCopy mapping were not modified because the mapping or consistency group is in the prepared state.

Explanation

The properties of the FlashCopy mapping were not modified because the mapping or consistency group is in the prepared state.

Action

Not applicable.

CMMVC5915E The properties of the FlashCopy mapping were not modified because the mapping or consistency group is in the copying state.

Explanation

The properties of the FlashCopy mapping were not modified because the mapping or consistency group is in the copying state.

Action

Not applicable.

CMMVC5916E The properties of the FlashCopy mapping were not modified because the mapping or consistency group is in the suspended state.

Explanation

The properties of the FlashCopy mapping were not modified because the mapping or consistency group is in the suspended state.

Action

Not applicable.

CMMVC5917E The FlashCopy mapping was not created because there is no memory in which to create the bitmap.

Explanation

The FlashCopy mapping was not created because there is no memory to create the bitmap.

Action

Not applicable.

CMMVC5918E The FlashCopy mapping was not prepared because the I/O group is offline.

Explanation

The FlashCopy mapping was not prepared because the I/O group is offline.

Action

Not applicable.

CMMVC5919E The FlashCopy mapping or consistency group was not started because the I/O group is offline.

Explanation

The FlashCopy mapping or consistency group was not started because the I/O group is offline.

Action

Not applicable.

CMMVC5920E The FlashCopy mapping was not created because the consistency group is not idle.

Explanation

The FlashCopy mapping was not created because the consistency group is not idle.

Action

Not applicable.

CMMVC5921E The properties of the FlashCopy mapping were not modified because the consistency group is not idle.

Explanation

The properties of the FlashCopy mapping were not modified because the consistency group is not idle.

Action

Not applicable.

CMMVC5922E The FlashCopy mapping was not created because the destination virtual disk (VDisk) is too small.

Explanation

The FlashCopy mapping was not created because the destination virtual disk (VDisk) is too small.

Action

Specify a different VDisk and reissue the command.

CMMVC5923E The FlashCopy mapping was not created because the I/O group is offline.

Explanation

The FlashCopy mapping was not created because the I/O group is offline.

Action

Not applicable.

CMMVC5924E The FlashCopy mapping was not created because the source and target virtual disks (VDisks) are different sizes.

Explanation

The FlashCopy mapping was not created because the source and target virtual disks (VDisks) are different sizes.

Action

Specify a different source and target VDisk that are the same size and reissue the command.

CMMVC5925E The remote cluster partnership was not created because it already exists.

Explanation

The remote cluster partnership was not created because it already exists.

Action

Specify a different remote cluster partnership and reissue the command.

CMMVC5926E The remote cluster partnership was not created because there are too many partnerships.

Explanation

The remote cluster partnership was not created because there are too many partnerships.

Action

Not applicable.

CMMVC5927E The action failed because the cluster ID is not valid.

Explanation

The action failed because the cluster ID is not valid.

Action

Specify the correct cluster ID and reissue the command.

CMMVC5928E The action failed because the cluster name is a duplicate of another cluster.

Explanation

The action failed because the cluster name is a duplicate of another cluster.

Action

Specify a different cluster name and reissue the command.

CMMVC5929E The Remote Copy partnership was not deleted because it has already been deleted.

Explanation

The Remote Copy partnership was not deleted because it has already been deleted.

Action

Not applicable.

CMMVC5930E The Remote Copy relationship was not created because an object that was specified in the command does not exist.

Explanation

The Remote Copy relationship was not created because an object that was specified in the command does not exist.

Action

Specify the correct object, and resubmit the command.

CMMVC5931E The Remote Copy relationship was not created because the master or auxiliary virtual disk (VDisk) is locked.

Explanation

The Remote Copy relationship was not created because the master or auxiliary virtual disk (VDisk) is locked.

Action

Unlock the master or auxiliary VDisk, and resubmit the command.

CMMVC5932E The Remote Copy relationship was not created because the master or auxiliary virtual disk (VDisk) is a member of a FlashCopy mapping.

Explanation

The Remote Copy relationship was not created because the master or auxiliary virtual disk (VDisk) is a member of a FlashCopy mapping.

Action

Not applicable.

CMMVC5933E The Remote Copy relationship was not created because the master or auxiliary virtual disk (VDisk) is in the recovery I/O group.

Explanation

The Remote Copy relationship was not created because the master or auxiliary virtual disk (VDisk) is in the recovery I/O group.

Action

Not applicable.

CMMVC5934E The Remote Copy relationship was not created because the master or auxiliary virtual disk (VDisk) is in the router mode.

Explanation

The Remote Copy relationship was not created because the master or auxiliary virtual disk (VDisk) is in the router mode.

Action

Not applicable.

CMMVC5935E The action failed because an object that was specified in the command does not exist.

Explanation

The action failed because an object that was specified in the command does not exist.

Action

Specify the correct object, and resubmit the command.

CMMVC5936E The action failed because an object that was specified in the command does not exist.

Explanation

The action failed because an object that was specified in the command does not exist.

Action

Specify the correct object, and resubmit the command.

CMMVC5937E The action failed because an object that was specified in the command does not exist.

Explanation

The action failed because an object that was specified in the command does not exist.

Action

Specify the correct object, and resubmit the command.

CMMVC5938E The Remote Copy consistency group was not deleted because the consistency group contains relationships. To delete the consistency group, the force option is required.

Explanation

Remote Copy consistency group was not deleted because the consistency group contains relationships.

Action

Specify the -force option to delete the consistency group.

CMMVC5939E The action failed because the cluster is not in a stable state.

Explanation

The action failed because the cluster is not in a stable state.

Action

Not applicable.

CMMVC5940E The cluster that contains the auxiliary virtual disk (VDisk) is unknown.

Explanation

The cluster that contains the auxiliary virtual disk (VDisk) is unknown.

Action

Not applicable.

CMMVC5941E The cluster that contains the master virtual disk (VDisk) has too many consistency groups.

Explanation

The cluster that contains the master virtual disk (VDisk) has too many consistency groups.

Action

Not applicable.

CMMVC5942E The cluster that contains the auxiliary virtual disk (VDisk) has too many consistency groups.

Explanation

The cluster that contains the auxiliary virtual disk (VDisk) has too many consistency groups.

Action

Not applicable.

CMMVC5943E The specified relationship is not valid.

Explanation

The specified relationship is not valid.

Action

Specify the correct relationship and reissue the command.

CMMVC5944E The specified consistency group is not valid.**Explanation**

The specified consistency group is not valid.

Action

Specify the correct consistency group and reissue the command.

CMMVC5945E The specified master cluster is not valid.**Explanation**

The specified master cluster is not valid.

Action

Specify the correct master cluster and reissue the command.

CMMVC5946E The specified auxiliary cluster is not valid.**Explanation**

The specified auxiliary cluster is not valid.

Action

Specify the correct auxiliary cluster and reissue the command.

CMMVC5947E The specified master virtual disk (VDisk) is not valid.**Explanation**

The specified master virtual disk (VDisk) is not valid.

Action

Specify the correct master VDisk and reissue the command.

CMMVC5948E The specified auxiliary virtual disk (VDisk) is not valid.**Explanation**

The specified auxiliary virtual disk (VDisk) is not valid.

Action

Specify the auxiliary VDisk and reissue the command.

CMMVC5949E The specified relationship is unknown.**Explanation**

The specified relationship is unknown.

Action

Specify a different relationship and reissue the command.

CMMVC5950E The specified consistency group is unknown.**Explanation**

The specified consistency group is unknown.

Action

Specify a different consistency group and reissue the command.

CMMVC5951E The operation cannot be performed because the relationship is not a stand-alone relationship.**Explanation**

The operation cannot be performed because the relationship is not a stand-alone one.

Action

Not applicable.

CMMVC5952E The relationship and consistency group have different master clusters.**Explanation**

The relationship and consistency group have different master clusters.

Action

Not applicable.

CMMVC5953E The relationship and group have different auxiliary clusters.**Explanation**

The relationship and group have different auxiliary clusters.

Action

Not applicable.

CMMVC5954E The master and auxiliary virtual disks (VDisks) are different sizes.

Explanation

The master and auxiliary virtual disks (VDisks) are different sizes

Action

Not applicable.

CMMVC5955E The maximum number of relationships has been reached.

Explanation

The maximum number of relationships has been reached.

Action

Not applicable.

CMMVC5956E The maximum number of consistency groups has been reached.

Explanation

The maximum number of consistency groups has been reached.

Action

Not applicable.

CMMVC5957E The master virtual disk (VDisk) is already in a relationship.

Explanation

The master virtual disk (VDisk) is already in a relationship.

Action

Specify a different master VDisk and reissue the command.

CMMVC5958E The auxiliary virtual disk (VDisk) is already in a relationship.

Explanation

The auxiliary virtual disk (VDisk) is already in a relationship.

Action

Specify a different auxiliary VDisk and reissue the command.

CMMVC5959E There is a relationship that already has this name on the master cluster.

Explanation

There is a relationship that already has this name on the master cluster.

Action

Specify a different name and reissue the command.

CMMVC5960E There is a relationship that already has this name on the auxiliary cluster.

Explanation

There is a relationship that already has this name on the auxiliary cluster.

Action

Specify a different name and reissue the command.

CMMVC5961E There is a consistency group that already has this name on the master cluster.

Explanation

There is a consistency group that already has this name on the master cluster.

Action

Specify a different name and reissue the command.

CMMVC5962E There is a consistency group that already has this name on the auxiliary cluster.

Explanation

There is a consistency group that already has this name on the auxiliary cluster.

Action

Specify a different name and reissue the command.

CMMVC5963E No direction has been defined.

Explanation

No direction has been defined.

Action

Not applicable.

CMMVC5964E The copy priority is not valid.**Explanation**

The copy priority is not valid.

Action

Not applicable.

CMMVC5965E The virtual disks (VDisks) are in different I/O groups on the local cluster.**Explanation**

The virtual disks (VDisks) are in different I/O groups on the local cluster.

Action

Not applicable.

CMMVC5966E The master virtual disk (VDisk) is unknown.**Explanation**

The master virtual disk (VDisk) is unknown.

Action

Specify a different master VDisk and reissue the command.

CMMVC5967E The auxiliary virtual disk (VDisk) is unknown.**Explanation**

The auxiliary virtual disk (VDisk) is unknown.

Action

Specify a different auxiliary VDisk and reissue the command.

CMMVC5968E The relationship cannot be added because the states of the relationship and the consistency group do not match.**Explanation**

The relationship cannot be added because the states of the relationship and the consistency group do not match.

Action

Not applicable.

CMMVC5969E The Remote Copy relationship was not created because the I/O group is offline.

Explanation

The Remote Copy relationship was not created because the I/O group is offline.

Action

Not applicable.

CMMVC5970E The Remote Copy relationship was not created because there is not enough memory.

Explanation

The Remote Copy relationship was not created because there is not enough memory.

Action

Not applicable.

CMMVC5971E The operation was not performed because the consistency group contains no relationships.

Explanation

The operation was not performed because the consistency group contains no relationships.

Action

Not applicable.

CMMVC5972E The operation was not performed because the consistency group contains relationships.

Explanation

The operation was not performed because the consistency group contains relationships.

Action

Not applicable.

CMMVC5973E The operation was not performed because the consistency group is not synchronized.

Explanation

The operation was not performed because the consistency group is not synchronized.

Action

Specify the Force option when starting the consistency group.

CMMVC5974E The operation was not performed because the consistency group is offline.

Explanation

The operation was not performed because the consistency group is offline.

Action

Not applicable.

CMMVC5975E The operation was not performed because the cluster partnership is not connected.

Explanation

The operation was not performed because the cluster partnership is not connected.

Action

Not applicable.

CMMVC5976E The operation was not performed because the consistency group is in the freezing state.

Explanation

The operation was not performed because the consistency group is in the freezing state.

Action

Not applicable.

CMMVC5977E The operation was not performed because it is not valid given the current consistency group state.

Explanation

The operation was not performed because it is not valid given the current consistency group state.

Action

Not applicable.

CMMVC5978E The operation was not performed because the relationship is not synchronized.

Explanation

The operation was not performed because the relationship is not synchronized.

Action

Not applicable.

CMMVC5980E The operation was not performed because the master and auxiliary clusters are not connected.

Explanation

The operation was not performed because the master and auxiliary clusters are not connected.

Action

Not applicable.

CMMVC5981E The operation was not performed because the relationship is in the freezing state.

Explanation

The operation was not performed because the relationship is in the freezing state.

Action

Not applicable.

CMMVC5982E The operation was not performed because it is not valid given the current relationship state.

Explanation

The operation was not performed because it is not valid given the current relationship state.

Action

Not applicable.

CMMVC5983E dump file was not created. This may be due to the file system being full.

Explanation

dump file was not created. This may be due to the file system being full.

Action

Not applicable.

CMMVC5984E The dump file was not written to disk. This may be due to the file system being full.

Explanation

The dump file was not written to disk. This may be due to the file system being full.

Action

Not applicable.

CMMVC5985E The action failed because the directory that was specified was not one of the following directories: /dumps, /dumps/iostats, /dumps/iotrace, /dumps/feature, /dumps/configs, /dumps/elogs, or /home/admin/upgrade.

Explanation

The action failed because the directory that was specified was not one of the following directories:

- /dumps
- /dumps/iostats
- /dumps/iotrace
- /dumps/feature
- /dumps/configs
- /dumps/elogs
- /home/admin/upgrade

Action

Specify one of the above directories and reissue the command.

CMMVC5986E The tracing of I/O operations was not started because the virtual disk (VDisk) or managed disk (MDisk) failed to return any statistics.

Explanation

The tracing of I/O operations was not started because the virtual disk (VDisk) or managed disk (MDisk) failed to return statistics.

Action

Not applicable.

CMMVC5987E %1 is not a valid command line option.

Explanation

The specified string that you have entered is not a supported command line option.

Action

Specify a supported option, and resubmit the command.

CMMVC5988E command should not be run by the root userid. Use the admin userid.

Explanation

This command should not be issued if you are logged in with a root user ID. Use the admin userid.

Action

Log off of the root user ID and log in as admin.

CMMVC5989E The operation was not performed because the relationship is offline.

Explanation

The operation was not performed because the relationship is offline.

Action

Not applicable.

CMMVC5990E The FlashCopy consistency group was not stopped as there are no FlashCopy mappings within the group.

Explanation

The FlashCopy consistency group was not stopped as there are no FlashCopy mappings within the group.

Action

Not applicable.

CMMVC5991E The Remote Copy consistency group was not stopped as there are no Remote Copy relationships within the group.

Explanation

The Remote Copy consistency group was not stopped as there are no Remote Copy relationships within the group.

Action

Not applicable.

CMMVC5992E The Remote Copy consistency group was not stopped as there are no Remote Copy relationships within the group.

Explanation

The Remote Copy consistency group was not stopped as there are no Remote Copy relationships within the group.

Action

Not applicable.

CMMVC5993E The specified upgrade package does not exist.

Explanation

The specified upgrade package does not exist.

Action

Not applicable.

CMMVC5994E Error in verifying the signature of the upgrade package.

Explanation

The system could not verify the signature of the upgrade package due to the following reasons:

- There is not enough space on the system to copy the file.

- The package is incomplete or contains errors.

Action

If the copy failed with an error indicating that there was insufficient space on the system, free up additional space on your system. Otherwise, ensure that the cluster time and date stamp on the signature is correct. (For example, the time and date cannot be in the future.)

CMMVC5995E Error in unpacking the upgrade package.

Explanation

The most likely cause of this error is lack of system space.

Action

Reboot the node and unpack the upgrade package again.

CMMVC5996E The specific upgrade package cannot be installed over the current version.

Explanation

The upgrade package is not compatible with the current version or the system.

Action

Check the available upgrade packages and find the correct upgrade package for your current version and for your system. If the upgrade package is correct for your system, check the version requirements for the package. You might have to upgrade the current version to an intermediate version before you upgrade to the latest version. (For example, if your current version is 1 and you are trying to upgrade to version 3, you might need to upgrade to version 2 before applying the version 3 upgrade.)

CMMVC5999W Featurization for this facility has not been enabled.

Explanation

Featurization for this facility has not been enabled.

Action

Not applicable.

CMMVC6000W Featurization for this facility has not been enabled.

Explanation

Featurization for this facility has not been enabled.

Action

Not applicable.

CMMVC6001E The FlashCopy consistency group was not started as there are no FlashCopy mappings within the group.

Explanation

The FlashCopy consistency group was not started as there are no FlashCopy mappings within the group.

Action

Create a FlashCopy within the appropriate group.

CMMVC6002E This command can only be run on a node that is in service mode.

Explanation

This command can only be run on a node that is in service mode.

Action

Not applicable.

CMMVC6003E This command can not be run on a node that is in service mode.

Explanation

This command can not be run on a node that is in service mode.

Action

Not applicable.

CMMVC6004E The delimiter value, %1, is invalid.

Explanation

The delimiter value, %1, is invalid.

Action

Specify a different delimiter.

CMMVC6005E The view request failed as the specified object is not a member of an appropriate group.

Explanation

A view was request on an object that has been incorrectly initialized.

Action

Ensure that the object is correctly initialized before resubmitting the view request.

CMMVC6006E The managed disk (MDisk) was not deleted because the resource was busy.

Explanation

An attempt was made to delete an MDisk from a MDisk group that is being used as a source and destination for migration operations.

Action

Ensure that the MDisk group is not being used for migration operations before reissuing the command.

CMMVC6007E The two passwords that were entered do not match.

Explanation

The two passwords entered for verification of your password change were not the same.

Action

Re-enter the passwords.

CMMVC6008E The key already exists.

Explanation

An attempt was made to load a duplicate SSH key.

Action

Not applicable.

CMMVC6009E Unable to malloc a block of memory in which to copy the returned data.

Explanation

The command line was unable to allocate a block of memory in which to copy the results of the query.

Action

Resubmit the command. If the problem persists, contact IBM technical support for assistance.

CMMVC6010E Unable to complete the command as there are insufficient free extents, or the command requested an expansion of 0 size.

Explanation

There are not enough free extents to meet the request.

Action

Not applicable.

CMMVC6011E This cluster is part of a remote cluster partnership. Because this upgrade package will make changes to the cluster state, it cannot be applied to the current code level until all remote cluster partnerships are deleted.

Explanation

You have attempted to apply software when a Remote Copy relationship to a remote cluster exists.

Action

Delete the Remote Copy relationship to the remote clusters, and resubmit the command.

CMMVC6012W The virtualized storage capacity is approaching the amount that you are licensed to use.

Explanation

The requested action has completed. However, the limits permitted by the license you purchased are approaching.

Action

Subsequent actions might require that you increase your licensed limits.

CMMVC6013E The command failed because there is a consistency group mismatch on the aux cluster.

Explanation

The action has failed as there was a difference in attributes between the Metro Mirror consistency groups involved.

Action

Ensure that the attributes of the two Metro Mirror consistency groups match before resubmitting the command.

CMMVC6014E The command failed because the requested object is either unavailable or does not exist.

Explanation

The command failed because the requested object is either unavailable or does not exist.

Action

Ensure that all parameters have been correctly entered. If this is the case the determine why the object is unavailable, then resubmit the command.

CMMVC6015E A delete request is already in progress for this object.

Explanation

A delete request is already in progress for this object.

Action

Not applicable.

CMMVC6016E The action failed as there would be, or are, no more disks in the MDisk group.

Explanation

The action failed as there would be, or are, no more disks in the I/O group.

Action

Ensure that all parameters have been correctly entered.

CMMVC6017E A parameter or argument contains invalid characters. Ensure that all characters are ASCII.

Explanation

The command-line interface (CLI) will only accept ASCII input.

Action

Ensure that all input to the CLI is ASCII, then resubmit the command.

CMMVC6018E The software upgrade pre-install process failed.

Explanation

The software upgrade failed as there was an error during the preprocessing. The package is either invalid or corrupted.

Action

Ensure the package is a valid upgrade package. Download the package from the source location again as it might have been corrupted during a network transfer.

CMMVC6019E The software upgrade failed as a node pended as the upgrade was in progress.

Explanation

The software upgrade failed as a node pended as the upgrade was in progress.

Action

Ensure that all nodes are online and available before restarting the upgrade process.

CMMVC6020E The software upgrade failed as the system was unable to distribute the software package to all nodes.

Explanation

The software upgrade failed as the system was unable to distribute the software package to all nodes.

Action

Ensure that all nodes are correctly zoned and that all nodes are online and can see the other nodes in the cluster. You might also want to check the error log.

CMMVC6021E The system is currently busy performing another request. Try again later.

Explanation

The requested action failed as the system is processing another request.

Action

Wait before resubmitting the request.

CMMVC6022E The system is currently busy performing another request. Try again later.

Explanation

The requested action failed as the system is processing another request.

Action

Wait before resubmitting the request.

CMMVC6023E The system is currently busy performing another request. Try again later.

Explanation

The requested action failed as the system is processing another request.

Action

Wait before resubmitting the request.

CMMVC6024E The auxiliary VDisk entered is invalid.**Explanation**

The auxiliary VDisk is entered as a parameter in the command-line interface is not a valid auxiliary VDisk.

Action

Select a valid auxiliary VDisk and reissue the command.

CMMVC6025E The RC consistency group Master cluster is not the local cluster.**Explanation**

The auxiliary VDisk is entered as a parameter in the command-line interface is not a valid auxiliary VDisk.

Action

Resubmit the command with a consistency group that belongs to the local cluster.

CMMVC6026E The RC consistency group is not in the stopped state.**Explanation**

The action failed as the Metro Mirror consistency group is not in the stopped state.

Action

Ensure that the Metro Mirror consistency group is in the stopped state before resubmitting the command.

CMMVC6027E The RC consistency group is not the primary master.**Explanation**

The RC consistency group requested in the command is not the Metro Mirror primary master.

Action

Ensure that the parameters have been entered correctly on the command line.

CMMVC6028E This upgrade package cannot be applied to the current software level because it contains changes to the cluster state and there are remote cluster partnership defined.

Explanation

The action failed because there is a connected remote cluster. The upgrade cannot be applied because it would render the remote cluster at a different code level to the remote cluster.

Action

Ensure that the cluster partnership is deconfigured before resubmitting the command. Ensure that you deconfigure the remote cluster and upgrade the code on it before reconfiguring the cluster partnership.

CMMVC6029E All nodes must have identical code level before a concurrent code upgrade can be performed.

Explanation

The concurrent upgrade failed as two or more nodes were at differing code levels. All nodes must be at the same code level before a software upgrade can be performed.

Action

Use the service mode to bring all nodes to the same level before resubmitting the concurrent upgrade.

CMMVC6030E The operation was not preformed because the FlashCopy mapping is part of a consistency group. The action must be performed at the consistency group level.

Explanation

An attempt was made to stop a FlashCopy mapping. This failed as the FlashCopy mapping is part of a consistency group.

Action

Issue the stop command to the FlashCopy consistency group. This will stop all FlashCopies within that group that are in progress.

CMMVC6031E The operation was not performed because the FlashCopy consistency group is empty.

Explanation

An attempt was made to prestart an empty FlashCopy consistency group.

Action

Not applicable.

CMMVC6032E The operation was not performed because one or more of the entered parameters is invalid for this operation.

Explanation

An invalid parameter was entered for the command.

Action

If attempting to change the I/O group to which the VDisk belongs, ensure that the VDisk is not already a part of the group.

CMMVC6033E The action failed due to an internal error.

Explanation

An internal error caused the action to fail.

Action

Not applicable.

CMMVC6034E The action failed because the maximum number of objects has been reached.

Explanation

The action failed because the maximum number of objects has been reached.

Action

Not applicable.

CMMVC6035E The action failed as the object already exists.

Explanation

An operation was requested to create an object that already exists.

Action

Ensure that the name you are attempting to apply to a new object does not exist, or change the name before re-issuing the command.

CMMVC6036E An invalid action was requested.

Explanation

The action failed because it is not a valid action with the command that was issued.

Action

Issue an action that is valid with the command.

CMMVC6037E The action failed as the object is not empty.**Explanation**

The action failed because an object was specified.

Action

Reissue the command without specifying an object.

CMMVC6038E The action failed as the object is empty.**Explanation**

The action failed because an object was not specified.

Action

Specify an object, and reissue the command.

CMMVC6039E The action failed as the object is not a member of a group.**Explanation**

The action failed because the object is not a member of a group.

Action

Specify an object that is part of a group, and reissue the command.

CMMVC6040E The action failed as the object is not a parent.**Explanation**

The action failed because the object is not a parent object.

Action

Specify an object that is a parent, and reissue the command.

CMMVC6041E The action failed as the cluster is full.**Explanation**

The action failed because the cluster is full.

Action

Remove data from the cluster, and reissue the command.

CMMVC6042E The action failed as the object is not a cluster member.

Explanation

The action failed because the object is not a member of the cluster.

Action

Specify an object that is a member of the cluster, and reissue the command.

CMMVC6043E The action failed as the object is a member of a group.

Explanation

The action failed because the object is a member of a group.

Action

Specify an object that is not a member of a group, and reissue the command.

CMMVC6044E The action failed as the object is a parent.

Explanation

The action failed because the object is a parent object.

Action

Specify an object that is not a parent object, and reissue the command.

CMMVC6045E The action failed, as the -force flag was not entered.

Explanation

The action failed because the -force option was not entered.

Action

Specify the -force option in the command.

CMMVC6046E The action failed as too many candidates were selected.

Explanation

The action failed because too many candidates were specified.

Action

Specify fewer candidates in the command.

CMMVC6047E The action failed as too few candidates were selected.**Explanation**

An action was requested with too few candidate objects.

Action

Determine the correct number of candidates required for the specific command and re-issue the command.

CMMVC6048E The action failed as the object is busy.**Explanation**

The action failed because the object is busy.

Action

Not applicable.

CMMVC6049E The action failed as the object is not ready.**Explanation**

The action failed because the object is not ready.

Action

Not applicable.

CMMVC6050E The action failed as the command was busy.**Explanation**

The action failed because the command is busy.

Action

Not applicable.

CMMVC6051E An unsupported action was selected.**Explanation**

The action failed because it is not valid with the command.

Action

Specify an action that is valid with the command.

CMMVC6052E The action failed as the object is a member of a FlashCopy mapping.

Explanation

The object is a member of a FlashCopy mapping, thus it cannot be deleted.

Action

Specify an object that is not a member of a FlashCopy mapping, or remove the object from the FlashCopy mapping.

CMMVC6053E An invalid WWPN was entered.

Explanation

An invalid worldwide port name (WWPN) was specified.

Action

Specify a valid WWPN.

CMMVC6054E The action failed as not all nodes are online.

Explanation

One or more nodes are not online.

Action

Check that each node is online, and reissue the command.

CMMVC6055E The action failed as an upgrade is in progress.

Explanation

The action failed because a software upgrade is in progress.

Action

Wait for the software upgrade to complete, and then reissue the command.

CMMVC6056E The action failed as the object is too small.

Explanation

The action failed because the object is too small.

Action

Specify a different object, and reissue the command.

CMMVC6057E The action failed as the object is the target of a FlashCopy mapping.

Explanation

The object is the target of a FlashCopy mapping, thus it cannot be deleted.

Action

Specify an object that is not the target of a FlashCopy mapping, or remove the object from the FlashCopy mapping.

CMMVC6058E The action failed as the object is in the recovery HWS.

Explanation

An attempt was made to perform an operation on a node that is in the recovery IO group.

Action

Get the node into one of the other IO Groups and re-issue the command.

CMMVC6059E The action failed as the object is in an invalid mode.

Explanation

The action failed because the object is in the wrong mode.

Action

Check that the object is in the correct mode, and reissue the command.

CMMVC6060E The action failed as the object is being deleted.

Explanation

The action failed because the object is being deleted.

Action

Not applicable.

CMMVC6061E The action failed as the object is being resized.

Explanation

The action failed because the object is being resized.

Action

Check that the object is in the correct mode, and reissue the command.

CMMVC6062E The action failed as the object is being moved between HWS.

Explanation

An attempt was made to perform an action against an object that is currently being moved between IO groups.

Action

Re-issue the command when the move operation has completed.

CMMVC6063E The action failed as there are no more disks in the group.

Explanation

An attempt was made to perform an action against a group that contained no disks.

Action

Either add disks to the group and re-issue the command, or select another group against which to execute the action.

CMMVC6064E The action failed as the object has an invalid name.

Explanation

An attempt was made to create or rename an object using an invalid name.

Action

Use a name that meets the naming standards and re-issue the command.

CMMVC6065E The action failed as the object is not in a group.

Explanation

An attempt was made to perform an action on an object that was not in an appropriate group.

Action

Ensure that the object is a member of an appropriate group and re-issue the command.

CMMVC6066E The action failed as the system is running low on memory.

Explanation

The system is running low on memory.

Action

Not applicable.

CMMVC6067E The action failed as the SSH key was not found.

Explanation

An attempt was made to perform an action using an SSH key that does not exist.

Action

Re-issue the command using a key that does exist.

CMMVC6068E The action failed as there are no free SSH keys.

Explanation

An attempt was made to use an SSH key when there are no free SSH keys.

Action

Upload additional keys and re-issue the command.

CMMVC6069E The action failed as the SSH key is already registered.

Explanation

An attempt was made to register an SSH key that was already registered.

Action

Not applicable.

CMMVC6070E An invalid or duplicated parameter, unaccompanied argument, or incorrect argument sequence has been detected. Ensure that the input is as per the help.

Explanation

The parameters entered for a command were invalid.

Action

Correct the parameters and re-issue the command.

CMMVC6071E The virtual disk (VDisk)-to-host mapping was not created because the VDisk is already mapped to a host.

Explanation

The virtual disk is already mapped to a host.

Action

Not applicable.

CMMVC6073E The maximum number of files has been exceeded.**Explanation**

The maximum number of files has been exceeded.

Action

Not applicable.

CMMVC6074E The command failed as the extent has already been assigned.**Explanation**

The command failed as the extent has already been assigned.

Action

Assign a different extent and reissue the command.

CMMVC6075E The expand failed as the last extent is not a complete extent.**Explanation**

The expand failed as the last extent is not a complete extent.

Action

Assign a different extent and reissue the command.

CMMVC6076E The command failed because the virtual disk cache is not empty. Either wait for the cache to flush or use the force flag to discard the contents of the cache.**Explanation**

The command failed due to an error during the flushing of the VDisk.

Action

Not applicable.

CMMVC6077E WARNING - Unfixed errors should be fixed before applying software upgrade. Depending on the nature of the errors, they might cause the upgrade process to fail. It is highly recommended to fix these errors before proceeding. If a particular error cannot be fixed, contact the support center.

Explanation

Unfixed errors should be fixed before applying software upgrade. Depending on the nature of the errors, they might cause the upgrade process to fail. It is highly recommended to fix these errors before proceeding.

Action

If the error cannot be fixed, contact the support center.

CMMVC6078E The action failed because the object is in an invalid mode.

Explanation

An attempt was made to perform an action against an object in a mode that did not allow for that action to be performed.

Action

Get the object into a suitable mode and re-issue the command.

CMMVC6079E Metadata recovery could not complete the operation because a parameter is invalid.

Explanation

Metadata recovery could not complete the operation because a parameter is invalid.

CMMVC6081E Metadata Recovery is busy processing the previous operation.

Explanation

Metadata Recovery is busy processing the previous operation.

CMMVC6082E The attempt to abort metadata recovery failed because the previous operation has completed.

Explanation

The attempt to abort metadata recovery failed because the previous operation has completed.

Action

None.

CMMVC6083E Metadata recovery could not find a valid dumpfile required for the rebuild operation.

Explanation

Metadata recovery could not find a valid dumpfile required for the rebuild operation.

CMMVC6084E Metadata recovery could not create/open/write the scan file, the disk might be full.

Explanation

Metadata recovery could not create/open/write the scan file, the disk might be full.

CMMVC6085E Metadata recovery could not create/open/write the dump file, the disk might be full.

Explanation

Metadata recovery could not create/open/write the dump file, the disk might be full.

CMMVC6086E Metadata recovery could not create/open/write the progress file, the disk might be full.

Explanation

Metadata recovery could not create/open/write the progress file, the disk might be full.

CMMVC6087E Metadata recovery could not map the buffers necessary to complete the operation.

Explanation

Metadata recovery could not map the buffers necessary to complete the operation.

CMMVC6088E The lba at which metadata recovery was requested does not contain metadata.

Explanation

The lba at which metadata recovery was requested does not contain metadata.

CMMVC6089E The metadata at the requested lba is flagged as invalid.

Explanation

The metadata at the requested lba is flagged as invalid.

CMMVC6090E The metadata header checksum verification failed.

Explanation

The metadata header checksum verification failed.

CMMVC6091E The metadata region checksum verification failed.

Explanation

The metadata region checksum verification failed.

CMMVC6092E The metadata recovery operation was aborted.

Explanation

The metadata recovery operation was aborted.

CMMVC6093E Metadata recovery internal error - (read only)

Explanation

Metadata recovery internal error - (read only)

CMMVC6095E Metadata recovery encountered the end of the disk.

Explanation

Metadata recovery encountered the end of the disk.

CMMVC6096E Metadata recovery encountered an error from a lower layer - (v1 no resource).

Explanation

Metadata recovery encountered an error from a lower layer - (v1 no resource).

CMMVC6097E Metadata recovery encountered an error from a lower layer - (v1 failure).

Explanation

Metadata recovery encountered an error from a lower layer - (v1 failure).

CMMVC6098E The copy failed as the specified node is the configuration node.

Explanation

The copy failed because the specified node is the configuration node.

Action

Not applicable.

CMMVC6100E -option not consistent with action

Explanation

The specified option is not supported for this action.

Action

Remove the option and reissue the command.

CMMVC6101E -option not consistent with -option

Explanation

The two specified options cannot be used together.

Action

Remove one of the options and reissue the command.

CMMVC6102E -option and -option are alternatives

Explanation

The two specified options are alternatives and cannot be used together.

Action

Remove one of the options and reissue the command.

CMMVC6103E Problem with file-name: details

Explanation

A problem occurred when opening a file. Determine the cause of the problem and correct it before trying again.

Action

Correct the problem and then reissue the command.

CMMVC6104E Action name not run**Explanation**

An unexpected error occurred.

Action

Contact the support center.

CMMVC6105E Different names for source (name) and target (name) clusters**Explanation**

The backup configuration cannot be restored to the target cluster because the source and target cluster have different names.

Action

Perform one of the following actions: (1) Use a different backup configuration. (2) Delete the cluster and recreate it with the same name as that stored in the backup configuration file.

CMMVC6106W Target cluster has non-default id_alias alias**Explanation**

The id_alias of the target cluster has a non-default target. Clusters should have a default value. The non-default value suggests the cluster is customized and is not suitable for restoration. Restoration changes the id_alias.

Action

Change the id_alias to a default value and reissue the command.

CMMVC6107E x io_grp objects in target cluster; y are required**Explanation**

The number of I/O groups in the target cluster is not sufficient to accommodate the I/O groups defined in the backup configuration file. Determine why there are not enough I/O groups.

Action

Correct the problem and reissue the command.

CMMVC6108I Disk controller system with a WWNN of wwnn found.**Explanation**

A disk controller system has been found with the required WWNN.

Action

Not applicable.

CMMVC6109E Disk controller system with a WWNN of wwnn not available.**Explanation**

A disk controller system has been found with the required WWNN. Ensure that the required disk controller system is available to the cluster.

Action

Ensure that the required disk controller system is available to the cluster and reissue the command.

CMMVC6110E Bad code level**Explanation**

An unexpected error occurred.

Action

Report the details to the support center.

CMMVC6111E Cluster code_level could not be determined from level**Explanation**

The code level of the cluster could not be determined. The code level should be of the form, x.y.z, where x, y, and z are integers.

Action

If the cause of the problem cannot be determined, contact the support center.

CMMVC6112W object-type object-name has a default name**Explanation**

An object in the cluster has a default name. This can cause problems when restoring a cluster as default names are changed during restoration. Object IDs are also changed during restoration.

Action

Choose an appropriate name for each object in the cluster and reissue the command.

CMMVC6113E Command failed with return code: details**Explanation**

An attempt to run a command remotely failed using secure communications.

Action

Determine the cause of the problem and reissue the command.

CMMVC6114E No help for action action.**Explanation**

There is no help for the requested topic.

Action

Not applicable.

CMMVC6115W Feature property mismatch: value1 expected; value2 found**Explanation**

The features in the backup configuration file and the target cluster do not match. There should be an exact match between the two. Nevertheless, the restore of the configuration can continue.

Action

Not applicable.

CMMVC6116I Feature match or property**Explanation**

The features in the backup configuration file and the target cluster are an exact match.

Action

Not applicable.

CMMVC6117E fix-or-feature is not available**Explanation**

An unexpected error occurred.

Action

Contact the support center.

CMMVC6118I type with property value [and property value] found**Explanation**

An object in the cluster has been found with the correct properties.

Action

Not applicable.

CMMVC6119E type with property value [and property value] not found**Explanation**

An object in the cluster with the correct properties has not been found. Restoration cannot proceed without the object.

Action

Determine why the object cannot be found. Ensure that the object is available and reissue the command.

CMMVC6120E Target is not the configuration node**Explanation**

The target is not the configuration node.

Action

Redirect the action against the configuration node and reissue the command.

CMMVC6121E No cluster id or id_alias in backup configuration**Explanation**

Neither the cluster id_alias or ID can be extracted from the backup configuration file.

Action

If the cause of the problem cannot be determined, contact the support center.

CMMVC6122E No type with property value present in table**Explanation**

An unexpected error occurred.

Action

Contact the support center.

CMMVC6123E No property for type name**Explanation**

An unexpected error occurred.

Action

Contact the support center.

CMMVC6124E No type with property value**Explanation**

An unexpected error occurred.

Action

Contact the support center.

CMMVC6125E No unique ID for type name**Explanation**

An unexpected error occurred.

Action

Contact the support center.

CMMVC6126E No type with unique ID value**Explanation**

An unexpected error occurred.

Action

Contact the support center.

CMMVC6127I SSH key identifier for user already defined; will not be restored**Explanation**

An identical SSH key for this user is already defined on the cluster. Therefore, the key in the backup file will not be restored.

Action

Specify a different SSH key and reissue the command.

CMMVC6128W details

Explanation

The files in the directory could not be listed.

Action

Determine why they could not be listed and correct the problem and reissue the command.

CMMVC6129E vdisk-to-host map objects have vdisk_UID values that are not consistent

Explanation

All of the VDisk-to-host map objects do not have the same number for the VDisk LUN instance. Therefore, there is a possibility the backup configuration file is corrupt. The LUN instance number should be the same for all VDisk-to-host map objects that are associated with a specific VDisk. The LUN instance number is incorporated into the VDisk_UID property.

Action

Determine why the LUN instance number is not the same and correct the problem and reissue the command.

CMMVC6130W Inter-cluster property will not be restored

Explanation

The restoration of inter-cluster objects is not supported.

Action

Not applicable.

CMMVC6131E No location cluster information

Explanation

An unexpected error occurred.

Action

Contact the support center.

CMMVC6132E An object of a given type has a property with an incorrect value. The operation cannot proceed until the property has the correct value. Take administrative action to change the value and try again.

Explanation

An object has a property with an incorrect value. The property most likely reflects the state of the object.

Action

Change the state to the required value and reissue the command.

CMMVC6133E Required type property property not found

Explanation

An unexpected error occurred.

Action

Contact the support center.

CMMVC6134E No argument for -option

Explanation

No argument has been supplied for an option that requires an argument.

Action

Supply an argument and reissue the command.

CMMVC6135E Argument value for -option is not valid

Explanation

An argument has been supplied for an option that is not valid.

Action

Supply an valid argument and try again.

CMMVC6136W No SSH key file file-name

Explanation

A file that contains an SSH key is not present and will not be restored. The backup operation will continue.

Action

No action is required. You might have to manually restore the key.

CMMVC6137W No SSH key file file-name; key not restored**Explanation**

An SSH key cannot be restored because the file containing it is not present. The restore operation will continue.

Action

After the restore is complete, locate the file containing the key, and perform one of the following actions: (1) Rename the file so that it has the correct name and reissue the command. (2) Restore the key manually using the `svctask addsshkey` command.

CMMVC6138E -option is required**Explanation**

An option is missing. The option might be listed as optional, but circumstances make the option mandatory.

Action

Supply the option and reissue the command.

CMMVC6139E Incorrect XML tag nesting in filename**Explanation**

There is a problem with the content of a configuration file. There is a problem parsing the XML in the file, because the XML records are not consistent. The file might be corrupt or has been truncated.

Action

Replace this copy with a good copy and try again. If the problem persists, Contact the support center.

CMMVC6140E No default name for type type**Explanation**

An unexpected error occurred.

Action

Contact the support center.

CMMVC6141E -option does not contain any argument**Explanation**

An argument has been supplied for an option that does not contain any.

Action

Remove the argument and reissue the command.

CMMVC6142E Existing object-type object-name has a non-default name**Explanation**

An object in the target default cluster has a non-default name. This suggests that the cluster was customized. The cluster is therefore not suitable for restoration.

Action

Reset the cluster as per the instructions for restoring the cluster configuration, and try again.

CMMVC6143E Required configuration file file-name does not exist**Explanation**

A file is missing that is critical for successful operation.

Action

Not applicable.

CMMVC6144W Object with default name name restored as substitute-name**Explanation**

An object with a default name has been restored with a different name. Ensure that you account for this name change when using the restored cluster in the future. To avoid this problem in the future, choose an appropriate name for each object in the cluster.

Action

Choose an appropriate name for each object in the cluster.

CMMVC6145I Use the restore -prepare command first**Explanation**

This advisory is given prior to CMMVC6103E when an intermediate file is missing, presumed not created.

Action

Not applicable.

CMMVC6146E Problem parsing object-type data: line**Explanation**

An unexpected error occurred.

Action

Contact the support center.

CMMVC6147E type name has a name beginning with prefix**Explanation**

An object has been encountered that has a name beginning with a reserved prefix. The only valid reason for an object with this kind of name is: a restoration command did not complete successfully.

Action

Ensure that no objects use the reserved prefix in their name, and reissue the command.

CMMVC6148E Target cluster has n-actual objects of type type instead of n-required**Explanation**

The target cluster does not have the required number of certain types of objects.

Action

Correct the problem and reissue the command.

CMMVC6149E An action is required**Explanation**

An action is required to run the command.

Action

Supply an action, and reissue the command.

CMMVC6150E The action, action, is not valid**Explanation**

An action has been supplied that is not valid.

Action

Supply a valid action, and reissue the command.

CMMVC6151E The -option option is not valid**Explanation**

An option has been supplied that is not valid.

Action

Supply a valid action, and reissue the command.

CMMVC6152E vdisk name instance number instance is not valid**Explanation**

The VDisk could not be restored because the instance number (in hex) is not valid.

Action

Contact the support center.

CMMVC6153E object not consistent with action**Explanation**

The specified object is not supported for the action.

Action

Remove the object and reissue the command.

CMMVC6154E Required object-type property property-name has a null value**Explanation**

An unexpected error occurred.

Action

Contact the support center.

CMMVC6155I SVCCONFIG processing completed successfully**Explanation**

Only information and warning messages are issued.

Action

Not applicable.

CMMVC6156W SVCCONFIG processing completed with errors**Explanation**

Processing was not successful.

Action

Not applicable.

CMMVC6164E The SVCCONFIG CRON job, which runs overnight on a daily overnight, has failed.**Explanation**

The SVCCONFIG CRON job, which runs overnight on a daily overnight, has failed.

Action

Resolve any hardware and configuration problems that you are experiencing on the 2145 cluster. If the problem reoccurs contact the software support center for assistance.

CMMVC6165E Target is not the original configuration node with WWNN of value.**Explanation**

A backup configuration can only be restored to the original configuration node.

Action

Recreate the default cluster with the correct configuration node, and reissue the command.

CMMVC6166E A property of an object has changed during svconfig restore -execute.**Explanation**

The integrity of the restoration cannot be guaranteed.

Action

Reissue the command from svconfig restore -prepare.

CMMVC6181E The target cluster contains an object that has a counterpart in the configuration to be restored, and has the correct ID.

Explanation

The indicated property has an unexpected value.

Action

Check that the correct (matching) backup configuration file (svc.config.backup.xml) is being provided and if it is, use the -force option to ignore the discrepancy. Otherwise, provide the correct file and try again.

CMMVC6182W An object that does not contribute to the fabric of the configuration cannot be restored because its configuration does not permit it to be created.

Explanation

An object that does not contribute to the fabric of the configuration cannot be restored because its configuration does not permit it to be created. For example, a host can only be created if it has at least one port.

Action

N/A

CMMVC6186W An IO group was restored with a different ID value.

Explanation

This can occur when the configuration node is different to the one used to create the original cluster. This affects the SCSI Inquiry value for the IO group.

Action

N/A

CMMVC6200E The action failed because of incompatible software.

Explanation

The software version on one or more nodes is incompatible with the new version.

Action

Refer to the compatibility requirements for the software version you are adding. Update the cluster to meet the compatibility requirements, and then perform the upgrade.

CMMVC6201E The node could not be added, because of incompatible software: status code *STATUS_CODE*.

Explanation

The node could not be added, because of incompatible software.

Action

Upgrade the software on the node that has been rejected to the same level of software as the cluster to which it will be added, and resubmit the command.

CMMVC6202E The cluster was not modified because the IP address is not valid.

Explanation

An attempt was made to change the IP address of a cluster to an invalid address.

Action

Correct the address and re-issue the command.

CMMVC6203E The action failed because the directory that was specified was not one of the following directories: /dumps, /dumps/iostats, /dumps/iotrace, /dumps/feature, /dumps/config, /dumps/elogs, /dumps/ec or /dumps/pl.

Explanation

An attempt was made to clear a file from, or copy a file to, an invalid directory.

Action

Ensure that the command accesses a valid directory.

CMMVC6204E The action failed as the resulting disk size would be less than, or equal to, zero.

Explanation

An attempt was made to shrink a disk, however the resulting size would have been less than or equal to zero.

Action

Not applicable

CMMVC6205E Metadata recovery can not use the provided mdisk id - invalid or destroyed.

Explanation

Metadata recovery can not use the provided mdisk id - invalid or destroyed.

CMMVC6206E The software upgrade failed as a file containing the software for the specified MCP version was not found.

Explanation

There are two files required to successfully complete a software upgrade. One file contains the files that make up the base operating system, and the other file contains the 2145 software. This message appears if the OS version is incompatible with the 2145 software.

Action

Upload two compatible files and reissue the command.

CMMVC6207E The action failed because the virtual disk (VDisk) is part of a Remote Copy mapping.

Explanation

An action was performed against a VDisk that is part of a Remote Copy mapping.

Action

Remove the VDisk from the Remote Copy mapping before resubmitting the command.

CMMVC6208E The action failed because the virtual disk (VDisk) is part of a FlashCopy mapping.

Explanation

An action was performed against a VDisk that is part of a FlashCopy mapping.

Action

Remove the VDisk from the FlashCopy mapping before re-issuing the command.

CMMVC6209E The FlashCopy mapping or consistency group could not be started in a reasonable time. The mapping or group is instead being prepared.

Explanation

The FlashCopy mapping or consistency group could not be started in a reasonable time. The mapping or group is instead being prepared.

Action

Resubmit the command.

CMMVC6210E The command failed as a result of a migrated disk IO medium error.

Explanation

The command failed as a result of a migrated disk IO medium error.

CMMVC6211E The command failed as a migrate to image was in progress.

Explanation

An attempt was made to execute a command against a VDisk that was involved in a migrate to image operation.

Action

Wait for the migration to complete and re-issue the command.

CMMVC6212E The command failed because data in the cache has not been committed to disk.

Explanation

The command failed because data in the cache has not been committed to disk.

CMMVC6213E You are trying to recover region data that was created by a code level different from the one you are currently running on the node.

Explanation

You are trying to recover region data that was created by a code level different from the one you are currently running on the node.

CMMVC6214E Failed to recreate the cluster you are trying to rebuild.

Explanation

Failed to recreate the cluster you are trying to rebuild.

CMMVC6215E The FlashCopy mapping was not created or modified because the consistency group already contains the maximum number of mappings.

Explanation

An attempt was made to create a FlashCopy mapping in, or move a FlashCopy mapping to, a consistency group that has the maximum number of FlashCopy mappings that it can contain.

Action

Create or move the FlashCopy mapping in another consistency group or remove an existing FlashCopy mapping from the desired group and then re-issue the command.

CMMVC6216E The Remote Copy relationship was not created because the master or auxiliary virtual disk (VDisk) is a member of a Remote Copy mapping.

Explanation

The Remote Copy relationship was not created because the master or auxiliary virtual disk (VDisk) is a member of a Remote Copy mapping.

Action

Select a different VDisk to make up the mapping.

CMMVC6217E The maximum number of hosts for the cluster is already configured.

Explanation

You must remove at least one host definition before you can resubmit the command.

Action

Determine whether the action is required.

If the action is required, review the current configuration to determine whether any current host definitions are not required. Remove at least one host definition that is not required, and resubmit the command.

CMMVC6218E The maximum number of host/IO group pairs for the cluster is already configured.

Explanation

You must remove at least one host/IO group pair definition before you can resubmit the command.

Action

Determine whether the action is required.

If the action is required, review the current configuration to determine whether any current host/IO group pair definitions are not required. Remove at least one host/IO group pair definition that is not required, and resubmit the command.

CMMVC6219E The maximum number of WPNs for the cluster is already configured.

Explanation

You must remove at least one WWPN definition before you can resubmit the command.

Action

Determine whether the action is required.

If the action is required, review the current configuration to determine whether any current WWPN definitions are not required. Remove at least one WWPN definition that is not required, and resubmit the command.

CMMVC6220E The maximum number of hosts for one or more IO groups is already configured.

Explanation

You must remove at least one host/IO group pair definition from the I/O group that you have specified before you can resubmit the command.

Action

Determine whether the action is required.

If the action is required, review the current configuration to determine whether any current host/IO group pair definitions for the I/O group that you have specified are not required. Remove at least one host/IO group pair definition that is not required from the I/O group that you have specified, and resubmit the command.

CMMVC6221E The maximum number of WPNs for one or more IO groups is already configured.

Explanation

You must remove at least one WWPN definition from the I/O group that you have specified before you can resubmit the command.

Action

Determine whether the action is required.

If the action is required, review the current configuration to determine whether any current WWPN definitions for the I/O group that you have specified are not required. Remove at least one WWPN definition that is not required from the I/O group that you have specified, and resubmit the command.

CMMVC6222E The maximum number of WWPNs for the host is already configured.

Explanation

You must remove at least one WWPN definition for the host that you have specified before you can resubmit the command.

Action

Determine whether the action is required.

If the action is required, review the current configuration to determine whether any current WWPN definitions for the host that you have specified are not required. Remove at least one WWPN definition that is not required for the host that you have specified, and resubmit the command.

CMMVC6223E The host does not belong to one or more of the IO groups specified or inferred.

Explanation

The host does not belong to one or more of the IO groups specified or inferred.

Action

Specify a host/IO group combination that is currently defined, and resubmit the command.

CMMVC6224E The host already belongs to one or more of the IO groups specified.

Explanation

The host already belongs to one or more of the IO groups specified.

Action

None.

CMMVC6225E An IO group cannot be removed from a host because of one or more associated vdisks.

Explanation

An IO group cannot be removed from a host because of one or more associated vdisks.

CMMVC6226E The action was not completed because the cluster has reached the maximum number of extents in MDisk Groups.

Explanation

The cluster has reached the maximum number of extents in the MDisk Group, therefore, the action did not complete.

Action

Select a different cluster and reissue the command.

CMMVC6227I The package installed successfully.

Explanation

The package installed successfully.

Action

None.

CMMVC6228E The cluster was recovered and the CLI functionality is limited until the cause of the failure is determined and any corrective action taken. Contact IBM technical support for assistance.

Explanation

The cluster was recovered and the CLI functionality is limited.

Action

Contact IBM technical support for assistance.

CMMVC6229E The action failed as the SSH key has been revoked.

Explanation

The action failed as the SSH key has been revoked.

CMMVC6230E The action failed as the SSH key index (SSH_LABEL_ID) is invalid.

Explanation

The action failed as the SSH key index (SSH_LABEL_ID) is invalid.

CMMVC6231E The action failed as the audit table is full.

Explanation

The action failed as the audit table is full.

Action

Save the audit log to disk, and resubmit the command.

CMMVC6232E This operation cannot be performed because the cluster is currently aborting the previous software upgrade command.

Explanation

This operation cannot be performed because the cluster is currently aborting the previous software upgrade command.

Action

Wait until the previous software upgrade command has aborted successfully, and resubmit the command.

CMMVC6233E This operation cannot be performed because, either a software upgrade has not been started, or a software upgrade is in progress but is not in a state where it can be aborted.

Explanation

This operation cannot be performed because the software upgrade is making progress.

CMMVC6234E The upgrade cannot be aborted because at least one node has already committed to a new code level.

Explanation

The upgrade cannot be aborted because at least one node has already committed to a new code level.

CMMVC6235E An invalid response has been entered. The command has not been executed. Input is case sensitive. Enter either yes or no.

Explanation

An invalid response has been entered. The command has not been executed. Enter either yes or no.

Action

Enter either yes or no.

CMMVC6236E The command has not completed. A limited availability parameter has been entered without the required environment setting being set.

Explanation

The command has not completed. A limited availability parameter has been entered without the required environment setting being set.

CMMVC6237E The command failed as the remote cluster does not support global mirror.

Explanation

The command failed as the remote cluster does not support global mirror.

CMMVC6238E The copy type differs from other copies already in the consistency group.

Explanation

The copy type differs from other copies already in the consistency group.

Action

Ensure that the copy type of the mapping that you are attempting to add is the same copy type as the mappings in the consistency group to which you are attempting to add the mapping, and resubmit the command.

CMMVC6239E The FlashCopy mapping was not prepared because the mapping or consistency group is in the stopping state.

Explanation

You cannot prepare a FlashCopy mapping or consistency group when the FlashCopy mapping or consistency group is in the stopping state. If you want to prepare a FlashCopy mapping or consistency group, the FlashCopy mapping or consistency group must be in the Stopped or idle_or_copied state.

Action

Wait until the FlashCopy mapping or consistency group reaches the Stopped or idle_or_copied state and then resubmit the command.

CMMVC6240E The properties of the FlashCopy mapping were not modified because the mapping or consistency group is in the stopping state.

Explanation

You cannot modify the consistency group of a FlashCopy mapping when the FlashCopy mapping is in the stopping state. If you want to modify the consistency

group of a FlashCopy mapping, the FlashCopy mapping must be in the Stopped or idle_or_copied state.

Action

Wait until the FlashCopy mapping reaches the Stopped or idle_or_copied state and then resubmit the command.

CMMVC6241E The FlashCopy mapping was not deleted because the mapping or consistency group is in the stopping state. The mapping or consistency group must be stopped first.

Explanation

You cannot delete a FlashCopy mapping or consistency group when the FlashCopy mapping or consistency group is in the stopping state. If you want to delete a FlashCopy mapping or consistency group, the FlashCopy mapping or consistency group must be in the Stopped or idle_or_copied state.

Action

Wait until the FlashCopy mapping or consistency group reaches the Stopped or idle_or_copied state and then resubmit the command.

CMMVC6242E The FlashCopy mapping or consistency group was not started because the mapping or consistency group is in the stopping state.

Explanation

You cannot start a FlashCopy mapping or consistency group when the FlashCopy mapping or consistency group is in the stopping state. If you want to start a FlashCopy mapping or consistency group, the FlashCopy mapping or consistency group must be in the Prepared state.

Action

Wait until the FlashCopy mapping or consistency group reaches the Stopped or idle_or_copied state and then prepare the FlashCopy mapping or consistency group before starting it.

CMMVC6243E The FlashCopy mapping or consistency group was not stopped because the mapping or consistency group is already in the stopping state.

Explanation

A Stop FlashCopy mapping or consistency group task has already been submitted and is still in progress. When the task has completed successfully, the FlashCopy mapping or consistency group state will change to Stopped.

Action

None.

CMMVC6244E The FlashCopy mapping was not created because the source virtual disk (VDisk) cannot be the target for a FlashCopy mapping.

Explanation

A VDisk cannot simultaneously be both the source of a FlashCopy mapping and the target of a FlashCopy mapping. The source VDisk that you have specified is currently defined as the target of a FlashCopy mapping.

Action

You have two options. One option is specify a different source VDisk and resubmit the command. The other option is delete the existing FlashCopy mapping that defines the source VDisk that you have specified as the target VDisk, and resubmit the command.

CMMVC6245E The FlashCopy mapping was not created because the source virtual disk (VDisk) is already in the maximum number of FlashCopy mappings.

Explanation

The number of FlashCopy mappings in which a Vdisk can be defined as the source Vdisk is limited. The source Vdisk that you have specified cannot be defined to another FlashCopy mapping because it is already defined as the source Vdisk to the maximum number of FlashCopy mappings.

Action

You have two options. One option is specify a different source VDisk and resubmit the command. The other option is delete one of the existing FlashCopy mappings that contains the source VDisk and resubmit the command.

CMMVC6246E The FlashCopy mapping was not created because the target virtual disk (VDisk) is already a source vdisk in a FlashCopy mapping.

Explanation

A VDisk cannot simultaneously be both the source of a FlashCopy mapping and the target of a FlashCopy mapping. The target VDisk that you have specified is currently defined as the source of a FlashCopy mapping.

Action

You have two options. One option is specify a different target VDisk and resubmit the command. The other option is delete all of the existing FlashCopy mappings that contain the target VDisk that you have specified and resubmit the command.

CMMVC6247E The FlashCopy mapping was not created because the target virtual disk (VDisk) is already a target vdisk in a FlashCopy mapping.

Explanation

A VDisk cannot simultaneously be the target of more than one FlashCopy mapping. The target VDisk that you have specified is currently defined as the target of another FlashCopy mapping.

Action

You have two options. One option is specify a different target VDisk and resubmit the command. The other option is delete the existing FlashCopy mapping that contains the target VDisk that you have specified and resubmit the command.

CMMVC6248E The command failed because the authorization table is full.

Explanation

The command failed because the authorization table is full.

CMMVC6249E The command failed because the authorization record was not found or is already set to the default role.

Explanation

The command failed because the authorization record was not found or is already set to the default role.

CMMVC6250E The command failed because the authorization record is not set to the default role. Use rmauth to set the default role.

Explanation

The command failed because the authorization record is not set to the default role.

Action

Use rmauth to set the default role.

CMMVC6251E The command failed because the specified role was not found.

Explanation

The command failed because the specified role was not found.

CMMVC6252E The command failed authorization because the session ssh key is invalid or was deleted.

Explanation

The command failed authorization because the session ssh key is invalid or was deleted.

CMMVC6253E The command failed authorization because the session ssh key does not have the requisite role.

Explanation

The command failed authorization because the session ssh key does not have the requisite role.

CMMVC6254E The command failed because the specified ssh key was not found. NOTE This command must specify an admin key.

Explanation

The command failed because the specified ssh key was not found. NOTE This command must specify an admin key.

CMMVC6255E The command can not set the authorization record to the default role. Use rmauth to set the default role.

Explanation

The command can not set the authorization record to the default role.

Action

Use rmauth to set the default role.

CMMVC6263E The command failed because the ssh key already exists or there is a duplicate ssh key.

Explanation

You have attempted to add an ssh key that already exists, and may have a different authorization level associated with it.

Action

Add a different ssh key if the existing ssh key of the same type does not have the authority level that you require.

CMMVC6296E One or more managed disks (MDisks) have failed validation tests, first failing mdisk id [%1].

Explanation

When you add a managed MDisk to an MDisk group, the new MDisk is validated to ensure that adding it to the MDisk group will not adversely impact the MDisk group status. Either the current status of the MDisk has not allowed the validation to be performed, or the validation has failed. Note: You cannot add Read Only or faulty MDisks to an MDisk group.

Action

- If the MDisk identity has changed since it was last discovered, submit the command-line interface command `svctask detectmdisk`, which might correct the problem.
- Check switch zoning and logical unit presentation on the controller to ensure that the MDisk is physically and logically connected to all of the nodes in this cluster.
- Ensure that the controller settings are correct and that the MDisk logical unit is correctly configured.
- Ensure that the MDisk logical unit state is one that passes the validation. A Read Only or faulty MDisk fails the validation.
- View the cluster error log for more information about the failed validation.

CMMVC6297E One or more managed disks (MDisks) have timed out during validation tests, first failing mdisk id [%1].

Explanation

When you add a managed MDisk to an MDisk group, the new MDisk is validated to ensure that adding it to the MDisk group will not adversely impact the MDisk group status. The current status of the MDisk permits the validation to be initiated, but the allotted time for the validation process elapsed before the validation process had completed. Note: You cannot add Read Only or faulty MDisks to an MDisk group.

Action

- Ensure that the controller settings are correct and that the MDisk logical unit is correctly configured.
- Ensure that the MDisk logical unit state is one that passes the validation. A Read Only or faulty MDisk fails the validation.
- Check the fibre-channel fabric and storage controller for faults that might reduce the reliability of cluster communication with the MDisk.
- View the cluster error log for more information about the failed validation.

CMMVC6298E The command failed because a target VDisk has dependent FlashCopy mappings.

Explanation

The target VDisk of the FlashCopy mapping, or the target VDisk of at least one of the FlashCopy mappings in the consistency group, has other FlashCopy mappings

that are dependent on the data on the target VDisk.

Action

Use the `lsvdiskdependentmaps` command and specify the target VDisk to determine which FlashCopy mappings are dependent on the target VDisk. Either wait for these mappings to reach the `idle_or_copied` state, or stop these mappings. Resubmit the command that produced this error.

CMMVC6299E The create failed because the source and target VDisks are members of FlashCopy mappings that have different grain sizes.

Explanation

All FlashCopy mappings that are in a tree of connected mappings must have the same grain size. The new FlashCopy mapping that you attempted to create would have linked two existing trees that have different grain sizes.

Action

You have three options. The first option is to resubmit the command and specify a different source or target VDisk. The second option is to delete all of the existing mappings that contain the source VDisk and resubmit the command. The third option is to delete all of the existing mappings that contain the target VDisk and resubmit the command.

CMMVC6300E The create failed because the source and target VDisks are members of FlashCopy mappings that belong to different I/O groups.

Explanation

All FlashCopy mappings in a tree of connected mappings must be in the same I/O group. The new FlashCopy mapping that you attempted to create would have linked two existing trees that are in different I/O groups.

Action

You have three options. The first option is to resubmit the command and specify a different source or target VDisk. The second option is to delete all of the existing mappings that contain the source VDisk and resubmit the command. The third option is to delete all of the existing mappings that contain the target VDisk and resubmit the command.

CMMVC6301E The create failed because the specified consistency group does not exist.

Explanation

The FlashCopy mapping was not created because the consistency group that you specified does not exist. You must create a consistency group before you can place a mapping in that group.

Action

Either create the FlashCopy consistency group that you specified and resubmit the command, or resubmit the command and specify an existing consistency group.

CMMVC6302E The create failed because the resulting tree of FlashCopy mappings would exceed the upper limit.

Explanation

Either the source VDisk or the target VDisk, or both, are already members of other FlashCopy mappings. The FlashCopy mapping was not created because the new FlashCopy mapping that you attempted to create would have linked two existing mapping trees into a single tree that exceeds the maximum number of mappings that are supported for a single tree.

Action

You have two options. The first option is to resubmit the command and specify a different source or target VDisk. The second option is to delete a sufficient number of the existing FlashCopy mappings in which either the source or the target VDisk is a member so that the combined mapping tree does not exceed the maximum number of mappings that are supported for a single tree, and resubmit the command.

CMMVC6303E The create failed because the source and target VDIsks are the same.

Explanation

A particular Vdisk cannot be both the source and the target in a FlashCopy mapping. The FlashCopy mapping was not created because you have specified the same VDisk as both the source and the target.

Action

Resubmit the command and specify source and target VDIsks that are not identical.

CMMVC6304E The create failed because the source VDisk does not exist.

Explanation

You must specify an existing VDisk as the source of a FlashCopy mapping. The FlashCopy mapping was not created because the source VDisk that you specified does not exist.

Action

Either create the source VDisk that you specified and resubmit the command, or resubmit the command and specify an existing VDisk as the source.

CMMVC6305E The create failed because the target VDisk does not exist.

Explanation

You must specify an existing VDisk as the target of a FlashCopy mapping. The FlashCopy mapping was not created because the target VDisk that you specified does not exist.

Action

Either create the target VDisk that you specified and resubmit the command, or resubmit the command and specify an existing VDisk as the target.

CMMVC6306E The create failed because the source VDisk is the member of a FlashCopy mapping whose grain size is different to that specified.

Explanation

All FlashCopy mappings that are in a tree of connected mappings must have the same grain size. The FlashCopy mapping was not created because the source VDisk that you specified is either the source or the target VDisk of another FlashCopy mapping, and the grain size of the other mapping is different from the grain size that you specified for the mapping that you attempted to create.

Action

You have two options. The first option is to delete all of the FlashCopy mappings that contain the source VDisk that you specified where the grain size of the FlashCopy mapping is different from the grain size that you specified, and resubmit the command. The second option is to resubmit the command and do not specify the grain size attribute.

CMMVC6307E The create failed because the target VDisk is the member of a FlashCopy mapping whose grain size is different to that specified.

Explanation

All FlashCopy mappings that are in a tree of connected mappings must have the same grain size. The FlashCopy mapping was not created because the target VDisk that you specified is either the source or the target VDisk of another FlashCopy mapping, and the grain size of the other mapping is different from the grain size that you specified for the mapping that you attempted to create.

Action

You have two options. The first option is to delete all of the FlashCopy mappings that contain the target VDisk that you specified where the grain size of the FlashCopy mapping is different from the grain size that you specified, and resubmit the command. The second option is to resubmit the command and do not specify the grain size attribute.

CMMVC6308E The create failed because the source VDisk is the member of a FlashCopy mapping whose I/O group is different to that specified.

Explanation

All FlashCopy mappings in a tree of connected mappings must be in the same I/O group. The FlashCopy mapping was not created because the source VDisk that you specified is the source or target VDisk in another FlashCopy mapping and the I/O group of the other FlashCopy mapping is different from the I/O group that you specified.

Action

You have two options. The first option is to delete all of the FlashCopy mappings that contain the source VDisk that you specified where the FlashCopy mapping is in a different I/O group from the I/O group that you specified, and resubmit the command. The second option is to resubmit the command and do not specify the I/O group attribute. If you perform the second option, the default value of the I/O group attribute is used.

CMMVC6309E The create failed because the target VDisk is the member of a FlashCopy mapping whose I/O group is different to that specified.

Explanation

All FlashCopy mappings in a tree of connected mappings must be in the same I/O group. The FlashCopy mapping was not created because the target VDisk that you specified is the source or target VDisk in another FlashCopy mapping and the I/O group of the other FlashCopy mapping is different from the I/O group that you specified.

Action

You have two options. The first option is to delete all of the FlashCopy mappings that contain the target VDisk that you specified where the FlashCopy mapping is in a different I/O group from the I/O group that you specified, and resubmit the command. The second option is to resubmit the command and do not specify the I/O group attribute. If you perform the second option, the default value of the I/O group attribute is used.

CMMVC6310E The modify failed because the specified FlashCopy mapping does not exist.

Explanation

You cannot modify a FlashCopy mapping that does not exist. The modify command failed because the FlashCopy mapping that you specified does not exist.

Action

Resubmit the command and specify an existing FlashCopy mapping.

CMMVC6311E The command failed because the source VDisk is the target of a FlashCopy mapping that is in the specified consistency group.

Explanation

A particular VDisk cannot be both the source of one FlashCopy mapping and the target of another FlashCopy mapping in the same consistency group. The FlashCopy mapping was not created because the source VDisk of the FlashCopy mapping that you attempted to create is already the target VDisk of a FlashCopy mapping in the consistency group that you specified.

Action

Resubmit the command and specify a different consistency group.

CMMVC6312E The command failed because the target VDisk is the source of a FlashCopy mapping that is in the specified consistency group.

Explanation

A particular VDisk cannot be both the source of one FlashCopy mapping and the target of another FlashCopy mapping in the same consistency group. The FlashCopy mapping was not created because the target VDisk of the FlashCopy mapping that you attempted to create is already the source VDisk of a FlashCopy mapping in the consistency group that you specified.

Action

Resubmit the command and specify a different consistency group.

CMMVC6313E The command failed because the specified background copy rate is invalid.

Explanation

The command failed because the background copy rate that you specified is not a supported value.

Action

Either resubmit the command and specify a supported value for the background copy rate, or resubmit the command and do not specify the background copy rate attribute. If you do not specify the background copy rate attribute, the default background copy rate value is used.

CMMVC6314E The command failed because the specified cleaning rate is not valid.

Explanation

The command failed because the cleaning rate that you specified is not a supported value.

Action

Either resubmit the command and specify a supported value for the cleaning rate, or resubmit the command and do not specify the cleaning rate attribute. If you do not specify the cleaning rate attribute, the default cleaning rate value is used.

CMMVC6315E The command failed because the specified grain size is not valid.

Explanation

The command failed because the grain size that you specified is not a supported value.

Action

Either resubmit the command and specify a supported value for the grain size, or resubmit the command and do not specify the grain size attribute. If you do not specify the grain size attribute, the default grain size value is used.

CMMVC6500E The action failed because the source and destination vdisk are the same.

Explanation

The action failed because the source and destination vdisk are the same.

CMMVC6501E The action failed because the node hardware is incompatible with the current I/O group member.

Explanation

The action failed because the node hardware is incompatible with the current I/O group member.

CMMVC6502E The FlashCopy mapping was not prepared because preparing consistency group 0 is not a valid operation.

Explanation

The FlashCopy mapping was not prepared because preparing consistency group 0 is not a valid operation.

CMMVC6503E The FlashCopy mapping or consistency group was not stopped because starting consistency group 0 is not a valid operation.

Explanation

The FlashCopy mapping or consistency group was not stopped because starting consistency group 0 is not a valid operation.

Accessibility

Accessibility features help a user who has a physical disability, such as restricted mobility or limited vision, to use software products successfully.

Features

These are the major accessibility features in the SAN Volume Controller Console :

- You can use screen-reader software and a digital speech synthesizer to hear what is displayed on the screen. The following screen readers have been tested: WebKing v5.5 and Window-Eyes v5.5.
- You can operate all features using the keyboard instead of the mouse.
- You can change the initial delay and repeat rate of the up and down buttons to two seconds when you use the front panel of the SAN Volume Controller to set or change an IP address. This feature is documented in the applicable sections of the SAN Volume Controller publications.

Navigating by keyboard

You can use keys or key combinations to perform operations and initiate many menu actions that can also be done through mouse actions. You can navigate the SAN Volume Controller Console and help system from the keyboard by using the following key combinations:

- To traverse to the next link, button, or topic, press Tab inside a frame (page).
- To expand or collapse a tree node, press → or ←, respectively.
- To move to the next topic node, press V or Tab.
- To move to the previous topic node, press ^ or Shift+Tab.
- To scroll all the way up or down, press Home or End, respectively.
- To go back, press Alt+←.
- To go forward, press Alt+→.
- To go to the next frame, press Ctrl+Tab.
- To move to the previous frame, press Shift+Ctrl+Tab.
- To print the current page or active frame, press Ctrl+P.
- To select, press Enter.

Accessing the publications

You can view the publications for the SAN Volume Controller in Adobe Portable Document Format (PDF) using the Adobe Acrobat Reader. The PDFs are provided at the following Web site:

<http://www.ibm.com/storage/support/2145>

Related reference

“SAN Volume Controller library and related publications” on page xxiv
A list of other publications that are related to this product are provided to you for your reference.

Notices

This information was developed for products and services offered in the U.S.A.

IBM may not offer the products, services, or features discussed in this document in other countries. Consult your local IBM representative for information on the products and services currently available in your area. Any reference to an IBM product, program, or service is not intended to state or imply that only that IBM product, program, or service may be used. Any functionally equivalent product, program, or service that does not infringe any IBM intellectual property right may be used instead. However, it is the user's responsibility to evaluate and verify the operation of any non-IBM product, program, or service.

IBM may have patents or pending patent applications covering subject matter described in this document. The furnishing of this document does not give you any license to these patents. You can send license inquiries, in writing, to:

*IBM Director of Licensing
IBM Corporation
North Castle Drive
Armonk, NY 10504-1785
U.S.A.*

For license inquiries regarding double-byte (DBCS) information, contact the IBM Intellectual Property Department in your country or send inquiries, in writing, to:

*IBM World Trade Asia Corporation
Licensing
2-31 Roppongi 3-chome, Minato-ku
Tokyo 106-0032, Japan*

The following paragraph does not apply to the United Kingdom or any other country where such provisions are inconsistent with local law:

INTERNATIONAL BUSINESS MACHINES CORPORATION PROVIDES THIS PUBLICATIONS "AS IS" WITHOUT WARRANTY OF ANY KIND, EITHER EXPRESS OR IMPLIED, INCLUDING, BUT NOT LIMITED TO, THE IMPLIED WARRANTIES OF NON-INFRINGEMENT, MERCHANTABILITY OR FITNESS FOR A PARTICULAR PURPOSE. Some states do not allow disclaimer of express or implied warranties in certain transactions, therefore, this statement may not apply to you.

This information could include technical inaccuracies or typographical errors. Changes are periodically made to the information herein; these changes will be incorporated in new editions of the publication. IBM may make improvements and/or changes in the product(s) and/or the program(s) described in this publication at any time without notice.

Any references in this information to non-IBM Web sites are provided for convenience only and do not in any manner serve as an endorsement of those Web sites. The materials at those Web sites are not part of the materials for this IBM product and use of those Web sites is at your own risk.

IBM may use or distribute any of the information you supply in any way it believes appropriate without incurring any obligation to you.

Licensees of this program who wish to have information about it for the purpose of enabling: (i) the exchange of information between independently created programs and other programs (including this one) and (ii) the mutual use of the information which has been exchanged, should contact:

*IBM Corporation
Almaden Research
650 Harry Road
Bldg 80, D3-304, Department 277
San Jose, CA 95120-6099
U.S.A.*

Such information may be available, subject to appropriate terms and conditions, including in some cases, payment of a fee.

The licensed program described in this document and all licensed material available for it are provided by IBM under terms of the IBM Customer Agreement, IBM International Program License Agreement or any equivalent agreement between us.

Any performance data contained herein was determined in a controlled environment. Therefore, the results obtained in other operating environments may vary significantly. Some measurements may have been made on development-level systems and there is no guarantee that these measurements will be the same on generally available systems. Furthermore, some measurement may have been estimated through extrapolation. Actual results may vary. Users of this document may verify the applicable data for their specific environment.

Information concerning non-IBM products was obtained from the suppliers of those products, their published announcements or other publicly available sources. IBM has not tested those products and cannot confirm the accuracy of performance, compatibility or any other claims related to non-IBM products. Questions on the capabilities of non-IBM products may be addressed to the suppliers of those products.

All statements regarding IBM's future direction or intent are subject to change or withdrawal without notice, and represent goals and objectives only.

This information is for planning purposes only. The information herein is subject to change before the products described become available.

This information contains examples of data and reports used in daily business operations. To illustrate them as completely as possible, the examples include the names of individuals, companies, brands, and products. All of these names are fictitious and any similarity to the names and addresses used by an actual business enterprise is entirely coincidental.

If you are viewing this information softcopy, the photographs and color illustrations may not appear.

Trademarks

The following terms are trademarks of the International Business Machines Corporation in the United States, other countries, or both:

- AIX
- BladeCenter
- Enterprise Storage Server
- FlashCopy
- IBM
- IBM eServer
- IBM TotalStorage
- IBM System Storage
- System p5
- System z9
- System Storage
- TotalStorage
- xSeries

Intel and Pentium are trademarks of Intel Corporation in the United States, other countries, or both.

Java and all Java-based trademarks are trademarks of Sun Microsystems, Inc. in the United States, other countries, or both.

Microsoft and Windows are trademarks of Microsoft Corporation in the United States, other countries, or both.

UNIX is a registered trademark of The Open Group in the United States and other countries.

Linux is a trademark of Linus Torvalds in the United States, other countries, or both.

Adobe, the Adobe logo, PostScript, and the PostScript logo are either registered trademarks or trademarks of Adobe Systems Incorporated in the United States, and/or other countries.

Other company, product, and service names may be trademarks or service marks of others.

Glossary

This is the glossary for the SAN Volume Controller.

A

application server

A host that is attached to the storage area network (SAN) and that runs applications.

asymmetric virtualization

A virtualization technique in which the virtualization engine is outside the data path and performs a metadata-style service. The metadata server contains all the mapping and locking tables while the storage devices contain only data. See also *symmetric virtualization*.

auxiliary virtual disk

The virtual disk that contains a backup copy of the data and that is used in disaster recovery scenarios. See also *master virtual disk*.

C

cluster

In SAN Volume Controller, up to four pairs of nodes that provide a single configuration and service interface.

configuration node

A node that acts as the focal point for configuration commands and manages the data that describes the cluster configuration.

consistency group

A group of copy relationships between virtual disks that are managed as a single entity.

consistent copy

In a Metro or Global Mirror relationship, a copy of a secondary virtual disk (VDisk) that is identical to the primary VDisk from the viewpoint of a host system, even if a power failure occurred while I/O activity was in progress.

copied

In a FlashCopy mapping, a state that indicates that a copy has been started after the copy relationship was created. The copy process is complete and the target disk has no further dependence on the source disk.

copying

A status condition that describes the state of a pair of virtual disks (VDisks) that have a copy relationship. The copy process has been started but the two virtual disks are not yet synchronized.

counterpart SAN

A nonredundant portion of a redundant storage area network (SAN). A counterpart SAN provides all the connectivity of the redundant SAN but without the redundancy. Each counterpart SANs provides an alternate path for each SAN-attached device. See also *redundant SAN*.

D

data migration

The movement of data from one physical location to another without disrupting I/O operations.

degraded

Pertaining to a valid configuration that has suffered a failure but continues to be supported and legal. Typically, a repair action can be performed on a degraded configuration to restore it to a valid configuration.

dependent write operations

A set of write operations that must be applied in the correct order to maintain cross-volume consistency.

destage

A write command initiated by the cache to flush data to disk storage.

directed maintenance procedures

The set of maintenance procedures that can be run for a cluster. These procedures are run from within the SAN Volume Controller application and are documented in the *IBM System Storage SAN Volume Controller: Service Guide*.

disconnected

In a Metro or Global Mirror relationship, pertains to two clusters when they cannot communicate.

disk controller

A device that coordinates and controls the operation of one or more disk drives and synchronizes the operation of the drives with the operation of the system as a whole. Disk controllers provide the storage that the cluster detects as managed disks (MDisks).

disk zone

A zone defined in the storage area network (SAN) fabric in which the SAN Volume Controller can detect and address the logical units that the disk controllers present.

E

error code

A value that identifies an error condition.

ESS See *IBM TotalStorage[®] Enterprise Storage Server[®]*.

exclude

To remove a managed disk (MDisk) from a cluster because of certain error conditions.

excluded

In SAN Volume Controller, the status of a managed disk that the cluster has removed from use after repeated access errors.

extent A unit of data that manages the mapping of data between managed disks and virtual disks.

F

failover

In SAN Volume Controller, the function that occurs when one redundant part of the system takes over the workload of another part of the system that has failed.

fibre channel

A technology for transmitting data between computer devices at a data rate of up to 4 Gbps. It is especially suited for attaching computer servers to shared storage devices and for interconnecting storage controllers and drives.

FlashCopy service

In SAN Volume Controller, a copy service that duplicates the contents of a source virtual disk (VDisk) to a target VDisk. In the process, the original contents of the target VDisk are lost. See also *point-in-time copy*.

FlashCopy mapping

A relationship between two virtual disks.

FlashCopy relationship

See *FlashCopy mapping*.

G**Global Mirror**

An asynchronous copy service that enables host data on a particular source virtual disk (VDisk) to be copied to the target VDisk that is designated in the relationship.

H

HBA See *host bus adapter*.

host bus adapter (HBA)

In SAN Volume Controller, an interface card that connects a host bus, such as a peripheral component interconnect (PCI) bus, to the storage area network.

host An open-systems computer that is connected to the SAN Volume Controller through a fibre-channel interface.

host ID

In SAN Volume Controller, a numeric identifier assigned to a group of host fibre-channel ports for the purpose of logical unit number (LUN) mapping. For each host ID, there is a separate mapping of Small Computer System Interface (SCSI) IDs to virtual disks (VDisks).

host zone

A zone defined in the storage area network (SAN) fabric in which the hosts can address the SAN Volume Controllers.

I**IBM TotalStorage Enterprise Storage Server (ESS)**

An IBM product that provides an intelligent disk-storage subsystem across an enterprise.

idling The status of a pair of virtual disks (VDisks) that have a defined copy relationship for which no copy activity has yet been started.

In a Metro or Global Mirror relationship, the state that indicates that the master virtual disks (VDisks) and auxiliary VDisks are operating in the primary role. Consequently, both VDisks are accessible for write I/O operations.

illegal configuration

A configuration that will not operate and will generate an error code to indicate the cause of the problem.

image mode

An access mode that establishes a one-to-one mapping of extents in the managed disk (MDisk) with the extents in the virtual disk (VDisk). See also *managed space mode* and *unconfigured mode*.

image VDisk

A virtual disk (VDisk) in which there is a direct block-for-block translation from the managed disk (MDisk) to the VDisk.

inconsistent

In a Metro or Global Mirror relationship, pertaining to a secondary virtual disk (VDisk) that is being synchronized with the primary VDisk.

input/output (I/O)

Pertaining to a functional unit or communication path involved in an input process, an output process, or both, concurrently or not, and to the data involved in such a process.

integrity

The ability of a system to either return only correct data or respond that it cannot return correct data.

Internet Protocol (IP)

In the Internet suite of protocols, a connectionless protocol that routes data through a network or interconnected networks and acts as an intermediary between the higher protocol layers and the physical network.

I/O See *input/output*.

I/O group

A collection of virtual disks (VDisks) and node relationships that present a common interface to host systems.

I/O throttling rate

The maximum rate at which an I/O transaction is accepted for this virtual disk (VDisk).

IP See *Internet Protocol*.

L

LBA See *logical block address*.

local fabric

In SAN Volume Controller, those storage area network (SAN) components (such as switches and cables) that connect the components (nodes, hosts, switches) of the local cluster together.

local/remote fabric interconnect

The storage area network (SAN) components that are used to connect the local and remote fabrics together.

logical block address (LBA)

The block number on a disk.

logical unit (LU)

An entity to which Small Computer System Interface (SCSI) commands are addressed, such as a virtual disk (VDisk) or managed disk (MDisk).

logical unit number (LUN)

The SCSI identifier of a logical unit within a target. (S)

LU See *logical unit*.

LUN See *logical unit number*.

M**managed disk (MDisk)**

A Small Computer System Interface (SCSI) logical unit that a redundant array of independent disks (RAID) controller provides and a cluster manages. The MDisk is not visible to host systems on the storage area network (SAN).

managed disk group

A collection of managed disks (MDisks) that, as a unit, contain all the data for a specified set of virtual disks (VDisks).

managed space mode

An access mode that enables virtualization functions to be performed. See also *image mode* and *unconfigured mode*.

mapping

See *FlashCopy mapping*.

master virtual disk

The virtual disk (VDisk) that contains a production copy of the data and that an application accesses. See also *auxiliary virtual disk*.

MDisk

See *managed disk*.

Metro Mirror

A synchronous copy service that enables host data on a particular source virtual disk (VDisk) to be copied to the target VDisk that is designated in the relationship.

migration

See *data migration*.

mirrorset

IBM definition: See *RAID-1*.

HP definition: A RAID storageset of two or more physical disks that maintain a complete and independent copy of the data from the virtual disk. This type of storageset has the advantage of being highly reliable and extremely tolerant of device failure. Raid level 1 storagesets are referred to as mirrorsets.

N

node One SAN Volume Controller. Each node provides virtualization, cache, and Copy Services to the storage area network (SAN).

node rescue

In SAN Volume Controller, the process by which a node that has no valid software installed on its hard disk drive can copy the software from another node connected to the same fibre-channel fabric.

O

offline

Pertaining to the operation of a functional unit or device that is not under the continual control of the system or of a host.

online Pertaining to the operation of a functional unit or device that is under the continual control of the system or of a host.

P

partnership

In Metro or Global Mirror operations, the relationship between two clusters. In a cluster partnership, one cluster is defined as the local cluster and the other cluster as the remote cluster.

paused

In SAN Volume Controller, the process by which the cache component quiesces all ongoing I/O activity below the cache layer.

pend To cause to wait for an event.

point-in-time copy

The instantaneous copy that the FlashCopy service makes of the source virtual disk (VDisk). In some contexts, this copy is known as a T_0 copy.

port The physical entity within a host, SAN Volume Controller, or disk controller system that performs the data communication (transmitting and receiving) over the fibre channel.

primary virtual disk

In a Metro or Global Mirror relationship, the target of write operations issued by the host application.

PuTTY

A client program that allows you to run remote sessions on your computer through specific network protocols, such as SSH, Telnet, and Rlogin.

Q

quorum disk

A managed disk (MDisk) that contains a reserved area that is used exclusively for cluster management. The quorum disk is accessed in the event that it is necessary to determine which half of the cluster continues to read and write data.

R

RAID See *redundant array of independent disks*.

RAID 1

SNIA dictionary definition: A form of storage array in which two or more identical copies of data are maintained on separate media. (S)

IBM definition: A form of storage array in which two or more identical copies of data are maintained on separate media. Also known as mirrorset.

HP definition: See *mirrorset*.

RAID 5

SNIA definition: A form of parity RAID in which the disks operate independently, the data strip size is no smaller than the exported block size, and parity check data is distributed across the array's disks. (S)

IBM definition: See the SNIA definition.

HP definition: A specially developed RAID storageset that stripes data and parity across three or more members in a disk array. A RAIDset combines the best characteristics of RAID level 3 and RAID level 5. A RAIDset is the best choice for most applications with small to medium I/O requests, unless the application is write intensive. A RAIDset is sometimes called parity RAID. RAID level 3/5 storagesets are referred to as RAIDsets.

RAID 10

A type of RAID that optimizes high performance while maintaining fault tolerance for up to two failed disk drives by striping volume data across several disk drives and mirroring the first set of disk drives on an identical set.

redundant array of independent disks (RAID)

A collection of two or more disk drives that present the image of a single disk drive to the system. In the event of a single device failure, the data can be read or regenerated from the other disk drives in the array.

redundant SAN

A storage area network (SAN) configuration in which any one single component might fail, but connectivity between the devices within the SAN is maintained, possibly with degraded performance. This configuration is normally achieved by splitting the SAN into two, independent, counterpart SANs. See also *counterpart SAN*.

rejected

A status condition that describes a node that the cluster software has removed from the working set of nodes in the cluster.

relationship

In Metro or Global Mirror, the association between a master virtual disk (VDisk) and an auxiliary VDisk. These VDIsks also have the attributes of a primary or secondary VDisk. See also *auxiliary virtual disk*, *master virtual disk*, *primary virtual disk*, and *secondary virtual disk*.

S

SAN See *storage area network*.

SAN Volume Controller fibre-channel port fan in

The number of hosts that can see any one SAN Volume Controller port.

SCSI See *Small Computer Systems Interface*.

secondary virtual disk

In Metro or Global Mirror, the virtual disk (VDisk) in a relationship that contains a copy of data written by the host application to the primary VDisk.

Secure Shell (SSH)

A program to log in to another computer over a network, to execute commands in a remote machine, and to move files from one machine to another.

sequential VDisk

A virtual disk that uses extents from a single managed disk.

Simple Network Management Protocol (SNMP)

In the Internet suite of protocols, a network management protocol that is used to monitor routers and attached networks. SNMP is an

application-layer protocol. Information on devices managed is defined and stored in the application's Management Information Base (MIB).

Small Computer System Interface (SCSI)

A standard hardware interface that enables a variety of peripheral devices to communicate with one another.

SNMP

See *Simple Network Management Protocol*.

SSH See *Secure Shell*.

stand-alone relationship

In FlashCopy, Metro Mirror, and Global Mirror, relationships that do not belong to a consistency group and that have a null consistency group attribute.

stop A configuration command that is used to stop the activity for all copy relationships in a consistency group.

stopped

The status of a pair of virtual disks (VDisks) that have a copy relationship that the user has temporarily broken because of a problem.

storage area network (SAN)

A network whose primary purpose is the transfer of data between computer systems and storage elements and among storage elements. A SAN consists of a communication infrastructure, which provides physical connections, and a management layer, which organizes the connections, storage elements, and computer systems so that data transfer is secure and robust. (S)

subsystem device driver (SDD)

An IBM pseudo device driver designed to support the multipath configuration environments in IBM products.

superuser authority

The level of access required to add users.

suspended

The status of a pair of virtual disks (VDisks) that have a copy relationship that has been temporarily broken because of a problem.

symmetric virtualization

A virtualization technique in which the physical storage in the form of Redundant Array of Independent Disks (RAID) is split into smaller chunks of storage known as *extents*. These extents are then concatenated, using various policies, to make virtual disks (VDisks). See also *asymmetric virtualization*.

synchronized

In Metro or Global Mirror, the status condition that exists when both virtual disks (VDisks) of a pair that has a copy relationship contain the same data.

T

trigger

To initiate or reinitiate copying between a pair of virtual disks (VDisks) that have a copy relationship.

U

unconfigured mode

A mode in which I/O operations cannot be performed. See also *image mode* and *managed space mode*.

uninterruptible power supply (UPS)

A device that is connected between a computer and its power source that protects the computer against blackouts, brownouts, and power surges. The uninterruptible power supply contains a power sensor to monitor the supply and a battery to provide power until an orderly shutdown of the system can be performed.

V

valid configuration

A configuration that is supported.

VDisk See *virtual disk*.

virtual disk (VDisk)

In SAN Volume Controller, a device that host systems attached to the storage area network (SAN) recognize as a Small Computer System Interface (SCSI) disk.

virtualization

In the storage industry, a concept in which a pool of storage is created that contains several disk subsystems. The subsystems can be from various vendors. The pool can be split into virtual disks that are visible to the host systems that use them.

virtualized storage

Physical storage that has virtualization techniques applied to it by a virtualization engine.

vital product data (VPD)

Information that uniquely defines system, hardware, software, and microcode elements of a processing system.

W

worldwide node name (WWNN)

An identifier for an object that is globally unique. WWNNs are used by Fibre Channel and other standards.

worldwide port name (WWPN)

A unique 64-bit identifier that is associated with a fibre-channel adapter port. The WWPN is assigned in an implementation- and protocol-independent manner.

WWNN

See *worldwide node name*.

WWPN

See *worldwide port name*.

Index

Special characters

-filtervalue argument 179

A

about this guide xxi
accessibility
 keyboard 443
 repeat rate of up and down buttons 443
 shortcut keys 443
addhostiogrps command 87
addhostport command 88
addmdisk command 115
addnode command 38, 71
addsshkey command 297
administrator role 18, 19
applysoftware command 73, 301
audit log commands
 catauditlog 11
 dumppauditlog 13
 lsauditlogdumps 14
 overview 11

B

backup and restore commands 65
backup command 65
backup commands
 backup 65
 clear 66
 help 67

C

catauditlog command 11
caterrlog command 187
caterrlogbyseqnum command 189
chcluster command 40
chcontroller commands 319
chemail command 23
chemailuser command 25
cherrstate command 75, 289
chfcconsistgrp command 127
chfcmap command 128
chhost command 89
chiogrps command 43
chlicense command 293
chmdisk command 123
chmdiskgrp command 116
chnode command 46
chpartnership command 145
chrconsistgrp command 146
chrrelationship command 147
chvdisk command 97
clear command 66
cleardumps command 47, 302
clearerrlog command 76, 288

CLI (command-line interface)
 configuring PuTTY 5
 preparing SSH client systems 2

cluster commands 37

 addnode 38
 chcluster 40
 chiogrps 43
 chnode 46
 cleardumps 47
 cpdumps 48
 detectmdisk 50
 rmnode 51
 setclustertime 56
 setpwdreset 57
 settimezone 58
 startstats 58
 stopcluster 61
 stopstats 63

cluster diagnostic and service-aid

 commands
 addnode 71
 overview 71

cluster diagnostic commands

 rmnode 78
 setlocale 84
 svqueryclock 85
 writeserenum 85

cluster diagnostic service-aid commands

 applysoftware 73
 cherrstate 75
 clearerrlog 76

cluster error log

 displaying 187

clusters 37

 diagnostic and service-aid
 commands 71

command-line interface (CLI)

 configuring 4
 configuring PuTTY 5
 preparing SSH clients 2

Command-line interface messages

 overview 321

commands 37

 addhostiogrps 87
 addhostport 88
 addmdisk 115
 addnode 38, 71
 addsshkey 297
 applysoftware 301
 backup 65
 catauditlog 11
 caterrlog 187
 caterrlogbyseqnum 189
 chcluster 40
 chcontroller 319
 chemail 23
 chemailuser 25
 cherrstate 75, 289
 chfcconsistgrp 127
 chfcmap 128
 chhost 89

commands (*continued*)

 chiogrps 43
 chlicense 293
 chmdisk 123
 chmdiskgrp 116
 chnode 46
 chpartnership 145
 chrconsistgrp 146
 chrrelationship 147
 chvdisk 97
 clear 66
 cleardumps 47, 302
 clearerrlog 76, 288
 cpdumps 48
 detectmdisk 50
 dumppauditlog 13
 dumpperrlog 77, 287, 303
 dumppinternallog 294
 exit 304
 expandvdisksize 100
 finderr 77, 287
 help 67
 includemdisk 124
 ls2145dumps 190, 307
 lsauditlogdumps 14
 lsauth 20
 lscluster 192
 lsclustercandidate 195
 lsclustervpd 308
 lscontroller 196
 lscopystatus 191
 lsdiscoverystatus 199
 lsemailer 26
 lserrlogbyfcconsistgrp 200
 lserrlogbyfcmap 201
 lserrlogbyhost 203
 lserrlogbyiogrps 204
 lserrlogbymdisk 206
 lserrlogbymdiskgp 207
 lserrlogbynode 208
 lserrlogbyrcconsistgrp 210
 lserrlogbyrcrelationship 211
 lserrlogbyvdisk 213
 lserrlogdumps 214, 309
 lsfabric 215
 lsfcconsistgrp 217
 lsfcmap 220
 lsfcmapcandidate 222
 lsfcmapdependentmaps 224
 lsfcmapprogress 223
 lsfeaturedumps 226, 310
 lsfreeextents 227
 lshbaportcandidate 228
 lshost 229
 lshostiogrps 231
 lshostvdisksmap 233
 lsiogrps 234
 lsiogrpscandidate 238
 lsiogrphost 236
 lsiostatdumps 239, 311
 lsiotracedumps 240, 312

commands (*continued*)

- lslicense 241
- lsmdisk 242
- lsmdiskcandidate 246
- lsmdiskextent 248
- lsmdiskgrp 250
- lsmdiskmember 252
- lsmigrate 254
- lsnode 255
- lsnodecandidate 258
- lsnodes 313
- lsnodevpd 259, 314
- lsrconsistgrp 262
- lsrrelationship 265
- lsrrelationshipcandidate 268
- lsrrelationshipprogress 269
- lssoftware.dumps 270, 317
- lsshkeys 271
- lstimezones 272
- lsvdisk 273
- lsvdiskdependentmaps 277
- lsvdiskextent 277
- lsvdiskfcmappings 279
- lsvdiskhostmap 280
- lsvdiskmember 281
- lsvdiskprogress 283
- migrateexts 167
- migratetoimage 169
- migratevdisk 170
- mkauth 18
- mkemailuser 28
- mkfconsistgrp 129
- mkfcmmap 130
- mkhost 91
- mkmdiskgrp 117
- mkpartnership 149
- mkrconsistgrp 150
- mkrcrelationship 151
- mkvdisk 102
- mkvdiskhostmap 107
- prestartfconsistgrp 134, 139
- prestartfcmmap 135
- restore 68
- rmailsshkeys 298
- rmauth 19
- rmemailuser 29
- rmfconsistgrp 136
- rmfcmmap 137
- rmhost 93
- rmhostiogrps 94
- rmhostport 95
- rmmdisk 118
- rmmdiskgrp 120
- rmnode 51, 78
- rmpartnership 154
- rmrconsistgrp 155
- rmrrelationship 156
- rmsshkey 299
- rmvdisk 109
- rmvdiskhostmap 111
- sendinventoryemail 30
- setclustertime 56
- setdisktrace 173
- setemail 31
- setevent 83, 290
- setlocale 84
- setpwdreset 57

commands (*continued*)

- setquorum 124
- settimezone 58
- settrace 174
- showtimezone 284
- shrinkvdisksize 112
- startemail 32
- startfconsistgrp 139
- startfcmmap 140
- startrcconsistgrp 157
- startrcrelationship 159
- startstats 58
- starttrace 176
- stopcluster 61
- stopemail 33
- stopfconsistgrp 142
- stopfcmmap 143
- stoprcconsistgrp 161
- stoprcrelationship 162
- stopstats 63
- stoptrace 177
- svqueryclock 85
- switchrcconsistgrp 164
- switchrcrelationship 165
- testemail 33
- writeserenum 85

configuring

- command-line interface (CLI) 4
- master console 4
- PuTTY 5
- SAN Volume Controller 4
- secure shell 4

controller commands

- chcontroller 319
- overview 319

controllers

- changing 319
- command 196, 319

copyoperator role 18, 19

cpdumps command 48

creating, SSH keys 4

current time zone 284

D

data migration progress

- viewing 254

dependent maps

- viewing 224

detectmdisk command 50

dump files 226

- listing 190, 307

dumpauditlog command 13

dumperrlog command 77, 287, 303

dumpinternallog command 294

E

e-mail commands

- chemail 23
- chemailuser 25
- lsemailuser 26
- mkemailuser 28
- overview 23
- rmemailuser 29
- sendinventoryemail 30

e-mail commands (*continued*)

- setemail 31
- startemail 32
- stopemail 33
- testemail 33

emphasis in text xxiv

error log commands

- cherrstate 289
- clearerrlog 288
- dumperrlog 287
- finderr 287
- overview 287
- setevent 290

error log dump files

- viewing 309

exit command 304

expandvdisksize command 100

extent allocation

- viewing 248

F

featurization commands

- chlicense 293
- dumpinternallog 294
- overview 293

featurization settings 241

filtering

- FlashCopy
 - consistency groups 217
 - mappings 220, 277

finderr command 77, 287

FlashCopy

- definition 451
- mapping 451

FlashCopy commands

- chfconsistgrp 127
- chfcmmap 128
- mkfconsistgrp 129
- mkfcmmap 130
- overview 127
- prestartfconsistgrp 134, 139
- prestartfcmmap 135
- rmfconsistgrp 136
- rmfcmmap 137
- startfconsistgrp 139
- startfcmmap 140
- stopfconsistgrp 142
- stopfcmmap 143

FlashCopy progress 223

free extents 227

G

generating a SSH key pair 4

Global Mirror commands

- chpartnership 145
- chrconsistgrp 146
- chrrelationship 147
- mkpartnership 149
- mkrconsistgrp 150
- mkrcrelationship 151
- overview 145
- rmpartnership 154
- rmrconsistgrp 155
- rmrrelationship 156

Global Mirror commands (*continued*)
startcrconsistgrp 157
startcrrelationship 159
stopcrconsistgrp 161
stopcrrelationship 162
switchcrconsistgrp 164
switchcrrelationship 165
glossary 449

H

help command 67
host bus adaptor, unconfigured
 viewing 228
host commands
 addhostiogrp 87
 addhostport 88
 chhost 89
 mkhost 91
 overview 87
 rmhost 93
 rmhostiogrp 94
 rmhostport 95
host I/O group 231
hosts
 commands 87
 viewing 229

I

includemdisk command 124
information center xxiv
information commands
 caterrlog 187
 caterrlogbyseqnum 189
 ls2145dumps 190
 lscluster 192
 lsclustercandidate 195
 lscontroller 196
 lscopystatus 191
 lsdiscoverystatus 199
 lserrlogbyfconsistgrp 200
 lserrlogbyfcmmap 201
 lserrlogbyhost 203
 lserrlogbyiogrp 204
 lserrlogbymdisk 206
 lserrlogbymdiskgrp 207
 lserrlogbynnode 208
 lserrlogbyrconsistgrp 210
 lserrlogbyrrelationship 211
 lserrlogbyvdisk 213
 lserrlogdumps 214
 lsfabric 215
 lsfconsistgrp 217
 lsfcmmap 220
 lsfcmmapcandidate 222
 lsfcmmapdependentmaps 224
 lsfcmmapprogress 223
 lsfeaturedumps 226
 lsfreeextents 227
 lshbaportcandidate 228
 lshost 229
 lshostiogrp 231
 lshostvdiskmap 233
 lsiogrp 234
 lsiogrpcandidate 238

information commands (*continued*)
 lsiogrpghost 236
 lsiostatsdumps 239
 lsiotracedumps 240
 lslicense 241
 lsmdisk 242
 lsmdiskcandidate 246
 lsmdiskextent 248
 lsmdiskgrp 250
 lsmdiskmember 252
 lsmigrate 254
 lsnode 255
 lsnodecandidate 258
 lsnodevdpd 259
 lsrconsistgrp 262
 lsrrelationship 265
 lsrrelationshipcandidate 268
 lsrrelationshipprogress 269
 lssoftware.dumps 270
 lssshkeys 271
 lstimezones 272
 lsvdisk 273
 lsvdiskdependentmaps 277
 lsvdiskextent 277
 lsvdiskfcmappings 279
 lsvdiskhostmap 280
 lsvdiskmember 281
 lsvdiskprogress 283
 overview 187
 showtimezone 284
installing PuTTY 1
inventory commands
 chcluster 40
 chemail 23
 mkemailuser 28
 overview 23
 rmemailuser 29
 sendinventoryemail 30
 startemail 32
 stopemail 33
 testemail 33

K

keyboard
 navigating by 443
 shortcuts 443

L

legal notices 445
license
 changing settings 293
 viewing 241
list dump commands 185
ls2145dumps command 190, 307
lsauditlogdumps command 14
lsauth command 20
lscluster command 192
lsclustercandidate command 195
lsclustervpd command 308
lscontroller command 196
lscopystatus command 191
lsdiscoverystatus command 199
lsemailuser command 26
lserrlogbyfconsistgrp command 200

lserrlogbyfcmmap command 201
lserrlogbyhost command 203
lserrlogbyiogrp command 204
lserrlogbymdisk command 206
lserrlogbymdiskgrp command 207
lserrlogbynnode command 208
lserrlogbyrconsistgrp command 210
lserrlogbyrrelationship command 211
lserrlogbyvdisk command 213
lserrlogdumps command 214, 309
lsfabric command 215
lsfconsistgrp command 217
lsfcmmap command 220
lsfcmmapcandidate command 222
lsfcmmapdependentmaps command 224
lsfcmmapprogress command 223
lsfeaturedumps command 226
lsfeaturedumps commands 310
lsfreeextents command 227
lshbaportcandidate command 228
lshost command 229
lshostiogrp command 231
lshostvdiskmap command 233
lsiogrp command 234
lsiogrpcandidate command 238
lsiogrpghost command 236
lsiostatsdumps command 239, 311
lsiotracedumps command 240
lsiotracedumps commands 312
lslicense command 241
lsmdisk command 242
lsmdiskcandidate command 246
lsmdiskextent command 248
lsmdiskgrp command 250
lsmdiskmember command 252
lsmigrate command 254
lsnode command 255
lsnodecandidate command 258
lsnodes command 313
lsnodevdpd command 259, 314
lsrconsistgrp command 262
lsrrelationship command 265
lsrrelationshipcandidate command 268
lsrrelationshipprogress command 269
lssoftware.dumps command 270, 317
lssshkeys command 271
lstimezones command 272
lsvdisk command 273
lsvdiskdependentmaps command 277
lsvdiskextent command 277
lsvdiskfcmappings command 279
lsvdiskhostmap command 280
lsvdiskmember command 281
lsvdiskprogress command 283

M

managed disk commands
 chmdisk 123
 includemdisk 124
 setquorum 124
managed disk group commands
 addmdisk 115
 chmdiskgrp 116
 mkmdiskgrp 117
 rmmdisk 118
 rmmdiskgrp 120

- managed disk groups command
 - overview 115
- managed disks
 - viewing disks 242
 - viewing groups 250
- managed disks commands
 - overview 123
- master console
 - configuring 4
- MDisk *See* managed disks 123
- MDisks *See* managed disk groups 115
- Metro Mirror commands
 - chpartnership 145
 - chrconsistgrp 146
 - chrrelationship 147
 - mkpartnership 149
 - mkrconsistgrp 150
 - mkrrelationship 151
 - overview 145
 - rmpartnership 154
 - rmrconsistgrp 155
 - rmrrelationship 156
 - startcrconsistgrp 157
 - startcrrelationship 159
 - stoprcconsistgrp 161
 - stoprcrelationship 162
 - switchrconsistgrp 164
 - switchrrelationship 165
- migrateexts command 167
- migratetoimage command 169
- migratevdisk command 170
- migration 167
- migration commands
 - migrateexts 167
 - migratetoimage 169
 - migratevdisk 170
 - overview 167
- mkauth command 18
- mkemailuser command 28
- mkfconsistgrp command 129
- mkfcmmap command 130
- mkhost commands 91
- mkmdiskgrp command 117
- mkpartnership command 149
- mkrconsistgrp command 150
- mkrrelationship command 151
- mkvdisk commands 102
- mkvdiskhostmap command 107

N

- nodes
 - adding 38, 71
 - addnode command 38, 71
 - changing 46
 - chnode command 46
 - deleting 51, 78
 - rmnode command 51, 78
 - viewing 255, 313

O

- ordering publications xxviii
- overview 37, 65
 - audit log commands 11
 - cluster commands 37

- overview (*continued*)
 - cluster diagnostic and service-aid
 - commands 71
 - controller commands 319
 - e-mail commands 23
 - error log commands 287
 - featurization commands 293
 - FlashCopy commands 127
 - host commands 87
 - information commands 187
 - inventory event notification
 - commands 23
 - list dump commands 185
 - managed disk groups command 115
 - managed disks commands 123
 - migration commands 167
 - pscp application 9
 - role-based security commands 17
 - secure shell 3
 - secure shell key commands 297
 - service mode commands 301
 - service mode information
 - commands 307
 - tracing commands 173

P

- preparing
 - SSH client system 2
 - overview 1
- prestartfcconsistgrp command 134
- prestartfcmap command 135
- public secure shell keys 6
- publications
 - accessing 443
 - ordering xxviii
- PuTTY 5
 - configuring 5
 - generating a key pair 4
 - installing 1
 - scp (pscp) 9
 - SSH *See* secure shell 1

R

- related information xxiv
- restore command 68
- restore commands
 - clear 66
 - help 67
 - restore 68
- rmallsshkeys command 298
- rmauth command 19
- rmemailuser command 29
- rmfconsistgrp command 136
- rmfcmmap command 137
- rmhost command 93
- rmhostiogr command 94
- rmhostport command 95
- rmmdisk command 118
- rmmdiskgrp command 120
- rmnode command 51, 78
- rmpartnership command 154
- rmrconsistgrp command 155
- rmrrelationship command 156
- rmsshkey command 299

- rmvdisk command 109
- rmvdiskhostmap command 111
- Role based security commands
 - lsauth 20
 - mkauth 18
 - rmauth 19
- role-based security commands
 - overview 17

S

- SAN Volume Controller
 - console configuring 4
 - copying using PuTTY scp 9
- secure shell
 - adding keys 6, 7
 - client system 4
 - overview 1
 - configuring 4
 - creating keys 4
 - overview 3
 - PuTTY 5
- secure shell (SSH) keys
 - viewing 271
- secure shell key commands
 - addsshkey 297
 - overview 297
 - rmallsshkeys 298
 - rmsshkey 299
- security 3
- sendinventoryemail command 30
- service mode
 - commands 301
 - information commands 307
- service mode commands
 - applysoftware 301
 - cleardumps 302
 - dumperrlog 303
 - exit 304
 - overview 301
- service mode information commands
 - ls2145dumps 307
 - lsclustervpd 308
 - lserrlogdumps 309
 - lsfeaturedumps 310
 - lsiostatsdumps 311
 - lsiotracedumps 312
 - lsnodes 313
 - lsnodevpd 314
 - lssoftwaredumps 317
 - overview 307
- service-aid commands
 - dumperrlog 77
 - finderr 77
 - setevent 83
- setclustertime command 56
- setdisktrace command 173
- setemail command 31
- setevent command 83, 290
- setlocale command 84
- setpwdreset command 57
- setquorum command 124
- settimezone command 58
- settrace command 174
- shortcut keys 443
- showtimezone command 284
- shrinkvdisksize command 112

- software
 - copying using PuTTY scp 9
- software packages
 - listing 317
 - viewing 270
- SSH *See* secure shell 2, 3, 4, 6, 297
- startemail command 32
- startfcconsistgrp command 139
- startfcmap command 140
- starttrconsistgrp command 157
- starttrrelationship command 159
- startstats command 58
- starttrace command 176
- stopcluster command 61
- stopemail command 33
- stopfcconsistgrp command 142
- stopfcmap command 143
- stopprconsistgrp command 161
- stopprrelationship command 162
- stopstats command 63
- stoptrace command 177
- support
 - Web sites xxviii
- svqueryclock command 85
- switchrconsistgrp command 164
- switchrrelationship command 165
- syntax diagram xxix

T

- testemail command 33
- text emphasis xxiv
- time zones 272
- tracing commands
 - overview 173
 - setdisktrace 173
 - settrace 174
 - starttrace 176
 - stoptrace 177
- trademarks 447

V

- VDisks (virtual disks)
 - viewing 273
- VDisks *See* virtual disks 97
- viewing
 - clusters 192
 - featurization settings 293
 - Global Mirror
 - consistency groups 262
 - relationships 265
 - I/O groups 234
 - Metro Mirror
 - consistency groups 262
 - relationships 265
- virtual disk
 - viewing FlashCopy mappings 279
- virtual disk (VDisks) extent
 - viewing 277
- virtual disk commands
 - chvdisk 97
 - expandvdisksize 100
 - mkvdisk 102
 - mkvdiskhostmap 107
 - rmvdisk 109

- virtual disk commands (*continued*)
 - rmvdiskhostmap 111
 - shrinkvdisksize 112
- virtual disks
 - creating 102
- virtual disks commands
 - overview 97
- vital product data (VPD)
 - listing 308
 - viewing 259

W

- Web sites xxviii
- writeserenum command 85

Readers' Comments — We'd Like to Hear from You

IBM System Storage SAN Volume Controller
Command-Line Interface User's Guide
Version 4.2.1

Publication No. SC26-7903-02

We appreciate your comments about this publication. Please comment on specific errors or omissions, accuracy, organization, subject matter, or completeness of this book. The comments you send should pertain to only the information in this manual or product and the way in which the information is presented.

For technical questions and information about products and prices, please contact your IBM branch office, your IBM business partner, or your authorized remarketer.

When you send comments to IBM, you grant IBM a nonexclusive right to use or distribute your comments in any way it believes appropriate without incurring any obligation to you. IBM or any other organizations will only use the personal information that you supply to contact you about the issues that you state on this form.

Comments:

Thank you for your support.

Submit your comments using one of these channels:

- Send your comments to the address on the reverse side of this form.

If you would like a response from IBM, please fill in the following information:

Name

Address

Company or Organization

Phone No.

E-mail address



Fold and Tape

Please do not staple

Fold and Tape



NO POSTAGE
NECESSARY
IF MAILED IN THE
UNITED STATES

BUSINESS REPLY MAIL

FIRST-CLASS MAIL PERMIT NO. 40 ARMONK, NEW YORK

POSTAGE WILL BE PAID BY ADDRESSEE

International Business Machines Corporation
Information Development
Department 61C
9032 South Rita Road
Tucson, Arizona 85755-4401



Fold and Tape

Please do not staple

Fold and Tape



Printed in USA

SC26-7903-02



Spine information:



IBM System Storage SAN Volume
Controller

Command-Line Interface User's Guide

Version 4.2.1