

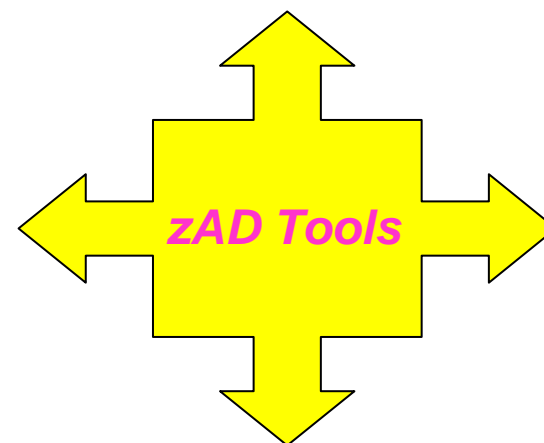

IBM Software Group

System z  
**CICS TOOLS**  
Try-n-Buy

August 24, 2006



@business on demand.

WebSphere. software

# Preface

The following are trademarks of International Business Machines Corporation in the United States, other countries, or both: IBM, CICS, CICS/ESA, CICS TS, CICS Transaction Server, CICSplex, DB2, MQSeries, OS/390, S/390, WebSphere, z/OS, zSeries, Parallel Sysplex.

Java, JavaBeans, and all Java-based trademarks and logos are trademarks of Sun Microsystems, Inc. in the United States, other countries, or both.

Microsoft, Windows, Windows NT, and the Windows logo are trademarks of Microsoft Corporation in the United States, other countries, or both.

Other company, product, and service names and logos may be trademarks or service marks of others.



# SPEAKERS

## David Tran

Systems z, Application Development Tools, Specialist, Americas

1-408-463-2636

[dmtran@us.ibm.com](mailto:dmtran@us.ibm.com)

## Colette Arena

Systems z, CICS Technical Sales Support

1-914-715-6384

[arenac@us.ibm.com](mailto:arenac@us.ibm.com)

## Steve Bryant

Systems z, CICS Technical Sales Support

1-901-762-5142

[Steven\\_Bryant@us.ibm.com](mailto:Steven_Bryant@us.ibm.com)





# Agenda

- **How to Trial the tools “Try-n-Buy”**
- **Tools Overview and Logical Grouping**
- **CICS Application Transformation**
  - ▶ CICS Business Event Publisher for MQSeries (BEP)
  - ▶ CICS Interdependency Analyzer (IA)
- **CICS Subsystem Management**
  - ▶ CICS Performance Analyzer (PA)
  - ▶ CICS Configuration Manager (CM)
- **CICS Data Management**
  - ▶ CICS Batch Application Control (BAC)
  - ▶ CICS VSAM Copy (VC)
  - ▶ CICS VSAM Recovery (VR)



# Enterprise Application Lifecycle Portfolio

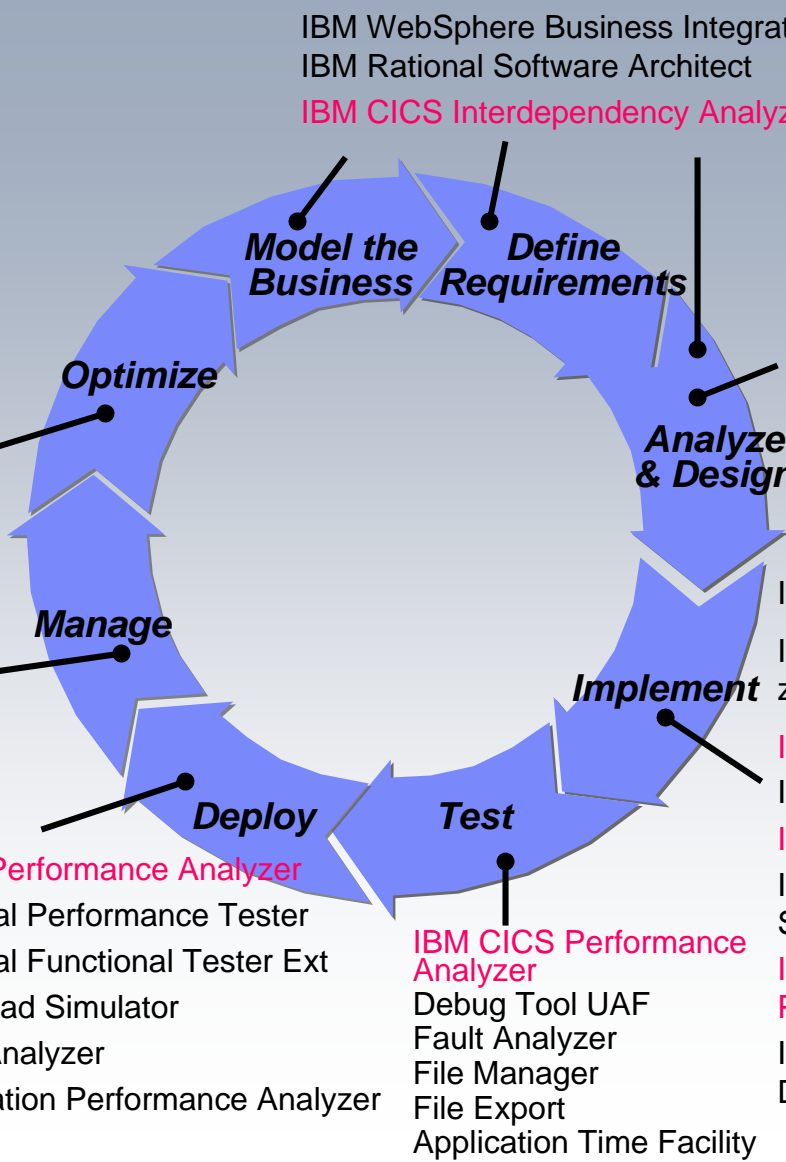
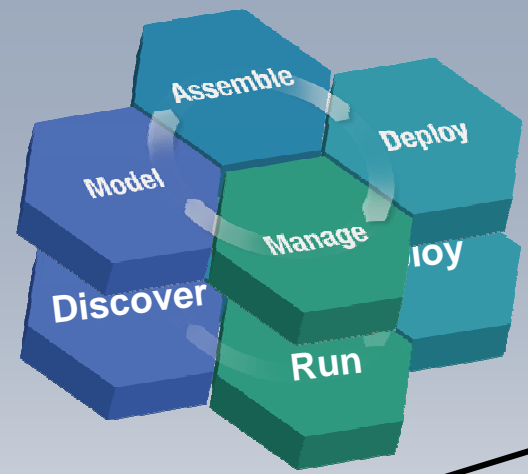

IBM WebSphere Business Integration Modeler  
 IBM Rational Software Architect  
 IBM CICS Interdependency Analyzer

IBM WebSphere Business Modeler  
 IBM Rational Software Architect  
 IBM WebSphere Asset Analyzer  
 IBM Asset Transformation Workbench

IBM Rational Application Developer  
 IBM WebSphere Developer for z/Series

IBM CICS VSAM Transparency  
 IBM Rational Software Architect  
 IBM CICS VSAM Copy  
 IBM WebSphere Developer for System z  
 IBM CICS Business Event Publisher  
 IBM WebSphere Integration Developer

IBM Session Manager  
 CICS Online Transmission Time Optimizer  
 IBM Batch Application Control  
 IBM CICS Configuration Manager  
 IBM VSAM Recovery  
 SCLM AE  
 Rational ClearCase  
 Rational ClearQuest  
 Tivoli Composite Application Manager for WebSphere  
 Tivoli Composite Application Manager for SOA \*  
 Tivoli Federated Identity Manager

CICS Performance Analyzer  
 Rational Performance Tester  
 Rational Functional Tester Ext  
 Workload Simulator  
 Fault Analyzer  
 Application Performance Analyzer

IBM CICS Performance Analyzer  
 Debug Tool UAF  
 Fault Analyzer  
 File Manager  
 File Export  
 Application Time Facility

# CICS TOOLS Try-n-Buy



- Easy click registration & download
  - Includes Terms & Conditions for evaluation of tools
  - 30 day evaluation
- Try one or all seven
- Webcast hints and tips
- 24 hr response to Q&A WW
- On-site assistance

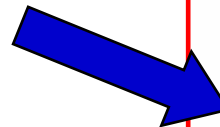

IBM System z Software  
Trial Code Download



**Make the most of your CICS efficiency, availability and skills**

**Free CICS Tools Trial Code**  
Available for a limited time: End date November 15, 2006

Download now at [ibm.com/software/os/zseries/trials/cicstools/](http://ibm.com/software/os/zseries/trials/cicstools/)

IT organizations are under constant pressure from business to improve platform efficiency, maximize system availability, and make the most of staff skills. The pressure is even more acute with CICS® because it's also recognized as a critical component of future Web services implementations. IBM offers a suite of CICS tools that can help support application transformation and CICS technology-based SOA implementations; enable easier CICS version-to-version upgrades (especially to CICS Transaction Server for z/OS V3.1); reduce the complexity and cost of CICS system and application management; improve CICS application and data availability; and, comply with regulations such as the U.S. Sarbanes-Oxley Act.

- **CICS Batch Application Control** – Simplify and automate management of resource allocation between online CICS and batch
- **CICS Business Event Publisher for MQSeries®** – Drive new business processes from CICS applications and DB2® and IMS™ data to new environments, via WebSphere® MQ, without the need to change the original applications or data
- **CICS Configuration Manager** – Manage resource definitions in the multiple CICS systems, from a single interface, with comprehensive reporting and optional change management control facilities
- **CICS Interdependency Analyzer** – Understand your active application inventory for efficient maintenance, upgrades and help in building new applications
- **CICS Performance Analyzer** – Comprehensive offline performance reporting and analysis for tuning and capacity planning
- **CICS VSAM Copy** – Create point-in-time copies of VSAM files concurrent with business-critical online processing activity
- **CICS VSAM Recovery** – Automate recovery of lost and damaged CICS and batch VSAM data

Download your free CICS Tools trial code today at [ibm.com/software/os/zseries/trials/cicstools/](http://ibm.com/software/os/zseries/trials/cicstools/)

Find more information, visit [ibm.com/software/http/cics/tools/](http://ibm.com/software/http/cics/tools/)



© Copyright IBM Corporation 2006

CICS, DB2, IBM, the IBM logo, IMS, MQSeries, System z, WebSphere and zSeries are trademarks or registered trademarks of International Business Machine Corporation in the United States, other countries or both. Other company, product and service names may be trademarks or service marks of others. All rights reserved.





# Agenda

- **Tools Overview and Logical Grouping**
- **CICS Application Transformation**
  - ▶ **CICS Business Event Publisher for MQSeries (BEP)**
  - ▶ CICS Interdependency Analyzer (IA)
- **CICS Subsystem Management**
  - ▶ CICS Performance Analyzer (PA)
  - ▶ CICS Configuration Manager (CM)
- **CICS Data Management**
  - ▶ CICS Batch Application Control (BAC)
  - ▶ CICS VSAM Copy (VC)
  - ▶ CICS VSAM Recovery (VR)



# CICS Business Event Publisher for MQSeries V1R2 (5655-J99)

- **Create and manage outbound events using WebSphere MQ without changing existing CICS applications**
- Integrate z/OS applications and data to new environments (CICS, IMS and DB2 events)
- Create MQPUT messages for MQSeries queue from events and associated information
- Based on user-specified message content rules, Queue names and MQPUT options
- Provides easy to use workstation GUI for selection and rules creation
- Real time action and results
- Offers low cost, low risk integration strategy





# CICS Business Event Publisher for MQSeries

## *Value:*

- No change to existing application programs or data
- Extends z/OS applications to new environments

## *CICS BEP scenarios:*

- Event notification – new customer added, account = zero
- Activity Audits – who, what, when is accessing the file?
- Error notification – create message when error detected
- Threshold notification – stock running low
- Automation – removal of manual or latency in business process
- Data source for Message Brokers
- Data transfer
- External logging or notification



# CICS Business Event Publisher for MQSeries

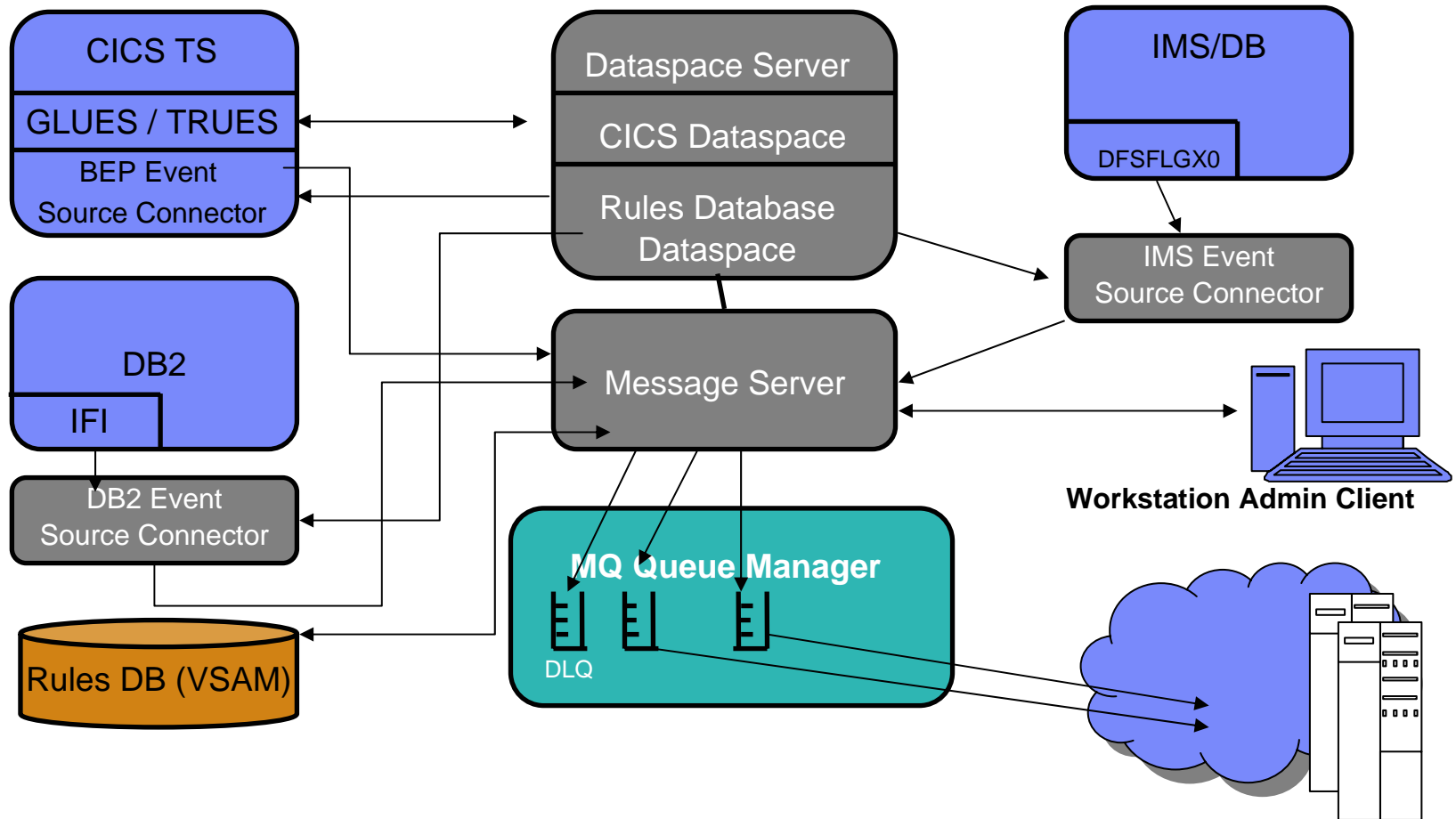



# Agenda

- **Tools Overview and Logical Grouping**
- **CICS Application Transformation**
  - ▶ CICS Business Event Publisher for MQSeries (BEP)
  - ▶ **CICS Interdependency Analyzer (IA)**
- **CICS Subsystem Management**
  - ▶ CICS Performance Analyzer (PA)
  - ▶ CICS Configuration Manager (CM)
- **CICS Data Management**
  - ▶ CICS Batch Application Control (BAC)
  - ▶ CICS VSAM Copy (VC)
  - ▶ CICS VSAM Recovery (VR)



# CICS Interdependency Analyzer V2R1 (5655-G77)

- **Run-time and batch reporting tool that captures resource relationships:**
  - ▶ which resources (Programs, Files, TSQs TDQs etc) are required by a transaction
  - ▶ which programs have affinities due to the CICS API commands within them
  - ▶ which transactions have affinities to other transactions or particular CICS regions
  - ▶ what is the sequencing of transactions within an application
  - ▶ which resources are no longer used
- Relationship data loaded onto a DB2 data base. Query interface and sample queries are provided for comprehensive analysis.
- Includes CICS, DB2, WebSphere MQ, and IMS DB resources



# CICS Interdependency Analyzer

## *Value:*

- Replaces manual documentation
- Identifies opportunities for threadsafe
- Reduces testing for V to V migration

## *CICS IA scenarios:*

- Documentation or source code is missing
- Changes to applications have not been documented
- You are providing outsourcing services, and need a complete picture of CICS resource relationships in your customer systems
- You have been through a merger/acquisition, so the information about inherited CICS systems is not available
- You are implementing workload balancing and need to identify affinities



# CICS Interdependency Analyzer

## *Value of being threadsafe:*

- Reduces overall CPU consumption
- Increases CICS throughput by reducing response time

## *How IA will help you get to threadsafe:*

- CICS/IA reports the current TCB mode for each EXEC CICS (or DB2, MQ, DLI) call.
- Users who are converting their programs to thread safe can use this during testing to assist in finding out which TCB modes their program runs in. This would help in identifying programs that have CICS API calls that are not thread safe and cause TCB mode swapping.





# Agenda

- **Tools Overview and Logical Grouping**
- **CICS Application Transformation**
  - ▶ CICS Business Event Publisher for MQSeries (BEP)
  - ▶ CICS Interdependency Analyzer (IA)
- **CICS Subsystem Management**
  - ▶ **CICS Performance Analyzer (PA)**
  - ▶ CICS Configuration Manager (CM)
- **CICS Data Management**
  - ▶ CICS Batch Application Control (BAC)
  - ▶ CICS VSAM Copy (VC)
  - ▶ CICS VSAM Recovery (VR)



# CICS Performance Analyzer V1R4 (5655-F38)

- **Off-line performance reporting and analysis tool:**
  - ▶ Complements your existing online monitor
  - ▶ Reports on CICS as well as CICS related subsystems including DB2, WebSphere MQ, and IMS .
  - ▶ Uses SMF data (110 records for CICS, 101's for DB2 , 116's for MQ)
  - ▶ Provides end to end detailed performance bottleneck analysis to assist in tuning CICS systems
  - ▶ Review application performance and identify potential to improve application design
  - ▶ Provides capacity planning and trend analysis
  - ▶ Identifies trends leading to poor CICS performance or even outages





# CICS Performance Analyzer

## *Value:*

- Ease of use with ISPF dialogs that help you to build, maintain, and submit reports, includes extensive online help and field descriptions
- Provides over 140 sample reports for immediate productivity and reporting capability
- No additional setup or customization required – processes existing SMF data
- Provides a variety of reports including Extensive Tabular Reports and Graph Reports
- Provides cross-system performance analysis for MRO and ISC
- Provides cost effective software solution for trend analysis



# CICS PA Overview

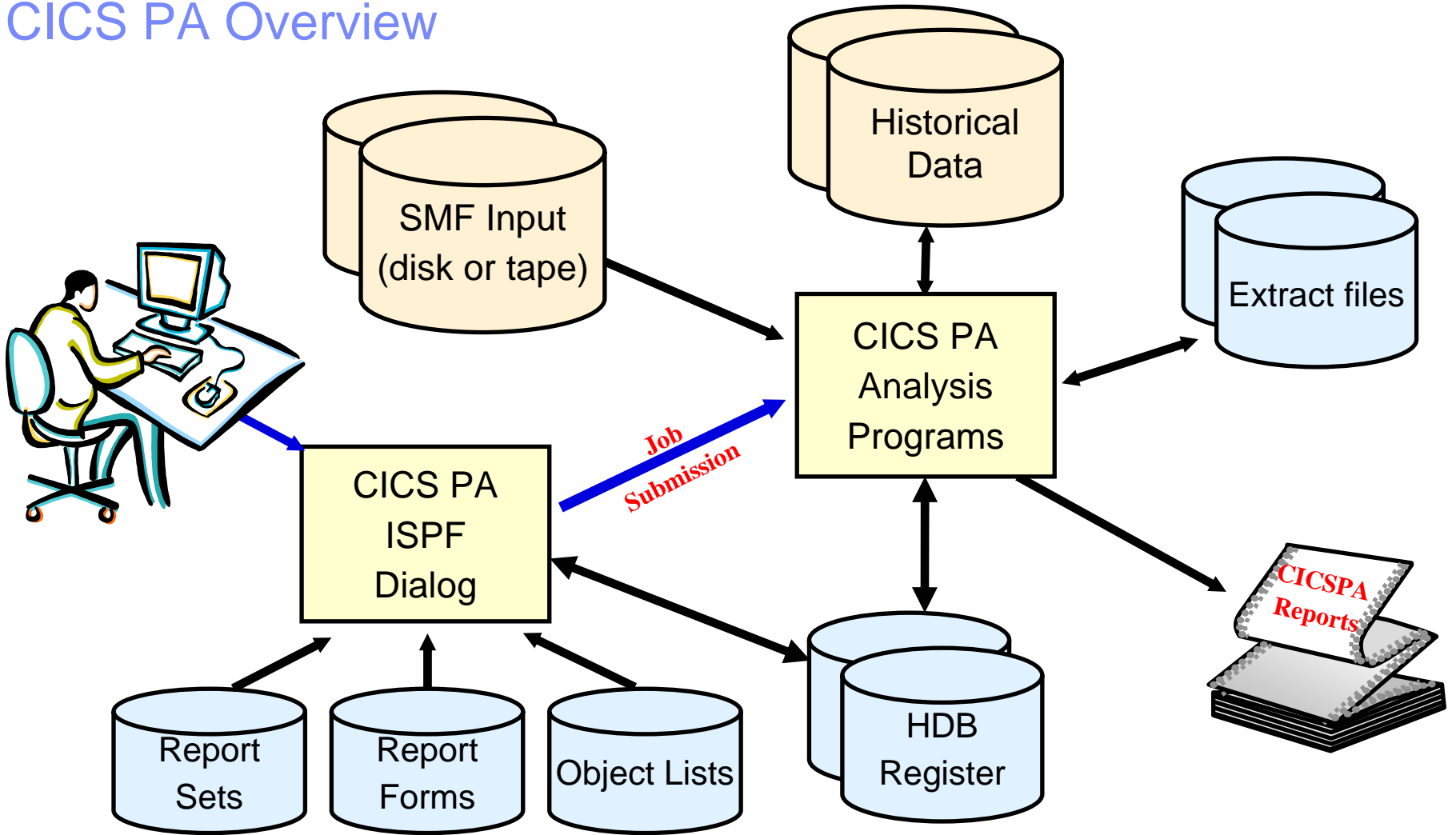



# Agenda

- **Tools Overview and Logical Grouping**
- **CICS Application Transformation**
  - ▶ CICS Business Event Publisher for MQSeries (BEP)
  - ▶ CICS Interdependency Analyzer (IA)
- **CICS Subsystem Management**
  - ▶ CICS Performance Analyzer (PA)
  - ▶ **CICS Configuration Manager (CM)**
- **CICS Data Management**
  - ▶ CICS Batch Application Control (BAC)
  - ▶ CICS VSAM Copy (VC)
  - ▶ CICS VSAM Recovery (VR)



# CICS Configuration Manager V1R2 (5697-I78)

- **Manages, replicates, and deploys CICS resource definitions across CICS regions including regions that are controlled by CICSplex SM**
- You can use CICS Configuration Manager to:
  - Edit/compare resource definitions
  - Report on resource definitions that match specified criteria
  - Migrate resource definitions from one CICS System Definition (CSD) file or CICSplex SM context to another
  - Back out migrations
- Includes change management feature where approval is required from authorized users before migrating definitions
- Includes audit trail capability where reports can be generated and changes backed out to any previous version of the definitions
- Includes disaster recovery capability to distribute CICS resources across multiple sites using an integrated export and import function



# Migration Scenario

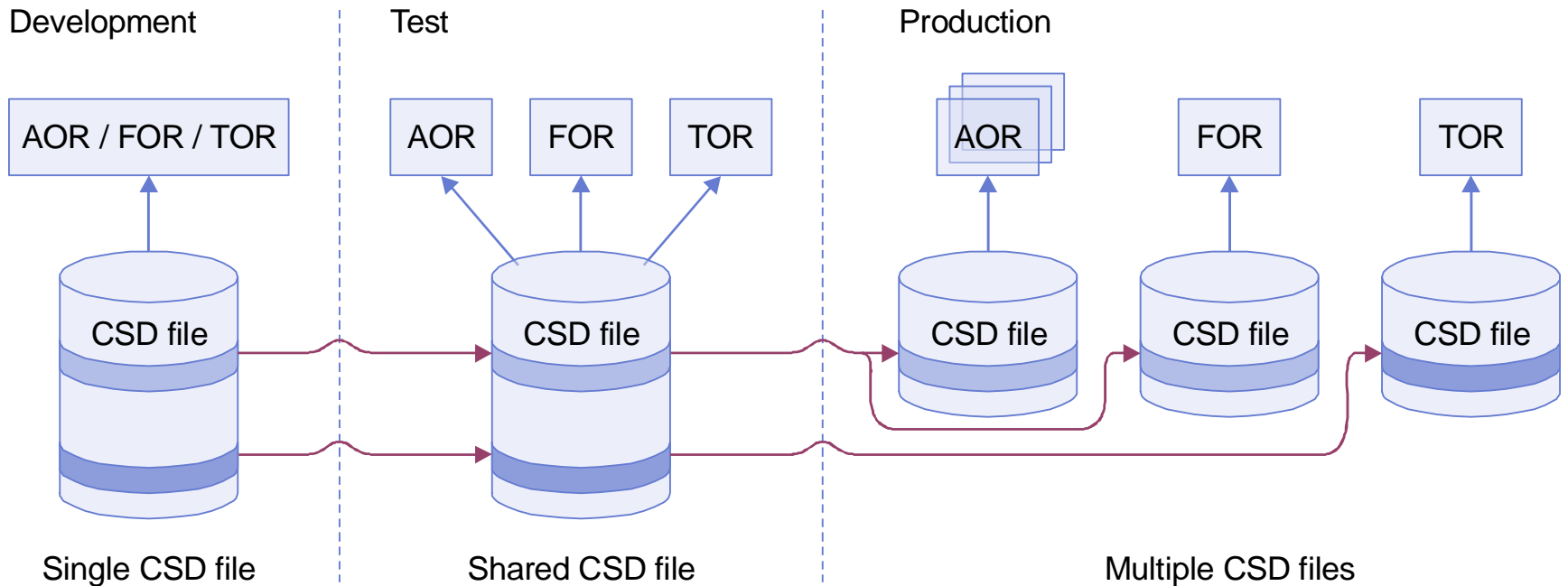

# CICS Configuration Manager

## *Value:*

- A common interface to CSD files and CICSplex SM contexts
- One single command to copy a set of resource definitions across multiple CICS configurations
- No dependency on CICS regions being up to make changes
- Allows systems staff to maintain control of the CICS environment and give applications staff the ability to define application resources if they choose
- Audit trail key for Sarbanes Oxley
- Approval/disapproval of changes key for Change Management



# CICS CM Flow

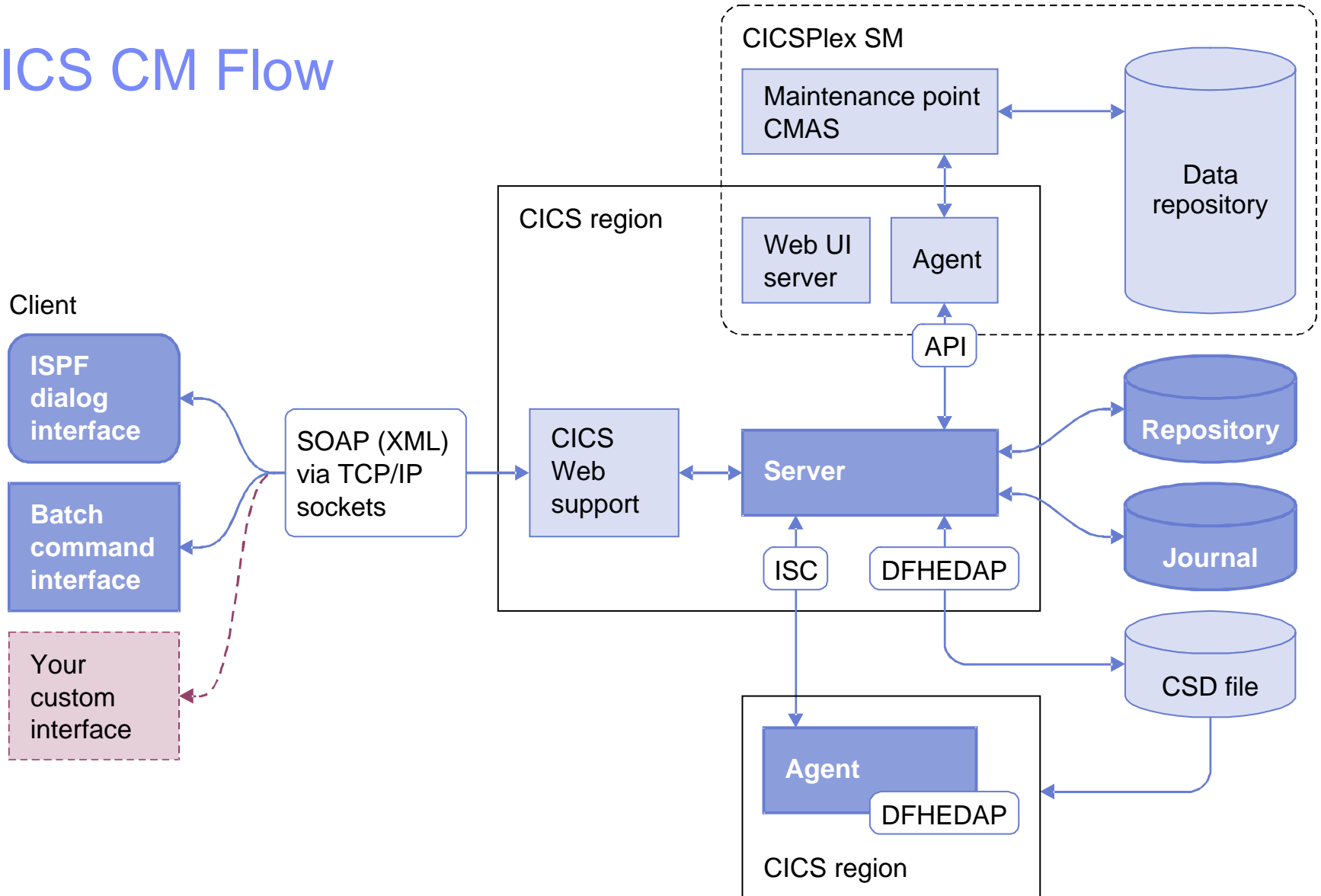



# Agenda

- **Tools Overview and Logical Grouping**
- **CICS Application Transformation**
  - ▶ CICS Business Event Publisher for MQSeries (BEP)
  - ▶ CICS Interdependency Analyzer (IA)
- **CICS Subsystem Management**
  - ▶ CICS Performance Analyzer (PA)
  - ▶ CICS Configuration Manager (CM)
- **CICS Data Management**
  - ▶ **CICS Batch Application Control (BAC)**
  - ▶ CICS VSAM Copy (VC)
  - ▶ CICS VSAM Recovery (VR)





# CICS Batch Application Control V1R1 (5697-I94)

- **What does it do?**

- ▶ Dynamic control of CICS resources
- ▶ Simplifies and automates the transitions between batch and CICS application access to the same resources
- ▶ Enables a batch-job step to change the state of relevant CICS resources
- ▶ Tracks resource state change requests across CICS systems and batch streams and helps ensure each resource is in its correct state when CICS regions start

- **Benefits?**

- ▶ Helps reduce errors and abends related to batch processing
- ▶ Minimizes manual interventions by operators and system programmers
- ▶ Moves your CICS applications closer to 24x7 availability
- ▶ Helps you lower the total cost of ownership of your zSeries platform



# CICS Batch Application Control

- Enables a batch-job step to change the state of relevant CICS resources
- Tracks resource state change requests across participating CICS systems and batch stream
- Ensures resources are in their correct state when CICS regions start
- Powerful “group” feature enables a job step to change the state of all resources associated with an application

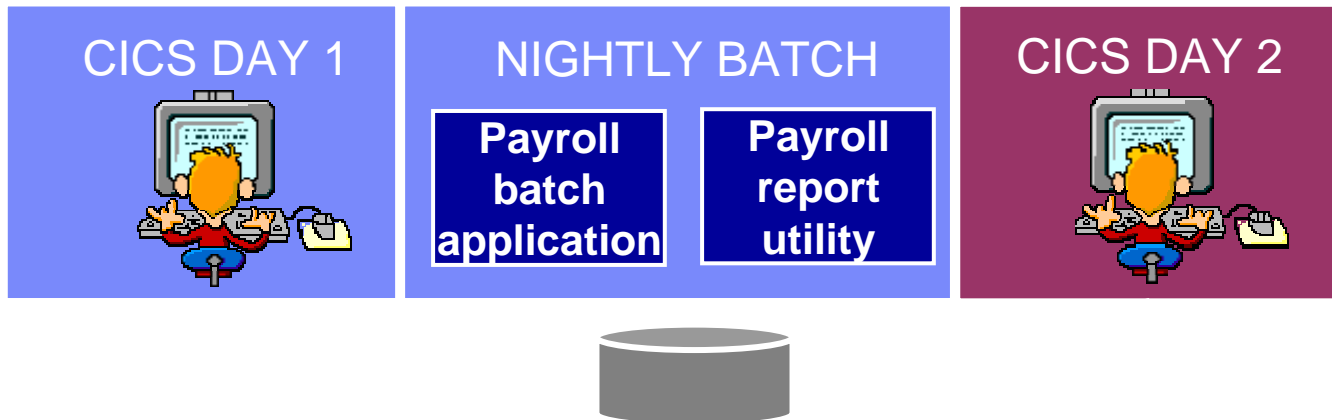



# Agenda

- **Tools Overview and Logical Grouping**
- **CICS Application Transformation**
  - ▶ CICS Business Event Publisher for MQSeries (BEP)
  - ▶ CICS Interdependency Analyzer (IA)
- **CICS Subsystem Management**
  - ▶ CICS Performance Analyzer (PA)
  - ▶ CICS Configuration Manager (CM)
- **CICS Data Management**
  - ▶ CICS Batch Application Control (BAC)
  - ▶ **CICS VSAM Copy (VC)**
  - ▶ CICS VSAM Recovery (VR)



# CICS VSAM Copy for z/OS V1R1 (5655-L67)

- **What does it do?**
  - ▶ Creates CONSISTENT copies of VSAM data sets
    - While they remain online and open to CICS for update
    - While they are closed to CICS
  
- **Benefits?**
  - ▶ Creates ad-hoc copies of VSAM data sets
    - Without affecting current performance of running CICS applications
    - Produced copies are consistent (no incomplete units of work)
  - ▶ Reporting of production data
  - ▶ Testing new applications with production data
  - ▶ Copying production data for input to other non-CICS applications



# CICS VSAM Copy for z/OS

- Supports KSDS, ESDS, RRDS, and VRRDS VSAM
- Supports copying a VSAM KSDS base cluster with alternate indices
- Automatically determines if the data set is online or offline to CICS before copy
- Includes best of both worlds
  - ▶ Create consistent copies of VSAM data sets
  - ▶ Create copies of data sets while online to CICS for update
  - ▶ Copy multiple VSAM data sets in one run
  - ▶ No degradation to performance of running CICS transactions





# Agenda

- **Tools Overview and Logical Grouping**
- **CICS Application Transformation**
  - ▶ CICS Business Event Publisher for MQSeries (BEP)
  - ▶ CICS Interdependency Analyzer (IA)
- **CICS Subsystem Management**
  - ▶ CICS Performance Analyzer (PA)
  - ▶ CICS Configuration Manager (CM)
- **CICS Data Management**
  - ▶ CICS Batch Application Control (BAC)
  - ▶ CICS VSAM Copy (VC)
  - ▶ **CICS VSAM Recovery (VR)**

# CICS VSAM Recovery for z/OS V4R1 (5655-P30)

## ▪ **What does it do?**

- ▶ Enables recovery of lost or damaged VSAM files
- ▶ Automatically detects VSAM errors and starts corrective action
- ▶ Automates the creation of batch recovery jobs
- ▶ Supports forward recovery for both CICS and batch VSAM
- ▶ Enhances disaster recovery by providing the capability to forward recover VSAM data sets at a remote recovery site
- ▶ Integrates with ISMF

## ▪ **Benefits?**

- ▶ Provides a VSAM recovery environment very similar to DB2
- ▶ Complete history of all VSAM backups and updates
- ▶ Simplifies your Disaster Recovery process for VSAM files
- ▶ Reduce nightly batch windows by eliminating multiple VSAM copies of critical files



# Customer Batch Window Reduction



## CICS VR Option #1 and #2

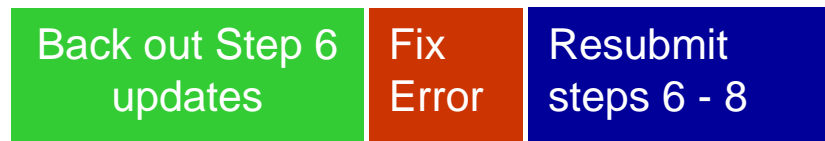
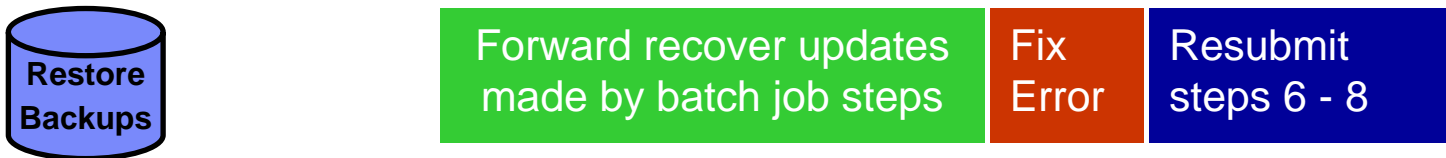



## CICS VR Release History

- CICS VR 4.1 – GA December 2005
- CICS VR 3.3 – GA September 2004
- CICS VR 3.2 – GA March 2003
- CICS VR 3.1 – GA December 2001
- CICS VR 2.x – GA 1990's
- CICS VR 1.1 – GA August 1987



# SUMMARY

CICS tools web site, including library

[www.ibm.com/software/http/cics/tools](http://www.ibm.com/software/http/cics/tools)

**Free 60 day CICS Tools Trial Code**

Download now at:

[ibm.com/software/os/zseries/trials/cicstools/](http://ibm.com/software/os/zseries/trials/cicstools/)

**IBM System z Software  
Trial Code Download**

**Make the most of your CICS efficiency, availability and skills**

**Free CICS Tools Trial Code**  
Available for a limited time. End date November 15, 2006.  
Download now at [ibm.com/software/os/zseries/trials/cicstools/](http://ibm.com/software/os/zseries/trials/cicstools/)

IT organizations are under constant pressure from business to improve platform efficiency, maximize system availability and make the most of staff skills. The pressure is even more acute with CICS® because it's also recognized as a critical component of future Web services implementations. IBM offers a suite of CICS tools that can help support application transformation and CICS technology-based SOA implementations; enable easier CICS version-to-version upgrades (especially to CICS Transaction Server for z/OS V31); reduce the complexity and cost of CICS system and application management; improve CICS application and data availability; and, comply with regulations such as the U.S. Sarbanes-Oxley Act.

- **CICS Batch Application Control** – Simplify and automate management of resource allocation between online CICS and batch
- **CICS Business Event Publisher for MGSeries®** – Drive new business processes from CICS applications and DB2® and IMS® data to new environments, via WebSphere® MQ, without the need to change the original applications or data
- **CICS Configuration Manager** – Manage resource definitions in the multiple CICS systems, from a single interface, with comprehensive reporting and optional change management control facilities
- **CICS Interdependency Analyzer** – Understand your active application inventory for efficient maintenance, upgrades and help in building new applications
- **CICS Performance Analyzer** – Comprehensive offline performance reporting and analysis for tuning and capacity planning
- **CICS VSAM Copy** – Create point-in-time copies of VSAM files concurrent with business-critical online processing activity
- **CICS VSAM Recovery** – Automate recovery of lost and damaged CICS and batch VSAM data

Download your free CICS Tools trial code today at [ibm.com/software/os/zseries/trials/cicstools/](http://ibm.com/software/os/zseries/trials/cicstools/)

Find more information, visit [ibm.com/software/http/cics/tools/](http://ibm.com/software/http/cics/tools/)

© Copyright IBM Corporation 2006  
CICS, DB2, IBM, the IBM logo, IMS, MGSeries, System z, WebSphere and zSeries are trademarks or registered trademarks of International Business Machine Corporation in the United States, other countries or both. Other company, product and service names may be trademarks or service marks of others. All rights reserved.



# Upcoming Event

## IBM Event Publishing Tools Webcast - Customer Scenarios and Solutions

Broadcast date: August 31, 2006,  
1:00 - 2:30 p.m., EDT

Register now at

[http://www.ibm.com/software/zseries/  
telecon/31aug](http://www.ibm.com/software/zseries/telecon/31aug)

IBM System z™ Software Teleconference

Teleconference - August 31, 2006

### IBM Event Publishing Tools - Customer Scenarios and Solutions

Service oriented architecture (SOA) offers a deep well of opportunities that most businesses are just beginning to explore. If you want to get full flexibility from it, try taking advantage of the SOA event-driven architecture. It supports z/OS® event-driven scenarios – without changes to existing application code.

Event Detection and Publishing is a new approach within SOA that gives you a non-intrusive way to unlock the power of z/OS applications and data. It provides immediate detection of, and immediate action on, application and data events with no change requirements to underlying code. CICS®, DB2®, IMS, VSAM, CA-IDMS, Adabas and other customers can use its set of constructs – run-time artifacts, tools, APIs – to support event-driven customer scenarios. By reusing your existing code, you can drive additional processing and realize considerable savings in cost, time and resources.

#### Teleconference

Join us for this teleconference and learn how IBM z/OS Event Publishing toolset can help you:

- Use core z/OS applications to leverage new business opportunities or new technology
- Distribute CICS, VSAM, DB2, IMS™, CA-IDMS, Adabas and other database information without rewriting code
- Deliver external event logging or notification of CICS, DB2 or IMS activity
- Extend data from the mainframe to other databases more efficiently

**Speakers:** Dot Alexander, Vice President, System z Software, Americas  
Satish Tanna, Senior IT Specialist, Technical Specialist for CICS z/OS Tools

Karen Durward, Information Management, WebSphere II Product Management

**Broadcast date:** August 31, 2006, 1:00 - 2:30 p.m., Eastern Daylight Time

**Developed for:** CICS and database application developers and managers, and IT architects

**Technical level:** Intermediate

[Register online right now](#)

Register now for this informative teleconference  
[ibm.com/software/zseries/telecon/31aug](http://ibm.com/software/zseries/telecon/31aug)

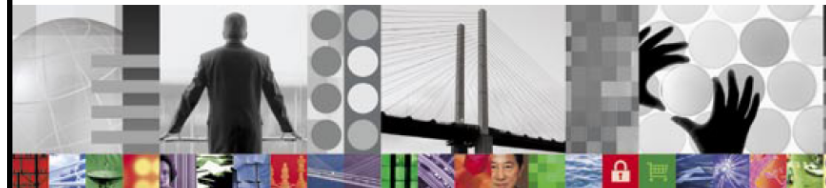

Copyright © 2006 IBM Corporation.

CICS, DB2, IBM, the IBM logo, IMS, the On Demand Business logo, System z, z/OS and zSeries are registered trademarks of International Business Machines Corporation in the United States, other countries or both.

Other company, product and service names may be trademarks or service marks of others. All rights reserved.

ON DEMAND BUSINESS™



# Polling Questions

- **Do you think you will go to Try- It- You'll- Love-It site and download at least one of the CICS Tools for an evaluation?**
  - ▶ 1 – Yes
  - ▶ 2 – No
  
- **Would you like more information on Business Event Publisher?**
  - ▶ 1 – Yes
  - ▶ 2 – No
  
- **Would you like more information on CICS Interdependency Analyzer?**
  - ▶ 1 – Yes
  - ▶ 2 – No
  
- **Would you like more information on CICS Performance Analyzer?**
  - ▶ 1 – Yes
  - ▶ 2 – No
  
- **Would you like more information on CICS Configuration Manager?**
  - ▶ 1 – Yes
  - ▶ 2 – No
  
- **Would you like more information on CICS Batch Application Control?**
  - ▶ 1 – Yes
  - ▶ 2 – No
  
- **Would you like more information on CICS VSAM Copy?**
  - ▶ 1 – Yes
  - ▶ 2 – No
  
- **Would you like more information on CICS VSAM Recovery?**
  - ▶ 1 – Yes
  - ▶ 2 – No



## Question and Answer



**Live on call or email [dmtran@us.ibm.com](mailto:dmtran@us.ibm.com)**

