



Deploying new applications on the mainframe

Bill Jones
wgjones@us.ibm.com

SOA on your terms and our expertise



SOA requires a robust, secure deployment environment



IBM WebSphere Application Server V6

The Industry's leading application server for building, running & managing business-critical application services

- 1** **Build** and **deploy** applications quickly and with ease
- 2** **Run** services in the most secure, scalable, highly available environment
- 3** **Reuse & create** Java assets and extend their reach
- 4** **Manage** applications effortlessly
- 5** **Grow** as needs evolve, leveraging core skills and assets

zSeries is the fastest growing WebSphere platform for 2005



Build and deploy applications quickly and with ease



Reduce the programming steps to build an application by up to 75 % by leveraging development and deployment enhancements

Ease of use in the development process:

- Comprehensive portfolio of tools deploy directly to WebSphere Application Server
- Rapidly build user interfaces with Java Server Faces
- Simplify access to heterogeneous data sources using Service Data Objects

Ease of use for the deployment process:

- WebSphere Rapid Deployment
- Fine grained application updates

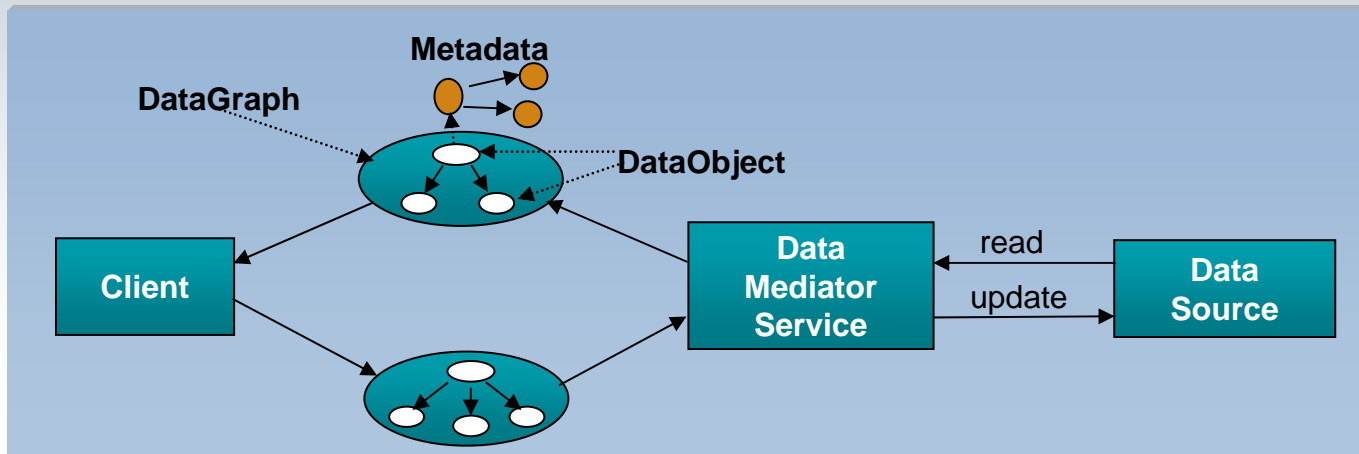

Reuse Java assets and extend their reach



Increase return on investment and lower total cost of ownership by reusing existing IT assets with comprehensive support for Web Services standards

Open standards – such as J2EE 1.4 – enable cost effective planning for future growth

- Web services loosely integrate disparate resources - both new and existing
- Create building blocks for new business applications

Comprehensive support for Web Services

- Standards like JAX-RPC, SAAJ & WS* provide a structure for interconnecting services
- UDDI V3 provides a secure means of discovering and describing Web services
- Web Services Gateway provides a programmable “Firewall” and “Broker” for Web Services
 - Service mapping and protocol transformation; Access control, Audit, Usage log, Non-repudiation...

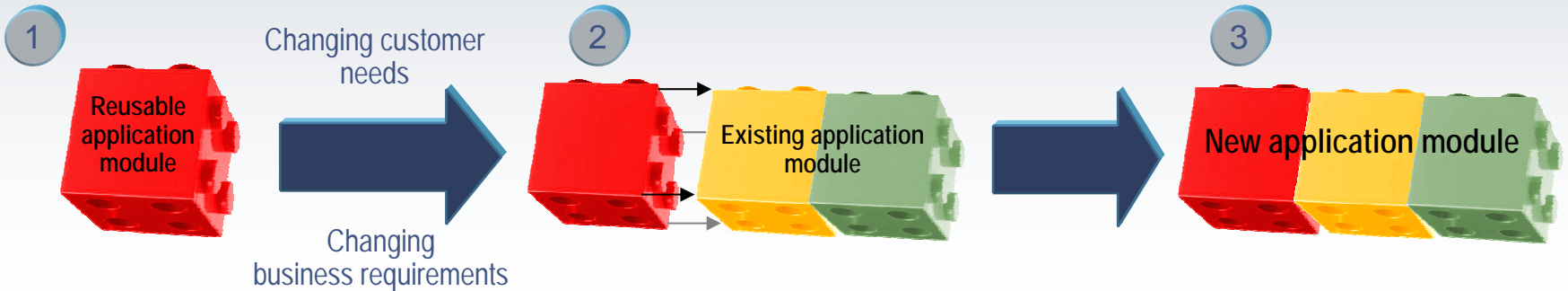

Run services in the most secure, reliable deployment environment

*Eliminate downtime of business-critical applications that can cost as much as
\$10,000 per minute*

Key component of a High Availability (HA) solution

- Built-in High Availability Manager eliminates single point of failure and is easily configured/deployed
 - Hot standby and peer failover for critical services like Transaction Manager, Messaging..
- Advanced clustering configuration options
- Leverage fault tolerant storage technologies such as Network Attached Storage to lower the cost and complexity of HA configurations

Resilient application server security implementation

- Comprehensive support for Security Standards
 - Full J2EE security model
 - Web Services security
 - SSL channel framework
 - Government security standards support
 - FIPS 140-2, Common Criteria Assurance Level 4

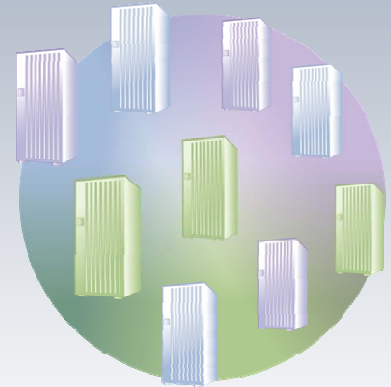

Manage Applications Effortlessly



Manage complex, dynamic IT environments simply and efficiently, while building skills that can be reused across other WebSphere products

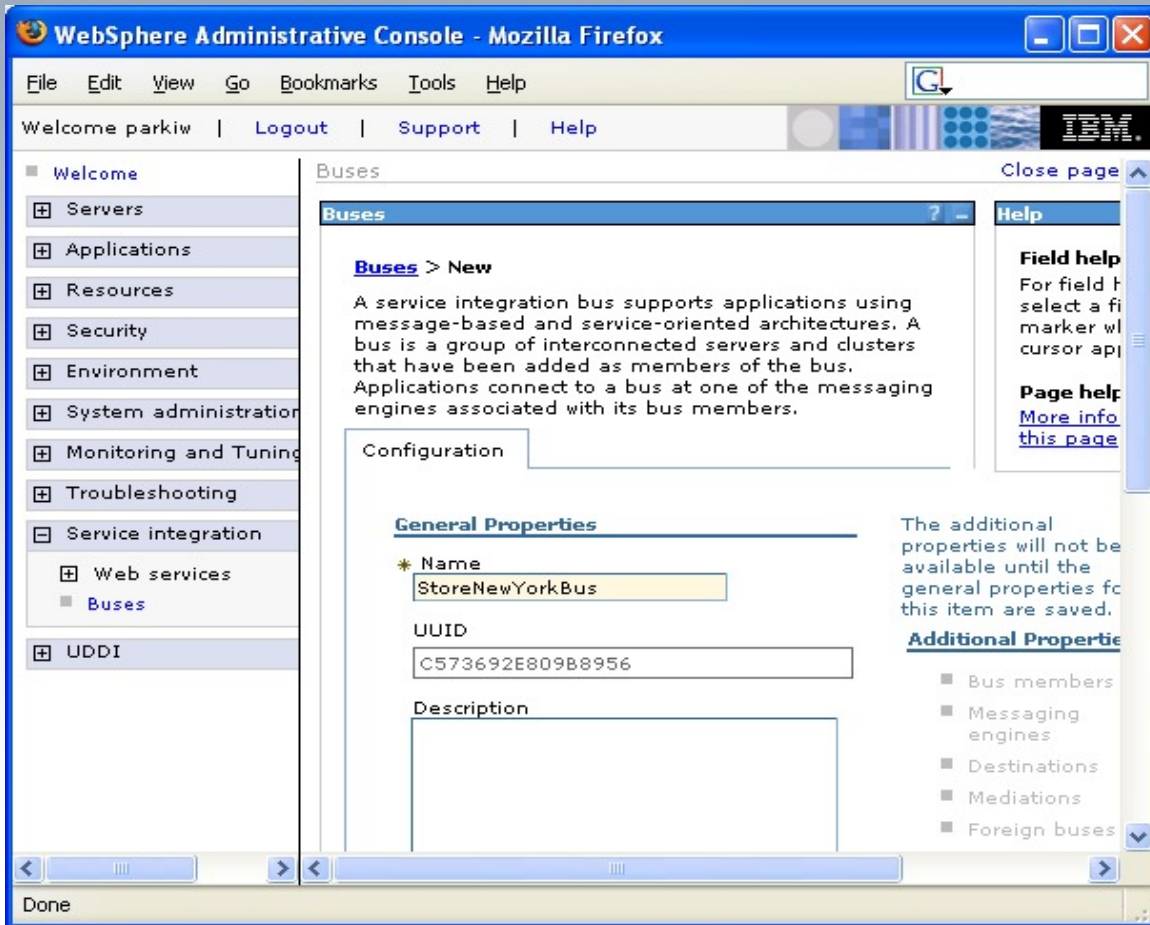

- Administrative Console can be accessed by the Administrator via a Web browser.
- Allows user to navigate through a tree of panels
- Admin support for mixed platforms and versions
- Ability to manage WebSphere Application Server and other WebSphere products from a single console
- Fine grained application updates

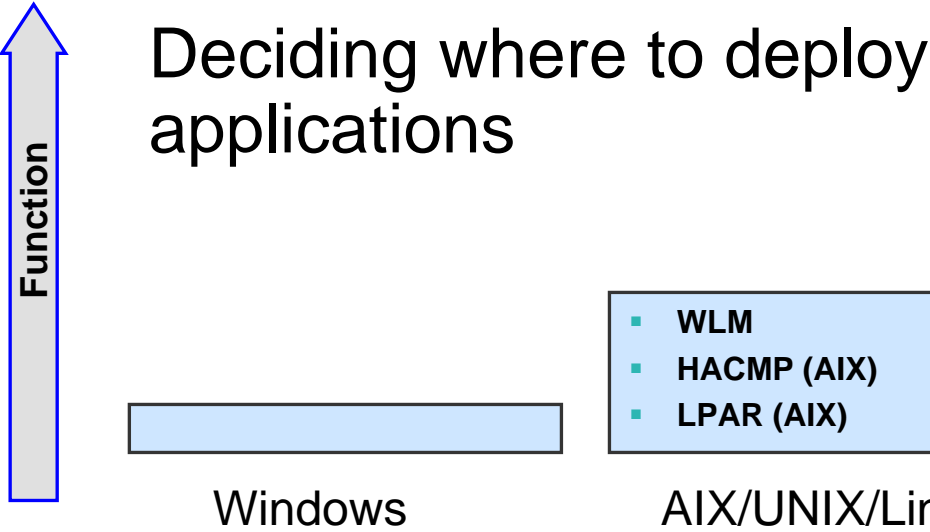

The first step in deciding where to run your applications is evaluating your platform options based on the needs of your application

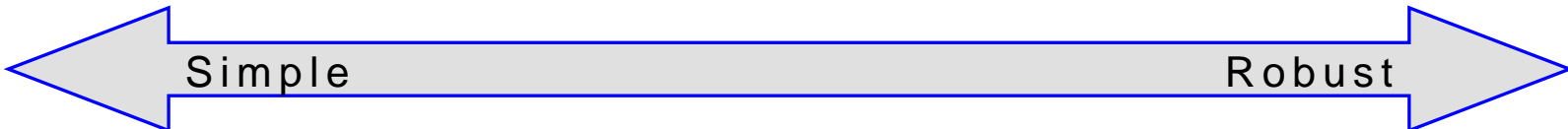

✓ Little OS function

✓ Simple Workload management

✓ Resource provisioning on demand

✓ Availability

✓ Zero downtime

✓ Some virtualization of resources

✓ Prioritization of diverse workloads

✓ Support for complex transactions

✓ Stalwart security model

Watch terminology - **Not** equivalent across platforms

Deciding where to deploy applications: *Factoring in the value of the application server*



The second step in deciding where to run your applications is evaluating your application server options

Windows

- WAS delivers:**
- High availability
 - Clustering
 - J2EE 1.4
 - Web Services
 - Security
 - Messaging

AIX/UNIX/Linux

- WAS delivers:**
- High availability
 - Clustering
 - J2EE 1.4
 - Web Services
 - Security
 - Messaging

z/OS

- WAS delivers:**
- High availability
 - Clustering
 - J2EE 1.4
 - Web Services
 - Security
 - Messaging
 - Platform optimization
 - ✓ Mainframe security
 - ✓ Sysplex support
 - ✓ z/OS WLM architected inside
 - ✓ Tight integration with DB2, CICS
 - ✓ Complex transaction support

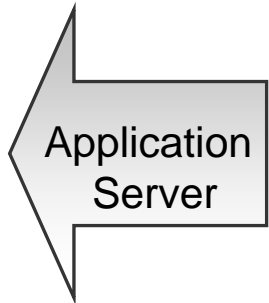

WebSphere Application Server offers common schedules and a programming model across the releases

Java Application Characteristics for WebSphere Application Server Deployments: pSeries and zSeries

Compute Intensive

Homogenous

Raw throughput

Predictable

Simple transactions

Heavy I/O – mixed workload

High ROI

Unpredictable volumes

Access to core mainframe assets

Complex transactions

Business critical

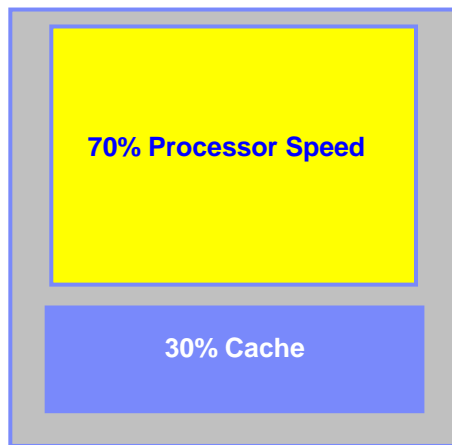

pSeries

Considering application characteristics is only one factor when deciding where to run your business applications, but knowing what your platform does best is *critical*

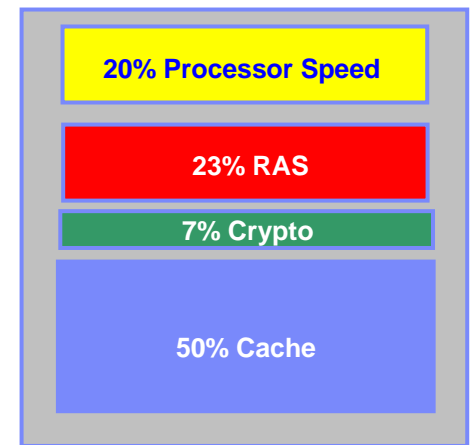

zSeries

Enterprise data access with multiple physical tiers vs a single physical tier

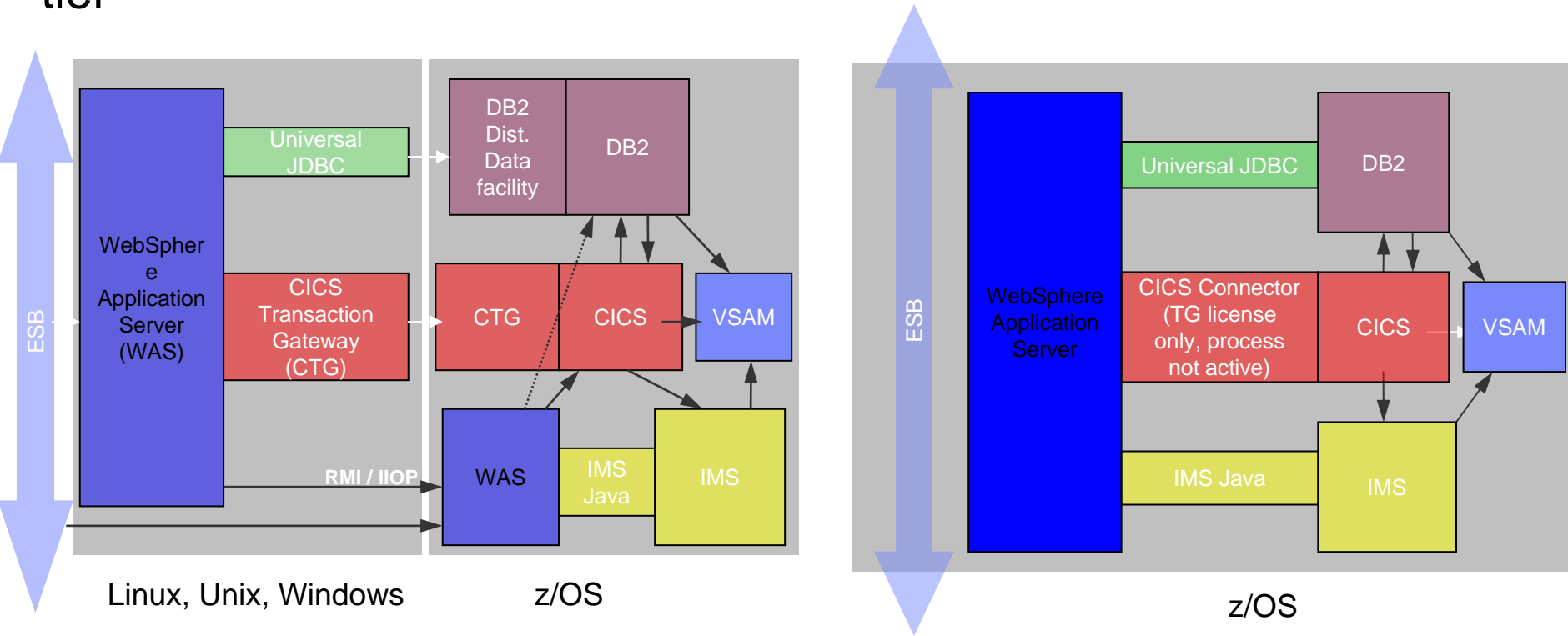

Moving from multiple physical tiers to a single tier provides many benefits, including tighter security, enhanced management, reduced costs, and performance gains.

Single Tier Performance Benefits



High availability benefits

- Fewer tiers to HA enable and manage
- Proven Parallel Sysplex HA enablement
- Parallel Sysplex exploitation by all program products
- Simplified recovery procedures
- Faster restart times
- Operating system service (ARM) for system restart



Performance benefits

- No network time
- No product specific network protocol construction / deconstruction
 - DRDA (DB2)
 - CICS Transaction gateway (CICS)
 - RMI / IIOP (IMS & J2EE)
- Reduced CPU utilization
- Hi speed access to cache without network
 - Parallel Sysplex infrastructure infrastructure for DB2, CICS, IMS, MQ
 - Guaranteed integrity and currency of data (Pessimistic data access)
- Improved two phase commit performance

Benefits of a single tier environment



Management benefits

- **Fewer components to manage**
 - ✓ Hardware servers
 - ✓ Network Infrastructure
 - ✓ Operating Systems
- **zSeries Platform Scalability**
 - ✓ Vertical (Up to 32 CPU per image)
 - ✓ Horizontal Scalability (Parallel Sysplex)
- **Smaller Physical Footprint and resource utilization**
- **Single end to end management interface / console for all products within the architecture**
 - ✓ WebSphere cross platform administrative interface
 - ✓ MVS Console, System Monitor Facility

Security benefits

- Single security authority for authentication and authorization
- Simplified Compliance Certification and Analysis (SOX, HIPAA, etc)
- Tight integration of WebSphere and RACF via SAF
- End user authentication for authorization and auditing throughout the architecture
- No network between tiers
 - ✓ Reduced Opportunity for intercepting transmissions (
 - ✓ No need to encrypt data or tunnel between tiers



zAAP Engines

Do you ...

- Have considerable Java workload?
- Anticipate growth in Java workloads?
- Need more capacity?
- Want to consolidate Java workloads?
- Need to lower the cost of running Java workloads?

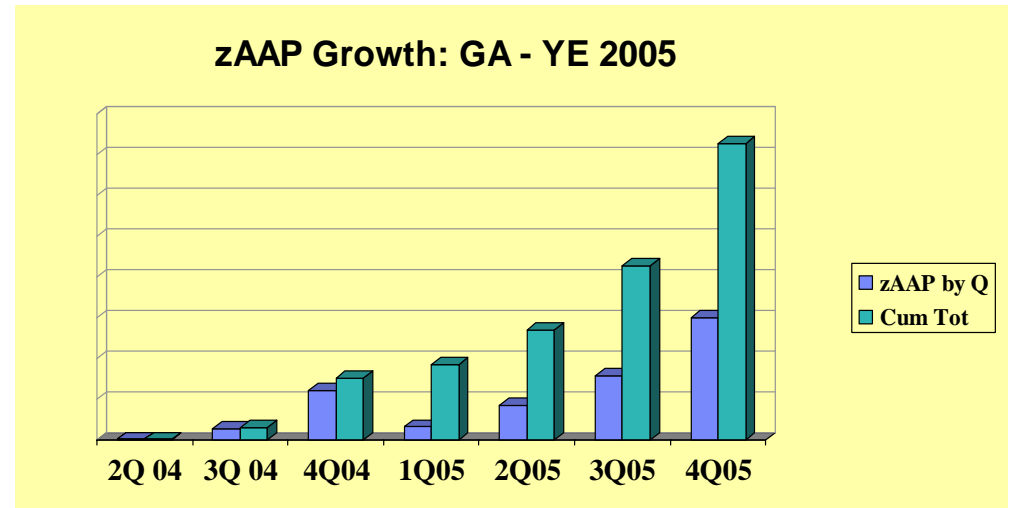

Which workloads are good for zAAPs?

- Some are good candidates
 - Heavy Java
- Some aren't good candidates
 - Light weigh Java
- The cost of dispatching between zAAPs and Standard CPs
 - It costs more to get there than being there
 - Look at the "Switch Rate" and "zAAP eligible microseconds per switch" under Excel workbook

Additional Customer Experiences with zAAPs

Case #1: ISV in benchmarking

- LPAR configured with WAS z/OS running the target application & using a type 2 connection to DB2 in the same LPAR
- Offload percentage for the server was 72% without any modification or optimization
- What was not off-loadable was DB2, TCPIP, and control region processing

Case #2: Customer account

- Current production environment running WAS z/OS / apps, using type 2 and type 4 connections to DB2
- Approximately 7 zAAPs offloading 4000 MIPs

What is WebSphere Extended Deployment?

What if you could deliver greater value to your application infrastructure in a non-invasive fashion utilizing the existing base?

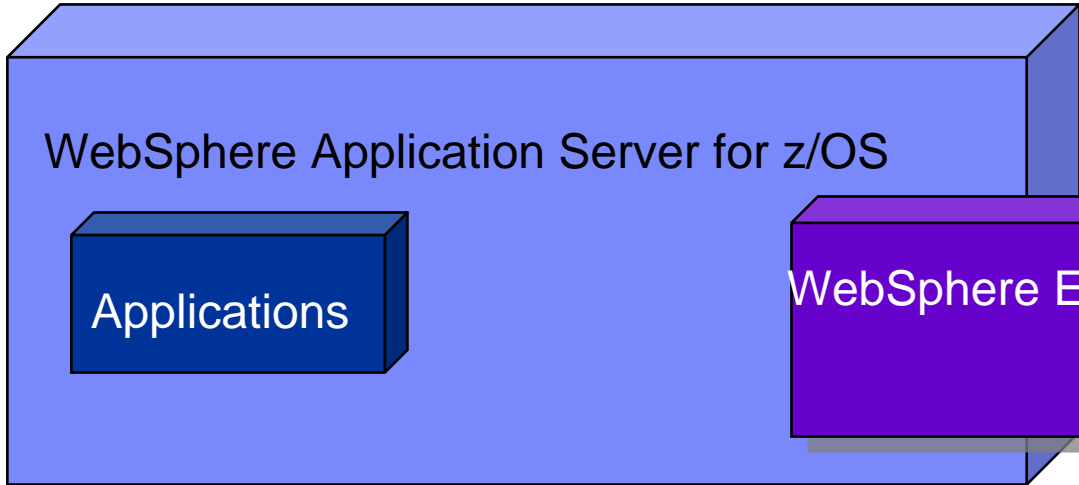

Provides a robust environment for business applications

- ✓ J2EE 1.4
- ✓ Advanced Web Services

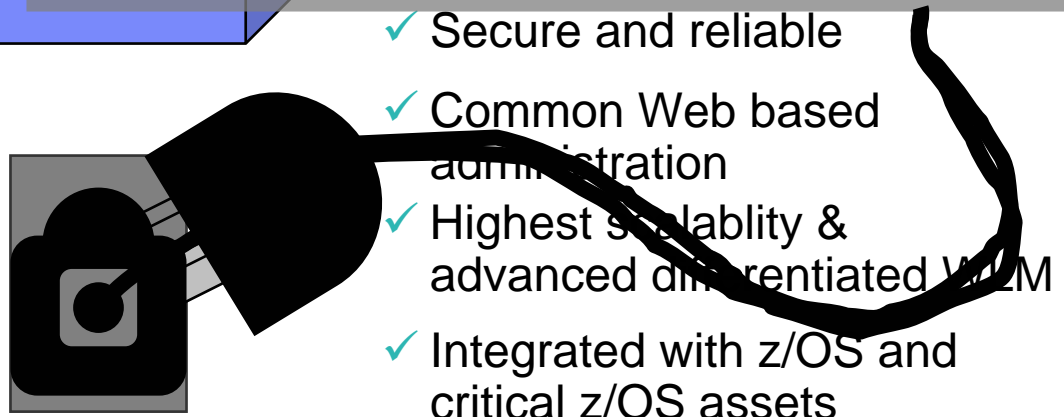

IS WAS & XD a replacement for mainframe WAS deployments?

“Maybe I can use WAS & XD on Distributed and still get a mainframe quality of service?”

There is no overlap or comparison:

- Scalability between the products differs
 - WAS & XD Distributed has dynamic horizontal scaling
 - WAS z/OS has dynamic vertical scaling
- Both have goal based policy workloads, but the similarities end there ...
 - z/OS WLM is a comprehensive WLM for an end-to-end production enterprise
- Availability considerations are radically different
 - There is no parallel sysplex equivalent
- Security options are not comparable

A deployment is only as strong as the foundation it is built upon

Business value of XD for z/OS deployments

WebSphere Application Server for z/OS derives immense value from the functionality of z/OS which enables intelligent automation, requiring less manpower for higher returns



WebSphere Extended Deployment for z/OS brings enhanced intelligence to the application server, enabling WAS for z/OS deployments to be the most effective and productive J2EE application infrastructure

WAS for z/OS **platform integration** offers:

- Parallel Sysplex support for class five availability (99.999%)
- Intelligent Resources Director dynamically adjusts resources as needed
- z/OS WLM architected inside for linear scalability and differentiated workload priorities
- Ability to run in close proximity to data, enabling type 2 connections and super fast data exchange rates, even for high volumes
- Support for transactional integrity delivered by Resource Recovery Services
- Support for diverse workloads and intense utilization rates

XD for z/OS supports... Flexibility

Support for **heterogeneous** workloads and application servers

XD for z/OS provides:

- WebSphere Batch environment:
 - ✓ Designed for structured J2EE batch workloads
 - On z/OS XD supports concurrent OLTP & batch workloads on the same application server
 - ✓ Scheduling agent to ensure batch workloads are disseminated to garner unused WebSphere resources
 - ✓ Service policy support to differentiate workload importance
- WebSphere & non-WebSphere server support
 - ✓ Simplifies the management of diverse servers

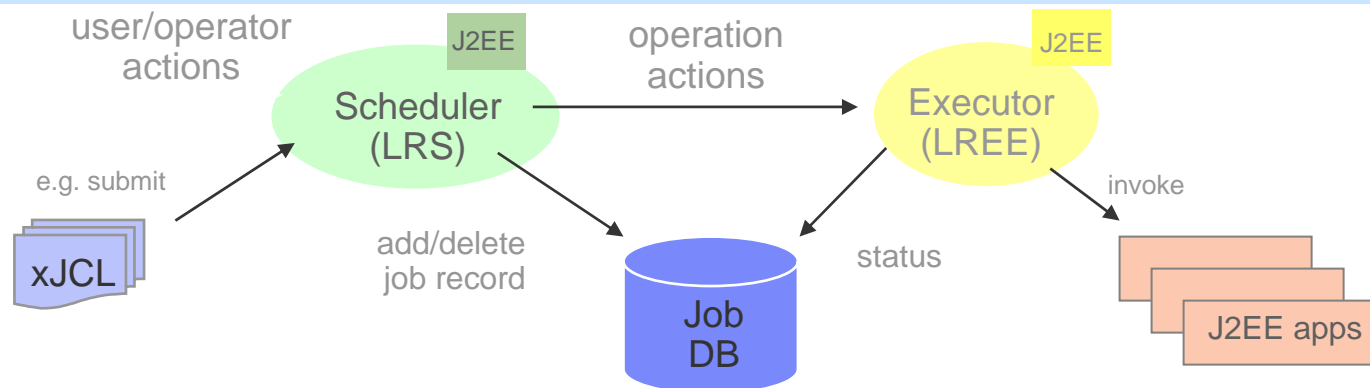

XD for z/OS enables ... Intelligence

Provide **intelligence** for application servers to share information and workloads

XD for z/OS provides:

- On Demand Router (ODR)
 - ✓ Provides an intelligent proxy for workload routing within and across LPARs
 - Uses metrics from z/OS WLM to make decisions
- Health Policy
 - ✓ Proactively seeks software maladies, such as hung servers, excessive memory consumption, and storm drain situations, and addresses them
- Service Policies
 - ✓ Enables granular classification of application workloads which is addressed within the ODR
 - ✓ Value is compounded by z/OS WLM which manages XD application workloads, as well as all zSeries workloads

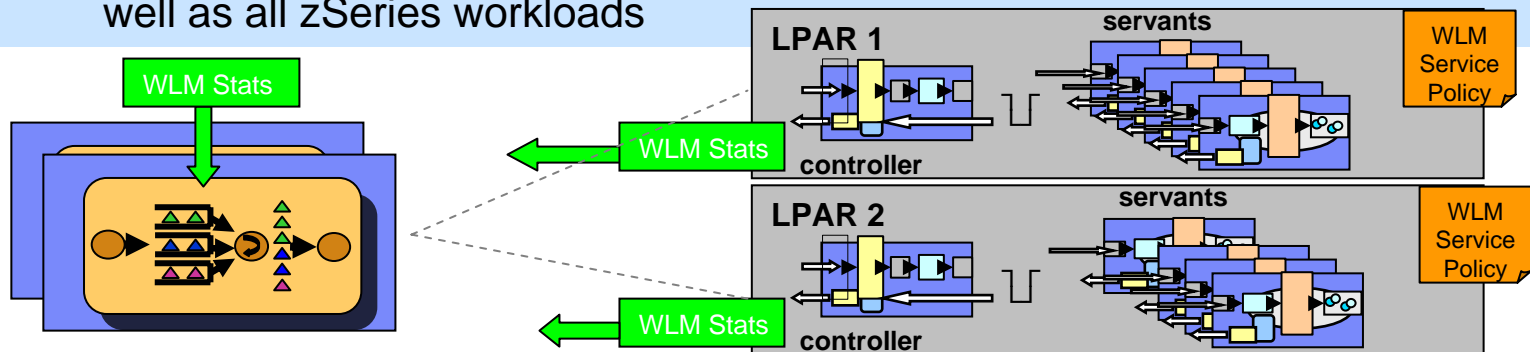

XD for z/OS drives ... Performance

Eliminate performance hindrances with smart datasource access and caching

XD for z/OS provides:

- Partitioning Facility
 - ✓ Ability to break applications into partitions which enable smart, consistent caching at a partition level
 - ✓ Highly available application partitions
 - ✓ Provides reduced lock contention on shared DB2 resources
- ObjectGrid
 - ✓ Creates a caching fabric for shared object data which reduces unproductive backend datasource transactions

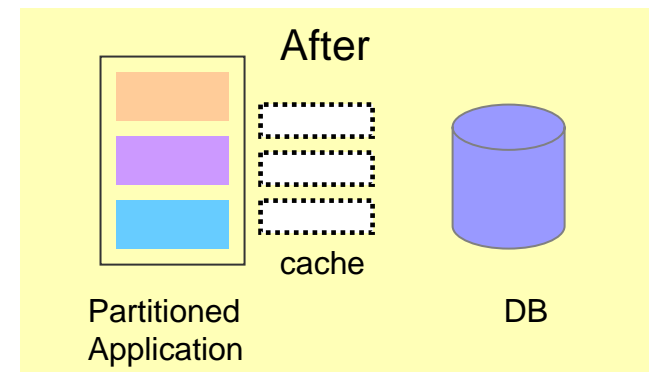
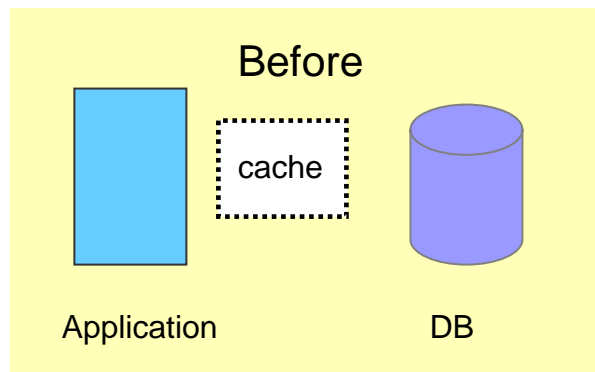

XD for z/OS addresses ... Manageability

Simplify and overcome complex application environments

XD for z/OS provides:

- Application Edition Manager
 - ✓ Provides the facility for multiple versions of production applications, including operational support for piloting, staging, and rollback
- Visualization
 - ✓ Customizable charts which are dynamically update to display the success of your application infrastructure
 - ✓ Runtime maps enable at a glance assessments of the components of your application server cells

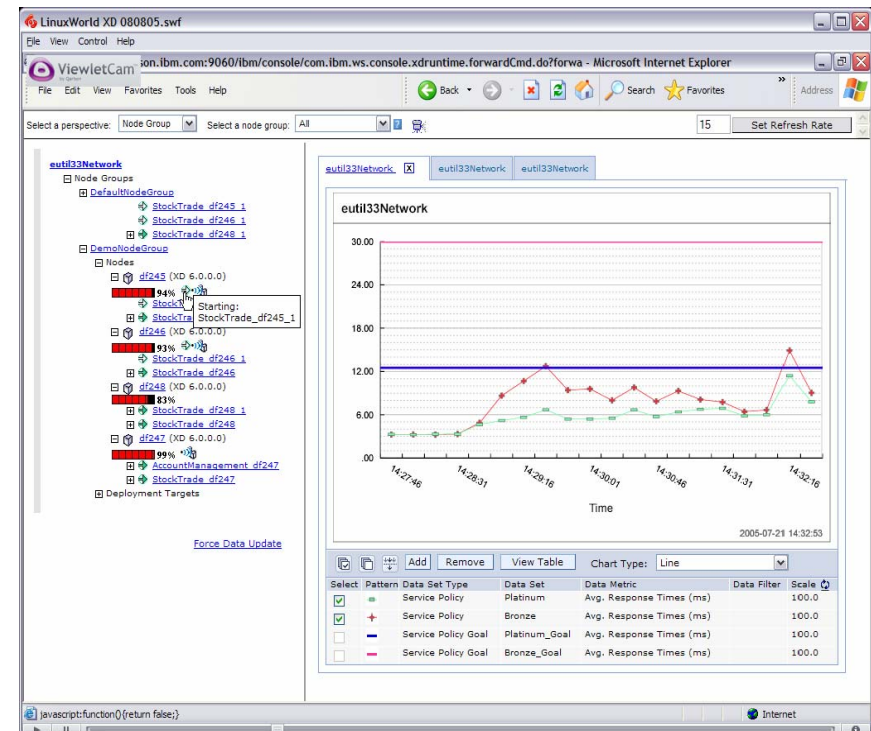

Deciding where to deploy applications: WebSphere XD

Once your platform and application server decisions have been made, XD can be added to optimize the existing application infrastructure

Function

WAS delivers:

- High availability
- Clustering
- J2EE 1.4
- Web Services
- Security
- Messaging

XD delivers:

- WebSphere batch
- On demand router
- App edition mgr
- Visualization
- Performance optimizers

Windows

- WLM
- HACMP (AIX)
- LPAR (AIX)

WAS delivers:

- High availability
- Clustering
- J2EE 1.4
- Web Services
- Security
- Messaging

XD delivers:

- WebSphere batch
- On demand router
- App edition mgr
- Visualization
- Performance optimizers

AIX/UNIX/Linux

- Intelligent Resource Director
- z/OS WLM
- Mixed workload support
- Sysplex (GDPS)
- ARM
- RRS
- LPAR
- Mainframe security

WAS delivers:

- High availability
- Clustering
- J2EE 1.4
- Web Services
- Security
- Messaging
- * Platform optimized

XD delivers:

- WebSphere batch
- On demand router
- App edition mgr
- Visualization
- Performance optimizers
- * z/OS WLM Integration
- * Shared workload mgmt

z/OS

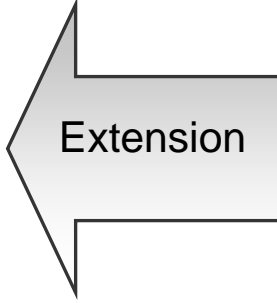
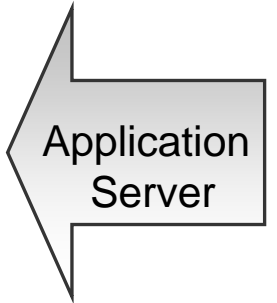
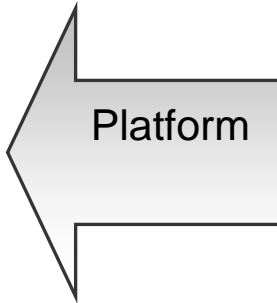

Resources

- [A Cool Way to Boost Performance with IBM WebSphere for z/OS Applications](#)
- [The Dinosaur Myth](#)
- [IBM Education Assistant](#)
- [WebSphere Virtual User's Group](#)
- [WebSphere Application Server Information Center](#)
- [Mainstream: WebSphere for z/OS](#)
- [Redpiece: Scaling for High Availability](#)
- [Optimizing WebSphere Application Server for Performance](#)
- [Introducing WebSphere Extended Deployment for z/OS](#)
- Extreme Leverage Web site: [WAS for z/OS](#) & [XD for z/OS](#)



WebSphere Portal

Raising the bar on business value

Bill Jones
wgjones@us.ibm.com

SOA on your terms and our expertise

ON DEMAND BUSINESS™

The New Economy

Human Capital Replaces Physical Capital as the Source of Value in an Organizational



Budget constraints
Goals to improve performance

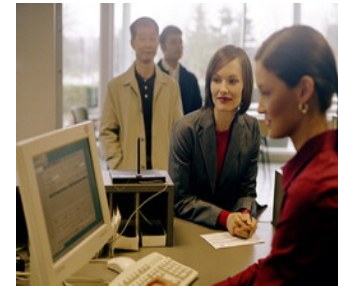

Nature of work is changing
Employees need to maintain skill levels to meet job requirements

Aligning IT strategy
ROI on IT investment

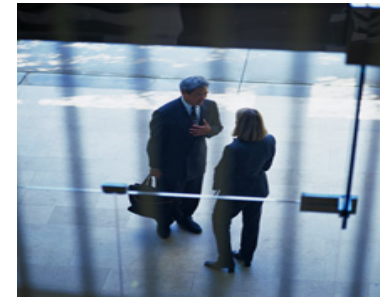

Increase productivity
Improve efficiency



Complex technical environment
Lack of blueprint to integrate systems

The Need for Productivity is Everywhere



Top Budget Priorities of Business Technology execs

- Streamline or optimize business processes
- Boost worker productivity across the company
- Serve customers better!

Information Week, Jan 5, 2004 - interview with 400 bus-technology executives

There is a Fundamental Shift Underway...

Technology convergence in the marketplace

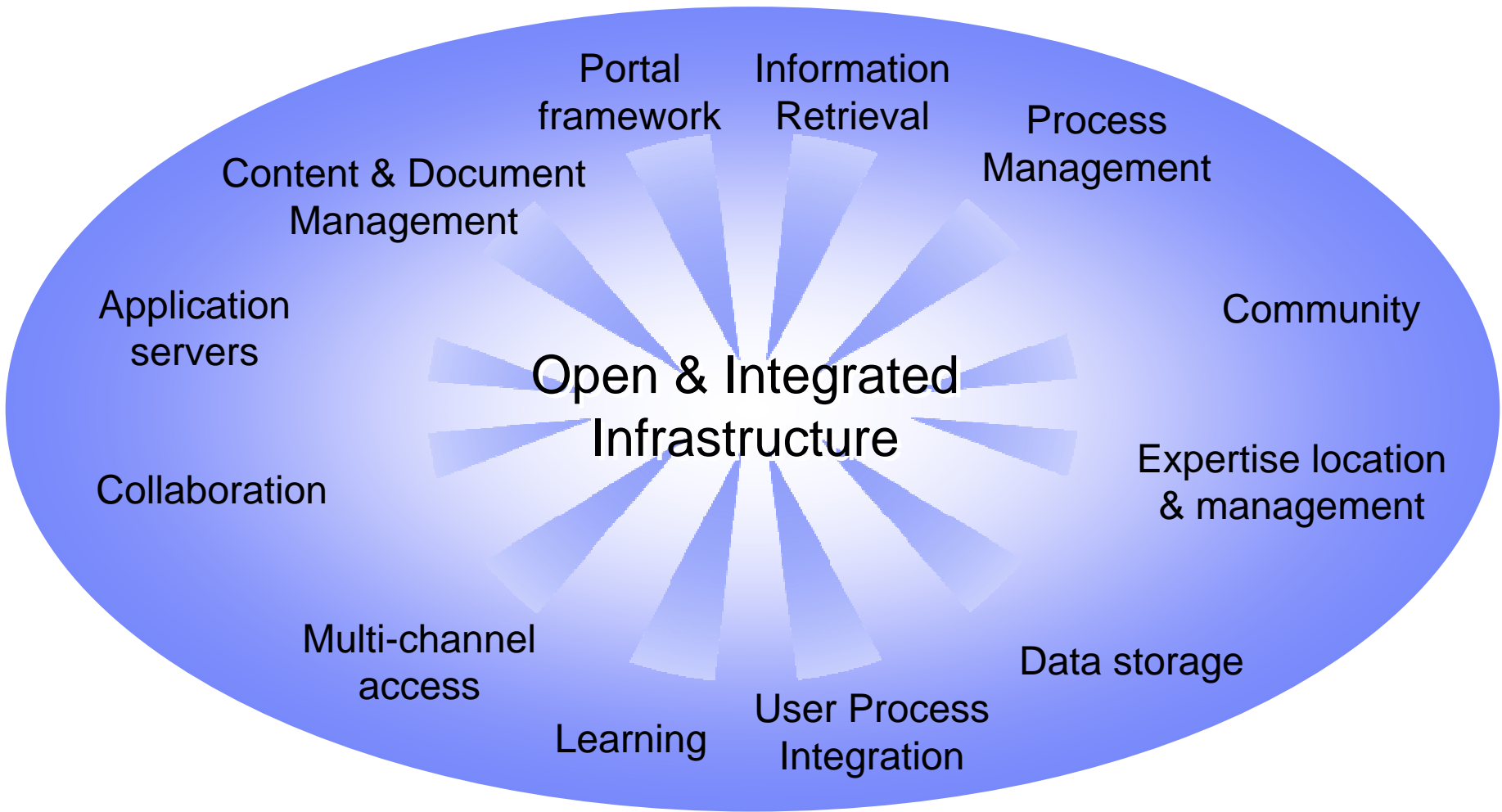

IBM On Demand Business™

An on demand business is an enterprise whose business can respond in real time to any customer demand, market opportunity, or external threat.

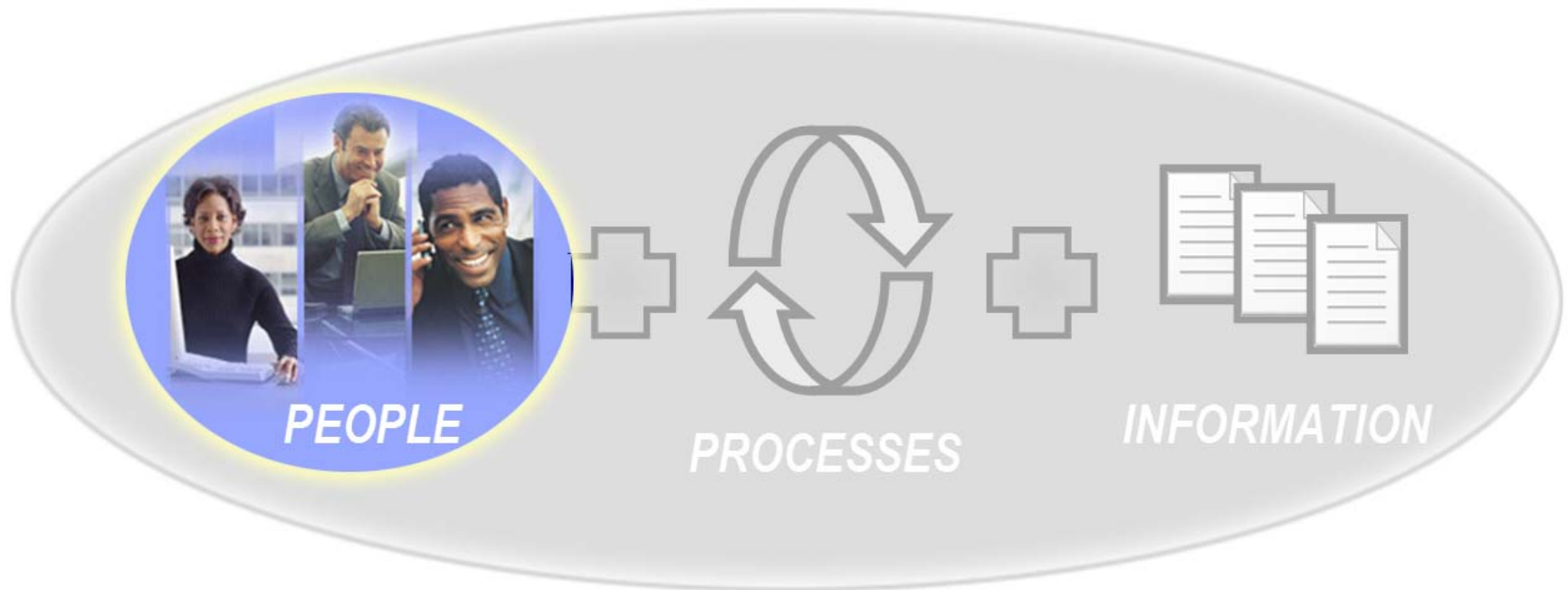

On Demand Businesses require a portal framework that provides **integrated access** to people, applications, processes and information.

B2E Portals improve employee productivity and rapid decision making

B2C Portals increase customer loyalty and cross-sell revenue

B2B Portals build partner relationships through integration with your business processes

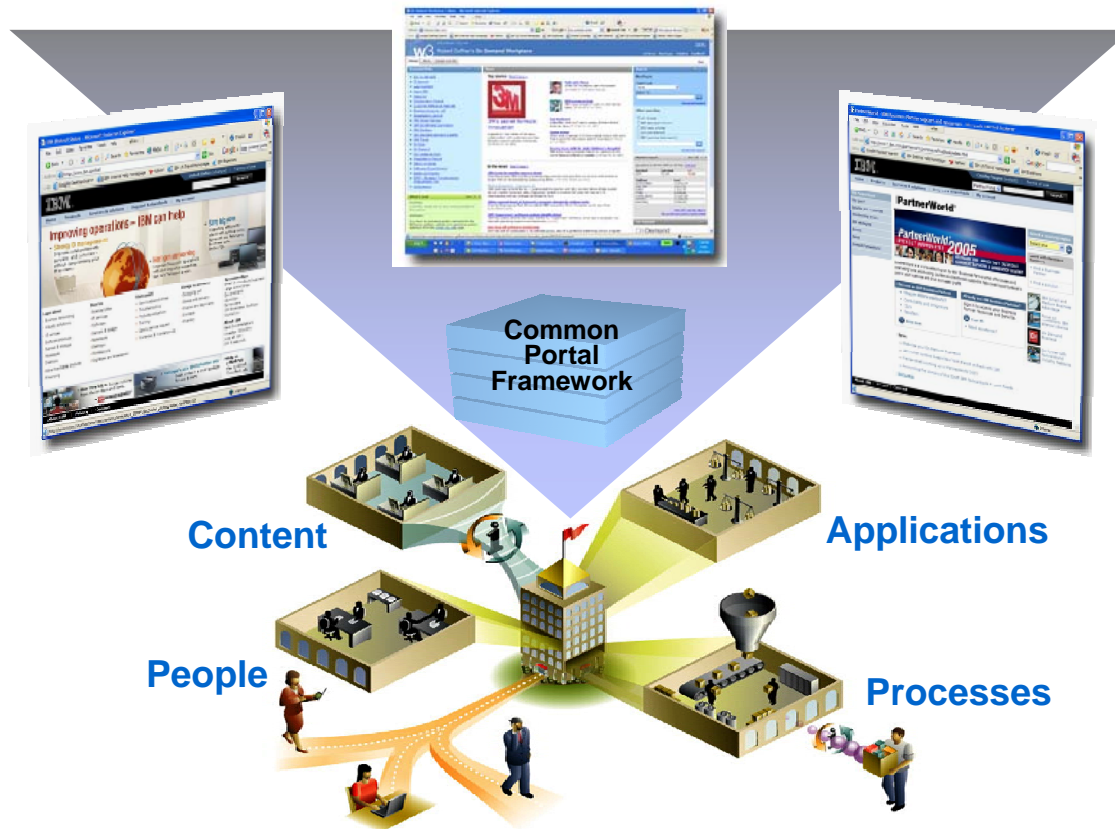

The Role of the Portal

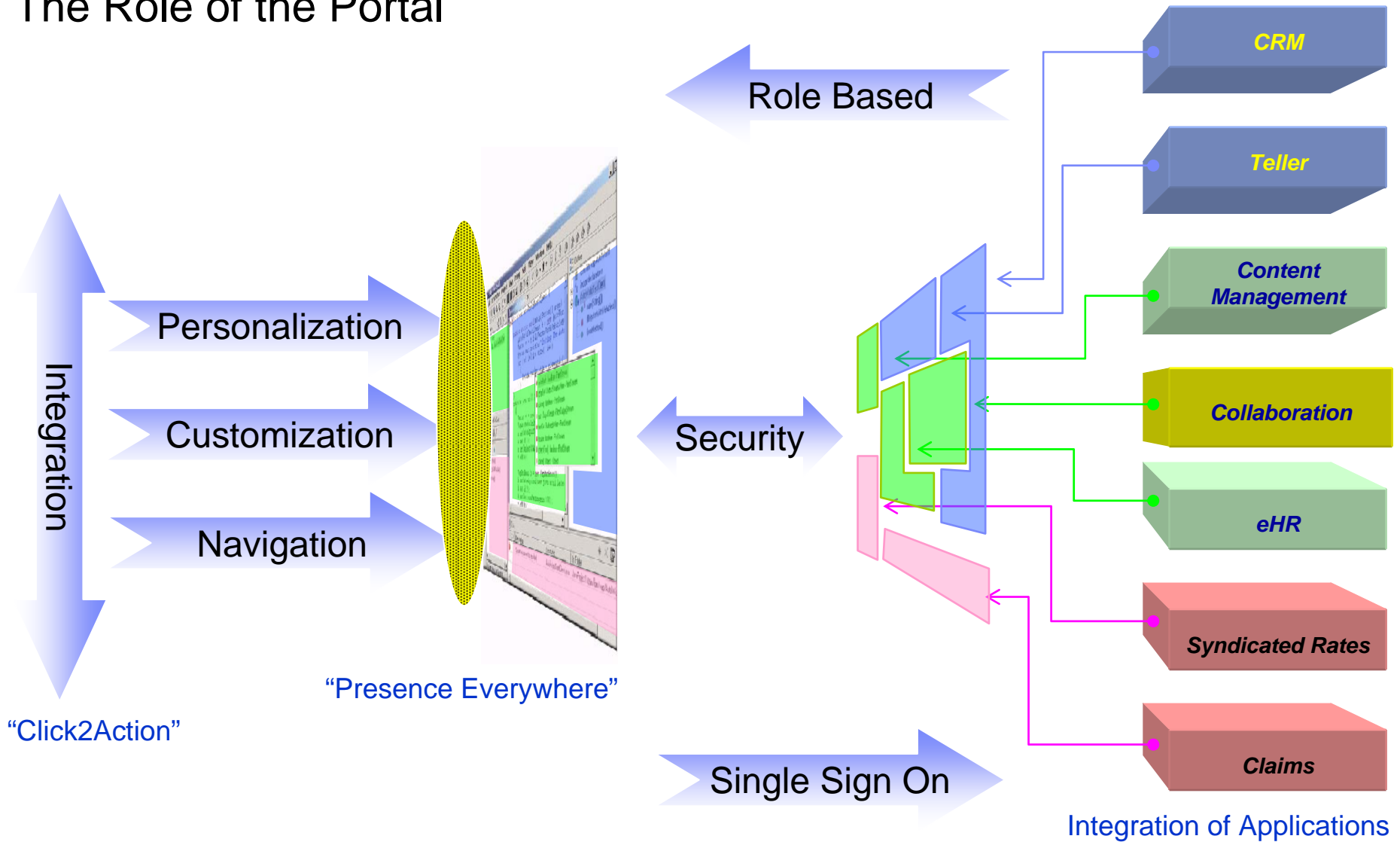

Portal Principle

- Combines application user interfaces together into one unified presentation
- Each portlet is a separate application
 - Developed, deployed, managed, and displayed independent of other portlets
 - Can be placed anywhere on the page
- Delivers a highly personalized experience, considering
 - User's job role
 - Security settings
 - Administrators
 - Personal settings
 - Device settings

The screenshot shows the IBM My support portal interface. At the top is a blue banner with the IBM logo and navigation links: Home, Products & services, Support & downloads, and My account. Below the banner is a search bar and a 'Select a Country' dropdown. The main content area is titled 'My support' and contains several portlets: 'WebSphere Portal' with a product filter, 'Downloadable files' with a list of documents, 'Frequently asked questions' with 0 items, 'Hints and tips' with a list of articles, 'Technical support search' with a search box and 'Submit' button, 'Flashes' with 0 items, and 'Solutions' with 0 items. On the right side, there are additional portlets: 'Welcome, Chris' with a sign-out link, 'What's new' with a list of links, and 'Find resources' with a list of links. A yellow callout box labeled 'Banner' points to the top navigation bar. A yellow callout box labeled 'Navigation' points to the left sidebar menu. A yellow callout box labeled 'Portlets' points to the main content area.

SOA and Portal

- Portlets are the natural way for users to interact with an enterprise “Service”

Flight Selection

Portlet

Flight Select Portlet			
Frankfurt, Germany (FRA) to New York City, NY, USA (JRA)	Economy	Air Pakistan	450.00\$
Departure: 2002/10/05, 19:05 - Return: 2002/10/09, 07:30			
Frankfurt, Germany (FRA) to New York City, NY, USA (JRA)	Economy	Air France	450.00\$
Departure: 2002/10/05, 19:05 - Return: 2002/10/07, 15:10			
Frankfurt, Germany (FRA) to New York City, NY, USA (JRA)	Business	Lufthansa	1,400.00\$
Departure: 2002/10/05, 19:05 - Return: 2002/10/07, 09:45			
Frankfurt, Germany (FRA) to New York City, NY, USA (JRA)	Business	British Airways	1,299.00\$
Departure: 2002/10/05, 09:45 - Return: 2002/10/10, 09:45			
Frankfurt, Germany (FRA) to New York City, NY, USA (JRA)	First Class	Air Pakistan	2,100.00\$
Departure: 2002/10/05, 09:45 - Return: 2002/10/09, 19:05			
Frankfurt, Germany (FRA) to New York City, NY, USA (JRA)	Business	Lufthansa	1,299.00\$
Departure: 2002/10/05, 07:30 - Return: 2002/10/10, 07:30			
Frankfurt, Germany (FRA) to New York City, NY, USA (JRA)	Business	American Airlines	900.00\$
Departure: 2002/10/05, 15:10 - Return: 2002/10/07, 19:05			

refresh list

Flight Selection Service

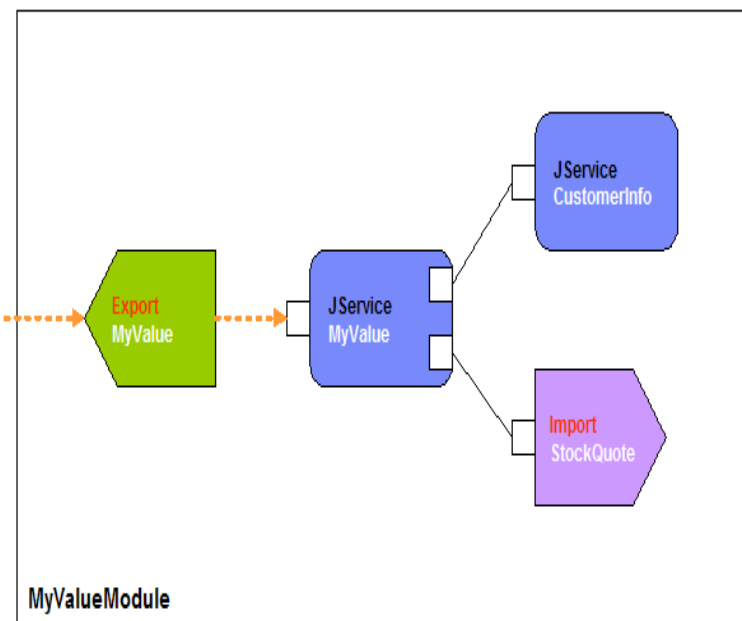

Why WebSphere Portal Now?

Business Benefits

Executives

- Support Company Strategies & Initiatives
- Soft & Hard ROI
- Reduce Support calls (Desktop)
- Cost Avoidance
- Transaction costs
- Drive Revenue
- Increase Customer Loyalty / Relationship
- Single Communication Vehicle (Channels)
- Competitive Advantage



Admin / IT / Development

- Alignment of IT investments
- Single Sign On
- Internationalization
- Intranet / Extranet
- Leverage Reuse & Investments
- Faster Development of solutions



End User

- Single User Experience
- Collaboration in Context
- Hides complexity of environment
- Move outside "silo" department
- Self Service



Line Of Business

- Delivery Platform for "their" applications, content, process
- Single Portal Price includes additional value
- Marketing & Branding
- Role Based
- Connect Geographical dispersed teams
- Power to assemble new process
- Improving Business Productivity
- Improving Responsiveness



WebSphere Portal Enable for z/OS V5.1 (5.1.0.1 code)

- Functional Parity with WebSphere Portal for Multiplatforms V5.1
- Close to 100% code compatibility
- Easier and More Intuitive Installation and Configuration
- Selected Exploitation of z/OS Qualities of Service
- Performance equal to or better than WebSphere Portal for Multiplatforms V5.1
- Enterprise Characteristics of the z/OS Platform
 - Includes support for the zSeries Application Assist Processor (zAAP)

z/OS

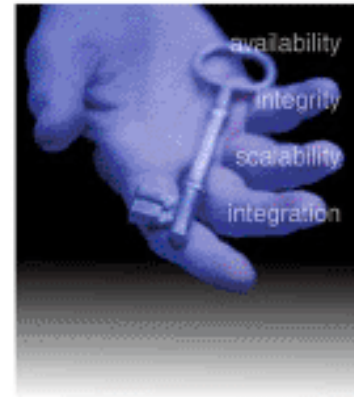

**World-class computing
for the on demand business**

Why Deploy Portal on z/OS?

- Portal exploits the capabilities of the zSeries z990 hardware
 - Legendary availability and superior reliability
 - Architected instructions for ebusiness workloads
 - Checksum, PLO, IEEE floating point, SSL
 - Dedicated co-processors
 - ICSF, zAAP, IFL
 - Self configuring through capacity upgrades on demand
 - Self protecting and self healing through PPRC and XRC
 - Superior virtualization techniques through LPAR, PR/SM, and IRD

In Summary...

Flexibility and Choice

Depth and Breadth

Innovations for People Productivity

Raising the bar on Business Value

...Delivering on Demand Organizations