

WebSphere Business Integration Express Plus



Data Handler Guide

WebSphere Business Integration Express Plus



Data Handler Guide

Note!

Before using this information and the product it supports, read the information in "Notices" on page 185.

14May2004

This edition of this document applies to IBM WebSphere Business Integration Server Express, version 4.3, IBM WebSphere Business Integration Server Express Plus, version 4.3, and to all subsequent releases and modifications until otherwise indicated in new editions. To send us your comments about this document, e-mail doc-comments@us.ibm.com. We look forward to hearing from you.

© Copyright International Business Machines Corporation 2004. All rights reserved. US Government Users Restricted Rights – Use, duplication or disclosure restricted by GSA ADP Schedule Contract with IBM Corp.

© **Copyright International Business Machines Corporation 2004. All rights reserved.**
US Government Users Restricted Rights – Use, duplication or disclosure restricted by GSA ADP Schedule Contract with IBM Corp.

Contents

About this document	v
Audience	v
Related documents	v
Typographic conventions	v
New in this release	vii
<hr/>	
Part 1. Getting started.	1
<hr/>	
Chapter 1. Data handler overview.	3
What is a data handler?	3
Data handler instantiation	12
Calling the data handler	16
Metadata-driven data handler design.	19
Chapter 2. Installing and configuring data handlers	21
Installing data handlers	21
Configuring data handlers	21
Configuring a connector to use data handlers	25
Chapter 3. XML data handler	27
Overview	27
Requirements for business object definitions	30
Configuring the XML data handler	35
XML documents that use DTDs.	38
XML documents that use schema documents	50
Creating business object definitions	76
Converting business objects to XML documents	78
Converting XML documents to business objects	81
Customizing the XML data handler	82
Chapter 4. Request-Response data handler	85
Overview	85
Requirements for business object definitions	92
Configuring the Request-Response data handler	95
Converting business objects with the request data handler.	98
Converting business objects with the response data handler	99
Error handling	100
Customizing the Request-Response data handler	100
Chapter 5. FixedWidth data handler.	103
Overview.	103
Configuring the FixedWidth data handler	104
Converting business objects to FixedWidth documents	107
Converting FixedWidth documents to business objects	108
Chapter 6. Delimited data handler.	111
Overview.	111
Configuring the Delimited data handler	112
Converting business objects to delimited data	115
Converting delimited data to business objects	116
Chapter 7. NameValue data handler	119

Overview	119
Configuring the NameValue data handler	120
Converting business objects to NameValue data	123
Converting NameValue data to business objects	124

Part 2. Custom data handlers 127

Chapter 8. Creating a custom data handler. 129

Overview of the data-handler development process	129
Tools for data-handler development	131
Designing the data handler	132
Extending the data handler base class	133
Implementing the methods	134
Building a custom name handler	147
Adding a data handler to the jar file	148
Creating data-handler meta-objects	149
Setting up other business objects	151
Configuring a connector	151
An internationalized data handler	152

Chapter 9. Data Handler base class methods. 157

createHandler()	157
getBO() - abstract	158
getBO() - public	160
getBOName()	161
getBooleanOption()	162
getByteArrayFromBO()	163
getEncoding()	164
getLocale()	164
getOption()	165
getStreamFromBO()	165
getStringFromBO()	166
setConfigMOName()	167
setEncoding()	168
setLocale()	168
setOption()	169
traceWrite()	170

Appendix. Using the XML ODA 171

Installation and usage	171
Using an XML ODA in Business Object Designer Express	174
Contents of the generated business object definition	183
Modifying information in the business object definition	183

Notices 185

Programming interface information	186
Trademarks and service marks	187

Index 189

About this document

The products IBM^(R)WebSphere Business Integration Server Express and IBM^(R)WebSphere Business Integration Server Express Plus are made up of the following components: InterChange Server Express, the associated Toolset Express, CollaborationFoundation, and a set of software integration adapters. The tools in Toolset Express help you to create, modify, and manage business processes. You can choose from among the prepackaged adapters for your business processes that span applications. The standard processes template--CollaborationFoundation--allows you to quickly create customized processes.

This document describes delivered data handlers and custom data handler capabilities.

Except where noted, all the information in this guide applies to both IBM WebSphere Business Integration Server Express and IBM WebSphere Business Integration Server Express Plus. The term WebSphere Business Integration Server Express and its variants refer to both products.

Audience

This document is for consultants and customers. You should be familiar with business objects and metadata objects. To use the XML data handler, you should be familiar with XML documents, current XML standards, and with SAX (Simple API for XML). If you intend to expand the data handler library, you should be proficient in the Java programming language.

Related documents

The complete set of documentation available with this product describes the features and components common to all WebSphere Business Integration Server Express installations, and includes reference material on specific components.

You can download, install, and view the documentation at the following site:
<http://www.ibm.com/websphere/wbiserverexpress/infocenter>

Note: Important information about this product may be available in Technical Support Technotes and Flashes issued after this document was published. These can be found on the WebSphere Business Integration Support Web site, <http://www.ibm.com/software/integration/websphere/support/>. Select the component area of interest and browse the Technotes and Flashes sections.

Typographic conventions

This document uses the following conventions:

<code>courier font</code>	Indicates a literal value, such as a command name, file name, information that you type, or information that the system prints on the screen.
<i>new term</i>	Indicates a new term the first time that it appears.
<i>italic, italic</i>	Indicates a variable name or a cross-reference.

<i>blue outline</i>	A blue outline, which is visible only when you view the manual online, indicates a cross-reference hyperlink. Click inside the outline to jump to the object of the reference.
{ }	In a syntax line, curly braces surround a set of options from which you must choose one and only one.
[]	In a syntax line, square brackets surround an optional parameter.
...	In a syntax line, ellipses indicate a repetition of the previous parameter. For example, <code>option[...]</code> means that you can enter multiple, comma-separated options.
< >	In a naming convention, angle brackets surround individual elements of a name to distinguish them from each other, as in <code><server_name><connector_name>tmp.log</code> .
\	In this document, backslashes (\) are used as the convention for directory paths. All IBM WebSphere product pathnames are relative to the directory where the IBM WebSphere product is installed on your system.
<i>ProductDir</i>	Represents the directory where the product is installed. For the IBM Business Integration Server Express environment, the default product directory is "IBM\WebSphereICS". For the IBM WebSphere Business Integration Adapters environment, the default product directory is "WebSphereAdapters".
<i>%text%</i>	Text within percent (%) signs indicates the value of the Windows text system variable or user variable.

New in this release

This is the first release of this guide.

Part 1. Getting started

Chapter 1. Data handler overview

This chapter introduces WebSphere business integration system data handlers. A data handler is responsible for converting business objects into serialized data and for converting serialized data into business objects. This serialized data is in an application-readable format (string or input stream). This chapter contains the following sections:

- “What is a data handler?”
- “Data handler instantiation” on page 12
- “Calling the data handler” on page 16
- “Metadata-driven data handler design” on page 19

What is a data handler?

A *data handler* is a Java class instance that converts between a particular serialized format and a business object. Data handlers are used by components of a business integration system that transfer information between a WebSphere business integration broker and some external process. Table 1 shows the components that handle transfer of information between a WebSphere business integration broker and an external process.

Table 1. Components that transfer information in the WebSphere business integration system

Component	Purpose	For more information
Adapter	<p>Handles transfer of information between a WebSphere business integration broker and an external process such as an application or technology.</p> <p>Note: The adapter uses a runtime component called a <i>connector</i> to actually handle the transfer of information between an integration broker and an application (or technology).</p> <p>These external processes identify events that occur within them by sending an event record to an event store. The adapter detects events in this event store. When it finds a triggering event, the adapter creates a business object that represents the event and sends this event <i>asynchronously</i> to the business integration broker. This business object contains data and a verb to indicate the type of event (such as Create or Update).</p>	<p>For IBM-delivered adapters: see the individual adapter guides.</p> <p>For a custom adapter, see the <i>Connector Development Guide for Java</i> or the <i>Connector Development Guide for C++</i> (depending on the language in which the connector is implemented) for information about custom connectors.</p>

Table 1. Components that transfer information in the WebSphere business integration system (continued)

Component	Purpose	For more information
Access client	<p>Handles transfer of information between the InterChange Server integration broker and some external process such as a servlet within a web server.</p> <p>An access client is an external process that uses the Server Access Interface to communicate directly with InterChange Server. When this component receives some information that needs to be transferred, it creates a business object that represents the event and sends this event <i>synchronously</i> to a collaboration within InterChange Server. As with the adapter, the business object contains data and a verb to indicate the type of event (such as Create or Update).</p>	Server Access Interface Development Guide

As Table 1 shows, the task of both these components (connector and access client) is to transfer information between a broker and an external process, as follows:

- To send information to an integration broker, these components format it in a business object.
- To send information to an external process, these components format it in its native serialized format.

Often, the external process uses some common format such as XML for its native serialized data. Rather than have every adapter (or access client) handle the transformation between these common formats and business objects, the WebSphere business integration system provides several IBM-delivered data handlers. In addition, you can create custom data handlers to handler conversion between your own native format. The adapter (or access client) can then call the appropriate data handler to perform the data conversion based on the Multipurpose Internet Mail Extensions (MIME) type of the serialized data.

Note: A data handler is implemented in a Java class named `DataHandler`. This class is an abstract class, which the data-handler developer extends to implement a data handler instance. For more information, see “Extending the data handler base class” on page 133.

The section provides the following information about data handlers:

- “IBM-delivered data handlers”
- “Data-handler meta-objects” on page 6
- “Contexts for calling data handlers” on page 6

IBM-delivered data handlers

IBM delivers data handlers in the Java archive (jar) files shown in Table 2. These jar files reside in the `DataHandlers` subdirectory under the product directory.

Table 2. IBM-delivered data-handler jar files

Contents	Description	Data-handler jar file
Base data handlers	Text-based data handlers and data handlers specific to some IBM-delivered adapters	CwDataHandler.jar
Special data handlers	XML data handler	CwXMLDataHandler.jar
Custom data handlers	Data handlers that you implement	CustDataHandler.jar

Base data handlers

The base data-handler file, `CwDataHandler.jar`, contains most of the IBM-delivered data handlers. This file resides in the `DataHandlers` subdirectory of the product directory. Table 3 shows the base data handlers that this base data-handler file contains.

Table 3. Base data handlers in the base data-handler file

Data handler	MIME type	For more information
Request-Response Data Handler	text/requestresponse	Chapter 4, "Request-Response data handler," on page 85
FixedWidth Data Handler	text/fixedwidth	Chapter 5, "FixedWidth data handler," on page 103
Delimited Data Handler	text/delimited	Chapter 6, "Delimited data handler," on page 111
NameValue Data Handler	text/namevalue	Chapter 7, "NameValue data handler," on page 119

Note: This manual describes the text data handlers that Table 3 lists. The base data-handler file also contains several data handlers specific to certain IBM-delivered adapters. If an IBM adapter uses a special data handler, its adapter guide describes the installation, configuration, and use of its data handler.

Special data handlers

IBM makes separate installers available for a few data handlers. In order to install these special data handlers, you must follow the steps provided in the *Installation Guide for WebSphere Business Integration Adapters*.

The separation of a data handler from the base data-handler file allows many adapters to use the data handler without incurring the overhead of storing the other data handlers that reside in the base data-handler file. Table 4 shows the data handlers for which IBM provides separate installers and separate jar files.

Table 4. IBM-delivered data handlers with separate jar files

Data handler	Data-handler jar file	MIME type	For more information
XML Data Handler	CwXMLDataHandler.jar	text/xml	Chapter 3, "XML data handler," on page 27

Custom data handlers

If the IBM-delivered data handlers do *not* handle the conversion of serialized data to a business object, you can create your own custom data handler. The `CustDataHandler.jar` file is intended to hold any custom data handlers that you might develop. This file resides in the `DataHandlers` subdirectory of the product

directory. For information about how to create a custom data handler, see Chapter 8, “Creating a custom data handler,” on page 129.

Note: To assist in develop of custom data handlers, IBM also delivers source code for the FixedWidth, Delimited, and NameValue data handlers as sample code. For more information, see “Sample data handlers” on page 131.

Data-handler meta-objects

A connector or Server Access Interface process instantiates a data handler based on the MIME type of an input file or the MIME type specified in a business object request.

A data-handler meta-object is a hierarchical business object that can contain any number of child objects. The data-handler configuration information is arranged in the following hierarchy:

- The *top-level* meta-object contains information about the MIME types that the different data handlers can support. Each top-level attribute is a cardinality 1 attribute referencing a child meta-object for a data handler instance. Each attribute represents one MIME type and indicates which data handler can manipulate it.
- The *child* meta-object contains the actual configuration information for a particular data handler. Each attribute represents a configuration property and provides information such as its default value and type.

Note: A data handler is not required to use meta-objects to hold configuration information. However, *all* IBM-delivered data handlers are designed to use meta-objects for their configuration information.

Data-handler meta-objects allow a connector or Server Access Interface process to instantiate a data handler based on the MIME type of an input file or the MIME type specified in a business object request. To configure a data handler, you must ensure that its meta-objects are correctly initialized and available to the callers (a connector or an access client).

Note: Each IBM-delivered data handler uses configuration properties that are defined in data-handler meta-objects. However, a custom data handler might or might not use meta-objects for its configuration properties. For more information, see “Using data-handler meta-objects” on page 133.

Contexts for calling data handlers

As Table 1 on page 3 describes, a component that needs to transfer data in the WebSphere business integration system can invoke a data handler. Table 5 provides additional information about the components that can invoke a data handler.

Table 5. Context for calling data handlers

Component	Type of event communication	Type of flow	Software that invokes the data handler
Adapter	Asynchronous	Event-triggered flow	Connector
Access client	Synchronous	Call-triggered flow	Server Access Interface

As Table 5 shows, in an event-triggered flow, an adapter calls a data handler directly. In a call-triggered flow, an external process that uses the Server Access

Interface (called an access client) initiates a call to the data handler. A data handler operates the same whether it is called directly by an adapter or indirectly by an access client. These contexts are described in the next sections.

Data handlers in a connector context

In an event-triggered flow, the runtime component of an adapter, called the *connector*, interacts directly with a data handler to convert data.

Note: For IBM-delivered adapters, see the individual adapter guides. For a custom adapter, see the *Connector Development Guide for Java* or the *Connector Development Guide for C++*, depending on the language in which the adapter is implemented. These guides are part of the WebSphere Business Integration Adapters documentation set.

When a connector calls a data handler, the data handler runs as part of the connector process. Figure 1 illustrates the data handler in the context of a connector.

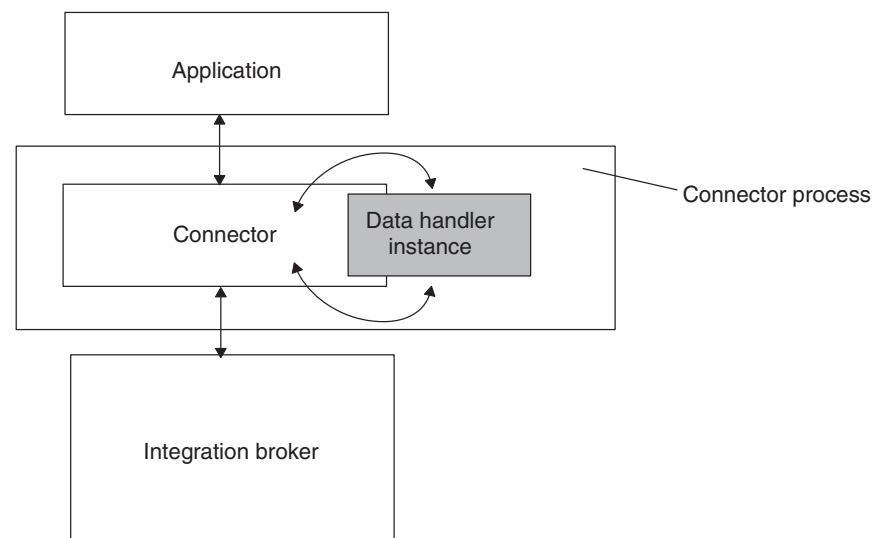

Figure 1. Data handler in the context of a connector

The data conversion reflects the business object requirements and the direction of the flow:

- The connector invokes the data handler for a business-object-to-string conversion when it handles business object request processing.
- The connector invoke the data handler for a string-to-business-object conversion when it handles event notification.

Connector business-object-to-string conversion: For a business-object-to-string conversion, the connector calls the data handler, passing it a business object. The data handler uses the information in the business object and the business object definition to create a stream or string of data. This stream or string of data is in the format associated with the data handler, usually of a particular MIME type. Business-object-to-string conversion is useful when the connector receives information from an integration broker in the form of a business object. The connector must then send the information in the business object to its application (or technology) as serialized data.

Figure 2 illustrates the data handler in the context of a connector when the data handler performs a business-object-to-string conversion.

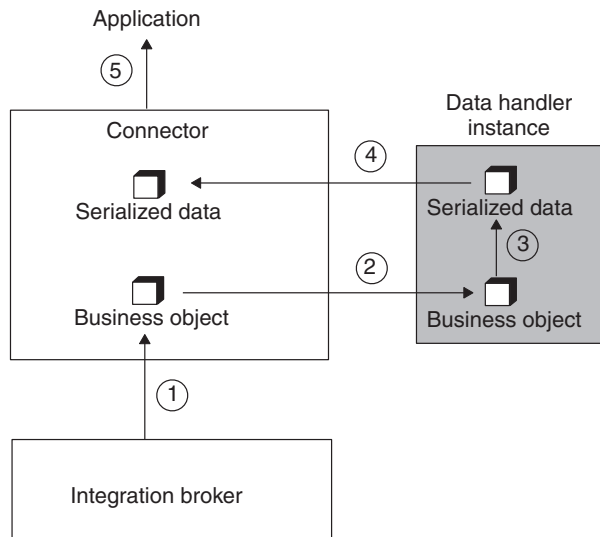

Figure 2. Business-object-to-string conversion in the connector context

1. The connector receives a business object from an integration broker.
2. The connector creates an instance of a data handler to handle the business object (using the `createHandler()` static method in the `DataHandler` base class). For more information about how a connector instantiates the data handler, see “Instantiation in the context of a connector” on page 16.
3. The connector requests a business-object-to-string conversion by calling one of the following data-handler methods:
 - `getStreamFromBO()`
 - `getStringFromBO()`
 - `getByteArrayFromBO()`

Into this method, the connector sends the business object as an argument. The data handler serializes the business object into the requested data format.

4. The data handler returns the serialized data to the connector.
5. The connector writes the serialized data to the destination, which could be an email, a file, or an HTTP connection.

Connector string-to-business-object conversion: For a string-to-business-object conversion, the connector calls the data handler, passing it the serialized data and its associated MIME type object. The data handler receives a stream or string of data. The data handler uses the information in the data stream to create, name, and populate a business object instance of the specified type. String-to-business-object conversion is useful when the connector needs to send an event to an integration broker. The application sends this event as serialized data having a particular MIME type, to the connector.

Figure 3 illustrates the data handler in the context of a connector when the data handler performs a string-to-business-object conversion.

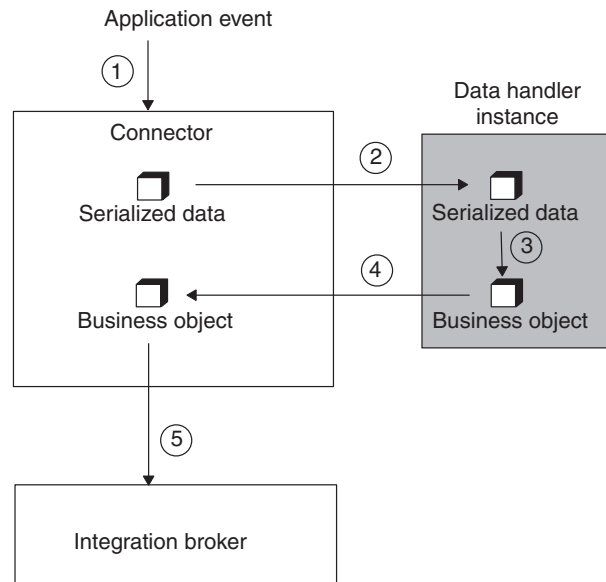

Figure 3. String-to-business-object conversion in the connector context

1. The connector detects an application event. The event may be in the form of an email, a text file, an XML document, or any other common format for which a data handler exists.
2. The connector creates an instance of a data handler to handle the event (using the `createHandler()` static method in the `DataHandler` base class).
For more information about how a connector instantiates the data handler, see “Instantiation in the context of a connector” on page 16.
3. The connector sends in the serialized data as an argument to the `getBO()` method of the data-handler instance. The data handler builds an instance of a business object.
The connector might also specify the business object to which the `getBO()` method converts the data. Some connectors specify the business object type; others assume that the data handler can extract the business object type from the serialized text. The data handler parses the data and populates the attribute values for the business object based on the serialized data.
4. The data handler returns the business object to the connector.
5. The connector sends the business object to the integration broker.

Data handlers in the context of the Server Access Interface

In a call-triggered flow, an access client interacts with a data handler to convert data. An *access client* is an external process that uses the Server Access Interface to interact with InterChange Server Express. When an access client calls either the `ItoExternalForm()` or `IcreateBusinessObjectFrom()` method of the Server Access Interface API, it initiates a call to a data handler. The Server Access Interface, which runs as part of the InterChange Server Express process, actually invokes the data handler.

InterChange Server

The Server Access Interface is an API that allows an access client to execute a collaboration inside InterChange Server. This interface is available for use *only* when InterChange Server is the integration broker. For more information on this interface and on access clients, see the *Access Development Guide* in the IBM WebSphere InterChange Server documentation set.

An access client might be a servlet that handles a request from a client browser. The request might be a request for data, an order request, or another type of business-to-business transaction. As another example, an access client might be a C++ or Java program that uses the Server Access Interface to access InterChange Server Express and exchange data with another application.

When an access client initiates a call that requires a data handler, the data handler runs as part of the InterChange Server process. Figure 4 illustrates the data handler in the context of the Server Access Interface. In this example, the access client is a Web server and servlet.

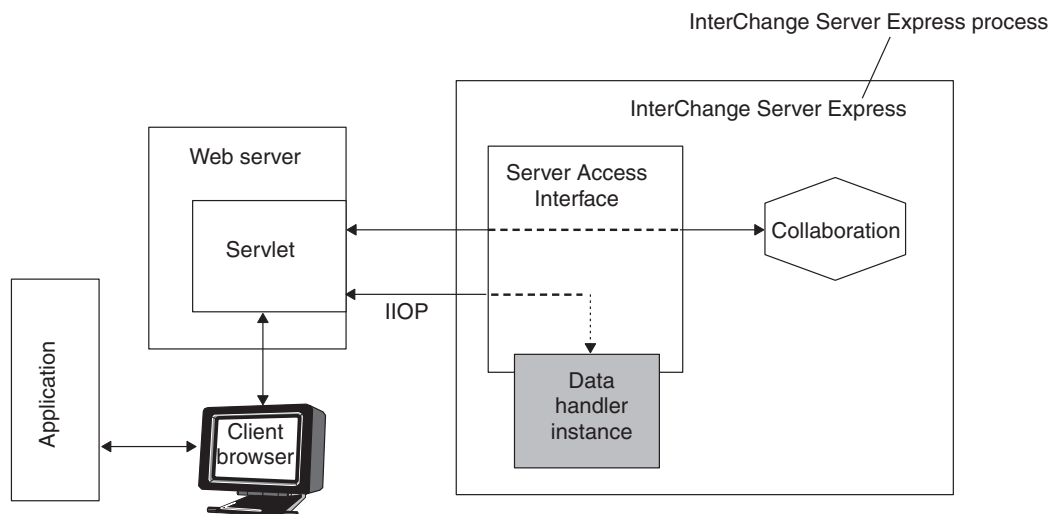

Figure 4. Data handler in the context of the Server Access Interface

The data conversion reflects the business object requirements and the direction of the flow:

- Receiving a business object from InterChange Server Express requires that the access client ask the data handler for a business-object-to-string conversion.
- Sending data to InterChange Server Express requires that the access client ask the data handler for a string-to-business-object conversion.

Server Access Interface business-object-to-string conversion: For a business-object-to-string conversion, the data handler receives a business object as the result of the execution of a collaboration. The data handler uses the information in the business object to create a stream or string of data. This data is in the format associated with the data handler, usually of a particular MIME type. The access client often sends the resulting business object to the application as serialized data.

Figure 5 illustrates the data handler in the context of the Server Access Interface when the data handler performs a business-object-to-string conversion for an access client.

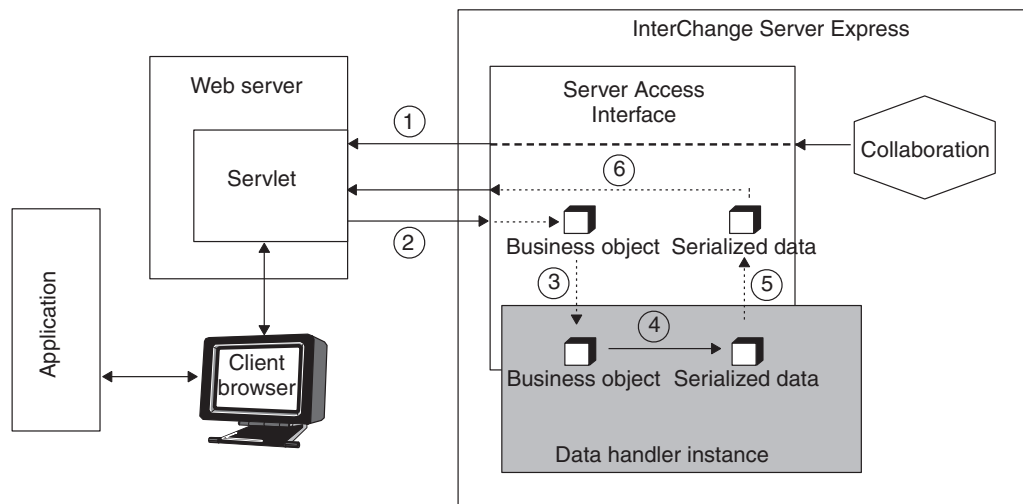

Figure 5. Business-object-to-string conversion in the Server Access Interface context

1. The collaboration returns the requested data or the results of requested actions to the access client.
2. To convert the business object to the required format, the access client sends the business object as an argument to the `ItoExternalForm()` method of the Server Access Interface.
3. The Server Access Interface takes the following actions:
 - Create an instance of a data handler to handle the conversion (using the `createHandler()` static method in the `DataHandler` base class).
 - Send in the serialized data as an argument to one of the following data-handler methods:
 - `getStreamFromBO()`
 - `getStringFromBO()`
 - `getByteArrayFromBO()`
4. The data handler parses the business object to create the serialized data.
5. The data handler returns the serialized data to the Server Access Interface.
6. The Server Access Interface returns the serialized data to the access client.

Server Access Interface string-to-business-object conversion: For a string-to-business-object conversion, the data handler receives a stream or string of data. The data handler uses the information in the data stream to create, name, and populate a business object instance of the specified type. String-to-business-object conversion is useful when the access client needs to send a business object to a collaboration in InterChange Server Express. The access client sends the serialized data, usually having a particular MIME type, to the data handler.

Figure 6 illustrates the data handler in the context of the Server Access Interface when the data handler performs a string-to-business-object conversion for an access client.

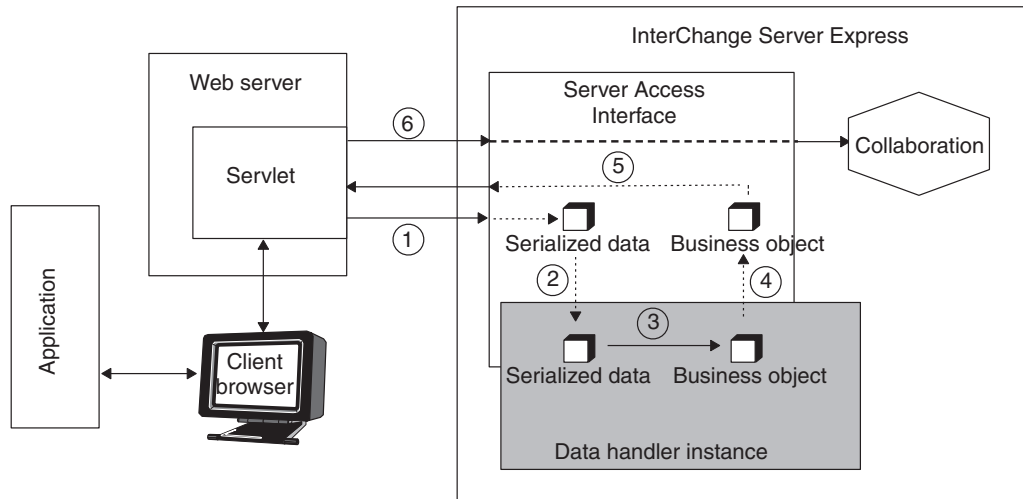

Figure 6. String-to-business-object conversion in the Server Access Interface context

1. To convert serialized data to a business object, the access client sends the serialized data as an argument to the `IcreateBusinessObjectFrom()` method of the Server Access Interface.
2. The Server Access Interface takes the following actions:
 - Create an instance of a data handler to handle the conversion (using the `createHandler()` static method in the `DataHandler` base class).
 - Send in the serialized data as an argument to the `getBO()` method of the data handler instance.
3. The data handler builds an instance of a business object.
The data handler parses the data and populates the attribute values for the business object based on the serialized data.
4. The data handler returns the business object to the Server Access Interface.
5. The Server Access Interface returns the business object to the access client.
6. The access client calls a collaboration that uses the business object data in a business process.

Data handler instantiation

Data handlers are implemented as a library of classes that a connector or the Server Access Interface (for an access client communicating with the Business Integration Express integration broker) can use. The `DataHandler` base class is an abstract class. Therefore, to instantiate a data handler, you must instantiate one of the `DataHandler` subclasses. Each data handler, either an IBM-delivered data handler or a custom data handler, is a subclass of the `DataHandler` base class. The method to instantiate an instance of a data handler is `createHandler()`.

The `createHandler()` method uses information in the *data-handler meta-objects* to determine which data handler to instantiate and how to initialize this data handler. A data-handler meta-object is a hierarchical business object that can contain any number of child objects. The data-handler configuration information is arranged in the following hierarchy:

- The *top-level* meta-object contains information about the MIME types that the different data handlers can support. Each top-level attribute is a cardinality 1 attribute that references the child meta-object for a data handler instance. Each

attribute represents one MIME type and its attribute type indicates the child meta-object for the data handler that can manipulate this MIME type.

- The *child* meta-object contains the actual configuration information for a particular data handler. Each attribute represents a configuration property and provides information such as its default value and type.

Note: A data handler is not required to use meta-objects to hold configuration information. However, *all* IBM-delivered data handlers are designed to use meta-objects for their configuration information.

The `createHandler()` method takes the following steps to instantiate a data handler:

- “Identifying the data-handler class”
- “Setting data-handler configuration properties” on page 15
- “Setting the business-object prefix” on page 15

Identifying the data-handler class

For a data handler to be created, an implementation of the `DataHandler` base class must be instantiated. The data-handler instantiation method derives the name of this data-handler class from one of two values, which is passed in as an argument to the `createHandler()` method:

- The class name of the data handler to instantiate
- The MIME type of the data to convert

Using a class name

If the data-handler caller passes in a class name as an argument, `createHandler()` instantiates a data handler of that class name. It looks for the specified class in the following places:

1. `CwDataHandler.jar` file
2. `CwXMLDataHandler.jar` file
3. `CustDataHandler.jar` file
4. Elsewhere in the CLASSPATH

If the caller provides *only* the class name for the data handler, `createHandler()` neither looks for data-handler meta-objects nor sets configuration properties from these objects. Therefore, a data handler instantiated in this way does *not* require meta-objects. For more information on whether a custom data handler should use meta-objects, see “Using data-handler meta-objects” on page 133.

Using a MIME type

If the data-handler caller does *not* pass in the class name as an argument, the `createHandler()` method requires a value for a MIME type. When a calling component (connector or access client) passes a MIME type, `createHandler()` uses the child data-handler meta-object associated with that MIME type to derive the class name and other configuration information for the data handler instance.

Note: For more information on meta-objects, see “Configuring data handlers” on page 21. For more information on whether a custom data handler should use meta-objects, see “Using data-handler meta-objects” on page 133.

To derive a class name from a specified MIME type, the `createHandler()` method takes the following steps:

1. Convert the MIME type to a MIME-type string

When the `createHandler()` method searches the top-level data-handler meta-object, it converts any non-alphanumeric characters, such as a hyphen (-), period (.) or slash (/), to an underscore (_). For example, if the MIME type is `text/html`, `createHandler()` parses the type to the string `text_html`.

The `createHandler()` method performs this conversion of non-alphanumeric characters in stages, so that matches of MIME type names that contain periods can occur. However, Business Object Designer Express does not allow the period character in attribute names. Therefore, IBM recommends that you do *not* include them in the MIME type names.

You can create unique MIME type/subtype combinations to indicate variations on a particular MIME type. In the MIME-type name, you separate the MIME type and subtype with a non-alphanumeric character (such as a hyphen or underscore). However, because `createHandler()` replaces any non-alphanumeric character with an underscore, IBM recommends that you use only an underscore to separate the MIME type and subtype. If the MIME type is `text/xml-sgml`, the method converts the type to the string `text_xml_sgml`.

2. Obtain the name of the top-level data-handler meta-object from a static property in the `DataHandler` base class. In this top-level meta-object, `createHandler()` looks for an attribute that matches the MIME-type string of the data to convert.
3. If `createHandler()` locates a matching MIME-type string in the top-level meta-object, `createHandler()` takes the following steps:
 - a. If the caller supplied a value for the business-object prefix (an optional third argument) to `createHandler()`, interpret this value as a MIME subtype and append it to the MIME type to create a MIME-type string of the form:
`MIMETypeString_BOPrefix`
If no attribute of this name exists, `createHandler()` looks for an attribute that matches *only* the MIME type. For example, if the caller passes in a MIME type of `edi` and a business-object prefix of `x12`, `createHandler()` looks for an attribute in the top-level meta-object named “`edi_x12`”. If no attribute by this name exists, `createHandler()` looks for an attribute named “`edi`”.
 - b. Obtain the associated child data-handler meta-object, which contains the configuration properties for the data handler instance to use (for example, a possible configuration property might identify which character to use for the data handler delimiter).
 - c. Retrieve the value of the `ClassName` attribute from the child meta-object.
 - If the `ClassName` attribute contains a value, `createHandler()` instantiates a data handler of this class name. Part of the process of implementing a data handler is the creation of the associated child data-handler meta-object. At this time, the developer who implements the data handler can add the class name to the `ClassName` attribute of the child meta-object. This `ClassName` value is required if the class name is different from the default class name, as described in 4a.
 - If this `ClassName` attribute does *not* contain a value, `createHandler()` builds a class name for the data handler it instantiates, as described in 4a.
4. If the `createHandler()` method does *not* find a matching MIME-type string in the top-level meta-object, it builds a class name of the data handler that it will instantiate, as follows:
 - a. Append the MIME-type string to the name of the base data handler package:
`com.crossworlds.DataHandlers`

For example, if the MIME-type string is `text_html`, the resulting string is:
`com.crossworlds.DataHandlers.text.html`

- b. If the method can locate the generated class name on the CLASSPATH, it instantiates this class. It looks for this class in the following places:
 - `CwDataHandler.jar` file
 - `CustDataHandler.jar` file
 - Elsewhere in the CLASSPATH

Using a class name and MIME type

If the caller provides *both* the class name and the MIME type, `createHandler()` takes the following actions:

- Create a data handler of the specified class. To locate this class, the data handler looks in the directories listed in “Using a class name” on page 13.
- Use the child meta-object associated with the MIME type to initialize the configuration options of this data handler. For information on how `createHandler()` determines the child meta-object from the MIME type, see “Using a MIME type” on page 13

In other words, when the caller provides a class name, this class name *overrides* the class name specified in the `ClassName` attribute of the child meta-object.

Setting data-handler configuration properties

All IBM-delivered data handlers (see Table 3 and Table 4) are designed to use data-handler meta-objects for their configuration information. A data-handler meta-object is a hierarchical business object:

- In the top-level data-handler meta-object, each attribute is identified with a MIME type and represents a child data-handler meta-object.
- The child data-handler meta-object contains configuration information for the data handler associated with the MIME type.

The IBM-delivered data handlers use the configuration information in its associated a child data-handler meta-object to initialize its properties. Therefore, IBM delivers a child meta-object for each of its delivered data handlers (see Table 8).

Note: For a description of data-handler meta-objects, see “Configuring data handlers” on page 21.

After the `createHandler()` method instantiates the data handler instance, it calls a special protected method, `setupOptions()`, to initialize the data handler’s configuration with the values in the appropriate child data-handler meta-object.

Note: A custom data handler is not required to use meta-objects to initialize its configuration. If the data handler has an associated child meta-object, the `createHandler()` method does not call `setupOptions()` for the data handler. For more information, see “Setting up other business objects” on page 151.

For more information on meta-objects, see “Configuring data handlers” on page 21.

Setting the business-object prefix

The `createHandler()` method can accept an optional business-object prefix as its third argument. It uses this argument to determine the MIME type name (see “Using a MIME type” on page 13). After `createHandler()` has instantiated the data

handler instance and set its configuration properties, its final task is to set the value of the BOPrefix configuration option (if one exists) in the data handler to the value of this third argument.

Note: Any data handler that uses a BOPrefix configuration option (such as the XML data handler) prepends this prefix to business-object names.

The data handler can prepend this prefix to the names of any business objects that it creates (during string-to-business-object conversion). It puts an underscore (_) between the prefix and the business-object name. For example, a connector might invoke the XML data handler with the following createHandler() call:

```
createHandler(null, "text/xml", "UserApp");
```

The createHandler() method instantiates the XML data handler and set its BOPrefix attribute to "UserApp". When the XML data handler creates a Customer business object, it:

- Obtains the business object name from the serialized data
- Prepends the "UserApp" prefix to the business object name

The resulting business-object name is "UserApp_Customer".

Calling the data handler

Regardless of the context in which a data handler is called, the data handler is instantiated by the createHandler() method. How that method is called in each context is as follows:

- A connector *explicitly* calls createHandler() to instantiate a data handler.
- An access client calls createHandler() *implicitly*; the Server Access Interface actually calls createHandler() when the access client initiates a data-handler call through one of the following Server Access Interface methods: ItoExternalForm() or IcreateBusinessObjectFrom().

Instantiation in the context of a connector

Figure 7 shows an example of data handler instantiation when the data handler is called in the context of a connector.

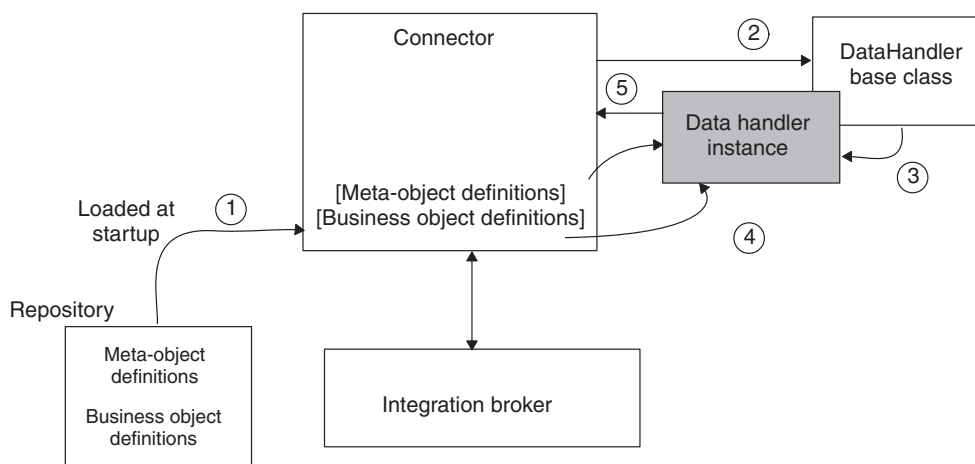

Figure 7. Data handler instantiation in the connector context

To instantiate a data handler called in the context of a connector, the connector takes the following steps:

1. Meta-objects are read into memory when the connector starts up, as long as the meta-objects are included on the list of supported objects for the connector.

Meta-objects are stored in the repository along with business objects. The meta-object definitions, like business object definitions, must exist in memory for the data handler to be able to access them. When these meta-objects are in memory as part of the connector process, the meta-objects are accessible by a data handler called in the context of a connector.

2. The connector calls the `setConfigMObjectName()` static method in the `DataHandler` base class to set a static property in the data handler base class to the name of the top-level meta-object for the data handler.

This top-level meta-object is the connector meta-object (`MO_DataHandler_Default` by default). The top-level meta-object must be part of the connector's supported objects list.

Note: How the connector obtains the name of the data handler top-level meta-object is determined as part of the connector design. For more information, see "Configuring a connector" on page 151.

3. The connector calls the `createHandler()` static method in the `DataHandler` base class to create an instance of the `DataHandler` base class that performs the required data conversion. The name of the class to be created is determined in one of two ways:

- If the connector passes in a class name as an argument, the `createHandler()` method instantiates a data handler of that class name. A connector can explicitly specify a class name when it calls `createHandler()`.
- If the MIME type is passed in instead of the class name, `createHandler()` derives the class name from the MIME type.

The `createHandler()` method converts the MIME type to a MIME-type string and obtains the name of the data handler's top-level meta-object from a static property in the `DataHandler` base class. From this top-level meta-object, `createHandler()` obtains the name of the child meta-object for the data handler. This child meta-object contains configuration information, including the name of the class to instantiate. For information on how this derivation occurs, see "Identifying the data-handler class" on page 13.

4. The data handler performs the required data conversion. The connector agent calls the appropriate `DataHandler` method to perform the required conversion:
 - The `getBO()` method for a string-to-business-object conversion.
 - The `getStringFromBO()` method for a business-object-to-string conversion or the `getStreamFromBO()` method for a business-object-to-stream conversion.
5. The data handler returns the appropriate format to the connector agent.

Instantiation in the context of the Server Access Interface

Figure 8 shows an example of data handler instantiation when the data handler is called in the context of the Server Access Interface.

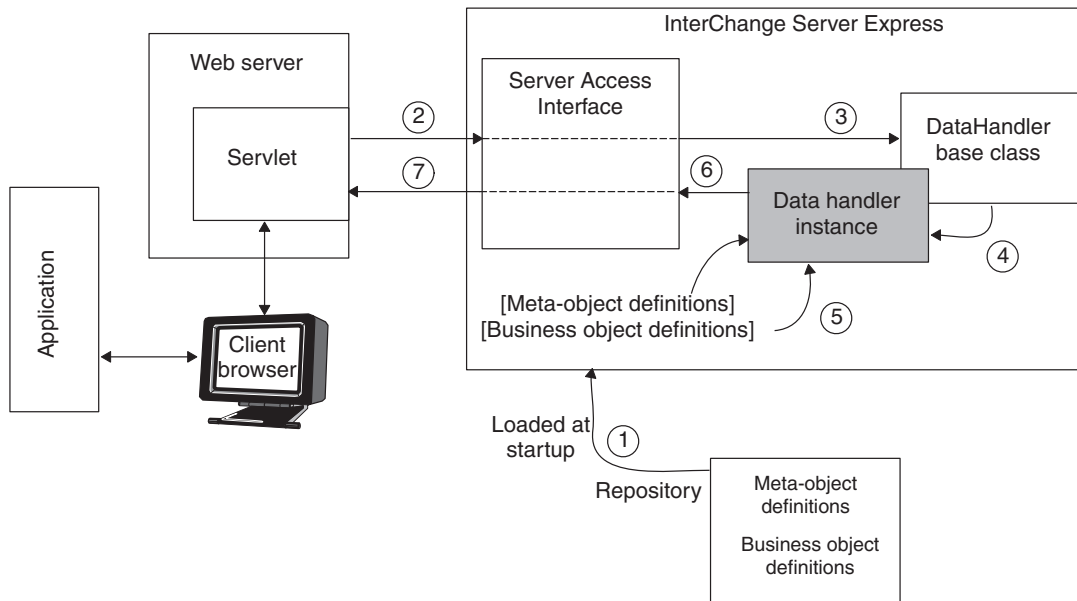

Figure 8. Data handler instantiation in the Server Access Interface context

To instantiate a data handler called in the context of the Server Access Interface, the Server Access Interface takes the following steps:

1. Meta-objects are read into memory when the server starts up, along with all other business object definitions in the repository.

Meta-objects are stored in the repository along with business objects. The meta-object definitions, like business object definitions, must exist in memory for the data handler to be able to access them. Once these meta-objects are in memory as part of the Business Integration Express (and Server Access Interface) process, the meta-objects are accessible by a data handler called in the context of the Server Access Interface.

2. An access client initiates creation of an instance of a data handler with one of the Server Access Interface methods: `IcreateBusinessObjectFrom()` or `ItoExternalForm()`.

These methods pass the MIME type of the data to be converted.

Note: Access clients must use Server Access Interface methods to call a data handler. Although these methods indirectly call data handler interface methods, the methods provide only a subset of the data handler interface. For information on the Server Access Interface methods, see the *Access Development Guide*. For information on the methods provided in the data handler interface, see Chapter 9, "Data Handler base class methods," on page 157.

3. The Server Access Interface sets the name of the top-level meta-object for the data handler to `MO_Server_DataHandler`.
4. The Server Access Interface creates an instance of a `DataHandler` subclass to perform the required data conversion (using the `createHandler()` method of the `DataHandler` base class).

When called in the context of the Server Access Interface, the `createHandler()` method does *not* specify a class name. Instead, `createHandler()` converts the MIME type to a MIME-type string and obtains the name of the data handler's top-level meta-object. From this top-level meta-object, `createHandler()` obtains the name of the child meta-object for the data handler. This child meta-object

contains configuration information, including the name of the class to instantiate. For information on how this derivation occurs, see “Identifying the data-handler class” on page 13.

5. The data handler performs the required data conversion. The Server Access Interface calls the appropriate `DataHandler` method to perform the required conversion:
 - The `getBO()` method for a string-to-business-object conversion
 - The `getStringFromBO()` method for a business-object-to-string conversion or the `getStreamFromBO()` method for a business-object-to-stream conversion.
6. The data handler returns the requested format to the Server Access Interface.
7. The Server Access Interface returns the requested format to the access client.

Metadata-driven data handler design

IBM-delivered data handlers are metadata-driven. Metadata is data about the business object that is stored in business object definitions. Metadata in a business object definition provides information describing the data in an instance of the business object. In general, business object metadata includes the structure of the business object, the settings of its attribute properties, and the content of its application-specific information. It also provides instructions on how to process the data.

Connectors are typically designed to use business object metadata when processing business objects. Similarly, data handlers are designed to use business object metadata. For example:

- The XML data handler requires that each business object definition contain application-specific information describing each attribute. This text enables the data handler to identify XML elements, XML attributes, processing instructions, and other types of XML markup.
- The `FixedWidth` data handler uses the value of the business object attribute property `MaxLength` to parse fixed-width strings.
- The `NameValue` data handler uses the name and value of business object attributes.

A metadata-driven data handler handles each business object that it supports based on metadata encoded in the business object definition rather than on information hard-coded in the data handler. Therefore, a data handler can handle new or modified business objects without requiring modifications to the data handler code.

Chapter 2. Installing and configuring data handlers

This chapter describes how to install and configure data handlers. It also discusses how to configure a connector to support data handlers. This chapter contains the following sections:

- “Installing data handlers”
- “Configuring data handlers”
- “Configuring a connector to use data handlers” on page 25

Installing data handlers

The IBM WebSphere Business Integration Server Express product includes the base data-handler file, `CwDataHandlers.jar`, as well as the XML data handler, `CwXMLDataHandler.jar`. Therefore, this product includes the data handlers that Table 3 on page 5 lists. The Server Access Interface process (within InterChange Server Express) can access any of the data handlers in the `CwDataHandlers.jar` file. The InterChange Server Express Installer automatically installs this data-handler file. For the use of the InterChange Server Express Installer, follow the instructions in *Installing WebSphere Business Integration Express*.

When the installation is complete, the files in Table 6 are installed in the product directory on your system.

Table 6. Installed file structure for data handlers in WebSphere Business Integration Express

Directory	Description
DataHandlers	Contains the file <code>CwDataHandler.jar</code> for compiled versions of the IBM-delivered data handlers and the file <code>CwXMLDataHandler.jar</code> , which contains the separate XML Data Handler.
DataHandlers\repository\DataHandlers	Contains text files with meta-object definitions for data handlers called in the context of the Server Access Interface (used with InterChange Server Express).

Configuring data handlers

Data-handler meta-objects allow a connector or Server Access Interface process to instantiate a data handler based on the MIME type of an input file or the MIME type specified in a business object request. To configure a data handler, you must ensure that its meta-objects are correctly initialized and available to the calling components (a connector or an access client).

Note: Each IBM-delivered data handler uses configuration properties that are defined in data-handler meta-objects.

In support of the IBM-delivered data handlers, IBM delivers the data-handler meta-objects listed in Table 7.

Table 7. IBM-delivered data-handler meta-objects

Meta-object level	Quantity	Location
Top-Level		

Table 7. IBM-delivered data-handler meta-objects (continued)

Meta-object level	Quantity	Location
For InterChange Server Express	One	repository\edk
For connector	One	DataHandlers\repository\ DataHandlers
Child	One for each data handler	DataHandlers\repository\ DataHandlers

To configure the use of one or more data handlers for use by a caller, you must:

- In a top-level meta-object, provide the caller with the supported MIME types and their associated data handlers.
- In a child meta-object, provide the caller with the appropriate configuration information for the desired behavior of the data handler.

Top-level meta-objects

A top-level data-handler meta-object associates a MIME type with a child data-handler meta-object. The child meta-object provides configuration information, which always includes the name of the data handler class to instantiate. Therefore, a top-level meta-object associates a MIME type with a data handler. All calling components with access to a particular top-level meta-object can invoke any of the data handlers whose MIME type appears in this meta-object.

You can control which data handlers a calling component can support by grouping the appropriate MIME-type attributes in a particular top-level meta-object and having the calling component provide the name of the meta-object that contains the data handlers it needs to use. IBM delivers the following top-level data-handler meta-objects:

- `MO_Server_DataHandler` to identify data handlers that are available to access clients that invoke data handlers.
- `MO_DataHandler_Default` to identify data handlers that are available to connectors that invoke data handlers.

MO_Server_DataHandler meta-object

The Server Access Interface process uses the `MO_Server_DataHandler` meta-object to identify the data handlers it can use. The delivered version of `MO_Server_DataHandler` is not configured to support any MIME types. It includes only a single dummy attribute. You can customize this meta-object to support any data handler installed with your WebSphere Business Integration Express. If you want your access clients to support a MIME type, rename the dummy attribute in the top-level `MO_Server_DataHandler` meta-object to the name of the supported MIME type and provide the associated child meta-object for that MIME type.

For example, to provide access clients with support for the `text_xml` MIME type, rename the dummy attribute to `text_xml` and provide the name of the MIME type's associated child meta-object as the attribute's type. This child meta-object configures the XML data handler. Figure 9 illustrates a `MO_Server_DataHandler` meta-object that contains one attribute, `text_xml`, which represents the `MO_DataHandler_DefaultXMLConfig` child meta-object.

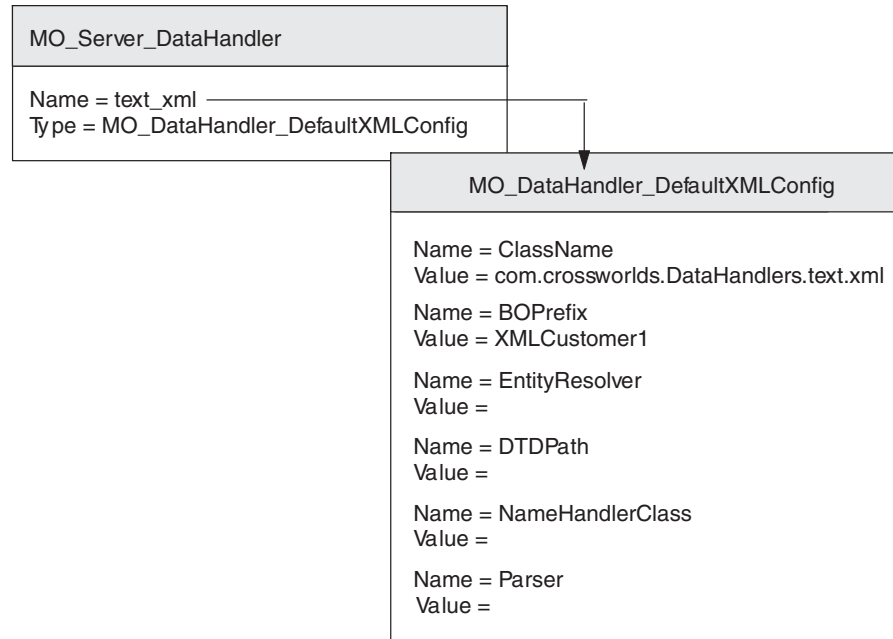

Figure 9. *MO_Server_DataHandler* meta-object

If you want your access clients to support additional MIME types, define a new attribute in the top-level `MO_Server_DataHandler` meta-object for each MIME type and provide the associated child meta-object for that MIME type. If you are invoking more than one data handler, you must define a child meta-object for each data handler instance. To provide support for an additional MIME type, you can either:

- Add any of the MIME types supported by the IBM-delivered data handlers (see Table 3 on page 5 and Table 4 on page 5) to the top-level data-handler meta-object.
- Define your own custom MIME type and child meta-object, as long as you have a data handler that supports it.

Note: The name of the top-level server meta-object for data handlers *must* be the default name of `MO_Server_DataHandler`, but you can configure the top-level meta-object to contain any number of child meta-objects.

MO_DataHandler_Default meta-object

By default, a connector uses the `MO_DataHandler_Default` meta-object to identify the data handlers it can use. The delivered version of `MO_DataHandler_Default` is configured to support the MIME types of all IBM-delivered data handlers (including some adapter-specific data handlers that are not covered in this document).

If you want your connector to support different MIME types, you must ensure that an attribute exists in the `MO_DataHandler_Default` meta-object for each MIME type that you want the connector to support. This attribute must specify the appropriate MIME type and represent the associated child meta-object for that MIME type. To provide support for an additional MIME type, you can define your own custom MIME type and child meta-object, as long as you have a data handler that supports it.

Note: You can change the name of the top-level meta-object for connectors to correspond to a particular connector, or even a particular business object or a particular type of file that the connector needs to process. Whatever object you use, however, must be supported by the connector definition, so if you use a different top-level object you must configure the connector definition to support it. For more information, see “Configuring a connector to use data handlers” on page 25.

Figure 10 shows a top-level data-handler meta-object for connectors that defines two data handlers: XML and NameValue.

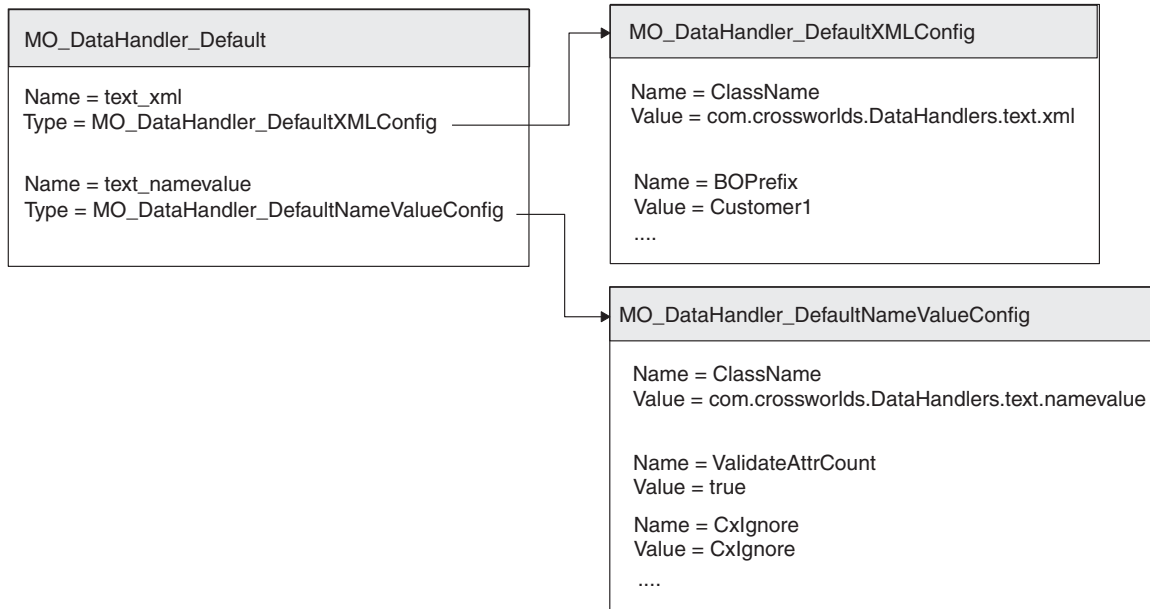

Figure 10. Example meta-object for two different data handlers

Note: For a connector to be able to access a data handler, the top-level data-handler meta-object must be on the list of supported objects for the connector. Otherwise, the connector cannot load the meta-object at startup.

Child meta-objects

A child data-handler meta-object is a flat business object that contains configuration information to initialize a data handler. Different types of data handlers have different configuration requirements, so child meta-objects have different attributes. This configuration information customizes the behavior of the data handler instance. Therefore, a set of attribute values in a child meta-object defines a specific configuration, which in turn is associated with a particular data handler behavior. All callers that access a particular child meta-object invoke the behavior of the associated data handler that the configuration information defines.

- If all callers that access a given top-level meta-object require *only one* behavior of a particular data handler, provide appropriate configuration information in a child meta-object and associate this child meta-object with data handler’s MIME type in the top-level meta-object.

For example:

- For all connectors to access the particular data-handler behavior, make sure that the child meta-object is associated with the data handler’s MIME type in the top-level meta-object for connectors (MO_DataHandler_Default by default).

- For all access clients to access the particular data handler behavior, make sure that the child meta-object is associated with the data handler’s MIME type in the top-level meta-object for the server, `MO_Server_DataHandler`.
- If callers that access a given top-level meta-object require *more than one* behavior of a particular data handler, create a child meta-object with the appropriate configuration information for each data-handler behavior and associate each child meta-object with a unique MIME-type name (in the top-level data-handler meta-object).

IBM recommends that you name the child meta-objects with a unique MIME type/subtype combination:

`text_MIMEtype_subtype`

where:

- The MIME type (*MIMEtype*) represents the MIME type that the data handler supports.
- The MIME subtype (*subtype*) represents the particular behavior of the data handler.

For example, if all connectors can support *both* the default XML data handler and an SGML version, you can create the following MIME types: `text_xml` and `text_xml_sgml`. Keep in mind that MIME-type names can only contain alphanumeric characters and the special characters of period (.) and underscore (_).

IBM delivers a child data-handler meta-object for each of the data handlers it delivers, as Table 8 shows.

Table 8. Child data-handler meta-objects

Child meta-object	For more information
<code>MO_DataHandler_DefaultXMLConfig</code>	“Configuring the XML data handler” on page 35
<code>MO_DataHandler_DefaultFixedWidthConfig</code>	“Configuring the FixedWidth data handler” on page 104
<code>MO_DataHandler_DefaultDelimitedConfig</code>	“Configuring the Delimited data handler” on page 112
<code>MO_DataHandler_DefaultNameValueConfig</code>	“Configuring the NameValue data handler” on page 120
<code>MO_DataHandler_DefaultRequestResponseConfig</code>	“Configuring the Request-Response data handler” on page 95

Configuring a connector to use data handlers

If a data handler is to run in the context of a connector, you must configure the connector to use a data handler:

- A connector must have access to the data-handler meta-object in order to instantiate a data handler.

Before invoking a data handler for the first time, a connector sets a static property in the data handler base class to the name of a top-level data-handler meta-object. From this top-level meta-object, the data handler obtains its configuration information. Each time the data handler is subsequently instantiated, the configuration properties for that data handler instance are obtained. The data handler must have access to this configuration information to do its work.

- To instantiate the data handler, the connector must know either the name for the data handler class or the MIME type of the data.

When a connector calls `createHandler()` to invoke a data handler, it passes in either the class name or the MIME type for the data.

- If the connector passes in the MIME type, the `createHandler()` method checks the top-level data-handler meta-object for an attribute whose name matches the MIME type. If a matching attribute is found, the `createHandler()` method checks for the value of the `ClassName` attribute in the child meta-object that is associated with the MIME type.
- If the connector passes in a class name, the `createHandler()` method instantiates a data handler of that class name.

If the connector does not pass in the correct class name or MIME type, the instantiation process fails. For more information, see “Identifying the data-handler class” on page 13.

Connectors are configured to obtain this configuration information in different ways. For example:

- The Adapter for XML has a configuration property, `DataHandlerConfigMO`, that specifies the name of the top-level meta-object. If this property is not filled in, the connector cannot find the meta-object. In addition, any top-level business object for the XML connector must have a `MimeType` attribute that specifies the MIME type of the data in the business object. The connector uses the `MimeType` attribute value to invoke the appropriate data handler.
- The Adapter for JText has its own configuration meta-object, which has `ClassName`, `DataHandlerConfigMO` and `MimeType` attributes to specify the name of the class, data-handler meta-object, and the MIME type for a file, respectively.

Other connectors may have different ways of configuring the use of a data handler. See the adapter guide for the connector for more information.

If the connector cannot find the data handler top-level meta-object, or it cannot determine the class name or MIME type, then it cannot create the data handler. Therefore, when you are configuring a connector to use a data handler, be sure to:

1. Determine how to configure the name of the top-level data-handler meta-object for the connector. Make sure that the spelling of the meta-object name is correct.
2. Determine how to configure the MIME type. Make sure that the MIME type is spelled correctly.
3. Make sure that the top-level data-handler meta-object is in the supported objects list for the connector.
4. Make sure that the child meta-object for the data handler has the value of the data handler class name (in the `ClassName` attribute) specified correctly.

Chapter 3. XML data handler

The IBM WebSphere Business Integration Data Handler for XML, called the *XML data handler*, converts business objects into XML documents and XML documents into business objects. For instructions on installing the XML data handler, see “Installing data handlers” on page 21.

Note: The XML data handler supports XML version 1.0.

This chapter describes how the XML data handler processes XML documents and how to define business objects to be processed by the XML data handler. It also discusses how to configure the XML data handler. This chapter contains the following sections:

- “Overview”
- “Requirements for business object definitions” on page 30
- “Configuring the XML data handler” on page 35
- “XML documents that use DTDs” on page 38
- “XML documents that use schema documents” on page 50
- “Creating business object definitions” on page 76
- “Converting business objects to XML documents” on page 78
- “Converting XML documents to business objects” on page 81
- “Customizing the XML data handler” on page 82

Overview

The XML data handler is a data-conversion module whose primary role is to convert business objects to and from XML documents. An XML document is serialized data with the text/xml MIME type. The XML data handler can be used by connectors and by access clients.

This overview provides the following information about the XML data handler:

- “Processing XML documents and business objects”
- “XML data handler components” on page 28

Processing XML documents and business objects

XML documents use a template, called a schema, to define their structure. Table 9 shows the most common data models for defining this schema.

Table 9. XML data models

XML data model	For more information
Document type definitions (DTDs) Schema documents	“XML documents that use DTDs” on page 38 “XML documents that use schema documents” on page 50

Just as a DTD or a schema document describes the structure of the XML document, the business object definition describes the structure of the business object. The XML data handler uses business object definitions when it converts between business objects and XML documents. It determines how to perform the conversion

using the structure of the business object definition and its application-specific information. A properly-constructed business object definition ensures that the data handler can correctly convert a business object to an XML document and an XML document to a business object. Before the XML data handler can perform a conversion between XML document and business object, it must be able to locate the associated business object definition.

Use of the XML data handler to convert an XML document to a business object or a business object to an XML document requires that the following steps occur.

Table 10. Using the XML data handler

Step	For more information
1. Business object definitions that describe the XML and business-object structure must exist and be available to the XML data handler when it executes. 2. The XML data handler must be configured for your environment. 3. The XML data handler must be called from a connector (or access client) to perform the appropriate data operation: a) Data operation: receive a business object from the caller, convert the business object to an XML document, and pass the XML document to the caller. b) Data operation: Receive an XML document from the caller and use the name handler and SAX parser to build a business object. Then return the business object to the caller.	"Requirements for business object definitions" on page 30 "Creating business object definitions from DTDs" on page 49 "Configuring the XML data handler" on page 35 "Converting business objects to XML documents" on page 78 "Converting XML documents to business objects" on page 81

XML data handler components

The XML data handler uses following components to convert XML data to a business object:

- Name handler
- Simple API for XML (SAX) parser
- (Optional) If the XML document has a DTD and it includes entity references, the XML data handler uses an additional component—the entity resolver—to resolve the references.

Figure 11 illustrates the XML data handler components and their relationship to one another. These components are described in the sections that follow.

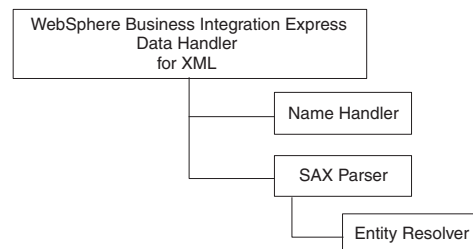

Figure 11. XML data handler components

Name handler

The XML data handler uses the name handler to extract the name of the business object from an XML message. The data handler invokes an instance of the name handler based on the value of the `NameHandlerClass` attribute in the XML data handler child meta-object:

- If a class name is provided in the `NameHandlerClass` attribute, the XML data handler uses that name handler to determine the business object name.
- If no class name is provided, the data handler uses the default name handler to determine the business object name. The default name handler uses the name of the root element in the XML document and `BOPrefix` property to form the business object name:

`BOPrefix_rootElement`

For information on how to create a custom name handler, see “Building a custom XML name handler” on page 82.

SAX parser

If a parser is *not* specified in the Default Value property of the Parser attribute in the XML child meta-object, the data handler uses the default SAX Parser:

`org.apache.xerces.parsers.SAXParser`

To use a validating parser, you can take either of the following steps:

- Set the Default Value property of the `Validation` attribute in the XML child meta-object to true. The Default Value that IBM provides for this attribute is false.
- To use a validating SAX parser from IBM, change the class name in the Default Value property of the Parser attribute to:

`com.ibm.xml.parsers.ValidatorSaxParser`

If your business object definitions are based on DTDs, use the local entity resolver, and provide a Default Value for the document type definition (DTD) or schema path in the `DTDPath` attribute. Make sure you place all the DTD's or Schema files in the location specified in the `DTDPath` attribute.

Note: When using a validating parser, make sure that you are using the correct `EntityResolver` and that the `DTDPath` is set correctly. For instruction on how to do this, see “Configuring the XML data handler” on page 35.

Alternatively, you may use the non-validating SAX Parser from IBM. To use this parser, set the Default Value property of the Parser attribute of the XML child meta-object to the value `com.ibm.xml.parsers.SAXParser`.

Entity resolver

The entity resolver specifies how the SAX parser resolves external references (such as references to DTDs and schema documents) in XML data. If the XML document contains entity references, the SAX parser invokes an instance of the entity resolver using the `EntityResolver` attribute in the XML data handler configuration meta-object.

External references are handled differently depending on the entity-resolver class that `EntityResolver` specifies. Table 11 shows the entity-resolver classes that the XML data handler provides.

Table 11. Entity-resolver classes for the XML data handler

Entity-resolver class	Description
DefaultEntityResolver	This class is the default entity resolver. If this entity resolver is invoked, all external references are ignored.
LocalEntityResolver	The local entity resolver processes external references as local file names. Its behavior depends on the data model used for validation: <ul style="list-style-type: none"> • If DTDs are used for validation, the local entity resolver substitutes the path in the systemID with the value of the DTDPATH meta-object attribute, if the systemID starts with file:// or http:// and the DTDPATH attribute is set. The external reference is ignored if the systemID is not a path name or the DTDPATH attribute is not set. • If schema documents are used for validation, the local entity resolver substitutes the path that the schemaLocation or noNamespaceSchemaLocation attribute specifies with the value of the DTDPATH meta-object attribute, if path starts with file:// or http://, or it contains a DOS filename (for example, "D:\xmlschemas\test").
URIEntityResolver	This entity resolver processes external references as local file names or downloadable URLs. It dynamically resolves the external reference in either of the following cases: <ul style="list-style-type: none"> • If DTDs are used for validation: if the DOCTYPE contains a SYSTEM value that begins with http:// or file:// • If schema documents are used for validation: if the schemaLocation or noNamespaceSchemaLocation attribute begins with http:// or file:// <p>The entity resolver then opens an HTTP connection and downloads the DTD or schema document from the specified web site.</p> <p>Attention: The XML data handler does <i>not</i> cache the DTDs or schema documents. When the data handler uses the URIEntityResolver class as its entity resolver, it opens an HTTP connection <i>each time</i> it parses the XML document. Therefore, network traffic can impact the performance of the XML data handler.</p>

Note: All entity-resolver classes in Table 11 must have the following class prefix:
com.crossworlds.DataHandlers.xml

If your XML documents use schema documents, any external schemas that the schema document includes are also treated as external entities. Therefore, the SAX parser invokes an entity resolver to resolve these included schema documents. If the XML document uses the schemaLocation or noNamespaceSchemaLocation to specify schema locations, you can set the EntityResolver attribute to either LocalEntityResolver or URIEntityResolver for validation of external schema documents (either included or imported).

If you need to specify another way to find external entities, you must create a custom entity resolver. For information on creating a custom entity resolver, see "Building a custom entity resolver" on page 84.

Requirements for business object definitions

To ensure that business object definitions conform to the requirements of the XML data handler, use the guidelines in this section, which involve:

- "Business object structure" on page 31
- "Business object attribute properties" on page 32

- “Application-specific information” on page 34
- “Business object verbs” on page 35

A properly-constructed business object definition ensures that the data handler can correctly convert a business object to an XML document and an XML document to a business object. For information on how to create business objects for the XML data handler, see “Creating business object definitions from DTDs” on page 49.

Business object structure

To represent a DTD or schema document requires at least two business object definitions:

- The *top-level* business object represents the information that defines the DTD or schema document and must contain the following:
 - An attribute named `XMLDeclaration` to represent the XML version
This attribute must have the `type=pi` tag in its application-specific information.
 - An attribute to represent the root element in the DTD or schema document
This attribute must have as its type a single-cardinality business object, whose type is the business object definition for the root element of the DTD or schema document. The XML ODA obtains the name of this root element from the `Root ODA` configuration property. The application-specific information must list the name of this element with the `elem_name` tag.

Note: The `elem_name` tag replaces previous syntax, which required only the name of the XML element in the business-object attribute’s application-specific information. The XML data handler still supports the old syntax for backward compatibility with existing business object definitions. However, the XML ODA uses the new syntax when it generates business object definitions.

- A *root-element* business object definition represents the XML-definition document’s root element. You can tell the XML ODA which element to consider the root element through its `Root` configuration property. It contains an attribute for each of the XML components in the root element.

A business object that is processed by the XML data handler using business object definitions from DTDs or schema documents must follow these additional rules:

- Every tag in the XML document must have an associated attribute in the business object. The business object definition provides the type of the business object attribute and the application-specific information for that attribute are stored. This information is determined by the structure and content of the XML element.
- In the business object definition for an XML element, all attributes that represent XML attributes must occur *before* other attributes. The XML data handler assumes that attributes for a given XML element are the *first* attributes in the business object definition.

Note: A business object must contain enough data so that the XML data handler can create a valid XML document. Avoid sending the data handler business objects without data.

This document provides the following information about the structure of business object definitions for DTDs and schema documents:

Data model	For more information
Document type definition (DTD)	"Business object structure for DTDs" on page 39
Schema document	"Business object structure for schema documents" on page 51

Business object attribute properties

Business object definitions define attributes. Each attribute has various properties that provide information about the attribute. This section describes how the XML data handler interprets several of these properties and describes how to set them when modifying a business object definition.

Name attribute property

Each business object attribute must have a unique name. The XML Element or XML Attribute name is always specified in the `elem_name` or `attr_name` tag. In this case, the name of the XML element (or attribute) specified in the `elem_name` (or `attr_name`) tag of the attribute application-specific information contains the special characters. However, the name of the business object attribute (which does not allow these special characters) omits them.

Type attribute property

Each business object attribute must have a type, such as Integer, String, or the type of a contained child business object, as follows:

- For a DTD: XML elements that contain either child elements or one or more non-FIXED attributes are treated as business objects. XML elements with only a PCDATA value are treated as attributes if the XML element is included in its parent through single cardinality. If it is included through multiple cardinality, it is represented as a business object because business object definitions do not support multiple-cardinality scalar values (for example, an array of String values).
- For a schema document: Each business object attribute must have a type of either String or the type of a contained child business object. XML elements that contain either child elements or complex types are treated as business objects. XML elements with only a simple-type value are treated as business object attributes if the XML element is included in its parent through single cardinality. If it is included through multiple cardinality, it is represented as a business object because business object definitions do not support multiple-cardinality scalar values (for example, an array of String values).

Note: All simple attributes should be of type String

Key and Foreign Key attribute properties

Each business object must have at least one primary key attribute, which is specified by setting the Key property to true for an attribute. The setting of the Foreign Key property is optional and depends on the structure of the XML document. This section provides the following information about the Key and Foreign Key attribute properties:

- "Designating the key in the business object definition"
- "Handling keys and "required-ness"" on page 33

Designating the key in the business object definition: In earlier versions of XML-business-object-definition-generation tools (such as XMLBorgen, Edifecs SpecBuilder, and the XML ODA), the generation tool designated the `ObjectEventId`

attribute as the key of a parent XML business object. However, as of this release, Business Object Designer Express no longer allows you to save a business object definition that has the ObjectEventId attribute specified as a key.

Because of this restriction, the current version of XML ODA now takes the following actions:

- In each child business object, it sets the first attribute as the key.
- In the parent business object, it does *not* set a key attribute.

To provide a key to a parent business object definition that the XML ODA generates, you must bring up the business object definition in Business Object Designer Express and analyze your business object definition to determine the appropriate attribute to designate as the key. You must change the business object definition's key attribute *before* you can save the business object definition in Business Object Designer Express .

Note: The XML ODA replaces earlier XML-business-object-definition-generation tools (such as XMLBorgen and Edifecs SpecBuilder). Therefore, only the XML ODA takes these special steps to avoid assignment of the ObjectEventId as the parent business object's key attribute. If you have existing XML business object definitions that you have generated with any earlier XML-business-object-definition-generation tools (including an earlier version of the XML ODA), these business object definitions might still use ObjectEventId as a key. You should analyze these business object definitions if you are migrating their business objects to the current release. Failure to set an appropriate key attribute in your business object definition can have a negative impact on the performance of the event sequencing feature.

Handling keys and "required-ness": This document provides the following information about the relationship between keys and "required-ness":

Data model	For more information
Document type definition (DTD)	"Business object attribute properties for DTDs" on page 40
Schema document	"Business object attribute properties for schema documents" on page 59

Required attribute property

If this property is specified for an attribute that contains a single-cardinality child business object, the XML data handler requires that the parent business object contain a child business object for this attribute. The settings of the Cardinality, Key, and Foreign Key attribute properties can affect the setting an attribute's Required property.

This document provides the following information about "required-ness":

Data model	For more information
Document type definition (DTD)	"Business object attribute properties for DTDs" on page 40
Schema document	"Business object attribute properties for schema documents" on page 59

Cardinality attribute property

The Cardinality property indicates the number of child business objects allowed in an attribute that has a business object definition as its type. The setting of this property depends on the structure of the XML document and its elements. Its setting also affects whether the attribute must be required (its Required property set to true).

This document provides the following information about the relationship between cardinality and "required-ness":

Data model	For more information
Document type definition (DTD)	"Business object attribute properties for DTDs" on page 40
Schema document	

Special attribute values

A business object attribute has a value whose type matches the attribute's Type property. In addition, an attribute can have either of two special values:

- CxIgnore

When the XML data handler receives a business object from an integration broker, it ignores *all* attributes with a value of CxIgnore. It is as if those attributes are invisible to the data handler. Therefore, the data handler does *not* generate a corresponding XML element; that is, it does *not* create an XML tag for this attribute (not even an empty tag). When the XML data handler receives XML input that has no XML tag that corresponds to a business object attribute, the data handler assigns the attribute a value of CxIgnore.

- CxBlank

When the XML data handler receives a business object from an integration broker, it processes the CxBlank attribute value based on the attribute's Type property:

- For a complex attribute (one whose Type property is set to the name of another business object definition), the data handler assumes that no complex attributes have the CxBlank value.
- For a simple attribute (one whose Type property is set to a String data type), the data handler creates an empty tag in the XML document. For XML documents based on DTDs, empty double quotation marks (" ") are used as the PCDATA equivalent of CxBlank.

When the XML data handler receives XML input that has an empty tag, the data handler assigns a value of CxBlank to its corresponding business object attribute.

Application-specific information

Application-specific information in business object definitions provides the data handler with instructions on how to convert business objects to XML documents. The application-specific information enables the data handler to process the business object correctly. Therefore, if you create new business objects or modify existing business objects for the XML data handler, make sure that the application-specific information in the business object definition matches the syntax that the data handler expects. The XML data handler can use the following kinds of application-specific information:

- Business-object-level application-specific information provides information about the business object definition as a whole.

- Attribute-level application-specific information provides information about a particular attribute.

Note: The XML data handler uses application-specific information to match components of an XML document with attributes in a business object. The maximum length for application-specific information is 255 characters. If the value of the application-specific information is more than 255 characters, you must reconstruct your DTD or schema document, and then regenerate the business object.

This document provides the following information about application-specific information:

Data model	For more information
Document type definition (DTD)	"Application-specific information for XML components in DTDs" on page 41
Schema document	"Application-specific information for XML components in schema documents" on page 60

Business object verbs

When converting business objects to XML documents, the XML data handler does *not* generate XML for the verb, nor does it set a verb when converting an XML document to a business object. However, verb information can be preserved in one of these ways:

- You can create an element in the DTD or schema document for the verb and create a business object attribute for the verb. You can then design the content of your business integration system to copy the verb into the business object attribute. The data handler then converts the verb to the XML element, thereby preserving the verb in the XML document. When the XML document is returned, the business integration system can set the verb according to the value of the business object attribute.
- You can create DTDs or schema documents for specific business object and verb combinations, and associate each business object request with the DTD or schema document for that business object and verb. When an XML document is converted to a business object and returned to the caller, the connector can set the verb that corresponds to the DTD or schema document.
- If the calling connector can be provided with information about the verb, it can set the verb in the business object before sending it to integration broker.

Configuring the XML data handler

To configure an XML data handler, you must ensure that its configuration information is provided in the XML data handler's child meta-object.

Note: To configure an XML data handler, you must also create or modify business object definitions so that they support the data handler. For more information, see "Requirements for business object definitions" on page 30.

For the XML data handler, IBM delivers the default child meta-object `MO_DataHandler_DefaultXMLConfig`. Each attribute in this meta-object defines a configuration property for the XML data handler. Table 12 describes the attributes in this child meta-object.

Table 12. Child meta-object attributes for the XML data handler

Attribute name	Description	Delivered default value
BOPrefix	Prefix used by the default NameHandler class to build the names of business object names. The default value must be changed to match the name of the associated the business object definition. The attribute value is case-sensitive.	XMLTEST
ClassName	Name of the data-handler class to load for use with the specified MIME type. The top-level data-handler meta-object has an attribute whose name matches the specified MIME type and whose type is the XML child meta-object (described by Table 12).	com.crossworlds. DataHandlers.text.xml
DefaultEscapeBehavior	If an attribute value contains special characters, it requires the XML data handler to perform escape processing. If the attribute's application-specific information does <i>not</i> include the escape tag, the XML data handler checks the value of the DefaultEscapeBehavior property to determine whether to perform escape processing. For more information, see "For an XML element or attribute that contains special characters" on page 47.	true
DTDPath	Used by the data handler to configure the path to the document type definitions (DTDs) or schemas (XSDs).	None
DummyKey	Key attribute; not used by the data handler but required by the business integration system.	1
EntityResolver	Name of the class to use to handle references to external entities such as a DTD or schema. For more information on values for this attribute, see "Entity resolver" on page 29.	None
IgnoreUndefinedAttributes	When this attribute is set to false, the XML data handler validates all XML attributes against the business object definition; it throws an exception when it encounters an undefined attribute. When this attribute is set to true, the XML data handler ignores all undefined XML attributes, generating a warning.	true
IgnoreUndefinedElements	When this attribute is set to false, the XML data handler validates all XML elements against the business object definition; it throws an exception when it encounters an element not defined in the application-specific information. When this attribute is set to true, the XML data handler ignores all undefined XML elements (and any attributes within these undefined elements), generating a warning.	false
InitialBufferSize	Defines the initial size of the buffer that is used when converting business objects to XML. Set this value to the size, in bytes, of your XML business objects. Setting this value to a high number will speed the conversion of business objects to serialized XML.	2 MB (2,097,152 KB)
NameHandlerClass	Name of the class to use to determine the name of a business object from the content of an XML document. Change the default value of this attribute if you create your own custom name handler. For more information, see "Building a custom XML name handler" on page 82.	com.crossworlds. DataHandlers.xml. TopElementNameHandler
Parser	Package name of a SAX-compliant parser for the XML document.	None

Table 12. Child meta-object attributes for the XML data handler (continued)

Attribute name	Description	Delivered default value
UseNewLine	Set to true if you want each tag in the output XML to be on a new line. (The XML data handler adds extra content in the form of line feeds and carriage returns to the XML document.) Set to false if you do not want to alter the XML output.	false
Validation	This value is used by the data handler to specify that the validating parser is used. The data handler does this by setting the feature http://xml.org/sax/features/validation of the xerces parser to true. To use a validating parser, the default value must be changed to true. When Validation is set to true, the XML parser will validate the XML document against: <ul style="list-style-type: none"> • A DTD, if a DTD is present • A schema document, if one is specified. In this case, the XML parser does full schema checking. • Both DTDs and schema documents, if both are specified 	false
ObjectEventId	Placeholder not used by the data handler but required by the business integration system.	None

The “Delivered default value” column in Table 12 lists the value in the Default Value property for the corresponding attribute in the delivered business object. You must examine your environment and set the Default Value properties of those attributes to the appropriate values. You must make sure that at least the `ClassName` and `BOPrefix` attributes have default values.

Note: Use Business Object Designer Express to modify business object definitions.

A single child meta-object can be used by different MIME type/subtype combinations if each of the combinations uses the same XML data handler configuration. If your connector requires different XML data handler configurations for different MIME types, then you must create a separate child meta-object for each data handler instance. To prepare multiple configurations of the XML data handler, take the following steps:

- Copy and rename the default XML child meta-object. A recommended approach to naming a new child meta-object is to provide subtypes to the MIME type. For example, to support both the default XML data handler and an SGML version, you can copy the default XML child meta-object and name this copy `MO_DataHandler_DefaultSGMLConfig`.
- Set the default values of the attributes in each XML child meta-object to configure the data handler instance.

Create attributes in the top-level data-handler meta-object for each MIME type/subtype combination. For example, in support of the XML and SGML, you can create the following MIME types: `text_xml` and `text_xml_sgml`. Each of these attributes would represent its associated child meta-object.

You can also configure the XML data handler to support multiple instances of the same data handler. In this case, you can create another top-level attribute named `text_xml_subtype`, where *subtype* can be an application name, as in `text_xml_AppA`, an application entity name, or another appropriate name.

For more information about how to configure a data handler, see “Configuring data handlers” on page 21.

Figure 12 shows an example of a top-level data-handler meta-object and its corresponding child meta-objects. Notice that there are four attributes in the top-level meta-object `MO_DataHandler_XMLSample`, but only three child meta-objects. This is because the attribute `Application_xml_AppC` uses the same child meta-object as the attribute `text_xml_AppB` to invoke the appropriate data handler.

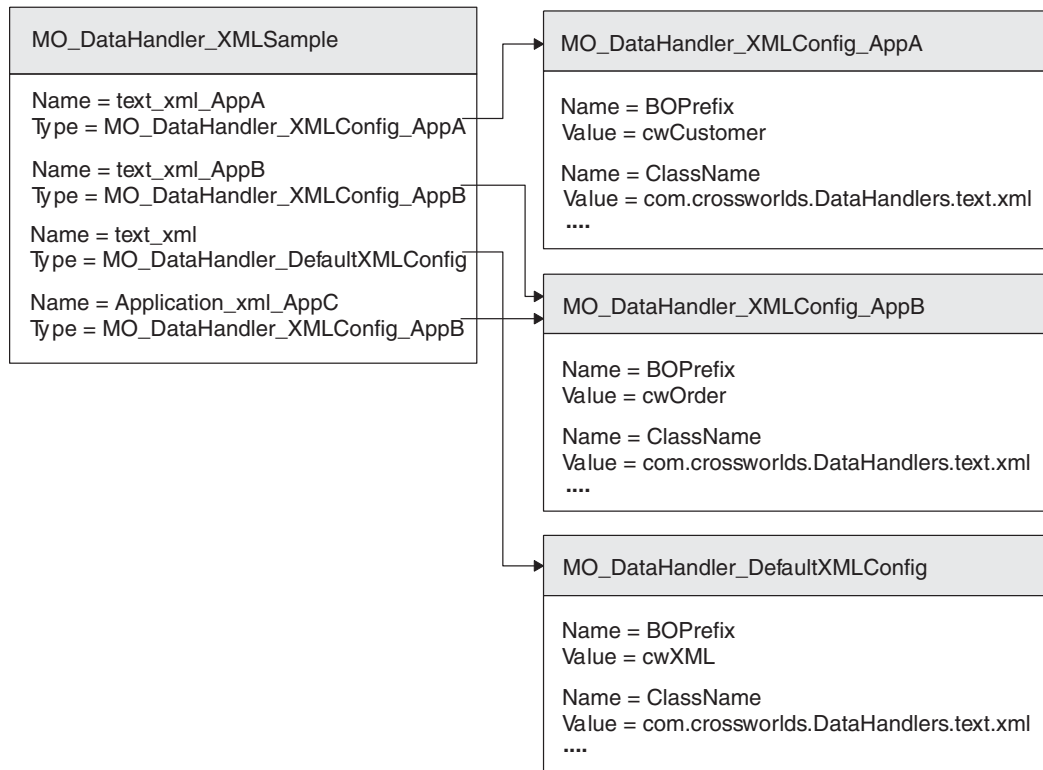

Figure 12. Example meta-object for multiple XML data handlers

XML documents that use DTDs

A *document type document* (DTD) is a data model for XML documents that provides a special syntax to describe the XML document’s template, called a schema. This DTD is a file with the `.dtd` extension. The business object definitions that represent the schema of an XML document use information in the DTD to preserve and record the document’s structure. This section provides the following information about deriving structure information for a business object definition from a DTD:

- “Requirements for business object definitions based on DTDs”
- “Creating business object definitions from DTDs” on page 49

Requirements for business object definitions based on DTDs

To ensure that business object definitions that correspond to DTDs conform to the requirements of the XML data handler, use the guidelines in this section, which involve:

- “Business object structure for DTDs” on page 39
- “Business object attribute properties for DTDs” on page 40
- “Application-specific information for XML components in DTDs” on page 41

A properly-constructed business object definition ensures that the data handler can correctly convert a business object to an XML document and an XML document to a business object. For information on how to create business objects for the XML data handler, see “XML documents that use schema documents” on page 50.

Business object structure for DTDs

To represent a DTD requires at least the two business object definitions described in “Business object structure” on page 31. For a DTD, these business object definitions have the following additional requirements:

- The *top-level* business object represents an XML DTD and can contain the following:
 - An attribute named `DocType` to represent the `DOCTYPE` declaration
Whether the XML ODA generates a `DocType` attribute in the top-level business object definition depends on the setting of its `DocTypeOrSchemaLocation` configuration property. For more information, see “For an XML `DOCTYPE` declaration” on page 48 and “Supported DTD structures” on page 50.
 - An attribute named `XMLDeclaration` to represent the XML version
This attribute must have the `type=pi` tag in its application-specific information. For more information, see “For XML processing instructions” on page 72.
 - An attribute to represent the root element in the DTD
As described in “Business object structure” on page 31, this attribute must have as its type a single-cardinality business object, whose type is the business object definition for the root element. The application-specific information must list the name of this element with the `elem_name` tag. For more information, see “For XML elements” on page 68.
- A *root-element* business object definition represents the DTD’s root element.

A business object that is processed by the XML data handler using business object definitions based on DTDs must also follow these rules:

- Every tag in the XML document has an associated attribute in the business object definition. The exception to this rule is for `FIXED` attributes. By default, `FIXED` attributes are *not* included in a business object definition because these attributes contain static data. However, if you want your `FIXED` attributes to be included in the business object definition, you can manually add attributes for them to the business object definition.

Note: For a list of general business object requirements, see “Requirements for business object definitions” on page 30.

An example DTD for an XML document is shown below. The DTD is named `Order`, and it contains elements that correspond to an application `Order` entity.

```
<!--Order -->
<!-- Element Declarations -->
<!ELEMENT Order (Unit+)>
<!ELEMENT Unit (PartNumber?, Quantity, Price, Accessory*)>
<!ELEMENT PartNumber (#PCDATA)>
<!ELEMENT Quantity (#PCDATA)>
<!ELEMENT Price (#PCDATA)>
<!ELEMENT Accessory (Quantity, Type)>
<!ATTLIST Accessory
    Name CDATA >
<!ELEMENT Type (#PCDATA)>
```

Figure 13 shows the structure of a business object that might be created to correspond to an XML document associated with the `Order` DTD. Note that each

XML element and element attribute in the Order DTD has a corresponding business object attribute. The top-level business object contains attributes for the XML declaration, the DOCTYPE, and the top-level Order element. Note also that the element attribute Name is the first attribute in the Accessory business object.

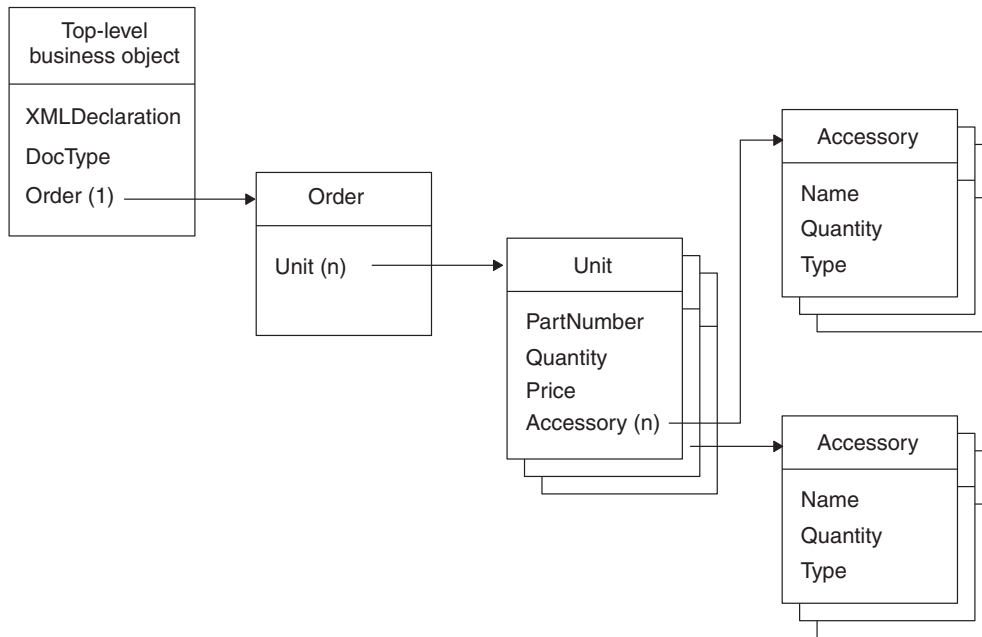

Figure 13. Example business object for XML document using the Order DTD

Business object attribute properties for DTDs

When the business object definitions for an XML document are based on DTDs, the business object attribute properties have the restrictions discussed in “Business object attribute properties” on page 32. In addition, the DTD syntax can determine the “required-ness” of a business object attribute. The “required-ness” is a combination of factors, including cardinality and whether the attribute is a key, that determines whether the XML data handler requires the attribute. If an attribute is required, its Required attribute property must be set to true.

The setting of the Required attribute property depends on the XML element and attribute specifications, as well as the settings of the Cardinality, Key, and Foreign Key attribute properties, as follows:

- The cardinality of a business object attribute is determined by the ELEMENT fragment in the DTD. This cardinality affects whether the attribute is required. Table 13 outlines the cardinality and “required-ness” for possible combinations of element declarations in a DTD.

Table 13. Cardinality and “Required-ness” for a DTD

DTD ELEMENT fragment	Cardinality	Required
None specified	1	Yes
?	1	No
+	N	Yes
*	N	No

- Whether a business object attribute is a primary or foreign key is determined by the ATTLIST fragment in the DTD. The presence of a key affects whether the attribute is required. Table 14 outlines how syntax in the ATTLIST fragment

affects the business object attribute's "required-ness" for possible combinations of attribute declarations in a DTD.

Table 14. Keys and "Required-ness" for a DTD

DTD ATTLIST fragment	Key	Required	Comment
#IMPLIED	No	No	
#REQUIRED	No	Yes	
ID (#IMPLIED #REQUIRED)	Yes	No	#IMPLIED, #REQUIRED ignored
IDREF (#IMPLIED, #REQUIRED)	Foreign key	Depends on whether #IMPLIED or #REQUIRED is specified	
NMTOKEN (#IMPLIED #REQUIRED)	Yes	No	#IMPLIED, #REQUIRED ignored

Application-specific information for XML components in DTDs

This section provides the following information on the application-specific information format for business object definitions based on DTDs:

- "Business-object-level application-specific information"
- "Array attribute application-specific information" on page 44
- "Attribute application-specific information" on page 44

Business-object-level application-specific information: The XML data handler uses the following types of business objects to represent different kinds of XML elements generated from a DTD:

- "Regular business object definitions based on DTDs"
- "Mixed business object definitions based on DTDs"
- "Wrapper business object definitions based on DTDs" on page 42

These types of business objects are distinguished by the application-specific information at the business object level.

Regular business object definitions based on DTDs: A *regular* business object represents an XML element. In this type of business object, the application-specific information at the business object level identifies the name of the XML element that the business object represents. For example, suppose the XML element is defined as:

```
<!ELEMENT Unit(...)>
```

The application-specific information at the business object level for the associated business object definition is:

```
[BusinessObjectDefinition]
Name = MyApp_Unit
AppSpecificInfo = elem_name=Unit
[Attribute]
...
```

Mixed business object definitions based on DTDs: A *mixed* business object represents a mixed XML element, one that contains mixed content of character data (#PCDATA) and other subelements. The DTD representation of a mixed-type XML element looks like the following:

```
<!ELEMENT (#PCDATA | CONTAINED_ELEMENT1 | CONTAINED_ELEMENTN)*>
```

For example, suppose the Cust XML element is defined in the DTD as follows:

```
<!ELEMENT Cust(#PCDATA | Address | Phone)*>
```

To represent a mixed-type XML element, use a mixed-type business object definition. For a mixed business object definition, its business-object-level application-specific information consists of the following components:

- The name of the mixed XML element
- The tag type=MIXED

For the business object definition, MyApp_Cust, which represents the Cust element, the application-specific information at the business object level is as follows:

```
[BusinessObjectDefinition]  
Name = MyApp_Cust  
AppSpecificInfo = Cust;type=MIXED;
```

Wrapper business object definitions based on DTDs: A wrapper business object represents a repeating choice list. This type of business object definition is needed when an XML element has children that can appear in any order and be of any cardinality. A wrapper business object preserves the order and cardinality of the child elements in the XML document.

For a choice-list XML element, the DTD definition looks like this:

```
(CONTAINEDELEMENT1 | ... | CONTAINEDELEMENTN)*
```

As an example, the choice-list XML element definition in a DTD might be:

```
<!ELEMENT CUST( U | I | B )* >
```

This element contains three subelements that are optional and that can appear in any order. Each subelement is a simple element. Figure 14 shows an XML document of this type.

```
<CUST>  
  <U>.....  
</U>  
  <B>.....  
</B>  
  <I>.....  
</I>  
  <B>.....  
</B>  
  <U>.....  
</U>  
  ...
```

Figure 14. XML document content for a repeating choice list

To represent a choice-list XML element defined in a DTD, the business object definition is hierarchical. It includes the following business object definitions:

- The parent business object definition
This parent business object definition contains a single attribute that represents a multiple-cardinality business object array. This attribute has as its type the business object definition for the associated wrapper business object. The parent business object definition contains the following application-specific information:
 - At the business-object-level, the parent business object definition contains the name of the choice-list element in its application-specific information

- At the attribute level, the multiple-cardinality attribute (in the parent business object definition) specifies the optional choice elements in the following format:

(choiceElement1|...|choiceElementN)

where *choiceElement1...choiceElementN* correspond to each of the choice elements defined. The pipe (|) character must separate each of the choice elements and the entire tag must be enclosed in parentheses.

- A wrapper business object definition

The wrapper business object definition contains one attribute for each of the choice elements defined in the choice-list element. It does *not* require any application-specific information at the business-object level.

Figure 15 shows an illustration of the hierarchy of the business object definitions for a choice-list XML element. At runtime, each child business object is an instance of a wrapper business object and has only one attribute populated with data. As an example, a business object for the XML content in Figure 14 on page 42 would have five children, each with the appropriate attribute populated.

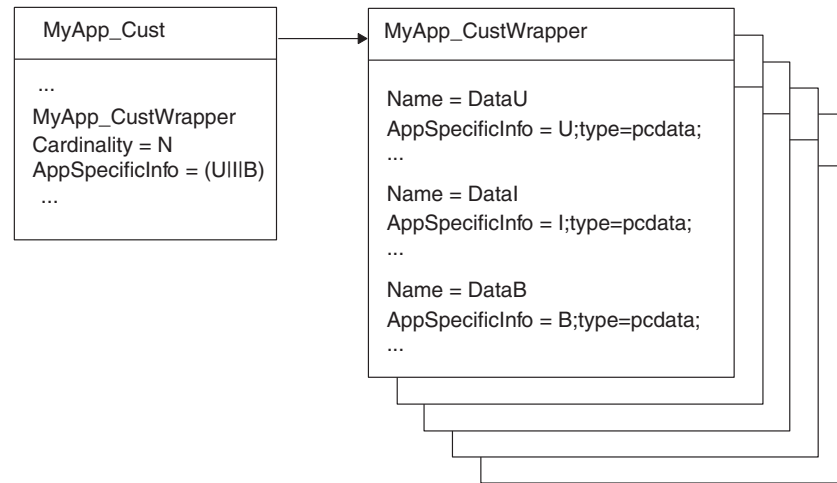

Figure 15. Hierarchical business object definition for choice-list XML element

Figure 16 shows the parent business object definition, *MyApp_Cust*, with its application-specific information.

```

[BusinessObjectDefinition]
Name = MyApp_Cust
AppSpecificInfo =

  [Attribute]
  Name = CustWrapper
  Type = MyApp_CustWrapper
  Cardinality = N
  AppSpecificInfo = attr_name=CustWrapper;(U|I|B)
[End]
  
```

Figure 16. Parent business object definition for a choice-list element

The wrapper business object definition, *MyApp_CustWrapper*, has three attributes, one for each choice element. Because each choice element contains character data, the application-specific information for each attribute specifies:

- The name of the element

- The tag type=pcdata

Note: For more information on attributes for character data, see “For an XML element with only PCDATA” on page 46.

Figure 17 shows the wrapper business object definition for this XML document.

```
[BusinessObjectDefinition]
Name = MyApp_CustWrapper
AppSpecificInfo =

    [Attribute]
    Name = DataU
    Type = String
    AppSpecificInfo = attr_name=U;type=pcdata;
    [End]

    [Attribute]
    Name = DataI
    Type = String
    AppSpecificInfo = attr_name=I;type=pcdata;
    [End]

    [Attribute]
    Name = DataB
    Type = String
    AppSpecificInfo = attr_name=B;type=pcdata;
    [End]
```

Figure 17. Wrapper business object definition for a choice-list element

Array attribute application-specific information: If a business object attribute represents an XML element that contains other elements, the application-specific information must contain the name of the element. For example, if an attribute named `DeliveryDate` has a business object type and represents an element named `DATETIME`, the application-specific information contains the name of the element:

```
Name = DeliveryDate
Relationship = Containment
Cardinality = n
AppSpecificInfo = DATETIME
```

Attribute application-specific information: The attribute of a business object definition can represent the following XML components:

- “For XML elements” on page 45
- “For an XML element with only PCDATA” on page 46
- “For an XML attribute” on page 46
- “For an XML element with character data and attributes” on page 47
- “For an XML element or attribute that contains special characters” on page 47
- “For an XML DOCTYPE declaration” on page 48
- “For a CDATA section” on page 48
- “For an XML comment” on page 49
- “For XML processing instructions” on page 49

Table 25 shows the tags for attribute-level application-specific information for these different XML components along with the sections in this manual that describe these tags in more detail.

Table 15. Tags for attribute application-specific information

Representation of business object attribute	Application-specific information	For more information
An XML element	<code>elem_name=name of XML element</code>	"For XML elements"
An XML element with only PCDATA	<code>elem_name=name of XML element;type=pcdata</code>	"For an XML element with only PCDATA" on page 46
An attribute for an XML element	<code>attr_name=name of XML attribute</code>	"For an XML attribute" on page 46
An XML element that contains character data and attributes	<code>type=attribute</code> <code>type=pcdata;notag</code>	"For an XML element with character data and attributes" on page 47
An XML element or attribute whose content includes special characters	<code>escape=true</code>	"For an XML element or attribute that contains special characters" on page 72
For a DOCTYPE declaration	<code>type=doctype</code>	"For an XML DOCTYPE declaration" on page 48
For a CDATA section	<code>type=cdata</code>	"For a CDATA section" on page 48
A comment to be added to the XML document	<code>type=comment</code>	"For an XML comment" on page 72
A processing instruction	<code>type=pi</code>	"For XML processing instructions" on page 72

Note: Attribute application-specific information can also include a tag of the form (a | b | c) to specify a multiple-cardinality attribute that represents a repeating choice. For more information, see "Wrapper business object definitions based on DTDs" on page 42.

For XML elements: Every simple (String) business object attribute that represents an XML element must include the `elem_name` tag in its application-specific information to identify the associated element:

```
elem_name=name of XML element
```

For example, if a business object attribute `CustLName` represents a simple XML attribute, its application-specific information is:

```
Name = CustLName
AppSpecificInfo = elem_name=CustLName;
```

XML element names can contain special characters (such as periods and hyphens). However, the names of business object attributes cannot contain these special characters. Therefore, the name of the XML element must be specified in the `elem_name` tag. To name the business object attribute, the XML ODA removes any special characters in the XML element's name, replacing them with an underscore (`_`) character.

In the following example, the application-specific information for the XML element specifies a different from the actual XML element's name because the attribute contains a special character:

```
Name = Phone_Tag
AppSpecificInfo = elem_name=Phone#Tag;
```

The actual name of the XML element contains a pound sign (`#`), which is invalid in the names of business-object attributes. Therefore, the `elem_name` tag in the

application-specific information specifies the actual XML element name. In the name of the associated business-object attribute, the pound sign is replaced with an underscore.

For an XML element with only PCDATA: XML elements that contain only character data are mixed elements, which contain only the PCDATA element content specifier. A business object attribute that represents an XML element with only PCDATA must have the following type tag in the application-specific information:

```
type=pcdata
```

In this case, the element name is the first field in the application-specific information, and the type parameter is the second field.

For example, an element named PartNumber that contains only PCDATA would have the following definition in the DTD:

```
<!ELEMENT PartNumber (#PCDATA)>
```

The corresponding attribute in the business object definition would have the following application-specific information:

```
Name = PartNumber  
AppSpecificInfo = elem_name=PartNumber;type=pcdata;
```

If the application-specific information also contains the text notag, the XML data handler does not generate XML markup. It adds only the value of the attribute itself to the XML document. For more information, see “For an XML element with character data and attributes” on page 47.

For an XML attribute: If a business object attribute represents an attribute of an XML element, its application-specific information must include the following tags:

- The attr_name tag:

```
attr_name=attrName
```

XML attribute names can contain special characters (such as periods and hyphens). However, the names of business object attributes cannot contain these special characters. Therefore, the name of the XML attribute must be specified in the attr_name tag. To name the business object attribute, the XML ODA removes any special characters in the XML attribute’s name.

- The type tag:

```
type=attribute
```

This type tag identifies the purpose of the associated business object attribute as an XML attribute.

Note: As described in “Business object structure” on page 31, all business object attributes that represent XML attributes must occur within the business object definition *before* any business object attributes that represent XML elements.

For example, if a business object attribute named ID represents an XML attribute named ID, its application-specific information is:

```
Name = ID  
AppSpecificInfo = attr_name=ID;type=attribute;
```

For another example that uses the type=attribute tag, see “For an XML element with character data and attributes” on page 47.

For an XML element with character data and attributes: If an XML element contains *only* PCDATA or CDATA and has one or more XML attributes, its business object definition must include the following attributes:

- A business-object attribute for each XML attribute.
The attribute name must match the name of the XML attribute. Its attribute-level application-specific information must include the `attr_name` and `type=attribute` tags. For more information, see “For an XML attribute” on page 46.
- A business-object attribute for the character data associated with the PCDATA or CDATA element-content specifier.
This attribute contains the data that is associated with the parent XML element. Its application-specific information must contain:
 - The appropriate `type=typename` tag, (where *typename* is either `pcdata` or `cdata`) followed by a semicolon (;)
 - The `notag` keyword, which prevents the XML data handler from generating duplicate start tags (one for the business object and one for the attribute). The XML data handler creates an XML start and end tag for every business object attribute *unless* `notag` appears in the application-specific information for that attribute.

For example, suppose an XML element named `Price` has an attribute named `Currency` and requires data for `Price`:

```
<!ELEMENT Price (#PCDATA)>
<!ATTLIST Price Currency NMTOKEN #IMPLIED>
```

Because the `Price` element has an XML attribute, in its business object definition a business-object attribute must be created for `Currency`. In addition, another attribute must exist to hold the `Price` data. The attribute for the `Price` data must specify `notag` in its application-specific information to prevent the data handler from creating a start and end tag for this attribute.

The `Price` child business object might look like this:

```
[BusinessObjectDefinition]
Name = Price
AppSpecificInfo = Price
  [Attribute]
  Name = Currency
  Type = String
  AppSpecificInfo = attr_name=Currency;type=attribute;
  ...
  [End]
  [Attribute]
  Name = Price
  Type = String
  AppSpecificInfo = Price;type=pcdata;notag
  ...
  [End]
```

In this case, the data handler does *not* generate a new XML element for the `Price` data but simply adds the data to the parent element.

For an XML element or attribute that contains special characters: Business object attributes representing XML elements or XML attributes with content that require escape processing must include the following tag in their application-specific information:

```
escape=true
```

An attribute requires escape processing if the attribute represents an XML element whose value contains any of the following special characters:

- single quotes (')
- double quotes (")
- ampersand (&)
- less-than sign (<)
- greater-than sign (>)

An attribute will *not* be escape-processed unless it contains the `escape=true` tag in its application-specific information. This tag must be placed at the end of any existing application-specific information. For example:

```
[Attribute]
Name=Data
Type=String
AppSpecificInfo=Price;type=pcdata;escape=true
[End]
```

If the attribute's application-specific information does *not* include the escape tag, the XML data handler checks the value of the `DefaultEscapeBehavior` property to determine whether to perform escape processing:

- If `DefaultEscapeBehavior` is true, the XML data handler performs escape processing on *all* attribute values.
- If `DefaultEscapeBehavior` is false, the XML data handler will *only* perform escape processing on attributes whose application-specific information contains the escape tag.

For an XML DOCTYPE declaration: If a business object attribute represents a document type declaration in the prolog, the application-specific information must include the following type tag:

```
type=doctype
```

For example, if a business object attribute named `DocType` represents a DOCTYPE element, its application-specific information is:

```
Name = DocType
AppSpecificInfo = type=doctype;
```

If the `DocType` attribute has the value:

```
DOCTYPE CUSTOMER "customer.dtd"
```

then the data handler generates the following XML:

```
<!DOCTYPE CUSTOMER "customer.dtd">
```

This application-specific information may also be used to include general entity declarations in the XML document. However, there is no explicit support for the inclusion of an internal DTD or parameter entity declarations. These can be included in the document by putting the entire text into the value of an attribute that has `type=doctype` in the application-specific information.

For a CDATA section: If a business object attribute represents a CDATA section within an XML document, the application-specific information must include the following type tag:

```
type=cdata
```

For example, if a business object attribute `UserArea` represents a CDATA section, its application-specific information is:

```
Name = UserArea
AppSpecificInfo = type=cdata;
```

For an XML comment: When the XML data handler converts a business object to an XML document, you can specify that it add comments to the XML document. To enable the data handler to add comments, take the following steps:

- Create in the business object definition the business object attribute (or attributes) that represents the comments.

Note: The XML ODA does *not* automatically generate business object attributes for XML comments. You must manually add these attributes as described in “Manually creating business object definitions” on page 77.

- Include the following type tag in the attribute-level application-specific information:

```
type=comment
```

- In the actual business object, specify the comment text as the value for this attribute.

For example, if a business object attribute named `Comment` represents an XML comment that the data handler should add to an XML document, the `Comment` attribute would appear as follows:

```
Name = Comment
AppSpecificInfo = type=comment;
```

If this attribute has the value “Customer information update from application A”, the following XML is generated:

```
<!--Customer information update from application A-->
```

For XML processing instructions: If a business object attribute represents a processing instruction, the application-specific information must include the following type tag:

```
type=pi
```

For example, if a business object attribute named `XMLDeclaration` represents the XML declaration in the prolog, the application-specific information is:

```
Name = XMLDeclaration
AppSpecificInfo = type=pi;
```

If the attribute has the value:

```
xml version = "1.0"
```

then the XML data handler generates the following XML:

```
<?xml version="1.0"?>
```

Creating business object definitions from DTDs

A DTD describes the format of an XML document. Therefore, the DTD is very useful for obtaining information needed for the business object definition. To translate the structure information in the DTD to a business object definition, you can use the XML Object Discovery Agent (ODA). For information on XML ODA, see “Using an XML ODA to create business object definitions” on page 76.

Note: Previous versions of the XML data handler included two tools to create business object definitions from DTDs: Edifecs SpecBuilder and the deprecated XMLBorgen utility. The XML ODA replaces both these tools have been replaced in functionality.

Supported DTD structures

The XML ODA supports structures of a DTD including:

- Entities — User-defined entities of the following form are recognized and substituted wherever referenced:

```
<!ENTITY % name value>
```

Note: The XML ODA removes newline characters (`\n`), carriage returns (`\r`), or tab characters (`\t`) if the characters occur between the ENTITY tag and its content, or between an element or attribute tag and the content of the tag.

- External DTDs — The XML ODA supports references to external DTDs (where one DTD refers to one or more other DTDs). They can resolve external DTDs *only* if they are on the local file system; they cannot access a URL to find them. Both these tools always try to find references to the external DTDs on the local file system; they do *not* ignore them.
- ANY directive — The XML ODA creates a String attribute for an element with ANY as its content. For example, if the DTD has the following construct:

```
<!ELEMENT SCENE (ANY) >
```

The corresponding business object definition is:

```
[Attribute]
Name = SCENE
Type = String
Cardinality = 1
MaxLength = 255
IsKey = false
IsForeignKey = false
IsRequired = true
AppSpecificInfo = SCENE;type=pcdata;
[End]
```

- Prolog — The XML data handler populates prolog information such as the DOCTYPE and XML declaration, as long as the business object definition contains attributes that correspond to those elements. However, the data handler populates *only* the name of the DOCTYPE; it does *not* populate other possible meta information.

Unsupported DTD structures

The XML ODA is capable of processing most DTDs. However, it does *not* support the following DTD structures:

- Conditional sections — These sections have the following structure:

```
<![INCLUDE[ information to be included ]]>
<![IGNORE[ information to be ignored ]]>
```

- Namespaces — A tag of the form `xxx:yyy` is treated simply as a tag `xxx:yyy`, and not as a tag `yyy` belonging to a namespace `xxx`.

XML documents that use schema documents

An *XML Schema* is a data model for XML documents that uses a *schema document* (.xsd extension) to define the template (schema) of an XML document. Unlike a DTD, a schema document uses the same syntax as an XML document to describe the schema. The business object definitions that represent the schema of an XML document use information in the schema document to preserve and record the

document's structure. This section provides the following information about deriving structure information for a business object definition from a schema document:

- "Requirements for business object definitions based on schema documents"
- "Creating business object definitions from schema documents" on page 74

Requirements for business object definitions based on schema documents

To ensure that business object definitions that represent schema documents conform to the requirements of the XML data handler, use the guidelines in this section, which involve:

- "Business object structure for schema documents"
- "Business object attribute properties for schema documents" on page 59
- "Application-specific information for XML components in schema documents" on page 60

Business object structure for schema documents

A business object that is processed by the XML data handler using business object definitions based on schema documents must follow these rules:

- The schema document must have the following required business object definitions:
 - A top-level business object definition represents the schema element.
 - A root-element business object definition represents the schema document's root element. A regular, mixed, or wrapper business object definition represents the root element in the schema document.
- For more information, see "Required business object definitions for schema documents" on page 52.
- A regular, mixed, or wrapper business object definition can represent contained XML components as well.

An example schema document for an XML document is shown in Figure 18. The schema document is named `Order`, and it contains elements that correspond to an application `Order` entity. This sample schema document describes the same business object structure as the one that the sample DTD document described. Figure 13 on page 40 shows the structure of a business object definition that might be created to correspond to an XML document associated with the `Order` schema document.

```

<?xml version="1.0" encoding="UTF-8"?>
<xs:schema xmlns:xs="http://www.w3.org/2001/XMLSchema"
  elementFormDefault="qualified">
  <xs:complexType name="AccessoryType">
    <xs:sequence>
      <xs:element ref="Quantity"/>
      <xs:element ref="Type"/>
    </xs:sequence>
    <xs:attribute name="Name" type="xs:string" use="required"/>
  </xs:complexType>
  <xs:element name="Order">
    <xs:complexType>
      <xs:sequence>
        <xs:element name="Unit" type="UnitType"
          maxOccurs="unbounded"/>
      </xs:sequence>
    </xs:complexType>
  </xs:element>
  <xs:element name="PartNumber" type="xs:string"/>
  <xs:element name="Price" type="xs:string"/>
  <xs:element name="Quantity" type="xs:string"/>
  <xs:element name="Type" type="xs:string"/>
  <xs:complexType name="UnitType">
    <xs:sequence>
      <xs:element ref="PartNumber" minOccurs="0"/>
      <xs:element ref="Quantity"/>
      <xs:element ref="Price"/>
      <xs:element name="Accessory" type="AccessoryType" minOccurs="0"
        maxOccurs="unbounded"/>
    </xs:sequence>
  </xs:complexType>
</xs:schema>

```

Figure 18. Sample XML schema document

Required business object definitions for schema documents: To represent a schema document requires at least the two business object definitions described in “Business object structure” on page 31. For a schema document, these business object definitions have the following additional requirements:

- The *top-level* business object represents the schema element and must contain the following:
 - An attribute named XMLDeclaration to represent the XML version
This attribute must has the type=pi tag in its application-specific information. For more information, see “For XML processing instructions” on page 72.
 - An attribute to represent the root element in the schema document
As described in “Business object structure” on page 31, this attribute must have as its type a single-cardinality business object, whose type is the business object definition for the root element. The application-specific information must list the name of this element with the elem_name tag. For more information, see “For XML elements” on page 68.
- A *root-element* business object definition represents the schema document’s root element. Because a schema document can have several XML components defined at the global level, you can tell the XML ODA which element to consider the root element through its Root configuration property. The root-element business object definition can contain the following attributes:
 - A schemaLocation attribute (optional) to represent where the schema document (or documents) resides

Whether the XML ODA generates a `schemaLocation` attribute in the top-level business object definition depends on the setting of its `DocTypeOrSchemaLocation` configuration property. For more information, see “For XML schema locations” on page 72.

- An attribute for each of the XML components in the root element

Note: For a list of general business object requirements, see “Requirements for business object definitions” on page 30.

Both these required business object definitions require business-object-level application-specific information that defines the target namespace and any component-name qualifications. For more information, see “Business-object-level application-specific information” on page 60.

The XML schema element in Figure 18 on page 52 is as follows:

```
<?xml version="1.0" encoding="UTF-8"?>
<xs:schema xmlns:xs="http://www.w3.org/2001/XMLSchema"
  elementFormDefault="qualified">
```

Figure 19 shows the top-level business object definition, `TopLevel`, which represents this schema element.

```
[BusinessObjectDefinition]
Name=TopLevel
AppSpecificInfo=elem_fd=qualified;attr_fd=unqualified
...
  [Attribute]
  Name=XMLDeclaration
  Type=String
  AppSpecificInfo=type=pi;
  ...
  [End]
  [Attribute]
  Name=Order
  Type=TopLevel_Order
  AppSpecificInfo=elem_name=Order;
  ...
  [End]
...
[End]
```

Figure 19. Sample top-level business object definition

If the XML ODA generated the top-level business object definition in Figure 19, the following ODA configuration properties would have been set:

ODA configuration property	Value of property
<code>BOPrefix</code>	Not set
<code>TopLevel</code>	"TopLevel"
<code>Root</code>	"Order"
<code>DocTypeorSchemaLocation</code>	true

For an example of a root-element business object definition, see Figure 26 on page 65.

Regular business object definitions based on schema documents: A *regular* business object definition represents any of the following XML constructs:

- An XML element that contains a complex type (either named or anonymous) that contains a sequence group of child elements.

Each child element in the sequence group is represented as an attribute in the business object definition. For more information, see “For XML elements within a complex type” on page 69.

Note: If the complex type contains a choice or an all group, it must be represented by a wrapper business object definition. For more information, see “Wrapper business object definitions based on schema documents” on page 56.

- An XML element that contains attributes

In these types of business object definition, the business-object-level application-specific information does *not* require any special information. The attributes of a regular business object definition represent the elements defined within the XML complex type.

Note: For complex types that contain a sequence group of child elements, each child element in the sequence group is represented as an attribute in the business object definition.

For example, suppose an XML element named Unit is defined as:

```
<xsd:element name="Unit">
  <xsd:complexType>
    ...
  </xsd:complexType>
</element>
```

The following business object definition represents the Unit element:

```
[BusinessObjectDefinition]
Name = MyApp_Unit
AppSpecificInfo =
  [Attribute]
  ...
```

Mixed business object definitions based on schema documents: A *mixed* business object definition represents a mixed XML element, one that contains mixed content of character data and other subelements. A schema document describes a mixed-type XML element as a complex type with the mixed attribute set to true, as follows:

```
<xsd:complexType mixed="true">
  <xsd:sequence>
    <xsd:element name="subElement1" type="subElementType"/>
    ...
  </xsd:sequence>
</xsd:complexType>
```

Note: Mixed business objects, as described in this section, are used for a repeating list of elements *and* character data. If your choice list does *not* contain any character data, use a wrapper business object as described in “Qualified component names” on page 65.

Because this complex type sets the mixed attribute to true, it can contain character data in addition to the one or more subelements it defines. If the mixed attribute is set to false, no character data is permitted in the complex type.

For example, Figure 20 shows a mixed-type XML element defined in a schema document.

```
<xsd:complexType name="Cust" mixed="true">
  <xsd:sequence>
    <xsd:element name="Name"/>
    <xsd:element name="Address"/>
    <xsd:element name="Phone"/>
  </xsd:sequence>
</xsd:complexType>
```

Figure 20. Sample schema document for a mixed-type XML element

To represent a mixed-type XML element requires the following two business object definitions:

- The parent business object definition

This parent business object definition contains a single attribute that represents a multiple-cardinality business object array. This attribute has as its type the business object definition for the associated wrapper business object. The parent business object definition includes the following application-specific information:

- The business-object-level application-specific information consists of the following components:

- The name of the associated mixed-type XML element followed by a semicolon (;)
- The tag `type=MIXED`

- The multiple-cardinality attribute has the following tag in its application-specific information:

(mixedTypeElement|subElement1|...|subElementN)

where:

- *mixedTypeElement* is the name of the associated mixed-type XML element
- *subelement1...subElementN* correspond to each of the subelements defined in the complex type

The pipe (|) character must separate each of the subelements and the entire tag must be enclosed in parentheses.

- A wrapper business object definition

The wrapper business object definition contains attributes for the mixed data:

- One attribute for the character data, which requires the `type=pcdata` tag (to indicate character data) as well as the `notag` tag (to indicate that the data is associated with the current element, not a separate element).
- One attribute for each of the subelements defined in the mixed-type element. Each attribute requires the `type=pcdata` tag (to indicate that it represents a simple type).

For more information on the `type=pcdata` tag, see “For XML elements within a complex type” on page 69.

Note: This wrapper business object definition does *not* require any application-specific information at the business-object level.

If the business object definition, `MyApp_Cust`, represents the `Cust` mixed-type element in Figure 20, its application-specific information is as follows:

```

[BusinessObjectDefinition]
Name = MyApp_Cust
AppSpecificInfo = type=MIXED;

    [Attribute]
    Name=Cust_wrapper1
    Type=MyApp_CustWrapper1
    Cardinality=n
    AppSpecificInfo=(Cust|Address|Phone)
    ...
[End]

```

Wrapper business object definitions based on schema documents: A *wrapper* business object definition represents a repeating choice list. This type of business object definition is needed when an XML element has children that can appear in any order and be of any cardinality. A wrapper business object preserves the order and cardinality of the child elements in a particular XML document.

Note: Wrapper business objects, as described in this section, are used for a repeating choice list that contains elements, *not* for character data. If your choice list contains any character data, use a mixed business object. For more information, see “Mixed business object definitions based on schema documents” on page 54.

A schema document can describe a choice-list XML element as a complex type that contains either of the following model groups:

- A choice group, which defines an unordered list of elements in which only one element must appear:

```

<xsd:complexType>
  <xsd:choice>
    ...
  </choice>
</complexType>

```

To represent an XML element with a complex type that contains a choice group, the XML data handler expects the same hierarchical business object definition that it does for a choice-list XML element defined in a DTD:

- A parent business object definition that contains a single attribute with *multiple cardinality* whose type is the wrapper business object
- A wrapper business object definition that contains an attribute for each subelement in the choice group.

These business object definitions contain business-object-level application-specific information in the same format as the choice-list XML element for a DTD. For more information, see “Wrapper business object definitions based on DTDs” on page 42.

- An all group, which defines an unordered list of elements in which elements can appear no more than once each:

```

<xsd:complexType>
  <xsd:all>
    ...
  </xsd:all>
</xsd:complexType>

```

To represent an XML element with a complex type that contains an all group, the XML data handler expects a hierarchical business object definition with the following business object definitions:

- A parent business object definition that contains a single attribute with *multiple cardinality* whose type is the wrapper business object

- A wrapper business object definition that contains an attribute for each subelement in the all group

These business object definitions contain business-object-level application-specific information in the same format as the choice-list XML element for a DTD. For more information, see “Wrapper business object definitions based on DTDs” on page 42.

To indicate cardinality, these model groups support occurrence constraints with the `minOccurs` and `maxOccurs` attributes. For more information, see Table 18 on page 59.

As an example, the XML element definition in a schema document might be:

```
<xsd:element name="CUST">
  <xsd:complexType>
    <xsd:choice minOccurs="0" maxOccurs="unbounded">
      <xsd:element ref="U"/>
      <xsd:element ref="I"/>
      <xsd:element ref="B"/>
    </xsd:choice>
  </xsd:complexType>
</xsd:element>
```

This element contains three subelements that are optional (although one subelement out of the list *must* occur) and that can appear in any order. Figure 14 on page 42 shows an XML document of this type. Figure 16 on page 43 shows the parent business object definition for this XML document. Figure 17 on page 44 shows the wrapper business object definition.

Type substitution in business object definitions based on schema documents:

Type substitution enables derived types to appear in place of their base types in individual XML document instances. When type substitution occurs, an element conforming to a declaration with one data type can have any data type that either extends or restricts it. In the following schema definition, `ShirtType` and `HatType` are derived types of the basic `ProductType`:

```

<xsd:schema xmlns:xsd="http://www.w3.org/2001/XMLSchema">
<xsd:element name="items" type="ItemsType"/>
<xsd:complexType name="ItemsType">
  <xsd:sequence>
    <xsd:element ref="product" maxOccurs="unbounded"/>
  </xsd:sequence>
</xsd:complexType>
<xsd:element name="product" type="ProductType"/>
<xsd:complexType name="ProductType">
  <xsd:sequence>
    <xsd:element name="number" type="xsd:string"/>
    <xsd:element name="name" type="xsd:string"/>
  </xsd:sequence>
</xsd:complexType>
<xsd:complexType name="ShirtType">
  <xsd:complexContent>
    <xsd:extension base="ProductType">
      <xsd:sequence>
        <xsd:element name="size" type="xsd:string"/>
        <xsd:element name="color" type="xsd:string"/>
      </xsd:sequence>
    </xsd:extension>
  </xsd:complexContent>
</xsd:complexType>
<xsd:complexType name="HatType">
  <xsd:complexContent>
    <xsd:extension base="ProductType">
      <xsd:sequence>
        <xsd:element name="size" type="xsd:string"/>
      </xsd:sequence>
    </xsd:extension>
  </xsd:complexContent>
</xsd:complexType>
</xsd:schema>

```

Figure 21. Sample schema with type substitution

Based on the schema above, the following XML document is valid:

```

<items xmlns:xsi="http://www.w3.org/2001/XMLSchema-instance">
<product>
  <number>999</number>
  <name>Special Seasonal</name>
</product>
<product xsi:type="ShirtType">
  <number>557</number>
  <name>Short-Sleeved Linen Blouse</name>
  <size>M</size>
  <color>blue</color>
</product>
<product xsi:type="HatType">
  <number>443</number>
  <name>Four-Gallon Hat</name>
  <size>L</size>
</product>
</items>

```

Figure 22. Derived types in an XML document

Wherever ProductType occurs, its derived types, ShirtType and HatType, indicated by the xsi:type attribute, can appear instead. To represent XML documents in which type substitution occurs, the XML data handler creates a wrapper business object as a child attribute of the XML document. This wrapper business object has

child attributes corresponding to the complex type (ProductType in Figure 21 on page 58) and its derived types (ShirtType and HatType). Table 16 and Table 17 show the business object definitions that would be generated from the XML schema above.

Table 16. Business object definitions for ItemsType

Attribute Name	Type	Cardinality	ASI
Product	ProductTypeWrapper	N	(product);typeSub=true

Table 17. Business object definitions for ProductTypeWrapper

Attribute	Type	Cardinality	ASI
ProductType	ProductType	1	Elem_name=product; xsiType=ProductType
ShirtType	ShirtType	1	Elem_name=product; xsiType=ShirtType;
HatType	HatType	1	Elem_name=product; xsiType=HatType;

Business object attribute properties for schema documents

When the business object definitions for an XML document are based on schema documents, the business object attribute properties have the restrictions discussed in “Business object attribute properties” on page 32. In addition, the schema-document syntax can determine the “required-ness” of a business object attribute. The “required-ness” is a combination of factors, including cardinality and whether the attribute is a key, that determines whether the XML data handler requires the attribute. If an attribute is required, its Required attribute property must be set to true.

The setting of the Required attribute property depends on the XML element and attribute specifications, as well as the settings of the Cardinality, Key, and Foreign Key attribute properties, as follows:

- The cardinality of a business object attribute is determined by the Occurrence indicator in the schema document. This cardinality affects whether the attribute is required. Table 18 outlines the cardinality and “required-ness” for possible combinations of element declarations in a schema document.

Table 18. Cardinality and “Required-ness” for a schema document

Schema fragment occurrence indicator	Cardinality	Required
None specified	1	Yes
maxOccurs > 1	N	Yes
maxOccurs = “unbounded”	N	Yes
minOccurs=0	No effect	No
minOccurs>1	N	Yes

- Whether a business object attribute is required is also determined by the use attribute in the schema document. Table 19 outlines the “required-ness” for possible values of the use attribute.

Table 19. "Required-ness" for a schema document

Schema fragment attribute: use	Cardinality	Required
None specified	No effect	No
use=required	No effect	Yes

- Whether a business object attribute is a primary or foreign key is determined by the `id` attribute in the schema document. The presence of a key affects whether the attribute is required. Table 20 outlines how value of the `id` attribute affects the business object attribute's "required-ness".

Table 20. Keys and "Required-ness" for a schema document

Schema fragment attribute: id	Key	Required	Comment
<code>id=ID</code>	Yes	No	

Application-specific information for XML components in schema documents

This section provides the following information on the application-specific information format for business object definitions based on schema documents:

- "Business-object-level application-specific information"
- "Attribute application-specific information" on page 67

Business-object-level application-specific information: The XML data handler uses the following types of business object definitions to represent the different kinds of root XML elements defined in a schema document. These types of business object definitions are distinguished by the application-specific information at the business object level.

Table 21. Tags for business-object-level application-specific information

Tag in application-specific information	Description	For more information
<code>target_ns</code>	Specifies the target namespace of the schema document	"Schema namespaces"
<code>attr_fd</code>	Specifies whether attribute names are qualified or unqualified.	"Qualified component names" on page 65
<code>elem_fd</code>	Specifies whether the names of locally declared elements are qualified or unqualified.	"Qualified component names" on page 65

Note: Business-level application-specific information can also include the `type=MIXED` tag. For more information, see "Mixed business object definitions based on schema documents" on page 54.

Schema namespaces: Unlike DTDs, schema documents require definition of at least one namespace. A *namespace* provides a context for the names of elements, element types, and attributes within an XML document. A namespace is a Uniform Resource Identifier (URI), which includes HTTP, FTP, as well as other kinds of paths. Table 22 shows the namespaces that a schema document can declare to be able to resolve the references between schema components.

Table 22. XML namespaces

Namespace	Description	Name	Common prefix
XML Schema Namespace	Defines every component used in the XML Schema Definition Language (XSDL), such as element, schema, and simpleType.	http://www.w3.org/2001/XMLSchema	xsd, xs
XML Schema Instance Namespace	Defines four attributes associated with the schema instance: type, nil, schemaLocation, noNamespaceSchemaLocation	http://www.w3.org/2001/XMLSchema-instance	xsi
User-defined namespace	Defines every component declared or defined by a global declaration (such as element, attribute, type, or group). Note: Locally declared elements may or may not use the target namespace. For more information, see “Qualified component names” on page 65.	User-defined	User-defined

Note: The XML ODA supports schema documents with multiple target namespaces.

Every schema document can declare one *target namespace*, which identifies the namespace to which global components (elements, attributes, types, or groups) belong, with the `targetNamespace` tag. If the schema element includes the `targetNamespace` tag, each business object definition generated for that schema document must contain the `target_ns` tag in its application-specific information to specify the target namespace declared for the XML document:

`target_ns=URI address for target namespace`

The `target_ns` tag must exist in the business-object-level application-specific information for *all* business object definitions, as follows:

- For the top-level business object definition, the value of the `target_ns` tag specifies the value that the `targetNamespace` attribute of the XML schema element specifies.
- Each business object definition that represents an XML element must also include the `target_ns` tag in its application-specific information. Because every global component (such as element, attribute, or type) belongs to its schema document’s target namespace, the business object definitions that represent these components also specify the schema document’s target namespace.

Note: Previous versions of the XML data handler expected the top-level business object definition to have attributes for the namespace prefixes and to use the appropriate `type=defaultNS` and `type=xmlns` tags in the attribute-level application-specific information. This mechanism for defining namespace prefixes has been replaced, although the XML data handler continues to support it for backward compatibility with existing business object definitions. New business object definitions should use the `target_ns` tag as described in this section. The XML ODA has been modified to use the `target_ns` tag.

For example, the schema document in Figure 23 defines the XML Schema Namespace (with the `xsd` prefix) and a target namespace (which is the default namespace).

```
<?xml version="1.0" encoding="UTF-8"?>
<xsd:schema xmlns:xsd="http://www.w3.org/2001/XMLSchema"
  targetNamespace="http://www.ibm.com/ns1" xmlns="http://www.ibm.com/ns1">
  <xsd:complexType name="TaxInfoType">
    <xsd:sequence>
      <xsd:element name="SSN" type="string">
      </xsd:element>
      <xsd:element name="State" type="string">
      </xsd:element>
    </xsd:sequence>
  </xsd:complexType>
  <xsd:element name="Customer">
    <xsd:complexType>
      <xsd:sequence>
        <xsd:element name="TaxInfo" type="TaxInfoType">
        </xsd:element>
        <xsd:element name="BillTo" type="xsd:string">
        </xsd:element>
      </xsd:sequence>
      <xsd:attribute name="Name" type="xsd:string">
      </xsd:attribute>
      <xsd:attribute name="ID" type="xsd:string">
      </xsd:attribute>
    </xsd:complexType>
  </xsd:element>
</xsd:schema>
```

Figure 23. The Schema1.xsd sample schema document

The XML ODA generates three business object definitions for this schema document: `BOPrefix_TopLevel`, `BOPrefix_TopLevel_Customer`, and `BOPrefix_TopLevel_TaxInfoType` (where `BOPrefix` and `TopLevel` are the values of these ODA configuration properties). All three of these business object definitions have the following in their business-object-level application-specific information: `target_ns=http://www.ibm.com/ns1;elem_fd=unqualified;attr_fd=unqualified`

Note: Because of the schema element in Figure 23 includes neither the `elementFormDefault` nor the `attributeFormDefault` attribute, this application-specific information includes the `elem_fd` and `attr_fd` tags set to `unqualified`. For more information, see “Qualified component names” on page 65.

One schema document can only define one target namespace. However, it can include elements and attributes defined in another schema document’s target namespace by using the `import` element.

Figure 24 shows a schema document that is based on the `Schema1.xsd` document defined in Figure 23. This schema document imports the `ns2` namespace, which declares the `TaxInfoType` complex type, the `BillTo` element, and the `Name` attribute.

```

<?xml version "1.0" encoding="UTF-8"?>
<xsd:schema xmlns:xsd="http://www.w3.org/2001/XMLSchema"
  targetNamespace="http://www.example.com/ns1" xmlns="http://www.example.com/ns1"
  attributeFormDefault="qualified" elementFormDefault="qualified"
  xmlns:ns2="http://www.example.com/ns2">
  <xsd:import schemaLocation="Schema2.xsd"
    namespace="http://www.example.com/ns2"/>
  <xsd:element name="Customer2">
    <xsd:complexType>
      <xsd:sequence>
        <xsd:element name="TaxInfo" type="ns2:TaxInfoType">
        </xsd:element>
        <xsd:element ref="ns2:BillTo">
        </xsd:element>
      </xsd:sequence>
      <xsd:attribute ref="ns2:Name">
      </xsd:attribute>
      <xsd:attribute name="ID" type="xsd:string">
      </xsd:attribute>
    </xsd:complexType>
  </xsd:element>
</xsd:schema>

```

Figure 24. Importing a target namespace

The business object definition for the root element, `Customer2`, must specify this alternate namespace for its attributes that represent the `TaxInfo`, `BillTo`, and `Name` XML components, as follows:

- The `TaxInfo` attribute has as its type a business object definition that represents the `TaxInfoType`, which is defined in the `ns2` (`http://www.example.com/ns2`) namespace (see Figure 25 on page 64).
- The `BillTo` attribute has the `elem_ns` tag in its application-specific information to specify the `ns2` namespace as the source of the associated `BillTo` element.
- The `Name` attribute has the `attr_ns` tag in its application-specific information to specify the `ns2` namespace as the source of its associated XML attribute, `Name`.

Figure 25 shows the schema document that defines the `TaxInfoType`, `BillTo`, and `Name` XML components in the `ns2` namespace.

```

<?xml version "1.0" encoding="UTF-8"?>
<schema xmlns:xsd="http://www.w3.org/2001/XMLSchema"
  targetNamespace="http://www.example.com/ns2"
  attributeFormDefault="qualified" elementFormDefault="qualified"
  xmlns:ns2="http://www.example.com/ns2">
  <complexType name="TaxInfoType">
    <sequence>
      <element name="SSN" type="string">
      </element>
      <element name="State" type="string">
      </element>
    </sequence>
  </complexType>
  <attribute name="Name" type="string"
  </attribute>
  <complexType name="AddressType">
    <sequence>
      <element name="Zip" type="string">
      </element>
      <element name="Street" type="string">
      </element>
    </sequence>
  </complexType>
  <element name="BillTo" type="ns2:AddressType">
  </element>
</schema>

```

Figure 25. Defining the second namespace

Figure 25 shows the business object definition for the Customer2 root element.

```

[BusinessObjectDefinition]
Name=TopLevel_Customer2
AppSpecificInfo=target_ns=http://www.example.com/ns1;elem_fd=qualified;
  attr_fd=qualified
...
  [Attribute]
  Name=Name
  Type=String
  AppSpecificInfo=attr_name=Name;type=attribute;attr_ns=http://www.example.com/ns2
  ...
  [End]
  [Attribute]
  Name=ID
  Type=String
  AppSpecificInfo=attr_name=ID;type=attribute
  ...
  [End]
  [Attribute]
  Name=schemaLocation
  Type=String
  AppSpecificInfo=attr_name=schemaLocation;type=xsischemaLocation
  ...
  [End]
  [Attribute]
  Name=TaxInfo
  Type=TopLevel_TaxInfoType
  AppSpecificInfo=elem_name=TaxInfo
  ...
  [End]
  [Attribute]
  Name=BillTo
  Type=TopLevel_AddressType
  AppSpecificInfo=elem_name=BillTo;elem_ns=http://www.example.com/ns2
  ...
  [End]
...
[End]

```

Figure 26. Sample root-element business object definition

Qualified component names: Within the XML document, names of components associated with a namespace are either qualified or unqualified, as follows:

- Unqualified names do *not* contain a prefix and are *not* part of any namespace.
- Qualified names are one of the following:
 - The component name contains a prefix associated with a namespace. You can assign a prefix to one or more namespaces. You declare a namespace's prefix with the `xmlns:prefix` tag, where *prefix* is the declared prefix. In the component definition within the schema document, these component names are *qualified* because they have a prefix prepended to the component name (*prefix:componentName*).
 - The names do not contain a prefix but are part of the default namespace (elements only).

The *default namespace* specifies the namespace to associate with components that do *not* include a prefix in their component names. You declare the default namespace with the `xmlns` tag.

For the XML data handler to correctly handle XML-to-business-object conversion, the namespaces for the XML document and the schema document must match, as follows:

- If a schema document specifies a default namespace, the XML document must also specify default namespace.
- If a schema document does *not* have a default namespace, the XML document cannot have a default namespace.

The `elementFormDefault` attribute of the schema element specifies whether the names of locally declared elements are qualified. By default, locally declared elements are unqualified and belong to the default namespace. The value of the `elementFormDefault` attribute determines the value of the `elem_fd` tag in the business-object-level application-specific information, as Table 23 shows.

Table 23. Setting the `elem_fd` tag

Value of <code>elementFormDefault</code>	Value of <code>elem_fd</code> tag
"unqualified"(or attribute is not specified at all)	<code>elem_fd=unqualified</code>
"qualified"	<code>elem_fd=qualified</code>

For example, the schema document in Figure 23 on page 62 does *not* contain the `elementFormDefault` attribute in its schema element. Therefore, the business-object-level application-specific information in *all* the business object definitions for this schema document (`BOPrefix_TopLevel`, `BOPrefix_TopLevel_Customer`, and `BOPrefix_TopLevel_TaxInfoType`, where `BOPrefix` and `TopLevel` are the values of these ODA configuration properties) contains the tag:

```
elem_fd=unqualified
```

Note: The business-object-level application-specific information for these three business object definitions would contain this same tag if the schema document's schema element included the attribute:

```
elementFormDefault="unqualified"
```

If an individual XML element includes the `form` attribute, this value of the `form` attribute overrides any setting of the `elementFormDefault` attribute.

The `attributeFormDefault` attribute of the schema element specifies whether the names of elements are qualified. By default, attribute names are unqualified and do not belong to any namespace. The value of the `attributeFormDefault` attribute determines the value of the `attr_fd` tag in the business-object level application-specific information in the same way as the value of the `elementFormDefault` attribute determines the value of the `elem_fd` tag, as Table 24 shows.

Table 24. Setting the `attr_fd` tag

Value of <code>attributeFormDefault</code>	Value of <code>attr_fd</code> tag
"unqualified"(or attribute is not specified at all)	<code>attr_fd=unqualified</code>
"qualified"	<code>attr_fd=qualified</code>

For example, the schema document in Figure 23 on page 62 does *not* contain the `attributeFormDefault` attribute in its schema element. Therefore, the business-object-level application-specific information in *all* the business object definitions for this schema document (`BOPrefix_TopLevel`,

BOPrefix_TopLevel_Customer, and BOPrefix_TopLevel_TaxInfoType, where BOPrefix and TopLevel are the values of these ODA configuration properties) contains the tag:

```
attr_fd=unqualified
```

Note: The business-object-level application-specific information for these three business object definitions would contain this same tag if the schema document's schema element included the attribute:

```
attributeFormDefault="unqualified"
```

Attribute application-specific information: The attribute of a business object definition can represent the following XML components:

- “For XML elements” on page 68
- “For XML elements within a complex type” on page 69
- “For an XML attribute” on page 71
- “For XML processing instructions” on page 72
- “For an XML comment” on page 72
- “For an XML element or attribute that contains special characters” on page 72
- “For XML schema locations” on page 72

Table 25 shows the tags for attribute-level application-specific information for these different XML components along with the sections in this manual that describe these tags in more detail.

Table 25. Tags for attribute application-specific information

Representation of business object attribute	Application-specific information	For more information
An XML element	<pre>elem_name=name of XML element elem_ns=namespace for element's definition elem_fd=value of form attribute</pre>	“For XML elements” on page 68
An XML element within a complex type	<pre>type=pcdata</pre>	“For XML elements within a complex type” on page 69
An attribute for an XML element	<pre>attr_name=name of XML attribute type=attribute attr_ns=namespace for attribute's definition attr_fd=value of form attribute</pre>	“For an XML attribute” on page 71
An XML element or attribute whose content includes special characters	<pre>escape=true</pre>	“For an XML element or attribute that contains special characters” on page 72
A comment to be added to the XML document	<pre>type=comment</pre>	“For an XML comment” on page 72
A processing instruction	<pre>type=pi</pre>	“For XML processing instructions” on page 72
The schemaLocation or noNamespaceSchemaLocation attribute for an XML instance.	<pre>type=xsischemaLocation type=xsinonSlocation</pre>	“For XML schema locations” on page 72

Note: Attribute application-specific information can also include a tag of the form (a | b | c) to specify a multiple-cardinality attribute that represents a repeating choice. For more information, see “Wrapper business object definitions based on schema documents” on page 56.

For XML elements: If a business object attribute represents an XML element, its application-specific information must include the `elem_name` tag to identify the associated element:

`elem_name=name of XML element`

XML element names can contain special characters (such as periods and hyphens). However, the names of business object attributes cannot contain these special characters. Therefore, the name of the XML element must be specified in the `elem_name` tag. To name the business object attribute, the XML ODA removes any special characters in the XML element’s name.

A business object attribute can represent an XML element in the following cases:

- If the XML element is (or contains) an XML complex type
In this case, the business object attribute is a *complex* attribute whose data type is the business object definition that represents the XML complex type. Its `elem_name` tag (in the attribute’s application-specific information) contains the name of the XML element (or complex type).
- If the XML element is part of an XML complex type
In this case, the business object attribute is a *simple* attribute of type String. Its application-specific information includes the `elem_tag` (which contains the name of the XML element within the complex type) and the `type=pcdata` tag. For more information, see “For XML elements within a complex type” on page 69.

A business object attribute that represents an XML element can also include the following tags in its application-specific information:

- The `elem_fd` tag specifies the setting of the XML element’s `form` attribute, which indicates whether the names of locally declared element are qualified or unqualified. If an XML element has specified the attribute `form="qualified"`, the value of `elem_fd` is set to the value of the `form` attribute.

For example, suppose a locally declared XML element has the following definition:

```
<xsd:element ref="Name" form="qualified"></xsd:element>
```

Its associated business object attribute would have the following format:

```
[Attribute]  
Name=ns2:Name  
Type=String  
AppSpecificInfo=elem_name=Name;elem_fd=qualified;  
...
```

If an XML element does *not* specify the `form` attribute, the value of the `elementFormDefault` attribute (on the schema element) determines whether element names are qualified. For more information, see “Qualified component names” on page 65.

- The `elem_ns` tag specifies the target namespace for the XML element, if this namespace is *different* from the schema document’s target namespace. This tag is required when a schema document uses multiple namespaces. If the XML element referenced in one schema document is defined in the target namespace of *some other schema document*, this tag lists the name of that namespace.

For example, suppose an XML element within a complex type has the following definition:

```
<xsd:element ref="ns2:BillTo"></xsd:element>
```

Its associated business object attribute would have the following format:

```
[Attribute]
Name=BillTo
Type=String
AppSpecificInfo=elem_name=BillTo;elem_ns=http://www.imb.com/ns2;
...
```

For a complete example of a schema document that includes XML elements defined in a second namespace, see “Schema namespaces” on page 60.

For XML elements within a complex type: If a business object definition represents an XML complex type (complexType), the contents of this complex type are represented by simple (String) attributes within this business object definition. These business object attributes’ application-specific information *must* include the elem_name tag to identify the name of the element.

Note: For more information on this tag, see “For XML elements” on page 68.

Within an XML complex type, a business object attribute can represent the kinds of complex-type content shown in Table 26.

Table 26. Contents of an XML complex type

Type of complex-type element	Description	Attribute application-specific information
Simple XML element	An element that contains <i>only</i> character content. It cannot contain any other elements or XML attributes. It can occur only within a complex type	type=pcdata
Simple content	Only character data (no element)	type=pcdata;notag
XML element with attributes	An element that contains <i>both</i> character data <i>and</i> some combination of subelements and attributes	None. This type of XML element must be represented with a business object definition, not as a single business object attribute. For more information, see “Regular business object definitions based on schema documents” on page 54.

As an example of the use of the type=pcdata tag, the schema document in Figure 23 on page 62 contains a definition for the TaxInfoType complex type, which contains only simple XML elements. The business object definition for the TaxInfoType XML complex type (B0Prefix_TopLevel_TaxInfoType, where B0Prefix and TopLevel are the values of the respectively named ODA configuration properties) would contain two attributes. Each attribute would have the name of the associated XML element in its application-specific information, as Figure 27 shows. Because this complex type contains only simple XML elements (no subelements or attributes), the corresponding business object attributes must also contain the type=pcdata tag in their application-specific information.

```

[BusinessObjectDefinition]
Name=BOPrefix_TopLevel_TaxInfoType
AppSpecificInfo=target_ns=;elem_fd=unqualified;attr_fd=unqualified
...
[End]
[Attribute]
Name=SSN
Type=String
AppSpecificInfo=elem_name=SSN;type=pcdata
...
[End]
[Attribute]
Name=State
Type=String
AppSpecificInfo=elem_name=SSN;type=pcdata
...
[End]

```

Figure 27. Sample business object definition for XML complex type with simple elements

As an example of the `notag` keyword used in conjunction with the `type=pcdata` tag, suppose an XML element named `Price` is the `PriceType` complex type, which has only simple content; that is, it contains only character data. In this case, the `simpleContent` element defined an attribute named `Currency` and requires data for `Price`:

```

<xsd:element name="Price" type="PriceType">
  <xsd:complexType name="PriceType">
    <xsd:simpleContent>
      <xsd:extension base="xsd:decimal">
        <xsd:attribute name="Currency" type="xsd:NMTOKEN"/>
      </xsd:extension>
    </xsd:simpleContent>
  </xsd:complexType>
</element>

```

The business object definition for the `PriceType` complex type contains an attribute to hold the character data associated with simple content. The application-specific information for this attribute must contain the following:

```
type=pcdata;notag
```

The `notag` keyword prevents the XML data handler from generating duplicate start tags (one for the business object definition and one for the attribute). The XML data handler creates an XML start and end tag for every business object attribute *unless* `notag` appears in the application-specific information for that attribute.

The `Price` child business object definition might look like this:

```

[BusinessObjectDefinition]
Name = Price
AppSpecificInfo =

[Attribute]
Name = Currency
Type = String
AppSpecificInfo = attr_name=Currency;type=attribute;
...
[End]

[Attribute]
Name = Price

```



```
Type = String
AppSpecificInfo = elem_name=Price;type=pcdata;notag
...
[End]
```

A business object attribute must exist to hold the Price data. The attribute for the Price data must specify notag in its application-specific information to prevent the data handler from creating a start and end tag for this attribute. In this case, the data handler does *not* generate a new XML element for the Price data but simply adds the data to the parent element.

In addition, the business object definition must contain another attribute must exist to hold the value of the Currency attribute. If the simple content contains attributes, the business object definition must also contain an attribute for each XML attribute. The attribute's application-specific information must include the type=attribute tag. For more information, see "For an XML attribute."

For an XML attribute: When a business object definition represents an XML element or complex type, any attributes that the schema document declares for this element are represented as attributes within the business object definition. When a business object attribute represents an attribute of an XML element, its application-specific information *must* include the following tags:

- The attr_name tag:
attr_name=name of XML attribute
- The type tag:
type=attribute

Note: For more information on these tags, see "For an XML attribute" on page 46. For an example of the use of the type=attribute tag, see "For XML elements within a complex type" on page 69.

A business object attribute that represents an XML attribute can also include the following tags in its application-specific information:

- The attr_fd tag specifies the setting of the XML attribute's form attribute, which indicates whether the attribute names are qualified or unqualified. If an XML attribute has the attribute form="qualified" for form="unqualified" specified, the attr_fd has a value specified in the "form" attribute.

For example, suppose an XML attribute has the following definition:

```
<xsd:attribute ref="Name" form="qualified"></xsd:attribute>
```

Its associated business object attribute would have the following format:

```
[Attribute]
Name=ns2:Name
Type=String
AppSpecificInfo=attr_name=Name;type=attribute;attr_fd=qualified
...
```

If an XML attribute does not specify the form attribute, the value of the attributeFormDefault attribute (on the schema element) determines whether attribute names are qualified. For more information, see "Qualified component names" on page 65.

- The attr_ns tag specifies the target namespace for the XML attribute, if this namespace is *different* from the schema document's target namespace. This tag is required when a schema document uses multiple namespaces. If the XML attribute referenced in one schema document is defined in the target namespace of *some other schema document*, this tag lists the name of that namespace.

For example, suppose an XML attribute has the following definition:

```
<xsd:attribute ref="ns2:Name"></xsd:attribute>
```

Its associated business object attribute would have the following format:

```
[Attribute]  
Name=Name  
Type=String  
AppSpecificInfo=attr_name=Name;attr_ns=http://www.example.com/ns2;  
  type=attribute  
...
```

For a complete example of a schema document that includes XML attributes defined in a second namespace, see “Schema namespaces” on page 60.

For an XML element or attribute that contains special characters: Business object attributes representing XML elements or XML attributes that include special characters in their content require escape processing by the XML data handler. To notify the data handler of the need to perform escape processing, the business object attribute’s application-specific information must contain the following tag:
escape=true

The steps to specify escape processing for an XML document that uses a schema document to describe its schema are the same as to specify escape processing for an XML document that uses a DTD to describe its schema. For more information, see “For an XML element or attribute that contains special characters” on page 47.

For an XML comment: When the XML data handler converts a business object to an XML document, you can specify that it add the XML comments to the XML document by including the following tag in an attribute’s application-specific information:
type=comment

The XML ODA does *not* automatically generate business object attributes for XML comments. You must manually add these attributes. The steps to add comments to an XML document described by a schema document are the same as to define a comment for an XML document that is described by a DTD. For more information, see “For an XML comment” on page 49.

For XML processing instructions: If the XML document contains XML processing instructions, some business object definition associated with the schema document must contain an attribute to hold the processing value. The application-specific information of this attribute must contain the following type tag:
type=pi

For example, when the XML data handler converts an XML document to a business object, it puts the XML version in a special attribute of the top-level business object definition called XMLDeclaration. The top-level business object in Figure 19 on page 53 shows the XMLDeclaration attribute within the TopLevel_Customer business object definition. For more information about the type=pi tag, see “For XML processing instructions” on page 49.

For XML schema locations: XML documents that refer to schema locations for their schema documents must include the following information:

- Declaration of the XML Schema Instance Namespace and a mapping of the xsi prefix to this namespace
- Inclusion of one of the following XML-Schema-instance attributes:
 - xsi:schemaLocation

This attribute associates the name of a namespace with a schema location. If the schema document uses a target namespace, the name of this target namespace must match the namespace that the `xsi:schemaLocation` attribute (in the XML document) specifies.

– `xsi:noNamespaceSchemaLocation`

This attribute identifies a schema location. If the schema document does *not* use a target namespace, the XML document includes the `noNamespaceSchemaLocation` attribute to identify a single schema location.

For example, suppose the XML document has the namespace declaration in Figure 28.

```
<order xmlns="http://sampleDoc.org/ord"
      xmlns:xsi="http://www.w3.org/2001/XMLSchema-instance"
      xsi:schemaLocation="http://www.example.com/order order.xsd">
  ...
/<order>
```

Figure 28. Sample schema-location definition in an XML document

The schema document might have the following namespace declaration, which defines a target namespace:

```
<xsd:schema xmlns:xsd="http://www.w3.org/2001/XMLSchema"
           xmlns="http://www.example.com/order"
           targetNamespace="http://www.example.com/order">
```

For the business object that represents this XML document to be able to hold the information in the `schemaLocation` attribute, its business object definition must provide an attribute for this schema-location information. In the root-element business object definition, this schema-location information is represented as follows:

- For an XML document that uses the `schemaLocation` attribute, the top-level business object definition must contain an attribute with the following properties:
 - The attribute name is `schemaLocation` and this attribute is of type `String`.
 - The attribute must have the following type tag in its application-specific information:
`type=xsischemaLocation`
 - The value of this business object attribute is the value of the `schemaLocation` attribute.
- For an XML document that uses the `noNamespaceSchemaLocation` attribute, the root-element business object definition must contain an attribute with the following properties:
 - The attribute name is `noNamespaceSchemaLocation` and this attribute is of type `String`.
 - The attribute must have the following type tag in its application-specific information:
`type=xsinamespaceLocation`

The root-element business object definition for the schema document that represents this XML document includes the following attributes for the schema location:

```
[Attribute]
Name=schemaLocation
Type=String
AppSpecificInfo=type=xsischemaLocation;
```

Note: When an attribute represents the `schemaLocation` or `noNamespaceSchemaLocation` XML attribute, it does *not* require the `type=attribute` tag in its application-specific information.

The XML ODA determines whether to generate a `schemaLocation` or `noNamespaceSchemaLocation` attribute in the top-level business object based on the value of its `DoctypeorSchemaLocation` ODA configuration property.

Creating business object definitions from schema documents

A schema document describes and constrains the content of an XML document. Therefore, the schema document is very useful for obtaining information needed for the business object definition. To translate the structure information in the schema document to a business object definition, you can use the XML Object Discovery Agent (ODA). For information on XML ODA, see “Using an XML ODA to create business object definitions” on page 76.

Supported schema-document structures

The XML ODA maps element declaration in a schema to an attribute in the business object definition. The type of the business-object attribute depends on the type specified in the XML element declaration. A simple type maps to a `String` Java type. Complex types map to a business object definition.

The XML ODA supports structures of a schema document including:

- **Simple types** — Simple types can be either atomic (built-in or derived using restriction), list, or union types. The XML ODA maps all these types to a business-object attribute type of string. For more information, see “For XML elements within a complex type” on page 69.
- **Element wildcard** — The XML ODA maps the any wildcard to a simple attribute in the business object definition. At runtime, users must configure this attribute (by adding the appropriate application-specific information) based on the knowledge of the data.
- **anyAttribute element** — This element enables the user to extend the XML document with attributes that are not specified in the schema. The XML ODA prompts the user for a name for such an attribute and then maps the attribute to a simple attribute in a business object definition (see Figure 44 on page 182). The ODA ignores any namespace and `processContents` attributes for the `anyAttribute` wildcard.
- **sequence groups** — This model group requires child elements to appear in a specific order. The XML ODA maps the child elements in a sequence group to attributes within the business object definition. It determines the type of these attributes from the XML type attribute.
- **choice groups** — This model group indicates that only one of the corresponding conforming element declarations must appear in an instance. The XML ODA maps the child elements in a choice group to attributes within a wrapper business object definition. A parent business object definition contains a single attribute with multiple cardinality whose type is the wrapper business object definition. For more information, see “Wrapper business object definitions based on schema documents” on page 56.
- **all groups** — The XML ODA maps the child elements in an `all` group to attributes within a wrapper business object definition. A parent business object

definition contains a single attribute with multiple cardinality whose type is the wrapper business object definition. For more information, see “Wrapper business object definitions based on schema documents” on page 56.

- **include element** — The effect of the `include` is to bring into a schema document all the definitions and declarations contained in the included schema document. The XML ODA requires that you provide the full path to the schema document to be included. This full path is the actual location of the included schema document in the file system, *not* its URI. If you specify the location of the schema document with the XML ODA property `FileName`, all included schema documents must exist in this same location.

Note: When you include a schema document, make sure that the included schema document does *not* declare global elements that have the same names as the schema document that does the `include`.

- **restriction element** — This element allows you to derive complex types by restriction; that is, to restrict a complex type by removing or restricting its attributes or content. The XML ODA supports the restriction element in the following contexts:
 - For simple-content restrictions, the XML ODA does not perform any mapping for the restrictions that are defined for simple content and that involve facets of the derived type. It does process restrictions on any attributes defined in the derived type.
 - For complex-content restrictions, the XML ODA supports the elimination or restriction of attributes and the content model of the base complex type, as follows:
 - For a restricted content model, the ODA creates a business object definition for *both* the base complex type and the derived type. However, the XML ODA assumes that the schema syntax is valid and follows the W3C Schema specification guidelines for restrictions; it does *not* validate if the derived types are valid restrictions of the base type.
 - For attribute restrictions, the XML ODA assumes that all attributes of the base type are passed down to the derived type. Therefore, the business object definition has attributes for all XML attributes defined in the restriction as well as any other attributes defined in the base type (that are not included in the restriction).
- **import element** — This element allows an XML document to refer to components from other namespace. By specifying the `elem_ns` or `attr_ns` tags in the attribute application-specific information, the business object definition can identify an imported namespace. For more information, see “Schema namespaces” on page 60.
- **Complex-type derivation** — The XML ODA supports derived complex types using restriction and extension. For these constructs, it creates a business object definition for the derived complex type based on its derived content model.
- **Type substitution** — The XML ODA property `TypeSubstitution` provides support for type substitution based on the `xsi:type` attribute in the schema. When the user sets `TypeSubstitution` to `True` in a drop down in the ODA, the XML ODA generates an additional wrapper object with the ASI `"typeSub=true"` and business objects representing the base type and its derived types as children of this wrapper object. For more information, see “Type substitution in business object definitions based on schema documents” on page 57.

Unsupported schema-document structures

The XML ODA is capable of processing most schema documents. However, it does *not* support the following schema-document structures:

- Element substitution — The XML data handler does *not* support element substitution at runtime. You must specify element substitution in the schema with the `substitutionGroup` attribute on a global element declaration.
- Redefinition of types and groups — The `redefine` element allows you to redefine a type (simple or complex) or a group (element or attribute) so that only certain behavior is supported.
- Default and fixed attributes — The XML ODA ignores default and fixed attributes on element and attribute declarations. If an element or attribute declaration specifies one of these attributes and the instance does *not* contain the element or attribute, the XML ODA does not populate the corresponding business-object attribute.

Creating business object definitions

An XML document can have either a DTD or a schema document to define its structure. The business object definitions that represent the elements in an XML document must contain information about the document's structure. To create business objects to be processed by the XML data handler, the XML data handler must be able to locate business object definitions that contain the structural information for each XML document to be processed. You can generate business object definitions for XML documents in one of the following ways:

- “Using an XML ODA to create business object definitions”
- “Manually creating business object definitions” on page 77

Both these techniques involve use of the Business Object Designer Express tool. This section provides an overview on how to use Business Object Designer Express to generate business object definitions for XML documents. For a complete description of Business Object Designer Express, refer to the *Business Object Development Guide*.

Note: Some connectors that use the XML data handler require a top-level wrapper business object that contains the content business objects as children. Depending on the business object structure required by the connector you are using, therefore, you may need to add generated business objects as children to another business object. See the documentation for each connector for information on the structure of its business objects.

Using an XML ODA to create business object definitions

The XML Object Discovery Agent (ODA) creates business object definitions for an XML document based on either its DTD or schema document. The ODA examines the DTD or schema document to obtain information about the XML document structure. It then writes the business object definitions to a file that can be loaded into the business integration system.

Note: If an XML document does *not* have a DTD or schema document, you can manually create a business object definition for the document. For more information, see “Manually creating business object definitions” on page 77.

The XML ODA builds business object definitions that conform to the requirements of the XML data handler. The ODA adds the required `objectId` attribute to all business object definitions. It also adds the repository version number to the top of the business object file if you specify this, which is required to import a business object definition into the WebSphere Business Integration Express. These business

object definitions do *not* usually need additional editing. However, if you need to perform edits, see “Modifying information in the business object definition” on page 183.

For information on how to use XML ODA, see “Using the XML ODA,” on page 171. This appendix describes how to install and configure the XML ODA. It also describes how to use the XML ODA in Business Object Designer Express to generate business object definition. For information on launching Business Object Designer Express , see the *Business Object Development Guide*.

Manually creating business object definitions

This section describes how to manually create business object definitions to represent XML documents. You must ensure that you correctly define the business object definition, including its attributes, and the application-specific information.

Note: If an XML document does *not* have a DTD or schema document, you must manually create a business object definition for the document. If a DTD or schema document exists, IBM recommends use of the XML ODA to create a business object definition.

The description of XML-document format for a DTD or schema document describes business object definitions that the XML ODA builds. Table 9 on page 27 shows the sections of this manual that describe the format of XML documents that have a corresponding data model to describe their schema. As described in these sections, the business object definitions conform to the requirements of the XML data handler. Therefore, you can follow these descriptions when you need to create business object definitions manually.

In the following steps, *ElementTypeName* is the type of the XML element represented by the business object construct (either attribute or business object). To define a business object based on an XML document:

1. Create the top-level business object definition. The name of this business object definition should be the highest level element in the XML document (name of DTD or schema document, for example) in the format: *BOPrefix_TopLevelName*.

Note: Some connectors require a wrapper business object that contains the content business object as children. Refer to “Wrapper business object definitions based on DTDs” on page 42 for more information.

2. In the top-level business object definition, create attributes for the XML elements.

For a top-level business object definition based on either a DTD or a schema document, the following attributes are required:

- *XMLDeclaration* – The attribute’s application-specific information is *type=pi*.
- An attribute to represent the root element in the DTD or schema document – The attribute contains a single-cardinality child business object and its application-specific information specifies the name of the element with the *elem_name* tag.

For general information about these required attributes, see “Business object structure” on page 31. In addition, this document provides the following information about the structure of the top-level business object definition based on DTDs and schema documents:

Data model	For more information
Document type definition (DTD)	"Business object structure for DTDs" on page 39
Schema document	"Required business object definitions for schema documents" on page 52

3. Create the root-element business object definition, which is a child object of the top-level business object definition. It contains attributes for the root XML element. The name of this business object definition should be the root element in the XML document in the format: *BOPrefix_TopLevelName_RootElementName*
4. In the root-element business object definition, create a business object attribute for each contained element. Keep the following in mind:
 - The business object attribute name need not be the same as the XML element (or attribute) name. The application-specific information is used to specify the element (or attribute) name.
 - XML attributes must be the first attributes in the business object definition.
 - Type determination:
 - A String type is a cardinality-1 element with no element content or associated attribute-list declaration.
 - A business-object type is a cardinality-n contained element, or contained element with element content or associated attribute specification (or specifications).
 - Application-specific information is required for a String type attribute, mixed-typed element, or choice list element with cardinality n.

For general information about this application-specific information, see "Application-specific information" on page 34. In addition, this document provides the following information about the application-specific of the business-object attributes based on DTDs and schema documents:

Data model	For more information
Document type definition (DTD)	"Application-specific information for XML components in DTDs" on page 41
Schema document	"Application-specific information for XML components in schema documents" on page 60

Note: For an XML document with a schema definition, the root-element business object definition can also require an attribute for the schema location. For more information, see "Required business object definitions for schema documents" on page 52.

5. Create child business object definitions for all contained elements. Follow the rules listed above.

Converting business objects to XML documents

To convert a business object to an XML document, the XML data handler loops through the attributes in the business object definition in sequential order. It generates XML recursively based on the order in which attributes appear in the business object and its children.

The XML data handler processes business objects into an XML document as follows:

1. The data handler creates a document to contain the XML data.
2. The data handler examines the application-specific information in the top-level business object definition to determine if there are any child meta-objects (those whose names are listed in the *cw_mo_label* tag of the business-object-level application-specific information). The data handler does *not* include these attributes in the XML document.
3. The data handler loops through the remaining attributes of the business object definition.

The data handler generates XML for each attribute using the following rules:

- It creates a start and end tag for every simple `String` type attribute unless the `notag` string appears in the application-specific information for that attribute. If the start tag is open and the business object attribute being processed does *not* represent an XML attribute, the XML data handler closes the start tag (that is, it adds the character ">" to the XML document).
- If the attribute represents a business object, the XML data handler opens a start tag, makes a recursive call to retrieve the attributes in the child business object, generates XML for the attributes of the child business object, and then generates an end tag for the element. The XML data handler uses the *attribute-level* application-specific information `elem_name` as the name of the element. For multiple-cardinality attributes, this process is repeated for each instance of the business object in the array.
- If the attribute contains the application-specific information `xsiType`, the XML data handler writes out an attribute for the current element of the form `xsi:type=ValueofXsiType`. For example, if the business object attribute specifies `xsiType=ShirtType` then the corresponding XML attribute is `xsi:type="ShirtType"`. For more information about type substitution, see "Type substitution in business object definitions based on schema documents" on page 57.
- For attributes that represent XML markup, the data handler uses the attribute application-specific information and generates XML as shown in Table 27..

Table 27. XML output for attributes that represent XML markup

XML entity business object attribute represents	XML output	Example	Application-specific information
Processing instruction	<code><?AttrValue?></code>	<code><?xml version="1.0"?></code>	<code>type=pi</code>
DTD	<code><!AttrValue></code>	<code><!DOCTYPE CUSTOMER "customer.dtd"></code>	<code>type=doctype</code>
Element	<code><ElementName>...</ElementName></code>	For XML document based on a DTD: <code><CUSTOMER>... </CUSTOMER></code>	<code>type=pcdata</code>
XML attribute	<code>AttrName="AttrValue"</code>	For XML document based on a schema document: <code><element name=CUSTOMER...> </element></code> For XML document based on a DTD: <code>Seqno="1"</code>	<code>type=attribute</code>
CDATA section	<code><![CDATA[AttrValue]]></code>	For XML document based on a schema document: <code><element name=CUSTOMER... Seqno="1"...> </element></code> <code><![CDATA [<HTML>Text</HTML>]]></code>	<code>type=cdata</code>

Table 27. XML output for attributes that represent XML markup (continued)

XML entity business object attribute represents	XML output	Example	Application-specific information
Comment	<code><!--CommentText --></code>	<code><!--Customer information from source application A--></code>	type=comment
Schema location (with target namespace)	<code><elementName xmlns="URI_path" xmlns:xsi= "http://www.w3.org/ 2001/XMLSchema- instance" xsi:schemaLocation= "URI_for_schema schema_location" ...</code>	See Figure 28 on page 73	type= xsischemalocation
Schema location (no target namespace)	<code><elementName xmlns="URI_path" xmlns:xsi= "http://www.w3.org/ 2001/XMLSchema- instance" xsi:noNamespace SchemaLocation= "schema_location" ...</code>	<code><order xmlns="http://sampleDoc.org.ord" xmlns:xsi="http://www.w3.org/2001/ XMLSchema-instance" xsi:noNamespaceSchemaLocation= "order.xsd"> ... </order></code>	type=xsinNSlocation

- For attributes that contain the character data (PCDATA in a DTDs) associated with a given element, no markup is generated, and only the value of the attribute itself is added to the document (assuming the notag tag exists in the application-specific information).
- For attributes that contain character data for an element, or for an attribute, the data handler replaces any special characters with appropriate escape sequences (assuming the escape=true tag exists in the application-specific information), as Table 28 shows.

Table 28. Special characters and the XML representations

Special character	XML escape sequences
ampersand (&)	&
less than (<)	<
greater than (>)	>
single quote (')	&apos
double quote (")	"

Note: If an attribute represents an XML element whose value contains single quotes, double quotes or the &, <, or > characters, then the attribute requires escape processing. An attribute is *not* escape-processed unless it contains the value escape=true in its application-specific information. This application-specific information must be placed at the end of any other text.

- An attribute is skipped if either of the following conditions exist:
 - The attribute has the value of CxIgnore.
 - The attribute name is listed in the cw_mo_tag, in the application-specific information of the business object definition.

No XML is generated for these attributes.

- Simple String attributes with a value of CxBlank are included in the XML document as empty tags. For XML documents based on DTDs, double quotation marks (" ") are used as the PCDATA equivalent of CxBlank. However, the data handler assumes that no complex attribute (one whose type is a business object) has a value of CxBlank.
4. When the data handler completes the conversion, it returns the XML document to the caller.

Note: The verb information in a business object is lost in the conversion to an XML document. For information on preserving the verb, see “Business object verbs” on page 35.

Converting XML documents to business objects

This section provides the following information on how the XML data handler converts XML documents to business objects:

- “XML document requirements”
- “Serialized-data processing”

XML document requirements

The XML data handler makes the following assumptions about an XML document:

- The XML document is well formed.
- The XML document is compliant with SAX parser requirements. Note that the default parser used by the XML data handler requires that an XML document include an XML declaration.
- The structure of an XML document must match the structure of its corresponding business object. In addition, the order of the elements in the document must match the order of the attributes in the business object.

Serialized-data processing

When converting an XML document into a business object, the XML data handler assumes that the business object follows the structure of the XML document and conforms to the business object definition requirements described in “Requirements for business object definitions” on page 30. If there is no attribute in the business object for a given element name, the XML data handler returns an error.

To convert an XML document to a business object, the XML data handler does the following:

1. If the calling connector passes in a business object to the conversion method, the data handler uses this business object and continues. If the caller does *not* pass in a business object, the data handler determines the business object name and creates a business object to contain the data in the XML document.

To determine the business object name, the data handler invokes the name handler. The default name handler forms the top-level business object name by combining the BOPrefix meta-object attribute, an underscore, and the value of the root element. For example, if the XML document contains `<!DOCTYPE Customer >` and the BOPrefix attribute is MyApp, the resulting name is MyApp_Customer. You can provide a custom name handler to configure different behavior.

2. The data handler retrieves the value of the Parser meta-object attribute to determine which SAX parser to use to parse the XML document. For

information on which SAX parser the XML data handler uses, see “SAX parser” on page 29. When the data handler determines the name of the parser, it instantiates the parser.

3. The data handler registers the event handler (for a DTD-based XML document, it also registers the entity resolver) with the parser. The event handler is a callback method that processes each XML element and attribute.

Note: The entity resolver handles external entity references in DTD documents. If the data handler does not find an `EntityResolver` option with a valid class name, it uses `com.crossworlds.DataHandlers.xml.DefaultEntityResolver`. This entity resolver ignores all external references.

4. The data handler invokes the parser to parse the XML document.
 - The data handler determines if there are any child meta-objects (those whose names are listed in the `cw_mo_label` tag of the business object application-specific information). The data handler does *not* perform the processing to populate these attributes of the business object.
 - Depending on the type of element, the parser’s event handler queries the business object definition for the attribute properties and processes element data accordingly. Execution is stopped only on fatal errors from the parser or when an element in the XML data cannot be found in the business object definition.
5. When the business object is complete, the data handler returns it to the caller.

Note: For every element and attribute found in an XML document, the data handler expects to find an attribute in the business object. If there is no attribute in the business object definition for a given element or attribute name, the data handler returns an error. The exception to this rule is for attributes of type `FIXED`, which are not required in a business object definition. If `FIXED` attributes are not present in the business object definition, execution does not stop if a `FIXED` attribute is found in the XML document.

Customizing the XML data handler

You can customize the XML data handler by:

- “Building a custom XML name handler”
- “Building a custom entity resolver” on page 84

Building a custom XML name handler

The XML data handler calls the name handler to extract the name of the business object from an XML message. The default name handler included with the XML data handler looks for the tag:

```
<!DOCTYPE Name>
```

From this tag and the `BOPrefix` meta-object attribute, the data handler generates the name of the business object. The XML data handler determines which name handler to invoke by using the value of the `NameHandlerClass` attribute stored in the data-handler meta-object. If you need the name handler to function in a different way, you must:

1. Create a custom name handler by extending the `NameHandler` class.

2. Configure the XML data handler to use the custom class by updating the default value of the NameHandlerClass attribute in the meta-object for the XML data handler.

The following sample code extends the DataHandler class to create a custom data handler, CustomDataHandler, for the XML data handler:

```
package com.crossworlds.DataHandlers.xml;

// DataHandler Dependencies
import com.crossworlds.DataHandlers.
    Exceptions.MalformedDataException;
import com.crossworlds.DataHandlers.NameHandler;
import com.crossworlds.DataHandlers.DataHandler;

// Java classes
import java.io.*;
import java.lang.Exception;

/*****
 * CustomNameHandler class. This class extends the NameHandler
 * class and implements method:
 *   getBOName( Reader serializedData, String subType )
 * The method getBOName contains the logic to extract the BOName
 *****/
public class CustomNameHandler extends NameHandler
{

    /**
     * This method generates the business object name from
     * the data extracted from the 'serializedData' arg.
     * In this case, it is up to the caller to create
     * the BOName.
     */

    public String getBOName( Reader serializedData,
        String subType )
        throws MalformedDataException
    {
        // The NameHandler uses DataHandler tracing. If the
        // DataHandler is not set, the NameHandler won't run.
        if (dh == null)
            return null;
        // Log a message
        dh.traceWrite(
            "Entering CustomNameHandler.getBOName for subtype '"
                + subType + "'.", 4);

        // This method parses the XML document and extracts the
        // business object name from the following tag in
        // the XML doc:
        //   <cml title=
        // For example, in:
        //   <cml title="cholesterol" id="cml_cholesterol">
        // the business object name is 'cholesterol'.

        // Log a message
        dh.traceWrite(
            "Name resolution will be done using <cml title= ",4);
        String name = null;

        try
        {
            // Read line of data from the Reader object
            LineNumberReader lineReader =
                new LineNumberReader( serializedData );
            serializedData.mark( 1000 );

```

```

String line = lineReader.readLine();
while ( line != null )
{
    // search for <cml title= in the line
    int start = line.indexOf("<cml title=");
    if ( start != -1 )
    {
        start += 12;
        // search for the ending quotes for the tile tag
        int end = line.indexOf('\\"', start);

        // extract name from line
        name = line.substring(start, end);
        break;
    }
    line = lineReader.readLine();
}

if ( name == null || name.length() == 0 )
    throw new MalformedURLException(
        "Error: can't determine the BusinessObject Name.");

}

catch(Exception e)
{
    throw new MalformedURLException( e.getMessage() );
}
serializedData.reset();
return name;
}
}

```

Building a custom entity resolver

The SAX parser used by the XML data handler calls the entity resolver to find external entities (referenced DTDs) within an XML document. The entity resolver included with the XML data handler can ignore external references or search for them on a local file system. If you need to specify another way for external entities to be found, you must create a custom entity resolver class.

The XML data handler determines which entity resolver to invoke by using the value of the `EntityResolver` attribute stored in the XML data-handler meta-object.

Chapter 4. Request-Response data handler

The Request-Response data handler handles scenarios that require different data formats for their request and response business objects. The Request-Response data handler allows these two formats to be different. This chapter describes how the Request-Response data handler processes information and how to define business object definitions to be processed by the Request-Response data handler. It also discusses how to configure the Request-Response data handler.

This chapter contains the following sections:

- “Overview”
- “Requirements for business object definitions” on page 92
- “Configuring the Request-Response data handler” on page 95
- “Converting business objects with the request data handler” on page 98
- “Converting business objects with the response data handler” on page 99
- “Error handling” on page 100
- “Customizing the Request-Response data handler” on page 100

Note: The Request-Response data handler is one of the base data handlers contained in the `CwDataHandler.jar` file. For information on how to install this data handler and where to store its source code, see Chapter 2, “Installing and configuring data handlers,” on page 21.

Overview

The Request-Response data handler is a data-conversion module whose primary role is to provide support for request and response data that is in different formats; that is, it enables a calling context (such as an adapter or the Server Access Interface) to call two different data handlers:

- A *request data handler* handles data conversion for the WebSphere business integration system component that *initiates* a request.
- A *response data handler* handles data conversion for the WebSphere business integration system component that *responds* to a request.

With other data handlers, the calling contexts assumes that the data has the same format when sent to and received from the application or access client; therefore, the calling context is configured to call a single data handler to handle the conversion of both request and response business objects.

However, you might have a legacy application that accepts XML as an input and returns some custom-formatted document as output. Existing data handlers cannot easily handle this situation. However, you can configure the adapter that communicates with this legacy application to call the Request-Response data handler. This data handler can be configured to call separate data handlers for input and output:

- The IBM WebSphere Business Integration Data Handler for XML (XML data handler) to handle request business objects
- A custom data handler to handle response business objects

In request processing when the integration broker sends a request to this adapter, the adapter calls the Request-Response data handler, sending it the request business object. The Request-Response data handler checks its configuration to determine that it needs to invoke the XML data handler to convert this business object to an XML document. Once this business object has been converted, the Request-Response data handler returns XML document to the adapter, which in turn routes it to the legacy application.

Figure 29 shows an example of the business-object-to-string conversion as performed by the Request-Response data handler.

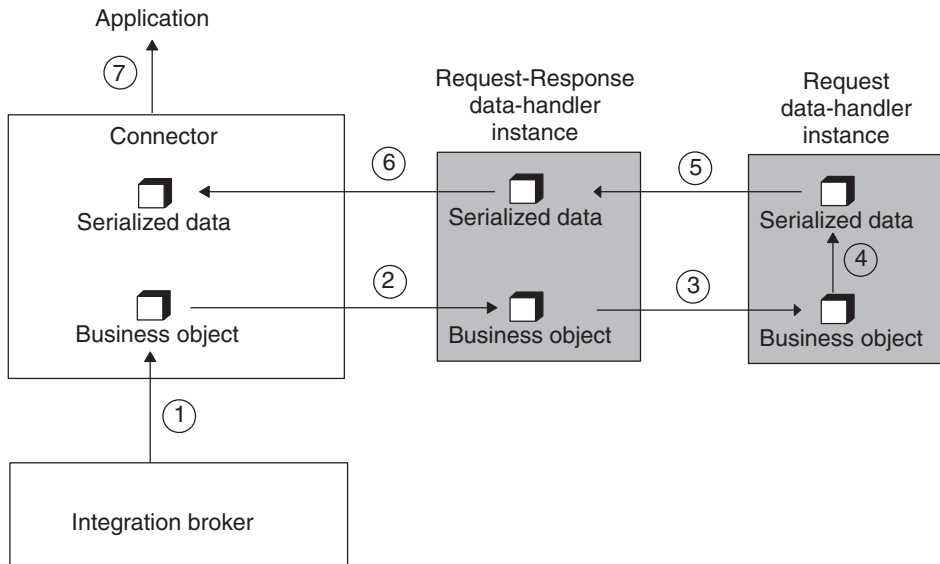

Figure 29. Business-object-to-string conversion with the Request-Response data handler

The adapter might later receive a response from the legacy application. This response would be in the legacy application’s custom format. The adapter again calls the Request-Response data handler, sending it the response data. The Request-Response data handler checks its configuration to determine that it needs to invoke the custom data handler to convert this response data into a business object. Once this data has been converted, the Request-Response data handler returns business object to the adapter, which in turn routes it to the integration broker.

The Request-Response data handler is also to enable the ICS integration broker to post one business object type to a collaboration port and receive one or more different business objects in return. For example, an access client can send a customer object to a collaboration and receive an array of pending order objects for that customer in return.

The Request-Response data handler supports serialized data with the text/requestresponse MIME type. That serialized data may be either text or binary data. However, the default top-level meta-objects (MO_DataHandler_Default or MO_Server_DataHandler) do *not* support the text/requestresponse MIME type. Therefore, for an access client or connector to be able to call the Request-Response data handler, you must modify the appropriate top-level meta-object to support the text/requestresponse MIME type. For more information, see “Configuring the top-level meta-object” on page 95.

This overview provides the following information about the Request-Response data handler:

- “Request-Response data-handler components”
- “Features of the Request-Response data handler”
- “Processing request and response business objects” on page 91

Request-Response data-handler components

A data handler can receive serialized data in one of two ways:

- Receive the serialized data *and* an empty business object: the data handler populates this business object with the serialized data.
- Receive *only* the serialized data: the data handler must create the business object before it can populate it with the serialized data.

The Request-Response data handler uses a name handler to create the name of the top-level business object it creates. Figure 30 illustrates the Request-Response data handler components and their relationship to one another.

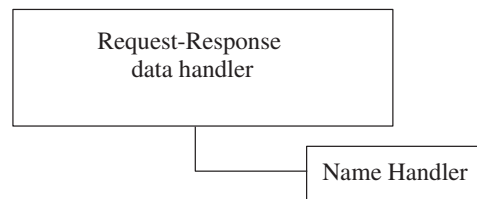

Figure 30. Request-Response data-handler components

The data handler invokes an instance of the name handler based on the value of the `NameHandlerClass` attribute in the Request-Response data handler child meta-object:

- If no class name is provided (the `NameHandlerClass` attribute is empty), the data handler uses its default name handler, which prepends the value of `BOPrefix` attribute to the name of the top-level business object generated by the data handler that is configured for requests. an error and generates an exception.
For example, if the user specifies the default `BOPrefix` of `REQUESTTEST` and the request data handler generates the business object `Customer`, the Request-Response data handler creates a top-level object named `REQUESTTEST_Customer` and attempts to populate one of its child objects with the `Customer` object.
- If a class name is provided in the `NameHandlerClass` attribute, the Request-Response data handler uses this name handler to determine the business object name.

To specify a custom name handler, set the `NameHandlerClass` to the name of the custom name-handler class. For information on how to create a custom name handler, see “Customizing the Request-Response data handler” on page 100.

The `NameHandlerClass` attribute in the version of the meta-object delivered with the product is blank. Therefore, the Request-Response name handler uses its default name handler.

Features of the Request-Response data handler

The Request-Response data handler is useful in both of the following cases:

- “Support for event processing” on page 88

- “Support for request processing” on page 90

Support for event processing

Event processing involves the notification of the integration broker that some event, which indicates a change to application business entities, has occurred. In event notification, the calling context of a data handler calls a data handler: the data handler to convert the serialized data to a business object (which is then routed to the integration broker). This string-to-business-object conversion is performed by the request data handler, because this data handler handles conversion from the request (input) format to a business object.

Event processing can be either synchronous or asynchronous. However, because in asynchronous event processing the adapter ((in particular, the connector component of the adapter) does not wait for a response from the integration broker , as follows:

- Synchronous event processing occurs when an access client notifies the IBM WebSphere InterChange Server (in particular, some collaboration within this server) that some event has occurred. The access client does not wait for a response from ICS, nor does it wait for a response. In this case, the Server Access Interface (within ICS) invokes the necessary data handlers.
- Asynchronous event processing occurs when an adapter (in particular, the connector component of the adapter) receives an event from its application or technology and sends this event (in the form of a business object) to an integration broker to notify it that something has occurred. However, the connector does not wait for a response from the integration broker. Therefore, the Request-Response data handler is not useful in the case of asynchronous event processing.

Note: For more information on the calling contexts of data handlers, see “Contexts for calling data handlers” on page 6.

For example, the following steps describe synchronous event processing. They describe how the Request-Response data handler allows the Server Access Interface (within ICS) to send data in one format (its request format) to the ICS and to receive a different form of data (its response format) in return. This allows an access client to complete a scenario such as sending a customer XML document and receiving an XML document containing pending orders for that customer in return.

1. An access client sends an event (as data in the request format) to be executed by a collaboration within ICS.
2. ICS creates a new instance of the Request-Response data handler and passes it request-format data.
3. The Request-Response data handler calls its configured request data handler, which converts the request-format data to a business object.

The Request-Response data handler uses its `getB0()` method to handle the serialized data it receives. It invokes the request data handler on this serialized data if either of the following conditions are true:

- If the `getB0()` method receives *only* the serialized data as an argument, it considers this data as a new request.
- If the `getB0()` method receives top-level business object *and* the serialized data as an argument, it checks the child business objects of the top-level business object to determine its next action.

If all child business objects contain a value of `CxIgnore` (indicating that they are *empty*), the data handler assumes that the serialized data represents a new request.

Note: If a child business object within the top-level business object is populated, the data handler assumes that this child object represents the original request and consequently that the serialized data represents the response. Therefore, it creates an instance of the response data handler to process the data. For more information, see “Support for request processing” on page 90.

In either of these cases, the Request-Response data handler creates an instance of the request data handler and uses this data handler to convert the request-format data to a request business object. To the request data handler, the Request-Response data handler passes the request-format data. The request data handler returns the corresponding request business object.

4. The Request-Response data handler adds the request business object as a child of the top-level business object, as follows:
 - If the data handler’s `getBO()` method did *not* receive a top-level business object, it must create a new one and then add the request business object to it. To name this new business object, the data handler calls its name handler. For more information, see “Request-Response data-handler components” on page 87.
 - If the data handler’s `getBO()` method *did* receive a top-level business object, it just adds the request business object to it.
5. The Request-Response data handler returns the top-level business object synchronously to the collaboration (which the access client has specified).
6. The collaboration receives the top-level business object, extracts the child object (which contains the request business object) and executes some business process.
7. The collaboration creates a new response business object and adds it to the top-level business object, then returns successfully.

This top-level business object is the one that the collaboration has received from the Request-Response data handler. Once the collaboration has updated this business object, the business object contains both the original request business object and the newly created response business object.

8. ICS passes the modified top-level business object to the Request-Response data handler.
9. The Request-Response data handler calls its configured response data handler to convert the response business object to response-format data.

The Request-Response data handler uses its `getStringFromBO()` method to handle the top-level business object it receives. If more than one child business object in the top-level business object is populated, the data handler assumes that the top-level business object contains *both* the original request business object and its response business object and consequently that the response business object must be converted. Therefore, it creates an instance of the response data handler to process the last defined child business object within the top-level business object as the response business object.

Note: If only one child business object within the top-level business object that `getStringFromBO()` received is populated, the data handler assumes that the child object represents a new request. Therefore, it creates an instance of the request data handler to convert the request business

object to serialized data (in the request format). For more information, see “Support for request processing.”

10. The Request-Response data handler returns the response-format data to its caller (Server Access Framework in ICS).
11. ICS returns the response-format data (which is based on the response business object) to the access client.

A connector can also perform synchronous event processing with the `executeCollaboration()` method. Generally, however, it performs asynchronous event processing using an event detection mechanism such as polling.

Support for request processing

Request processing involves the receipt of requests from the integration broker and to initiate the appropriate changes in the application business entities. Unlike event processing, which can be initiated by either an access client (synchronously) or a connector (asynchronously), request processing is initiated by an integration broker and involves communication with connectors only (not access clients).

In request processing, the calling context of a data handler calls a data handler to convert the serialized data to a business object (which is then routed to the integration broker). This string-to-business-object conversion

For example, the following steps describe request processing that involves a IBM WebSphere InterChange Server integration broker and a technology adapter. This technology adapter is configured to use the Request-Response data handler to handle request and response data. In this case, the request data is in one format and the response data in another.

1. The collaboration creates a new instance of the top-level business object and adds the request business object as a child.
2. The collaboration sends a request (in the form of the top-level business object) to the technology connector, which in turn passes the top-level business object to the Request-Response data handler.
3. The Request-Response data handler calls its configured request data handler to convert the request business object to request-format data.

The Request-Response data handler uses its `getStringFromBO()` method to handle the top-level business object it receives. If only one child business object within the top-level business object is populated, the Request-Response data handler assumes that the child object represents a new request. Therefore, it creates an instance of the request data handler to convert the request business object to serialized data (in the request format).

Note: If more than one child business object in the top-level business object that `getStringFromBO()` received is populated, the data handler assumes that the top-level business object contains *both* the original request business object and its response business object and consequently that the response business object must be converted. Therefore, it creates an instance of the response data handler to process the last defined child business object within the top-level business object as the response business object. For more information, see “Support for event processing” on page 88.

4. The technology connector sends the request-format data to the application.
5. The application performs some tasks and returns response-format data to the technology connector.

6. The technology connector passes both the original top-level business object and the response-format data to the Request-Response data handler.
7. The Request-Response data handler calls its configured response data handler to convert the response-format data to a business object.

The Request-Response data handler uses its `getB0()` method to handle the top-level business object and the serialized data it receives. If any of the child business objects within the top-level business object are populated, the Request-Response data handler assumes that the child object represents the original request and consequently that the serialized data it received is in the response format. Therefore, it creates an instance of the response data handler to convert the serialized data to a response business object.

Note: If all child business objects in the top-level business object that `getB0()` receives contain a value of `CxIgnore` (indicating that they are *empty*), the data handler assumes that the serialized data represents is a new request and creates an instance of the request data handler to process the data. For more information, see “Support for event processing” on page 88.

8. The Request-Response data handler adds this response business object as a child of the top-level business object and then returns this top-level business object to its caller (the technology connector).
9. The technology connector returns the updated top-level business object to the collaboration.
10. The collaboration receives the top-level business object and incorporates the content of its response business object into the business process.

Processing request and response business objects

Use of the Request-Response data handler to convert a request business object to its appropriate request format, or to convert data in a response format to a response business object requires that the steps outlined in Table 29 occur.

Table 29. Using the Request-Response data handler

Step	For more information
1. Business object definitions that describe the business-object structure must exist and be available to the Request-Response data handler (and its component data handlers) when it executes.	“Requirements for business object definitions” on page 92
2. The Request-Response data handler must be configured for your environment.	“Configuring the Request-Response data handler” on page 95
3. The Request-Response data handler must be called from a calling context (connector or access client) to perform the appropriate data operation:	
a) Data operation: Receive the request from the component that initiates this request and convert it to the appropriate format.	“Converting business objects with the request data handler” on page 98
b) Data operation: Receive the response from the component that responds to the request and convert it to the appropriate format.	“Converting business objects with the response data handler” on page 99

Requirements for business object definitions

To use the Request-Response data handler, you must create or modify business object definitions so that they provide the structure that the data handler requires. However, unlike other data handlers, you do not need to modify business object definitions so that they contain metadata. This section provides the information you need to create business object definitions to work with the Request-Response data handler. In particular, it provides the following information:

- “Understanding Request-Response business object structure”
- “Creating business object definitions for the Request-Response data handler” on page 94

Understanding Request-Response business object structure

The Request-Response data handler uses business object definitions when it receives business object from or sends business objects to its request or response data handler. The Request-Response data handler places specific requirements on the structure of business objects it can process. Business objects passed to the data handler must contain one request child object and one or more response child objects. These child objects must conform to the requirements of the data handler that will process them.

Note: The Request-Response data handler does *not* require application-specific information in the business object definitions or their attributes.

Figure 31 shows the structure of the business objects that represent a Request-Response business object.

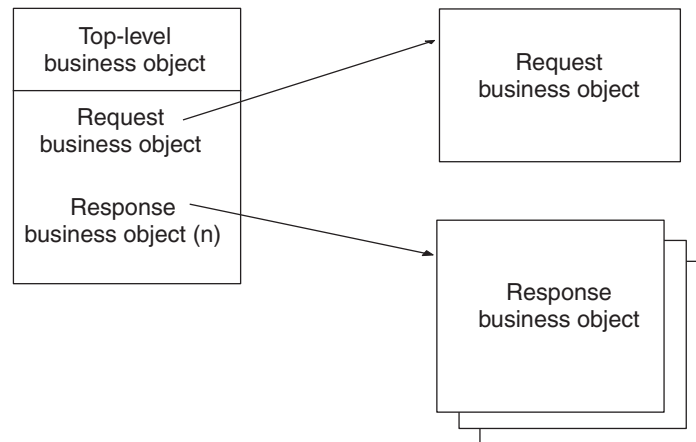

Figure 31. Business object structure for a request-response business object

To ensure that business object definitions conform to the requirements of the Request-Response data handler, use the guidelines provided for each of the following business objects:

- “Top-level business object” on page 93
- “Request business object” on page 93
- “Response business object” on page 94

Top-level business object

The Request-Response data handler expects a top-level business object to hold the information it receives from or sends to its calling context. Table 30 describes how the Request-Response data handler interprets the properties of a business object and describes how to set the properties when modifying a business object for use with the Request-Response data handler.

Table 30. Properties for the top-level business object definition

Property name	Description
Name	Each business object definition must have a unique name. It is recommended that these business object definitions begin with a standard prefix. The name of the top-level business object depends on the message standard, as follows: <i>BusObj Prefix + Response Business Object</i>
Version	A constant representing the current version of the business object definition. Current value is 1.0.0.
Application-specific Information	No application-specific information is required.

This top-level business object must contain the following attributes:

- A single-cardinality attribute to hold a single request business object
This request business object must conform to any business-object requirements that the request data handler requires.
- An single-cardinality attribute to hold the response business objects
The response business object must conform to any business-object requirements that the response data handler requires.

Notes:

1. If the target application could return *more than one* kind of response business object, the top-level business object must contain one child business object for each type of response business object.
For example, if the target application could return either a Customer XML document or an OrderUpdate XML document, the top-level business object definition must include two attributes, one to hold the business object definition that represents the Customer XML document, and the second to hold the business object definition that holds the OrderUpdate XML document. When it received the response business object, the data handler would populate the appropriate attribute.
2. The data handler fails if it receives a top-level business object that does *not* conform to expectations or if other data handlers involved fail to convert the business objects or documents passed to them.

Request business object

To hold the request information for the request data handler, the Request-Response data handler expects a request business object as the first attribute of the top-level business object. This attribute should be of single cardinality. Table 31 describes how the Request-Response data handler interprets the properties of this business object definition and describes how to set these properties when modifying the business object for use with the Request-Response data handler.

Table 31. Properties for the request business object definition

Property name	Description
Name	Each business object definition must have a unique name. This name must match the name of the business object definition that the request data handler handles.
Version	A constant representing the current version of the business object definition. Current value is 1.0.0.
Application-specific information	Depends on the particular request data handler being used.

Note: For information on the format of the request business object, see the documentation for the data handler that acts as the request data handler.

For example, if you specified `RequestDataHandlerMimeType` as `text/xml`, the child object you define as your request business object must be compatible with the XML data handler.

Response business object

To hold the response information for the response data handler, the Request-Response data handler expects a response business object in the attributes starting with the second attribute of the top-level business object. This attribute should be of single cardinality. If the response data handler might return more than one type of business object, the top-level business object has an attribute for each possible type. Table 32 describes how the Request-Response data handler interprets the properties of this business object definition and describes how to set these properties when modifying the business object for use with the Request-Response data handler.

Table 32. Properties for the response business object definition

Property name	Description
Name	Each business object definition must have a unique name. This name must match the name of the business object definition that the response data handler handles.
Version	A constant representing the current version of the business object definition. Current value is 1.0.0.
Application-specific information	Depends on the particular request data handler being used.

Note: For information on the format of the request business object, see the documentation for the data handler that acts as the request data handler.

For example, if you specified `ResponseDataHandlerMimeType` as `text/abc`, the child object you define as your request business object must be compatible with a custom data handler that can handle the abc MIME type.

Creating business object definitions for the Request-Response data handler

This section describes how to create business object definitions to represent the structure that the Request-Response data handler expects. Use Business Object Designer Express to add or delete attributes from the business object definition as well as edit attribute properties, as needed.

As described in “Understanding Request-Response business object structure” on page 92, the Request-Response data handler requires that you create the following business object definitions:

- “Creating the top-level business object definition”
- “Creating other business object definitions”

Creating the top-level business object definition

To create the top-level business object definition for the Request-Response data handler, you must manually create a business object definition using Business Object Designer Express:

1. Create the top-level business object definition.
For information on the structure of this top-level business object, see “Top-level business object” on page 93.
2. Create the child business objects for the top-level business object. In the top-level business object, create a child object attribute for the business objects shown in Table 33.

Table 33. Business objects for the Request-Response data handler

Attribute	Notes	Business object
Request business object	Contains the information about the request.	“Request business object” on page 93
Response business object	Contains the information about the request’s response	“Response business object” on page 94

Creating other business object definitions

To create the request and response business object definitions, you can use either of the following ways:

- You can use an Object Discovery Agent (ODA) to export the serialized data as a business object definition. ODAs exist for several data formats, including XML documents.
For information on the XML ODA, see “Using the XML ODA,” on page 171. For information on other ODAs, refer to the corresponding adapter guide.
- You can manually create a business object definition for the data using Business Object Designer Express.
For more information, see “Creating the top-level business object definition”

Configuring the Request-Response data handler

The Request-Response data handler retrieves its configuration properties from a hierarchy of meta-objects, as follows:

- The parent meta-object allows a connector or Server Access Interface to instantiate a data handler based on the MIME-type of the document.
- The child meta-object contains all the information needed to process the data in the document, including the class name of the data handler, the prefix of the business object to create, and more.

Configuring the top-level meta-object

The MIME type contained in the parent meta-object indicates which MIME types are supported and which data handlers provide this support. Neither of the provided top-level meta-object include an entry for the Request-Response data handler. To enable your connector or an access client to use the Request-Response data handler, you must add an attribute for the text/requestresponse MIME type

to the `MO_Server_DataHandler` or `MO_DataHandler_Default` top-level meta-object. This attribute must be of type `MO_DataHandler_DefaultRequestResponseConfig`.

The following fragment of a business object definition shows the definition for the `text/requestresponse` attribute:

```
[Attribute]
Name = text.requestresponse
Type = MO_DataHandler_DefaultRequestResponseConfig
ContainedObjectVersion = 1.0.0
Relationship = Containment
Cardinality = 1
MaxLength = 1
IsKey = false
IsForeignKey = false
IsRequired = false
IsRequiredServerBound = false
[End]
```

Note: For more information on top-level meta-objects and how to modify them, see “Top-level meta-objects” on page 22.

Configuring the child meta-object

To configure a Request-Response data handler, you must ensure that its configuration information is provided in the Request-Response’s child meta-object.

Note: To configure a Request-Response data handler, you must also create or modify business object definitions so that they support the data handler. For more information, see “Requirements for business object definitions” on page 92.

For the Request-Response data handler, IBM delivers the default child meta-object `MO_DataHandler_DefaultRequestResponseConfig`. Each attribute in this meta-object defines a configuration property for the Request-Response data handler. Table 34 describes the attributes in this child meta-object.

Table 34. Child meta-object attributes for the Request-Response data handler

Attribute name	Description	Delivered default value
<code>BOPrefix</code>	Prefix used by the default <code>NameHandler</code> class to build the name of the top-level business object. The default value must be changed to match the name of the associated the business object definition. The attribute value is case-sensitive.	<code>REQUESTTEST</code>
<code>ClassName</code>	Name of the data-handler class to load for use with the specified MIME type. The top-level data-handler meta-object must has an attribute whose name matches the specified MIME type and whose type is the Request-Response child meta-object (described by this table).	<code>com.crossworlds.DataHandlers.text.requestresponse</code>
<code>NameHandlerClass</code>	Name of the name-handler class to use to determine the name of the top-level business object from the content of a request document. Change the default value of this attribute if you create your own custom name handler. For more information, see “Building a custom XML name handler” on page 82.	<code>com.crossworlds.DataHandlers.xml.TopElementNameHandler</code>

Table 34. Child meta-object attributes for the Request-Response data handler (continued)

Attribute name	Description	Delivered default value
RequestDataHandlerMimeType	The MIME type of requests processed by this data handler. The Request-Response data handler uses this MIME type to determine the data handler to instantiate for processing any request business objects or documents.	text/xml
ResponseDataHandlerMimeType	The MIME type of responses processed by this data handler. The Request-Response data handler uses this MIME type to determine the data handler to instantiate for processing any response business objects or documents.	text/xml
ObjectEventId	Placeholder not used by the data handler but required by the business integration system.	None

The “Delivered default value” column in Table 34 lists the value in the Default Value property for the corresponding attribute in the delivered business object. You must examine your environment and set the Default Value properties of those attributes to the appropriate values. You must make sure that at least the ClassName and BOPrefix attributes have default values.

To create the MO_DataHandler_DefaultRequestResponseConfig child meta-object, use Business Object Designer Express to create a business object definition with the following format:

```
[BusinessObjectDefinition]
Name = MO_DataHandler_DefaultRequestResponseConfig
Version = 1.0.0
  [Attribute]
  Name = ClassName
  Type = String
  Cardinality = 1
  MaxLength = 255
  IsKey = false
  IsForeignKey = false
  IsRequired = false
  DefaultValue = com.crossworlds.DataHandlers.text.requestresponse
  IsRequiredServerBound = false
  [End]
  [Attribute]
  Name = NameHandlerClass
  Type = String
  MaxLength = 255
  IsKey = false
  IsForeignKey = false
  IsRequired = false
  IsRequiredServerBound = false
  [End]
  [Attribute]
  Name = RequestDataHandlerMimeType
  Type = String
  MaxLength = 255
  IsKey = false
  IsForeignKey = false
  IsRequired = false
  DefaultValue = text/xml
  IsRequiredServerBound = false
  [End]
```

```

[Attribute]
Name = ResponseDataHandlerMimeType
Type = String
MaxLength = 255
IsKey = false
IsForeignKey = false
IsRequired = false
DefaultValue = text/xml
IsRequiredServerBound = false
[End]

[Attribute]
Name = BOPrefix
Type = String
MaxLength = 255
IsKey = false
IsForeignKey = false
IsRequired = false
DefaultValue = Wrapper
IsRequiredServerBound = false
[End]

[Attribute]
Name = DummyKey
Type = String
MaxLength = 1
IsKey = true
IsForeignKey = false
IsRequired = false
DefaultValue = 1
IsRequiredServerBound = false
[End]

[Attribute]
Name = ObjectEventId
Type = String
Cardinality = 1
MaxLength = 255
IsKey = false
IsForeignKey = false
IsRequired = false
IsRequiredServerBound = false
[End]

[Verb]
Name = Create
[End]

[Verb]
Name = Delete
[End]

[Verb]
Name = Retrieve
[End]

[Verb]
Name = Update
[End]
[End]

```

Refer to “Configuring data handlers” on page 21 for information on where to put this child meta-object file.

Converting business objects with the request data handler

The *request data handler* handles data conversion for the WebSphere business integration system component that initiates a request:

- In request processing, the integration broker initiates the request, in the form of a request business object sent to a connector.

WebSphere InterChange Server

When the integration broker is InterChange Server (ICS), the collaboration creates the request business object and sends it to the appropriate connector for request processing.

Therefore, the request data handler performs a business-object-to-string conversion on the request, converting the request business object to serialized data. This serialized data is in the *request format*, which is the format that the connector's application (or access client) accepts as input.

- In event processing, the calling context (access client or connector) initiates the request, in the form of serialized data sent to the integration broker.

WebSphere InterChange Server

When the integration broker is ICS, you can use an access client to initiate synchronous event processing. For more information, see "Support for event processing" on page 88.

Therefore, the request data handler performs a string-to-business-object conversion on the request, converting the serialized data to a request business object. This serialized data is in the request format, which is the format that the access client or the connector's application generates as output.

The Request-Response data handler determines which data handler to invoke as its request data handler based on the `RequestDataHandlerMimeType` property in the child meta-object. The `RequestDataHandlerMimeType` property contains the MIME type that the request data handler supports. If `RequestDataHandlerMimeType` has *not* been initialized, the Request-Response data handler logs an error and generates an exception. Therefore, you *must* initialize the `RequestDataHandlerMimeType` property.

Converting business objects with the response data handler

The *response data handler* handles data conversion for the WebSphere business integration system component that responds to a request:

- In request processing, the connector's application responds to the request, in the form of serialized data sent to connector, which in turn routes it to the integration broker.

WebSphere InterChange Server

When the integration broker is InterChange Server (ICS), the collaboration receives the response business object from the connector.

Therefore, the response data handler performs a string-to-business-object conversion on the response, converting the serialized data to a response business object. This serialized data is in the *response format*, which is the format that the connector's application (or access client) generates as output.

- In event processing, the integration broker responds to the request, in the form of a response business object sent to the calling context (access client or connector).

WebSphere InterChange Server

When the integration broker is ICS, the collaboration within ICS generates the response business object. ICS then routes this response business object back to the calling context. For more information, see “Support for event processing” on page 88.

Therefore, the response data handler performs a business-object-to-string conversion on the response, converting the response business object to serialized data. This serialized data is in the response format, which is the format that the access client or the connector’s application accepts as input.

The Request-Response data handler determines which data handler to invoke as its response data handler based on the `ResponseDataHandlerMimeType` property in the child meta-object. The `ResponseDataHandlerMimeType` property contains the MIME type that the response data handler supports. If `ResponseDataHandlerMimeType` has *not* been initialized, the Request-Response data handler logs an error and generates an exception. Therefore, you *must* initialize the `ResponseDataHandlerMimeType` property.

Error handling

The Request-Response data handler throws an exception if it cannot process a request. The request-response data handler provides an exception message that describes both what the data handler was attempting to do when the error occurred and any message returned by a component involved in the transaction (such as another data handler or the JCDK). These exceptions are propagated (perhaps not as an exception but another data structure) to the component that invoked the data handler initially.

The Request-Response data handler logs error and traces messages using the services provided by the data handler framework. Error messages and warnings are recorded in ICS logs. The data-handler does not log any messages to the Java console.

Customizing the Request-Response data handler

You can customize the Request-Response data handler by creating a special name handler. The Request-Response data handler calls the name handler to obtain the name of the business object to create. The data handler determines which name handler to invoke by using the value of the `NameHandlerClass` attribute stored in the data-handler meta-object. The default name handler included with the Request-Response data handler prepends the value of the `BOPrefix` attribute to the name of the business object that the response data handler returns. If you need the name handler to function in a different way, you:

1. Create a custom name handler by extending the `NameHandler` class.
2. Configure the Request-Response data handler to use the custom name-handler class by updating the default value of the `NameHandlerClass` attribute in the meta-object for the Request-Response data handler.

For information on how to create a custom data handler, see “Building a custom name handler” on page 147.

Chapter 5. FixedWidth data handler

The FixedWidth data handler converts business objects to fixed-width strings and streams and from fixed-width strings and streams to business objects. This chapter describes how the FixedWidth data handler processes fixed-width documents and how to define business objects to be processed by the data handler. You can use this information as a guide to implementing business objects that conform to the requirements of the FixedWidth data handler. This chapter also discusses how to configure the FixedWidth data handler. This chapter contains the following sections:

- “Overview”
- “Configuring the FixedWidth data handler” on page 104
- “Converting business objects to FixedWidth documents” on page 107
- “Converting FixedWidth documents to business objects” on page 108

Note: The FixedWidth data handler is one of the base data handlers contained in the `CwDataHandler.jar` file. For information on how to install this data handler and where to store its source code, see Chapter 2, “Installing and configuring data handlers,” on page 21.

Overview

The FixedWidth data handler is a data-conversion module whose primary role is to convert business objects to and from strings or streams that have a format of fixed-width fields. A fixed-width string or stream is serialized data with the `text/fixedwidth` MIME type. The data handler parses text data using fixed-width fields. The field lengths are specified by the `MaxLength` property of each business object attribute. The value of this property is stored in the business object definition.

The default top-level connector meta-object (`MO_DataHandler_Default`) supports the `text/fixedwidth` MIME type. Therefore, a connector that is configured to support the `MO_DataHandler_Default` data-handler meta-object can call the FixedWidth data handler. For an access client to be able to call this data handler, you must modify the `MO_Server_DataHandler` meta-object to support the `text/fixedwidth` MIME type. For more information, see “Modifying the top-level meta-object” on page 150.

Features of the FixedWidth data handler

The FixedWidth data handler uses the value of the `MaxLength` property of attributes in a business object definition to determine how to read and write data. `MaxLength` defines the maximum number of characters of the attribute value, including padding to allow for right-justified or left-justified text.

You can configure a pad character that represents spaces to add to or remove from the data for alignment. Pad characters are added when converting business objects to strings and removed when converting strings to business objects. You can also configure the alignment of a business object attribute value to be left- or right-justified. This makes it possible for the attribute value data to retain meaningful characters. Table 35 describes the values for the `Alignment` meta-object attribute.

Table 35. Values of the Alignment meta-object attribute

Value	Description
LEFT	Trims left side and pads right side.
RIGHT	Trims right side and pads left side.
BOTH	When converting strings to business objects, trims both right and left sides. When converting business objects to strings, pads right side with pad characters.

In addition, with the Truncation meta-object attribute, you can configure the FixedWidth data handler to truncate business object values to their MaxLength, or generate an error if an attribute value is a string longer than MaxLength. You can also set the size of the length to be used for the business object name, verb, and business object count for cardinality 1 or n child objects.

Use Business Object Designer Express to set the value of the MaxLength property of String attributes. To change the value of the MaxLength property of other types (such as Integer, Double, and so forth), you must save the business object definition to a file, edit the file manually, and then import the modified definition into the business integration system.

Business object and FixedWidth string processing

The FixedWidth data handler performs the operations listed in Table 36.

Table 36. Data operations for the FixedWidth data handler

Data-handler operation	For more information
Receives a business object from the caller, converts the business object into a FixedWidth string or stream, and passes the FixedWidth data to the caller.	"Converting business objects to FixedWidth documents" on page 107
Receives a string or stream from the caller, builds a business object, and returns the business object to the caller.	"Converting FixedWidth documents to business objects" on page 108

Configuring the FixedWidth data handler

To configure the FixedWidth data handler, take the following steps:

- Enter the appropriate values for the attributes of the FixedWidth child meta-object.
- Create or modify business object definitions so that they support the data handler.

Each of these steps is described in more detail in the following sections.

Configuring the FixedWidth child meta-object

To configure a FixedWidth data handler, you must ensure that its configuration information is provided in the FixedWidth child meta-object. For the FixedWidth data handler, IBM delivers the M0_DataHandler_DefaultFixedWidthConfig child meta-object. Each attribute in this meta-object defines a configuration property for the FixedWidth data handler. Table 37 describes the attributes for this child meta-object.

Table 37. Child meta-object attributes for the FixedWidth data handler

Meta-object attribute name	Meaning	Delivered default value
ClassName	Name of the data handler class to load for use with the MIME type that matches the name of the attribute in the top-level data-handler meta-object. This attribute has the FixedWidth child meta-object as its type.	com.crossworlds. DataHandlers. text.fixedwidth
Alignment	Adds or removes the PadCharacter attribute. For event processing, pad characters are trimmed. For request processing, pad characters are added. Possible values are BOTH, LEFT, and RIGHT. For example, "LEFT" alignment means the value of the business object attributes moves to the extreme left of the space for that attribute value. "BOTH" alignment for event notification means that pad characters are trimmed off both the left and right sides. "RIGHT" alignment for request processing means that the right side is padded with pad characters.	BOTH
BOCountSize	Specifies the space allocated for the total number of business objects being processed.	3
BONameSize	Specifies the space allocated for the name of the business object.	50
BOVerbSize	Specifies the space allocated for the verb.	20
CxBlank	When converting from a business object, the FixedWidth data handler writes the value configured for the Default Value property of the CxBlank meta-object attribute to the fixed-width document whenever it encounters a business object attribute whose value is CxBlank. When converting to a business object, the FixedWidth data handler assigns the value configured for the Default Value property of the CxBlank meta-object attribute to the business object attribute's value whenever it encounters the value of this CxBlank meta-object attribute in the fixed-width document. Business objects must have at least one primary key that does <i>not</i> contain the value CxBlank at runtime.	CxBlank value
CxIgnore	When converting from a business object, the FixedWidth data handler writes the value configured for the Default Value property of the CxIgnore meta-object attribute to the fixed-width document whenever it encounters a business object attribute whose value is CxIgnore. When converting to a business object, the FixedWidth data handler assigns the value configured for the Default Value property of the CxIgnore meta-object attribute to the business object attribute's value whenever it encounters the value of this CxIgnore meta-object attribute in the fixed-width document. Business objects must have at least one primary key that does <i>not</i> contain the value CxIgnore at runtime.	CxIgnore value
DummyKey	Key attribute required by the business integration system.	1
OmitObjectEventId	Boolean value to determine whether or not to include ObjectEventId data in business-object-to-string and string-to-business-object conversions.	false
PadCharacter	Indicates spaces to add or remove for alignment. You can specify any character as the pad character.	#
Truncation	Sets removal of characters. If true, any attribute value in the business object that is greater than MaxLength is truncated to MaxLength during request processing. If false, an error is logged and formatting stops.	false
ObjectEventId	Placeholder not used by the data handler but required by the business integration system.	none

The “Delivered default value” column in Table 37 lists the value in the Default Value property for the corresponding attribute in the delivered business object. You must examine your environment and set the Default Value properties of those attributes to the appropriate values for your system and your FixedWidth documents. You must make sure that at least the `ClassName` attribute has a default value.

Note: Use Business Object Designer Express to modify business object definitions.

Business objects requirements

The FixedWidth data handler makes assumptions about the structure of the business objects that it handles. Therefore, when you create a business object for conversion using the FixedWidth data handler, follow these rules:

- Make sure that every attribute in the business object definition has an appropriate `MaxLength` property value. This ensures that the FixedWidth data handler can properly process the conversion of data from a business object to a FixedWidth format and from a FixedWidth format to a business object.
- Make sure that the `ObjectEventId` attribute is included in every business object at all levels of a business object hierarchy. Business Object Designer Express does this automatically when it saves a business object definition, but you should confirm that the requirement is met.

Business object structure

There are no requirements regarding the structure of the business objects for the FixedWidth data handler. The data handler can process any business object as long as the `MaxLength` attribute property has a value.

The business objects that the data handler processes can have any name allowed by the business integration system.

Business object attribute properties

Business object architecture contains various properties that apply to attributes. Table 38 describes how the FixedWidth data handler interprets these properties and describes how to set the properties when modifying a business object.

Table 38. Attribute properties for business objects converted using the FixedWidth data handler

Property name	Description
Name	Each business object attribute must have a unique name.
Type	Each business object attribute must have a type, such as Integer, String, or the type of a contained child business object.
Key	Not used by the FixedWidth data handler.
MaxLength	Determines the width of the field in which the attribute value is included.
Foreign Key	Not used by the FixedWidth data handler.
Required	Not used by the FixedWidth data handler.
Default Value	Not used by the FixedWidth data handler.
Cardinality	Supports cardinality 1 and cardinality n objects.

Business object application-specific information

The FixedWidth data handler does not require any application-specific information in business objects or their attributes. The data handler does, however, check for the existence of the `cw_mo_` tag, which a business object might use to indicate any child meta-object that the connector uses. The data handler ignores any attribute

identified by the `cw_mo_` tag in the application-specific information of the business object. For more information about the `cw_mo_` tag, see “Implementing conversion from a business object” on page 139.

Using existing business object definitions

The `FixedWidth` data handler can convert any business object to a `FixedWidth` string as long as the business object delivers data in a form that complies with the requirements of the data handler. The single requirement of the `FixedWidth` data handler is that each business object attribute have a `MaxLength` value specified. Existing business objects may need to be modified to specify an appropriate value for `MaxLength`.

Although existing business objects that meet this requirement can be converted by the `FixedWidth` data handler, a good practice is to create your own business objects for each type of data to be processed. If you use a sample business object, or a business object developed to support the same application in another implementation, be sure to modify the definition as necessary to include only the attributes required for the implementation for which you are developing.

Therefore, to convert existing business objects to a form that closely corresponds to your data, modify the business object to provide only the data required by the application and the information required by the data handler. To adapt existing business objects for use with the `FixedWidth` data handler, do the following:

1. Perform a functional analysis of the target application, and compare the results to existing business objects to determine the required fields of a business object definition.
2. Use Business Object Designer Express to add or delete attributes from the business object definition as needed.

Converting business objects to `FixedWidth` documents

To convert a business object to a `FixedWidth` document, the `FixedWidth` data handler loops through the attributes of the business object in sequential order. It generates fields in a fixed-width string recursively in the order in which attributes appear in the business object and its children.

The `FixedWidth` data handler processes business objects into a `FixedWidth` document as follows:

1. The data handler creates a fixed-width string to contain the data in the business object.
2. The data handler adds the business object name and the verb to the fixed-width string. The name of the business object can be specified as an argument to the conversion method.
3. The data handler examines the application-specific information in the business object definition to determine if there are any child meta-objects (those whose names are listed in the `cw_mo_` tag of the business object application-specific information). The data handler does not include these attributes in the `FixedWidth` document. For more information about the `cw_mo_` tag, see “Implementing conversion from a business object” on page 139.
4. The data handler looks for the meta-object attribute named `OmitObjectId`. If this is set to `true`, the data handler does not include the `ObjectId` data of the business object in the `FixedWidth` document.

5. The data handler loops through the remaining business object attributes in order, adding the correct padding to the string for each simple attribute. For array attributes, the data handler does the following:
 - If the attribute represents a single-cardinality attribute, the data handler adds the attribute name and a count of 1 to the string, and then recursively processes the child business object to add the values of each attribute to the string.
 - If the attribute represents a multiple cardinality array, the data handler adds the attribute name and the child object count to the string, and then recursively processes each child business object, adding the values of each attribute to the string.
6. When the data handler completes the conversion, it returns the serialized data to the caller. The data handler returns the data in the form (String or InputStream) requested by the caller.

Note: Any attribute value in the business object that has a length greater than `MaxLength` is truncated to `MaxLength` during request processing if the value of the `Default Value` property of the `Truncation` meta-object attribute is set to `true`. If `Truncation` is set to `false` and an attribute value has a length greater than `MaxLength`, formatting terminates, and an error is logged.

Converting FixedWidth documents to business objects

This section provides the following information on how the FixedWidth data handler converts FixedWidth documents to business objects:

- “FixedWidth string requirements”
- “Serialized-data processing” on page 109

FixedWidth string requirements

When converting a string to an business object, the FixedWidth data handler makes the following assumptions:

- The business object name appears as the first field in the data.
- The verb appears as the second field in the data.
- All attributes are given in the order that they appear in the business object definition.
- The `ObjectEventId` attribute is present in each business object. An entry for `ObjectEventId` is always required for a business object, even when it has the value `CxIgnore`, because the data handler uses it to distinguish between instances of a business object at runtime.

The format for a fixed-width string is as follows:

```
[Bus_Obj_Name<blank_space_padding_for_size>]
[Verb<blank_space_padding_for_size>]
[Attr1<blank_space_padding_for_size>]
[Attr2...<blank_space_padding_for_size>]
[Number-of-child-object_instances<blank_space_padding_for_size>]
[Child_Object_Name<blank_space_padding_for_size>]
[Child_Object_Verb<blank_space_padding_for_size>]
[Child_Object_Attr1<blank_space_padding_for_size>]
[Child_Object_Attr2...<blank_space_padding_for_size>]
<EndBO:Bus_Obj_Name>
```

In this format, the first two fields (`Bus_Obj_Name` and `Verb`) are padded to create fields of a length specified by the `B0NameSize` and `B0VerbSize` attributes in the

FixedWidth child meta-object. The subsequent attributes are padded to create fields of a length specified in the MaxLength property for each business object attribute.

A field used with the FixedWidth data handler must be at least eight characters long if CxIgnore is a possible value for that attribute. If an attribute is guaranteed not to have a CxIgnore value, MaxLength can be less than eight characters long.

When a connector reads a file in fixed-width format, the CxIgnore and CxBlank meta-object attributes must be configured to generate the desired values. These strings affect the minimum MaxLength attributes. The minimum value for MaxLength must accommodate both.

Serialized-data processing

The FixedWidth data handler processes a FixedWidth document into a business object as follows:

1. The data handler creates a business object to contain the data. The type of business object is either passed into the conversion method by the connector, or the data handler extracts the name of the business object from the first field of the string. If the type parameter and the content in the data do not match, the data handler generates an error.
2. The data handler sets the verb in the business object. The data handler assumes that the verb for the top-level business object is in the second field in the data.
3. The data handler determines if there are any child meta-objects (those whose names are listed in the cw_mo_ tag of the business object application-specific information). The data handler does *not* perform the processing to populate these attributes of the business object. For more information about the cw_mo_ tag, see “Implementing conversion from a business object” on page 139.
4. The data handler looks for the meta-object attribute named OmitObjectId. If this is set to true, the data handler does not perform the processing to populate the ObjectId attribute.
5. To set the remaining business object attributes, the data handler parses the data based on the MaxLength of each attribute as specified in the business object definition. It extracts attribute values from the data and populates the values of the simple attributes in the business object.

The data handler processes array attributes as follows:

- If the attribute is a single-cardinality attribute, the data handler recursively parses the attribute list, sets the attribute values, and adds the child business object to the parent business object.
- If the attribute is a multiple cardinality array, the data handler recursively parses the attributes in each child attribute list, and adds the child business object to the parent business object.

Chapter 6. Delimited data handler

The Delimited data handler converts business objects to delimited-format strings and streams, and from delimited-formatted strings and streams to business objects. This chapter describes how the Delimited data handler processes delimited data and how to define business objects to be processed by the data handler. You can use this information as a guide to modifying existing business objects or implementing new business objects that conform to the requirements of the data handler. This chapter also discusses how to configure the Delimited data handler. This chapter contains the following sections:

- “Overview”
- “Configuring the Delimited data handler” on page 112
- “Converting business objects to delimited data” on page 115
- “Converting delimited data to business objects” on page 116

Note: The Delimited data handler is one of the base data handlers contained in the `CwDataHandler.jar` file. For information on how to install this data handler and where to store its source code, see Chapter 2, “Installing and configuring data handlers,” on page 21.

Overview

The Delimited data handler is a data-conversion module whose primary role is to convert business objects to and from delimited-formatted strings or streams. A delimited-formatted string or stream is serialized data with the `text/delimited` MIME type. The data handler parses text data based on a specified delimiter that separates the individual fields of a business object’s data. This type of data conversion is used primarily where the efficiency of machine reading is most important.

The default top-level connector meta-object (`MO_DataHandler_Default`) supports the `text/delimited` MIME type. Therefore, a connector that is configured to use the `MO_DataHandler_Default` meta-object can call the Delimited data handler. If an access client must be able to call this data handler, you must modify the top-level server meta-object (`MO_Server_DataHandler`) to support the `text/delimited` MIME type. For more information, see “Modifying the top-level meta-object” on page 150.

Features of the Delimited data handler

The Delimited data handler allows you to set the following strings:

- The delimiter—The data handler uses a delimiter to separate the different fields in the delimited data. You can set the `Delimiter` meta-object attribute to the desired delimiter for your data. By default, the data handler uses a tilde (~) as the delimiter is size of the attribute property `MaxLength` to determine how to read and write data. `MaxLength` is an business object attribute property that defines the maximum number of characters of the attribute value, including padding to allow for right-justified or left-justified text. `MaxLength` is read from the definition of the business object in the repository. Accordingly, the main requirement for a business object is that the `MaxLength` for each string attribute is set appropriately.
- The escape string—The data handler uses the escape string to configure a string to escape the delimiter and escape strings. The escape string allows the attribute

value data to contain delimiter-like and escape-like strings. You can set the Escape meta-object attribute to configure the escape string. By default, the data handler uses the backslash character (\) as the escape string.

Business object and string processing

The Delimited data handler performs the operations listed in Table 39.

Table 39. Data operations for the Delimited data handler

Data-handler operation	For more information
Receives a business object from the caller, converts the business object to a Delimited string or stream, and passes the serialized data to the caller.	“Converting business objects to delimited data” on page 115
Receives a string or stream from the caller, builds a business object, and returns the business object to the caller. Receives a Delimited string or stream from the caller, builds a business object, and passes the business object to the caller.	“Converting delimited data to business objects” on page 116

Configuring the Delimited data handler

To configure the Delimited data handler, take the following steps:

- Enter the appropriate values for the attributes of the Delimited child meta-object.
- Create or modify business object definitions so that they support the data handler.

Each of these steps is described in more detail in the following sections.

Configuring the Delimited child meta-object

To configure a Delimited data handler, you must ensure that its configuration information is provided in the Delimited child meta-object. For the Delimited data handler, IBM delivers the `MO_DataHandler_DefaultDelimitedConfig` child meta-object. Each attribute in this meta-object defines a configuration property for the Delimited data handler. Table 40 describes the attributes in this child meta-object.

Table 40. Child meta-object attributes for the Delimited data handler

Meta-object attribute name	Meaning	Delivered default value
ClassName	Name of the data handler class to load for use with the specified MIME type. The top-level data-handler meta-object has an attribute whose name matches the specified MIME type and whose type is the Delimited child meta-object (described by Table 40).	<code>com.crossworlds.DataHandlers.text.delimited</code>
CxBlank	Establishes the equivalent value in the Delimited data for the special business object attribute value, Blank (the <code>CxBlank</code> constant). For more information, see “CxBlank” on page 114.	<code>CxBlank</code> constant (blank space)
CxIgnore	Establishes the equivalent value in the Delimited data for the special business object attribute value, Ignore (the <code>CxIgnore</code> constant). For more information, see “CxIgnore” on page 114.	<code>CxIgnore</code> constant (empty string)

Table 40. Child meta-object attributes for the Delimited data handler (continued)

Meta-object attribute name	Meaning	Delivered default value
Delimiter	String used to separate the values in business object attributes when writing business object data to files, or that is assumed to separate fields of data that correspond to attributes when converting a file to a business object. This value can contain multiple characters.	~ (tilde)
DummyKey	Key attribute required by the business integration system.	1
Escape	String used to escape the delimiter and escape characters if they occur in a business object attribute value. This value can only be one character in length.	\ (backslash)
OmitObjectId	Boolean value to determine whether or not to include ObjectId data in business object-to-String and String-to-business object conversions.	false
ObjectId	Placeholder attribute required by the business integration system.	none

The “Delivered default value” column in Table 40 lists the value in the Default Value property for the corresponding attribute in the delivered business object. You must examine your environment and set the Default Value properties of those attributes to the appropriate values for your system and your Delimited documents. You must make sure that at least the `ClassName` attribute has a default value.

Note: Use Business Object Designer Express to modify business object definitions.

Business object requirements

The Delimited data handler makes assumptions about the business objects that it handles. Therefore, when you create a business object for conversion using the Delimited data handler, follow these rules:

- Make sure that every business object attribute has a name to ensure that the Delimited data handler can properly convert the data.
- Make sure that the `ObjectId` attribute is included in every business object at all levels of a business object hierarchy. Business Object Designer Express does this automatically when it saves a business object definition, but you should confirm that the requirement is met.

The `Delimiter` attribute in the child meta-object configures the delimiter used to separate attribute fields. The default value is a tilde (~).

You can set the child meta-object attribute `Escape` to configure a string to escape the delimiter and escape strings. The escape string allows the attribute value data to contain delimiter-like and escape-like strings.

Business object structure

There are no requirements regarding the structure of the business objects for the Delimited data handler. The data handler can process any business object.

The business objects that the data handler processes can have any name allowed by the integration broker.

Business object attribute properties

Business object architecture contains various properties that apply to attributes. Table 41 describes how the Delimited data handler interprets several of these properties and describes how to set the properties when modifying a business object.

Table 41. Attribute properties for business objects converted using the Delimited data handler

Property name	Description
Name	Every business object attribute must have a unique name.
Type	Each business object attribute must have a type, such as Integer, String, or the type of a contained child business object.
Key	Not used by the Delimited data handler.
MaxLength	Not used by the Delimited data handler.
Foreign Key	Not used by the Delimited data handler.
Required	Not used by the Delimited data handler.
Default Value	Not used by the Delimited data handler.
Cardinality	Supports cardinality 1 and cardinality n objects.

Attributes in business objects can have the special values of `CxIgnore` or `CxBlank`. The Delimited data handler takes special processing steps when attributes have these values, as described in the following sections.

CxIgnore: The `CxIgnore` meta-object attribute establishes the equivalent value in a Delimited data for the Ignore attribute value (the `CxIgnore` constant). By default, the `CxIgnore` meta-object attribute is set to the value of the `CxIgnore` constant. The data handler uses the `CxIgnore` meta-object attribute as follows:

- When converting *from* a business object, the Delimited data handler writes the value of the `CxIgnore` meta-object attribute (the value configured for its Default Value property) to the Delimited data whenever it encounters a business object attribute with the `CxIgnore` constant as its attribute value.
- When converting *to* a business object, the Delimited data handler assigns the `CxIgnore` constant to the business object attribute's value whenever it encounters the value of the `CxIgnore` meta-object attribute (the value configured for its Default Value property) in the Delimited data.

Note: Business objects must have at least one primary key that does *not* contain the value `CxIgnore` at runtime.

CxBlank: The `CxBlank` meta-object attribute establishes the equivalent value in a Delimited data for the Blank attribute value (the `CxBlank` constant). By default, the `CxBlank` meta-object attribute is set to the value of the `CxBlank` constant. The data handler uses the `CxBlank` meta-object attribute as follows:

- When converting *from* a business object, the Delimited data handler writes the value of the `CxBlank` meta-object attribute (the value configured for the Default Value property) to the Delimited data whenever it encounters a business object attribute with the `CxBlank` constant as its attribute value.
- When converting *to* a business object, the Delimited data handler assigns the `CxBlank` constant to the business object attribute's value whenever it encounters the value of the `CxBlank` meta-object attribute (the value configured for its Default Value property) in the Delimited data.

Note: Business objects must have at least one primary key that does *not* contain the value `CxBlank` at runtime.

Business object application-specific information

The Delimited data handler does not require any application-specific information in business objects or their attributes. The data handler does, however, check for the existence of the `cw_mo_` tag, which a business object might use to indicate any child meta-object that the connector uses. The data handler ignores any attribute identified by the `cw_mo_` tag in the application-specific information of the business object. For more information about the `cw_mo_` tag, see “Implementing conversion from a business object” on page 139.

Using existing business object definitions

The Delimited data handler can convert any business object to a Delimited string as long as the business object delivers data in a form that complies with the requirements of the data handler. The single requirement of the Delimited data handler is that if the data handler must read in a delimited file, that each individual field is separated by the configured delimiter.

Although existing business objects that meet this requirement can be converted by the Delimited data handler, a good practice is to create your own business objects for each type of data to be processed. If you use a sample business object, or a business object developed to support the same application in another implementation, be sure to modify the definition as necessary to include only the attributes required for the implementation for which you are developing.

Therefore, to convert existing business objects to a form that closely corresponds to your data, modify the business object to provide only the data required by the application and the information required by the data handler. To adapt existing business objects for use with the Delimited data handler, do the following:

1. Perform a functional analysis of the target application, and compare the results to existing business objects to determine the required fields of a business object definition.
2. Use Business Object Designer Express to add or delete attributes from the business object definition as needed.

Converting business objects to delimited data

To convert a business object to a string, the Delimited data handler loops through the attributes of a business object in sequential order. It generates Delimited formatting recursively in the order in which attributes appear in the business object and its children. The name of the business object is passed as an argument to the conversion method.

The Delimited data handler processes business objects into delimited data as follows:

1. The data handler creates a string to contain the data in the business object.
2. The data handler adds the business object name as the first token in the string and adds the verb as the second a token in the string.
3. The data handler examines the application-specific information in the business object definition to determine if there are any child meta-objects (those whose names are listed in the `cw_mo_` tag of the business object application-specific information). The data handler does *not* include these attributes in the delimited data. For more information about the `cw_mo_` tag, see “Implementing conversion from a business object” on page 139.

4. The data handler looks for the meta-object attribute named `OmitObjectEventId`. If this is set to `true`, the data handler does not include `ObjectEventId` data of the business object in the delimited data.
5. The data handler loops through the remaining business object attributes in order, adding values for each simple attribute to the string and adding the configured delimiter after each attribute. For container attributes, the data handler does the following:
 - If the attribute is a cardinality 1 container, the data handler adds the attribute count to the string, and then recursively processes the child business object to add values for each attribute.
 - If the attribute is a cardinality n container, the data handler adds the count of the child objects in the container to the string, and then recursively processes each child business object, adding values for each attribute to the string.
6. When the data handler completes the conversion, it returns the serialized data to the caller. The data handler returns the data in the form (String or `InputStream`) requested by the caller.

The format that the data handler generates conforms to the following pattern:

```
Bus_Obj_Name<delimiter>Verb<delimiter>Attr1<delimiter>Attr2<delimiter>
Number_of_child_object_instances<delimiter>Child_Object_Name<delimiter>Verb
<delimiter>Attr1<delimiter>Attr2<EndBO:Bus_Obj_Name>
```

An escape string is appended in front of any delimiter-like string in an attribute value. The escape string is configured using the `Escape` attribute of the child meta-object.

Converting delimited data to business objects

This section provides the following information on how the Delimited data handler converts Delimited data to business objects:

- “Delimited string requirements”
- “Serialized-data processing” on page 117

Delimited string requirements

When converting a string or stream, the Delimited data handler makes the following assumptions:

- The data contains the delimiter specified in the `Delimiter` meta-object attribute.
- The business object name appears in the first field in the data.
- The verb appears as the second field in the data.
- Attributes are in the order that they appear in the business object definition.
- All objects in a child container are of the same type.
- The data contains a token that represents the number of child objects in each cardinality n container.
- The `ObjectEventId` attribute is present in each business object. An entry for `ObjectEventId` is always required for a business object, even when it has the value `CxIgnore`, because the data handler uses it to distinguish between instances of a business object at runtime.

If you have more than one business object in the data, make sure you do not introduce any new characters (such as a space, a tab, a new line, or a carriage return) between them.

When the Delimited data handler reads a file in Delimited format, it takes the following special processing steps to assign to a business object attribute the CxIgnore or CxBlank attribute value:

- It assigns the CxIgnore constant (null) as the corresponding attribute value whenever it encounters any of the following conditions in the Delimited data:
 - The value of the CxIgnore meta-object attribute (the value configured for its Default Value property)
 - The value of an empty string (" ")
- It assigns the CxBlank constant as the attribute value only when the CxBlank meta-object attribute is configured and it encounters this configured value in the corresponding Delimited data.

Note: Make sure the escape string and the delimiter have different values as configured by the Escape and Delimiter meta-object attributes in the Delimiter data handler child meta-object.

The following line shows an example of a string in Delimited format. The syntax is:

```
Bus_Obj_Name<delimiter>Verb<delimiter>Attr1<delimiter>Attr2<delimiter>
Number_of_child_object_instances<delimiter>Child_Object_Name<delimiter>
Verb<delimiter>Attr1<delimiter>Attr2<EndBO:Bus_Obj_Name>
```

The following sample uses a tilde (~) delimiter:

```
Customer~Create~p1~p2~p3~1~CustomerAddress~Create~q1~q2~q3~q4~q5~q6~q7~q8~q9~q10~3~
PhoneInfo~Create~r1~r2~r3~r4~r5~r6~r7~PhoneInfo~Create~r1~r2~r3~r4~r5~r6~r7~
PhoneInfo~Create~r1~r2~r3~r4~r5~r6~r7
```

Serialized-data processing

The Delimited data handler processes delimited data into a business object as follows:

1. The data handler gets the business object name from the first token in the data and creates a business object to contain the data.
2. The data handler sets the verb in the business object. The data handler assumes that the verb for the top-level business object is in the second token in the delimited data. Note that child business objects may not have verbs set.
3. The data handler determines if there are any child meta-objects (those whose names are listed in the cw_mo_ tag of the business object application-specific information). The data handler does *not* perform the processing to populate these attributes of the business object. For more information about the cw_mo_ tag, see “Implementing conversion from a business object” on page 139.
4. The data handler looks for meta-object attribute named OmitObjectEventId. If this is set to true, the data handler does not perform the processing to populate the ObjectEventId attribute.
5. The data handler parses the data and populates the values of the remaining simple attributes in the business object with the token values from the data. The data handler processes container attributes as follows:
 - If the attribute is single-cardinality, the data handler recursively parses the attribute tokens in the string, sets the attribute values in the business object, and adds the child business object container to the parent business object.
 - If the attribute is multiple cardinality, the data handler recursively parses the attribute tokens for each child object, sets the attribute values in the child business object, and adds the child business object container to the parent business object.

Chapter 7. NameValue data handler

The NameValue data handler converts a business object to string or stream formatted in name-value pairs, and converts a string or stream formatted in name-value pairs to a business object. This chapter describes how the NameValue data handler processes NameValue data and describes how to define business objects to be processed by the NameValue data handler. You can use this information as a guide to implementing business objects that conform to the requirements of the NameValue data handler. This chapter also discusses how to configure the NameValue data handler. This chapter contains the following sections:

- “Overview”
- “Configuring the NameValue data handler” on page 120
- “Converting business objects to NameValue data” on page 123
- “Converting NameValue data to business objects” on page 124

Note: The NameValue data handler is one of the base data handlers contained in the `CwDataHandler.jar` file. For information on how to install this data handler and where to store its source code, see Chapter 2, “Installing and configuring data handlers,” on page 21.

Overview

The NameValue data handler is a data-conversion module whose primary role is to convert a business object to and from a string or stream formatted in name-value pairs. A NameValue-formatted string or stream is serialized data with the `text/namevalue` MIME type. The NameValue data handler can be used to generate a business object file for testing purposes.

The data handler parses serialized data based on named fields. For example, a text file for this data handler contains fields that identify the business object type (`BusinessObject=BOname`), verb (`Verb=verbName`), number of attributes (`AttributeCount=numericValue`), and attribute values (`AttributeName=value`). The data handler uses the name-value information to parse the data.

The default top-level connector meta-object (`MO_DataHandler_Default`) supports the `text/namevalue` MIME type. Therefore, a connector that is configured to use the `MO_DataHandler_Default` meta-object can call the NameValue data handler. For an access client to be able to call this data handler, you must modify the `MO_Server_DataHandler` meta-object to support the `text/namevalue` MIME type. For more information, see “Modifying the top-level meta-object” on page 150.

The NameValue data handler performs the operations listed in Table 42.

Table 42. Data operations for the NameValue data handler

Data-handler operation	For more information
Receives a business object from the caller, converts the business object into a NameValue string or stream, and passes the serialized data to the caller.	“Converting business objects to NameValue data” on page 123
Receives a string or stream from the caller, builds a business object, and returns the business object to the caller.	“Converting NameValue data to business objects” on page 124

Configuring the NameValue data handler

To configure the NameValue data handler, take the following steps:

- Enter the appropriate values for the attributes of the NameValue child meta-object.
- Create or modify business object definitions so that they support the data handler.

Each of these steps is described in more detail in the following sections.

Configuring the NameValue child meta-object

To configure a NameValue data handler, you must ensure that its configuration information is provided in the NameValue child meta-object. For the NameValue data handler, IBM delivers the `MO_DataHandler_DefaultNameValueConfig` child meta-object. Each attribute in this meta-object defines a configuration property for the NameValue data handler. Table 43 describes the attributes for this child meta-object.

Table 43. Child meta-object attributes for the NameValue data handler

Meta-object attribute name	Description	Delivered default value
ClassName	Name of the data handler class to load for use with the specified MIME type. The top-level data-handler meta-object has an attribute whose name matches the specified MIME type and whose type is the NameValue child meta-object (described by Table 43).	<code>com.crossworlds.DataHandlers.text.namevalue</code>
CxBlank	Establishes the equivalent value in the NameValue data for the special business object attribute value, Blank (the <code>CxBlank</code> constant). For more information, see “CxBlank” on page 122.	<code>CxBlank</code> constant
CxBlankValue	<i>This attribute is deprecated.</i> Use the <code>CxBlank</code> meta-object attribute (above) to tell the data handler how the NameValue data represents the <code>CxBlank</code> attribute value.	blank space
CxIgnore	Establishes the equivalent value in the NameValue data for the special business object attribute value, Ignore (the <code>CxIgnore</code> constant). For more information, see “CxIgnore” on page 121.	<code>CxIgnore</code> constant
DefaultVerb	Business object verb	Create
DummyKey	Key attribute required by the business integration system.	1
SkipCxIgnore	During request processing, the processing of the special attribute value <code>CxIgnore</code> is based on the meta-object attribute <code>SkipCxIgnore</code> . For more information, see “CxIgnore” on page 121.	false
ValidateAttrCount	Determines whether the data handler looks for (or adds to the output string) a token that contains a count of attributes in the business object data.	true
ObjectEventId	Placeholder not used by the data handler but required by the business integration system.	none

The “Delivered default value” column in Table 43 lists the value in the Default Value property for the corresponding attribute in the delivered business object. You must examine your environment and set the Default Value properties of those attributes to the appropriate values for your system and your name-value pair-formatted documents.

Note: Use Business Object Designer Express to modify business object definitions.

Business object requirements

The NameValue data handler makes assumptions about the business objects that it handles. Therefore, when you pass a business object for conversion with the NameValue data handler, follow these rules:

- Make sure that every business object attribute has a Name property. This ensures that the NameValue data handler can properly process the conversion of data from a business object to a NameValue format, and a NameValue format to a business object.
- Make sure that the ObjectId attribute is included in every business object at all levels of a business object hierarchy. Business Object Designer Express does this automatically when it saves a business object definition, but you should confirm that the requirement is met.

Business object structure

There are no requirements regarding the structure of the business objects for the NameValue data handler. The data handler can process any business object.

The business objects that the data handler processes can have any name allowed by the business integration system.

Business object attribute properties

Business object architecture contains various properties that apply to attributes. Table 44 describes how the NameValue data handler interprets several of these properties and describes how to set the properties when modifying a business object definition.

Table 44. Attribute properties for business objects converted using the NameValue data handler

Property name	Description
Name	Each business object attribute must have a unique name.
Type	Each business object attribute must have a type, such as integer, String, or the type of a contained child business object. All simple attributes must be of type String.
Key	Not used by the NameValue data handler.
MaxLength	Not used by the NameValue data handler.
Foreign Key	Not used by the NameValue data handler.
Required	Not used by the NameValue data handler.
Default Value	Not used by the NameValue data handler.
Cardinality	Supports cardinality 1 and cardinality n objects.

Attributes in business objects can have the special values of CxIgnore or CxBlank. The NameValue data handler takes special processing steps when attributes have these values, as described in the following sections.

CxIgnore: The CxIgnore meta-object attribute establishes the equivalent value in a NameValue data for the Ignore attribute value (the CxIgnore constant). By default, the CxIgnore meta-object attribute is set to the value of the CxIgnore constant. The data handler uses the CxIgnore meta-object attribute as follows:

- When converting *from* a business object, the NameValue data handler writes the value of the CxIgnore meta-object attribute (the value configured for its Default Value property) to the NameValue data whenever it encounters a business object attribute with the CxIgnore constant as its attribute value.

- When converting *to* a business object, the NameValue data handler assigns the CxIgnore constant to the business object attribute's value whenever it encounters any of the following conditions in the NameValue data:
 - The value of the CxIgnore meta-object attribute (the value configured for its Default Value property)
 - The value of an empty string
 - No corresponding value

Note: Business objects must have at least one primary key that does *not* contain the value CxIgnore at runtime.

You can configure how the NameValue data handler processes attributes with an attribute value of CxIgnore. For example:

- You can configure whether you want the data handler to process attributes with a CxIgnore value during request processing or ignore them.
- You can decide not to make an entry for attributes with a CxIgnore value so that the connector can process the business object data correctly during event notification. This is helpful when creating a dummy file for an object type.

During request processing, the data handler is creating a serialized version of the business object. At this time, the processing of the special attribute value CxIgnore is based on the child meta-object attribute SkipCxIgnore, as follows:

- When SkipCxIgnore is set to false, the data handler writes the value of this CxIgnore meta-object attribute to the NameValue data whenever it encounters a business object attribute with the CxIgnore constant as the attribute's value.
- If SkipCxIgnore is set to true, the data handler ignores all attributes with a value of CxIgnore and does *not* generate any NameValue data for them.

Note: With SkipCxIgnore set to true, the NameValue data handler is *not* bidirectional; that is, it cannot perform string-to-business-object conversions on strings that it has generated during business-object-to-string conversions.

CxBlank: The CxBlank meta-object attribute establishes the equivalent value in a NameValue data for the Blank attribute value (the CxBlank constant). By default, the CxBlank meta-object attribute is set to the value of the CxBlank constant. The data handler uses the CxBlank meta-object attribute as follows:

- When converting *from* a business object, the NameValue data handler writes the value of the CxBlank meta-object attribute (the value configured for the Default Value property) to the NameValue data whenever it encounters a business object attribute with the CxBlank constant as its attribute value.
- When converting *to* a business object, the NameValue data handler assigns the CxBlank constant to the business object attribute's value whenever it encounters the value of the CxBlank meta-object attribute (the value configured for its Default Value property) in the NameValue data.

Note: Business objects must have at least one primary key that does *not* contain the value CxBlank at runtime.

Business object application-specific information

The NameValue data handler does not require any application-specific information in business objects or their attributes. The data handler does, however, check for the existence of the `cw_mo_tag`, which a business object might use to indicate any child meta-object that the connector uses. The data handler ignores any attribute

identified by the `cw_mo_` tag in the application-specific information of the business object. For more information about the `cw_mo_` tag, see “Implementing conversion from a business object” on page 139.

Using existing business object definitions

The NameValue data handler can convert any business object to NameValue serialized data as long as the business object delivers data in a form that complies with the requirements of the data handler. The NameValue data handler requires each piece of data to have a name that identifies it, such as `BusinessObject=Customer`, `Verb=Create`, and `CustomerName=JDoe`. Because attributes must have such a name, they can be used with the NameValue data handler.

Although existing business objects that meet this requirement can be converted by the NameValue data handler, a good practice is to create your own business objects for each type of data to be processed. If you use a sample business object, or a business object developed to support the same application in another implementation, be sure to modify the definition as necessary to include only the attributes required for the implementation for which you are developing.

Therefore, to convert existing business objects to a form that closely corresponds to your data, modify the business object to provide only the data required by the application and the information required by the data handler. To adapt existing business objects for use with the NameValue data handler, do the following:

1. Perform a functional analysis of the target application, and compare the results to existing business objects to determine the required fields of a business object definition.
2. Use Business Object Designer Express to add or delete attributes from the business object definition as needed.

Converting business objects to NameValue data

To convert a business object to a string or stream, the NameValue data handler loops through the attributes of a business object in sequential order. It generates name-value pairs recursively in the order in which attributes appear in the business object and its children. The name of the business object is passed as an argument to the conversion method.

The NameValue data handler processes business objects into NameValue data as follows:

1. The data handler creates a string to contain the data in the business object.
2. To specify the business object name, the data handler adds `BusinessObject=Name` to the string.
3. To specify the verb, the data handler adds `Verb=Verb` to the string.
4. If the meta-object attribute `ValidateAttrCount` is set to `true`, the data handler adds `AttributeCount=Count` to the string. This name-value pair specifies the number of the attributes in the business object data.
5. The data handler examines the application-specific information in the business object definition to determine if there are any child meta-objects (those whose names are listed in the `cw_mo_` tag of the business object application-specific information). The data handler does *not* include these attributes in the NameValue data. For more information about the `cw_mo_` tag, see “Implementing conversion from a business object” on page 139.

6. The data handler loops through the remaining business object attributes in order, adding name-value pairs for each simple attribute to the string. For container attributes, the data handler does the following:
 - If the attribute is a cardinality 1 container, the data handler adds the attribute name and a count of 1 to the string, and then recursively processes the child business object to add name-value pairs for each attribute to the string.
 - If the attribute is a cardinality n container, the data handler adds the attribute name and the number of child objects in the container to the string, and then recursively processes each child business object, adding name-value pairs for each attribute to the string.
7. When the data handler completes the conversion, it returns the serialized data to the caller. The data handler returns the data in the form (String or InputStream) requested by the caller.

If the child meta-object attribute `ValidateAttrCount` is true, the data handler adds a token that contains a count of the attributes in the business object to the output data. The data handler adds carriage returns to output data; the end result looks like Figure 32 on 125.

Converting NameValue data to business objects

This section provides the following information on how the NameValue data handler converts strings or streams formatted in name-value pairs to a business object:

- “NameValue string requirements”
- “Serialized-data processing” on page 126

NameValue string requirements

The NameValue data handler makes the following assumptions about serialized data:

- The business object name appears in the first name-value pair.
- The verb appears in the second name-value pair.
- The data contains a token that represents the number of instances of child objects for each child that is contained in a business object.
- The `ObjectEventId` attribute is present in each business object.

A token representing the attribute count is optional. If the child meta-object attribute `ValidateAttrCount` is true, the data handler looks for a token that contains a count of the attributes in the business object. If the attribute count is specified, it must accurately reflect the number of attributes in the business object definition.

When the NameValue data handler reads a file in name-value format, it takes the following special processing steps to assign to a business object attribute the `CxIgnore` or `CxBlank` attribute value:

- The data handler assigns the `CxIgnore` constant (`null`) as the corresponding attribute value whenever it encounters any of the following conditions in the NameValue data:
 - The value of the `CxIgnore` meta-object attribute (the value configured for its `Default Value` property)
 - The value of an empty string (“ ”)

- No corresponding value in the NameValue data for the business object attribute.
- The data handler assigns the CxBlank constant as the attribute value only when the CxBlank meta-object attribute is configured and it encounters this configured value in the corresponding NameValue data.

Figure 32 shows an example of serialized data in NameValue format.

```

BusinessObject=Customer
  Verb=Update
    AttributeCount=7
    CustomerID=103
    CustomerName=Thai Inc.
    Cust_Phone_Number=CxIgnore
    ProductName=GoodProduct
    Address=2
      BusinessObject=Address
        Verb=Update
          AttributeCount=3
          AddressID=105
          AddressLine=CxIgnore
          ObjectEventID=12345
      BusinessObject=Address
        Verb=Delete
          AttributeCount=3
          AddressID=106
          AddressLine=2758 Forest Avenue
          ObjectEventID=CxIgnore
    Item=1
      BusinessObject=Item
        Verb=Update
          ItemID=107
          ItemName=CxIgnore
          ObjectEventID=Obj_201
      ObjectEventID=SampleConnector_894927711_2

```

Figure 32. Example of NameValue data

In this example, entries indicate the following:

- BusinessObject is the name of the parent or child business object being processed.
- Verb is the type of request (for example, Create or Update) with which the parent or child business object is being sent.
- AttributeCount is the total number of attributes for the parent or child business object at that level.
- CustomerID, CustomerName, Cust_Phone_Number, and ProductName are the names of the attributes for the parent business object. Values for each parent business object attribute follow the attribute name.
- Address = 2 indicates that there are two instances of the Address child business object. Address is the attribute name that refers to the Address child business object in the parent object.
- Item = 1 indicates that the Item attribute contains a single instance of the Item business object.
- AddressID and AddressLine are the names of the attributes for the Address child business object. Values for each child business object attribute follow the attribute name.
- ObjectEventID=Obj_201 is the system-generated ID for the child business object, Item.

- ObjectEventID=SampleConnector_894927711_2 is the system-generated ID for the parent business object, Customer.

Serialized-data processing

The NameValue data handler converts strings or streams formatted in name-value pairs to a business object as follows:

1. The data handler creates a business object to contain the data in the string or stream.
2. The data handler sets the verb in the business object. The data handler assumes that the verb for the top-level business object is in the second name-value pair in the data. Note that child business objects may not have verbs set.
3. If the ValidateAttrCount child meta-object attribute is set to true, the data handler validates that the number of attributes in the file matches the number of attributes in the business object definition.
4. The data handler parses the serialized data.
 - It first determines if there are any child meta-objects (those whose names are listed in the cw_mo_tag of the business object application-specific information). The data handler does *not* perform the processing to populate these attributes of the business object. For more information about the cw_mo_tag, see “Implementing conversion from a business object” on page 139.
 - It populates the values of the remaining simple attributes in the business object. The data handler processes container attributes as follows:
 - If the attribute is single cardinality, the data handler recursively parses the attributes in the attribute list and adds the child business object container to the parent business object.
 - If the attribute is multiple cardinality, the data handler recursively parses the attributes in each child attribute list, and adds the child business object container to the parent business object.

You can specify the attributes in the serialized data in any order for the string-to-business object conversion because the data handler does a name and value association.

Part 2. Custom data handlers

Chapter 8. Creating a custom data handler

This chapter presents information on how to implement a custom data handler to use with a WebSphere business integration adapter or an access client. As with IBM-delivered data handlers, a custom data handler converts a business object to a specific serialized data format, and converts serialized data in a specific format to a business object. This chapter contains the following sections:

- “Overview of the data-handler development process”
- “Tools for data-handler development” on page 131
- “Designing the data handler” on page 132
- “Extending the data handler base class” on page 133
- “Implementing the methods” on page 134
- “Building a custom name handler” on page 147
- “Adding a data handler to the jar file” on page 148
- “Creating data-handler meta-objects” on page 149
- “Setting up other business objects” on page 151
- “Configuring a connector” on page 151
- “An internationalized data handler” on page 152

Overview of the data-handler development process

To develop a custom data handler, you code the data handler source file and complete other tasks, such as developing a meta-object for the data handler. The task of creating a custom data handler includes the following general steps:

1. Design the data handler, based on the format of the serialized data and structure of the business objects it converts.
2. Create a class that extends the class:
`com.crossworlds.DataHandlers.DataHandler`
3. Implement the abstract methods that convert data between specific data format and business objects.
4. Compile the class and add it to the `CustDataHandler.jar` file.
5. Create the data-handler meta-objects.
6. Develop business object definitions that conform to the requirements of the data handler as well as to the requirements of the caller.

Figure 33 provides a visual overview of the data-handler development process and provides a quick reference to chapters where you can find information on specific topics. Note that if a team of people is available for data-handler development, the major tasks of developing a data handler can be done in parallel by different members of the development team.

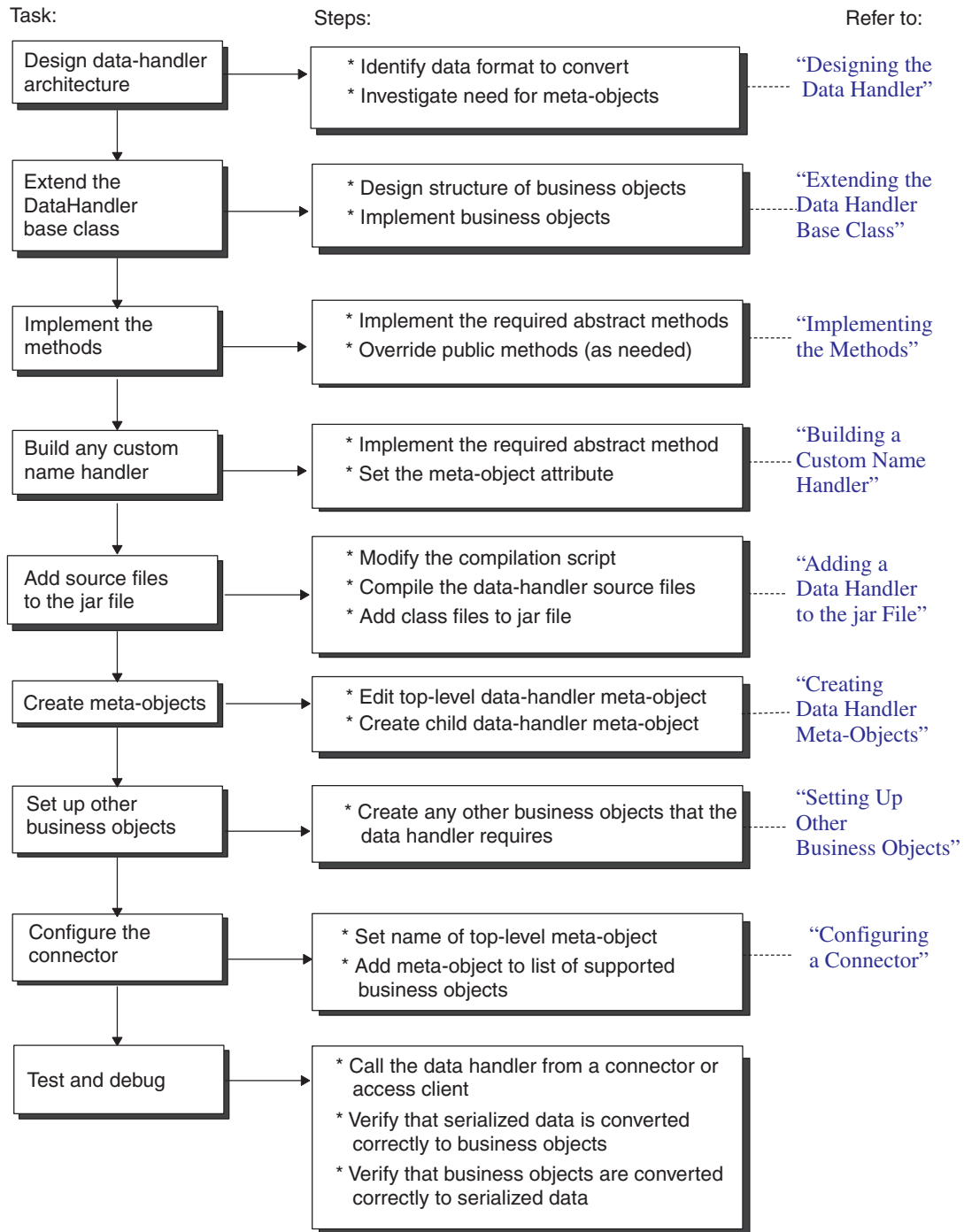

Figure 33. Overview of the data-handler development process

Tools for data-handler development

Because data handlers are written in Java, data handlers can be developed on either a Windows or UNIX system. Table 45 lists the tools that IBM provides for data handler development.

Table 45. Tools for data-handler development

Development Tool	Description
Adapter Development Kit (ADK)	Includes the following: <ul style="list-style-type: none">• Sample data handlers• Stub file for extending <code>DataHandler</code> class
Data Handler API	Single class, <code>DataHandler</code> , which you extend to create a custom data handler.
Java Connector Development Kit (JCDK)	Contains Java classes to work with business objects.

The Adapter Development Kit

The Adapter Development Kit (ADK) provides files and samples to assist in the development of an adapter. It provides samples for many of the adapter components, including an Object Discovery Agent (ODA), a connector, and a data handler. The ADK provides these samples in the `DevelopmentKits` subdirectory of the product directory.

Note: The ADK is part of the WebSphere Business Integration Adapters product and requires its own separate Installer. Therefore, to have access to the development samples in the ADK, you must the WebSphere Business Integration Adapters product and install the ADK. Please note that the ADK is available only for Windows systems. Table 46 lists the samples that the ADK provides for the development of a data handler as well as the subdirectory of the `DevelopmentKits` directory in which they reside.

Table 46. ADK samples for data handler development

Adapter Development Kit component	DevelopmentKits subdirectory
Data handler samples	<code>edk\DataHandler</code>

Sample data handlers

To assist with the development of a data handler, ADK includes code for several sample data handlers in the following product directory:

`DevelopmentKits\edk\DataHandler\Samples`

Table 47 lists the sample data handlers that the ADK provides.

Table 47. Sample data handlers included with the EDK

Name	Description
<code>delimited.java</code>	Converts business objects to Delimited strings and Delimited strings to business objects.
<code>fixedwidth.java</code>	Converts business objects to FixedWidth strings and from FixedWidth strings to business objects.
<code>namevalue.java</code>	Converts business objects to NameValue strings and NameValue strings to business objects.

Note: While these samples are useful to examine, they do *not* provide examples of all the functionality supported in the `DataHandler` class.

Development files

The `DevelopmentKits\edk\DataHandler` directory provides several files that assist in the development of a custom data handler, including those listed in Table 48.

Table 48. Data-handler development files

Data-Handler development file	For more information
<code>StubDataHandler.java</code>	"Extending the data handler base class" on page 133
<code>makeDataHandler.bat</code> (Windows systems)	"Adding a data handler to the jar file" on page 148

Data Handler API

The Data Handler API provides a single Java class, called `DataHandler`. The abstract `DataHandler` base class facilitates the development of a custom data handler. This class contains the methods that populate a business object with values extracted from input data, and methods that serialize a business object into a string or a stream. The class also includes utility methods that a custom data handler can use. You derive a custom data handler from the `DataHandler` class.

For information on the methods in the `DataHandler` class, see Chapter 9, "Data Handler base class methods," on page 157.

Java Connector Development Kit

To work with business objects, a data handler must use methods from the classes in the Java Connector Development Kit (JCDK). As you develop your data handler, you may need to import additional JCDK classes, such as `CxCommon.CXObjectContainerInterface` or `CxCommon.CXObjectAttr`. For reference information on the JCDK methods, see the *Connector Development Guide for Java* in the WebSphere Business Integration Adapters documentation set.

Note: The JCDK is the low-level Java connector library. Documentation of its methods are contained in a separate part of the *Connector Development Guide for Java*.

Designing the data handler

Before you begin to write a custom data handler, it is recommended that you clearly understand:

- The data format of the files that the data handler will be converting
- The business object model

In particular, you need to know how to:

- extract values from a business object instance
- build a business object instance and populate it with values from a file

Creating a metadata-driven data handler

For your custom data handler to be metadata-driven, it must dynamically specify information that identifies the data handler to use. For more information on metadata-driven data handlers, see "Metadata-driven data handler design" on page 19.

Using data-handler meta-objects

One of the design decisions you need to make is whether your data handler will use meta-objects to initialize its configuration.

Note: For more information about meta-objects, see “Configuring data handlers” on page 21.

Consider the following when deciding whether to use meta-objects:

- Meta-objects allow a data handler to be dynamically configured. This design strategy creates a more flexible data handler, one that can be configured based on the context in which it is called.

To call a data handler that uses meta-objects, the caller passes the data handler’s associated MIME type into the `createHandler()` method. When called with a MIME type, `createHandler()` initializes a newly instantiated data handler with the configuration information in the child meta-object.

- There is overhead associated with the accessing and searching of meta-objects. Your data handler might want to avoid meta-objects if its configuration information does not change (it can be hard-coded) or if it converts data that does not have an associated MIME type.

To call a data handler that does *not* use meta-objects, the caller passes *only* the data handler’s class name into the `createHandler()` method. When called with a class name, `createHandler()` instantiates a data handler of that class; it does not search for associated meta-objects.

If you design your custom data handler to use meta-objects, you need to create these meta-objects as part of your data-handler implementation. For more information, see “Creating data-handler meta-objects” on page 149.

Extending the data handler base class

To create a custom data handler, you extend the data-handler base class (`DataHandler`) to create your own *data-handler class*. The `DataHandler` class contains methods that perform the conversions (string-to-business-object and business-object-to-string), as well as utility methods to assist in development. The EDK contains stub code and makefiles for a custom data handler. The stub file contains Java code that defines an empty class listing all the methods that you must implement. You can use the stub file as a template to generate a custom data handler.

To create a data handler source file using the stub file:

1. Copy the `StubDataHandler.java` file and rename it so that its name matches the name of the data-handler class that it defines.

The stub file resides in the `DevelopmentKits\edk\DataHandler` subdirectory in the product directory. It includes `import` statements that import the data handler package `com.crossworlds.DataHandlers`. It also imports some classes from the Java Connector Development Kit.

2. Change the `StubDataHandler` keyword to the name of the class that implements your custom data handler.

For example, the following line extends the `DataHandler` class to create a custom data-handler class called `HtmlDataHandler`:

```
public class HtmlDataHandler extends DataHandler
```

Implementing the methods

To develop a data handler, you implement the following methods of the `DataHandler` class:

- The abstract `DataHandler` methods (required)
- The public `DataHandler` methods (optional)

The methods of your custom data handler go in the Java source file of the `DataHandler` class that you created in “Extending the data handler base class” on page 133.

Note: If the caller re-uses a cached instance of the `DataHandler` class over multiple threads, you might need to make the class thread-safe. To determine whether this is required, see the *Connector Development Guide for Java* for more details on the threading model.

Implementing the abstract methods

The data-handler base class, `DataHandler`, provides the abstract methods in Table 49, which you *must* implement in the `DataHandler` class for your custom data handler.

Table 49. Abstract methods in the `DataHandler` class

Data conversion	Format of serialized data	<code>DataHandler</code> method
String-to-business-object conversion	Converts serialized data, accessed through a <code>Reader</code> object, to a business object	<code>getBO()</code> - abstract
Business-object-to-string conversion	Converts a business object to an <code>InputStream</code> object	<code>getStreamFromBO()</code>
	Converts a business object to a <code>String</code> object	<code>getStringFromBO()</code>
	Converts a business object to a byte array.	<code>getByteArrayFromBO()</code>

Note: The copy of the `StubDataHandler.java` file that extends the `DataHandler` class with your custom data handler contains declarations for the abstract methods you need to implement.

The following sections provide implementation information for each of the abstract `DataHandler` methods.

Implementing conversion to a business object

The abstract `getBO()` method performs the string-to-business-object conversion; that is, it populates a business object with data extracted from a Java `Reader` object. There are two versions of the `getBO()` method:

- `getBO(Reader serializedData, BusinessObjectInterface theObj, Object config)`

Input arguments include a `Reader` object that contains the serialized data and a reference to the business object. The method populates the `theBusObj` business object with the `serializedData` data.

- `getBO(Reader serializedData, Object config)`

Input arguments include a Reader object that contains the serialized data. The method determines the name of the business object type (the business object definition) from the data, then creates and fills a business object instance of that type.

Note: To support the data handler when it is called in the context of a connector, your data-handler class (which extends `DataHandler`) must implement *both* versions of the `getBO()` method. To support the data handler when it is called *only* from an access client (IBM WebSphere InterChange Server integration broker only), you must implement only the second form of the `getBO()` method; the Server Access Interface uses only this second form of `getBO()`.

The `getBO()` method allows the caller to pass in an optional object containing configuration information (the `config` parameter). This information is in addition to the configuration information specified in the data-handler meta-object. As an example, the configuration object can point to a template file or to a URL that the data handler uses.

Note: When converting to a business object, `getBO()` must ensure that any attribute identified with a `cw_mo_label` tag in the application-specific information of the parent business object does *not* get a value. For more information on the `cw_mo_label` tag, see “Implementing conversion from a business object” on page 139.

The purpose of the abstract `getBO()` method is to populate a business object with the serialized data that the Reader object contains. The public versions of `getBO()` can then receive the serialized data in one of several supported forms, convert the data to a Reader object, and then call the abstract `getBO()` method to perform the actual string-to-business-object conversion. For more information on the public `getBO()` method, see “`getBO()` - public” on page 160.

Figure 34 shows a basic implementation of the second form of the `getBO()` method. The example illustrates the steps in the conversion of data from a Reader object that contains fixed-width data to a business object:

1. The `getBO()` method converts the data in the Reader object to a String object. It then calls the user-defined `getBOFromString()` method to create an instance of the business object.
2. The `getBOFromString()` method determines what type of business object to create based on the first fixed-width token in the String, and then it creates a business object instance of that type. It gets the verb from the second fixed-width token in the String and sets the verb in the business object. This method then calls the user-defined `parseAttributeList()` method to parse the remainder of the String and populate the business object with values.
3. The `parseAttributeList()` method parses the String and recursively populates the business object. When the method finds an attribute of an object type, it determines whether the object is single or multiple cardinality. It calls `getMultipleCard()` to recursively process the business objects in the array and `getSingleCard()` to process a single-cardinality child business object.

Tip: A data handler extracts data from business objects and populates business objects with data in the same way that a connector does. For example, in the following code sample, the `getBOFromString()` method calls `JavaConnectorUtil.createBusinessObject()` to create a business object instance and `BusinessObjectInterface.setVerb()` to set the verb. For

information on how to process business objects, see the *Connector Development Guide for Java*.

```
public BusinessObjectInterface getBO(Reader serializedData,
    Object config)
    throws Exception
{
    clear(config);
    BusinessObjectInterface resultObj = null;

    // Create a String object from the Reader, then use the string
    // method
    int conversionCheck;
    char[] temp = new char[2000];
    StringBuffer tempStringBuffer = new StringBuffer(1000);

    while ( (conversionCheck = serializedData.read(temp)) != -1 )
        tempStringBuffer.append(new String (temp, 0, conversionCheck));

    mBOString = new String(tempStringBuffer);
    mBOStringLength = mBOString.length();

    resultObj = getBOFromString(null);
    return resultObj;
}

// Gets business object name and verb and creates a bus obj instance
private BusinessObjectInterface getBOFromString(String pvBObjectType)
    throws Exception
{
    BusinessObjectInterface returnObj = null;
    String lvBOName = null;
    String lvVerb = null;

    lvBOName = this.getNextToken(mBONameSize, true);
    lvVerb = this.getNextToken(mBOVerbSize, true);

    if( (pvBObjectType != null) && (lvBOName.compareTo(pvBObjectType) != 0) ) {
        throw new Exception(...);
    }
    else
    {
        returnObj = JavaConnectorUtil.createBusinessObject(lvBOName);
    }

    returnObj.setVerb(lvVerb);

    parseAttributeList(returnObj);

    return returnObj;
}
```

Figure 34. Example *getBO()* method (Part 1 of 4)

```

// Parse String to populate the attributes in the business object
protected void parseAttributeList(BusinessObjectInterface pvBO)
    throws Exception
{
    if ( mEndOfBOString )
        throw new Exception(...);
    else if( pvBO == null )
        throw new Exception(...);

    int lvAttrNum = pvBO.getAttrCount();

    String lvAttrName = null;
    String lvAttrValue = null;
    int lvAttrMaxLength = 0;

    try {
        for (int lvAttrIndex = 0; lvAttrIndex < lvAttrNum;
            lvAttrIndex++)
        {
            CxObjectAttr lvAttrSpec = pvBO.getAttrDesc(lvAttrIndex);
            lvAttrName = lvAttrSpec.getName();

            // Determine if the attribute is a simple attribute or a
            // business object container.
            if (lvAttrSpec.isObjectType())
            {
                // Get the next token based on the BOCOUNTSIZE
                lvAttrMaxLength = mBOCOUNTSIZE;
                lvAttrValue = this.getNextToken(mBOCOUNTSIZE, true);
                String lvBOType = lvAttrSpec.getTypeName();
                Object lvAttrBOValue = null;

                if (lvAttrSpec.isMultipleCard())
                {
                    this.getMultipleCard(pvBO,lvAttrIndex,lvBOType,
                        lvAttrValue);
                }
                else {
                    this.getSingleCard(pvBO,lvAttrIndex,lvBOType,
                        lvAttrValue);
                }
            }
            else
            {
                // Get the next token based on the MaxLength of the attribute
                lvAttrMaxLength = lvAttrSpec.getMaxLength();
                if (lvAttrMaxLength > 0)
                    lvAttrValue = this.getNextToken(lvAttrMaxLength, false);
                else
                    lvAttrValue = null;
            }
        }
    }
}

```

Figure 34. Example *getBO()* method (Part 2 of 4)

```

        // For simple String attribute, set to null, set to
        // configured CxIgnore or CxBlank values, or set to the
        // attribute value
        if (lvAttrValue == null )
            pvBO.setAttrValue(lvAttrIndex, null);
        else if (lvAttrValue.equals(mCxIgnore)||
            lvAttrValue.equals(""))
            pvBO.setAttrValue(lvAttrIndex, null);
        else if (lvAttrValue.equals(mCxBlank)||
            lvAttrValue.equals(" "))
            pvBO.setAttrValue(lvAttrIndex, "");
        else
            pvBO.setAttrValue(lvAttrIndex, lvAttrValue);
    }
}

// Populates a child container with values in the String
protected void getMultipleCard(BusinessObjectInterface pvParentBO,
    int pvParentAttrIndex, String pvBObjectType, String pvObjectCountString)
    throws CW_BOFormatException, Exception
{
    try {
        if ( pvObjectCountString.equals(mCxIgnore) )
        {
            // trace message
        }
        else {
            int lvObjectCount = Integer.parseInt(pvObjectCountString);
            if ( lvObjectCount == 0)
            {
                // trace message with the number of objects in container
            }
            else if (lvObjectCount > 0)
            {
                // There is at least one instance of the object in the string
                BusinessObjectInterface lvChildBO = null;

                // For each instance of the child object, parse the attribute
                // list, and then add the object container to the parent.
                for (int lvObjectIndex = 0; lvObjectIndex < lvObjectCount;
                    lvObjectIndex++)
                {
                    lvChildBO = getBOFromString(pvBObjectType);
                    pvParentBO.setAttrValue(pvParentAttrIndex,lvChildBO);
                }
            }
        }
    }
}

```

Figure 34. Example getBO() method (Part 3 of 4)

```

// Populates a single cardinality child with values in the String
protected void getSingleCard(BusinessObjectInterface pvParentBO,
    int pvParentAttrIndex, String pvBOType, String pvObjectCountString)
    throws CW_BOFormatException, Exception
{
    try {
        BusinessObjectInterface lvChildBO = null;

        // Check the object count token
        // If it does not match "1", assume that the child object should
        // be null
        if (pvObjectCountString.equals("1"))
        {
            // The string contains a single instance of the child
            lvChildBO = getBOFromString(pvBOType);
            pvParentBO.setAttrValue(pvParentAttrIndex, lvChildBO);
        }
        else if ( pvObjectCountString.equals(mCxIgnore) ||
            pvObjectCountString.equals("0"))
        {
            // Validate that the object count token is valid
        }
        else
            throw new CW_BOFormatException(...);
    }
}

```

Figure 34. Example `getBO()` method (Part 4 of 4)

Implementing conversion from a business object

The abstract methods in Table 50 perform the business-object-to-string conversion; that is, they each create serialized data in a particular format from a business object.

Table 50. Abstract methods to implement business-object-to-string conversion

Abstract method	Description
<code>getStringFromBO()</code>	Converts the data in a business object to a String object.
<code>getStreamFromBO()</code>	Converts the data in a business object to an InputStream object.
<code>getByteArrayFromBO()</code>	Converts the data in a business object to a byte array.

The goal of converting from a business object is to create a serialized form of all data in the business object. Sometimes, however, some business-object data should *not* be included in the serialized data. For example, a business object might use a child meta-object to hold dynamic configuration information for a connector.

IBM reserves all application-specific information that begins with the prefix `cw_mo_label` for configuration and/or dynamic metadata. To indicate any attribute that a data handler should *ignore* during conversion from a business object, the business object definition for the parent business object specifies the following tag in its application-specific information:

```

cw_mo_label=child_meta-object_attribute_name

```

where *label* is a string you define to further identify the purpose of the *cw_mo_* tag and *child_meta-object_attribute_name* identifies the name of the attribute to ignore. This attribute usually contains the child meta-object. Multiple *cw_mo_label* tags are delimited by a semicolon (;).

When you implement the `getStringFromBO()`, `getStreamFromBO()`, and `getByteArrayFromBO()` methods for a custom data handler, these methods need to ensure that the data handler skips over connector-specific attributes, as follows:

1. Check for the existence of any *cw_mo_label* tag (where *label* is a string you provide to identify the attribute to ignore) in the application-specific information of the business object definition for the business object being converted.
2. If a *cw_mo_label* tag exists, locate the string that this tag provides (*child_meta-object_attribute_name*). Ignore any white space surrounding the equal sign (=).
3. While looping through the attributes of the business object, compare each attribute name against the *child_meta-object_attribute_name* string. Skip over any attribute with this name.

The following code fragment shows how to skip over attributes:

```
List configObjList =
    com.crossworlds.DataHandlers.text.namevalue.listMOAttrNames(BusObj);

//this list contains attribute names, which are configuration objects
for ( attributes in BusObj )
{
    String attrName = BusObj.getAttrDisc(i).getName();
    if ( configObjList.contains(attrName) )
    {
        //skip
        continue;
    }
}
```

For example, suppose a business object called `MyCustomer` uses a child meta-object to hold connector-specific routing information. If this meta-object is represented by an attribute named `CustConfig`, then `MyCustomer` could have the following tag in its application-specific information:

```
cw_mo_cfg=CustConfig
```

During conversion from a business object, a custom data handler checks the application-specific information for the business object definition associated with `MyCustomer`, locates the `cw_mo_cfg` tag, and determines that the `CustConfig` attribute needs to be skipped over. The resulting serialized data from the data handler does *not* include the `CustConfig` child meta-object.

Note: When converting from a business object, IBM-delivered data handlers skip over *any* attributes that the *cw_mo_label* tag identifies.

You need to develop any custom data handler to handle *cw_mo_label* tags *only* if the data handler works with connectors that use child meta-objects or other dynamic objects.

An implementation of the `getStringFromBO()` method: The `getStringFromBO()` method performs the business-object-to-string conversion; that is, it converts the data in a business object to a `String` object. For this method, the caller passes in

the business object to be converted. Figure 35 shows the `getStringFromBO()` method as implemented by the `FixedWidth` data handler. The method creates a `String` of fixed-width fields.

The example illustrates the steps in the conversion of data from a business object to a `Reader` object:

1. The `getStringFromBO()` method calls `setAttrList()` to recursively loop through the attributes in the business object. When the `setAttrList()` method finds a simple attribute, it calls the `setSimpleToken()` method to set the value.
2. The `setSimpleToken()` method adds the attribute value to a `StringBuffer` object, converts the `StringBuffer` to a `String` object, and adds the string to the `StringBuffer` representing the entire business object. When `setAttrList()` has processed the business object, the `getStringFromBO()` method converts the `StringBuffer` to a `String` object and returns the `String` to the caller.

```

public String getStringFromBO(BusinessObjectInterface theObj,
    Object config)
    throws Exception
{
    traceWrite(
        "Entering getStringFromBO(BusinessObjectInterface, Object) "
        + " for object type " + theObj.getName(),
        JavaConnectorUtil.LEVEL4);

    clear(config);
    String lvBOString = null;
    setAttrList(theObj);
    lvBOString = mBOStringBuffer.toString();

    traceWrite(
        "Exiting getStringFromBO(BusinessObjectInterface, Object) "
        + " for object type " + theObj.getName(),
        JavaConnectorUtil.LEVEL4);

    return lvBOString;
}

protected void setAttrList(BusinessObjectInterface pvBO) throws Exception
{
    traceWrite(
        "Entering setAttrList(BusinessObjectInterface) for object "
        + pvBO.getName(), JavaConnectorUtil.LEVEL4);

    int lvAttrNum = pvBO.getAttrCount();

    String lvAttrName = null;
    String lvAttrValue = null;
    int lvAttrMaxLength = 0;

    // Add the business object name and verb to the fixed width format
    // String
    this.setSimpleToken( mBONameSize, pvBO.getName());
    this.setSimpleToken( mBOVerbSize, pvBO.getVerb());

    try {
        List moAttrNames = listMOAttrNames( pvBO );
        int lvAttrCount = pvBO.getAttrCount();

        ATTRIBUTE_WALK: for (int lvAttrIndex = 0;
            lvAttrIndex < lvAttrCount; ++lvAttrIndex)
        {
            CxObjectAttr lvAttrSpec = pvBO.getAttrDesc(lvAttrIndex);
            lvAttrName = lvAttrSpec.getName();

            // Check if the current attribute is a simple (String) type
            // or a contained object.
            if (lvAttrSpec.isObjectType())
            {
                //skip child objects designated as meta objects
                if( moAttrNames.contains( lvAttrName ) )
                {
                    continue ATTRIBUTE_WALK;
                }
            }
        }
    }
}

```

Figure 35. Example `getStringFromBO()` method (Part 1 of 5)

```

if (lvAttrSpec.isMultipleCard())
{
    CxObjectContainerInterface lvAttrMultiCardBOValue =
    (CxObjectContainerInterface) pvBO.getAttrValue(lvAttrIndex);

    if (lvAttrMultiCardBOValue == null)
    {
        traceWrite(
            "setAttrList found empty multiple cardinality container "
            + lvAttrSpec.getTypeName(), JavaConnectorUtil.LEVEL5);

        // Add the count to the fixed width String
        this.setSimpleToken( mBOCountSize, "0");
    }
    else
    {
        int lvObjectCount =
            lvAttrMultiCardBOValue.getObjectCount();
        traceWrite(
            "setAttrList found multiple cardinality container "
            + lvAttrSpec.getTypeName() + " with "
            + lvObjectCount + " instances",
            JavaConnectorUtil.LEVEL5);

        // Add the count to the fixed width String
        this.setSimpleToken( mBOCountSize,
            Integer.toString(lvObjectCount));

        // Add each object in the container to the fixed
        // width String.
        for (int lvContObjectIndex = 0;
            lvContObjectIndex < lvObjectCount;
            ++lvContObjectIndex)
            setAttrList(
                lvAttrMultiCardBOValue.getBusinessObject(
                    lvContObjectIndex));
    }
}
else
{
    BusinessObjectInterface lvAttrSingleCardBOValue =
    (BusinessObjectInterface) pvBO.getAttrValue(lvAttrIndex);

    if (lvAttrSingleCardBOValue == null)
    {
        traceWrite(
            "setAttrList found empty single cardinality container "
            + lvAttrSpec.getTypeName(), JavaConnectorUtil.LEVEL5);

        // Add the count to the fixed width String
        this.setSimpleToken( mBOCountSize, "0");
    }
}

```

Figure 35. Example `getStringFromBO()` method (Part 2 of 5)

```

        else
        {
            traceWrite(
                "setAttrList found single cardinality container "
                + lvAttrSpec.getTypeName(),
                JavaConnectorUtil.LEVEL5);

            // Add the count to the fixed width String
            this.setSimpleToken( mBOCountSize, "1");
            setAttrList(lvAttrSingleCardBOValue);
        }
    }
}
else
{
    lvAttrValue = (String) pvBO.getAttrValue(lvAttrIndex);
    lvAttrMaxLength = lvAttrSpec.getMaxLength();

    if (lvAttrMaxLength > 0)
        this.setSimpleToken(lvAttrMaxLength, lvAttrValue);
}
}
}
catch (CxObjectNoSuchAttributeException e)
{
    throw new Exception(e.getMessage());
}

traceWrite(
    "Exiting setAttrList(BusinessObjectInterface) for object "
    + pvBO.getName(), JavaConnectorUtil.LEVEL4);
}

protected void setSimpleToken( int pvCellSize, String pvTokenValue)
    throws Exception
{
    traceWrite( "Entering setSimpleToken(int, String)",
        JavaConnectorUtil.LEVEL4);

    StringBuffer lvNewBuffer = new StringBuffer(pvCellSize);
    int lvTokenLength = 0;
    int lvCxIgnoreLength = mCxIgnore.length();
    int lvCxBlankLength = mCxBlank.length();

    int lvPadNumber = 0;

    // Check the token value to see if it is null
    if (pvTokenValue == null)
    {
        // For this case, we add the configured CxIgnore value to the
        // fixed width String if it fits in the cell.
        if (!mTruncation && lvCxIgnoreLength > pvCellSize)
            throw new Exception(
                " Null attribute value encountered where cell size is "
                + pvCellSize + ", size of CxIgnore value is "
                + lvCxIgnoreLength + "and truncation is not allowed. "
                + "Please check your MO format configuration.");
    }
}

```

Figure 35. Example `getStringFromBO()` method (Part 3 of 5)

```

else
{
    lvPadNumber = pvCellSize - lvCxIgnoreLength;
    lvNewBuffer.append(mCxIgnore);
}
}
else if (pvTokenValue.equals(""))
{
    // For this case, the configured CxBlank value is added to the
    // fixed width String if it fits in the cell.
    if (!mTruncation && lvCxBlankLength > pvCellSize)
        throw new Exception(
            " Blank attribute value encountered where cell size is "
            + pvCellSize + ", size of CxBlank value is "
            + lvCxBlankLength + "and truncation is not allowed. "
            + "Please check your MO format configuration.");
    else
    {
        lvPadNumber = pvCellSize - lvCxBlankLength;
        lvNewBuffer.append(mCxBlank);
    }
}
else
{
    // For this case, actually add the token value to the fixed
    // width String, unless the data is too long for the cell.
    lvTokenLength = pvTokenValue.length();
    if (!mTruncation && lvTokenLength > pvCellSize)
        throw new Exception(
            " Attribute value encountered where cell size is "
            + pvCellSize + ", size of token value is "
            + lvTokenLength + "and truncation is not allowed. "
            + "Please check your MO format configuration.");
    else
    {
        lvNewBuffer.append(pvTokenValue);
        lvPadNumber = pvCellSize - lvTokenLength;
    }
}

if (lvPadNumber <= 0 && mTruncation)
    // Token is longer than the cell and truncation is allowed,
    // so the characters up to pvCellSize are added
    lvNewBuffer.setLength(pvCellSize);
else if (lvPadNumber > 0)
{
    // Pad the cell based on the configuration option chosen
    if ( mAlignment.equals(fixedwidth.AlignmentLeft) ||
        mAlignment.equals(fixedwidth.AlignmentBoth))
        this.padRight(lvNewBuffer, lvPadNumber);
    else if (mAlignment.equals(fixedwidth.AlignmentRight))
        this.padLeft(lvNewBuffer, lvPadNumber);
}
}

```

Figure 35. Example `getStringFromBO()` method (Part 4 of 5)

```

String lvNewBuffString = lvNewBuffer.toString();

// Note that this may cause a performance issue when the tracing
// level is low, but in most cases it should not as any one token
// is *usually* not very long.
traceWrite(
    "Adding the following token to the fixed width String: "
    + lvNewBuffString, JavaConnectorUtil.LEVEL5);

// After the cell has been fully formatted, append to fixed width
// String being built
mBOStringBuffer.append(lvNewBuffString);

traceWrite( "Exiting setSimpleToken(int, String)",
    JavaConnectorUtil.LEVEL4);
}

```

Figure 35. Example `getStringFromBO()` method (Part 5 of 5)

An implementation of the `getStreamFromBO()` method: The `getStreamFromBO()` method converts the data in a business object to an `InputStream` object. Figure 36 shows an example implementation of the `getStreamFromBO()` method. In this implementation, `getStreamFromBO()` calls `getStringFromBO()` to build a `String` object containing the business object data, and then it converts the `String` to an `InputStream`. The method returns an `InputStream` object representing the data in the business object.

```

public InputStream getStreamFromBO(BusinessObjectInterface theObj,
    Object config)
    throws Exception
{
    clear(config);

    String B0string;
    B0string = getStringFromBO(theObj, config);

    return new ByteArrayInputStream( B0string.getBytes() );
}

```

Figure 36. Example `getStreamFromBO()` method

Overriding public methods

In addition to the abstract `DataHandler` methods (which you *must* implement), you might also need to override some public methods of the `DataHandler` class (see Table 51) so they work optimally with your custom data handler.

Table 51. Public methods of the `DataHandler` class

Public <code>DataHandler</code> method	Description
<code>getBO()</code> - public	Converts serialized data(in one of several formats) to a business object.
<code>getBOName()</code>	Obtains the name of the business object from the serialized data.
<code>getBooleanOption()</code>	Gets a value of a Boolean configuration option from the data handler.
<code>getOption()</code>	Gets the value of a configuration option from the data handler.
<code>setOption()</code>	Sets a configuration option in the data handler.

Table 51. Public methods of the `DataHandler` class (continued)

Public <code>DataHandler</code> method	Description
<code>traceWrite()</code>	Calls a trace-write method for the appropriate context of the data handler: connector or the Server Access Interface.

Building a custom name handler

A data handler can call a *name handler* to extract the name of a business object definition from the serialized data. This task is needed during string-to-business-object conversion when the caller of the data handler does *not* pass in a business object to be populated with the serialized data. In this case, the data handler must create the business object before it can populate it. To create the business object, the data handler must know the name of the associated business object definition. It is the name handler that obtains this business object name.

Note: Currently, the XML data handler uses name handlers to obtain the name of the business object to create.

The task of creating and implementing a custom name handler includes the following general steps:

1. Create a class that extends the `NameHandler` class.
2. Implement the abstract `getBOName()` method that reads the serialized data and returns the business object name.
3. Compile the class and add it to the `DataHandlers\CustDataHandler.jar` file. For more information, see “Adding a data handler to the jar file” on page 148.
4. Set the default value of the `NameHandlerClass` attribute in the meta-object for the data handler.

Extending the `NameHandler` class

To create a custom name handler, you extend the name-handler base class (`NameHandler`) to create your own *name-handler class*. The `NameHandler` class contains the method to extract the name of a business object from serialized data. The package for this name-handler base class is `com.crossworlds.DataHandlers.NameHandler`.

To derive a name-handler class, follow these steps:

1. Create a name-handler class that extends the `NameHandler` class.
2. Ensure that the name-handler class file imports the classes of the `NameHandler` package:

```
import
```
3. Implement the `getBOName()` method, which is the abstract method in the `NameHandler` class. For more information, see “Implementing the `getBOName()` method” on page 148.

The definition of the `NameHandler` class follows:

```
// Imports
import java.lang.String;
import java.io.Reader;
import com.crossworlds.DataHandlers.Exceptions.MalformedDataException;

public abstract class NameHandler {
```

```

// Constructors
public NameHandler() { }

// Methods
public abstract String getBOName(Reader serializedData,
String boPrefix)
throws MalformedDataException;
}

/* This method was introduced so that the NameHandler would have
 * a reference to the DataHandler. The DataHandler base calls this
 * method after it instantiated the NameHandler:
 * eg. nh = (NameHandler)Class.forName(className).newInstance();
 *     nh.setDataHandler(this);
 */
public final void setDataHandler( DataHandler dataHandler )
{
dh = dataHandler;
}

```

To create your own name handler, extend the NameHandler abstract base class.

Implementing the getBOName() method

Extending the NameHandler class requires implementing the getBOName() method, which reads serialized data and returns the name of the business object associated with the data. The syntax for this method is:

```

public abstract String getBOName(Reader serializedData, String BOPrefix)
throws MalformedDataException

```

where:

serializedData

Is a reference to an object that contains the message.

BOPrefix

Is a String value that contains the business object prefix for the names of the business object definitions; this argument can be set to the BOPrefix attribute in the meta-object (if one exists).

Setting the meta-object attribute

To tell the data handler to use a custom name handler, you must set the Default Value property of a meta-object attribute to the full class name. The data handler can then obtain the class name at runtime from one of its configuration options. By default, this meta-object attribute is called NameHandlerClass. The child meta-object associated with the XML data handler include this attribute. The IBM-delivered default value for this attribute specifies the name of the default name handler class. To have a data handler use a custom name handler, make sure that you update the Default Value property for the NameHandlerClass attribute in the child meta-object associated with the data handler you extend.

Adding a data handler to the jar file

When you have completed the code for the new data handler, you must compile the class and add it to a Java archive (jar) file. The file CustDataHandler.jar is provided to contain custom data handlers. This jar file is located in the DataHandlers subdirectory of the product directory. To locate a data-handler class, the createHandler() method searches this jar file after it searches the CwDataHandler.jar file that contains delivered data handlers.

Note: To be able to compile Java code, you must have the Java Development Kit (JDK) installed on your machine. For the required version of the JDK and how to install it, refer to your product installation information.

To add a custom data handler to CustDataHandler.jar:

1. Edit the data-handler compilation script to add the names of the Java source files.

This data-handler compilation script resides in the following subdirectory of the product directory:

DevelopmentKits\edk\DataHandler

Windows

On a Windows system, the data-handler compilation script is called `make_datahandler.bat`. Add the names of the Java source files to the line:

```
set SOURCE_FILES_DH=
```

UNIX

On a UNIX system, the data-handler compilation script is called `make_datahandler`. Add the names of the Java source files to the line:

```
SOURCE_FILES_DH=
```

2. Run the data handler compilation script to compile the Java files into a `.class` file.
3. Add the new class to the `CustDataHandler.jar` file using the following command:

```
jar -vf CustDataHandler.jar input_files
```

where *input_files* is a list of the class files to add.

Creating data-handler meta-objects

If you write a custom data handler that uses data-handler meta-objects, you must:

- Create a child data-handler meta-object that contains attributes for the configuration information of the custom data handler.
- Modify the top-level data-handler meta-object to include the supported MIME type so that your data handler can be configured when it is instantiated.
- Set up the meta-objects in the business integration system.

Note: For information on how to determine whether to use meta-objects in the data-handler design, see “Using data-handler meta-objects” on page 133.

Creating the child meta-object

The child meta-object contains the configuration information for the data handler. The `createHandler()` method uses this information to initialize the newly instantiated data handler. For more detailed information on this process, see “Using a MIME type” on page 13.

To create a child meta-object for a custom data handler:

1. Create a child meta-object to represent an instance of the data handler.

You can use the Business Object Designer Express tool to create this child meta-object. The meta-object must contain attributes to define the configuration information that your data handler requires. At a minimum, the child meta-object *must* have a `ClassName` attribute.

2. Determine whether you need to specify the name of the data handler class in the `ClassName` attribute.
 - For a data handler that is in the default format, you do not need to specify a value for `ClassName`. The default format is:
`com.crossworlds.DataHandlers.MimeTypeString`
However, you can specify the class name for the data handler in the `ClassName` attribute's default value.
 - For a data handler class that is not in the default format, you must specify the full class name for the data handler instance. Otherwise, the `createHandler()` method cannot locate your data handler class when it tries to instantiate the data handler.
3. Set the default values of the appropriate attributes in the child meta-object to configure how the data handler instance will process data.

Modifying the top-level meta-object

When a caller supplies a MIME type to the `createHandler()` method, `createHandler()` determines which data handler to instantiate with these steps:

1. Locate the name of the top-level meta-object that is associated with the data handler.
2. Look in this top-level meta-object for a MIME type that matches the data to convert.
3. If this MIME type exists, find the name of the associated child meta-object, which contains the configuration information.

For a more detailed explanation of this process, see "Using a MIME type" on page 13. For this process to be successful, `createHandler()` must be able to locate the MIME type associated with data. Therefore, you must edit the top-level data-handler meta-object to include an attribute for the MIME type of the data that your data handler converts. This attribute must include:

- A name that matches the MIME-type string for the data handler's associated MIME type
The name of the MIME type can contain *only* alphanumeric characters and the underscore (`_`). No other special characters are valid. If your MIME type contains a period (`.`), replace it with an underscore.
- A single-cardinality business object
- A type that is the name of the child meta-object representing your data handler

As an example, Figure 37 shows a top-level connector meta-object that is configured for a custom HTML data handler.

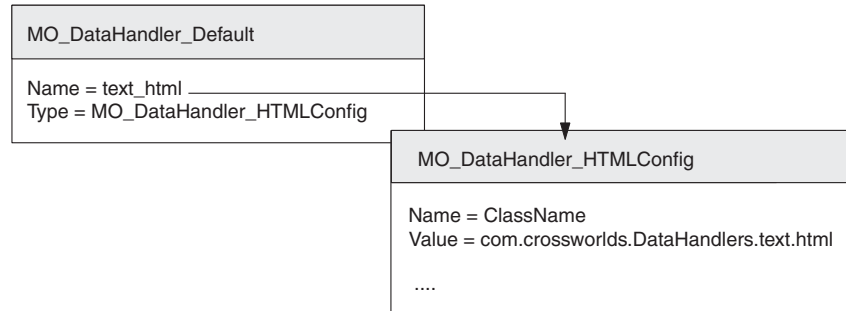

Figure 37. Example top-level connector meta-object for a custom data handler

In Figure 37, the default top-level meta-object for a connector (`MO_DataHandler_Default`) has been modified to support a new MIME type: HTML. In support of this MIME type, the `MO_DataHandler_Default` meta-object contains the following attribute properties:

Attribute Name = `text_html`
 Attribute Type = `MO_DataHandler_HTMLConfig`

Important: The name of the MIME type is limited to alphanumeric characters and underscores (`_`). No other special characters can be used for the MIME type.

Setting up meta-objects in the business integration system

Once you have created the data-handler meta-objects, you must set up these meta-objects in the WebSphere business integration system, as follows:

1. Load the new meta-objects into the repository.
2. Modify the appropriate meta-object depending on the context in which the data handler will be called:
 - If the data handler is to execute in the context of a connector, add the data handler meta-object as a child to the top-level data handler meta-object. Then add support for the top-level data handler meta-object to the connector definition.
 - If the data handler is to execute in the context of the Server Access Interface, add the data handler meta-object as a child to the top-level server meta-object `MO_Server_Datahandler`.

Setting up other business objects

In addition to coding the data handler, you must set up any business objects for the data handler. Create business objects that conform to the requirements of the data handler as well as to the requirements of the caller.

Tip: Make sure that any business objects the data handler requires are on the supported objects list for any connector that will use the data handler.

Configuring a connector

If the custom data handler will be used in the context of a connector, you need to configure each connector to obtain the name of the top-level connector meta-object. Connectors get information about data-handler meta-object names and class names in different ways. For example:

- To configure the WebSphere Business Integration Adapter for XML to use a data handler, you set the `DataHandlerConfigMO` connector configuration property and set the `MimeType` attribute in the XML connector's business object.
- To configure the WebSphere Business Integration Adapter for JText to use a data handler, you set the `ClassName`, or `DataHandlerConfigMO` and the `MimeType` attributes in the JText configuration meta-object.

For more information, see “Configuring a connector to use data handlers” on page 25.

Tip: When you configure a connector to use a data handler, make sure that the spelling of the meta-object name is correct and make sure that the MIME type is spelled correctly.

An internationalized data handler

An *internationalized data handler* is a data handler that has been written in such a way that it can be customized for a particular locale. A *locale* is the part of a user's environment that brings together information about how to handle data that is specific to the end user's particular country, language, or territory. The locale is typically installed as part of the operating system. Creating a data handler that handles locale-sensitive data is called the *internationalization* (I18N) of the data handler. Preparing an internationalized data handler for a particular locale is called the *localization* (L10N) of the data handler.

This section provides the following information on an internationalized data handler:

- What is a locale?
- Design considerations for an internationalized data handler

What is a locale?

A *locale* provides the following information for the user environment:

- Cultural conventions according to the language and country (or territory)
 - Data formats:
 - Dates: define full and abbreviated names for weekdays and months, as well as the structure of the date (including date separator).
 - Numbers: define symbols for the thousands separator and decimal point, as well as where these symbols are placed within the number.
 - Times: define indicators for 12-hour time (such as AM and PM indicators) as well as the structure of the time.
 - Monetary values: define numeric and currency symbols, as well as where these symbols are placed within the monetary value.
 - Collation order: how to sort data for the particular character code set and language.
 - String handling includes tasks such as letter “case” (upper case and lower case) comparison, substrings, and concatenation.
- A *character encoding* — the mapping from a character (a letter of the alphabet) to a numeric value in a character code set. For example, the ASCII character code set encodes the letter “A” as 65, while the EBCDIC character set encodes this letter as 43. The *character code set* contains encodings for all characters in one or more language alphabets.

A locale name has the following format:

ll_TT.codeset

where *ll* is a two-character language code (usually in lower case), *TT* is a two-letter country and territory code (usually in upper case), and *codeset* is the name of the associated character code set. The *codeset* portion of the name is often optional. The locale is typically installed as part of the installation of the operating system.

Design considerations for an internationalized data handler

This section provides the following categories of design considerations for internationalizing a data handler:

- Locale-sensitive design principles
- Character-encoding design principles

Locale-sensitive design principles

To be internationalized, a data handler must be coded to be locale-sensitive; that is, its behavior must take the locale setting into consideration and perform the task appropriate to that locale. For example, for locales that use English, the data handler should obtain its error messages from an English-language message file. The data handler framework that is installed with the product is internationalized. To complete the internationalization (I18N) of a data handler you develop, you must ensure that your data-handler implementation is internationalized.

An internationalized data handler must follow a set of locale-sensitive design principles:

- The text of all error, status, and trace messages should be isolated from the data-handler implementation in a message file and translated into the language of the locale.
- Sorting or collation of data uses a collation order appropriate for the language and country of the locale.
- String processing (such as comparison, substrings, and letter case) is appropriate for characters in the locale's language.
- Formats of dates, numbers, and times are appropriate for the locale.

The data handler might need to perform locale-sensitive processing (such as data format conversions) when it converts between the serialized data application and a business object. To track the locale associated with the data handler's environment, the `DataHandler` class has a private locale variable, which is initialized to the locale of the operating system on which the data handler runs. You can access the data handler environment's locale (the value of this private locale variable) at runtime through the accessor methods in Table 52.

Table 52. Methods to access the data handler environment's locale

Data Handler class	Method
<code>DataHandler</code>	<code>getLocale()</code> , <code>setLocale()</code>

When a business object is created, it has a locale associated with its data. This locale applies to the data in the business object, *not* to the name of the business object definition or its attributes (which must be characters in the code set associated with the U.S. English locale, `en_US`). To create a business object, your data handler can use the methods shown in Table 53. These methods have access to

the private locale variable in the `DataHandler` class. When one of these methods creates a business object, it associates with this business object the locale that the private `DataHandler` locale variable specifies.

Note: The methods in Table 53 set the locale *only* in the top-level business object. If the business object contains child business objects, these children might not have a valid locale value because they have their locale set to the system default.

Use the methods in Table 53 to create a business object and set the locale for its data. To ensure that the private locale variable specifies the correct locale for the data in the business object, you can use the `setLocale()` method *before* you call either of the methods in Table 53.

Table 53. Methods to assign a locale to a business object

Data Handler class	Method
<code>DataHandler</code>	<code>getBO()</code> - public, <code>getBOName()</code>

Character-encoding design principles

If data transfers from a location that uses one code set to a location that uses a different code set, some form of character conversion needs to be performed for the data to retain its meaning. The Java runtime environment within the Java Virtual Machine (JVM) represents data in the Unicode character set. The Unicode character set is a universal character set that contains encodings for characters in most known character code sets (both single-byte and multibyte). There are several encoding formats of Unicode. The following encodings are used most frequently within the integration business system:

- Universal multiple octet Coded Character Set: UCS-2
The UCS-2 encoding is the Unicode character set encoded in 2 bytes (octets).
- UCS Transformation Format, 8-bit form: UTF-8
The UTF-8 encoding is designed to address the use of Unicode character data in UNIX environments. It supports all ASCII code values (0...127) so that they are never interpreted as anything except a true ASCII code. Each code value is usually represented as a 1-, 2-, or 3- byte value.

Most components in the IBM WebSphere business integration system are written in Java. Therefore, when data is transferred between most system components, it is encoded in the Unicode code set and there is no need for character conversion.

Because a data handler is a component written in Java, it handles the serialized data in the Unicode code set. Usually, the source of the data's input stream is also processing in Unicode. Therefore, a data handler does not normally need to perform character conversion on the serialized data. However, if the input or output data contains a byte array whose character encoding is not the same as the system default, the data handler must provide the character encoding.

To track the character encoding associated with the data handler's environment, the `DataHandler` class has a private character-encoding variable, which is initialized to the character encoding associated with the locale of the operating system on which the data handler runs. You can access the data handler environment's character encoding (the value of this private character-encoding variable) at runtime through the accessor methods in Table 54.

Table 54. Methods to retrieve the data handler's character encoding

Data Handler Class	Method
DataHandler	getEncoding(), setEncoding()

Chapter 9. Data Handler base class methods

The `DataHandler` class is the base class for the data handlers. It is contained in the `com.crossworlds.DataHandlers` package. All data handlers, including custom data handlers, must extend this abstract class.

The methods documented in this chapter fall into three categories:

- Abstract methods that must be implemented
- Public methods that have a provided implementation that may be overridden if needed
- Static methods that are called by connectors or access clients

Table 55 lists the methods of the `DataHandler` class.

Table 55. Member methods of the `DataHandler` class

Member methods	Type	Description	Page
<code>createHandler()</code>	Public Static	Creates an instance of a data handler.	157
<code>getBO()</code> - abstract	Abstract	Populates a business object with values extracted from serialized input data.	158
<code>getBO()</code> - public	Public	Converts serialized data to a business object.	160
<code>getBOName()</code>	Public	Gets the name of a business object based on the content of the serialized data.	161
<code>getBooleanOption()</code>	Public	Gets the value of the specified data-handler configuration option if it contains Boolean data.	162
<code>getByteArrayFromBO()</code>	Public	Serializes a business object into a byte array.	163
<code>getEncoding()</code>	Public	Retrieves the character encoding that the data handler is using.	164
<code>getLocale()</code>	Public	Retrieves the locale of the data handler.	164
<code>getOption()</code>	Public	Gets the value of the specified data-handler configuration option (if it has been set).	165
<code>getStreamFromBO()</code>	Abstract	Serializes a business object into an <code>InputStream</code> object.	165
<code>getStringFromBO()</code>	Abstract	Serializes a business object into a <code>String</code> object.	166
<code>setConfigMOName()</code>	Static	Sets the name of the top-level data-handler meta-object in a static property of the <code>DataHandler</code> base class.	167
<code>setEncoding()</code>	Public	Sets the character encoding that the data handler is using.	168
<code>setLocale()</code>	Public	Sets the locale of the data handler.	168
<code>setOption()</code>	Public	Sets the value of the specified data-handler configuration option.	169
<code>traceWrite()</code>	Public	Calls the appropriate trace-write function to write a trace message for the data handler.	170

`createHandler()`

Creates an instance of a data handler.

Syntax

```
public static DataHandler createHandler(String className,  
String mimeType, String BOPrefix);
```

Parameters

<i>className</i>	Is the class name of the data handler instance to create. If not specified, the method uses the <i>mimeType</i> argument to determine which data-handler class to instantiate.
<i>mimeType</i>	Specifies the MIME type of the data handler instance to create. If not provided, the method expects a <i>className</i> value to be provided. Key to the meta-object. If <i>BOPrefix</i> is provided, <i>mimeType</i> becomes part of the key.
<i>BOPrefix</i>	Is an optional parameter. If present, it is combined with <i>mimeType</i> to form the key to the meta-object. This argument can be used to specify a MIME subtype. It can also be used to set the data-handler configuration property <i>BOPrefix</i> .

Return values

An instance of a data handler.

Exceptions

Exception

Thrown if the method is unable to instantiate the data handler.

Notes

This method creates an instance of a data handler based on the values of its *className*, *mimeType*, and *BOPrefix* parameters:

- If the `createHandler()` method is called by a connector, the connector can specify a *className* value. If *className* is specified, `createHandler()` instantiates a data handler of this class name.
- If *mimeType* is specified, `createHandler()` creates a data handler based on the specified MIME type.

The method checks the top-level data-handler meta-object for an attribute whose name matches the content type of either the *mimeType* parameter or the *mimeType* and *BOPrefix* combination. If a matching attribute is found, the value of the `ClassName` attribute in the child meta-object is used as the class name.

If the method succeeds in instantiating a class for the data handler, it calls `setupOptions()` to set up the configuration properties for use by the data handler instance. For a complete description of how `createHandler()` instantiates a data handler, see "Data handler instantiation" on page 12.

For example, for MIME = "text/xml-application-xxx", the method loads the `com.crossworlds.DataHandlers.text.xml_application_xxx` class.

getBO() - abstract

Populates a business object with values extracted from serialized input data.

Syntax

```
public abstract void getBO(Reader serializedData,
                          BusinessObjectInterface theBusObj, Object config);
public abstract BusinessObjectInterface getBO(Reader serializedData,
                                              Object config);
```

Parameters

<i>serializedData</i>	Is a Java Reader object that accesses the serialized data.
<i>theBusObj</i>	Is the business object to populate with data.
<i>config</i>	Is an optional object that contains additional configuration information for the data handler.

Return values

The first form of this method has no return value. The second form returns a business object.

Notes

This `getB0()` method is the abstract method that performs string-to-business-object conversion for a data handler; that is, it defines the way to convert generic serialized data (accessed with a Reader object) to a business object. This method has two forms:

- The first form populates the empty business object, *theBusObj*, passed in by the caller.
- The second form creates a business object instance and populates it.

Note: A data handler that is called in the context of the Server Access Interface needs to provide functionality *only* for the second form of the `getB0()` method.

Important: The `getB0()` method is an abstract method that has no default implementation. Therefore, the data handler class *must* implement this method.

You pass the serialized data into `getB0()` as a Java Reader object. However, because Reader is a base class, you actually pass an instance of one of several subclasses of the Reader class. Some of the Reader subclasses provide an implementation for the `mark()` operation and some do not. The `mark()` operation allows the caller to mark a particular position within the stream and then subsequently return to that position.

Note: To pass a Reader object into the `getB0()` method of the XM data handler, you must ensure that the Reader subclass implements the `mark()` method. You can call the `isMarkSupported()` method of the Reader class to determine whether this method is supported for the Reader object you are using. It is recommended that you pass in the serialized data as a `StringReader` object.

If you need to provide your data handler with more configuration information than is included in the meta-object, you can use the *config* option to pass in an object that contains this information. For example, *config* could be a template file or a string to a URL for a schema that is used to build an XML document from a business object.

If *config* is a business object type, you can implement the `getB0()` method to call `setupOptions(config)`. The `setupOptions()` method is defined in the `DataHandler` base class. This method uses the attribute names in the business object as property names and the default values as the values for those properties. It sets the values of the configuration properties in the object for use by the data handler.

Once you have implemented the abstract `getBO()` method, the component that calls the data handler can call one of the public string-to-business-object conversion methods, shown in Table 56.

Table 56. Public string-to-business-object conversion methods

Public string-to-business-object conversion method	Description
<code>getBO(Object <i>serializedData</i>, Object <i>config</i>)</code>	Convert serialized data in a generic Object to a business object
<code>getBO(String <i>serializedData</i>, Object <i>config</i>)</code>	Convert serialized data in a Object to a business object
<code>getBO(InputStream <i>serializedData</i>, Object <i>config</i>)</code>	Convert serialized data in an InputStream to a business object
<code>getBO(byte[] <i>serializedData</i>, Object <i>config</i>)</code>	Convert serialized data in a byte array to a business object

See also

`getBO()` - public

getBO() - public

Converts serialized data to a business object.

Syntax

```
public BusinessObjectInterface getBO(Object serializedData,
    Object config);
public BusinessObjectInterface getBO(String serializedData,
    Object config);
public BusinessObjectInterface getBO(InputStream serializedData,
    Object config);
public BusinessObjectInterface getBO(byte[] serializedData,
    Object config);
public void getBO(Object serializedData,
    BusinessObjectInterface theBusObj, Object config);
```

Parameters

serializedData Is a reference to the serialized data.

theBusObj Is the business object to populate with data.

config Is an optional object that contains additional configuration information for the data handler.

Return values

The first four forms return a business object populated with the data from the input Object, String, InputStream, or byte-array object. The fifth form populates the specified business object with the data from the serialized data.

Exceptions

Exception

Thrown if the method is unable to convert the serialized data to a business object.

NotImplementedException

Thrown if the public version of the `getBO()` method is not implemented.

Notes

This `getBO()` method is the public method to perform string-to-business-object conversion. The `DataHandler` base class includes the abstract forms of `getBO()` (as described on page 158), which must be implemented as part of the data-handler class. This public version of `getBO()` defines a set of utility methods that allow a component (such as a connector or access client) to specify the *serializedData* as an `Object`, `String`, or `InputStream` objects, or as a byte array. The method converts the specified serialized data to a `Reader` object and then calls one of the abstract `getBO()` methods to convert the `Reader` object to a business object.

The public `getBO()` method has the following forms:

- The first form calls the appropriate `getBO()` method based on the type of the *serializedData* object. For example, if the type of the data is `String`, the method calls `getBO(String serializedData, Object config)`.
- The second, third and fourth forms create a `Reader` object from a `String`, `InputStream`, or byte-array object and call the abstract `getBO()` method to convert the `Reader` object to a business object.
- The fifth form is another utility that handles `getBO()` calls when the caller passes in a business object. It performs the following tasks:
 - determines the type of the *serializedData* object passed in
 - converts the object to a `String` or `InputStream` object, if appropriate
 - calls the abstract version, passing the business object as well as the data

For information on the *config* argument, see its description under the abstract form of `getBO()` (as described on page 158).

See also

`getBO()` - abstract

getBOName()

Gets the name of a business object based on the content of the serialized data.

Syntax

```
public String getBOName(Reader serializedData);  
public String getBOName(String serializedData);  
public String getBOName(InputStream serializedData);
```

Parameters

serializedData A reference to a `Reader` object containing the message.

Return values

Returns a `String` object containing the name of the business object. If no value exists for the `NameHandlerClass` attribute, this method returns `null`.

Exceptions

The second and third forms of `getBOName()` can throw the following exceptions:

MalformedDataException

Thrown if the serialized data (*serializedData*) is not in the correct format.

NotImplementedException

Thrown if the name handler is not implemented.

Notes

The `getBOName()` method creates an instance of a name handler to extract the name of the business object definition from the serialized data. It instantiates this name-handler object based on the value of the `NameHandlerClass` meta-object attribute. The name handler builds the business object name based on the contents of a message.

The `getBOName()` method has the following forms:

- The first form returns the business object name based on the `BOPrefix` meta-object attribute (if one exists) as well as on the return value from the `NameHandler` class.
- The second form creates a `Reader` object from the `String` and then calls the first form.
- The third form creates a `Reader` object from the `InputStream` and then calls first form.

Currently, only the following IBM-delivered data handler uses this method:

- XML data handler

The default name handler for the XML data handler calls the base class `getBOName(Reader data)`. If the data handler cannot handle the request, the `<!DOCTYPE Name` is used to extract the base name of the business object. The final name is formed as:

```
BOPrefix + "_" + Name.getStreamFromBO()
```

To create your own name handler, extend the `NameHandler` abstract base class and override the `getBOName()` method.

For more information, see “Building a custom XML name handler” on page 82.

getBooleanOption()

Gets the value of the specified data-handler configuration option if it contains Boolean data.

Syntax

```
public boolean getBooleanOption(String name);
```

Parameters

name Name of the configuration option.

Return values

Returns the value of the Boolean type option.

Notes

The `createHandler()` method uses any child meta-object associated with the data handler to initialize its configuration options. You can use the `getBooleanOption()` method to obtain the value of one of these options, as long as the option contains a Boolean value.

getBytesFromBO()

Serializes a business object into a byte array.

Syntax

```
abstract byte[] getBytesFromBO(BusinessObjectInterface theBusObj,
                               Object config);
```

Parameters

<i>theBusObj</i>	Business object to be converted to a byte array.
<i>config</i>	Optional object containing additional configuration information for the data handler.

Return values

A byte array containing serialized data that represents the specified business object.

Exceptions

Exception

Thrown if the method cannot convert the business object to a byte array of serialized data.

Notes

The `getBytesFromBO()` method performs business-object-to-byte conversion for a data handler. It converts the data in the *theBusObj* business object into a byte array (a Java `byte[]` object).

Important: The `getBytesFromBO()` method is an abstract method that has no default implementation. Therefore, the data handler class *must* implement this method.

If you need to provide your data handler with more configuration information than is included in the meta-object, you can use the *config* option to pass in an object that contains this information. For example, *config* could be a template file or a string to a URL for a schema that is used to build an XML document from a business object.

If *config* is a business object type, you can implement the `getBytesFromBO()` method to call `setupOptions(config)`. The `setupOptions()` method is defined in the `DataHandler` base class. This method uses the attribute names in the business object as property names and the default values as the values for those properties. It sets the values of the configuration properties in the object for use by the data handler.

See also

`getBO()` - public, `getStreamFromBO()`, `getStringFromBO()`

getEncoding()

Retrieves the character encoding that the data handler is using.

Syntax

```
public final String getEncoding();
```

Parameters

None.

Return values

A `String` containing the data handler's character encoding.

Notes

The `getEncoding()` method retrieves the data handler's character encoding. The character encoding is part of the locale, which defines cultural conventions for data according to language, country (or territory). This method is the accessor method that retrieves the value of a private character-encoding variable in the `DataHandler` class. This character encoding should indicate the character encoding of the serialized data that the data handler is processing.

This method is useful when the data handler needs to perform character-encoding processing, such as character conversion.

See also

`setEncoding()`

getLocale()

Retrieves the locale of the data handler.

Syntax

```
public final Locale getLocale();
```

Parameters

None.

Return values

A `Java Locale` object that describes the locale for the data handler's environment.

Notes

The `getLocale()` method retrieves the data handler's locale, which defines cultural conventions for data according to language, country (or territory), and a character encoding. This method is the accessor method that retrieves the value of a private locale variable in the `DataHandler` class. By default, the data handler's locale is the locale of the operating system on which the data handler runs.

This method is useful when the data handler needs to perform locale-sensitive processing.

See also

`setLocale()`

getOption()

Gets the value of the specified data-handler configuration option (if it has been set).

Syntax

```
public String getOption(String name);
```

Parameters

name Name of the configuration option.

Return values

A `String` object that contains the value of the option.

Notes

The `getOption()` method obtains the value of a configuration option. If the data handler has an associated child meta-object, the `createHandler()` method uses the default values of these meta-object attributes to initialize its configuration options. You can use the `getOption()` method to obtain the value of one of these options.

See also

`setOption()`

getStreamFromBO()

Serializes a business object into an `InputStream` object.

Syntax

```
abstract InputStream getStreamFromBO(BusinessObjectInterface theBusObj,  
                                      Object config);
```

Parameters

theBusObj Business object to be converted to a stream.

config Optional object containing additional configuration information for the data handler.

Return values

An `InputStream` object containing serialized data representing a business object.

Exceptions

Exception

Thrown if the method cannot convert the business object to a stream of serialized data.

Notes

The `getStreamFromBO()` method performs business-object-to-stream conversion for a data handler. It converts the data in the *theBusObj* business object into a stream (a Java `InputStream` object).

Important: The `getStreamFromBO()` method is an abstract method that has no default implementation. Therefore, the data handler class *must* implement this method.

If you need to provide your data handler with more configuration information than is included in the meta-object, you can use the `config` option to pass in an object that contains this information. For example, *config* could be a template file or a string to a URL for a schema that is used to build an XML document from a business object.

If *config* is a business object type, you can implement the `getStreamFromBO()` method to call `setupOptions(config)`. The `setupOptions()` method is defined in the `DataHandler` base class. This method uses the attribute names in the business object as property names and the default values as the values for those properties. It sets the values of the configuration properties in the object for use by the data handler.

See also

`getBO()` - public, `getByteArrayFromBO()`, `getStringFromBO()`

getStringFromBO()

Serializes a business object into a `String` object.

Syntax

```
abstract String getStringFromBO(BusinessObjectInterface theBusObj,  
                               Object config);
```

Parameters

<i>theBusObj</i>	Business object to be converted to a <code>String</code> .
<i>config</i>	Optional object containing additional configuration information for the data handler.

Return values

A `String` object containing serialized data that represents the data in the business object.

Exceptions

Exception

Thrown if the method cannot convert the business object to a string of serialized data.

Notes

The `getStringFromBO()` method performs business-object-to-string conversion for a data handler. It converts the data in the *theBusObj* business object into a Java String object.

Important: The `getStringFromBO()` method is an abstract method that has no default implementation. Therefore, the data handler class *must* implement this method.

If you need to provide your data handler with more configuration information than is included in the meta-object, you can use the `config` option to pass in an object that contains this information. For example, *config* could be a template file or a string to a URL for a schema that is used to build an XML document from a business object.

If `config` is a business object type, you can implement the `getStreamFromBO()` method to call `setupOptions(config)`. The `setupOptions()` method is defined in the `DataHandler` base class. This method uses the attribute names in the business object as property names and the default values as the values for those properties. It sets the values of the configuration properties in the object for use by the data handler.

See also

`getBO()` - public, `getByteArrayFromBO()`, `getStreamFromBO()`

setConfigMOName()

Sets the name of the top-level data-handler meta-object in a static property of the `DataHandler` base class.

Syntax

```
public static void setConfigMOName(String name);
```

Parameters

name String containing the name of the data-handler meta-object.

Return values

None.

Exceptions

Exception

Thrown if the method set the specified top-level data-handler meta-object.

Notes

The top-level data-handler meta-object holds the supported MIME types and the names of their associated child meta-objects. For information on data-handler meta-objects, see “Configuring data handlers” on page 21.

setEncoding()

Sets the character encoding that the data handler is using.

Syntax

```
public final void setEncoding(String encodingName);
```

Parameters

encodingName

A String object containing the new value to assign as the data handler’s character encoding.

Return values

None.

Notes

The `setEncoding()` method sets the data handler’s character encoding. The character encoding is part of the locale, which defines cultural conventions for data according to language, country (or territory). This method is the accessor method that sets a private character-encoding variable in the `DataHandler` class. This character encoding should indicate the character encoding of the serialized data that the data handler is processing.

This method is useful when the data handler needs to perform character-encoding processing, such as character conversion.

See also

`getEncoding()`

setLocale()

Sets the locale of the data handler.

Syntax

```
public final void setLocale(Locale localeObject);
```

Parameters

localeObject

A Java `Locale` object containing the new locale to assign to the data handler’s environment.

Return values

None.

Notes

The `setLocale()` method sets the data handler's locale, which defines cultural conventions for data according to language, country (or territory), and a character encoding. This method is the accessor method that sets a private locale variable in the `DataHandler` class. This locale should indicate the locale of the serialized data that the data handler receives and creates.

This method is useful when the data handler needs to change the data handler's locale. A possible use is to specify a different locale for the serialized data to be converted to a business object. Calling `setLocale()` before a call to `getBO()` changes the locale that `getBO()` uses when it associated a locale with the business object it creates.

See also

`getLocale()`

setOption()

Sets the value of the specified data-handler configuration option.

Syntax

```
public void setOption(String name, String value);
```

Parameters

<i>name</i>	Name of the configuration option.
<i>value</i>	Value of the configuration option.

Return values

None.

Notes

The `setOption()` method assigns a new value to the configuration option. If the data handler has an associated child meta-object, the `createHandler()` method uses the default values of these meta-object attributes to initialize its configuration options. If the data handler is called in the context of a connector, this child meta-object is in the connector-process memory. If the data handler is called in the context of an access client, this meta-object is in the memory of the InterChange Server Express process. You can use the `setOption()` method to override the value of one of these options.

Note: Changing a configuration option with `setOption()` sets the value of the meta-object attribute in memory. It does not affect the value of the attribute in the repository.

See also

`getOption()`

traceWrite()

Calls the appropriate trace-write function to write a trace message for the data handler.

Syntax

```
public void traceWrite(String message, int level);
```

Parameters

<i>message</i>	The message text to use for the trace message.
<i>level</i>	An integer specifying the trace level for the message. The trace level is from 0-5, where 0 specifies no tracing and 5 specifies full tracing.

Return values

None.

Notes

The `traceWrite()` method is a wrapper method that calls the appropriate trace write function depending on the context in which the data handler runs. The default tracing is connector tracing. If the data handler is run in the context of the Server Access Interface, the `traceWrite()` method sets the tracing subsystem before calling the trace-write method.

Appendix. Using the XML ODA

This chapter describes the XML ODA, an Object Discovery Agent (ODA) that generates business object definitions for XML documents. Because an XML document can have its schema defined by either a Document type definition (DTD) or a schema document, the XML ODA can use either of these data models to discover business object requirements specific to the XML document.

This chapter contains the following sections:

- “Installation and usage”
- “Using an XML ODA in Business Object Designer Express” on page 174
- “Contents of the generated business object definition” on page 183
- “Modifying information in the business object definition” on page 183

Installation and usage

This section discusses the following:

- “Installing the XML ODA”
- “Before using the XML ODA” on page 171
- “Launching the XML ODA” on page 172
- “Running multiple instances of the XML ODA” on page 173
- “Working with error and trace message files” on page 173

Installing the XML ODA

To install the XML ODA, use an IBM WebSphere Installer. For instructions on how to install this ODA with the Installer for IBM WebSphere Business Integration Server Express, see the *WebSphere Business Integration Server Express Installation Guide*.

When the installation is complete, the following files are installed in the product directory on your system:

- ODA\XML\XMLODA.jar
- ODA\messages\XMLODAAgent.txt
- ODA\messages\XMLODAAgent_*ll*_*TT*.txt files (message files specific to a language (*ll*) and a country or territory (*TT*))
- ODA\XML\start_XMLODA.bat (Windows only)
- ODA/XML/start_XMLODA.sh (UNIX only)

Note: Except as otherwise noted, this document uses backslashes (\) as the convention for directory paths. For UNIX installations, substitute slashes (/) for backslashes. All product pathnames are relative to the directory where product is installed on your system.

Before using the XML ODA

Before you run the XML ODA, verify that your system has the required files for the XML ODA. In particular, make sure that the ODA environment file has been installed in the bin subdirectory of your product directory.

UNIX

Make sure that the ODA environment file, `CWODAEnv.sh`, is installed in the following directory: `ProductDir/bin`.

Windows

Make sure that the ODA environment file, `CWODAEnv.bat`, is installed in the following directory: `ProductDir\bin`.

You must also make sure that the variables are correctly set in the startup script or batch file, which runs the ODA. Open for editing the shell (`start_XMLODA.sh`) or batch (`start_XMLODA.bat`) file and confirm that the values described in Table 57 are correct.

Table 57. Shell and batch file configuration variables

Variable	Explanation	Example
<code>set AGENTNAME</code>	Name of the ODA	<code>set AGENTNAME=XMLODA</code>
<code>set AGENT</code>	Name of the ODA's jar file	UNIX: <code>set AGENT = \${ProductDir}/ODA/XML/XMLODA.jar</code> WINDOWS: <code>set AGENT = %ProductDir%\ODA\xml\xmloda.jar</code>
<code>set AGENTCLASS</code>	Name of the ODA's Java class	<code>set AGENTCLASS=com.crossworlds.oda.xml.XMLAgent</code>

After installing the XML ODA and setting configuration variables in the shell or batch file (see Table 57), you must do the following to generate business objects:

1. Launch the XML ODA.
2. Launch Business Object Designer Express.
3. Follow a six-step process in Business Object Wizard, a GUI interface that Business Object Designer Express provides to configure and run an ODA.

The following sections describe these steps in detail.

Launching the XML ODA

You can launch the XML ODA with the startup script appropriate for your operating system.

UNIX

```
start_XMLODA.sh
```

Windows

```
start_XMLODA.bat
```

Note: The Windows Installer provides shortcuts to startup the ODAs it installs. If you have used this Installer to install the XML ODA, you will find a shortcut to start it under the menu Programs > IBM WebSphere Business Integration Adapters > Adapters > Object Discovery Agents.

You configure and run the XML ODA using Business Object Designer Express. Business Object Wizard, which Business Object Designer Express starts, locates each ODA by the name specified in the AGENTNAME variable of each script or batch file. The default ODA name for this connector is XMLODA.

Running multiple instances of the XML ODA

You can run multiple instances of an XML ODA either on the local host machine or a remote host machine. Each instance runs on a unique port. You can specify this port number as part of launching the ODA from within Business Object Designer Express. Figure 38 on page 175 illustrates the window in Business Object Designer Express from which you select the ODA to run.

Working with error and trace message files

Error and trace message files (the default is XMLODAAgent.txt) are located in the \ODA\messages, subdirectory under the product directory. These files use the following naming convention:

AgentNameAgent.txt

If you create multiple instances of the ODA script or batch file and provide a unique name for each represented ODA, you can have a message file for each ODA instance. Alternatively, you can have differently named ODAs use the same message file. There are two ways to specify a valid message file:

- If you change the name of an ODA and do not create a message file for it, you must change the name of the message file in Business Object Designer Express as part of ODA configuration. Business Object Designer Express provides a name for the message file but does not actually create the file. If the file displayed as part of ODA configuration does not exist, change the value to point to an existing file.
- You can copy the existing message file for a specific ODA, and modify it as required. Business Object Designer Express assumes you name each file according to the naming convention. For example, if the AGENTNAME variable specifies XMLODA1, the tool assumes that the name of the associated message file is XMLODA1Agent.txt. Therefore, when Business Object Designer Express provides the file name for verification as part of ODA configuration, the file name is based on the ODA name. Verify that the default message file is named correctly, and correct it as necessary.

Important: Failing to correctly specify the message file's name when you configure the ODA causes it to run without messages. For more information on specifying the message file name, see Table 59 on page 176.

During the configuration process, you specify:

- The name of the file into which the XML ODA writes error and trace information
- The level of tracing, which ranges from 0 to 5.

Table 58 describes these values.

Table 58. Tracing levels

Trace Level	Description
0	Logs all errors
1	Traces all entering and exiting messages for method
2	Traces the ODA's properties and their values
3	Traces the names of all business objects
4	Traces details of all spawned threads
5	• Indicates the ODA initialization values for all of its properties • Traces a detailed status of each thread that the XML ODA spawned • Traces the business object definition dump

For information on where you configure these values, see Table 59 on page 176.

Using an XML ODA in Business Object Designer Express

This section describes how to use Business Object Designer Express to generate business object definitions using the XML ODA. For information on launching Business Object Designer Express, see the *Business Object Development Guide*. Business Object Designer Express provides a wizard, called Business Object Wizard, that guides you through each of these steps. After you launch an ODA, you must launch Business Object Designer Express to obtain access to Business Object Wizard (which configures and runs the ODA). There are six steps in Business Object Wizard to generate business object definitions using an ODA.

After starting the ODA, do the following to start the wizard:

1. Open Business Object Designer Express.
2. From the File menu, select the New Using ODA... submenu.
Business Object Wizard displays the first window in the wizard, named Select Agent. Figure 38 on page 175 illustrates this window.

To select, configure, and run the ODA, follow these steps:

1. "Select the ODA"
2. "Specify configuration properties" on page 175
3. "Expand nodes and select XML elements" on page 177
4. "Confirm selection of objects" on page 178
5. "Generate the business object definition" on page 179 and, optionally, "Provide additional information" on page 180
6. "Save the business object definition" on page 182

Select the ODA

Figure 38 on page 175 illustrates the first dialog box in Business Object Wizard's six-step wizard. From this window, select the ODA to run.

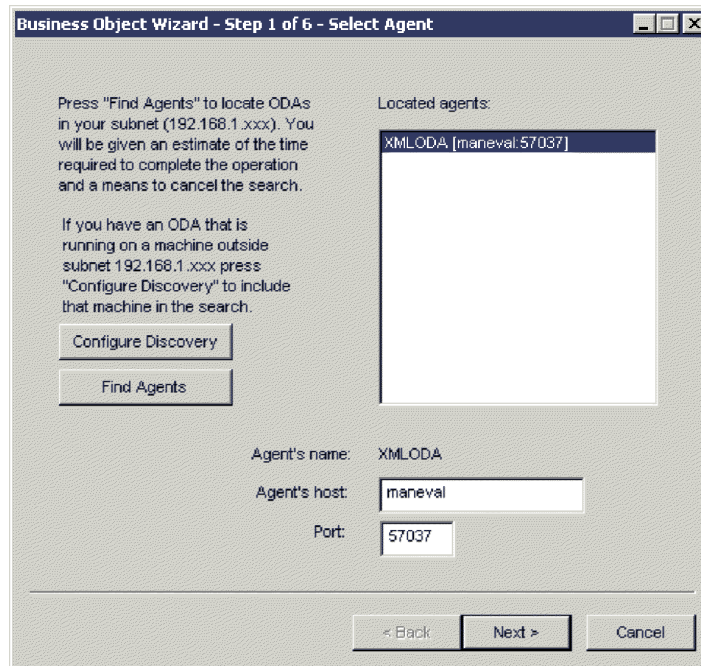

Figure 38. Selecting the ODA

To select the ODA:

1. Click the Find Agents button to display all registered or currently running ODAs in the Located agents field. Alternatively, you can find the ODA using its host name and port number.

Note: If Business Object Wizard does not locate your desired ODA, check the setup of the ODA.

2. Select the desired ODA from the displayed list.

Business Object Wizard displays your selection in the Agent's name field.

Specify configuration properties

The first time Business Object Wizard communicates with XML ODA, it prompts you to enter a set of ODA configuration properties as shown in Figure 39 on page 176.

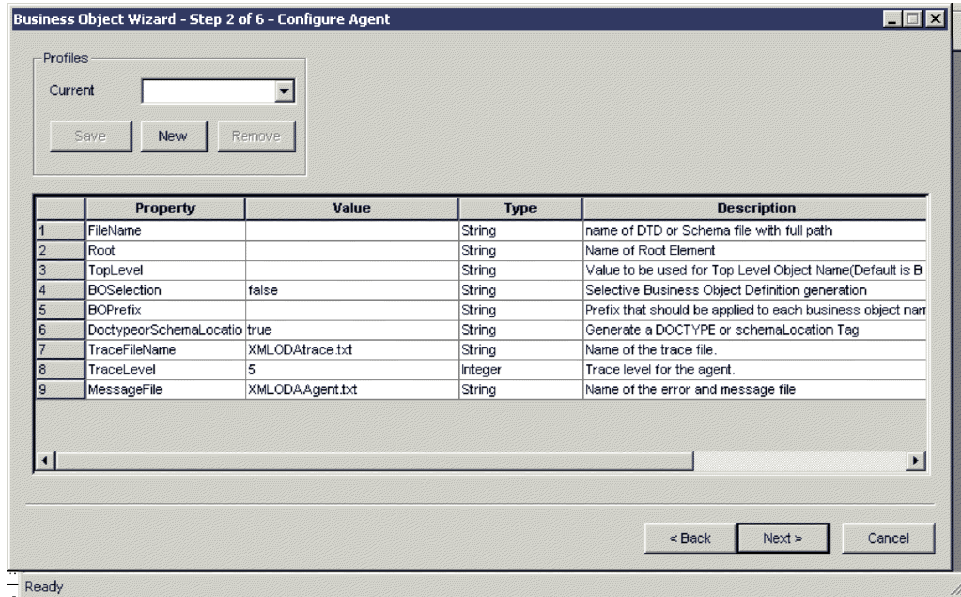

Figure 39. Specifying ODA configuration properties

Configure the XML ODA properties described in Table 59.

Table 59. XML ODA configuration properties

Row number	Property name	Property type	Description
1	FileName	String	Full pathname of the DTD or schema document. A DTD file must have the .dtd extension; a schema-document file must have the .xsd extension.
2	Root	String	Name of the XML element that is to be treated as the root element. If no root element is specified, the XML ODA makes the following assumptions: <ul style="list-style-type: none"> • If the ODA is parsing a DTD, it treats the first XML element as the root. • If the ODA is parsing a schema document, it treats the first global element as the root.
3	TopLevel	String	Name to be used for the top-level business object that the ODA generates. The ODA prepends the top-level business object with the business-object prefix (which the BOPrefix property specifies), separated by an underscore (_). If you do <i>not</i> specify a top-level name, the ODA assigns the name <i>BOPrefix_Root</i> (where <i>BOPrefix</i> and <i>Root</i> are the values of the BOPrefix and Root properties) as the name of the top-level business object.
4	BOSelection	String	A boolean value (true or false) to indicate whether the XML ODA will allow you to select the names of elements for which business object definitions are to be used. <ul style="list-style-type: none"> • If this property is set to false, the XML ODA allows the user to select only the root as the element and will generate business object definitions for the root and all of its child elements. • If this property is set to true, the XML ODA allows the user to select any element and will generate business object definitions only for the selected elements. <p>The default is false.</p>

Table 59. XML ODA configuration properties (continued)

Row number	Property name	Property type	Description
5	BOPrefix	String	Prefix that the ODA applies to the name of each business object definition for the XML document. If you do not specify a business-object prefix, the ODA does <i>not</i> prepend any string to the name of the business object definition.
6	DoctypeorSchemaLocation	String	A boolean value (true or false) to indicate whether the XML ODA should generate attributes for: <ul style="list-style-type: none"> • When processing DTDs: the DOCTYPE tag • When processing schema documents: the schemaLocation and xsi attributes (in the XML Schema Instance namespace) <p>The default is true.</p>
7	TraceFileName	String	Full pathname of the file into which XML ODA writes trace information. If the file does not exist, XML ODA creates it in the specified directory. If the file already exists, XML ODA appends to it. <p>By default, the XML ODA creates a trace file named XMLODAt race.txt in the ODA\XML subdirectory of the product directory.</p> <p>Use this property to specify a different name for the trace file.</p>
8	TraceLevel	Integer	Level of tracing enabled for XML ODA. Valid values are zero through five (0-5). Property defaults to a value of 5 (full tracing enabled). For more information, see “Working with error and trace message files” on page 173.
9	MessageFile	String	Full pathname of the error and message file. By default, the XML ODA creates a message and error file named XMLODAAgent.txt. <p>Important: The error and message file <i>must</i> be located in the ODA\messages subdirectory of the product directory.</p> <p>Use this property to verify or specify an existing file.</p>

Important: Correct the name of the message file if the default value displayed in Business Object Designer Express represents a non-existent file. If the name is not correct when you move forward from this dialog box, Business Object Designer Express displays an error message in the window from which the ODA was launched. This message does not pop up in Business Object Designer Express. Failing to specify a valid message file causes the ODA to run without messages.

You can save these properties in a named profile so that you do not need to re-enter them each time you use XML ODA. For information on specifying an ODA profile, see the *Business Object Development Guide*.

Expand nodes and select XML elements

Business Object Designer Express uses the properties configured in the previous step to connect the tool to the specified XML schema (DTD or schema document). After connecting, Business Object Designer Express displays a tree whose nodes represent all the XML elements defined in the XML schema.

You can expand the top-level XML element to display the entire hierarchical representation. For each XML element, XML ODA creates a child business object definition.

Figure 40 illustrates this dialog box with some XML elements expanded.

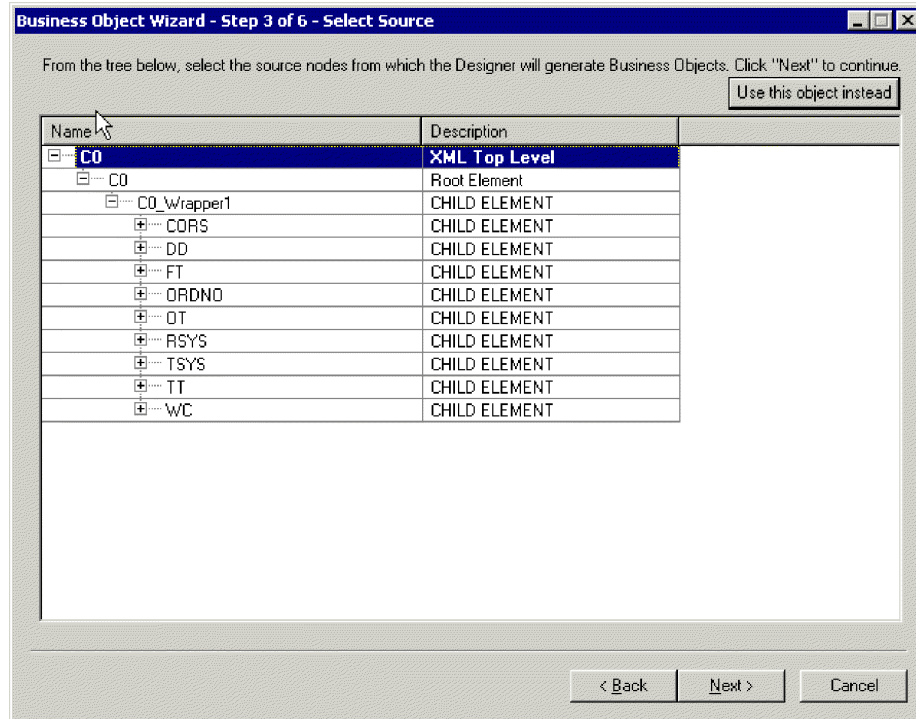

Figure 40. Tree of XML elements with expanded nodes

Select all required XML elements and click Next.

Confirm selection of objects

After you identify all the XML elements to be associated with the generated business object definitions, Business Object Designer Express displays the dialog box with only the selected objects. Figure 41 on page 179 illustrates this dialog box.

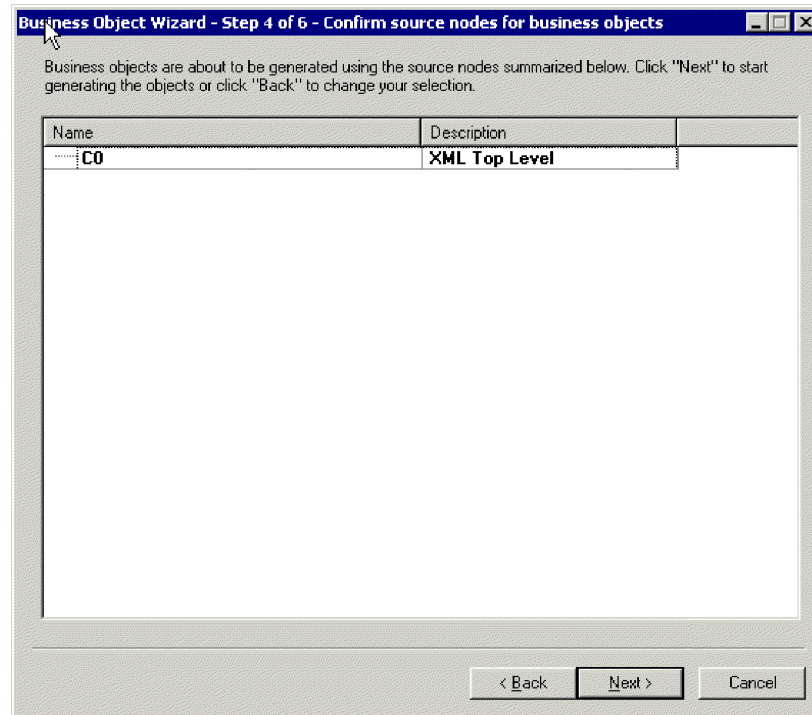

Figure 41. Confirming selection of objects

This window provides the following options:

- To confirm the selection, click Next.
- If the selection is not correct, click Back to return to the previous window and make the necessary changes. When the selection is correct, click Next.

Generate the business object definition

After you confirm the XML elements, the next dialog box informs you that Business Object Designer Express is generating the business object definition. If a large number of Component Interfaces has been selected, this generation step can take time.

Figure 42 on page 180 illustrates this dialog box.

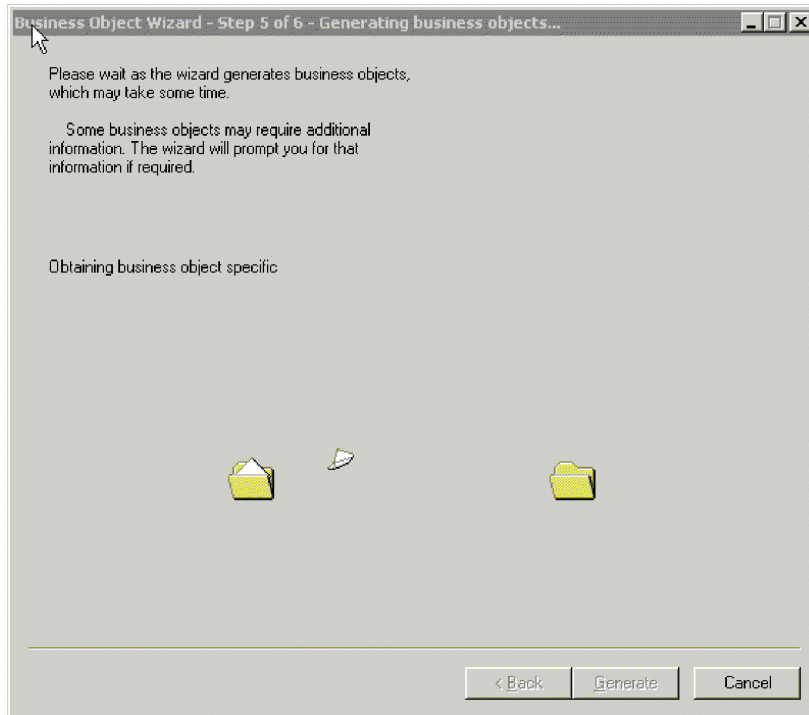

Figure 42. Generating the business object definitions

The XML ODA generates the name for a business object definition from the following information:

- The value of the `BOPrefix` ODA configuration property
- The value of the `TopLevel` ODA configuration property
- The name of the XML element that the business object definition represents

It separates each of these values with an underscore (`_`) character. Therefore, the name it generates has the following format:

`BOPrefix_TopLevel_XMLelement`

Provide additional information

Because the XML ODA needs additional information about the verbs, Business Object Designer Express displays the BO Properties window, which prompts you for the information. Figure 43 on page 181 illustrates this dialog box.

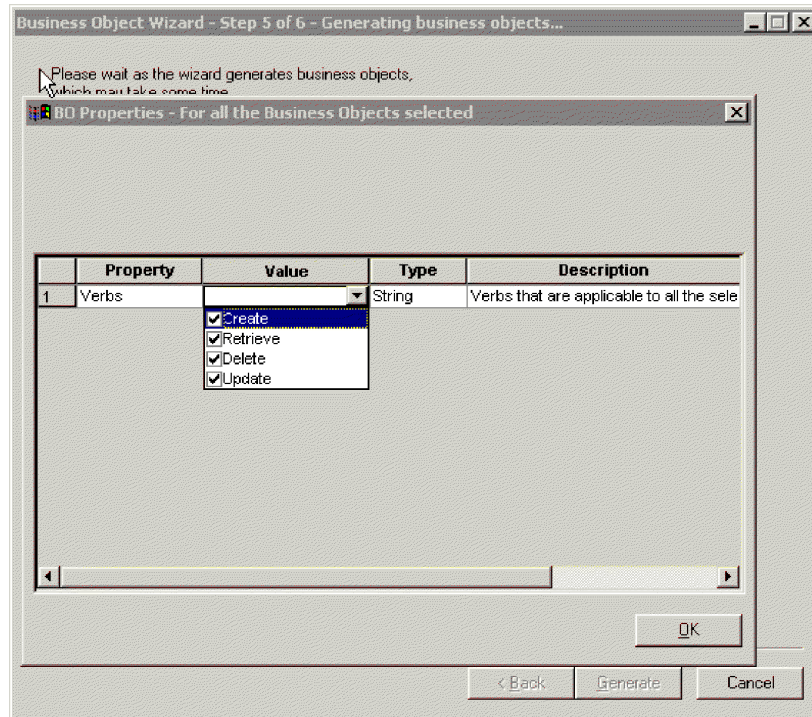

Figure 43. Providing additional information - verbs

In the BO Properties window, enter or change the verb information. Click in the *Value* field and select one or more verbs from the pop-up menu. These are the verbs supported by the business object.

Note: If a field in the BO Properties dialog box has multiple values, the field appears to be empty when the dialog box first displays. Click in the field to display a drop-down list of its values.

If your XML document has a schema document that contains an `anyAttribute` element, the XML ODA displays an additional BO Properties window, as shown in Figure 44.

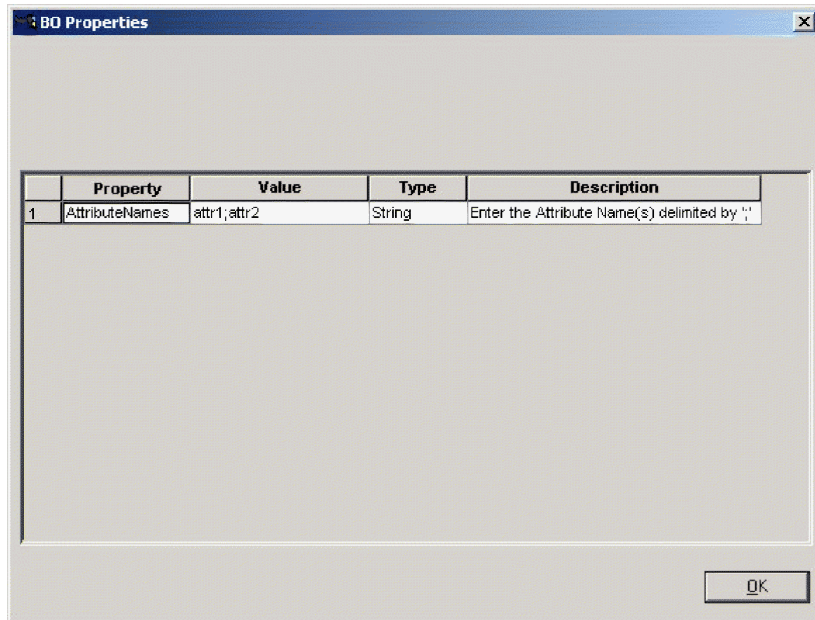

Figure 44. Providing additional information - attribute names

In this BO Properties window, enter the names of the business object attributes you want the XML ODA to create. Separate each attribute with a semicolon (;). For more information on anyAttribute, see “Supported schema-document structures” on page 74.

Save the business object definition

After you provide all required information in the BO Properties dialog box and click OK, Business Object Designer Express displays the final dialog box in the wizard. In this dialog box, you can take any of the following actions:

- Save the business object definition to the server (if InterChange Server is the integration broker).
- Save the business object definition to a file (for any integration broker).
- Open the business object definition for editing in Business Object Designer Express.

For more information, and to make further modifications, see the *Business Object Development Guide*.

Figure 45 on page 183 illustrates this dialog box.

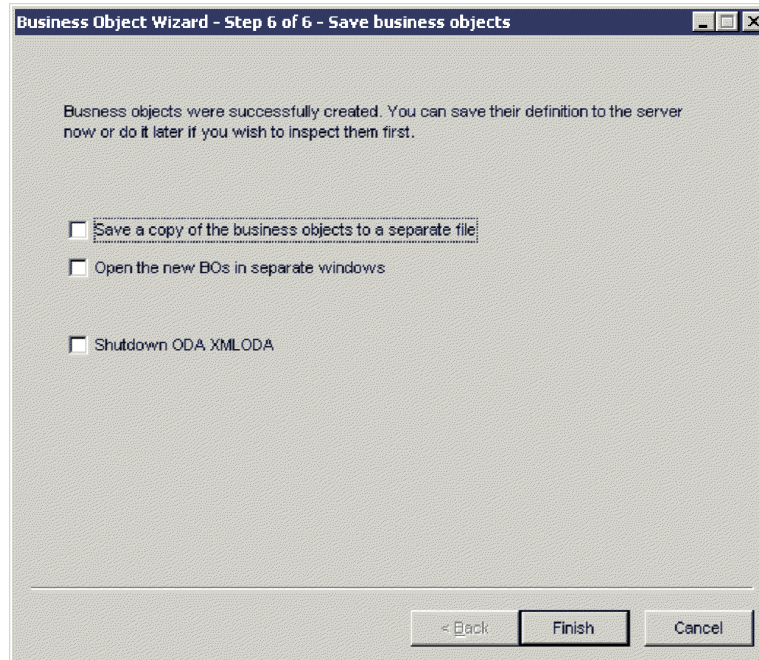

Figure 45. Saving the business object definition

Contents of the generated business object definition

The business object definition that the XML ODA generates the attributes, verbs, and application-specific information as described in the following sections:

Component of business object definition	For more information
Attributes	“Business object structure” on page 31 “Business object attribute properties” on page 32
Application-specific information	“Application-specific information” on page 34
Verbs	“Business object verbs” on page 35

Note: Earlier versions of the XML ODA generated parent business object definitions that designated the `ObjectEventId` attribute as the key. Business Object Designer Express no longer allows business object definitions to specify `ObjectEventId` as a key attribute. Therefore, XML ODA now takes special steps to avoid this behavior. This new behavior requires that you modify the generated business object definition to designate a key attribute. For more information, see “Key and Foreign Key attribute properties” on page 32.

Modifying information in the business object definition

It may be necessary modify information in the business object definition that the XML ODA creates. For example, you must manually remove unwanted attributes and add required tags for attribute application-specific information. To examine or modify the business object definition, you can use Business Object Designer Express or a text editor. To reload a revised definition into the repository, you can use Business Object Designer Express. Alternatively, if InterChange Server (ICS) is the integration broker, you can use the `repos_copy` command to load the definition

into the repository; if WebSphere MQ Integrator Broker is the integration broker, you can use a system command to copy the file into the repository directory.

Notices

IBM may not offer the products, services, or features discussed in this document in all countries. Consult your local IBM representative for information on the products and services currently available in your area. Any reference to an IBM product, program, or service is not intended to state or imply that only that IBM product, program, or service may be used. Any functionally equivalent product, program, or service that does not infringe any IBM intellectual property right may be used instead. However, it is the user's responsibility to evaluate and verify the operation of any non-IBM product, program, or service.

IBM may have patents or pending patent applications covering subject matter described in this document. The furnishing of this document does not give you any license to these patents. You can send license inquiries, in writing, to:

IBM Director of Licensing
IBM Corporation
North Castle Drive
Armonk, NY 10504-1785
U.S.A.

The following paragraph does not apply to the United Kingdom or any other country where such provisions are inconsistent with local law:

INTERNATIONAL BUSINESS MACHINES CORPORATION PROVIDES THIS PUBLICATION "AS IS" WITHOUT WARRANTY OF ANY KIND, EITHER EXPRESS OR IMPLIED, INCLUDING, BUT NOT LIMITED TO, THE IMPLIED WARRANTIES OF NON-INFRINGEMENT, MERCHANTABILITY OR FITNESS FOR A PARTICULAR PURPOSE. Some states do not allow disclaimer of express or implied warranties in certain transactions, therefore, this statement may not apply to you.

This information could include technical inaccuracies or typographical errors. Changes are periodically made to the information herein; these changes will be incorporated in new editions of the publication. IBM may make improvements and/or changes in the product(s) and/or program(s) described in this publication at any time without notice.

Any references in this information to non-IBM Web sites are provided for convenience only and do not in any manner serve as an endorsement of those Web sites. The materials at those Web sites are not part of the materials for this IBM product and use of those Web sites is at your own risk.

IBM may use or distribute any of the information you supply in any way it believes appropriate without incurring any obligation to you.

Licensees of this program who wish to have information about it for the purpose of enabling: (i) the exchange of information between independently created programs and other programs (including this one) and (ii) the mutual use of the information which has been exchanged, should contact:

IBM Burlingame Laboratory Director
IBM Burlingame Laboratory
577 Airport Blvd., Suite 800

Burlingame, CA 94010
U.S.A

Such information may be available, subject to appropriate terms and conditions, including in some cases, payment of a fee.

The licensed program described in this document and all licensed material available for it are provided by IBM under terms of the IBM Customer Agreement, IBM International Program License Agreement, or any equivalent agreement between us.

Any performance data contained herein was determined in a controlled environment. Therefore, the results obtained in other operating environments may vary significantly. Some measurements may have been made on development-level systems and there is no guarantee that these measurements will be the same on generally available systems. Furthermore, some measurement may have been estimated through extrapolation. Actual results may vary. Users of this document should verify the applicable data for their specific environment.

Information concerning non-IBM products was obtained from the suppliers of those products, their published announcements or other publicly available sources. IBM has not necessarily tested those products and cannot confirm the accuracy of performance, compatibility or any other claims related to non-IBM products. Questions on the capabilities of non-IBM products should be addressed to the suppliers of those products.

This information may contain examples of data and reports used in daily business operations. To illustrate them as completely as possible, the examples may include the names of individuals, companies, brands, and products. All of these names are fictitious and any similarity to the names and addresses used by an actual business enterprise is entirely coincidental.

All statements regarding IBM's future direction or intent are subject to change or withdrawal without notice, and represent goals and objectives only.

COPYRIGHT LICENSE

This information may contain sample application programs in source language, which illustrates programming techniques on various operating platforms. You may copy, modify, and distribute these sample programs in any form without payment to IBM, for the purposes of developing, using, marketing or distributing application programs conforming to the application programming interface for the operating platform for which the sample programs are written. These examples have not been thoroughly tested under all conditions. IBM, therefore, cannot guarantee or imply reliability, serviceability, or function of these programs.

Programming interface information

Programming interface information, if provided, is intended to help you create application software using this program.

General-use programming interfaces allow you to write application software that obtain the services of this program's tools.

However, this information may also contain diagnosis, modification, and tuning information. Diagnosis, modification and tuning information is provided to help you debug your application software.

Warning: Do not use this diagnosis, modification, and tuning information as a programming interface because it is subject to change.

Trademarks and service marks

The following terms are trademarks or registered trademarks of International Business Machines Corporation in the United States or other countries, or both:

IBM
the IBM logo
AIX
CrossWorlds
DB2
DB2 Universal Database
Domino
Lotus
Lotus Notes
MQIntegrator
MQSeries
Tivoli
WebSphere

Microsoft, Windows, Windows NT, and the Windows logo are trademarks of Microsoft Corporation in the United States, other countries, or both.

MMX, Pentium, and ProShare are trademarks or registered trademarks of Intel Corporation in the United States, other countries, or both.

Java and all Java-based trademarks are trademarks of Sun Microsystems, Inc. in the United States, other countries, or both.

Other company, product or service names may be trademarks or service marks of others.

Index

A

- Access client 4, 9
 - top-level meta-object 22
- Adapter Development Kit (ADK) 131
- Alignment data-handler configuration property 105
- Application-specific information
 - Delimited data handler and 115
 - FixedWidth data handler and 106
 - for a business object 41, 60
 - for an attribute 44, 67, 79
 - NameValue data handler and 122
 - Request-Response data handler and 93
 - size limitation 35
 - XML data handler and 41
- Attribute
 - complex 68
 - ignoring 139
 - simple 68, 69
- Attribute property
 - Cardinality 40, 59, 106, 114, 121
 - Delimited data handler and 114
 - FixedWidth data handler and 106
 - Foreign Key 32, 33, 40, 60
 - Key 32, 33, 40, 60
 - MaxLength 106
 - Name 32, 93, 94, 106, 114, 121
 - NameValue data handler and 121
 - Required 33, 34, 40, 59
 - Type 32, 106, 114, 121
 - XML data handler and 32, 40, 59

B

- BOCountSize data-handler configuration property 105
- BONameSize data-handler configuration property 105, 108
- BOPrefix data-handler configuration property 36, 96
 - createHandler() and 16, 158
 - getBOName() and 148, 162
 - Request-Response name handler and 87
 - XML name handler and 29, 81, 82
- BOPrefix XML ODA property 177, 180
- BOSelection XML ODA property 176
- BOVerbSize data-handler configuration property 105, 108
- Business object
 - converting from 7, 10, 139, 163, 165, 166
 - delimited data 116
 - fixed-width strings 108
 - name-value pairs 124
 - XML document 81
 - converting to 8, 11, 134, 160
 - delimited data 115
 - fixed-width string 107
 - input format 98
 - name-value pairs 123
 - XML document 78
 - creating 159
 - for data handler 151
 - getting name of 29, 87, 161
 - ignoring attribute of 135, 139
 - locale 153

- Business object (*continued*)
 - mixed 41, 54
 - name 82
 - populating 9, 12, 158
 - prefix 14, 158
 - regular 41, 54
 - requirements
 - Delimited data handler 113
 - FixedWidth data handler 106
 - NameValue data handler 121
 - Request-Response data handler 92
 - XML data handler 38, 51
 - returning 159, 160
 - wrapper 42, 55, 56, 65
- Business object definition
 - creating 76, 94, 174, 183
 - DTDs and 38, 50
 - from DTD 49
 - from schema document 74
 - mixed 41, 54
 - name 180
 - parent 42, 55, 56
 - regular 41, 54
 - requirements for schema document 38, 51
 - root-element 31, 39, 52, 73, 78
 - schema documents and 50, 76
 - top-level
 - Request-Response data handler 87, 93, 95
 - XML data handler 31, 39, 51, 52, 77, 79
 - wrapper 42, 55, 56, 65

C

- Cardinality attribute property
 - Delimited data handler and 114
 - FixedWidth data handler and 106
 - NameValue data handler and 121
 - XML data handler and 40, 59
- Character encoding 152, 164, 168
- Child meta-object 6, 13, 24, 149
 - Delimited data handler 112
 - FixedWidth data handler 104
 - NameValue data handler 120
 - Request-Response data handler 96
 - XML data handler 35
- ClassName data-handler configuration property 14, 15, 26, 150
 - Delimited data handler 112
 - FixedWidth data handler 105
 - NameValue data handler 120
 - Request-Response data handler 96
 - XML data handler 36
- Connector 3
 - configuring 25, 151
 - instantiating data handler 16
 - top-level meta-object 22, 23
 - use of data handlers 7
- createHandler() method 13, 17, 18, 26, 157
 - called by connector 8, 9
 - called by Server Access Interface 11, 12
 - locating a class 13, 148

- createHandler() method (*continued*)
 - with a class name 13, 15, 133
 - with a MIME type 13, 15, 133
- CustDataHandler.jar file 5, 13, 15, 148
- Custom data handler 82, 129, 152
 - adding to jar file 148
 - designing 132
 - development process 129
 - example of getBO() 134
 - example of getStreamFromBO() 146
 - example of getStringFromBO() 140
 - implementing the methods 134
 - location of 5
 - meta-objects for 133, 149
 - name handler 100, 147
 - required methods 134
 - setting up business objects for 151
 - using a stub file 133
- CwDataHandler.jar file 5, 13, 15, 21, 148
- CwXMLDataHandler.jar file 5, 13, 21
- CxBlank attribute value
 - Delimited data handler 112, 114, 117
 - FixedWidth data handler 105
 - NameValue data handler 120, 122, 125
 - XML data handler 34, 81
- CxBlank data-handler configuration property
 - Delimited data handler 112, 114, 117, 125
 - FixedWidth data handler 105, 109
 - NameValue data handler 120, 122
- CxBlankValue data-handler configuration property (deprecated) 120
- CxIgnore attribute value
 - Delimited data handler 114, 117
 - FixedWidth data handler 105, 109
 - NameValue data handler 121, 124
 - XML data handler 34, 80
- CxIgnore data-handler configuration property
 - Delimited data handler 112, 114, 117
 - FixedWidth data handler 105, 109
 - NameValue data handler 120, 121, 124

D

- Data conversion
 - from business object 7, 10, 139, 163, 166, 167
 - to business object 8, 11, 134, 159, 161
 - to byte array 163
 - to stream 166
 - to string 167
- Data handler 3
 - base 5
 - base class 133, 157
 - character encoding 164, 168
 - class for 13, 133
 - compilation script 149
 - configuration options 162, 165, 169
 - configuring 15, 21, 26, 159, 163, 166, 167
 - contexts for 6
 - customizing 5, 82, 100, 129, 152
 - development process of 129
 - IBM-delivered 4, 15
 - identifying class for 13
 - ignoring attributes 135, 139
 - in a call-triggered flow 6
 - instantiating 8, 9, 11, 12, 19, 157
 - internationalized 152, 157
 - locale 153, 164, 168

- Data handler (*continued*)
 - location of 5
 - meta-data-driven 19
 - overview 19
 - package for 14, 133
 - sample 6, 131
 - special 5
 - tracing 170
 - with connectors 7
 - with Server Access Interface 9
- Data Handler API 132
- DataHandler class 132, 157, 170
 - abstract methods 134
 - createHandler() 157
 - extending 133
 - getBO() (abstract) 158
 - getBO() (public) 160
 - getBOName() 161
 - getBooleanOption() 162
 - getByteArrayFromBO() 163
 - getEncoding() 164
 - getLocale() 164
 - getOption() 165
 - getStreamFromBO() 165
 - getStringFromBO() 166
 - package for 157
 - setConfigMOName() 167
 - setEncoding() 168
 - setLocale() 168
 - setOption() 169
 - traceWrite() 170
- DataHandler package 157
- DefaultEscapeBehavior data-handler configuration property 36, 48
- DefaultVerb data-handler configuration property
 - NameValue data handler 120
- Delimited data handler 111, 119
 - application-specific information 115
 - business object attribute properties 114
 - business object requirements 113
 - business object structure 113
 - child meta-object 112
 - configuring 112
 - converting business objects to strings 115
 - converting strings to business objects 116
 - CxBlank 112
 - CxIgnore 112
 - Delimiter 113
 - delimiter character 113
 - DummyKey 113
 - Escape 113
 - escape string 113
 - example string 117
 - features 111
 - OmitObjectEventId 113
 - overview 111
 - processing of 112
 - sample file 131
 - string requirements 116
 - with existing business objects 115
- Delimited datahandler
 - ClassName 112
- Delimiter data-handler configuration property 111, 113, 116, 117
- Development process 129, 131
- DoctypeorSchemaLocation XML ODA property 39, 53, 74, 177

- Document type definition (DTD) 38, 50
 - ANY directive 50
 - ATTLIST fragment 40, 41, 60
 - attribute properties and 32, 40
 - attributes 46, 47, 79
 - business object definition requirements 38
 - CDATA section 47, 48, 79
 - comments 49, 80
 - conditional section 50
 - creating business object definitions for 49, 76, 174, 183
 - DOCTYPE declaration 39, 48, 50, 79, 82
 - ELEMENT fragment 40
 - elements 45, 47, 79
 - entity resolver for 29, 36
 - external 50
 - FIXED attributes 39, 82
 - location of 176
 - mixed business object 41
 - namespaces 50
 - path for 36
 - PCDATA element 41, 46, 47, 80
 - preserving verbs 35
 - processing instructions 49, 79
 - regular business objects 41
 - required business object definitions 31, 39
 - root element 29, 31, 39, 77, 78, 176
 - sample 39
 - structure of business objects 31, 39
 - supported structures 50, 74
 - translating into business object definition 49
 - wrapper business object 42
- DTDPath data-handler configuration property 30, 36
- DummyKey data-handler configuration property
 - Delimited data handler 113
 - FixedWidth data handler 105
 - NameValue data handler 120
 - XML data handler 36

E

- E-Business Development Kit (EDK) 133
- Entity resolver 29, 82, 84
- EntityResolver data-handler configuration property 29, 36, 82, 84
- Escape character 113, 117
- Escape data-handler configuration property 112, 113, 117
- Escape string 113

F

- FileName XML ODA property 75, 176
- FixedWidth data handler 103, 111
 - Alignment 105
 - alignment values 103
 - application-specific information 106
 - BOCountSize 105
 - BONameSize 105
 - BOVerbSize 105
 - business object attribute properties 106
 - business object requirements 106
 - business object structure 106
 - child meta-object 104
 - ClassName 105
 - configuring 104
 - converting business objects to strings 107
 - converting strings to business objects 108

- FixedWidth data handler *(continued)*
 - CxBlank 105
 - CxIgnore 105
 - DummyKey 105
 - features 103
 - Max Length attribute property 103, 111
 - OmitObjectEventId 105
 - overview 103
 - pad character 103
 - PadCharacter 105
 - processing of 104
 - sample file 131
 - string requirements 108
 - truncation 108
 - Truncation 105
 - with existing business objects 107
- Foreign Key attribute property
 - XML data handler and 32, 33, 40, 60

G

- getBO() method 9, 12, 134
 - abstract 134, 158
 - public 146, 154, 160
- getBOName() method 146, 148, 154, 161
- getBooleanOption() method 146, 162
- getByteArrayFromBO() method 134, 139, 163
- getEncoding() method 155, 164
- getLocale() method 153, 164
- getOption() method 146, 165
- getStreamFromBO() method 134, 139, 146, 165
- getStringFromBO() method 134, 139, 140, 166

I

- IgnoreUndefinedAttributes data-handler configuration property 36
- IgnoreUndefinedElements data-handler configuration property 36
- InitialBufferSize data-handler configuration property 36

J

- Java Connector Development Kit (JCDK) 132, 133

K

- Key attribute property
 - XML data handler and 32, 33, 40, 60

L

- Locale 152, 153, 164, 168

M

- make_datahandler compilation script 149
- makeDataHandler.bat compilation script 132, 149
- MaxLength attribute property
 - Delimited data handler and 111
 - FixedWidth data handler and 103, 106, 109
- MessageFile XML ODA property 177
- Meta-object 12, 21, 25
 - child 6, 13, 14, 15, 24

- Meta-object (*continued*)
 - connector 151
 - creating 149
 - custom data handler 133, 149
 - for use by access client 22
 - for use by connectors 23
 - for use by Server Access Interface 22
 - loading 151
 - MIME type attribute 6, 21
 - setting name of 17, 18, 167
 - setting up 151
 - structure 6, 12
 - top-level 6, 12, 14, 15, 17, 22, 150, 167
 - whether to use 133

- MIME type 13, 17, 22, 158
 - naming restrictions 25, 150
 - subtype 14, 25, 37
 - text/delimited 5, 111
 - text/fixewidth 5, 103
 - text/namevalue 5, 119
 - text/requestresponse 5, 86
 - text/xml 5, 27

- MO_DataHandler_Default meta-object 17, 23
- MO_DataHandler_DefaultDelimitedConfig meta-object 25, 112
- MO_DataHandler_DefaultFixedWidthConfig meta-object 25, 104
- MO_DataHandler_DefaultNameValueCollection meta-object 25, 120
- MO_DataHandler_DefaultRequestResponseConfig meta-object 25, 96
- MO_DataHandler_DefaultXMLConfig meta-object 25, 35
- MO_Server_DataHandler meta-object 18, 22

N

- Name attribute property
 - Delimited data handler and 114
 - FixedWidth data handler and 106
 - NameValue data handler and 121
 - Request-Response data handler and 93, 94
 - XML data handler and 32
- Name handler 147, 162
 - Request-Response data handler and 87, 100
 - XML data handler and 29, 81, 82
- NameHandler class 147
- NameHandlerClass data-handler configuration property 148, 162
 - Request-Response data handler 87, 96, 100
 - XML data handler 29, 36, 82
- NameValue data handler 119, 126
 - application-specific information 122
 - business object attribute properties 121
 - business object requirements 121
 - business object structure 121
 - child meta-object 120
 - ClassName 120
 - configuring 120
 - converting business objects to strings 123
 - converting strings to business objects 124
 - CxBlank 120
 - CxIgnore 120
 - DefaultVerb 120
 - DummyKey 120
 - example file 125
 - overview 119
 - processing of 119

- NameValue data handler (*continued*)
 - sample file 131
 - SkipCxIgnore 120
 - string requirements 124
 - ValidateAttrCount 120
 - with existing business objects 123

O

- ObjectEventId attribute 76, 106, 113, 121
- OmitObjectEventId data-handler configuration property
 - Delimited data handler 113
 - FixedWidth data handler 105

P

- PadCharacter data-handler configuration property 105
- Parser data-handler configuration property 29, 36, 81

R

- Reader object 159
- Request data handler 85, 98
- Request-Response data handler 85, 101
 - BOPrefix 96
 - business object requirements 92
 - business object structure 92
 - child meta-object 96
 - ClassName 96
 - components 87
 - configuring 95
 - converting business objects to input format 98
 - converting strings to business objects 99
 - creating business object definitions for 94
 - customizing 100
 - name handler 87, 100
 - NameHandlerClass 96
 - overview 85
 - processing of 91
 - request business object 93, 95
 - RequestDataHandlerMimeType 97
 - response business object 94, 95
 - ResponseDataHandlerMimeType 97
 - top-level business object 87, 93, 95
- RequestDataHandlerMimeType data-handler configuration property 97, 99
- Required attribute property
 - XML data handler and 33, 34, 40, 59
- Response data handler 85, 99
- ResponseDataHandlerMimeType data-handler configuration property 97, 100
- Root XML ODA property 31, 176

S

- SAX parser 29, 36, 81
- Schema document 50, 76
 - all group 56, 74
 - any element 74
 - anyAttribute element 74, 181
 - attribute properties and 59
 - attributeFormDefault 66, 71
 - attributes 71, 72, 79
 - business object definition requirements 51
 - choice group 56, 74

Schema document (*continued*)

- comments 72, 80
- complex types 54, 68, 69, 75
- creating business object definitions for 74, 76, 174, 183
- default namespace 65, 66
- elementFormDefault 66, 68
- elements 41, 54, 68, 69, 72, 79
- entity resolver for 29
- form attribute 68, 71
- import element 62, 75
- include element 75
- mixed business object 54
- namespaces 60
- occurrence indicator 59
- processing instructions 72, 79
- regular business object 54
- required business object definitions 31, 52
- required element 75
- root element 29, 31, 51, 52, 77, 78, 176
- sample 51
- schema element 52
- schema locations 30, 52, 72, 176, 177
- sequence group 54, 74
- simple elements 69
- simple types 69
- structure of business objects 51
- target namespace 61
- targetNamespace 61
- use attribute 60
- wrapper business object 56, 65
- xmlns attribute 65

Server Access Interface

- getBO() and 159
- IcreateBusinessObjectFrom() 12, 18
- instantiating data handler 17
- ItoExternalForm() 11, 18
- top-level meta-object 22
- use of data handlers 9

- setConfigMOName() method 17, 167
- setEncoding() method 155, 168
- setLocale() method 153, 168
- setOption() method 146, 169
- setupOptions() method 15, 158, 159, 163, 166, 167
- SkipCxiIgnore data-handler configuration property 120, 122
- StubDataHandler.java file 132, 133, 134

T

- Top-level meta-object 6, 12, 17, 150, 167
- TopLevel XML ODA property 176, 180
- Trace message 170
- TraceFileName XML ODA property 177
- TraceLevel XML ODA property 177
- traceWrite() method 147, 170
- Truncation data-handler configuration property 104, 105, 108
- Type attribute property
 - Delimited data handler and 114
 - FixedWidth data handler and 106
 - NameValue data handler and 121
 - XML data handler and 32
- TypeSubstitution XML ODA property 75

U

- UseNewLine data-handler configuration property 37

V

- ValidateAttrCount data-handler configuration property 120, 123, 124, 126
- Validation data-handler configuration property 29, 37
- Verb (preserving in XML) 35, 81

X

- XML data handler 27, 84
 - application-specific information 41
 - attr_fd 67, 71
 - attr_name 45, 46, 67
 - attr_ns 67
 - cw_mo_label 79, 80, 82, 139
 - elem_fd 67, 68
 - elem_name 45, 67, 68, 69
 - elem_ns 67
 - escape 36, 48
 - escape=true 45, 47, 67, 80
 - notag 45, 47, 69, 70, 79, 80
 - type=attr_name 71
 - type=attribute 45, 46, 47, 67, 71, 79
 - type=cdata 45, 47, 48, 79
 - type=comment 45, 49, 67, 72, 80
 - type=defaultNS 61
 - type=doctype 45, 48, 79
 - type=MIXED 42, 55
 - type=pcdata 44, 45, 46, 47, 67, 69, 79
 - type=pi 45, 49, 67, 72
 - type=xmlns 61
 - type=xsinoNSlocation 67, 73
 - type=xsischemalocation 67, 73
 - xsinoNSlocation 80
 - xsinoschemalocation 80
 - attribute-level application-specific information 44, 67
 - BOPrefix 36
 - business object attribute properties 32, 40, 59
 - business object structure 31, 39, 51
 - business-object-level application-specific information 41, 60
 - child meta-object 35
 - ClassName 36
 - components 28
 - configuring 35
 - converting business objects 78
 - converting XML documents 81
 - customizing 82
 - DefaultEscapeBehavior 36
 - DTDPath 36
 - DummyKey 36
 - entity resolver 29, 84
 - EntityResolver 36
 - escape processing 36, 47, 80
 - IgnoreUndefinedAttributes 36
 - IgnoreUndefinedElements 36
 - InitialBufferSize 36
 - location of 5
 - name handler 29, 81, 82, 162
 - NameHandlerClass 36
 - overview 27
 - Parser 36
 - processing of 27
 - Reader object restrictions 159
 - SAX parser 29
 - UseNewLine 37
 - Validation 37

- XML data handler (*continued*)
 - verb conversion 35, 81
- XML document 27
 - attributes 31, 46, 71
 - CDATA section 47, 48, 79
 - comments 49, 72, 80
 - converting to business object 81
 - escape processing 47, 72
 - external references 29, 82
 - noNamespaceSchemaLocation 73, 80
 - parsing 81
 - processing instruction 49
 - prolog 48, 49, 50
 - requirements 81
 - root element 176
 - schemaLocation 52, 72, 80
- XML Object Discovery Agent (ODA) 171, 184
 - BOPrefix 177
 - BOSelection 176
 - configuration properties 175
 - DoctypeorSchemaLocation 74, 177
 - FileName 75, 176
 - installing 171
 - launching 172
 - MessageFile 177
 - multiple instances 173
 - properties 176
 - Root 176
 - TopLevel 176
 - TraceFileName 177
 - TraceLevel 177
 - TypeSubstitution 75
- XML Schema Instance Namespace 61, 72, 177
- XML Schema Namespace 61



Printed in USA