



# **SHADOW MAINFRAME ADAPTER CLIENT FOR DB2**

**SHADOW MAINFRAME ADAPTER SERVER ADMINISTRATION  
SHADOW INTERFACE FOR DB2 ADMINISTRATION**

***POWERED BY***  
***SHADOW***

Date: January, 2004

This document is published by the NEON Systems, Inc. Technical Publications Department and applies to Shadow Mainframe Adapter Client for DB2.

Copyright © 1994-2003 NEON Systems, Inc. All rights reserved. Printed in the U.S.A.

Licensee is granted permission to make a limited number of copies of the documentation for its internal business purposes only. All such copies shall bear all copyright, trade secret, trademark and any other intellectual property notices on the original copies. This limited right to reproduce for internal purposes only is not transferable. Furthermore, this limited right DOES NOT include any license to distribute, modify, display or make derivative works from the Copyrighted materials.

NEON, Shadow, Shadow Direct, and Enterprise Direct are registered trademarks, and the NEON logo, Shadow Activity Monitor, Shadow Advanced Controls, Shadow Advanced Scalability, Shadow AutoHTML, Shadow Mainframe Adapter Client, Shadow Enterprise Auditing, Shadow Enterprise Direct, Shadow Enterprise Transactions, Shadow Event Facility, Shadow Enterprise Transactions, Shadow Interface, Shadow JDBC Adapter, Shadow MDI Replacement Module, Shadow REXX/Tools, Shadow Mainframe Adapter Server, Shadow SSL Support Module, Shadow Support Module, Shadow Web Interface, and Shadow Web Server are trademarks of NEON Systems, Inc. in the USA and in other select countries.

The symbols ® and ™ denote USA trademark rights.

All other trademarks are the property of their respective owners.

Throughout this publication, NEON Systems, Inc. is also, for convenience, referred to as "NEON." The Reader should not presume that such use of NEON conflicts with the use of NEON as a registered trademark associated with certain products of NEON Systems, Inc.

This software/documentation contains proprietary information of NEON Systems, Inc.; it is provided under a license agreement containing restrictions on use and disclosure and is also protected by copyright law. Reverse engineering of the software is prohibited.

If this software/documentation is delivered to any U.S. Government Agency, then it is delivered with Restricted Rights and the following legend is applicable:

#### **Restricted Rights Legend**

Use, duplication, or disclosure by the U.S. Government is subject to restrictions set forth in FAR Section 52.227-14 (June 1987) Alt. III(g)(3)(June 1987), FAR Section 52.227-19 (June 1987), or sub-clause (c)(1)(ii) of Rights in Technical Data and Computer Software clause at DFARS 252.227-7013, as applicable.  
Contractor is NEON Systems, Inc. 14100 Southwest Freeway, Suite 500, Sugar Land, Texas 77478.

NEON Systems, Inc. does not warrant that this document is error-free. The information in this document is subject to change without notice and does not represent a commitment on the part of NEON Systems, Inc. No part of this document may be reproduced or transmitted in any form or by any means, electronic or mechanical, including photocopying and recording, for any purpose without the express written permission of an authorized representative of NEON Systems, Inc.

Address inquiries to:

**NEON Systems, Inc.**

14100 SW Freeway, Suite 500  
Sugar Land, Texas 77478

World Wide Web: <http://www.neonsys.com>

Phone: 1-800-505-6366  
(281) 491-4200 (Corporate Sales, Customer Support)  
Fax: (281) 242-3880



# Contents

---

## Part I: Introduction

### Chapter 1: Introduction:

<b>Shadow Mainframe Adapter Client for DB2</b> .....	1-1
Overview .....	1-1
Shadow .....	1-1
Shadow Mainframe Adapter Client for DB2 .....	1-2

## Part II: Shadow Mainframe Adapter Server Administration

### Chapter 2: Shadow Mainframe Adapter Server:

<b>ISPF vs Web Interface</b> .....	2-1
Overview .....	2-1
Shadow Mainframe Adapter Server ISPF (ISPF/SDF) Application .....	2-1
Shadow Mainframe Adapter Server Primary Option Menu .....	2-2
Invoking Shadow ISPF .....	2-3
ISPF/SDF Basics .....	2-4
The Shadow Web Interface (SWI) .....	2-10
Preparation .....	2-11
Logging On .....	2-12
The Home Page .....	2-13
Security Features .....	2-19

### Chapter 3: Shadow Mainframe Adapter Server: Control

Overview .....	3-1
Shadow Mainframe Adapter Server Control Option Menu .....	3-1
Option 1: Setting the ISPF Session Parameters .....	3-3
Option 3: Displaying Control Block Information .....	3-4
Option 4: Displaying Product Statistics .....	3-7
Option 6: Displaying Product Module Information .....	3-8
Option 7: Displaying Product Task Information .....	3-11
Option 11: Displaying RPC Load Module Information .....	3-14
Option 12: Displaying Product Information for Each Shadow Copy in Use .....	3-16
Option 13: Displaying Product Storage Information .....	3-20
Option 19: Displaying National Language Support Tables .....	3-39

### Chapter 4: Shadow Mainframe Adapter Server: Communications

Overview .....	4-1
Remote Users Application .....	4-1
Link Control Application .....	4-1

---

Remote Users Application .....	4-2
Available Commands .....	4-2
Column Names .....	4-3
Invoking the Remote Users Application .....	4-5
Using the Kill Command to Terminate a User Connection .....	4-6
Link Control Application .....	4-7
Available Commands .....	4-7
Column Names .....	4-8
Invoking the Link Control Application .....	4-9
<b>Chapter 5: Shadow Mainframe Adapter Server: Database Control .....</b>	<b>5-1</b>
Overview .....	5-1
Database Control Application .....	5-1
Option 1: Displaying and Controlling the Database Table .....	5-2
Option 2: Displaying Shadow Mainframe Adapter Server Performance Data .....	5-4
<b>Chapter 6: Shadow Mainframe Adapter Server: Tracing and Troubleshooting .....</b>	<b>6-1</b>
Overview .....	6-1
Trace Browse .....	6-1
Trace Browse Archival Facility .....	6-2
SQL Trace .....	6-3
Trace Browse .....	6-3
Invoking Trace Browse .....	6-3
Setting Up a Trace Browse Profile .....	6-5
Using the Refresh Mode .....	6-13
Using the Valid Trace Browse Commands and Operands .....	6-14
Using Row Information Commands .....	6-34
Understanding the Order of Trace Browse Events .....	6-35
Printing Trace Browse Information .....	6-36
The Trace Browse Archival Facility .....	6-36
Backups .....	6-37
Configuring the Shadow Trace Browse Archival Facility .....	6-39
Using the Trace Browse Archival Facility .....	6-42
Using Trace Browse Archival Commands .....	6-45
SQL Trace .....	6-47
Available Commands .....	6-47
Column Names .....	6-48
Invoking SQL Trace .....	6-51
<b>Chapter 7: Shadow Mainframe Adapter Server: Data Mapping Facility (DMF) .....</b>	<b>7-1</b>
Overview .....	7-1
How it Works .....	7-2

Restrictions . . . . .	7-2
Recommendations . . . . .	7-3
Specifying an ISPF Library or Dataset . . . . .	7-3
ISPF Libraries . . . . .	7-3
Other Partitioned Datasets . . . . .	7-4
Packed Datasets . . . . .	7-6
The Shadow Mainframe Adapter Server Mapping Library . . . . .	7-6
Using the Data Mapping Checklist . . . . .	7-6
Data Mapping Options . . . . .	7-7
Setting Up a Map Default . . . . .	7-7
Performing a Map Extract . . . . .	7-9
Displaying a Map . . . . .	7-11
Copying a Map . . . . .	7-14
Refreshing a Map . . . . .	7-16
Generating an RPC . . . . .	7-16
Merging Maps . . . . .	7-20
Generating a Stored Procedure from Maps . . . . .	7-21
Generating HTML from Maps . . . . .	7-22
Using Data Maps in Mainframe Adapter Client Programs . . . . .	7-25

**Chapter 8: Shadow Mainframe Adapter Server:**

**Managing System Resources . . . . . 8-1**

Shadow DVIPA Support . . . . .	8-1
Using 40K Block Fetch . . . . .	8-1
Queries Eligible for Block Fetch . . . . .	8-2
Enabling 40K Block Fetch . . . . .	8-3
Using CPU Time Limits . . . . .	8-3
Setting a CPU Time Limit for Shadow Mainframe Adapter Clients . . . . .	8-3
Setting a CPU Time Limit for All Mainframe Adapter Clients . . . . .	8-5
Using Wait Time for All Mainframe Adapter Clients . . . . .	8-7
Enabling the External Wait Time Limit . . . . .	8-8
Disabling the External Wait Time Limit Mechanism . . . . .	8-8
Detecting Session Failures . . . . .	8-8
Enabling Session Failure Detection . . . . .	8-9
Setting the Dispatch Priority . . . . .	8-9
Enabling Dispatch Priority . . . . .	8-9
Other System Resource Features . . . . .	8-10

**Chapter 9: Shadow Mainframe Adapter Server:**

**Using Work Load Manager Support . . . . . 9-1**

Overview . . . . .	9-1
Enclaves . . . . .	9-2
WLM Classification of Shadow Transactions . . . . .	9-2
Step 1: Create or Select Service Class Definitions . . . . .	9-3

Step 2: Create Shadow Mainframe Adapter Server Classification Rules . . . . .	9-4
Step 3: Define Service Class Definitions for Shadow Subtasks . . . . .	9-6
Step 4: Enable WLM Support within Shadow Mainframe Adapter Server . . . . .	9-6
Step 5: Verify Proper WLM Classification . . . . .	9-8
Running in WLM Compat Mode . . . . .	9-9
<b>Chapter 10: Shadow Mainframe Adapter Server:</b>	
<b>Enterprise Auditing . . . . .</b>	<b>10-1</b>
Support Overview . . . . .	10-1
Implementation . . . . .	10-1
Key Features . . . . .	10-2
Key Benefits . . . . .	10-3
Prerequisites . . . . .	10-3
Creating an OS/390 or z/OS Security Environment . . . . .	10-3
Prerequisites. . . . .	10-4
Caching the OS/390 or z/OS Security Environment . . . . .	10-4
Security Considerations. . . . .	10-4
Using Generic and Extended IDs . . . . .	10-5
Mainframe Adapter Client Side Support. . . . .	10-6
Host Side Support . . . . .	10-7
<b>Chapter 11: Shadow Mainframe Adapter Server: Supported SMF Fields . . . . .</b>	<b>11-1</b>
Enabling SMF Support. . . . .	11-1
Units of Time . . . . .	11-1
SMF Record Types . . . . .	11-2
SMF Type 01 Records. . . . .	11-3
SMF Type 02 Records. . . . .	11-5
SMF Type 03 Records. . . . .	11-7
SMF Type 04 Records. . . . .	11-8
SMF Type 06 Records. . . . .	11-11
SMF Type 09 Records. . . . .	11-12
SMF Type 10 Records. . . . .	11-13
SMF Type 11 Records. . . . .	11-15
SMF Type 13 Records. . . . .	11-17
SMF Type 14 Records. . . . .	11-18
SMF Type 15 Records. . . . .	11-20
SMF Type 16 Records. . . . .	11-21
SMF Type 17 Records. . . . .	11-23
<b>Chapter 12: Shadow Mainframe Adapter Server:</b>	
<b>Limiting Number of Shadow Connections . . . . .</b>	<b>12-1</b>
Overview . . . . .	12-1
Rejecting Connections . . . . .	12-1
Placing Connections in a Queue . . . . .	12-2

---

<b>Chapter 13: Shadow Mainframe Adapter Server: Disaster Recovery</b>	13-1
Overview	13-1
Disabling the Warning Message Prompt	13-1
Disabling All Mainframe Adapter Client Prompts	13-2
Deleting the Host Connection Text String	13-2
Requesting a Temporary License Code	13-5
<b>Chapter 14: Shadow Mainframe Adapter Server: Monitoring Mainframe Adapter Client Response Time</b>	14-1
Overview	14-1
Enabling Mainframe Adapter Client Response Time Monitoring	14-2
Step 1: Setting the Product Parameter	14-2
Step 2: Creating the Definitions	14-2
Step 3: Restarting Shadow Mainframe Adapter Server	14-3
Viewing Mainframe Adapter Client Response Time Information	14-3
SMF Recording	14-3

## Part III: Shadow Interface for DB2 Administration

<b>Chapter 15: Shadow Interface for DB2: Using DB2 Stored Procedures</b>	15-1
Using a DB2 Stored Procedure to Access z/OS Data	15-1
Prerequisites	15-1
Preparing a DB2 Stored Procedure	15-2
Invoking a Stored Procedure	15-3
Returning Results Sets	15-3
Using SET CURRENT PATH	15-5
Troubleshooting DB2 Stored Procedures	15-6
Samples	15-6
<b>Chapter 16: Shadow Interface for DB2: Shadow Enterprise Transactions (Two-Phase Commit)</b>	16-1
Overview	16-1
RRMS and the Two-Phase Commit	16-2
Prerequisites	16-2
System Requirements	16-3
Environment Requirements	16-3
Choosing an Attachment Facility	16-3
Enabling Two-Phase Commit	16-4
Shadow Interface for DB2	16-4
Shadow Mainframe Adapter Server	16-4
Shadow Mainframe Adapter Client	16-8
Monitoring and Controlling RRS Transactions	16-8
Displaying Resource Manager Information	16-9

Displaying Information on Active Transactions . . . . .	16-12
Displaying information on Indoubt Transactions . . . . .	16-15
Displaying Recovery Table Information . . . . .	16-19
Displaying RRS Units of Recovery Information . . . . .	16-22
Running RRS . . . . .	16-26

## Part IV: Shadow Mainframe Adapter Client for DB2: Appendixes

### Appendix L: Shadow Mainframe Adapter Server:

<b>Started Task Parameters</b> . . . . .	A-1
Introduction . . . . .	A-1
Available Commands . . . . .	A-1
Viewing Details about a Parameter . . . . .	A-2
Modifying a Started Task Parameter . . . . .	A-8
Shadow Started Task Parameters . . . . .	A-15
PRODADABAS . . . . .	A-16
PRODAPPCMVS . . . . .	A-19
PRODBROWSE . . . . .	A-26
PRODCICS . . . . .	A-30
PRODCOMM . . . . .	A-34
PRODEVENT . . . . .	A-46
PRODFILE . . . . .	A-47
PRODGLV . . . . .	A-54
PRODIMS . . . . .	A-57
PRODLICENSE . . . . .	A-60
PRODLOGGING . . . . .	A-61
PRODMMSGQ . . . . .	A-68
PRODPARM . . . . .	A-73
PRODREXX . . . . .	A-88
PRODRPC . . . . .	A-89
PRODRRS . . . . .	A-98
PRODSECURITY . . . . .	A-100
PRODSEF . . . . .	A-114
PRODSQL . . . . .	A-117
PRODSTOR . . . . .	A-127
PRODTOKEN . . . . .	A-133
PRODTRACE . . . . .	A-135
PRODWLM . . . . .	A-153
Obsolete . . . . .	A-157



# About this Publication

---

This book contains user documentation for Shadow Mainframe Adapter Server and the Shadow Mainframe Adapter Client for DB2, both Mainframe Adapter Server components of the Shadow product.

## How this Publication Is Organized

This book contains the following chapters:

### Part I: Introduction

- Chapter 1, “Introduction: Shadow Mainframe Adapter Client for DB2,” provides a brief overview of the Shadow Mainframe Adapter Client product.

### Part II: Shadow Mainframe Adapter Server Administration

- Chapter 2, “Shadow Mainframe Adapter Server: ISPF vs Web Interface,” covers the Shadow ISPF application and the Shadow Web Interface, both of which are tools for administering Shadow Mainframe Adapter Server.
- Chapter 3, “Shadow Mainframe Adapter Server: Control,” provides information for viewing and modifying Shadow Mainframe Adapter Server product data.
- Chapter 4, “Shadow Mainframe Adapter Server: Communications,” describes how to access the information provided by the Remote Users application and the Link Control application by means of the Shadow ISPF panels or the Shadow Web Interface screens.
- Chapter 5, “Shadow Mainframe Adapter Server: Database Control,” covers the Database Control application, which allows you to view and modify the Shadow Mainframe Adapter Server Database table, as well as display performance data.
- Chapter 6, “Shadow Mainframe Adapter Server: Tracing and Troubleshooting,” covers the diagnostic tools designed to record critical events in the life of each Shadow individual transaction process. This internal information can be used to debug and correct problems within the Shadow itself.
- Chapter 7, “Shadow Mainframe Adapter Server: Data Mapping Facility (DMF),” covers the Shadow Data Mapping Facility, which can be used with the Shadow Interfaces for IMS/TM, CICS/TS, VSAM, or ADABAS, to format result sets.

- 
- Chapter 8, “Shadow Mainframe Adapter Server: Managing System Resources,” describes the scalability features offered by Shadow to maximize host/Mainframe Adapter Client throughput and minimize response time, regardless of the number of users.
  - Chapter 9, “Shadow Mainframe Adapter Server: Using Work Load Manager Support,” describes the Work Load Manager (WLM) support offered by Shadow .
  - Chapter 10, “Shadow Mainframe Adapter Server: Enterprise Auditing,” covers Enterprise Auditing (Transaction Level Security), a feature of Shadow Mainframe Adapter Server, the Mainframe Adapter Server component of the Shadow product.
  - Chapter 11, “Shadow Mainframe Adapter Server: Supported SMF Fields,” covers Shadow supported SMF fields. This support provides a means for gathering and recording information used to evaluate system usage.
  - Chapter 12, “Shadow Mainframe Adapter Server: Limiting Number of Shadow Connections,” covers the methods for limiting the number of users connecting to the Shadow Mainframe Adapter Server.
  - Chapter 13, “Shadow Mainframe Adapter Server: Disaster Recovery,” describes the disaster recovery ability of Shadow.
  - Chapter 14, “Shadow Mainframe Adapter Server: Monitoring Mainframe Adapter Client Response Time,” covers the Mainframe Adapter Client response time monitoring features of Shadow .

### **Part III: Shadow Interface for DB2 Administration**

- Chapter 15, “Shadow Interface for DB2: Using DB2 Stored Procedures,” guides you through the process of using DB2 stored procedures to access z/OS data, a feature of the Shadow Mainframe Adapter Server, the Mainframe Adapter Server component of the ShadowConnect product.
- Chapter 16, “Shadow Interface for DB2: Shadow Enterprise Transactions (Two-Phase Commit),” provides information for using Shadow Enterprise Transactions (two-phase commit), a licensed feature of Shadow Mainframe Adapter Server, the Mainframe Adapter Server component of the Shadow product.

### **Part IV: Shadow Mainframe Adapter Client for DB2: Appendixes**

- Appendix A, “Shadow Mainframe Adapter Server: Started Task Parameters,” shows you how to view parameters, modify a started task parameter, and provides details about each started task parameter.

---

## Reader's Comments

Please e-mail any comments or questions you have about our documentation to [support@neonsys.com](mailto:support@neonsys.com).

Thank you!

---

# Introduction

---



# CHAPTER 1: **Introduction: Shadow Mainframe Adapter Client for DB2**

---

This chapter gives a general introduction to the Shadow Mainframe Adapter Client for DB2, a component for the Shadow product.

Topics include:

- Overview
  - Shadow
  - Shadow Mainframe Adapter Client for DB2

## **Overview**

### **Shadow**

Organizations that view investment in integration software on a project-by-project basis can license Shadow via its Shadow packaging option. ShadowConnect focuses on the Application Server or Integration Server connectivity requirement and provides cost-effective licensing options that fit the project model perfectly.

Shadow is an efficient, easy-to-use, and flexible solution for integrating mainframe data sources and transaction environments to Mainframe Adapter Client/Mainframe Adapter Server and n-tier environments. The unique Shadow architecture provides maximum flexibility with minimal impact on CPU cycles.

Shadow Mainframe Adapter Client for DB2 consists of:

- Shadow Mainframe Adapter Server
- Shadow Mainframe Adapter Client
- Shadow Interface for DB2

Key Features of Shadow include:

#### **On the Mainframe Adapter Server Side:**

- Provides native access to ADABAS, CICS, DB2, IMS/DB, IMS/TM, Natural, and VSAM from a single tool.
- Eliminates the need for a mid-tier gateway.
- Installs in less than one day.

- Incorporates centralized online monitoring, control, and diagnostic capabilities.

**On the Mainframe Adapter Client Side:**

- Provides Connect applications with an ODBC, JDBC, and J2CA API.
- Performs data and SQL dialect conversions, dynamic-to-static SQL conversions, data compression, and network optimization in conjunction with the Shadow Mainframe Adapter Server.

## ***Shadow Mainframe Adapter Client for DB2***

Shadow Mainframe Adapter Client for DB2 offers access to DB2-z/OS data and transactions, providing the maximum performance needed to integrate DB2 data and stored procedures with distributed or Web applications without custom coding, or sacrificing flexibility, reliability, and security. In addition, one Shadow Mainframe Adapter Server can access many DB2 subsystems.

This connector enables Java applications to integrate z/OS data and transactional sources through the JDBC API. Shadow Mainframe Adapter Client is configurable and takes advantage of Java capabilities including multi-threading, connection pooling, and batch updates. Shadow Mainframe Adapter Client is JDBC 2.0 compliant and supports JDK 1.1.x, JDK 1.2.3 (J2EE) and Java servlets. It runs on a growing range of platforms including HP-UX, Sun Solaris, IBM AIX, SCO Unix, USS, Linux, and Windows.



Shadow Mainframe Adapter  
Server Administration

---



*CHAPTER 2:*

# **Shadow Mainframe Adapter Server: ISPF vs Web Interface**

---

---

This chapter covers the Shadow ISPF application and the Shadow Web Interface, both of which are tools installed with Shadow Mainframe Adapter Server, the Mainframe Adapter Server component of the Shadow product.

Topics include:

- Overview
- Shadow Mainframe Adapter Server ISPF (ISPF/SDF) Application
  - Shadow Mainframe Adapter Server Primary Option Menu
  - Invoking Shadow ISPF
  - ISPF/SDF Basics
- The Shadow Web Interface (SWI)
  - Preparation
  - Logging On
  - The Home Page
  - Security Features

## **Overview**

The Shadow Mainframe Adapter Server ISPF application and the Shadow Web Interface are both tools for administering Shadow Mainframe Adapter Server. The ISPF application is an interactive control application, consisting of panels for verifying procedures and diagnosing problems, as well as monitoring and controlling the local copy of Shadow Mainframe Adapter Server. Most all functions that can be performed with the ISPF application can also be performed with the Shadow Web Interface, which is a Graphical User Interface (GUI).

## **Shadow Mainframe Adapter Server ISPF (ISPF/SDF) Application**

The Shadow ISPF application can be used by the following individuals:

- **Application Programmers** to debug SQL-based programs.
- **System Operators** to monitor and control the local copy of SDB.
- **System Programmers** to verify installation procedures and to diagnose application problems.

## Shadow Mainframe Adapter Server Primary Option Menu

The main panel for the Shadow ISPF application is the **Shadow Mainframe Adapter Server Primary Option Menu** (see Figure 2–1). From this menu, you can select any Shadow Mainframe Adapter Server application, or you can choose the on-line tutorial.



### Note:

Most ISPF/SDF applications will not work unless Shadow Mainframe Adapter Server is up and running. If you attempt to use one of the applications that requires the services of the Shadow Mainframe Adapter Server, an error message will be displayed.

```

----- Shadow Mainframe Adapter Server Primary Option Menu -----
-----
Option ===>

  1 LINK          - Display and control link table           Date: xx/xx/xxxx
  2 IMS          - IMS Control Facility                     Time: xx:xx
  3 CICS         - CICS Control Facility                   Version: xx.xx.xxxx
  4 REMOTE USER - Display and control remote users         SSID: SDBx
  5 SDB CONTROL  - Control Shadow Mainframe Adapter Server
  6 TRACE BROWSE - Browse Shadow Mainframe Adapter Server trace log
  7 SEF CONTROL  - Control Shadow Event Facility (SEF)
  8 DATABASES    - Monitor and control database access
 10 DATA MAPPING - Data Mapping Facility
 11 ACI          - Advanced Communications Interface
 13 PUBLISH     - Event Publisher
  D DEBUG       - Debugging Facilities
 S SUPPORT      - Display Shadow Mainframe Adapter Server Support Information
 T TUTORIAL     - Display information about Shadow Mainframe Adapter Server

```

**Figure 2–1. Shadow Mainframe Adapter Server Primary Option Menu**

More information about each of the options can be found as indicated in Table 2–1.



### Note:

The information in the upper right hand corner of the panel includes the Date, Time, Version Number (of the product) and the ID of the Shadow Subsystem to which you are currently connected. The last four digits of the Version Number indicates the maintenance level (or SVFX number) of the tape you are currently running.

**Table 2–1. Shadow Mainframe Adapter Server Primary Option Menu -- Finding More Information**

Option	Documentation Reference
1 LINK	See Chapter 4, “Shadow Mainframe Adapter Server: Communications.”
2 IMS	See the following: <ul style="list-style-type: none"> <li>Shadow Mainframe Adapter Client for IMS/DB documentation.</li> <li>Shadow Mainframe Adapter Client for IMS/TM documentation.</li> </ul>
3 CICS	See the Shadow Mainframe Adapter Client for CICS/TS documentation.
4 REMOTE USER	See Chapter 4, “Shadow Mainframe Adapter Server: Communications.”
5 SDB CONTROL	See Chapter 3, “Shadow Mainframe Adapter Server: Control.”
6 TRACE BROWSE	See Chapter 6, “Shadow Mainframe Adapter Server: Tracing and Troubleshooting.”
7 SEF CONTROL	Not applicable.
8 DATABASES	See Chapter 5, “Shadow Mainframe Adapter Server: Database Control.”
10 DATA MAPPING	See Chapter 7, “Shadow Mainframe Adapter Server: Data Mapping Facility (DMF).”
11 ACI	See the Shadow Mainframe Adapter Client for Natural documentation.
13 PUBLISH	See the Shadow Event Publisher User Documentation

## Invoking Shadow ISPF

Invoke ISPF/SDF with the Shadow REXX/EXEC (located in the NEON.SV040800.EXEC(FB) dataset). The syntax is as follows:

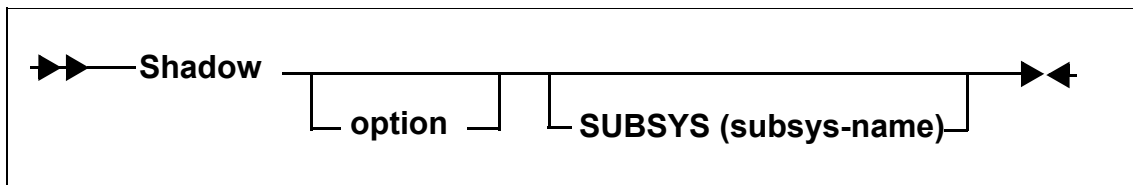

Where:

**option** Specifies one of the valid options on the **Shadow Mainframe Adapter Server Primary Option Menu** (Figure 2–1). The Shadow

REXX/EXEC must be invoked from within ISPF or modified in order to run from the TSO **Ready** prompt.

**SUBSYS** Specifies the 4-character subsystem name of the copy of Shadow Mainframe Adapter Server to use. All ISPF/SDF applications communicate with the specified subsystem. The default value is SDBB.



**Note:**

While you are in the ISPF/SDF application, you can modify the subsystem name using the Shadow Mainframe Adapter Server ISPF Session Parameters application (see the *Shadow Mainframe Adapter Server Started Task Parameter Reference*).

The SDF application is run under the ISPF applid of SDB, permitting the user to customize options, such as PF keys, just for the SDF application.

## ***ISPF/SDF Basics***

For the most part, the Shadow ISPF/SDF application works like any ISPF application. If you are already familiar with other ISPF-based applications, you are prepared to use ISPF/SDF. If not, you may want to read the following paragraphs to acquaint yourself with ISPF's general features.

### **Types of Commands**

ISPF/SDF applications utilize two types of commands:

- Display commands
- System control commands

#### ***Display Commands***

The display commands are used to control the display of data (for example, the **UP** and **DOWN** scrolling commands are display commands).

#### ***System Control Commands***

The system control commands are application specific. They are used to change the system's operating status.

### **Shadow Mainframe Adapter Server Primary Commands**

All panels have an **Option** or **Command** field in the upper left-hand corner, as shown in Figure 2-2.

```
----- Shadow Mainframe Adapter Server Primary Option Menu -----
-----
Option ==>
```

**Figure 2–2. Shadow Mainframe Adapter Server Option/Command Field**

You can enter primary commands in this field by typing in the command name (sometimes called the command verb) and pressing ENTER. For instance, to use the **HELP** command, type the following:

```
Option ==> HELP
```

You can issue any ISPF built-in command from the command field of any ISPF/SDF application. The most commonly used primary commands are the following:

#### **HELP**

Invokes the on-line tutorial. The help is context-sensitive. For example, if you are in the Link application, you will get help on controlling links.

#### **END**

Causes the current display to be abandoned, and returns you to the previous panel. It is also used to terminate the tutorial.

#### **RETURN**

Returns control to the **Shadow Mainframe Adapter Server Primary Option Menu**.

#### **SPLIT**

Causes the display to be split into two logical displays. The split occurs on whatever line the cursor is currently positioned.

#### **KEYS**

Displays the current PF key settings and allows you to change them.

#### **PFSHOW**

Displays the current PF key settings at the bottom of the panel. You cannot modify PF key settings using **PFSHOW**.

#### **PRINT**

Records the current panel image in the ISPF list file, which can later be printed.

Commands can also be associated with PF keys (see the **KEYS** command description, above), in which case the command is executed by pressing the appropriate PF key. If you want to associate a command with a PF key that accepts operands you must:

1. Enter the operand in the **Option** field. Examples of operands include **UP**, **DOWN**, and **SPLIT** commands.
2. Press the PF key you want associated with the command. ISPF will automatically concatenate the command verb with the operands and simulate the pressing of the ENTER key.

## Using the ISPF Jump Function

ISPF/SDF supports the use of the ISPF “jump” function. You can jump directly to one application from another (without backing up through menus) by entering an equals (=) sign followed by a valid option specification. For example, the command will take you directly to the SDB Task Parameters application (option 5, sub-option 2).

```
COMMAND ==> =5.2
```

## Scrolling Data with UP and DOWN

Some displays present data in a scrollable format. To see data that is logically “below” the data on panel, use the **DOWN** command. To see data that is logically “above” the data on panel, use the **UP** command.

The action of both the **UP** and **DOWN** commands can be modified by entering operands following the command verb. These operands are as follows:

<b>n</b>	Scrolls the display the specified number of lines.
<b>PAGE</b>	Scrolls a whole panel full of data.
<b>MAX</b>	Scrolls the display to the top or the bottom of the data.
<b>CSR</b>	Scrolls the display to the current cursor position. If the command is <b>UP</b> , the line with the cursor is scrolled to the bottom of the display. If the command is <b>DOWN</b> , the line with the cursor is scrolled to the top of the display.

The scroll field on most scrollable displays can be used to modify the scrolling action. To change the scroll amount, tab to the scroll field (it is marked with the word **Scroll**) and type in one of the scroll operands listed above. The scroll amount will be saved between sessions. Figure 2–3 shows the scroll option for “PAGE”.



```

----- ISPF PARAMETER OPTIONS -----
----- Keylist Utility -----
|  File   View  |
|-----|
|  Keylist Utility for SDB  |
| Command ===>                Scroll ===> PAGE |
| Actions: N=New   E=Edit   V=View   D=Delete   /=None |
|  Keylist   Type  |
|-----|

```

**Figure 2–3. Scroll Options**

You can optionally set PF keys to issue scrolling commands; however, in applications where scrolling is possible, the PF keys are usually set up to contain the following:

- F8 and F20 for the **DOWN** command
- F7 and F19 for the **UP** command.

You can use the **KEYS** command to view and/or change the PF key default settings (see Figure 2–4).

```

PF Key Definitions and Labels - Primary Keys
Command ===>
Number of PF Keys . . . 24                Terminal type . . 3278
Enter "/" to select . .                  (Enable EURO sign)

PF1 . . . HELP
PF2 . . . SPLIT
PF3 . . . END
PF4 . . . RETURN
PF5 . . . RFIND
PF6 . . . RCHANGE
PF7 . . . UP
PF8 . . . DOWN
PF9 . . . SWAP
PF10 . . LEFT
PF11 . . RIGHT
PF12 . . RETRIEVE

PF1 label . .          PF2 label . .          PF3 label . .
PF4 label . .          PF5 label . .          PF6 label . .
PF7 label . .          PF8 label . .          PF9 label . .
PF10 label . .         PF11 label . .         PF12 label . .

Press ENTER key to display alternate keys. Enter END command to exit.

```

**Figure 2–4. PF Keys Option**

## Sorting Data

Some of the scrollable applications support the sorting and locating of data. The **Sort** command is a primary command that sorts the columns of a display. The syntax of the **Sort** command is as follows:



Where:

### **sort-field-name**

Specifies the 1-to-8 character identifier for the column to be sorted. Note that this name is not always the same as the column name. (The sort names are documented with each application's column names.)

**A** Indicates that the column is to be sorted in ascending sequence (smallest to largest).

**D** Indicates that the column is to be sorted in descending sequence (largest to smallest).

## Locating Data

Once a display is sorted on a particular column, that column becomes the search column for the **LOCATE** command. The **LOCATE** command is used to find and scroll the display to a specified row. The syntax of the **LOCATE** command is as follows:



Where:

### **locate-field-value**

Indicates the row to which you want to scroll. This value must be in the same format as the data in the sort column, for example, if the sorted field is a decimal number, the locate-field-value must also be a decimal number. For character strings, you do not need to specify a string that is the full length of the column. If you specify a shorter string, the **LOCATE** command will pad the locate-field-value with blanks to the length of the field.

## Auto-Refresh

Some ISPF/SDF applications support the **GO** command. The **GO** command places the display into an auto-refresh mode. When a display is in auto-refresh mode, the keyboard is locked and the program periodically simulates an ENTER action. The syntax of the **GO** command is as follows:



Where:

**seconds** Specifies a value between 1 and 60, indicating the amount of time that the program should wait between refresh cycles.

To terminate auto-refresh mode, use the attention key (or PA1 on some terminals).



**Note:**

Two attention actions back-to-back will cause the application to terminate.

## Splitting the Screen

Using the **SPLIT** primary command, you can split your ISPF/SDF session into two logical sessions. Only one session is active at a time. The active session is the one that contains the cursor. To move between sessions you use the **SWAP** command. Alternatively, if a portion of the inactive window is visible, you can simply move the cursor into the inactive window to move to that session. To terminate a session, you can exit either by backing out through the session's primary option menu or by using the “=X” jump function.

## Security

Users must be authorized to use the applications of ISPF/SDF. At a minimum, your security administrator must give your TSO userid **READ** authority for you to be able to view the several resource lists (host links, databases, remote users, etc.). If you wish to change Shadow Mainframe Adapter Server information, your userid must be given **UPDATE** authority.

## Getting Help

Every ISPF/SDF application supports on-line help. To access an application's tutorial, enter the **HELP** primary command or press the **HELP** PF key from within any panel of any application (the **HELP** command is usually assigned to F1, but that can be changed). To terminate the tutorial and return the application, use the **END** command or the **END** PF key (usually F3).

If you are outside of an application and would like to view its tutorial without getting into it, select Option T from the primary option menu. This will take you to the main tutorial panel, which is shown in Figure 2–5. From the tutorial menu, you may select any of the applications’ tutorials.

```

TUTORIAL ----- TABLE OF CONTENTS ----- TUTORIAL
OPTION  ===>

          |          SHADOW Mainframe Adapter Server TUTORIAL          |
          |-----|-----|
The following topics are presented in sequence, or may be selected by
entering a selection code in the option field:
0  ISPF PARMS   - Specify terminal and user parameters
1  LINK         - Display and control link table
2  DATABASE    - Display and control database table
3  ATTACHED USER - Display and control local users
4  REMOTE USER - Display and control remote users
5  SDB CONTROL - Control Shadow Mainframe Adapter Server
6  TRACE BROWSE - Browse Shadow Mainframe Adapter Server trace log
X  EXIT        - Terminate ISPF/SDB using log and list defaults

```

**Figure 2–5. ISPF/SDF Tutorial Menu**

If your installation has installed MVS/Quick-Ref<sup>1</sup>, you can use the SQL Explain sub-application of the attached users, remote users, and trace browse applications to display explanatory text related to SQL operations.

## The Shadow Web Interface (SWI)

The Shadow Web Interface™ (SWI) is a GUI (Graphical User Interface) that allows you to perform many of the same functions available on the ISPF panels. SWI allows you to use a common Web browser to monitor and control Shadow Mainframe Adapter Server, giving you remote administration of the Shadow product and its components. Shadow Web Interface offers the following access and control features:

- Enables administrative functions over the Web, which include controlling and monitoring for the following:
  - Product
  - Storage
  - Databases
  - CICS
  - IMS
  - RRS
  - TSO

<sup>1</sup> MVS/Quick-Ref must be purchased separately. It is a product of Chicago-Soft, Ltd.

- Controlled using a product parameter.
- Trace browse support.
- Integrates security features.

The following Web browsers are supported:

- Netscape Navigator™ v 4.0 or higher
- Microsoft Internet Explorer™ v 4.0 or higher

## Preparation

Before you begin, you will need to perform the following steps:

1. Install Shadow Mainframe Adapter Server on the various components for your site. (See the *Shadow Mainframe Adapter Server Installation Guide* and the component user documentation for more information.)
2. Set the HOSTDOMAIN product parameter to allow cookies to be recognized. There must be a minimum three node name separated by periods. For example:

P390.NEONSYS.COM

3. **(Optional)** If you want to change the default parameter value (SWICNTL), modify the Shadow Mainframe Adapter Server SWIURLNAME parameter in your SDBxIN00 initialization EXEC and change the value. For example, the default is as follows:

```
MODIFY PARM NAME (SWIURLNAME) VALUE (SWICNTL)
```



### Note:

The SWIURLNAME (SHADOW WEB INTERFACE URL NAME) parameter activates the Web interface. The default value, SWICNTL, is loaded during installation.

4. Verify that your browser accepts cookies.
5. Specify the URL (and port number) in your browser. For example:

```
http://domain_name:portnumber/swicntl
```

Where `swicntl` is the value of the SWIURLNAME parameter.

6. Press ENTER.

The login panel shown in Figure 2–6 appears.



**NEON**  
SYSTEMS, INC.

### Shadow Direct Control and Administration Logon

Use of the Shadow Server Control and Administration functions require that you signon using your MVS Userid and Password. Further, your MVS Userid and Password must be authorized to access and/or update the Server controlled resources managed by this application.

MVS Userid:   
Password:   
New Password:   
ReType New Password:

**Figure 2–6. Shadow Web Interface Logon Screen**

## Logging On

Before you can use the interface, you must first logon:



**Note:**

You must wait for the entire page to display before entering any information. If you do not, security will not be properly implemented and your userid and password will *not* be sent.

1. In the **MVS Userid** field, type your mainframe userid.
2. In the **Password** field, type your password.
3. Click **Submit Logon Request** or press ENTER. The Shadow Web Interface home page shown in Figure 2–7 displays.

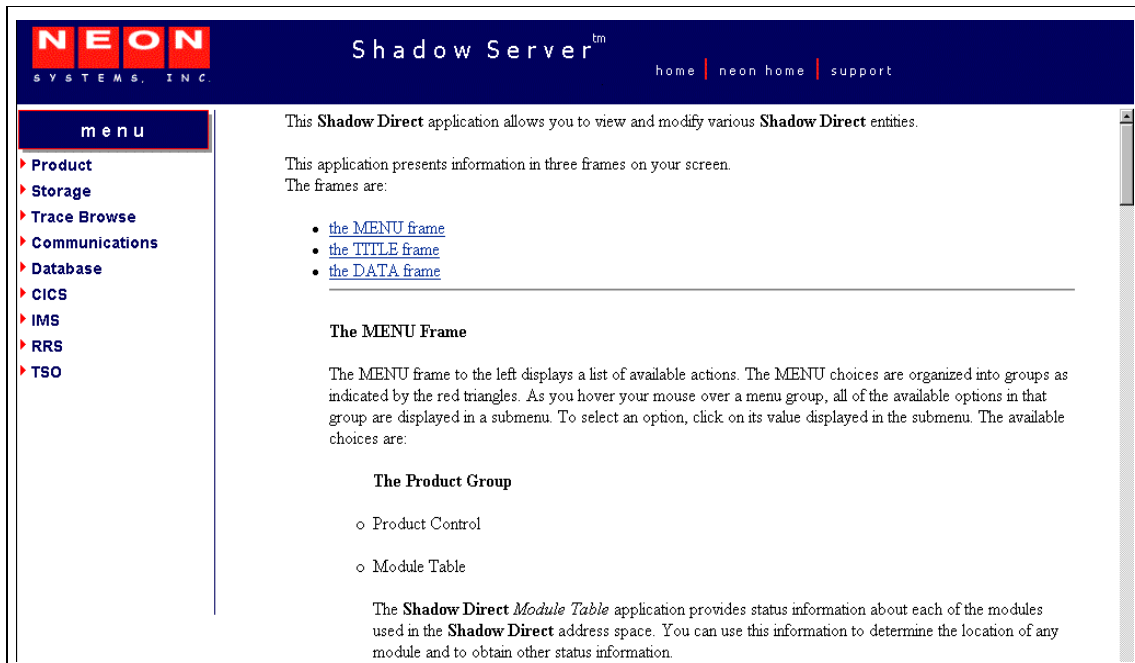

**Figure 2–7. Shadow Web Interface Home Page**

## The Home Page

Information is presented in three frames on your screen:

- The TITLE frame
- The DATA frame
- The MENU frame

### The TITLE Frame

The TITLE frame is at the top of your screen. It displays the following:

- The product title.
- **Home:** A link back to the Shadow Web Interface home page.
- **NEON Home:** A link to the home page.
- **Support:** A link to Technical Support.

### The DATA Frame

The DATA frame appears on the right side of your screen and displays the application information.

## The MENU Frame

The MENU frame, on the left of the screen, displays a list of available actions. The MENU is organized into the following main groups:

- Product
- Storage
- Trace Browse
- Communications
- Database
- CICS
- IMS
- RRS
- TSO



### **Note:**

Most of the MENU frame group panels have an ACTION column with links that can be used to gain further information about the row or selected item.

## *Product*

The submenu items listed in Table 2–2 are available under the **Product** group.

**Table 2–2. Product Group Submenu Items**

Submenu	Description
Product Control	Displays a composite of statistical and general information about the product, such as subsystem names, status, and addresses.
Module Table	Provides status information about each of the modules used in the Shadow Mainframe Adapter Server address space. This information can be used to determine the location of any module and other status information.
Parameter Groups	Allows you to control the started task parameters created using the Shadow Mainframe Adapter Server initialization EXEC, SDBxIN00. Some of these parameters can be modified after setup. For information on viewing and changing parameters.
Tasks	Displays current and cumulative information for monitoring and controlling specific Shadow Mainframe Adapter Server tasks. With it, you can kill a selected task, display the task trace control block, or display the user detail for the selected row.
Process Block	Displays information on process blocks, such as name, origin, usage, and addresses.
Token Control	Allows you to display and control Shadow Mainframe Adapter Server execution tokens. Using this application, you can determine the status of a token, look at token data, and kill tokens, as needed.
MIME/Filetype Table	Provides status information about each of the entries in the configurable Shadow Mainframe Adapter Server Servicemen table. You can use this information to determine if a filetype entry has been defined, obtain status information, and update entries.



**Table 2–2. Product Group Submenu Items (continued)**

Submenu	Description
Data Mapping Block	Allows you to view the mapping data structures.
DBCS Translate Table	Displays the DBCS translation tables in either an ASCII-to-EBCDIC DBCS translation table or an EBCDIC-to-ASCII DBCS translation table.

## Storage

The **Storage** option is a virtual storage information application that allows you to see the allocation of private virtual storage in Shadow Mainframe Adapter Server's address space. This includes the following information:

- Who is using the Private and Extended areas.
- Which programs are being run in the Private and Extended areas.

The **Storage** group is designed to help you locate potential problem areas. The submenu items listed in Table 2–3 are available under the **Storage** group.

**Table 2–3. Storage Group Submenu Items**

Submenu	Description
Internal Control Blocks	Displays internal product control blocks and storage areas as formatted lists with descriptions and as a hexadecimal dump. You must have z/OS security subsystem READ authorization to the Shadow Mainframe Adapter Server's CONTROLBLOCKS generalized resource rule in order to use this diagnostic function.
Pvt Area Stg Display	Displays the allocation of virtual storage information in the Shadow Mainframe Adapter Server's address space by subpool. This includes the amount of storage used for the following: <ul style="list-style-type: none"> <li>• Allocated: Allocated to a subpool</li> <li>• Allocated - Free: Used</li> <li>• Free: Not used</li> </ul>
Common Area Stg Display	Displays summary information of the allocation of virtual storage for each subpool in the Shadow Mainframe Adapter Server's address space. This includes the amount of storage used for the following: <ul style="list-style-type: none"> <li>• Allocated: Allocated to a subpool</li> <li>• Allocated - Free: Used</li> <li>• Free: Not used</li> </ul>
TCB Storage Summary	Displays summary information pertaining to the allocation of virtual storage for each TCB in the Shadow Mainframe Adapter Server's address space. This includes the TCB address and the amount of owned storage used for the following: <ul style="list-style-type: none"> <li>• Allocated: Allocated to a subpool</li> <li>• Allocated - Free: Used</li> <li>• Free: Not used</li> </ul>

**Table 2–3. Storage Group Submenu Items (continued)**

Submenu	Description
Allocated Storage	Displays an overview of the allocation of virtual storage in the Shadow Mainframe Adapter Server's address space. The information is displayed by regions in which the address and size of the region is reported. Within each region, the address and size of each block of allocated virtual storage is displayed.
Virtual Storage	Displays an overview of both allocated and unallocated virtual storage in the Shadow Mainframe Adapter Server's address space. This information is displayed by regions in which the address and size of the region is reported. Within each region, the address and size of each block of allocated and unallocated virtual storage is displayed.
Unallocated Storage	Displays an overview of unallocated virtual storage in the Shadow Mainframe Adapter Server's address space. This information is displayed by regions in which the address and size of the region is reported. Within each region, the address and size of each block of unallocated virtual storage is displayed.

### *Trace Browse*

The trace list, which is maintained by the SDB started task, is a record of all communication, WWW, and internal events in message format. The most recent messages are at the bottom of the list and the oldest messages are at the top. The list is implemented as a FIFO buffer, the size of which is an SDB parameter. When the list is full, messages are removed from the top of the buffer to make room for the newer messages at the bottom.

The submenu items listed in Table 2–4 are available under the **Trace Browse** group.

**Table 2–4. Trace Browse Group Submenu Items**

Submenu	Description
Trace Browse Records	Displays trace browse records. When you select the <b>Trace Browse Records</b> menu option, the panel displays the bottom of the trace list. This contains the most recent additions.
Trace Browse Control	Allows you to control trace browse records. With <b>Trace Browse Control</b> , you can limit the display of record types as well as set the number of records to be retrieved during each interaction.

### *Communications*

The **Communications** group allows you to do the following:

- Display and control the link table.
- Display and modify in-flight transactions (remote users).

The submenu items listed in Table 2–5 are available under the **Communications** group.

**Table 2–5. Communications Group Submenu Items**

Submenu	Description
Link Control	Allows you to display and control teleprocessing links. Use this application to determine and change the status of the links.
IP Address Tree	Displays the Internet Protocol (IP) network address of a node.
Remote Users	Displays current and cumulative transactions regarding users on remote nodes. Remote users connect with the local Shadow Mainframe Adapter Server to access databases on the local node.

## *Database*

The **Database** group is used to view and modify the Web Server's database table. The submenu item listed in Table 2–6 is available under the **Database** group.

**Table 2–6. Database Group Submenu Item**

Submenu	Description
Database Control	Allows you to view and modify the Shadow Mainframe Adapter Server database table. With it, you can view database statistics, such as version number, database status (if the database is up or down), and address. You can also clear pending requests.

## *CICS*

The **CICS** group is the CICS Control Facility. The submenu items listed in Table 2–7 are available under the **CICS** group.

**Table 2–7. CICS Group Submenu Items**

Submenu	Description
CICS Connections	Allows you to monitor and control CICS connections. The main CICS Connections panel is summarized by connection name. It contains information such as access method, total sessions, and protocol used. You can use the <b>Sessions</b> link to drill down to view individual sessions or to change the status (ANY, UP, or DOWN). You can also change the status on the main CICS Connections panel and apply it to all the sessions for the connection name.
CICS Session	Allows you to monitor and control each CICS session.

## *IMS*

The IMS Control Facility allows you to monitor and control your access to IMS/TM and IMS/DB. An APPC/MVS provides the ability to monitor APPC/MVS conversations to IMS in real-time and historical mode. APPC/MVS conversations

can be terminated automatically (inactivity timeout setting) or by manual intervention (line command).

The submenu items listed in Table 2–8 are available under the **IMS** group.

**Table 2–8. IMS Group Submenu Items**

Submenu	Description
IMS LTERM Table	Allows you to display and control LTERM mapping. You can exploit existing IMS LTERM security by assigning known LTERM names to inbound IMS transactions based on the userid or the IP address of the originating requestor.
APPC/MVS Detail	Allows you to monitor APPC/MVS conversations to IMS in historical mode, including information such as userid, conversation start time, total sends, and total data received.
APPC/MVS Realtime	Allows you to monitor APPC/MVS conversations to IMS in real-time mode.
APPC/MVS Interval	Displays a summary of APPC/MVS conversation statistics.

## *RRS*

The Recoverable Resources Services (RRS) works with DB2 v 5.1 or later and Shadow Mainframe Adapter Server v 4.5 or later. The submenu items listed in Table 2–9 are available under the **RRS** group.

**Table 2–9. RRS Group Submenu Items**

Submenu	Description
Resource Manager	Allows you to monitor and control the resource manager. With it, you can enable or disable the manager, determine the status (enabled or disabled), and view other statistical information (such as the number of normal commits).
Active Transactions	Displays active (in-progress) transactions.
Indoubt Transactions	Displays transactions that are in-doubt due to error conditions during transaction processing.
Recovery Transactions	Displays recovery transactions.
Units of Recovery	Allows you to monitor recovery and to specify the number of entries the RRS recovery table holds.

## *TSO*

The submenu item listed in Table 2–10 is available under the **TSO** group.

Table 2–10. TSO Group Submenu Item

Submenu	Description
TSO Mainframe Adapter Servers	Displays TSO Mainframe Adapter Server status, job names, and address space.

## Security Features

The following security features are in Shadow Web Interface:

- **Encrypted userids and passwords.** Both are transmitted and stored in an encrypted format.
- **10 minute time-out.** There is an automatic 10 minute time-out that is invoked if you do not transmit a command via a mouse click. This security measure is active throughout the entire session. The time-out minutes *cannot* be reset.
- **Shadow Security.** When you install the Shadow Mainframe Adapter Server, additional security is invoked. Refer to the *Shadow Mainframe Adapter Server Installation Guide* for more information on security options.



# CHAPTER 3: **Shadow Mainframe Adapter Server: Control**

---

---

This chapter describes the Control options, a feature of the Shadow Mainframe Adapter Server, the Mainframe Adapter Server component of the Shadow product.

Topics include:

- Overview
- Shadow Mainframe Adapter Server Control Option Menu
  - Option 1: Setting the ISPF Session Parameters
  - Option 3: Displaying Control Block Information
  - Option 4: Displaying Product Statistics
  - Option 6: Displaying Product Module Information
  - Option 7: Displaying Product Task Information
  - Option 11: Displaying RPC Load Module Information
  - Option 12: Displaying Product Information for Each Shadow Copy in Use
  - Option 13: Displaying Product Storage Information
  - Option 19: Displaying National Language Support Tables

## **Overview**

With the Shadow Mainframe Adapter Server Control application, you can view and/or modify vital Shadow product data. This data includes various parameters and other control and statistical information. This application is available through both the Shadow ISPF panels and the Shadow Web Interface™

## **Shadow Mainframe Adapter Server Control Option Menu**

The main panel of the Shadow Mainframe Adapter Server Control application, the **Shadow Mainframe Adapter Server Control Option Menu**, is shown in Figure 3-1.

```

----- Shadow Mainframe Adapter Server Control Option Menu -----
----- SDBB
OPTION ===>

 1 ISPF Session - Display and modify ISPF/SDB session parameters
 2 SDB Task     - Display and modify SDB main task parameters
 3 SDB Blocks   - Display formatted SDB control blocks
 4 SDB Stats    - Display SDB product statistics
 5 SDB Tokens   - Display and Control tokens
 6 SDB Modules  - Display product module vector table entries
 7 SDB Tasks    - Display product tasks
 9 SDB IP Tree  - Display the IP address tree
10 SDB Prcs Blks - Display the Cross Memory Process Blocks
11 SDB RPC      - RPC Control Facility
12 SDB Copies   - Display information about each copy of the product
13 SDB Storage  - Display virtual storage information
14 SSL Utilities - SSL Key and Certificate Handling Utilities
15 Trace Archive - Trace Browse Archive Facility
17 SDB Group    - Display all remote users in a group

```

**Figure 3–1. Shadow Mainframe Adapter Server Control Option Menu**

More information about each of the Shadow Mainframe Adapter Server Control application options can be found as indicated in Table 3–1.

**Table 3–1. Shadow Mainframe Adapter Server Primary Option Menu -- Finding More Information**

Option	Documentation Reference
1 ISPF Session	See “Option 1: Setting the ISPF Session Parameters” on page 3-3.
2 SDB Task	See the <i>Shadow Mainframe Adapter Server Started Task Parameter Reference</i> .
3 SDB Blocks	See “Option 3: Displaying Control Block Information” on page 3-4.
4 SDB Stats	See “Option 4: Displaying Product Statistics” on page 3-7.
5 SDB Tokens	Not documented here (normally used by development).
6 SDB Modules	See “Option 6: Displaying Product Module Information” on page 3-8.
7 SDB Tasks	See “Option 7: Displaying Product Task Information” on page 3-11.
9 SDB IP Tree	Not documented here (normally used by development).
10 SDB Prcs Blks	Not documented here (normally used by development).
11 SDB RPC	See “Option 11: Displaying RPC Load Module Information” on page 3-14.
12 SDB Copies	See “Option 12: Displaying Product Information for Each Shadow Copy in Use” on page 3-16.
13 SDB Storage	See “Option 13: Displaying Product Storage Information” on page 3-20.
14 SSL Utilities	See the <i>Shadow Advanced Security Options User Documentation</i> .



**Table 3–1. Shadow Mainframe Adapter Server Primary Option Menu -- Finding More Information (*continued*)**

Option	Documentation Reference
15 Trace Archive	See Chapter 6, “Shadow Mainframe Adapter Server: Tracing and Troubleshooting,” of this guide.
17 SDB Group	See Chapter 4, “Shadow Mainframe Adapter Server: Communications,” of this guide.
19 NLS Tables	See “Option 19: Displaying National Language Support Tables” on page 3-39.

## Option 1: Setting the ISPF Session Parameters

Option 1 of the **Shadow Mainframe Adapter Server Control Option Menu** is used to identify the subsystem name that will be associated with your ISPF session. The settings are saved in the current user’s profile variable pool under the ISPF application.

This option is only available through the Shadow ISPF panels.

### Changing the Subsystem Information

1. From the **Shadow Mainframe Adapter Server Control Option Menu**, select Option 1, ISPF Session.
2. Press ENTER. The system displays the **Shadow Mainframe Adapter Server ISPF Session Parameters** panel shown in Figure 3–2.

```

----- Shadow Mainframe Adapter Server ISPF Session Parameters
-----
COMMAND ====>

Subsystem Name      ====> SDBB

```

**Figure 3–2. Shadow Mainframe Adapter Server ISPF Session Parameters**

3. If you are changing the name of the subsystem, type the new name over the old name that is displayed.



**Note:**

The subsystem name is specific to the TSO user who is using this ISPF session. Any changes made to the data on this panel will affect only the TSO user’s session.

Most systems will only run one copy of Shadow Mainframe Adapter Server. The default subsystem name is SDBB.

4. Press ENTER to save the subsystem name.
5. Use the **END** command (or F3 key) to return to the previous panel when you are satisfied with the values.

## Option 3: Displaying Control Block Information

The Shadow Mainframe Adapter Server Control Block application displays the current contents of critical product controls. The information is formatted to show individual fields and is followed by a hexadecimal dump of the control block controls. Although these displays were intended primarily for Customer Support personnel, system administrators may find this application helpful in some of their work.

This application is view-only and is available through the Shadow ISPF panels and the Shadow Web Interface.

### Available Commands

The Shadow Mainframe Adapter Server Control Block application supports all four scrolling commands (**UP**, **DOWN**, **LEFT**, **RIGHT**) and their PF key equivalents or scroll bar equivalents. It also supports the primary **SORT** and **LOCATE** commands.

In addition, the ISPF and Shadow Web Interface applications support the control block commands shown in Table 3–2.

**Table 3–2. Control Block Commands**

Command Description	ISPF	Web Interface
Displays the product control block specified by the selected row.	D	Display
Formats the block selection entry for the selected row.	F	Format
Prints the block selection entry for the selected row.	P	N/A
Displays the block selection entry for the selected row.	S	CBSB

To use control block commands, do one of the following:

- **ISPF panels:** Type the command to the left of the line and press ENTER.
- **Shadow Web Interface:** Click on the selected command.

### Column Names

Table 3–3 provides a description for each column name on the ISPF panels as well as the Shadow Web Interface. Sort names are provided for users of the ISPF panels.

**Table 3–3. Control Block Column Names**

<b>Column Name</b>	<b>Description</b>	<b>Sort Name (ISPF only)</b>
BLOCK NAME	Name of the control block.	NAME
DESCRIPTION	Description of the control block.	N/A
ASID	ASID where block resides.	ASID
ADDRESS	Virtual address of block storage.	ADDRESS
SIZE	Virtual size of block storage.	SIZE
PR KEY	Storage protection key.	PR KEY

## Invoking the Control Block Application

### *ISPF Panel Users*

To start the Shadow Mainframe Adapter Server Control Block application, do the following:

1. From the **Shadow Mainframe Adapter Server Control Option Menu**, select Option 3, SDB Blocks.
2. Press ENTER. The system displays the control block display panel shown in Figure 3–3.

```

----- Shadow Mainframe Adapter Server Internal C
ROW 1 OF 20
COMMAND ===>                                SCROLL===> PAGE
Line Commands:  D Display  F Format  P Print CB  S Show CB

Block Control Block
Name Description                               ASID  Address  Length  Pr  Note
BOST Active Browse Status Block                03BF  0E866000 00000800 80
CICO CICS Control Area                         03BF  00006000 00002000 80
CIEC EXCI Control Area                         03BF  0E4BB000 00001000 80
CMAS Product ASVT block                       03BF  7F38A000 00002A40 80
IMCO IMS Control Area                         03BF  00008000 00001000 80
MQCO IBM/MQ Control Area                      03BF  0E4BC000 00001000 80
OPCK Execution Checklist                      03BF  0DD58000 00000238 00
OPML Message Lookup Table                    03BF  7F703000 000110E8 40
OPMS Product Master Block                    03BF  0BE9C000 00009000 40
OPPA Product Parameter Table                 03BF  0E201000 00020DD8 00
OPPM Permanent Data Area                    03BF  0C662000 00001000 40
OPPT Protected Data Area                    03BF  7F398000 00001000 40
OPVT Module Address Vector Table            03BF  7F715000 000064F0 40
OPWK System Work Area                       03BF  7F723000 00004000 80
RLCI Compiler Interpretor Table             03BF  1592C000 00000100 88
RRCO RRS Control Area                       03BF  0E4BE000 00001000 80
RXWS GLVEVENT. Work Space                   03BF  154AC000 00000100 80
RXWS GLOBAL. Work Space                     03BF  1536A000 00000100 80
VSSD VSSD Storage Detail                    03BF  7F399000 00001030 80
WMCB WLM Control Block                      03BF  0E4BD000 00001000 80

```

**Figure 3–3. Shadow Mainframe Adapter Server ISPF Control Block Display**

- Use the available line commands in Table 3–2 on page 3-4 to perform the appropriate function(s).

### **Shadow Web Interface Users**

To start the Shadow Mainframe Adapter Server Control Block application:

- From the main menu, select **Storage** → **Internal Control Blocks**. The system displays the **Internal Control Blocks** screen, as shown in Figure 3–4.

Actions	Block Name	Description	ASID	Address	Length	Protect Key
<a href="#">Display</a> , <a href="#">Format</a> , <a href="#">CBSP</a>	BOST	Active Browse Status Block	005B	0E735000	00000800	80
<a href="#">Display</a> , <a href="#">Format</a> , <a href="#">CBSP</a>	CICO	CICS Control Area	005B	00006000	00002000	80
<a href="#">Display</a> , <a href="#">Format</a> , <a href="#">CBSP</a>	CIEC	EXCI Control Area	005B	0E3A5000	00001000	80
<a href="#">Display</a> , <a href="#">Format</a> , <a href="#">CBSP</a>	CMAS	Product ASVT block	005B	7F38C000	00002A40	80
<a href="#">Display</a> , <a href="#">Format</a> , <a href="#">CBSP</a>	IMCO	IMS Control Area	005B	00008000	00001000	80
<a href="#">Display</a> , <a href="#">Format</a> , <a href="#">CBSP</a>	MQCO	IBM/MQ Control Area	005B	0E3A6000	00001000	80
<a href="#">Display</a> , <a href="#">Format</a> , <a href="#">CBSP</a>	OPCK	Execution Checklist	005B	0DC56000	00000238	00
<a href="#">Display</a> , <a href="#">Format</a> , <a href="#">CBSP</a>	OPML	Message Lookup Table	005B	7F705000	00010F20	40
<a href="#">Display</a> , <a href="#">Format</a> , <a href="#">CBSP</a>	OPMS	Product Master Block	005B	0C7C3000	00009000	40
<a href="#">Display</a> , <a href="#">Format</a> , <a href="#">CBSP</a>	OPPA	Product Parameter Table	005B	0E0EF000	000020780	00
<a href="#">Display</a> , <a href="#">Format</a> , <a href="#">CBSP</a>	OPPM	Permanent Data Area	005B	0C790000	00001000	40
<a href="#">Display</a> , <a href="#">Format</a> , <a href="#">CBSP</a>	OPPT	Protected Data Area	005B	7F39A000	00001000	40
<a href="#">Display</a> , <a href="#">Format</a> , <a href="#">CBSP</a>	OPVT	Module Address Vector Table	005B	7F716000	000064F0	40
<a href="#">Display</a> , <a href="#">Format</a> , <a href="#">CBSP</a>	OPWK	System Work Area	005B	7F724000	00004000	80
<a href="#">Display</a> , <a href="#">Format</a> , <a href="#">CBSP</a>	RLCI	Compiler Interpreter Table	005B	154BB000	00000100	88
<a href="#">Display</a> , <a href="#">Format</a> , <a href="#">CBSP</a>	RRCO	RRS Control Area	005B	0E3A8000	00001000	80
<a href="#">Display</a> , <a href="#">Format</a> , <a href="#">CBSP</a>	RXWS	GLVEVENT. Work Space	005B	1537D000	00000100	80
<a href="#">Display</a> , <a href="#">Format</a> , <a href="#">CBSP</a>	RXWS	GLOBAL. Work Space	005B	15239000	00000100	80
<a href="#">Display</a> , <a href="#">Format</a> , <a href="#">CBSP</a>	VSSD	VSSD Storage Detail	005B	7F39B000	00001030	80
<a href="#">Display</a> , <a href="#">Format</a> , <a href="#">CBSP</a>	WMCB	WLM Control Block	005B	0E3A7000	00001000	80

Figure 3–4. Shadow Web Interface Control Block Display

- Use the available action commands in Table 3–2 on page 3-4 to perform the appropriate function(s).

## Option 4: Displaying Product Statistics

The Shadow Mainframe Adapter Server Statistics application displays a scrollable list of product statistics. These statistics, when interpreted correctly, provide useful insight into the current state of the product. From time to time, this display will be instrumental in diagnosing certain system problems.

This application is view-only and is available only through the Shadow ISPF panels.

### Available Commands

The Shadow Mainframe Adapter Server Statistics application supports all four scrolling commands (**UP**, **DOWN**, **LEFT**, **RIGHT**) and their PF key equivalents or scroll bar equivalents. It also supports the **FIND** and **SCROLL MAX** commands.

## Invoking the Statistics Application

### *ISPF Panel Users*

To start the Shadow Mainframe Adapter Server Statistics application:

1. From the **Shadow Mainframe Adapter Server Control Option Menu**, select Option 4, SDB Stats.
2. Press ENTER. The system displays the **SDB Product Statistics** panel shown in Figure 3–5.

```

BROWSE -- SDB PRODUCT STATISTICS ----- Line 00000000 Col 001
051
Command ==>>>                                     Scroll ==>> PAGE
NUMBER PROCESS BLOCKS IN USE                        1
NUMBER OF ATTACHED SUBTASKS                         3
EARLY EOT EXIT COUNT                               3184
OTHER SUBSYSTEM EXIT COUNT                         0
END OF MEMORY EXIT COUNT                           57
CURRENT ABEND SCORE                                 1
CURRENT ABEND COUNT                                 1
SUPPRESSED ABEND COUNT                             0
CURRENT LOGREC SCORE                               0
CURRENT LOGREC COUNT                               0
SUPPRESSED LOGREC COUNT                            0
CUR EXPECTED ABEND SCORE                           0
CURRENT EXPECTED ABENDS                             0
SUPPRESSED EXPECTED ABENDS                         0
TOTAL PC PROC BLKS USED                             4692
PC PROC BLKS INUSE                                  0
PC PROC BLK RECAPTURES                              0
PC PROC BLK HIGH WATER COUNT                       3
TOTAL ES PROC BLKS USED                             0
ES PROC BLKS INUSE                                  0
ES PROC BLK RECAPTURES                              0
ES PROC BLK ALOC FAIL COUNT                         0
ES PROC BLK HIGH WATER COUNT                       0
DYN PROC BLOCK ALLOC COUNT                          0
DYN PROC BLOCK ALLOC FAILED                         0

```

**Figure 3–5. Shadow ISPF Product Statistics**

## **Option 6: Displaying Product Module Information**

The Shadow Mainframe Adapter Server Modules application provides status information about each of the modules used in the Shadow Mainframe Adapter Server address space. You can use this information to determine the location of a

specific module or to obtain status information about a module, such as module name, address, and size.

This application is view-only and is available through the Shadow ISPF panels and the Shadow Web Interface.

## Available Commands

The Shadow Mainframe Adapter Server Modules application supports all four scrolling commands (**UP**, **DOWN**, **LEFT**, **RIGHT**) and their PF key equivalents or scroll bar equivalents. It also supports the primary **SORT** and **LOCATE** commands.

In addition, the ISPF and Shadow Web Interface applications support the product module commands shown in Table 3–4.

**Table 3–4. Product Module Commands**

Command Description	ISPF	Web Interface
Displays the data associated with the module.	D	Display
Formats the data for the selected row.	F	Format
Prints the control block for the selected row.	P	N/A
Displays the control block for the selected row.	S	Block

To use product module commands, do one of the following:

- **ISPF panels:** Type the command to the left of the line and press ENTER.
- **Shadow Web Interface:** Click on the selected command.

## Column Names

Table 3–5 provides a description for each column name on the ISPF panels as well as the Shadow Web Interface screen. Sort names are provided for users of the ISPF panels.

**Table 3–5. Product Module Column Names**

Column Name	Description	Sort Name (ISPF only)
MODULE NAME	The name of the product module.	NAME
MODULE ADDRESS	The address of the product module.	ADDRESS
ORIGINAL ADDRESS	The original module address.	ORIGINAL
MODULE SIZE	Product module size.	SIZE

**Table 3–5. Product Module Column Names (continued)**

Column Name	Description	Sort Name (ISPF only)
COMPILE DATE	Module compile date.	DATE
COMPILE TIME	Module compile time.	TIME
USER SIZE	User area size.	USER
PRIMARY USAGE	High primary stack usage.	PRIMARY
ERROR USAGE	High error stack usage.	ERROR

## Invoking Shadow Modules

### ISPF Panel Users

To start the Shadow Mainframe Adapter Server Modules application:

1. From the **Shadow Mainframe Adapter Server Control Option Menu**, select Option 6, SDB Modules.
2. Press ENTER. The system displays the **Shadow Mainframe Adapter Server Module Table** panel shown in Figure 3–6.

```

----- Shadow Mainframe Adapter Server Module Table -----
SCR 1 ROW 1 OF 306
COMMAND ===>                                SCROLL ===> PAGE
Line Commands:  D Display Data  F Format  P Print CB  S Show CB

MODULE  MODULE  ORIGINAL  MODULE
NAME    ADDRESS  ADDRESS   SIZE    NOTE
OPABMG  0DC6E000 0DC6E000 00000D38
OPACDA  0DC6F000 0DC6F000 000168A0
OPADBRFE 0DC86000 0DC86000 00002D38
OPADMG  0DC89000 0DC89000 00000318
OPADTP  0DC8A000 0DC8A000 0002A408
OPALCB  0DCB5000 0DCB5000 00000188
OPAMMG  0DCB6000 0DCB6000 00001238
OPAMTP  0DCB8000 0DCB8000 000066A8
OPAOEX  0DCCC000 0DCCC000 00006820
OPAOPR  0DCD3000 0DCD3000 000073B0
OPAORLMG 0DCDB000 0DCDB000 00017E10
OPAPFCH 0C2F5000 0DCBF000 00000580
OPAPFM  0DCC0000 0DCC0000 00000490
OPAPMG  0DCC1000 0DCC1000 00004B18
OPARRU  0DCC6000 0DCC6000 00005F58
OPASMF  0DCF3000 0DCF3000 00007A98
OPATMD  0DCFB000 0DCFB000 00001338

```

**Figure 3–6. Shadow ISPF Product Module**



There are three panels that comprise the Shadow Modules application. Use the **LEFT** and **RIGHT** scroll commands (or PF keys) to shift between them.

- Use the available line commands in Table 3–4 on page 3-9 to perform the appropriate function(s).

## Shadow Web Interface Users

To start the Shadow Mainframe Adapter Server Modules application:

- From the main menu, select **Product** → **Module Table**. The system displays the **Module Table** screen, as shown in Figure 3–7.

Actions	Module Name	Module Address	Original Load Address	Module Size	Module Assembly Date	Module Assembly Time	User Area Size	Primary Stack Usage	Error Stack Usage
<a href="#">Format Block</a>	OPABMG	0DB6E000	0DB6E000	00000D38	2000/10/07	15:08	00000498	00000000	00000000
<a href="#">Format Block</a>	OPACDA	0DB6F000	0DB6F000	000168E0	2000/12/01	11:10	00010FB8	00000000	00000000
<a href="#">Format Block</a>	OPADBRFE	0DB86000	0DB86000	00002960	2000/12/05	14:36	00000148	00000000	00000000
<a href="#">Format Block</a>	OPADMG	0DB89000	0DB89000	00000318	2000/10/07	15:09	00000490	00000000	00000000
<a href="#">Format Block</a>	OPADTP	0DB8A000	0DB8A000	00029D90	2000/11/17	11:15	00002D08	00000000	00000000
<a href="#">Format Block</a>	OPALCB	0DBB4000	0DBB4000	00000188	2000/10/07	15:10	00000150	00000000	00000000
<a href="#">Format Block</a>	OPAMMG	0DBB5000	0DBB5000	00001238	2000/10/07	15:11	00000198	00000000	00000000
<a href="#">Format Block</a>	OPAMTP	0DBB7000	0DBB7000	000066A8	2000/12/13	17:35	00010ECO	00000000	00000000

**Figure 3–7. Shadow Web Interface Product Module**

Use the vertical and horizontal scrollbars to navigate this screen.

- Use the available action commands in Table 3–3 on page 3-6 to perform the appropriate function(s).

## Option 7: Displaying Product Task Information

The Shadow Mainframe Adapter Server Tasks application provides current and cumulative information about Shadow Mainframe Adapter Server tasks.

This application is available through the Shadow ISPF panels and the Shadow Web Interface.

### Available Commands

The Shadow Mainframe Adapter Server Tasks application supports all four scrolling commands (**UP**, **DOWN**, **LEFT**, **RIGHT**) and their PF key equivalents or scroll bar equivalents. It also supports the primary **SORT** and **LOCATE** commands.

In addition, the ISPF and Shadow Web Interface applications support the product task commands shown in Table 3–6.

**Table 3–6. Product Task Commands**

Command Description	ISPF	Web Interface
Cancels the thread.	C	Cancel
Formats the information for the selected row.	F	Format
Kills the selected task.	K	Kill
Displays the control block for the selected row.	S	Block
Displays an SQL trace for the selected task.	T	SQL
Displays user detail for the selected row.	U	User
Prints the associated control block for the selected row.	P	N/A

To use product task commands, perform one of the following:

- **ISPF panels:** Type the command to the left of the line and press ENTER.
- **Shadow Web Interface:** Click on the selected command.

## Column Names

Table 3–7 provides a description for each column name on the ISPF panels as well as the Shadow Web Interface screen. Sort names are provided for users of the ISPF panels.

**Table 3–7. Product Task Column Names**

Column Name	Description	Sort Name (ISPF only)
TCB ADDRESS	The name of the product module.	TCB
CONNECTION ID	The address of the product module.	CONNECTION
EXECUTION STATE	Status of subtasks.	
PROGRAM NAME	Product module size.	PROGRAM
CPU TIME	Amount of CPU time used by the TCB.	CPU
SMAF ADDRESS	Address of the SMAF control block.	SMAF
TASK TYPE	Description of the type of task.	TASK

## Invoking the Tasks Application

### ISPF Panel Users

To start the Shadow Mainframe Adapter Server Tasks application:

1. From the **Shadow Mainframe Adapter Server Control Option Menu**, select Option 7, SDB Tasks.
2. Press ENTER. The system displays the **Shadow Mainframe Adapter Server Tasks** panel shown in Figure 3–8.

```

----- Shadow Mainframe Adapter Server Tasks -----
SCR 1 ROW 1 OF 18
COMMAND ==> SCROLL ==> PAGE
Line Commands: C Cancel Thread F Format K Kill Task P Print CB S Show CB
                T SQL Trace U User Detail

TCB          CONNECTION  EXECUTION  PROGRAM    CPU
ADDRESS      ID              STATE      NAME       TIME      NOTE
0080F5F8     0015F686       Running    OPDBTP     010.992S
00815240     0015F607       Running    OPCKLM     006.626S
00815960     0015F606       Running    SEFFULL    001.342S
008D0870     0015F605       Running    OPMALG     001.128S
008F6030     0015F600       Running    TRACE      000.608S
008D1790     0015F602       Running    OPIMSR     000.202S
008F6898     0015F5FF       Running    OPINAS     000.175S
0080AE88     0015F67D       Running    OPDBTP     000.168S
008D0B00     0015F604       Running    OPRRRM     000.167S
008D1338     0015F603       Running    GLVA       000.158S
008733C8     0015F601       Running    OPCIEC     000.148S
0080D788     0015F617       Running    OPDBTP     000.081S
0080F438     0015F60F       Running    OPMAOT     000.074S
00800AC8     0015F679       Running    OPDBTP     000.054S
0080D288     0015F608       Running    OPMAEC     000.012S
0080DA60     0015F60B       Running    OPMAEC     000.008S
0080DCF0     0015F60A       Running    OPMAEC     000.008S

```

**Figure 3–8. Shadow ISPF Product Tasks**

There are two panels that comprise the Shadow Mainframe Adapter Server Tasks application. Use the **LEFT** and **RIGHT** scroll commands (or PF keys) to shift between them.

3. Use the available line commands in Table 3–6 on page 3-12 to perform the appropriate function(s).

### Shadow Web Interface Users

To start the Shadow Mainframe Adapter Server Tasks application:

1. From the main menu, select **Product** → **Tasks**. The system displays the **Tasks** screen, as shown in Figure 3–9.

Actions	TCB Address	Connection ID	Execution State	Program Name	CPU Time	SMAF Address	Task Type
<a href="#">Cancel</a> , <a href="#">Format</a> , <a href="#">Kill</a> , <a href="#">Display</a> , <a href="#">SQL</a> , <a href="#">User</a>	008D1650	00135006	Running	OPCKLM	070.593S	7E380660	Check CPU/Wait Limits Subtask
<a href="#">Cancel</a> , <a href="#">Format</a> , <a href="#">Kill</a> , <a href="#">Display</a> , <a href="#">SQL</a> , <a href="#">User</a>	008D1330	00135004	Running	OPMALG	009.345S	7E38C028	Main Product Logging Task
<a href="#">Cancel</a> , <a href="#">Format</a> , <a href="#">Kill</a> , <a href="#">Display</a> , <a href="#">SQL</a> , <a href="#">User</a>	008D1A80	00135002	Running	OPIMSR	002.186S	7E3BF520	IMS CTL Server Task
<a href="#">Cancel</a> , <a href="#">Format</a> , <a href="#">Kill</a> , <a href="#">Display</a> , <a href="#">SQL</a> , <a href="#">User</a>	008E9210	00000002	Running	TRACE	001.908S	7F72C0B8	Main Product Subtask
<a href="#">Cancel</a> , <a href="#">Format</a> , <a href="#">Kill</a> , <a href="#">Display</a> , <a href="#">SQL</a> , <a href="#">User</a>	00819120	00135003	Running	GLVA	001.759S	7E3BF120	Main Product Subtask
<a href="#">Cancel</a> , <a href="#">Format</a> , <a href="#">Kill</a> , <a href="#">Display</a> , <a href="#">SQL</a> , <a href="#">User</a>	00873590	00135001	Running	OPCIEC	001.481S	7F3863B8	CICS EXCI Controller Task

**Figure 3–9. Shadow Web Interface Product Tasks**

Use the vertical and horizontal scrollbars to navigate this screen.

2. Use the available action commands in Table 3–6 on page 3-12 to perform the appropriate function(s).

## Option 11: Displaying RPC Load Module Information

With the Shadow Mainframe Adapter Server RPC Load Module application, you can display or refresh the RPC load modules that are loaded in the Shadow Mainframe Adapter Server address space.

This application is view-only and is available through the Shadow ISPF panels and the Shadow Web Interface.

### Available Commands

The Shadow Mainframe Adapter Server RPC Load Module application supports all four scrolling commands (**UP**, **DOWN**, **LEFT**, **RIGHT**) and their PF key equivalents or scroll bar equivalents. It also supports the primary **SORT** and **LOCATE** commands.

In addition, the ISPF and Shadow Web Interface applications support the RPC load module commands shown in Table 3–8.

**Table 3–8. RPC Load Module Commands**

Command Description	ISPF	Web Interface
Formats the information for the selected row.	F	Format
Displays the control block for the selected row.	S	RPC

To use the load module commands, do one of the following:

- **ISPF panels:** Type the command to the left of the line and press ENTER.
- **Shadow Web Interface:** Click on the selected command.

## Invoking the RPC Load Module Application

### *ISPF Panel Users*

To start the Shadow Mainframe Adapter Server RPC Load Module application:

1. From the **Shadow Mainframe Adapter Server Control Option Menu**, select Option 11, SDB RPC.
2. Press ENTER. The system displays the **Shadow Mainframe Adapter Server RPC Control Facility** panel shown in Figure 3–10.

```

----- Shadow Mainframe Adapter Server RPC Control Facility -----
Subsystem SDBB
OPTION  ====>

      1  Display RPC PLM      - Display RPC Preload Modules
  
```

**Figure 3–10. Shadow ISPF RPC Control Facility**

3. If you want to display the RPC preload modules, from the **Shadow Mainframe Adapter Server RPC Control Facility** panel, select Option 1, Display RPC PLM. The system displays the **Shadow Mainframe Adapter Server RPC Preload Modules** panel shown in Figure 3–11.

```

----- Shadow Mainframe Adapter Server RPC Preload Modules -----
--- ROW 1 OF 1
COMMAND  ====>                                SCROLL  ====> PAGE
Line Commands:  P Print Map  S Show Map

MODULE
NAME           ADDRESS      LENGTH  COUNT  TTR      K  Z  C  ADDRESS  NOTE
  
```

**Figure 3–11. Shadow ISPF RPC Preload Modules**

4. If you want to refresh the RPC preload module, from the **Shadow Mainframe Adapter Server RPC Control Facility** panel (Figure 3–10), select Option 2, Refresh RPC PLM. If the refresh is successful, the system displays a “Refresh Successful” message in the upper right hand corner of the panel, as shown in Figure 3–12.

**Note:**

This option is used to notify Shadow Mainframe Adapter Server that new RPC preload module(s) have been placed in the preload library and the incore versions need to be refreshed from the RPC preload library.

```
----- Shadow Mainframe Adapter Server RPC Control Facility -----
Refresh Successful
OPTION ===>

1 Display RPC PLM - Display RPC Preload Modules
```

**Figure 3–12. Shadow ISPF Refresh RPC Preload Modules**

## Shadow Web Interface Users

To start the Shadow Mainframe Adapter Server RPC Load Module application:

1. From the main menu, select **Product** → **RPC Preload Modules**. The system displays the **RPC Reload Modules** screen, as shown in Figure 3–13.

The screenshot shows the Shadow Server web interface. At the top, there is a header with the NEON logo and 'Shadow Server™' text. Below the header, there is a navigation menu on the left with options like Product, Storage, Trace Browse, Communications, Database, CICS, IMS, RRS, and TSO. The main content area is titled 'RPC Preload Modules' and contains a table with the following data:

Actions	Module Name	LPA	Length	Use Count	TTR	K	Z	C	CDE
<a href="#">Format RPC</a>	SDCOIMAP	8007C8E8	71448	1	000A0D	00	00	2C	008090D0

**Figure 3–13. Shadow Web Interface RPC Preload Modules**

2. Use the available action commands in Table 3–8 on page 3-14 to perform the appropriate function(s).

## Option 12: Displaying Product Information for Each Shadow Copy in Use

The Shadow Mainframe Adapter Server Copies application provides information about the various copies of Shadow Mainframe Adapter Server in use.

This application is view-only and is available through the Shadow ISPF panels and the Shadow Web Interface.

## Available Commands

The Shadow Mainframe Adapter Server Copies application supports all four scrolling commands (**UP**, **DOWN**, **LEFT**, **RIGHT**) and their PF key equivalents or scroll bar equivalents. It also supports the primary **SORT** and **LOCATE** commands.

In addition, the ISPF and Shadow Web Interface applications support the copies commands shown in Table 3–9.

**Table 3–9. Shadow Copies Commands**

Command Description	ISPF	Web Interface
Formats the information for the selected item.	F	Format
Prints the control block information related to the selected item.	P	N/A
Displays the control block information related to the selected item.	S	CMPD

To use the copies commands, perform one of the following:

- **ISPF panels:** Type the command to the left of the line and press ENTER.
- **Shadow Web Interface:** Click on the selected command.

## Column Names

Table 3–10 provides a description for each column name on the ISPF panels as well as the Shadow Web Interface screen.

**Table 3–10. Shadow Copies Column Names**

Column Name	Description
PRODUCT NAME	The 4-character name of the Shadow Mainframe Adapter Server subsystem (started task) with which this ISPF/SDF session is to communicate.
GROUP NAME	Name of the load balancing group.
PRODUCT STATUS	Status of Shadow Mainframe Adapter Server (for example, up or down).
NETWORK TYPE	Type of network on which Shadow Mainframe Adapter Server can run (for example, TCP/IP or SNA using LU6.2 protocol).
TRANSFER STATUS	Status of transfer.
CURRENT USERS	Number of users currently using Shadow Mainframe Adapter Server.
PRODUCT VERSION	Product version and release number.

**Table 3–10. Shadow Copies Column Names (continued)**

Column Name	Description
HI-WATER USERS	Maximum number of concurrent users.
LICENSED MAXIMUM	Maximum number of licensed concurrent users.
INSTALLATION MAXIMUM	Maximum number of installed users for that particular subsystem.
UNALLOCATED<16 MEG	Current amount of unallocated storage below 16MB.
UNALLOCATED>16 MEG	Current amount of unallocated storage above 16MB.
MINIMUM <16 MEG	The MINPRIV parameter is used to control the minimum amount of below the 16 MB line storage that must be available for new inbound sessions to be handled. If this much storage is not available, new inbound sessions will be rejected. If this parameter is set to zero, then the amount of below the 16 MB line storage will not be checked for each new connection. To set this parameter, see the <i>Shadow Started Task Parameters Reference</i> .
MINIMUM>16 MEG	The EMINPRIV parameter is used to control the minimum amount of above the 16 MB line storage that must be available for new inbound sessions to be handled. If this much storage is not available, new inbound sessions will be rejected. If this parameter is set to zero, then the amount of above the 16 MB line storage will not be checked for each new connection. To set this parameter, see the <i>Shadow Started Task Parameters Reference</i> .
ALLOCATED<16 MEG	Current amount of allocated storage below 16MB.
ALLOCATED>16 MEG	Current amount of allocated storage above 16MB.
SSCT ADDRESS	Address for subsystem control block.
SSVT ADDRESS	Address for subsystem vector table.
OPMS ADDRESS	Address for main product control block.
OPPM ADDRESS	Address for product permanent data area.
ASID	Address space index.

## Invoking the Copies Application

### *ISPF Panel Users*

To start the Shadow Mainframe Adapter Server Copies application:

1. From the **Shadow Mainframe Adapter Server Control Option Menu**, select Option 12, SDB Copies.
2. Press ENTER. The system displays the **Shadow Mainframe Adapter Server Product Control** panel shown in Figure 3–14.



```

----- Shadow Mainframe Adapter Server Product Control -----
SCR 1 ROW 1 OF 11
COMMAND ==>
Line Commands: F Format P Print CB S Show CB
                                SCROLL ==> PAGE

PRODUCT  GROUP      PRODUCT  NETWORK  TRANSFER  CURRENT
NAME     NAME        STATUS   TYPE     STATUS    USERS   NOTE
SDBB    None       Up       OTC/IP   Enabled   4
SDBC    None       Up       OTC/IP   Enabled   0
SDBD    None       Up       OTC/IP   Enabled   0
SDBH    None       Down     OTC/IP   Disabled  0
SDBI    None       Down     OTC/IP   Disabled  0
SDBO    None       Down     OTC/IP   Disabled  0
SDBR    None       Up       OTC/IP   Enabled   1
SDBU    None       Up       OTC/IP   Enabled   1
SDBV    None       Up       OTC/IP   Enabled   0
SDBW    WAYNE     Up       OTC/IP   Enabled   1

```

**Figure 3–14. Shadow ISPF Product Control**

There are four panels that comprise the Shadow Mainframe Adapter Server Copies application. Use the **LEFT** and **RIGHT** scroll commands (or PF keys) to shift between them.

- Use the available line commands in Table 3–9 on page 3-17 to perform the appropriate function(s).

### Shadow Web Interface Users

To start the Shadow Mainframe Adapter Server Copies application:

- From the main menu, select **Product** → **Product Control**. The system displays the product control screen, as shown in Figure 3–15.

Actions	Subsystem Name	Group Name	Product Status	Network Type	Transfer Status	Subsystem Name	Version String	Hi-Water Users	Licensed Maximum	Installation Maximum
<a href="#">Format_CMPD</a>	SDBB	None	Up	OTC/IP	Enabled	SDBB	04.05.01	4	2000	2000
<a href="#">Format_CMPD</a>	SDBC	None	Up	OTC/IP	Enabled	SDBC	04.05.01	1	2000	2000
<a href="#">Format_CMPD</a>	SDBD	None	Up	OTC/IP	Enabled	SDBD	04.05.01	0	2000	2000
<a href="#">Format_CMPD</a>	SDBH	None	Up	OTC/IP	Enabled	SDBH	04.05.01	1	25000	2000
<a href="#">Format_CMPD</a>	SDBJ	None	Up	OTC/IP	Enabled	SDBJ	04.05.01	1	2000	2000
<a href="#">Format_CMPD</a>	SDBO	None	Up	OTC/IP	Enabled	SDBO	04.05.01	10	2000	2000
<a href="#">Format_CMPD</a>	SDBR	None	Up	OTC/IP	Enabled	SDBR	04.05.01	1	2000	2000
<a href="#">Format_CMPD</a>	SDBU	None	Up	OTC/IP	Enabled	SDBU	04.05.01	3	2000	2000

**Figure 3–15. Shadow Web Interface Product Control**

Use the vertical and horizontal scrollbars to navigate this screen.

2. Use the available action commands in Table 3–9 on page 3-17 to perform the appropriate function(s).

## Option 13: Displaying Product Storage Information

The Shadow Mainframe Adapter Server Storage application provides information pertaining to the allocation of virtual storage in the Shadow Mainframe Adapter Server address space.

This storage application (see Figure 3–16) has several options available for summarizing and presenting information, including the following:

- Virtual storage information by TCBS.
- Private area information by subpools.
- Common area information by subpools.
- Allocated virtual storage information.
- Unallocated virtual storage information.
- Both allocated and unallocated storage information.

```

----- Shadow Mainframe Adapter Server Virtual Storage Information -
----- SDBB
OPTION  ===>

 1 SDB TCBS      - Display virtual storage information by TCBS
 2 SDB Subpools  - Display private area information by subpools
 3 SDB Subpools  - Display common area information by subpools
 4 SDB Allocated - Display allocated virtual storage information
 5 SDB Unalloc   - Display unallocated virtual storage information
 6 SDB Both      - Display allocated/unallocated storage information

```

**Figure 3–16. Shadow Mainframe Adapter Server Virtual Storage Information**

This application is view-only and is available through the Shadow ISPF panels and the Shadow Web Interface.

### Displaying Virtual Storage Information by TCBS

The Shadow Mainframe Adapter Server TCB Virtual Storage Summary application provides information pertaining to the allocation of virtual storage for each TCB in the Shadow Mainframe Adapter Server's address space.

For each TCB, the TCB address is shown, as well as the amount of owned storage allocated to that TCB. Also shown is the amount of utilized storage and the amount of free storage. For each class of storage, the total is shown for both below and above the 16 megabyte line. The program name, connection ID, and userid are shown for each TCB, when available.

All storage sizes are presented as true megabytes rounded up to the nearest one-thousandth of a megabyte.

## Available Commands

The Shadow Mainframe Adapter Server TCB Virtual Storage Summary application supports all four scrolling commands (**UP**, **DOWN**, **LEFT**, **RIGHT**) and their PF key equivalents or scroll bar equivalents. It also supports the primary **SORT** and **LOCATE** commands.

In addition, the ISPF and Shadow Web Interface applications support the TCB virtual storage commands shown in Table 3–11.

**Table 3–11. Virtual Storage by TCBs Commands**

Command Description	ISPF	Web Interface
Formats the information for the selected TCB.	F	Format
Displays the VSIF control block for the selected TCB.	S	VSIF
Prints the VSIF control block for the selected TCB.	P	N/A
Displays a storage summary by subpool for the selected TCB.	D	TCB

To use the TCB virtual storage commands, perform one of the following:

- **ISPF panels:** Type the command to the left of the line and press ENTER.
- **Shadow Web Interface:** Click on the selected command.

## Column Names

Table 3–12 provides a description for each column name on the ISPF panels as well as the Shadow Web Interface screen. Sort names are provided for users of the ISPF panels.

**Table 3–12. Virtual Storage by TCBs Column Names**

Column Name	Description	Sort Name (ISPF only)
TCB ADDRESS	The address of the TCB for which storage sizes are being displayed.	TCB
ALLOCATED <16 MEG	The size of the owned blocks of virtual storage allocated to this TCB that reside below the 16 MB line.	BELOW
ALLOCATED >16 MEG	The size of the owned blocks of virtual storage allocated to this TCB that reside above the 16 MB line.	ABOVE
UTILIZED <16 MEG	The size of the owned blocks of virtual storage allocated to this TCB that reside below the 16 MB line minus the amount of free storage within those blocks.	USEDLOW

**Table 3–12. Virtual Storage by TCBs Column Names (continued)**

Column Name	Description	Sort Name (ISPF only)
UTILIZED >16 MEG	The size of the owned blocks of virtual storage allocated to this TCB that reside above the 16 MB line minus the amount of free storage within those blocks.	USEDHIGH
NOT USED <16 MEG	The size of the free storage within the blocks of virtual storage allocated to this TCB that reside below the 16 MB line.	FREELOW
NOT USED >16 MEG	The size of the free storage within the blocks of virtual storage allocated to this TCB that reside above the 16 MB line.	FREEHIGH
PROGRAM NAME	The name of the program associated with this TCB.	PROGRAM
CONNECTION ID	The connection identifier associated with this TCB.	CONNECTION
USER ID	The userid associated with this TCB.	USERID

### *Invoking the TCB Virtual Storage Summary Application*

**ISPF Panel Users.** To start the Shadow Mainframe Adapter Server TCB Virtual Storage Summary application:

1. From the **Shadow Mainframe Adapter Server Virtual Storage Information** panel, select Option 1, SDB TCBs.
2. Press ENTER. The system displays the **Shadow Mainframe Adapter Server TCB Storage** panel shown in Figure 3–17.

```

----- Shadow Mainframe Adapter Server TCB Stor-
age          SCR 1 ROW 1 OF 26
COMMAND ==>                                SCROLL ==> PAGE
Line Commands:  F Format  P Print CB  S Show CB  D Display Details

```

TCB ADDRESS	ALLOCATED < 16 MEG	ALLOCATED > 16 MEG	UTILIZED < 16 MEG	UTILIZED > 16 MEG	NOTE
008F6898	0.747	31.215	0.725	31.132	
008FDE28	0.098	0.524	0.073	0.489	
008FE1B8	0.055	0.223	0.014	0.183	
008D1790	0.036	0.196	0.021	0.179	
00815960	0.024	7.059	0.012	7.036	
008D1338	0.012	3.004	0.005	2.995	
008F6030	0.012	104.516	0.005	104.509	
008D0B00	0.008	0.176	0.004	0.173	
008D0D90	0.008	0.008	0.005	0.003	
008733C8	0.008	0.200	0.004	0.193	
0080F5F8	0.004	1.395	0.001	1.378	
00800AC8	0.004	1.407	0.001	1.386	
008D0870	0.004	0.372	0.001	0.361	
0080DA60	0.004	0.215	0.001	0.199	
0080AE88	0.004	1.407	0.001	1.386	
008D0558	0.004	0.000	0.001	0.000	
00815240	0.004	0.176	0.001	0.173	
008D0230	0.004	0.000	0.001	0.000	
00815E88	0.004	0.000	0.001	0.000	
0080DCF0	0.004	0.215	0.001	0.199	
0080DE88	0.004	0.215	0.001	0.199	
0080D288	0.004	0.219	0.001	0.201	
0080D788	0.004	1.411	0.001	1.390	
0080F438	0.004	0.180	0.001	0.173	
008FF1D8	0.000	0.051	0.000	0.047	

**Figure 3–17. Shadow ISPF Virtual Storage by TCBs**

There are two panels that comprise the Shadow Mainframe Adapter Server TCB Virtual Storage application. Use the **LEFT** and **RIGHT** scroll commands (or PF keys) to shift between them.

- Use the available line commands in Table 3–11 on page 3-21 to perform the appropriate function(s).

**Shadow Web Interface Users.** To start the Shadow Mainframe Adapter Server TCB Virtual Storage Summary application:

- From the main menu, select **Storage** → **TCB Storage Summary**. The system displays the **TCB Storage Summary** screen, as shown in Figure 3–18.

The screenshot shows the Shadow Server web interface. At the top, there is a header with the NEON logo and the text 'Shadow Server™'. Below the header, there are links for 'home', 'neon home', and 'support'. A navigation menu is on the left side, listing categories like Product, Storage, Trace Browse, Communications, Database, CICS, IMS, RRS, and TSO. The main content area is titled 'TCB Storage Summary' and contains a table with the following data:

Actions	TCB Address	Allocated < 16 Meg	Allocated > 16 Meg	Used < 16 Meg	Used > 16 Meg	Free < 16 Meg	Free > 16 Meg	Program Name	Connection ID	User ID
<a href="#">Format</a> , <a href="#">VSIF</a> , <a href="#">TCB</a>	008E9860	0.829	31.508	0.807	31.324	0.022	0.185	OPINAS	00135162	NONE
<a href="#">Format</a> , <a href="#">VSIF</a> , <a href="#">TCB</a>	008FDE48	0.098	0.516	0.073	0.485	0.026	0.032	IEFSDD60	N.A.	NONE
<a href="#">Format</a> , <a href="#">VSIF</a> , <a href="#">TCB</a>	008FE1D8	0.055	0.223	0.014	0.183	0.042	0.041	IEAVAR00	N.A.	NONE
<a href="#">Format</a> , <a href="#">VSIF</a> , <a href="#">TCB</a>	008D1930	0.036	0.196	0.021	0.179	0.015	0.018	OPIMSR	00135165	NONE
<a href="#">Format</a> , <a href="#">VSIF</a> , <a href="#">TCB</a>	00819D90	0.028	3.879	0.012	3.855	0.016	0.025	SEFFULL	00135168	NONE
<a href="#">Format</a> , <a href="#">VSIF</a> , <a href="#">TCB</a>	008190F0	0.012	3.004	0.005	2.995	0.008	0.010	GLVA	00135166	NONE
<a href="#">Format</a> , <a href="#">VSIF</a> , <a href="#">TCB</a>	008E9138	0.012	104.516	0.005	104.509	0.008	0.008	TRACE	00135163	NONE

**Figure 3–18. Shadow Web Interface Virtual Storage by TCBs**

Use the vertical and horizontal scrollbars to navigate this screen.

- Use the available action commands in Table 3–11 on page 3-21 to perform the appropriate function(s).

## Displaying Private Area Information by Subpools

The Shadow Mainframe Adapter Server Subpool Private Storage Summary application provides summary information pertaining to the allocation of virtual storage for each subpool in the Shadow Mainframe Adapter Server's address space.

For each subpool, the subpool number is shown, as well as the amount of storage allocated to that subpool. Also shown is the amount of utilized storage and the amount of free storage. For each class of storage, the total is shown for both below and above the 16 MB line.

All storage sizes are presented as true megabytes rounded up to the nearest one-thousandth of a megabyte.

### Available Commands

The Shadow Mainframe Adapter Server Subpool Private Storage Summary application supports all four scrolling commands (**UP**, **DOWN**, **LEFT**, **RIGHT**) and their PF key equivalents or scroll bar equivalents. It also supports the primary **SORT** and **LOCATE** commands.

In addition, the ISPF and Shadow Web Interface applications support the subpool private area storage commands shown in Table 3–13.

**Table 3–13. Subpool Private Area Storage Commands**

Command Description	ISPF	Web Interface
Formats the information for the selected subpool.	F	Format
Displays the VSIF control block for the selected subpool.	S	VSIF
Prints the VSIF control block for the selected subpool.	P	N/A
Displays a storage summary by subpool for the selected subpool.	D	TCB

To use the subpool private area storage commands, perform one of the following:

- **ISPF panels:** Type the command to the left of the line and press ENTER.
- **Shadow Web Interface:** Click on the selected command.

### *Column Names*

Table 3–14 provides a description for each column name on the ISPF panels as well as the Shadow Web Interface screen. Sort names are provided for users of the ISPF panels.

**Table 3–14. Subpool Storage Column Names**

Column Name	Description	Sort Name (ISPF only)
SUBPOOL	The number of the subpool for which the storage sizes are being displayed.	SUBPOOL
ALLOCATED <16 MEG	The size of the owned blocks of virtual storage allocated to this subpool that reside below the 16 MB line.	BELOW
ALLOCATED >16 MEG	The size of the owned blocks of virtual storage allocated to this subpool that reside above the 16 MB line.	ABOVE
UTILIZED <16 MEG	The size of the owned blocks of virtual storage allocated to this subpool that reside below the 16 MB line minus the amount of free storage within those blocks.	USEDLOW
UTILIZED >16 MEG	The size of the owned blocks of virtual storage allocated to this subpool that reside above the 16 MB line minus the amount of free storage within those blocks.	USEDHIGH
NOT USED <16 MEG	The size of the free storage within the blocks of virtual storage allocated to this subpool that reside below the 16 MB line.	FREELow
NOT USED >16 MEG	The size of the free storage within the blocks of virtual storage allocated to this subpool that reside above the 16 MB line.	FREEHIGH

## Invoking the Subpool Private Storage Summary Application

**ISPF Panel Users.** To start the Shadow Mainframe Adapter Server Subpool Private Storage Summary application:

1. From the **Shadow Mainframe Adapter Server Virtual Storage Information** panel, select Option 2, SDB Subpools.
2. Press ENTER. The system displays the **Shadow Mainframe Adapter Server Pvt Area** panel shown in Figure 3–19.

```
----- Shadow Mainframe Adapter Server Pvt Area
SCR 1 ROW 1 OF 17
COMMAND ==>                                SCROLL ==> PAGE
Line Commands:  F Format  P Print CB  S Show CB  D Display Details
```

SUBPOOL NUMBER	ALLOCATED		UTILIZED		NOTE
	< 16 MEG	> 16 MEG	< 16 MEG	> 16 MEG	
0	0.098	0.102	0.023	0.079	
1	0.000	0.122	0.000	0.106	
10	0.012	1.485	0.012	1.431	
69	0.325	126.047	0.322	126.014	
78	0.000	0.180	0.000	0.180	
131	0.000	0.008	0.000	0.004	
205	0.000	0.516	0.000	0.512	
215	0.000	0.106	0.000	0.103	
225	0.000	0.063	0.000	0.049	
229	0.000	0.356	0.000	0.318	
230	0.504	16.918	0.408	16.704	
236	0.063	0.008	0.058	0.008	
237	0.016	0.008	0.010	0.008	
251	0.024	0.239	0.020	0.230	
252	0.020	8.907	0.015	8.895	
255	0.395	11.465	0.386	11.461	

**Figure 3–19. Shadow ISPF Subpool Private Area Storage**

There are two panels that comprise the Shadow Mainframe Adapter Server Subpool Private Storage Summary application. Use the **LEFT** and **RIGHT** scroll commands (or PF keys) to shift between them.

3. Use the available line commands in Table 3–13 on page 3-25 to perform the appropriate function(s).

**Shadow Web Interface Users.** To start the Shadow Mainframe Adapter Server Subpool Private Storage Summary application:

1. From the main menu, select **Storage →Pvt Area Stg Display**. The system displays the **Pvt Area Stg Display** screen, as shown in Figure 3–20.



Actions	Subpool Number	Allocated < 16 Meg	Allocation >16 Meg	Used <16 Meg	Used >16 Meg	Free < 16 Meg	Free > 16 Meg
<a href="#">Format</a> , <a href="#">VSIF</a> , <a href="#">ICB</a>	0	0.083	0.079	0.023	0.073	0.060	0.006
<a href="#">Format</a> , <a href="#">VSIF</a> , <a href="#">ICB</a>	1	0.000	0.118	0.000	0.105	0.000	0.014
<a href="#">Format</a> , <a href="#">VSIF</a> , <a href="#">ICB</a>	10	0.012	1.469	0.012	1.430	0.000	0.040
<a href="#">Format</a> , <a href="#">VSIF</a> , <a href="#">ICB</a>	69	0.321	118.598	0.318	118.573	0.003	0.025
<a href="#">Format</a> , <a href="#">VSIF</a> , <a href="#">ICB</a>	78	0.000	0.180	0.000	0.180	0.000	0.000
<a href="#">Format</a> , <a href="#">VSIF</a> , <a href="#">ICB</a>	131	0.000	0.004	0.000	0.002	0.000	0.003
<a href="#">Format</a> , <a href="#">VSIF</a> , <a href="#">ICB</a>	205	0.000	0.434	0.000	0.434	0.000	0.001

**Figure 3–20. Shadow Web Interface Subpool Private Area Storage**

Use the vertical and horizontal scrollbars to navigate this screen.

- Use the available action commands in Table 3–13 on page 3-25 to perform the appropriate function(s).

## Displaying Common Area Information by Subpools

The Shadow Mainframe Adapter Server Subpool Common Storage Summary application provides summary information pertaining to the allocation of virtual storage for each subpool in the Shadow Mainframe Adapter Server's address space.

For each subpool, the subpool number is shown, as well as the amount of storage allocated to that subpool. Also shown is the amount of utilized storage and the amount of free storage. For each class of storage, the total is shown for both below and above the 16 MB line.

All storage sizes are presented as true megabytes rounded up to the nearest one-thousandth of a megabyte.

### Available Commands

The Shadow Mainframe Adapter Server Subpool Common Storage Summary application supports all four scrolling commands (**UP**, **DOWN**, **LEFT**, **RIGHT**) and their PF key equivalents or scroll bar equivalents. It also supports the primary **SORT** and **LOCATE** commands.

In addition, the ISPF and Shadow Web Interface applications support the subpool common area storage commands shown in Table 3–15.

**Table 3–15. Subpool Common Area Storage Commands**

Command Description	ISPF	Web Interface
Formats the information for the selected subpool.	F	Format
Displays the VSIF control block for the selected subpool.	S	VSIF
Print the VSIF control block for the selected subpool.	P	N/A
Displays a storage summary by subpool for the selected subpool.	D	TCB

To use the subpool common area storage commands, perform one of the following:

- **ISPF panels:** Type the command to the left of the line and press ENTER.
- **Shadow Web Interface:** Click on the selected command.

### Column Names

Table 3–16 provides a description for each column name on the ISPF panels as well as the Shadow Web Interface screen. Sort names are provided for users of the ISPF panels.

**Table 3–16. Subpool Common Area Storage Column Names**

Column Name	Description	Sort Name (ISPF only)
SUBPOOL	The number of the subpool for which the storage sizes are being displayed.	SUBPOOL
ALLOCATED <16 MEG	The size of the owned blocks of virtual storage allocated to this subpool that reside below the 16 MB line.	BELOW
ALLOCATED >16 MEG	The size of the owned blocks of virtual storage allocated to this subpool that reside above the 16 MB line.	ABOVE
UTILIZED <16 MEG	The size of the owned blocks of virtual storage allocated to this subpool that reside below the 16 MB line minus the amount of free storage within those blocks.	USEDLOW
UTILIZED >16 MEG	The size of the owned blocks of virtual storage allocated to this subpool that reside above the 16 MB line minus the amount of free storage within those blocks.	USEDHIGH
NOT USED <16 MEG	The size of the free storage within the blocks of virtual storage allocated to this subpool that reside below the 16 MB line.	FREELOW
NOT USED >16 MEG	The size of the free storage within the blocks of virtual storage allocated to this subpool that reside above the 16 MB line.	FREEHIGH

## Invoking the Subpool Common Storage Summary

**ISPF Panel Users.** To start the Shadow Mainframe Adapter Server Subpool Common Storage Summary application:

1. From the **Shadow Mainframe Adapter Server Virtual Storage Information** panel, select Option 3, SDB Subpools.
2. Press ENTER. The system displays the **Shadow Mainframe Adapter Server Common Area** panel shown in Figure 3–21.

```

----- Shadow Mainframe Adapter Server Common Area
SCR 1 ROW 1 OF 10
COMMAND ==>                                SCROLL ==> PAGE
Line Commands:  F Format  P Print CB  S Show CB  D Display Details

```

SUBPOOL NUMBER	ALLOCATED		UTILIZED		NOTE
	< 16 MEG	> 16 MEG	< 16 MEG	> 16 MEG	
226	0.047	0.000	0.044	0.000	
227	0.047	1.290	0.029	1.277	
228	0.106	3.352	0.090	3.282	
231	0.735	14.434	0.692	14.292	
239	0.032	1.231	0.029	1.204	
241	0.801	27.668	0.668	27.037	
245	1.430	9.875	0.680	5.287	
247	0.000	0.243	0.000	0.240	
248	0.000	2.290	0.000	2.285	

**Figure 3–21. Shadow ISPF Common Area Storage**

There are two panels that comprise the Shadow Mainframe Adapter Server Subpool Common Storage Summary application. Use the **LEFT** and **RIGHT** scroll commands (or PF keys) to shift between them.

3. Use the available line commands in Table 3–15 on page 3-28 to perform the appropriate function(s).

**Shadow Web Interface Users.** To start the Shadow Mainframe Adapter Server Subpool Common Storage Summary application:

1. From the main menu, select **Storage** → **Common Area Stg Display**. The system displays the **Common Area Stg Display** screen, as shown in Figure 3–22.

Actions	Subpool Number	Allocated < 16 Meg	Allocation >16 Meg	Used <16 Meg	Used >16 Meg	Free < 16 Meg	Free > 16 Meg
<a href="#">Format</a> <a href="#">VSIF</a> <a href="#">TCB</a>	226	0.047	0.000	0.044	0.000	0.004	0.000
<a href="#">Format</a> <a href="#">VSIF</a> <a href="#">TCB</a>	227	0.043	1.274	0.028	1.254	0.016	0.020
<a href="#">Format</a> <a href="#">VSIF</a> <a href="#">TCB</a>	228	0.086	1.610	0.074	1.571	0.013	0.040
<a href="#">Format</a> <a href="#">VSIF</a> <a href="#">TCB</a>	231	0.528	11.317	0.498	11.218	0.031	0.099
<a href="#">Format</a> <a href="#">VSIF</a> <a href="#">TCB</a>	239	0.032	1.114	0.028	1.096	0.004	0.018
<a href="#">Format</a> <a href="#">VSIF</a> <a href="#">TCB</a>	241	0.629	20.422	0.527	19.960	0.103	0.463
<a href="#">Format</a> <a href="#">VSIF</a> <a href="#">TCB</a>	245	1.434	10.321	0.375	4.048	1.060	6.273
<a href="#">Format</a> <a href="#">VSIF</a> <a href="#">TCB</a>	247	0.000	0.247	0.000	0.242	0.000	0.005
<a href="#">Format</a> <a href="#">VSIF</a> <a href="#">TCB</a>	248	0.000	1.864	0.000	1.852	0.000	0.012
<a href="#">Format</a> <a href="#">VSIF</a> <a href="#">TCB</a>	TOTAL	2.797	48.165	1.570	41.238	1.228	6.927

**Figure 3–22. Shadow Web Interface Subpool Common Area Storage**

Use the vertical and horizontal scrollbars to navigate this screen.

- Use the available action commands in Table 3–15 on page 3-28 to perform the appropriate function(s).

## Displaying Allocated Virtual Storage Information

The Shadow Mainframe Adapter Server Allocated Virtual Storage application provides an overview of the allocation of virtual storage in the Shadow Mainframe Adapter Server's address space.

For each region in the address space, the address and size of the region are reported. Within each region, the address and size of each block of allocated virtual storage are displayed.

All storage sizes are presented as true megabytes rounded up to the nearest one-thousandth of a megabyte.

### Available Commands

The Shadow Mainframe Adapter Server Allocated Virtual Storage application supports all four scrolling commands (**UP**, **DOWN**, **LEFT**, **RIGHT**) and their PF key equivalents or scroll bar equivalents. It also supports the primary **SORT** and **LOCATE** commands.

In addition, the ISPF and Shadow Web Interface applications support the allocated virtual storage commands shown in Table 3–17.

**Table 3–17. Allocated Virtual Storage Commands**

Command Description	ISPF	Web Interface
Formats the information for the selected block.	F	Format
Displays the VSIF control block for the selected block.	S	VSIF
Prints the VSIF control block for the selected block.	P	N/A
Displays the contents of the allocated virtual storage at this address space.	D	TCB

To use the allocated virtual storage commands, perform one of the following:

- **ISPF panels:** Type the command to the left of the line and press ENTER.
- **Shadow Web Interface:** Click on the selected command.

### *Column Names*

Table 3–18 provides a description for each column name on the ISPF panels as well as the Shadow Web Interface screen. Sort names are provided for users of the ISPF panels.

**Table 3–18. Allocated Virtual Storage Column Names**

Column Name	Description	Sort Name (ISPF only)
DESCRIPTION	Specifies that the block of storage is used (allocated) or that this is a total line.	DESCRIPTION
REGION ADDRESS	The beginning address of the region.	REGION
REGION SIZE	The size of the region.	REGIONSIZE
BLOCK ADDRESS	The beginning address of the block of allocated storage.	BLOCK
BLOCK SIZE	The size of the block of allocated storage.	BLOCKSIZE

### *Invoking the Allocated Virtual Storage Application*

**ISPF Panel Users.** To start the Shadow Allocated Virtual Storage application:

1. From the **Shadow Mainframe Adapter Server Virtual Storage Information** panel, select Option 4, SDB Allocated.
2. Press ENTER. The system displays the **Shadow Mainframe Adapter Server Allocated Storage** panel shown in Figure 3–23.

```

----- Shadow Mainframe Adapter Server Allocated Storage
---- ROW 1 OF 26
COMMAND ==>                                SCROLL ==> PAGE
Line Commands:  D Display  F Format  P Print CB  S Show CB

```

DESCRIPTION	REGION ADDRESS	REGION SIZE	BLOCK ADDRESS	BLOCK SIZE	NOTE
REGION TOTAL	00001000	0.016	N.A.	0.000	
USED	00005000	8.981	00005000	0.461	
USED	00005000	8.981	0007C000	0.016	
USED	00005000	8.981	00800000	0.004	
USED	00005000	8.981	00802000	0.004	
USED	00005000	8.981	00804000	0.004	
USED	00005000	8.981	00808000	0.024	
USED	00005000	8.981	0080F000	0.942	
REGION TOTAL	00005000	8.981	N.A.	1.454	
USED	0DC00000	1828.000	0DC00000	123.946	
USED	0DC00000	1828.000	157F5000	0.059	
USED	0DC00000	1828.000	1580F000	8.856	
USED	0DC00000	1828.000	1623C000	0.008	
USED	0DC00000	1828.000	1623F000	0.012	
USED	0DC00000	1828.000	16243000	0.743	
USED	0DC00000	1828.000	16302000	0.008	
USED	0DC00000	1828.000	16305000	0.020	
USED	0DC00000	1828.000	1630B000	0.024	
USED	0DC00000	1828.000	16322000	0.364	
USED	0DC00000	1828.000	163A2000	3.051	
USED	0DC00000	1828.000	7E27E000	0.016	
USED	0DC00000	1828.000	7E28B000	0.024	
USED	0DC00000	1828.000	7E294000	0.129	
USED	0DC00000	1828.000	7E2B9000	29.278	
REGION TOTAL	0DC00000	1828.000	N.A.	166.532	

**Figure 3–23. Shadow ISPF Allocated Virtual Storage**

3. Use the available line commands in Table 3–17 on page 3-31 to perform the appropriate function(s).

**Shadow Web Interface Users.** To start the Shadow Allocated Virtual Storage application:

1. From the main menu, select **Storage** → **Allocated Storage**. The system displays the **Allocated Storage** screen, as shown in Figure 3–24.

Actions	Description	Region Address	Region Size	Block Address	Block Size
<a href="#">Format.VSUN</a>	REGION TOTAL	00001000	0.016	N.A.	0.000
<a href="#">Format.VSUN</a>	USED	00005000	8.981	00005000	0.407
<a href="#">Format.VSUN</a>	USED	00005000	8.981	0006F000	0.004
<a href="#">Format.VSUN</a>	USED	00005000	8.981	00072000	0.137
<a href="#">Format.VSUN</a>	USED	00005000	8.981	00807000	0.004
<a href="#">Format.VSUN</a>	USED	00005000	8.981	0080B000	0.958
<a href="#">Format.VSUN</a>	REGION TOTAL	00005000	8.981	N.A.	1.508
<a href="#">Format.VSUN</a>	USED	0DB00000	1829.000	0DB00000	129.110
<a href="#">Format.VSUN</a>	USED	0DB00000	1829.000	15C1D000	0.036
<a href="#">Format.VSUN</a>	USED	0DB00000	1829.000	7E29E000	0.004
<a href="#">Format.VSUN</a>	USED	0DB00000	1829.000	7E2B3000	29.301
<a href="#">Format.VSUN</a>	REGION TOTAL	0DB00000	1829.000	N.A.	158.450
<a href="#">Format.VSUN</a>	OVERALL TOTAL	N.A.	1837.997	N.A.	159.958

Figure 3–24. Shadow Web Interface Allocated Virtual Storage

- Use the available action commands in Table 3–17 on page 3-31 to perform the appropriate function(s).

## Displaying Unallocated Virtual Storage Information

The Shadow Mainframe Adapter Server Unallocated Virtual Storage application provides an overview of the unallocated virtual storage in the Shadow Mainframe Adapter Server's address space.

For each region in the address space, the address and size of the region are reported. Within each region, the address and size of each block of unallocated virtual storage are displayed.

All storage sizes are presented as true megabytes rounded up to the nearest one-thousandth of a megabyte.

### Available Commands

The Shadow Mainframe Adapter Server Unallocated Virtual Storage application supports all four scrolling commands (**UP**, **DOWN**, **LEFT**, **RIGHT**) and their PF key equivalents or scroll bar equivalents. It also supports the primary **SORT** and **LOCATE** commands.

In addition, the ISPF and Shadow Web Interface applications support the unallocated virtual storage commands shown in Table 3–19.

**Table 3–19. Unallocated Virtual Storage Commands**

Command Description	ISPF	Web Interface
Formats the information for the selected block.	F	Format
Displays the VSIF control block for the selected block.	S	VSIF
Prints the VSIF control block for the selected block.	P	N/A
Displays the contents of the unallocated virtual storage at this address space.	D	TCB

To use the unallocated virtual storage commands, perform one of the following:

- **ISPF panels:** Type the command to the left of the line and press ENTER.
- **Shadow Web Interface:** Click on the selected command.

### *Column Names*

Table 3–20 provides a description for each column name on the ISPF panels as well as the Shadow Web Interface screen. Sort names are provided for users of the ISPF panels.

**Table 3–20. Unallocated Virtual Storage Column Names**

Column Name	Description	Sort Name (ISPF only)
DESCRIPTION	Specifies that the block of storage is free (unallocated) or that this is a total line.	DESCRIPTION
REGION ADDRESS	The beginning address of the region.	REGION
REGION SIZE	The size of the region.	REGIONSIZE
BLOCK ADDRESS	The beginning address of the block of unallocated virtual storage.	BLOCK
BLOCK SIZE	The size of the block of unallocated virtual storage.	BLOCKSIZE

### *Invoking the Unallocated Virtual Storage Application*

**ISPF Panel Users.** To start the Shadow Mainframe Adapter Server Unallocated Virtual Storage application:

1. From the **Shadow Mainframe Adapter Server Virtual Storage Information** panel, select Option 5, SDB Unalloc.
2. Press ENTER. The system displays the **Shadow Mainframe Adapter Server Unallocat** panel shown in Figure 3–25.



```

----- Shadow Mainframe Adapter Server Unallo-
cat          ROW 1 OF 21
COMMAND ==>                                SCROLL ==> PAGE
Line Commands:  F Format  P Print CB  S Show CB

```

DESCRIPTION	REGION ADDRESS	REGION SIZE	BLOCK ADDRESS	BLOCK SIZE	NOTE
FREE	00001000	0.016	00001000	0.016	
REGION TOTAL	00001000	0.016	N.A.	0.016	
FREE	00005000	8.981	00080000	7.500	
FREE	00005000	8.981	00801000	0.004	
FREE	00005000	8.981	00803000	0.004	
FREE	00005000	8.981	00805000	0.012	
REGION TOTAL	00005000	8.981	N.A.	7.520	
FREE	0DC00000	1828.000	15806000	0.036	
FREE	0DC00000	1828.000	16146000	0.961	
FREE	0DC00000	1828.000	1623E000	0.004	
FREE	0DC00000	1828.000	16242000	0.004	
FREE	0DC00000	1828.000	16301000	0.004	
FREE	0DC00000	1828.000	16304000	0.004	
FREE	0DC00000	1828.000	1630A000	0.004	
FREE	0DC00000	1828.000	16311000	0.067	
FREE	0DC00000	1828.000	1637F000	0.137	
FREE	0DC00000	1828.000	167B3000	1658.793	
FREE	0DC00000	1828.000	7E282000	0.012	
FREE	0DC00000	1828.000	7E292000	0.004	
REGION TOTAL	0DC00000	1828.000	N.A.	1660.028	

**Figure 3–25. Shadow ISPF Unallocated Virtual Storage**

- Use the available line commands in Table 3–19 on page 3-34 to perform the appropriate function(s).

**Shadow Web Interface Users.** To start the Shadow Mainframe Adapter Server Unallocated Virtual Storage application:

- From the main menu, select **Storage** → **Unallocated Storage**. The system displays the **Unallocated Storage** screen, as shown in Figure 3–26.

Actions	Description	Region Address	Region Size	Block Address	Block Size
<a href="#">Format, VSUN</a>	FREE	00001000	0.016	00001000	0.016
<a href="#">Format, VSUN</a>	REGION TOTAL	00001000	0.016	N.A.	0.016
<a href="#">Format, VSUN</a>	FREE	00005000	8.981	0006D000	0.008
<a href="#">Format, VSUN</a>	FREE	00005000	8.981	00070000	0.008
<a href="#">Format, VSUN</a>	FREE	00005000	8.981	00095000	7.446
<a href="#">Format, VSUN</a>	FREE	00005000	8.981	00808000	0.012
<a href="#">Format, VSUN</a>	REGION TOTAL	00005000	8.981	N.A.	7.473
<a href="#">Format, VSUN</a>	FREE	0DB00000	1829.000	15C1C000	0.004
<a href="#">Format, VSUN</a>	FREE	0DB00000	1829.000	15C26000	6.020
<a href="#">Format, VSUN</a>	FREE	0DB00000	1829.000	16400000	1662.618
<a href="#">Format, VSUN</a>	FREE	0DB00000	1829.000	7E29F000	0.079
<a href="#">Format, VSUN</a>	REGION TOTAL	0DB00000	1829.000	N.A.	1668.719
<a href="#">Format, VSUN</a>	OVERALL TOTAL	N.A.	1837.997	N.A.	1676.208

Figure 3–26. Shadow Web Interface Unallocated Virtual Storage

- Use the available action commands in Table 3–19 on page 3-34 to perform the appropriate function(s).

## Displaying Both Allocated and Unallocated Virtual Storage Information

The Shadow Mainframe Adapter Server Virtual Storage application provides an overview of all virtual storage, both allocated and unallocated, in the Shadow Mainframe Adapter Server's address space.

For each region in the address space, the address and size of the region are reported. Within each region, the address and size of each block of allocated and unallocated virtual storage are displayed.

All storage sizes are presented as true megabytes rounded up to the nearest one-thousandth of a megabyte.

### Available Commands

The Shadow Mainframe Adapter Server Virtual Storage application supports all four scrolling commands (**UP**, **DOWN**, **LEFT**, **RIGHT**) and their PF key equivalents or scroll bar equivalents. It also supports the primary **SORT** and **LOCATE** commands.

In addition, the ISPF and Shadow Web Interface applications support the virtual storage commands shown in Table 3–21.

**Table 3–21. Virtual Storage Commands**

Command Description	ISPF	Web Interface
Formats the information for the selected block.	F	Format
Displays the VSIF control block for the selected block.	S	VSIF
Prints the VSIF control block for the selected block.	P	N/A
Displays the contents of the virtual storage at this address space.	D	TCB

To use the virtual storage commands, perform one of the following:

- **ISPF panels:** Type the command to the left of the line and press ENTER.
- **Shadow Web Interface:** Click on the selected command.

### *Column Names*

Table 3–22 provides a description for each column name on the ISPF panels as well as the Shadow Web Interface screen. Sort names are provided for users of the ISPF panels.

**Table 3–22. Virtual Storage Column Names**

Column Name	Description	Sort Name (ISPF only)
DESCRIPTION	Specifies that the block of storage is free (unallocated) or used (allocated) or that this is a total line.	DESCRIPTION
REGION ADDRESS	The beginning address of the region.	REGION
REGION SIZE	The size of the region.	REGIONSIZE
BLOCK ADDRESS	The beginning address of the block of virtual storage.	BLOCK
BLOCK SIZE	The size of the block of virtual storage.	BLOCKSIZE

### *Invoking the Virtual Storage Application*

**ISPF Panel Users.** To start the Shadow Mainframe Adapter Server Virtual Storage application:

1. From the **Shadow Mainframe Adapter Server Virtual Storage Information** panel, select Option 6, SDB Both.
2. Press ENTER. The system displays the **Shadow Mainframe Adapter Server Virtual Storage** panel shown in Figure 3–27.

```

----- Shadow Mainframe Adapter Server Virtual Storage
----- ROW 1 OF 39
COMMAND ==>
Line Commands:  D Display  F Format  P Print CB  S Show CB
                SCROLL ==> PAGE

```

DESCRIPTION	REGION ADDRESS	REGION SIZE	BLOCK ADDRESS	BLOCK SIZE	NOTE
FREE	00001000	0.016	00001000	0.016	
REGION TOTAL	00001000	0.016	N.A.	0.016	
USED	00005000	8.981	00005000	0.481	
FREE	00005000	8.981	00080000	7.500	
USED	00005000	8.981	00800000	0.004	
FREE	00005000	8.981	00801000	0.004	
USED	00005000	8.981	00802000	0.004	
FREE	00005000	8.981	00803000	0.004	
USED	00005000	8.981	00804000	0.004	
FREE	00005000	8.981	00805000	0.012	
USED	00005000	8.981	00808000	0.969	
REGION TOTAL	00005000	8.981	N.A.	8.981	
USED	0DC00000	1828.000	0DC00000	124.024	
FREE	0DC00000	1828.000	15806000	0.036	
USED	0DC00000	1828.000	1580F000	9.215	
FREE	0DC00000	1828.000	16146000	0.961	
USED	0DC00000	1828.000	1623C000	0.008	
FREE	0DC00000	1828.000	1623E000	0.004	
USED	0DC00000	1828.000	1623F000	0.012	
FREE	0DC00000	1828.000	16242000	0.004	
USED	0DC00000	1828.000	16243000	0.743	
FREE	0DC00000	1828.000	16301000	0.004	

**Figure 3–27. Shadow ISPF Virtual Storage**

3. Use the available line commands in Table 3–21 on page 3-37 to perform the appropriate function(s).

**Shadow Web Interface Users.** To start the Shadow Mainframe Adapter Server Virtual Storage application:

1. From the main menu, select **Storage** → **Virtual Storage**. The system displays the **Virtual Storage** screen, as shown in Figure 3–28.

Actions	Description	Region Address	Region Size	Block Address	Block Size
<a href="#">Format, VSUN</a>	FREE	00001000	0.016	00001000	0.016
<a href="#">Format, VSUN</a>	REGION TOTAL	00001000	0.016	N.A.	0.016
<a href="#">Format, VSUN</a>	USED	00005000	8.981	00005000	0.407
<a href="#">Format, VSUN</a>	FREE	00005000	8.981	0006D000	0.008
<a href="#">Format, VSUN</a>	USED	00005000	8.981	0006F000	0.004
<a href="#">Format, VSUN</a>	FREE	00005000	8.981	00070000	0.008
<a href="#">Format, VSUN</a>	USED	00005000	8.981	00072000	0.137
<a href="#">Format, VSUN</a>	FREE	00005000	8.981	00095000	7.446
<a href="#">Format, VSUN</a>	USED	00005000	8.981	00807000	0.004

**Figure 3–28. Shadow Web Interface Virtual Storage**

- Use the available action commands in Table 3–21 on page 3-37 to perform the appropriate function(s).

## ***Option 19: Displaying National Language Support Tables***

The Shadow Mainframe Adapter Server National Language Support (NLS) Tables application displays built-in and customer-configured National Language control tables, which can be modified.

Each table entry represents a separate National Language character set that can be selected for use within the Mainframe Adapter Server. The tables contain information for converting information to/from ASCII/EBCDIC. Both SBCS (Single Byte Character Set) and DBCS (Double Byte Character Set) tables are shown, intermingled, within the list.

SBCS tables are used to directly convert 1-byte codepoint values between ASCII and EBCDIC. The SBCS table to be used while processing a transaction can be selected individually, as needed, or the system-wide default can be used.

DBCS tables are used to convert 2-byte codepoints between an IBM HOST DBCS codepage and a recognized, ASCII-based double-byte character set standard. DBCS encoding is dynamically selected based on the encoding scheme in use by the communications transport.

The Mainframe Adapter Server creates these National Language tables during early start-up processing. Site-specific modifications can be applied to these built-in tables during start-up to modify individual codepoints.

Generally, if you need to make site-specific modifications, you can readily modify one of the unused National Language tables to tailor it to your specific needs. This can be done on-line, but changes remain in effect only until the Mainframe

Adapter Server is shut down. To make persistent changes, use DEFINE SBCS or DEFINE DBCS statements in the Shadow Mainframe Adapter Server's start-up parameters.

The Shadow Mainframe Adapter Server National Language Support Tables application is available through the Shadow ISPF panels and the Shadow Web Interface.

## Available Commands

The Shadow Mainframe Adapter Server National Language Support Tables application supports all four scrolling commands (**UP**, **DOWN**, **LEFT**, **RIGHT**) and their PF key equivalents or scroll bar equivalents. It also supports the primary **SORT** and **LOCATE** commands.

In addition, the ISPF and Shadow Web Interface applications support the NLS commands shown in Table 3–23.

**Table 3–23. NLS Commands**

Command Description	ISPF	Web Interface
Formats the display data fields into a vertical, read-only list.	F	Format
Prints/dumps the underlying table control block.	P	N/A
Displays/dumps the underlying table control block.	S	Dump
Displays all mapped ASCII-to-EBCDIC conversion codepoint values.	A	A-to-E
Displays all mapped EBCDIC-to-ASCII conversion codepoint values.	E	E-to-A

To use the NLS commands, perform one of the following:

- **ISPF panels:** Type the command to the left of the line and press ENTER.
- **Shadow Web Interface:** Click on the selected command.

## Column Names

Table 3–24 provides a description for each column name on the ISPF panels as well as the Shadow Web Interface screen. Sort names are provided for users of the ISPF panels.

**Table 3–24. NLS Column Names**

<b>Column Name</b>	<b>Description</b>	<b>Sort Name (ISPF only)</b>
NLS NAME	Unique name representing the table.	NAME
NLS TYPE	The type of National Language table -- either SBCS or DBCS.	TYPE
DESCRIPTION	Built-in table description or user-specified comment information.	COMMENT DESC
ASCII CODEPAGE	ASCII Coded Character Set (CCS) codepage name.	ASCII
EBCDIC CODEPAGE	EBCDIC Coded Character Set (CCS) codepage name.	EBCDIC
CHARACTER-SET	Character Encoding Scheme (CES) used for conversion and communications transport.	CHARSET ENCODING
CHANGE DATE/TIME	Date and time of last on-line update.	CHANGED DATE
LAST-CHANGE JOB	Job name that last modified the table.	JOBNAME

## Invoking the NLS Application

### *ISPF Panel Users*

To start the National Language Support application:

1. From the **Shadow Mainframe Adapter Server Control Option Menu**, select Option 19, NLS Tables.
2. Press ENTER. The system displays the **Shadow Mainframe Adapter Server National Languages** panel shown in Figure 3–29.

```

----- Shadow Mainframe Adapter Server National Languages -----
SCR 1 ROW 1 OF 42
COMMAND ===>
Line Commands:  F Format                P Print CB                SCROLL ===> PAGE
                  A ASCII Codepoints    E EBCDIC Codepoints      S Show CB

NLS  NLS  DESCRIPTION OR
NAME TYPE USER-COMMENT                                NOTE
BEL  SBCS Belgian
BIG5 DBCS Big5 Chinese DBCS
CBL  SBCS Canadian Bilingual
DAN  SBCS Danish (MS)
DAN2 SBCS Danish/Norwegian
DEU  SBCS German (MS)
DEU2 SBCS Austrian/German
ENG  SBCS U.K. English (MS)
ENG2 SBCS U.K. English
ENU  SBCS U.S. English (System Default)
ENU2 SBCS U.S. English (NEON Legacy)
ESN  SBCS Modern spanish (MS)
ESP  SBCS Castillian Spanish (MS)
ESP2 SBCS Spanish
FIN  SBCS Finnish (MS)
FIN2 SBCS Finnish/Swedish
FRA  SBCS French (MS)
FRA2 SBCS French
FRC  SBCS Canadian French
HANG DBCS Hangul DBCS
ISL  SBCS Icelandic (MS)
ITA  SBCS Italian (MS)
ITA2 SBCS Italian
JEUC DBCS EUC-JP DBCS
JPE  SBCS Japanese (NEON Legacy)
JPL  SBCS Japanese (IBM-290/IBM-930)
JPX  SBCS Japanese (IBM-1027/IBM-939)
JS78 DBCS Shift-JIS 1978 DBCS
JS83 DBCS Shift-JIS 1983 DBCS
KRCH DBCS Korean DBCS
NLD  SBCS Dutch (MS)
NLD2 SBCS Dutch
NOR  SBCS Norwegian (MS)

```

**Figure 3–29. Shadow ISPF NLS**

3. Use the available line commands in Table 3–23 on page 3-40 to perform the appropriate function(s).



## Shadow Web Interface Users

To start the National Language Support application:

1. From the main menu, select **Product/National Language Support**. The system displays the **National Language Support** screen, as shown in Figure 3–30.

Actions	Name	Type	Description	ASCII Codepage	EBCDIC Codepage	Charset Encoding	Last-Change Date/Time	Last-Changed By
<a href="#">A-to-E</a> , <a href="#">E-to-A</a> , <a href="#">Format</a> , <a href="#">Dump</a>	BEL	SBCS	Belgian	LATIN-1	IBM-500	ISO-8859-1	2001/01/02 17:07	SDBB
<a href="#">A-to-E</a> , <a href="#">E-to-A</a> , <a href="#">Format</a> , <a href="#">Dump</a>	BIG5	DBCS	Big5 Chinese DBCS	IBM-947	IBM-835	big5	2001/01/02 17:07	SDBB
<a href="#">A-to-E</a> , <a href="#">E-to-A</a> , <a href="#">Format</a> , <a href="#">Dump</a>	CBL	SBCS	Canadian Bilingual	LATIN-1	IBM-037	ISO-8859-1	2001/01/02 17:07	SDBB
<a href="#">A-to-E</a> , <a href="#">E-to-A</a> , <a href="#">Format</a> , <a href="#">Dump</a>	DAN	SBCS	Danish (MS)	MS-LATIN-1	IBM-277	ISO-8859-1	2001/01/02 17:07	SDBB
<a href="#">A-to-E</a> , <a href="#">E-to-A</a> , <a href="#">Format</a> , <a href="#">Dump</a>	DAN2	SBCS	Danish/Norwegian	LATIN-1	IBM-277	ISO-8859-1	2001/01/02 17:07	SDBB
<a href="#">A-to-E</a> , <a href="#">E-to-A</a> , <a href="#">Format</a> , <a href="#">Dump</a>	DEU	SBCS	German (MS)	MS-LATIN-1	IBM-273	ISO-8859-1	2001/01/02 17:07	SDBB
<a href="#">A-to-E</a> , <a href="#">E-to-A</a> , <a href="#">Format</a> , <a href="#">Dump</a>	DEU2	SBCS	Austrian/German	LATIN-1	IBM-273	ISO-8859-1	2001/01/02 17:07	SDBB
<a href="#">A-to-E</a> , <a href="#">E-to-A</a> , <a href="#">Format</a> , <a href="#">Dump</a>	ENG	SBCS	U.K. English (MS)	MS-LATIN-1	IBM-285	ISO-8859-1	2001/01/02 17:07	SDBB
<a href="#">A-to-E</a> , <a href="#">E-to-A</a> , <a href="#">Format</a> , <a href="#">Dump</a>	ENG2	SBCS	U.K. English	LATIN-1	IBM-285	ISO-8859-1	2001/01/02 17:07	SDBB
<a href="#">A-to-E</a> , <a href="#">E-to-A</a> , <a href="#">Format</a> , <a href="#">Dump</a>	ENU	SBCS	U.S. English (System Default)	LATIN-1	IBM-1047	ISO-8859-1	2001/01/02 17:07	SDBB
<a href="#">A-to-E</a> , <a href="#">E-to-A</a> , <a href="#">Format</a> , <a href="#">Dump</a>	ENU2	SBCS	U.S. English (NEON Legacy)	NEON-LATIN-1	IBM-1047	ISO-8859-1	2001/01/02 17:07	SDBB
<a href="#">A-to-E</a> , <a href="#">E-to-A</a> , <a href="#">Format</a> , <a href="#">Dump</a>	ESN	SBCS	Modern spanish (MS)	PC-LATIN-1	IBM-284	ISO-8859-1	2001/01/02 17:07	SDBB
<a href="#">A-to-E</a> , <a href="#">E-to-A</a> , <a href="#">Format</a> , <a href="#">Dump</a>	ESP	SBCS	Castilian Spanish (MS)	MS-LATIN-1	IBM-284	ISO-8859-1	2001/01/02 17:07	SDBB
<a href="#">A-to-E</a> , <a href="#">E-to-A</a> , <a href="#">Format</a> , <a href="#">Dump</a>	ESP2	SBCS	Spanish	LATIN-1	IBM-284	ISO-8859-1	2001/01/02 17:07	SDBB
<a href="#">A-to-E</a> , <a href="#">E-to-A</a> , <a href="#">Format</a> , <a href="#">Dump</a>	FIN	SBCS	Finnish (MS)	MS-LATIN-1	IBM-278	ISO-8859-1	2001/01/02 17:07	SDBB
<a href="#">A-to-E</a> , <a href="#">E-to-A</a> , <a href="#">Format</a> , <a href="#">Dump</a>	FIN2	SBCS	Finnish/Swedish	LATIN-1	IBM-278	ISO-8859-1	2001/01/02 17:07	SDBB

**Figure 3–30. Shadow Web Interface NLS**

2. Use the available action commands in Table 3–23 on page 3-40 to perform the appropriate function(s).



# CHAPTER 4: **Shadow Mainframe Adapter Server: Communications**

---

---

This chapter describes the Remote Users application and the Link Control application, both of which are features provided by Shadow Mainframe Adapter Server, the Mainframe Adapter Server component of the Shadow product.

Topics include:

- Overview
  - Remote Users Application
  - Link Control Application
- Remote Users Application
  - Available Commands
  - Column Names
  - Invoking the Remote Users Application
  - Using the Kill Command to Terminate a User Connection
- Link Control Application
  - Available Commands
  - Column Names
  - Invoking the Link Control Application

## **Overview**

### ***Remote Users Application***

Shadow Mainframe Adapter Server has several means of communicating information to its users. With the Remote Users application, you can view current and cumulative information regarding users connected to the local Shadow Mainframe Adapter Server. With the Link Control application, you can view application and control information across inter-SDB teleprocessing links.

### ***Link Control Application***

Shadow Mainframe Adapter Server communicates application and control information across inter-SDB teleprocessing links. With the Link Control application, you can view and control these links, as well as determine and change their status. Shadow Mainframe Adapter Server supports two types of links:

- SNA Logical Unit 6.2 (LU 6.2)
- Transmission Control Protocol/Internet Protocol (TCP/IP)

This section describes how links are activated, deactivated, and monitored by means of the Shadow ISPF panels or the Shadow Web Interface screens.

## Remote Users Application

This section will cover the following topics:

- Available Commands
- Column Names
- Invoking the Remote Users Application
- Using the **Kill** Command to Terminate a User Connection

### Available Commands

The Remote Users application supports all four scrolling commands (**UP**, **DOWN**, **LEFT**, **RIGHT**) and their PF key equivalents or scroll bar equivalents. It also supports the primary **SORT** and **LOCATE** commands.

In addition, the ISPF and Shadow Web Interface application supports the remote user commands shown in Table 4–1.

**Table 4–1. Remote User Commands**

Command Description	ISPF	Web Interface
Cancels the thread.	C	Cancel
Starts the SQL Explain application (requires MVS/Quick-Ref).	E	N/A
Formats the information for the selected row.	F	Format
Displays user information for the selected row.	I	Userinfo
Kills the selected user (see “Using the Kill Command to Terminate a User Connection” on page 4-6).	K	Kill
Prints the associated control block for the selected row.	P	N/A
Starts the Control Block Browse sub-application.	S	Block
Invokes the SQL Trace sub-application.	T	Utrace
Displays user detail for the selected row.	U	Udetail

To use remote user commands, perform one of the following:

- **ISPF panels:** Type the command to the left of the line and press ENTER.
- **Shadow Web Interface:** Click on the selected command.

## Column Names

Table 4–2 provides a description for each column name on the ISPF panels as well as the Shadow Web Interface screen. Sort names are provided for users of the ISPF panels.

**Table 4–2. Remote User Column Names**

Column Name	Description	Sort Name (ISPF only)
HOST USERID	The identifier of the remote user.	USER
LAN USERID	The LAN userid of the remote user.	LAN
HOST NAME	The link that is being used. <ul style="list-style-type: none"> <li>For attached users, this is the name of the remote system that is being accessed.</li> <li>For remote users, this is the name of the remote system that is accessing the local system.</li> </ul>	HOST
LINK TYPE	Identifies the communication protocol.	TYPE
APPLICATION NAME	Application name specified in the APNA (Application Name) keyword of the Shadow data source.	APPLICATION
TCP/IP IPADDRESS	A 4-byte Internet Protocol (IP) network address of a node.	IPADDR
USER PARAMETER	User parameter specified in the USERPARM (Host User Parm) keyword of the Shadow data source.	
REMOTE PORT	The port being used by the remote Shadow Mainframe Adapter Server system.	REMOTE
LOCAL PORT	The TCP/IP port used by the remote SDB.	LOCAL
IUCV PATH	A token used by SDB to communicate with TCP/IP.	PATH
SOCKET NUMBER	A number identifying a TCP/IP session.	SOCKET
DB2 SUBS	DB2 subsystem to which the remote user is connected.	DB2
PLAN NAME	The plan used to open a DB2 thread.	PLAN
SQL RC	Most recent DB2 interface return code.	SQLRC
SQL REASON	Most recent DB2 interface reason code.	REASON
SQL CODE	Most recent SQLCA SQLCODE field value.	SQLCODE
SQL STMT-TYPE	The SQL verb.	SQLTYPE
STATEMENT NUMBER	Pre-processor built SQL statement number.	STMTNO
CURSOR NUMBER	Number of the cursor being used.	CURSOR
LOCKS HELD	Number of locks held.	
PROGRAM NAME	Shadow Mainframe Adapter Server transaction program name.	PROGRAM

**Table 4–2. Remote User Column Names (continued)**

<b>Column Name</b>	<b>Description</b>	<b>Sort Name (ISPF only)</b>
CPU TIME	Total CPU time.	
SQL COUNT	The number of SQL operations executed. Included in this count are SQL executed, RPCs or stored procedures executed, rollbacks or commits specifically initiated from the Mainframe Adapter Client via a Shadow call, and operations to turn auto-commit off or on.	SQLCOUNT
CONNECT TIME	Total elapsed time.	CONNECT
CONNECT STATE	<ul style="list-style-type: none"> <li>• PROCESS: In DB2 or application</li> <li>• SEND: Send in progress</li> <li>• RECEIVE: Receive in progress</li> </ul>	STATE
STATE DURATION	Amount of time in current state.	DURATION
FUNCTION CODE	Type of SDB processing.	FUNCTION
GENERIC USERID		GENERIC
EXTENDED USERID		EXTENDED
<b>TOTAL SENT</b>	Refers to cumulative outbound data.	
TOTAL RAW SENT	Kilobytes before compression.	TOSENTR
TOTAL COMPRESSED SENT	Kilobytes after compression.	TOSENTC
TOTAL PERCENT SENT	$(1-(\text{COMPRESSED}/\text{RAW})) * 100$	TOSENTP
<b>CURRENT SENT</b>	Refers to last outbound transmission.	
CURRENT RAW SENT	Kilobytes before compression.	CUSENTR
CURRENT COMPRESSED SENT	Kilobytes after compression.	CUSENTC
CURRENT PERCENT SENT	$(1-(\text{COMPRESSED}/\text{RAW})) * 100$	CUSENTP
<b>TOTAL RECEIVED</b>	Refers to cumulative inbound data.	
TOTAL RAW RECEIVED	Kilobytes before compression.	TORECVR
TOTAL COMPRESSED RECEIVED	Kilobytes after compression.	TORECVC
TOTAL PERCENT RECEIVED	$(1-(\text{COMPRESSED}/\text{RAW})) * 100$	TORECVP
<b>CURRENT RECEIVED</b>	Refers to last inbound transmission.	
CURRENT RAW RECEIVED	Kilobytes before compression.	CURECVR
CURRENT COMPRESSED RECEIVED	Kilobytes after compression.	CURECVC
CURRENT PERCENT RECEIVED	$(1-(\text{COMPRESSED}/\text{RAW})) * 100$	CURECVP

**Table 4–2. Remote User Column Names (continued)**

Column Name	Description	Sort Name (ISPF only)
<b>TELELPROCESSING</b>	Refers to data transfer time.	
MSECS	Number of milliseconds.	TPMSECS
PERCENT	Percentage of total time.	TPPERCNT
<b>HOST PROCESSING</b>	Refers to data extraction time.	
MSECS	Number of milliseconds.	HOMSECS
PERCENT	Percentage of total time.	HOPERCNT
<b>TOTAL TIME</b>	Amount of time it took to process the last transaction.	TOTIME

## Invoking the Remote Users Application

### ISPF Panel Users

To start the Remote Users application:

1. From the **Shadow Mainframe Adapter Server Primary Option Menu**, select Option 4, Remote User.
2. Press ENTER. The system displays the **Shadow Mainframe Adapter Server Remote Users** panel shown in Figure 4–1.

```

----- Shadow Mainframe Adapter Server Remote Users -----
SCR 1 ROW 1 OF 3
COMMAND ==>>>                                SCROLL ==>> PAGE
Line Commands:  C Cancel Thread  E Explain Codes  F Format  I Information
K Kill User    P Print CB  S Show CB  T User Trace  U User Detail

HOST   LAN           HOST           LINK   APPLICATION
USERID USERID           NAME          TYPE   NAME          NOTE
AI38PHV pvu           pvunttest     OTC/IP Not-Set
AI38PHV pvu           pvutcpip      OTC/IP Not-Set

```

**Figure 4–1. Shadow ISPF Remote Users**

There are seven panels that comprise the ISPF Remote Users application. Use the **LEFT** and **RIGHT** scroll commands (or PF keys) to shift between them.

3. Use the available line commands in Table 4–1 on page 4-2 to perform the appropriate function(s).

### Shadow Web Interface Users

To start the Remote Users application:

1. From the main menu, select **Communications** → **Remote Users**. The system displays the remote users screen, as shown in Figure 4–2.

Actions	User ID	LAN Userid	Host Name	Link Type	Application Name	User Parameter	IP Address	Remote	Local	Path ID	Socket Number	DB2 Subsystem Name	DB2 Plan Name
<a href="#">Cancel</a>   <a href="#">Format</a>   <a href="#">Userinfo</a>   <a href="#">KILL</a> <a href="#">Block</a>   <a href="#">Ultrace</a>   <a href="#">Udataill</a>	SDEB		10.17.16.69	OTC/IP	Not-Set	Not-Set	10.17.16.69	4439	1200	0	1		Not-Set

**Figure 4–2. Shadow Web Interface Remote Users**

Use the vertical and horizontal scrollbars to navigate this screen.

2. Use the available action commands in Table 4–1 on page 4-2 to perform the appropriate function(s).

## Using the Kill Command to Terminate a User Connection

In the Remote User application, the **Kill** line command can be used to terminate a remote user’s connection with Shadow Mainframe Adapter Server . The kill operation will close the entire TCP/IP session with the Mainframe Adapter Client.



### Note:

If you use the **Kill** command, the task supporting the remote Mainframe Adapter Client will fail with an X ‘222’ abend. There will be no reason code associated with this event.

The trace browse application will show the following:

- The authorization request for the kill operation (see “Authorization” on page 4-7).
- The abend of the remote user’s thread.
- The close and sever of the remote session.

The **Kill** operation will fail if the target Mainframe Adapter Client is terminated before the operation was executed. Failure will most likely occur when the **Kill** line command is entered some time after the Remote Users display was requested.



### Note:

The Remote Users display is not automatically updated.



## Authorization

The **Kill** command can only be issued when a user has authorization to do so. Authorization will be granted in two cases:

- When the user been granted UPDATE authority to the USERS resource.
- When the userid of the person attempting to kill the connection is the same as the userid of the Mainframe Adapter Client being killed. In this case, the UPDATE authority will not be checked.

## Link Control Application

This section will cover the following topics:

- Available Commands
- Column Names
- Invoking the Link Control Application

### Available Commands

The Link Control supports all four scrolling commands (**UP**, **DOWN**, **LEFT**, **RIGHT**) and their PF key and scroll bar equivalents. It also supports the **SORT** and **LOCATE** commands.

In addition, the ISPF and Shadow Web Interface applications support the link control commands shown in Table 4–3.

**Table 4–3. Link Control Commands**

Command Description	ISPF	Web Interface
Changes a link status to the ANY status.	A	Any
Displays user details for a selected row.	B	Udetail
Changes the desired status of the link to DOWN.	D	Down
Formats the link control information for the selected row.	F	Block
Prints the CMLI control block for the selected row.	P	N/A
Displays the CMLI control block for the selected row.	S	CMLI
Displays a SQL trace of the last session started on this link.	T	SQL
Changes the desired status of the link to UP.	U	Up

**Notes:**

**LU 6.2 links:** If you reset the desired status from UP to DOWN, no new LU 6.2 sessions will be allowed to start and the link will terminate. If you set the desired status from DOWN to UP, the product will try to start sessions continually until they are successfully started. If you set the desired status of a link to ANY, the product will make no further effort to initiate or terminate sessions. *(This only applies to LU 6.2-based links.)*

**TCP/IP links:** TCP/IP links are established as needed.

To use link control commands, perform one of the following:

- **ISPF panels:** Type the command to the left of the line and press ENTER.
- **Shadow Web Interface:** Click on the selected command.

## Column Names

Table 4–4 provides a description for each column name on the ISPF panels as well as the Shadow Web Interface screen. Sort names are provided for users of the ISPF panels.

**Table 4–4. Link Control Column Names**

Column Name	Description	Sort Name (ISPF only)
HOST NAME	An EBCDIC string designating a host.	HOST
LINK TYPE	An EBCDIC string designating a host.	LINK
TRUSTED HOST	<ul style="list-style-type: none"> <li>• YES: Indicates that the remote host does not require a userid/password.</li> <li>• NO: Indicates that the remote host requires a userid/password.</li> </ul>	TRUSTED
LAST USERID	The last userid for the selected row.	USERID
ACTUAL STATUS	<ul style="list-style-type: none"> <li>• UP: Indicates that the link is available for work.</li> <li>• DOWN: Indicates that the link is unavailable for work.</li> <li>• UNKNOWN: Indicates that the link is in transition.</li> </ul>	ACTSTAT
DESIRED STATUS	<ul style="list-style-type: none"> <li>• UP: Indicates that the link should be available for work.</li> <li>• DOWN: Indicates the link should be unavailable for work.</li> </ul>	DESSTAT
TOTAL SESSION	The maximum number of sessions.	TOTSE
ACTUAL SESSIONS	The number of allocated sessions.	ACTSE
LU 6.2 MODE (For ISPF panels only)	The name of the logon mode entry used.	MODE
LU 6.2 WINNERS (For ISPF panels only)	The number of sessions where the local system is guaranteed to win any contention with the remote system.	WINNERS

**Table 4–4. Link Control Column Names (continued)**

Column Name	Description	Sort Name (ISPF only)
LU 6.2 LOSERS (For ISPF panels only)	The number of sessions where the local system is guaranteed to lose any contention with the remote system.	LOSERS
VTAM MODE NAME (For Web Interface only)		
WINNERS (For Web Interface only)		
LOSERS (For Web Interface only)		
TCP/IP ADDRESS	A 4 -byte Internet Protocol (IP) network address of a node. Together, the port number and IP address uniquely identify an SDB system.	IPADDR
TCP/IP PORT	A number used to access a specific application in the TCP/IP environment. Together, the port number and IP address uniquely identify an SDB system.	PORT
NOTE (For ISPF panels only)	Indicates the last line command.	

## Invoking the Link Control Application

### ISPF Panel Users

To start the Link Control application:

1. From the **Shadow Mainframe Adapter Server Primary Option Menu**, select Option 1, Link.
2. Press **Enter**. The system displays the **Shadow Mainframe Adapter Server Link Control** panel shown in Figure 4–3.

```

----- Shadow Mainframe Adapter Server Link Control -----
- SCR 1 ROW 1 OF 9
COMMAND ==>>                                SCROLL ==>> PAGE
Line Commands:  F Format  S Show CB  U Bring up  D Bring Down  A Any OK
                P Print CB  T User Trace  B User Detail

HOST           LINK   TRUSTED  LAST      ACTUAL    DESIRED
NAME           TYPE   HOST     USERID   STATUS    STATUS    NOTE
aseuffert      OTC/IP No      AI38AAS  N.A.     N.A.
camaro         OTC/IP No      AI38YTY  N.A.     N.A.
katy           OTC/IP No      AI38PHV  N.A.     N.A.
loginid       OTC/IP No      AI38GW   N.A.     N.A.
pvunttest     OTC/IP No      AI38PHV  N.A.     N.A.
pvutcpip      OTC/IP No      AI38PHV  N.A.     N.A.
wmorton       OTC/IP No      AI38WM   N.A.     N.A.
DEV1          OTC/IP No      Not-Set  Up       N.A.

```

### Figure 4–3. Shadow ISPF Link Control

There are three panels that comprise the ISPF Link Control application. Use the **LEFT** and **RIGHT** scroll commands (or **PF** keys) to shift between them.

- Use the available line commands in Table 4–3 on page 4-7 to perform the appropriate function(s).

## Shadow Web Interface Users

To start the Link Control application:

- From the main menu, select **Communications** → **Link Controls**. The system displays the **Link Control** screen, as shown in Figure 4–4.

Actions	Host Name	Link Type	Trusted Host	User ID	Actual Status	Desired Status	Total Session Count	Active Sessions	VTAM Mode Name	Winners	Losers	IP Address	Port Number
<a href="#">ANY</a> , <a href="#">Udetail</a> , <a href="#">DOWN</a> , <a href="#">Block</a> , <a href="#">CMLI</a> , <a href="#">SQL</a> , <a href="#">UP</a>	jlin	OTC/IP	No	AI38PDS	N.A.	N.A.	0	0	*	*	*	10.17.16.61	1320
<a href="#">ANY</a> , <a href="#">Udetail</a> , <a href="#">DOWN</a> , <a href="#">Block</a> , <a href="#">CMLI</a> , <a href="#">SQL</a> , <a href="#">UP</a>	DEV1	OTC/IP	No	Not-Set	Up	N.A.	0	0	*	*	*	10.17.16.23	1200
<a href="#">ANY</a> , <a href="#">Udetail</a> , <a href="#">DOWN</a> , <a href="#">Block</a> , <a href="#">CMLI</a> , <a href="#">SQL</a> , <a href="#">UP</a>	10.17.16.69	OTC/IP	No	Not-Set	N.A.	N.A.	0	0	*	*	*	10.17.16.69	4439

Figure 4–4. Shadow Web Interface Link Control

- Use the available action commands in Table 4–3 on page 4-7 to perform the appropriate function(s).

# CHAPTER 5: *Shadow Mainframe Adapter Server: Database Control*

---

---

This chapter covers the Database Control application, a feature of the Shadow Mainframe Adapter Server, the Mainframe Adapter Server component of the Shadow product.

Topics include:

- Overview
- Database Control Application
  - Option 1: Displaying and Controlling the Database Table.
  - Option 2: Displaying Shadow Mainframe Adapter Server Performance Data.

## Overview

The Database Control application allows you to view and modify the Shadow Mainframe Adapter Server database table, as well as display performance data. This information can be obtained by means of the Shadow ISPF panels or the Shadow Web Interface screens.

## Database Control Application

The main panel of the Shadow Mainframe Adapter Server Database Control application is shown in Figure 5–1.

```
----- Monitor and Control Database Access ----- Subsystem SDBB
OPTION  ===>

  1 Databases          - Display and control Database Table
  2 Monitor           - Display Shadow Mainframe Adapter Server performance data
  3 RRS               - Monitor and control RRS (transactions)
```

**Figure 5–1. Database Control Application**

This menu offers three options from which you can choose. These options include:

- Option 1: Displaying and controlling the database table.
- Option 2: Displaying Shadow Mainframe Adapter Server performance data.
- Option 3: Monitoring and controlling RRS transactions.

Options 1 and 2 will be covered in this chapter, including the following information for each option:

- An overview
- Available commands
- Column names
- Invoking the application



**Note:**

Option 3 is covered in the *Shadow Enterprise Transactions User Documentation*.

## Option 1: Displaying and Controlling the Database Table

With this option, you can view and modify the Shadow Mainframe Adapter Server database table. This table maps database names to entries in the Link table (see “Link Control Application” on page 4-7 of Chapter 4, “Shadow Mainframe Adapter Server: Communications”). You can associate a database name with a new host name (link) using a line command.

### Available Commands

The Database Control application supports all four scrolling commands (**UP**, **DOWN**, **LEFT**, **RIGHT**) and their PF key equivalents or scroll bar equivalents. It also supports the primary **SORT** and **LOCATE** commands.

In addition, the ISPF and Shadow Web Interface applications support the database table control commands shown in Table 5–1.

**Table 5–1. Database Table Control Commands**

Command Description	ISPF	Web Interface
Formats database information for the selected row.	F	Format
Prints the associated control block for the selected row.	P	N/A
Displays the control block for the selected row.	S	CMDB
Clears the control block for the selected row.	C	Clear

To use Database Table control commands, perform one of the following:

- **ISPF panels:** Type the command to the left of the line and press ENTER.
- **Shadow Web Interface:** Click on the selected command.

## Column Names

Table 5–2 provides a description for each column name on the ISPF panels as well as the Shadow Web Interface screen. Sort names are provided for users of the ISPF panels.

**Table 5–2. Database Table Control Column Names**

Column Name	Description	Sort Name (ISPF only)
DATABASE NAME	The name of the database as it will be referred to in the application programs.	DATABASE
DATABASE TYPE	Identifies the type of database management systems for the database name.	TYPE
DATABASE VERSION	The version of the database management system.	VERSION
ACTUAL STATUS	The status of the database management system.	STATUS
COMPLETED REQUESTS	The number of completed requests for the database management system.	COMPLETED REQUESTS
PENDING REQUESTS	The number of pending requests for the database management system.	PENDING REQUESTS
SSCT ADDRESS	The address of the Subsystem Communication Table (SSCT) for the selected database management system.	SSCT ADDRESS
RIB ADDRESS	The address of the Release Information Block (RIB) for the selected database management system.	RIB
COMMAND STRING (for Web Interface only)	The one character prefix that is used when issuing console commands directly to the DB2 sub-system.	

## Invoking the Database Table Control Display

### *ISPF Panel Users*

To start the Database Table Control display:

1. From the **Shadow Mainframe Adapter Server Primary Option Menu**, select Option 8, Databases.
2. Press ENTER. The system displays the **Monitor and Control Database Access** panel, as shown in Figure 5–1.
3. From this menu, select Option 1, Databases.
4. Press ENTER. The system displays the **Shadow Mainframe Adapter Server Database Control** panel shown in Figure 5–2.

```

----- Shadow Mainframe Adapter Server Database Control -----
-- SCR 1 ROW 1 OF 2
COMMAND ==> _____ SCROLL ==> PAGE
Line Commands: C Clear F Format P Print CB S Show CB

DATABASE DB DATABASE DATABASE COMPLETED PENDING
NAME TYPE VERSION STATUS REQUESTS REQUESTS NOTE
DB2C DB2 6.1.0 Down 0 0
    
```

**Figure 5–2. Shadow Database Control**

5. Use the available line commands in Table 5–1 on page 5-2 to perform the appropriate function(s).

### Shadow Web Interface Users

To start the Database Table Control display:

1. From the main menu, select **Database** → **Database Control**. The system displays the **Database Control** screen, as shown in Figure 5–3.

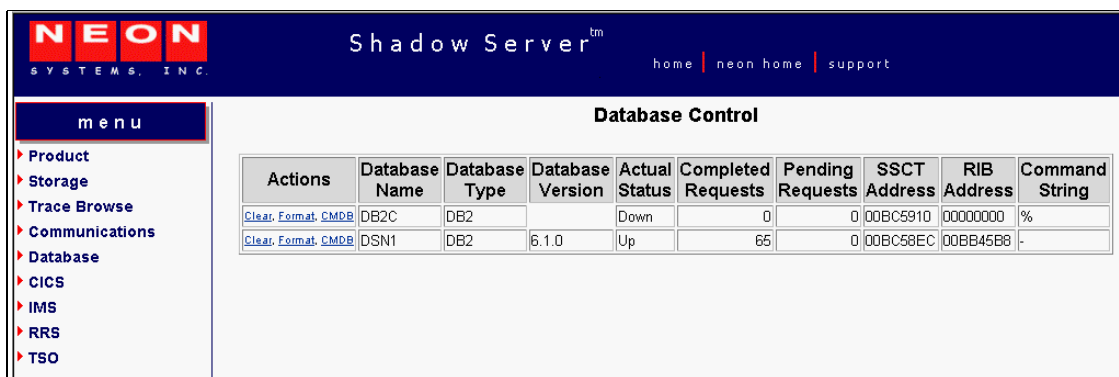

**Figure 5–3. Shadow Web Interface Database Control Users**

Use the vertical and horizontal scrollbars to navigate this screen.

2. Use the available action commands in Table 5–1 on page 5-2 to perform the appropriate function(s).

## Option 2: Displaying Shadow Mainframe Adapter Server Performance Data

With this option, you can view current and cumulative summarized interval trace information.



## Available Commands

The Shadow Mainframe Adapter Server Performance Data application supports all four scrolling commands (**UP**, **DOWN**, **LEFT**, **RIGHT**) and their PF key equivalents or scroll bar equivalents. It also supports the primary **SORT** and **LOCATE** commands.

In addition, the ISPF and Shadow Web Interface applications support the Shadow Mainframe Adapter Server performance commands shown in Figure 5–3.

**Table 5–3. Shadow Mainframe Adapter Server Performance Commands**

Command Description	ISPF	Web Interface
Formats information for the selected row.	F	Format
Prints the associated control block for the selected row.	P	N/A
Displays detail information for the selected row.	S	CMDB
Displays the associated control block for the selected row.	D	Clear

To use Shadow Mainframe Adapter Server performance commands, do one of the following:

- **ISPF panels:** Type the command to the left of the line and press ENTER.
- **Shadow Web Interface:** Click on the selected command.

## Column Names

Table 5–4 provides a description for each column name on the ISPF panels as well as the Shadow Web Interface screen. Sort names are provided for users of the ISPF panels.

**Table 5–4. Shadow Mainframe Adapter Server Performance Column Names**

Column Name	Description	Sort Name (for ISPF only)
INTERVAL START	The start time for the interval.	INTERVAL
USER COUNT	The number of users summarized in the interval.	USER
TOTAL CPU TIME	Total CPU time used.	TOTAL
DATABASE CPU TIME	Amount of CPU time spent in DB2.	DB2
NETWORK CPU TIME	Amount of CPU time spent in network.	NETWORK
REXX CPU TIME	Amount of CPU time spent in REXX.	REXX
RPC CPU TIME	Amount of CPU time spent in RPC.	RPC
OTHER CPU TIME	Amount of CPU time not in DB2, network, REXX, or RPC.	OTHER

**Table 5–4. Shadow Mainframe Adapter Server Performance Column Names**

Column Name	Description	Sort Name (for ISPF only)
SQL COUNT	The number of SQL operations executed. Included in this count are SQL executed, RPCs or stored procedures executed, rollbacks or commits specifically initiated from the Mainframe Adapter Client via a Shadow call, and operations to turn auto-commit off or on.	SQLCOUNT
BYTES WRITTEN	Total number of bytes written to the Mainframe Adapter Client.	BYTES

## Invoking the Shadow Mainframe Adapter Server Performance Application

### *ISPF Panel Users*

To start the Shadow Mainframe Adapter Server Performance application, do the following:

1. From the **Shadow Mainframe Adapter Server Primary Option Menu**, select Option 8, Databases.
2. Press ENTER. The system displays the **Monitor and Control Database Access** panel, as shown in Table 5–1.
3. From this menu, select Option 2, Monitor.
4. Press ENTER. The system displays the **Shadow Mainframe Adapter Server Intervals** panel shown in Table 5–4.

```

----- Shadow Mainframe Adapter Server Intervals SCR 1 ROW
1 OF 87
COMMAND ==>                                SCROLL ==> PAGE
Line Commands:  D Display Detail  F Format  P Print CB  S Show CB

INTERVAL          USER  TOTAL      DATABASE  NETWORK
START            COUNT CPU TIME  CPU TIME  CPU TIME  NOTE
2001/04/11 09:15:00    3  000.000S  000.000S  000.000S
2001/04/11 09:00:00    4  000.001S  000.000S  000.000S
2001/04/11 08:45:00    9  000.111S  000.036S  000.013S
2001/04/11 08:30:00    6  000.007S  000.000S  000.004S

```

**Figure 5–4. Shadow Mainframe Adapter Server Interval Summary**

There are two panels that comprise this application. Use the **LEFT** and **RIGHT** scroll commands (or PF keys) to shift between them.

5. Use the available line commands in Table 5–3 on page 5-5 to perform the appropriate function(s).

## Shadow Web Interface Users

To start the Shadow Mainframe Adapter Server Performance application, do the following:

1. From the main menu, select **Database** → **Interval Summary**. The system displays the **Interval Summary** screen, as shown in Table 5–5.

Actions	Interval Start	User Count	Total CPU Time	Database CPU Time	Network CPU Time	REXX CPU Time	RPC CPU Time	Other CPU Time	SQL Count	Bytes Written
<a href="#">Detail</a> , <a href="#">Format</a> , <a href="#">Block</a>	2001/04/03 13:30:00	2	000.000S	000.000S	000.000S	000.000S	000.000S	000.000S	0	0
<a href="#">Detail</a> , <a href="#">Format</a> , <a href="#">Block</a>	2001/04/03 13:15:00	2	000.000S	000.000S	000.000S	000.000S	000.000S	000.000S	0	0
<a href="#">Detail</a> , <a href="#">Format</a> , <a href="#">Block</a>	2001/04/03 13:00:00	2	000.000S	000.000S	000.000S	000.000S	000.000S	000.000S	0	0
<a href="#">Detail</a> , <a href="#">Format</a> , <a href="#">Block</a>	2001/04/03 12:45:00	4	000.097S	000.008S	000.011S	000.000S	000.000S	000.077S	8	29609
<a href="#">Detail</a> , <a href="#">Format</a> , <a href="#">Block</a>	2001/04/03 12:30:00	1	000.119S	000.009S	000.001S	000.000S	000.093S	000.014S	2	8450
<a href="#">Detail</a> , <a href="#">Format</a> , <a href="#">Block</a>	2001/04/03 12:15:00	0	000.000S	000.000S	000.000S	000.000S	000.000S	000.000S	0	0

**Figure 5–5. Shadow Web Interface Interval Summary**

2. Use the available action commands in Table 5–3 on page 5-5 to perform the appropriate function(s).



**CHAPTER 6:**

# ***Shadow Mainframe Adapter Server: Tracing and Troubleshooting***

---

---

This chapter covers the tracing capabilities offered with Shadow Mainframe Adapter Server, the Mainframe Adapter Server component of the Shadow product. These are powerful diagnostic tools designed to record critical events in the life of each individual transaction process.

Topics Include:

- Overview
  - Trace Browse
  - Trace Browse Archival Facility
  - SQL Trace
- Trace Browse
  - Invoking Trace Browse
  - Setting Up a Trace Browse Profile
  - Using the Refresh Mode
  - Using the Valid Trace Browse Commands and Operands
  - Using Row Information Commands
  - Understanding the Order of Trace Browse Events
  - Printing Trace Browse Information
- The Trace Browse Archival Facility
  - Backups
  - Configuring the Shadow Trace Browse Archival Facility
  - Using the Trace Browse Archival Facility
- SQL Trace
  - Available Commands
  - Column Names
  - Invoking SQL Trace

## **Overview**

### ***Trace Browse***

The Shadow Mainframe Adapter Server component incorporates an extensive trace facility that is implemented by adding trace records to a trace buffer maintained in virtual storage. Trace operations are performed entirely with memory-to-memory instructions, and nothing is written to disk until the session is complete. At that point, the trace information is automatically saved on disk using a VSAM dataset. This approach combines the performance advantages of memory-to-memory tracing with the non-volatility of standard disk storage.

Trace records are created for a wide variety of events in the Shadow Mainframe Adapter Server address space. Specifically, trace records are written for SQL operations, IMS calls, CICS calls, communication events (LU 6.2, TCP/IP, and messages), thread attach and detach events, RPC events, message events, and errors (abends). It is even possible for an RPC to add its own trace messages to the trace for diagnostic purposes.

Typically, the trace buffer is large enough that a complete record of all Mainframe Adapter Client/ Mainframe Adapter Server processing can be maintained for a period of several days. Shadow Mainframe Adapter Server supports multiple trace browse datasets. With the use of hierarchical storage management, you can maintain an unlimited history of data. The trace browse data collection routines support collection of all the data required for auditing, capacity planning, and trend analysis of usage patterns. You can secure the trace browse filter capability to prohibit viewing of sensitive data by a non-authorized user.

The Trace Browse application is available through the Shadow ISPF panels and the Shadow Web Interface.

**Note:**

The Trace Browse Archival Facility is only available through the ISPF application.

## ***Trace Browse Archival Facility***

The Trace Browse Archival Facility in Shadow Mainframe Adapter Server is used to backup, or archive, the *active* trace browse data. Trace browse is a powerful diagnostic tool designed to record critical events in the life of each transaction, such as communication, APIs, and SQL processing events for all users, both attached and remote. This internal trace information can also be used to debug and correct problems within the Shadow application.

The Trace Browse Archival Facility consists of a large block of virtual storage, which can optionally be backed by a data-in-virtual (DIV) linear data set. This block of virtual storage is sub-divided into a *status area*, a configurable number of *event blocks*, and a series of *vector tables*.

- **Status area.** The status area occupies the first 4k page of the trace virtual storage and contains checkpoint information about the trace area itself. It also contains information about the most recent trace archive.
- **Event blocks.** The event blocks begin within the second 4k page of the trace virtual storage area. Each event block occupies 896 bytes of storage. Each Mainframe Adapter Server event is recorded into the next available slot, beginning with the first slot, continuing through the end of the event blocks, and then wrapping around to the beginning.
- **Vector tables.** The vector tables, each beginning on a 4k page boundary, follow the event blocks in storage. The vector tables contain indexing

information that allows views of the trace to be filtered without searching through the entire virtual storage area occupied by each individual event block.

## **SQL Trace**

The SQL Trace application provides detailed information on all the SQL statements a user's application has executed. The information displayed in the SQL Trace application is derived from the main SDB log using connection IDs as the selection criterion.

If you have selected an active session, the data is current and can be refreshed (i.e., the latest information can be viewed) by pressing the ENTER key.

This application is available through both the Shadow ISPF panels and the Shadow Web Interface.

## **Trace Browse**

This section covers the following topics:

- Invoking Trace Browse
- Setting Up a Trace Browse Profile
- Using the Refresh Mode
- Using the Valid Trace Browse Commands and Operands
- Using Row Information Commands
- Understanding the Order of Trace Browse Events
- Printing Trace Browse Information

## **Invoking Trace Browse**

### **ISPF Panel Users**

To start the Trace Browse application, do the following:

1. From the **Shadow Mainframe Adapter Server Primary Option Menu**, select Option 6, Trace Browse.
2. Press ENTER. The system displays the **Shadow Mainframe Adapter Server Trace** panel, similar to the one shown in Figure 6-1.

```

----- Shadow Mainframe Adapter Server Trace --- 13:46:14 08 JUN
01 Cols 001 079
COMMAND ==>                                SCROLL ==> PAGE
-----+-----1-----+-----2-----+-----3-----+-----4-----+-----5-----+-----6-----+-----7-----+-----
COMMIT UR STARTED - RRS SVCS NEONRMSDBB - MACRO ABOUT TO BE ISSUED
COMMIT UR EXECUTED - RRS SVCS NEONRMSDBB - RRS COMMIT UR COMPLETED NORMALLY
DSNHLI INTERNAL COMMIT - DSNT400I SQLCODE = 000, SUCCESSFUL EXECUTION - SDBC10
WRITE EXECUTED          - SOCK 0001 - WRITE COMPLETED
READ EXECUTED           - SOCK 0001 - READ COMPLETED
drop table ctstable1 - DSNT400I SQLCODE = 000, SUCCESSFUL EXECUTION - SDBC1010
COMMIT UR STARTED - RRS SVCS NEONRMSDBB - MACRO ABOUT TO BE ISSUED
COMMIT UR EXECUTED - RRS SVCS NEONRMSDBB - RRS COMMIT UR COMPLETED NORMALLY
DSNHLI INTERNAL COMMIT - DSNT400I SQLCODE = 000, SUCCESSFUL EXECUTION - SDBC10
WRITE EXECUTED          - SOCK 0001 - WRITE COMPLETED
READ EXECUTED           - SOCK 0001 - READ COMPLETED
COMMIT UR STARTED - RRS SVCS NEONRMSDBB - MACRO ABOUT TO BE ISSUED
COMMIT UR EXECUTED - RRS SVCS NEONRMSDBB - RRS COMMIT UR COMPLETED NORMALLY
DSNHLI INTERNAL COMMIT - DSNT400I SQLCODE = 000, SUCCESSFUL EXECUTION
BACKOUT UR STARTED - RRS SVCS NEONRMSDBB - MACRO ABOUT TO BE ISSUED
BACKOUT UR EXECUTED - RRS SVCS NEONRMSDBB - RRS BACKOUT UR COMPLETED NORMALLY
DSNHLI INTERNAL ROLLBACK - DSNT400I SQLCODE = 000, SUCCESSFUL EXECUTION
DSNRLI BYPASSED CLOSE - RC 0 REASON 00000000 SQLCODE 0 - SYNC
WRITE EXECUTED          - SOCK 0001 - WRITE COMPLETED
CLOSE STARTED           - SOCK 0001 - CLOSE INITIATED
CLOSE EXECUTED          - SOCK 0001 - CLOSE COMPLETED

```

**Figure 6–1. Shadow Mainframe Adapter Server Trace Browse**

3. Navigate through the trace messages as follows:
  - Use the **UP**, **DOWN**, **RIGHT**, and **LEFT** scroll commands (or their PF key equivalents) to navigate this ISPF panel.
  - Use the **MAX** or **M** scroll operand to scroll the maximum amount in any direction.
  - If you are at the top or the bottom of the trace list (and it is full), press **ENTER** to scroll the list down, since messages are removed from the top and added to the bottom.

## Shadow Web Interface Users

To start the Trace Browse application, do the following:



1. From the main menu, select **Trace Browse** → **Trace Browse Records**. The system displays the trace browse records, as shown in Figure 6–2.

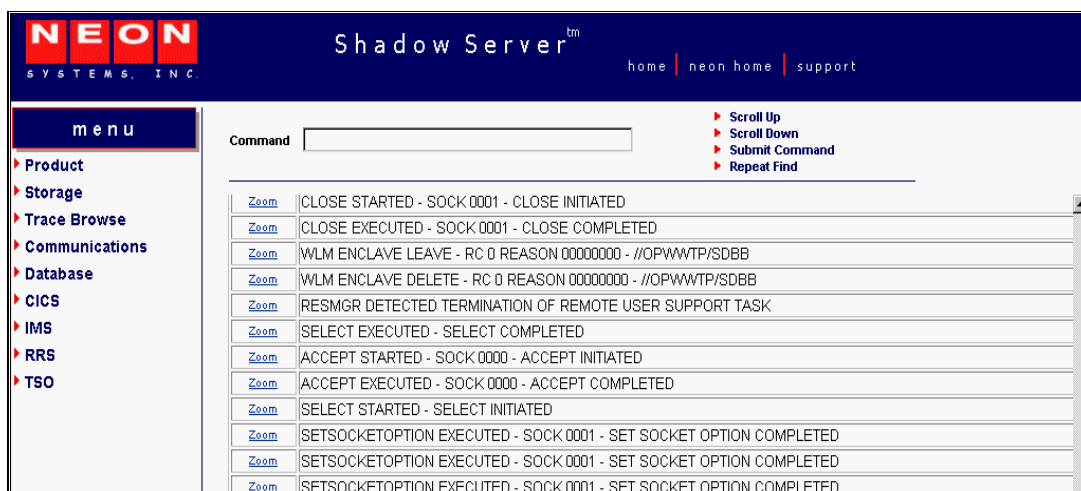

**Figure 6–2. Shadow Web Interface Trace Browse**

2. Use the **Scroll Up** and **Scroll Down** commands at the top of the screen in Figure 6–2 to navigate this screen.

## Setting Up a Trace Browse Profile

When you are viewing Shadow Mainframe Adapter Server events using the Trace Browse application, you may want to browse only a subset of these events. The trace browse profile can help you to do this. Through its filtering profile, it can filter the entire set of trace messages, displaying only those messages you want displayed.



### **Note:**

The filtering profile is for an individual user. One user's profile has no affect on another user's profile.

When you first start the Trace Browse application, you will have no profile and all messages will be displayed.

You can set up a profile using one of the following:

- The Shadow Mainframe Adapter Server trace browse profile specification display.
- The **PROFILE** option on the command line of the trace browse ISPF panel.

**Note:**

The Shadow Mainframe Adapter Server trace browse profile specification display can be used with both the ISPF application panels and the Shadow Web Interface screens; however, the **PROFILE** command line option can only be used with the ISPF application panels.

## Using the Trace Browse Profile Specification Display

### *ISPF Panel Users*

To use the trace browse profile specification display, do the following:

1. On the command line of the main **Shadow Mainframe Adapter Server Trace** panel (Figure 6–1), type **PROFILE** (with no operands).
2. Press **ENTER**. The system will display the **Shadow Mainframe Adapter Server Browse Profile** panel shown in Figure 6–3.

```

----- Shadow Mainframe Adapter Server Browse Profile -----
-----
COMMAND ====>
JOBNAME  ====> AI38*      ====>      ====>      ====>
USERID   ====>          ====>      ====>      ====>
COLOR    ====>          ====>      ====>      ====>
CONNECT  ====>          ====>      ====>      ====>
VCID     ====>          ====>      ====>      ====>
HOST NAME ====>          ====>      ====>
SSID     ====>          ====>
TCB      ====>          ====>
XIDTOKEN ====>
GTRIDTKN ====>
CONVTKN  ====>

Event type filter options, Specify Y or N to include or exclude event type

ABN ====> Y  APM ====> Y  ATH ====> N  CIC ====> Y  CMD ====> Y  CPG ====> Y  DET ====> Y
DIS ====> N  ECI ====> Y  ENA ====> Y  EXC ====> Y  FIL ====> Y  GLV ====> Y  IMS ====> Y
ITC ====> Y  MQS ====> Y  OTC ====> Y  OTM ====> Y  RPC ====> Y  RRS ====> Y  SQL ====> Y
SQM ====> Y  SSL ====> Y  STG ====> N  STR ====> Y  TCP ====> Y  TOD ====> Y  TSO ====> Y

```

**Figure 6–3. Shadow Mainframe Adapter Server Browse Profile**

3. Specify the profile criteria (see Table 6–1) to determine which records you want displayed. The arrows to the right of some of the entries indicate that you can input additional values for the column names.

► **Notes:**

- If you specify more than one profile criteria, Shadow Mainframe Adapter Server joins them with the logical AND operator. Trace browse will filter the available records and display only those that fit both criteria.
  - If you specify more than one value for a profile criterion, Shadow Mainframe Adapter Server joins them with the logical OR operator. Trace browse will filter the available records and display any that any of the values. For example, with two JOBNAMEs specified, a record will be selected if it contains one or the other of the values.
4. In the event type options located in the bottom half of the panel shown in Figure 6–3, type Y for yes or N for no to include or exclude particular event types, respectively.
  5. Press ENTER. The system will re-display the **Shadow Mainframe Adapter Server Trace** panel (Figure 6–1), reflecting the profile options you have set.

## Shadow Web Interface Users

To use the trace browse profile specification display, do the following:

1. From the main menu, select **Trace Browse** → **Trace Browse Control**. The system will display the **Current Trace Browse Filters** screen, as shown in Figure 6–4.

The screenshot shows the 'Shadow Server' web interface. At the top, there is a navigation bar with the 'NEON SYSTEMS, INC.' logo and links for 'home', 'neon home', and 'support'. Below this is a 'menu' sidebar on the left with options like 'Product', 'Storage', 'Trace Browse', 'Communications', 'Database', 'CICS', 'IMS', 'RRS', and 'TSO'. The main content area has tabs for 'Filters', 'Events', 'Columns', and 'Records'. The 'Filters' tab is selected, showing a 'Current Trace Browse Filters' panel. This panel contains a grid of input fields for various criteria: JOBNAME, USERID, COLOR, CONNECT, VCID, HOSTNAME, SSID, and TCB. A 'Save settings' button is located at the bottom of the filter grid.

**Figure 6–4. Shadow Web Interface Browse Profile**

2. Specify the profile criteria (see Table 6–1) to determine which records you want displayed. You may only enter values for the following criteria:

- JOBNAME
- USERID
- COLOR
- CONNECT
- VCID
- HOST NAME
- SSID
- TCB

► **Notes:**

- If you specify more than one profile criteria, Shadow Mainframe Adapter Server joins them with the logical AND operator. Trace browse will filter the available records and display only those that fit both criteria.
  - If you specify more than one value for a profile criterion, Shadow Mainframe Adapter Server joins them with the logical OR operator. Trace browse will filter the available records and display any that any of the values. For example, with two JOBNAMEs specified, a record will be selected if it contains one or the other of the values.
3. Click the **Events** button located on the top of the **Current Trace Browse Filters** screen (shown in Figure 6–4). The system will display the **Current Trace Browse Events** screen, as shown in Figure 6–5.

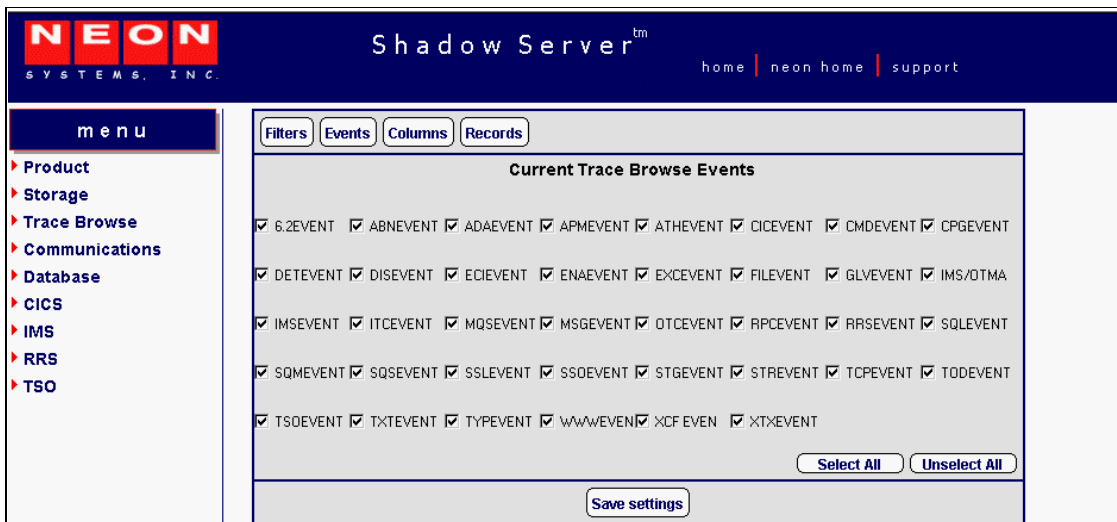

**Figure 6–5. Shadow Web Interface Trace Browse Events**

4. Select the check boxes of the event types you want to include in the trace (or deselect to exclude).

## Using the PROFILE Command

The **PROFILE** command can be used from the ISPF application panels to set and clear profile criteria.



### **Note:**

The **PROFILE** command line option can *only* be used with the ISPF application panels; it is not available with the Shadow Web Interface.

## Setting Profile Criteria

The **PROFILE** command can be used to establish new profile criteria values. On the command line of the main **Shadow Mainframe Adapter Server Trace** panel (Figure 6–1), use the **PROFILE** command with the following syntax:

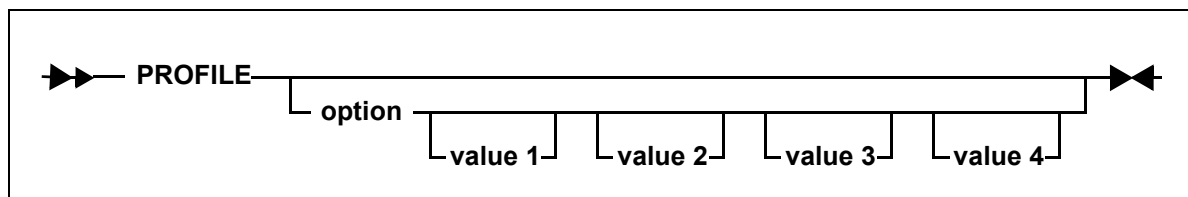

Where:

### **option**

Specifies the name of the option you want to set (see Table 6–1).

### **value1...value4**

Specifies the values to use in selecting records. When specifying profile criteria, only **JOBNAME**, **USERID**, **COLOR**, and **CONNECT** can have multiple values. The event type options can only have one value (Y to include or N to exclude).

**Example 1.** To enter a specification for **JOBNAME** and exclude all records except those produced by a single user, use the following:

```
PROFILE JOBNAME jobname
```



### **Note:**

This will show you all the connections this user has made to Shadow Mainframe Adapter Server. You may want to use this type of profile whenever you are looking for patterns and need to study several sessions for a user.

**Example 2.** To select two jobs, you could specify both on the same profile command, as follows:

```
PROFILE JOBNAME jobname1 jobname2
```

**Example 3.** To filter out all trace browse messages except for those related to a particular connection, given that the connection ID is unique for each connection established with the product, use the following:

```
PROFILE CONNECT connection-id
```



**Note:**

Use this type of profile when you want to study just one connection for a user. This will give you all of the records for one session, including all communications and I/O.

### Clearing Profile Criteria

To clear the profile setting for an option and prevent it from be considered for filtering, use the **PROFILE** command specifying the criteria but leaving the value omitted, as follows:

```

  >>> PROFILE _____ <<<
          |
          | option
          |
  
```

Where:

**option**

Specifies the name of the profile criteria you want to clear (see Table 6-1).

**Example.** To clear any existing JOBNAME specifications, enter the following:

```
PROFILE JOBNAME
```

### Profile Criteria

Table 6-1 provides a description and the allowed values for the profile criteria for both the ISPF application and the Shadow Web Interface.

**Table 6-1. Trace Browse Profile Criteria**

Option	Option Description	Value Description
JOBNAME	Limits the records to those containing the specified value in the JOBNAME column (for column descriptions, see Table 6-3 on page 6-18).	As many as 4 values may be entered.

**Table 6–1. Trace Browse Profile Criteria (continued)**

<b>Option</b>	<b>Option Description</b>	<b>Value Description</b>
<b>USERID</b>	Limits the records to those containing the specified value in the USERID column (for column descriptions, see Table 6–3 on page 6-18).	As many as 4 values may be entered.
<b>COLOR</b>	(This option not supported at this time.)	(This option is not supported at this time.)
<b>CONNECT</b>	Limits the records to those containing the specified value in the CONNECT column (for column descriptions, see Table 6–3 on page 6-18).	As many as 4 values may be entered.
<b>VCID</b>	Limits the records to those containing the specified value in the VCID column (for column descriptions, see Table 6–3 on page 6-18).	As many as 4 values may be entered.
<b>HOST NAME</b>	Limits the records to those containing the specified value in the HOST NAME column (for column descriptions, see Table 6–3 on page 6-18).	As many as 4 values may be entered.
<b>SSID</b>	Limits the records to those containing the specified value in the SSID column (for column descriptions, see Table 6–3 on page 6-18).	As many as 4 values may be entered.
<b>TCB</b>	Limits the records to those containing the specified value in the TCB column (for column descriptions, see Table 6–3 on page 6-18).	As many as 4 values may be entered.
<b>XIDTOKEN</b>		
<b>GTRIDTKN</b>		
<b>CONVTKN</b>		
<b>ABNevent</b>	Controls whether abend event records are included in the user’s “view” of trace data.	<b>Y:</b> Yes (default) <b>N:</b> No
<b>APMevent</b>	Controls whether APPC/MVS event records are included in the user’s “view” of trace data.	<b>Y:</b> Yes (default) <b>N:</b> No
<b>ATHevent</b>	Controls whether authorization event records are included in the user’s “view” of trace data.	<b>Y:</b> Yes (default) <b>N:</b> No
<b>CHGevent</b>	Controls whether Shadow Event Publisher records are included in the users “view” of trace data.	<b>Y:</b> Yes (default) <b>N:</b> No
<b>CICevent</b>	Controls whether CICS event records are included in the user’s “view” of trace data.	<b>Y:</b> Yes (default) <b>N:</b> No
<b>CMDevent</b>	Controls whether command event records are included in the user’s “view” of trace data.	<b>Y:</b> Yes (default) <b>N:</b> No
<b>CPGevent</b>	Controls whether C program event records are included in the user’s “view” of trace data.	<b>Y:</b> Yes (default) <b>N:</b> No
<b>DETevent</b>	Controls whether detach event records are included in the user’s “view” of trace data.	<b>Y:</b> Yes (default) <b>N:</b> No
<b>DISevent</b>	Controls whether disable event records are included in the user’s “view” of trace data.	<b>Y:</b> Yes (default) <b>N:</b> No

**Table 6–1. Trace Browse Profile Criteria (continued)**

<b>Option</b>	<b>Option Description</b>	<b>Value Description</b>
<b>ECIevent</b>	Controls whether CICS EXCI event records are included in the user's "view" of trace data.	<b>Y:</b> Yes (default) <b>N:</b> No
<b>ENAevent</b>	Controls whether enable event records are included in the user's "view" of trace data.	<b>Y:</b> Yes (default) <b>N:</b> No
<b>EXCevent</b>	Controls whether exception event records are included in the user's "view" of trace data.	<b>Y:</b> Yes (default) <b>N:</b> No
<b>FILevent</b>	Controls whether file event records are included in the user's "view" of trace data.	<b>Y:</b> Yes (default) <b>N:</b> No
<b>GLVevent</b>	Controls whether global variable event records are included in the user's "view" of trace data.	<b>Y:</b> Yes (default) <b>N:</b> No
<b>IMSevent</b>	Controls whether IMS event records are included in the user's "view" of trace data.	<b>Y:</b> Yes (default) <b>N:</b> No
<b>ITCevent</b>	Controls whether Interlink TCP/IP event records are included in the user's "view" of trace data.	<b>Y:</b> Yes (default) <b>N:</b> No
<b>MQSevent</b>	Controls whether MQSeries event records are included in the user's "view" of trace data.	<b>Y:</b> Yes (default) <b>N:</b> No
<b>OTCevent</b>	Controls whether IBM OE Sockets TCP/IP records are included in the user's "view" of trace data.	<b>Y:</b> Yes (default) <b>N:</b> No
<b>OTMevent</b>	Controls whether IMS/OTMA event records are included in the user's "view" of trace data.	<b>Y:</b> Yes (default) <b>N:</b> No
<b>RPCevent</b>	Controls whether RPC event records are included in the user's "view" of trace data.	<b>Y:</b> Yes (default) <b>N:</b> No
<b>RRSevent</b>	Controls whether RRS event records are included in the user's "view" of trace data.	<b>Y:</b> Yes (default) <b>N:</b> No
<b>SQLevent</b>	Controls whether SQL event records are included in the user's "view" of trace data.	<b>Y:</b> Yes (default) <b>N:</b> No
<b>SQMevent</b>	Controls whether SQM event records are included in the user's "view" of trace data.	<b>Y:</b> Yes (default) <b>N:</b> No
<b>SSLevent</b>	Controls whether SSL records are included in the user's "view" of trace data.	<b>Y:</b> Yes (default) <b>N:</b> No
<b>STGevent</b>	Controls whether storage alteration records are included in the user's "view" of trace data.	<b>Y:</b> Yes (default) <b>N:</b> No
<b>STRevent</b>	Controls whether system trace records are included in the user's "view" of trace data.	<b>Y:</b> Yes (default) <b>N:</b> No
<b>TCPevent</b>	Controls whether TCP/IP event records are included in the user's "view" of trace data.	<b>Y:</b> Yes (default) <b>N:</b> No
<b>TODevent</b>	Controls whether time-of-day event records are included in the user's "view" of trace data.	<b>Y:</b> Yes (default) <b>N:</b> No
<b>TSOevent</b>	Controls whether TSO event records are included in the user's "view" of trace data.	<b>Y:</b> Yes (default) <b>N:</b> No



**Table 6–1. Trace Browse Profile Criteria (continued)**

Option	Option Description	Value Description
<b>TXEvent</b>	Controls whether product initialization, termination and general execution text messages are to be included.	<b>Y:</b> Yes (default) <b>N:</b> No
<b>TYEvent</b>	Controls whether TYP event records are included in the user's "view" of trace data.	<b>Y:</b> Yes (default) <b>N:</b> No
<b>WLMevent</b>	Controls whether WLM event records are included in the users "view" of trace data.	<b>Y:</b> Yes (default) <b>N:</b> No
<b>WWWevent</b>	Controls whether WWW event records are included in the user's "view" of trace data.	<b>Y:</b> Yes (default) <b>N:</b> No
<b>XCEvent</b>		<b>Y:</b> Yes (default) <b>N:</b> No
<b>XTXevent</b>	Controls whether extended text event records are included in the users "view" of trace data.	<b>Y:</b> Yes (default) <b>N:</b> No
<b>6.2event</b>	Controls whether 6.2 event records are included in the user's "view" of trace data.	<b>Y:</b> Yes (default) <b>N:</b> No

### *Wildcards for Trace Browse Profile*

The JOBNAME and USERID criteria can contain *wildcard* specifications. A wildcard is an entry that ends with an asterisk ("\*"). For example, if the entry in JOBNAME is "AI38\*", then all trace records the jobnames that start with "AI38" are selected.

## **Using the Refresh Mode**

When first invoking the Trace Browse application, the display will be positioned at the bottom of the list of trace records (you will see the "Bottom of Messages" marker at the bottom of the panel). To refresh the display with the latest messages, press ENTER.

You can also use the refresh mode at the top of the trace browse list (in which case you will see the "Top of Messages" marker at the top of the panel). If the list is full, press ENTER to scroll the display downward, since the oldest messages are eliminated to accommodate the newest messages being added to the end of the list.

If you reposition the trace browse display from its initial position at the bottom of the message stream, it will no longer shift when you press ENTER. If you use the **DOWN MAX** command, the refresh mode will be reinstated (although you will still need to press ENTER to see the latest messages).

**Note:**

Scrolling to the bottom without using the **DOWN MAX** command will not reinstate the refresh mode.

## Using the Valid Trace Browse Commands and Operands

There are five basic commands that you can use in the Trace Browse application:

- **PROFILE**
- **DISPLAY**
- **LOCATE**
- **FIND**
- **RFIND**

Table 6–2 gives a brief description of each of these commands and how they can be used.

**Table 6–2. Trace Browse Commands**

Command	Description
<b>PROFILE</b>	Modifies the user view of the trace list. See “Setting Up a Trace Browse Profile” on page 6-5.
<b>DISPLAY</b>	Controls display columns.
<b>LOCATE</b>	Scrolls the display to a specific message number.
<b>FIND</b>	Finds strings in message and some column text.
<b>RFIND</b>	Repeats the <b>FIND</b> command (like <b>RFIND</b> in ISPF Edit).

### Displaying Trace Browse Columns

#### Using the *DISPLAY* Command

The syntax of the **DISPLAY** command is as follows:

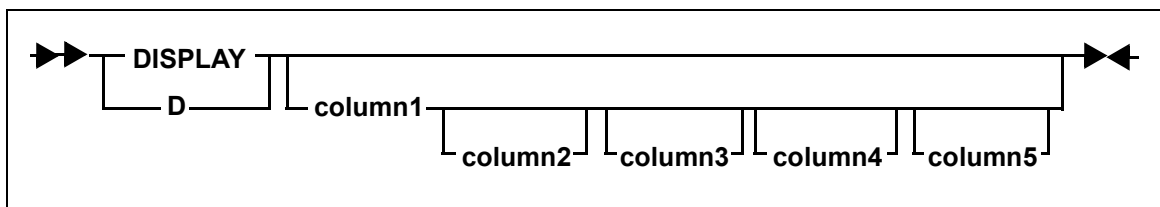

Where:

**column1...column5**

Specifies the columns to be displayed. You can specify one to five display columns separated by blanks. The columns will appear to the left of the message text in the order that you specify them with the command.

**ISPF Panel Users.** To display trace browse columns, do the following:

1. On the command line of the main **Shadow Mainframe Adapter Server Trace** panel (Figure 6–1), use the **DISPLAY** command followed by the appropriate column names to display specific columns.

In the example shown in Figure 6–6, the following **DISPLAY** command was used:

```
D TIMEX CPUTIME HOSTNAME EVENT TCBADDR
```

```
----- Shadow Mainframe Adapter Server Trace --- 13:17:58 22 MAY 01
Cols 001 033
COMMAND ==>
SCROLL ==> PAGE
HH:MM:SS.UUUUUU CPU TIME HOST NAME EVN TCBADD -----1-----2-----3---
*****
***** TOP OF MESSAGES *****
13:17:58.680565 000.029S N/A      DET 8AAE00 RESMGR DETECTED TERMINATION OF TA
13:53:56.298785 000.403S N/A      DET 8CFC50 RESMGR DETECTED TERMINATION OF TA
16:29:58.217938 000.035S N/A      DET 8AAE00 RESMGR DETECTED TERMINATION OF TA
10:49:16.694944 000.185S N/A      DET 8CFC50 RESMGR DETECTED TERMINATION OF TA
10:53:41.439585 000.286S N/A      DET 8CFC50 RESMGR DETECTED TERMINATION OF TA
```

**Figure 6–6. Display of TIMEX, CPUTIME, HOSTNAME, EVENT, and TCBADDR Columns**

2. To clear displayed columns, use the **DISPLAY** command with no operands. This will cause the trace browse panel to display just the trace message text.



**Note:**

The trace message text is always included as a part of the trace browse no matter what other columns are specified.

**Shadow Web Interface Users.** There are two ways you can display and rearrange columns using the Shadow Web Interface:

- From the the trace browse profile specification display
- From the Trace Browse application

To use the the trace browse profile specification display to modify the columns displayed, do the following:

1. From the main menu, select **Trace Browse** → **Trace Browse Control**. The system displays the **Current Trace Browse Filters** screen, as shown in Figure 6–7.

**Figure 6–7. Shadow Web Interface Trace Browse Filters**

2. Click the **Columns** button at the top of the screen. The system displays the **Current Trace Browse Column Selections** screen, as shown in Figure 6–8.

**Figure 6–8. Shadow Web Interface Trace Browse Column Selections**

3. Use the buttons in the middle of the screen (shown in Figure 6–9) to select columns you want to view and put them in the order you desire.

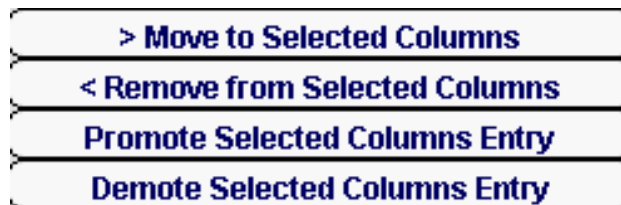
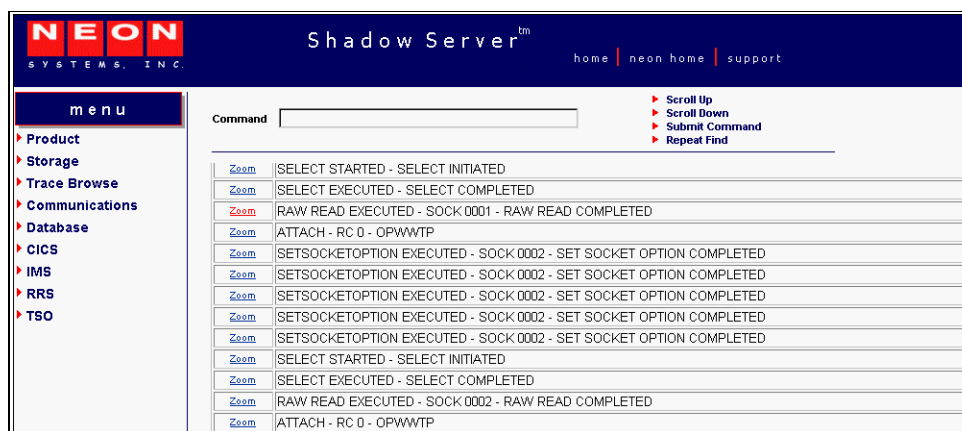

**Figure 6-9. Column Selection Buttons**

- Use the **Move to Selected Columns** button to move columns you want to view from the **Available Columns** list to the **Selected Columns** list.
  - Use the **Remove from Selected Columns** button to move columns from the **Selected Columns** list to the **Available Columns** list.
  - Use the **Promote Selected Columns Entry** and the **Demote Selected Columns Entry** buttons to position your chosen **Selected Columns** in the order you want.
4. Click the **Save Settings** button to save your settings.

To use the Trace Browse application to modify the columns displayed, do the following:

1. From the main menu, select **Trace Browse** → **Trace Browse Records**. The system displays the trace, as shown in Figure 6-10.

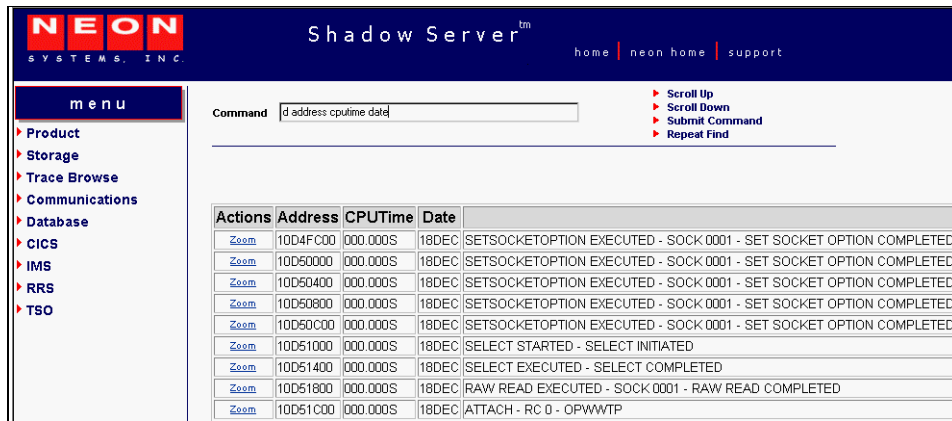

**Figure 6-10. Shadow Web Interface Trace Browse Records**

2. In the **Command** field, use the **D** command followed by the column names in the order you want to view them.

In the example shown in Figure 6-11, the following command has been entered:

```
d address cputime date
```



**Figure 6–11. Shadow Web Interface Display Command**

- Press ENTER. The system displays the columns you requested in the order you requested them.

### Displaying Available Trace Browse Columns

By default, the Trace Browse application displays three columns of information for each traced event:

- The time of the event
- The host name associated with the event
- A short description of the event

However, you can display many other columns, including the columns shown in Table 6–3.

**Table 6–3. Possible Trace Browse Columns**

Column	Description
<b>ACTION</b>	Displays the final Shadow Event Facility (SEF) event action: <ul style="list-style-type: none"> <li>• <b>ACC:</b> Accept</li> <li>• <b>REJ:</b> Reject</li> <li>• <b>NOA:</b> No action</li> </ul>
<b>ADDRESS</b>	The location in memory of the actual message data.
<b>ADDRJOB</b>	The location in memory of the current entry in the JOBNAME vector.
<b>ADDRUSR</b>	The location in memory of the current entry in the USERID vector.
<b>APMRC</b>	APPC/MVS return code.
<b>ASID</b>	The address space ID of the user that created the current trace browse entry.
<b>CLOCK</b>	The 8-byte binary clock value time stamp indicating when the trace browse message was created.

**Table 6–3. Possible Trace Browse Columns (continued)**

Column	Description																																	
<b>CNID</b>	The unique identifier assigned to each thread created by the product.																																	
<b>CODE</b>	The lowest level return code for each event in trace browse.																																	
<b>COLOR</b>	The color assigned to each trace browse message (very handy when using a monochrome monitor). This column is for general use and for product support. <i>Note:</i> The COLOR column is not completely implemented. At this time, only the value NONE will be displayed.																																	
<b>COUNT</b>	The number of SEF rules that processed the event.																																	
<b>CPUTIME</b>	The CPU time used by a particular thread. The format depends on how much CPU time the user has used so far: <ul style="list-style-type: none"> <li>Less than 1000 seconds: The format is nnn.nnnns.</li> <li>Between 1000 seconds and 100 hours: The format is hh:mm:ss.</li> <li>100 hours or more: The format is hhhh:mm.</li> </ul>																																	
<b>CVID</b>	The conversation ID assigned by LU 6.2 when a conversation is started.																																	
<b>DATE</b>	The date on which the message was created, in dd:mm:yy format.																																	
<b>ELAPSED</b>	The amount of time that the current event took in decimal microseconds (millionths of a second). It is calculated by subtracting the STCK (store clock) value taken at the beginning of processing from the STCK value taken at the end of processing.																																	
<b>EVENT</b>	Displays the type of event that created the message. The event types are as follows: <table border="0" style="margin-left: 40px;"> <tr> <td>ABNevent</td> <td>APMevent</td> <td>APIevent</td> </tr> <tr> <td>ATHevent</td> <td>CICevent</td> <td>CMDevent</td> </tr> <tr> <td>CPGevent</td> <td>DETevent</td> <td>DISevent</td> </tr> <tr> <td>ECIevent</td> <td>ENAEevent</td> <td>EXCevent</td> </tr> <tr> <td>FILEvent</td> <td>GLVevent</td> <td>IMSevent</td> </tr> <tr> <td>ITCevent</td> <td>MGXevent</td> <td>MQSevent</td> </tr> <tr> <td>MSGevent</td> <td>OTCevent</td> <td>RPCevent</td> </tr> <tr> <td>RRSevent</td> <td>SQLevent</td> <td>SQMevent</td> </tr> <tr> <td>SSLevent</td> <td>SSOevent</td> <td>STGevent</td> </tr> <tr> <td>TCPevent</td> <td>TODevent</td> <td>TSOevent</td> </tr> <tr> <td>TYPevent</td> <td>WWWevent</td> <td>6.2event</td> </tr> </table> <p>For an explanation of these events, see Table 6–1 on page 6-10.</p>	ABNevent	APMevent	APIevent	ATHevent	CICevent	CMDevent	CPGevent	DETevent	DISevent	ECIevent	ENAEevent	EXCevent	FILEvent	GLVevent	IMSevent	ITCevent	MGXevent	MQSevent	MSGevent	OTCevent	RPCevent	RRSevent	SQLevent	SQMevent	SSLevent	SSOevent	STGevent	TCPevent	TODevent	TSOevent	TYPevent	WWWevent	6.2event
ABNevent	APMevent	APIevent																																
ATHevent	CICevent	CMDevent																																
CPGevent	DETevent	DISevent																																
ECIevent	ENAEevent	EXCevent																																
FILEvent	GLVevent	IMSevent																																
ITCevent	MGXevent	MQSevent																																
MSGevent	OTCevent	RPCevent																																
RRSevent	SQLevent	SQMevent																																
SSLevent	SSOevent	STGevent																																
TCPevent	TODevent	TSOevent																																
TYPevent	WWWevent	6.2event																																
<b>HOSTNAME</b>	TCP/IP host name or LU 6.2 host name.																																	
<b>HOSTX</b>	TCP/IP host name extended or LU 6.2 host name/mode.																																	
<b>IPADDR</b>	The IP (Internet Protocol) address, which is the TCP/IP source or target associated with the message.																																	
<b>ITCRC</b>	Interlink TCP/IP return code.																																	
<b>JOBID</b>	The job ID of the job or address space that created the trace browse entry.																																	
<b>JOBNAME</b>	The job name of the job or address space that created the trace browse entry. This column is for general use and product support.																																	
<b>LENGTH</b>	The length of the text section of the message.																																	
<b>LUNAME</b>	The LU 6.2 source or target associated with the message.																																	

**Table 6–3. Possible Trace Browse Columns (continued)**

Column	Description
<b>MSGNO</b>	The sequential message number of the message. Message one is the first message collected by trace browse when data collection begins. The second is message two, and so forth. When the capacity of the trace browse message area is exhausted, the oldest message is discarded as each new message is added. Because of this, the top message in trace browse is not necessarily message number one.
<b>NODENAME</b>	The name of the communications node associated with the message. The format of each entry depends on the communication link type.
<b>OERC</b>	OE Sockets TCP/IP return code.
<b>PATHID</b>	The IUCV path ID associated with the message. This column only has meaning for TCP/IP-related events.
<b>RC</b>	The highest level return code for the message.
<b>REASON</b>	The second level return code for the message.
<b>SDBFLAGS</b>	The bits set by the various routines that create the trace browse.
<b>SECONDS</b>	The first 4 bytes of the binary time stamp, indicating when the trace browse message was created.
<b>SESSION</b>	The communications session associated with the message. The format of each entry depends on the communication link type.
<b>SOCKET</b>	The socket number associated with the message. This column only applies to TCP/IP-related events.
<b>SQLRC</b>	SQL return code.
<b>TCBADDR</b>	The TCB address field containing the address of the TCB that created the message.
<b>TCPRCEX</b>	The TCP/IP extended return codes. This column is only for TCP/IP-related events. It is used for general use and product support.
<b>TCPRC</b>	The TCP/IP return codes. This column is only for TCP/IP-related events.
<b>TERMNAME</b>	The name of the terminal with which the event is associated.
<b>TIME</b>	The time at which the message was created, in hh:mm:ss format.
<b>TIMEX</b>	The extended time field. This is the time at which the message was created calculated to the microsecond, in hh:mm:ss.uuuuuu format.
<b>TRACE1</b>	The trace data specific to the message. This field is for product support and debugging.
<b>USERID</b>	The security product userid that best identifies the message.
<b>VCID</b>	Unique virtual connection ID.
<b>VERSION</b>	The product version that created the message.
<b>VTAMRC</b>	The VTAM return code.

## Locating Messages

Use the **LOCATE** command to position the display at a specific line. The line can be specified by date, time, date/time combination, or by message number.



## Using the LOCATE Command

The syntax for the **LOCATE** command is as follows:

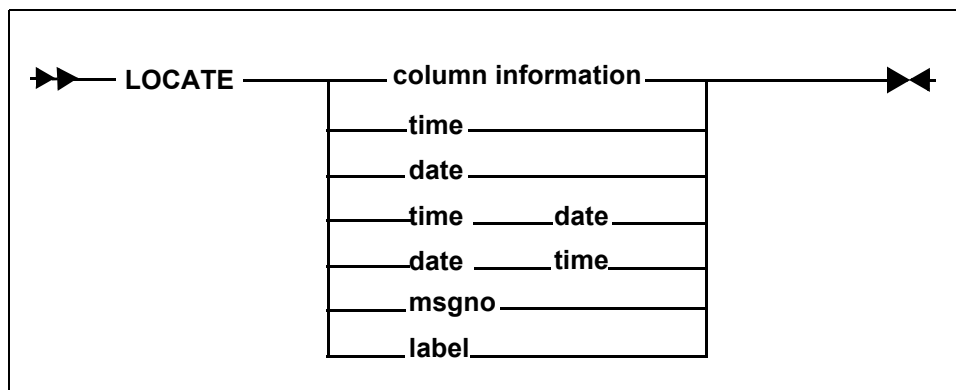

Where:

**time** Locates the time of day using a 24-hour format. Trace browse scrolls to the first occurrence and positions it at the top of the panel. Use one of the following formats to specify the time:

**hh:** Hour only  
**hh:mm** Hour and minute  
**hh:mm:ss** Hour, minute, and second (default format)

**Example:** To locate the first occurrence of 1:05 p.m., type the following:

```
LOCATE 13:05:00
```

**date** Locates the first occurrence of the date and positions it at the top of the panel. Use one of the following formats to specify the date:

**dmmm** Specific single-digit date, current year  
**ddmmm** Specific date, current year (default format)  
**ddmmmyy** Specific date, specific two-digit year  
**ddmmmyyyy** Specific date, specific four-digit year

**Example:** To locate February 5th of the current year, type the following:

```
LOCATE 05FEB
```

**msgno** Locates the message number and positions it at the top of the panel. The message number is a 1 to 10 digit integer.

**Example:** To locate the message number 0000058202, type the following:

```
LOCATE 0000058202
```

**label** Locates the label previously entered into the MSGNO column. If the label is not defined, an error message is displayed. See “Assigning and Locating Labels in Trace Browse” on page 6-24 for more information on labels.

**Example:** To locate the label “.PROJECTD”, type the following:

```
LOCATE .PROJECTD
```

**ISPF Panel Users.** On the command line of the main **Shadow Mainframe Adapter Server Trace** panel (Figure 6–12), use the **LOCATE** command with the appropriate criteria to locate a particular message.

For example, to locate a specific message with a particular time, do the following:

1. Use the **DISPLAY** command for displaying the appropriate column. In this case, display the time column, as follows:

```
d time
```

The system displays the time and message contents in the **Shadow Mainframe Adapter Server Trace** panel, as shown in Figure 6–12.

```
----- Shadow Mainframe Adapter Server Trace --- 10:10:09 22 MAY
01 Cols 001 070
COMMAND ==> SCROLL ==> PAGE
HH:MM:SS ---+---1---+---2---+---3---+---4---+---5---+---6---+---7
10:10:09 RESMGR DETECTED TERMINATION OF TASK OUTSIDE OF MAIN PRODUCT ASID
10:10:10 RESMGR DETECTED TERMINATION OF TASK OUTSIDE OF MAIN PRODUCT ASID
10:11:07 RESMGR DETECTED TERMINATION OF TASK OUTSIDE OF MAIN PRODUCT ASID
10:11:13 RESMGR DETECTED TERMINATION OF TASK OUTSIDE OF MAIN PRODUCT ASID
10:11:26 RESMGR DETECTED TERMINATION OF TASK OUTSIDE OF MAIN PRODUCT ASID
10:27:39 RESMGR DETECTED TERMINATION OF TASK OUTSIDE OF MAIN PRODUCT ASID
10:38:50 RESMGR DETECTED TERMINATION OF TASK OUTSIDE OF MAIN PRODUCT ASID
10:41:52 RESMGR DETECTED TERMINATION OF TASK OUTSIDE OF MAIN PRODUCT ASID
10:51:42 RESMGR DETECTED TERMINATION OF TASK OUTSIDE OF MAIN PRODUCT ASID
12:07:04 RESMGR DETECTED TERMINATION OF TASK OUTSIDE OF MAIN PRODUCT ASID
13:17:58 RESMGR DETECTED TERMINATION OF TASK OUTSIDE OF MAIN PRODUCT ASID
13:53:56 RESMGR DETECTED TERMINATION OF TASK OUTSIDE OF MAIN PRODUCT ASID
16:29:58 RESMGR DETECTED TERMINATION OF TASK OUTSIDE OF MAIN PRODUCT ASID
17:17:22 RESMGR DETECTED TERMINATION OF TASK OUTSIDE OF MAIN PRODUCT ASID
17:19:00 RESMGR DETECTED TERMINATION OF TASK OUTSIDE OF MAIN PRODUCT ASID
17:30:37 RESMGR DETECTED TERMINATION OF TASK OUTSIDE OF MAIN PRODUCT ASID
17:34:18 RESMGR DETECTED TERMINATION OF TASK OUTSIDE OF MAIN PRODUCT ASID
```

**Figure 6–12. Displaying the Time of Trace Browse Messages in Shadow ISPF**

2. To locate the specific message, use the **LOCATE** command followed by the criteria you want to use for locating. In this case, to locate a message with a particular time of 21:51:58, type the following:

```
l 21:51:58
```

- Press ENTER. The system displays the first occurrence of the specified criteria. Figure 6–13 displays the results of the example command, showing the first occurrence of the time 21:58:58.

```

----- Shadow Mainframe Adapter Server Trace --- 21:51:58 22 MAY
01 Cols 001 070
COMMAND ==>                                SCROLL ==> PAGE
HH:MM:SS -----1-----2-----3-----4-----5-----6-----7
21:51:58 RESMGR DETECTED TERMINATION OF TASK OUTSIDE OF MAIN PRODUCT ASID
21:51:58 RESMGR DETECTED TERMINATION OF TASK OUTSIDE OF MAIN PRODUCT ASID

```

**Figure 6–13. Locating a Message with a Particular Time**

**Shadow Web Interface Users.** To locate a particular message, use the **LOCATE** command with the appropriate criteria in the **Command** field of the trace browse screen (Figure 6–14).

For example, to locate a specific message with a particular time, do the following:

- From the main menu, select **Trace Browse** → **Trace Browse Records**. The system displays the trace.
- In the **Command** field, use the **DISPLAY** command for displaying the appropriate column. In this case, display the time column, as follows:

```
d time
```

The system displays the time and message contents for the trace messages, as shown in Figure 6–14.

Actions	Time	
<a href="#">Zoom</a>	15:21:28	RAW READ EXECUTED - SOCK 0002 - RAW READ COMPLETED
<a href="#">Zoom</a>	15:21:28	ATTACH - RC 0 - OPWWTP
<a href="#">Zoom</a>	15:21:28	URL - GET /swicnt/TRACBRWS?ACT=TBFMCT&FRW=NEONTBCTL HTTP/1.0 Accept: image/gif, image/x-bitmap
<a href="#">Zoom</a>	15:21:28	RAW WRITE EXECUTED - SOCK 0001 - RAW WRITE COMPLETED
<a href="#">Zoom</a>	15:21:28	RAW WRITE EXECUTED - SOCK 0001 - RAW WRITE COMPLETED
<a href="#">Zoom</a>	15:21:28	End-Transaction - Transaction-Status(200)
<a href="#">Zoom</a>	15:21:28	CLOSE STARTED - SOCK 0001 - CLOSE INITIATED
<a href="#">Zoom</a>	15:21:28	URL - GET /swicnt/TRACBRWS?ACT=BUILD&FRW=NEONTBXT HTTP/1.0 Accept: image/gif, image/x-bitmap

**Figure 6–14. Displaying the Time of Trace Browse Messages in the Shadow Web Interface**

- In the **Command** field, use the **LOCATE** command followed by the criteria you want to use for locating the specific message. In this case, to locate a message with a particular time of 13:05:00, type the following:

```
l 13:05:00
```

- Press ENTER. The system displays the first occurrence of the specified criteria. Figure 6–15 displays the results of the example command, showing the first occurrence of the time 13:05:00.

The screenshot shows the Shadow Server web interface. At the top, there is a navigation bar with the NEON logo and 'Shadow Server' text. Below the logo is a 'menu' section with links for Product, Storage, Trace Browse, Communications, Database, CICS, IMS, RRS, and TSO. A search bar contains the text '13:05:00'. To the right of the search bar are four action buttons: Scroll Up, Scroll Down, Submit Command, and Repeat Find. Below the search bar is a table with two columns: 'Actions' and 'Time'. The table contains several rows of search results, all showing the time '13:15:01' and various database-related messages.

Actions	Time	
Zoom	13:15:01	DSNALI INTERNAL OPEN - RC 0 REASON 00000000 SQLCODE 0 - DSN1/SDBC1010 - SDBB
Zoom	13:15:01	INSERT INTO SHADOW.STORAGE (PRODUCT,SUBSYSTEM,INTERVAL_START,MAXIMUM_USERS,SUBPOOL,
Zoom	13:15:01	DSNHLI INTERNAL EXECUTE - DSNT400I SQLCODE = 000, SUCCESSFUL EXECUTION - SDBC1010
Zoom	13:15:01	DSNHLI INTERNAL EXECUTE - DSNT400I SQLCODE = 000, SUCCESSFUL EXECUTION - SDBC1010
Zoom	13:15:01	DSNHLI INTERNAL EXECUTE - DSNT400I SQLCODE = 000, SUCCESSFUL EXECUTION - SDBC1010
Zoom	13:15:01	DSNHLI INTERNAL EXECUTE - DSNT400I SQLCODE = 000, SUCCESSFUL EXECUTION - SDBC1010
Zoom	13:15:01	DSNHLI INTERNAL EXECUTE - DSNT400I SQLCODE = 000, SUCCESSFUL EXECUTION - SDBC1010

**Figure 6–15. Locating a Message with a Particular Time in the Shadow Web Interface**

## Assigning and Locating Labels in Trace Browse

You can use labels to identify significant points within your trace log. This is a time-saving device that allows you to go straight to the points you have identified and labeled, bypassing the less significant entries.

These labels can only be used in the MSGNO column, since this column is the only modifiable one in trace browse (i.e., you can type over the values in the column).

To go to these labels, you can use the **LOCATE** command (see “Locating Messages” on page 6-20). The format of trace browse labels is identical to the format of ISPF Edit labels:

```
.aaaaaaa
```

A label consists of a period (“.”) followed by 1 to 7 alphabetic characters (a to z, uppercase or lowercase). As with ISPF Edit, you can never use numbers in a label.



### Note:

Internally, all label names are folded to uppercase for the purpose of comparison.

To assign a label, do the following:

1. On the command line of the main **Shadow Mainframe Adapter Server Trace** panel (Figure 6–1), use the **DISPLAY** command followed by the appropriate column names.
2. Press ENTER. The system will display the trace, including the specified columns and the message contents. In the example shown in Figure 6–16, the following command has been entered:

```
d msgno date
```

```
----- Shadow Mainframe Adapter Server Trace --- 21:51:58 22 MAY
01 Cols 001 062
COMMAND ==>                                SCROLL ==> PAGE
MESSAGENUM DDMMM -----1-----2-----3-----4-----5-----6--
0000006816 22MAY RESMGR DETECTED TERMINATION OF TASK OUTSIDE OF MAIN PRODUCT AS
0000006817 22MAY RESMGR DETECTED TERMINATION OF TASK OUTSIDE OF MAIN PRODUCT AS
0000006818 22MAY RESMGR DETECTED TERMINATION OF TASK OUTSIDE OF MAIN PRODUCT AS
0000006823 22MAY RESMGR DETECTED TERMINATION OF TASK OUTSIDE OF MAIN PRODUCT AS
0000006824 22MAY RESMGR DETECTED TERMINATION OF TASK OUTSIDE OF MAIN PRODUCT AS
0000006825 22MAY RESMGR DETECTED TERMINATION OF TASK OUTSIDE OF MAIN PRODUCT AS
0000006886 23MAY RESMGR DETECTED TERMINATION OF TASK OUTSIDE OF MAIN PRODUCT AS
0000006889 23MAY RESMGR DETECTED TERMINATION OF TASK OUTSIDE OF MAIN PRODUCT AS
0000006890 23MAY RESMGR DETECTED TERMINATION OF TASK OUTSIDE OF MAIN PRODUCT AS
0000006891 23MAY RESMGR DETECTED TERMINATION OF TASK OUTSIDE OF MAIN PRODUCT AS
0000006892 23MAY RESMGR DETECTED TERMINATION OF TASK OUTSIDE OF MAIN PRODUCT AS
0000006893 23MAY RESMGR DETECTED TERMINATION OF TASK OUTSIDE OF MAIN PRODUCT AS
0000006894 23MAY RESMGR DETECTED TERMINATION OF TASK OUTSIDE OF MAIN PRODUCT AS
0000006895 23MAY RESMGR DETECTED TERMINATION OF TASK OUTSIDE OF MAIN PRODUCT AS
0000006896 23MAY RESMGR DETECTED TERMINATION OF TASK OUTSIDE OF MAIN PRODUCT AS
0000006913 23MAY RESMGR DETECTED TERMINATION OF TASK OUTSIDE OF MAIN PRODUCT AS
0000006914 23MAY RESMGR DETECTED TERMINATION OF TASK OUTSIDE OF MAIN PRODUCT AS
```

**Figure 6–16. Shadow Mainframe Adapter Server Trace -- Displaying MSGNO for Assigning Labels**

3. Go to the first occurrence of the event and overwrite the numeric label in the MESSAGENUM column with an alphabetic one in the appropriate format.



**Note:**

There is no need to press ENTER after you enter the label. Just locate the next occurrence that you want to label.

4. Locate the next relevant occurrence of the event and add the next label.

Not all occurrences will be relevant. Only label those to which you may want to return. You can always move or delete the label later.

5. Continue adding labels until you are finished.

Figure 6–17 shows a message labelled “.POINT A” and a message labelled “.POINT B”.

```

----- Shadow Mainframe Adapter Server Trace --- 21:51:58 22 MAY
01  Cols 001 062
COMMAND ==>
                                SCROLL ==> PAGE
MESSAGENUM DMMM  -----1-----2-----3-----4-----5-----6--
.POINTA    22MAY RESMGR DETECTED TERMINATION OF TASK OUTSIDE OF MAIN PRODUCT AS
0000006817 22MAY RESMGR DETECTED TERMINATION OF TASK OUTSIDE OF MAIN PRODUCT AS
0000006818 22MAY RESMGR DETECTED TERMINATION OF TASK OUTSIDE OF MAIN PRODUCT AS
0000006823 22MAY RESMGR DETECTED TERMINATION OF TASK OUTSIDE OF MAIN PRODUCT AS
0000006824 22MAY RESMGR DETECTED TERMINATION OF TASK OUTSIDE OF MAIN PRODUCT AS
0000006825 22MAY RESMGR DETECTED TERMINATION OF TASK OUTSIDE OF MAIN PRODUCT AS
0000006886 23MAY RESMGR DETECTED TERMINATION OF TASK OUTSIDE OF MAIN PRODUCT AS
.POINTB    23MAY RESMGR DETECTED TERMINATION OF TASK OUTSIDE OF MAIN PRODUCT AS
0000006890 23MAY RESMGR DETECTED TERMINATION OF TASK OUTSIDE OF MAIN PRODUCT AS
0000006891 23MAY RESMGR DETECTED TERMINATION OF TASK OUTSIDE OF MAIN PRODUCT AS
0000006892 23MAY RESMGR DETECTED TERMINATION OF TASK OUTSIDE OF MAIN PRODUCT AS
0000006893 23MAY RESMGR DETECTED TERMINATION OF TASK OUTSIDE OF MAIN PRODUCT AS
0000006894 23MAY RESMGR DETECTED TERMINATION OF TASK OUTSIDE OF MAIN PRODUCT AS
0000006895 23MAY RESMGR DETECTED TERMINATION OF TASK OUTSIDE OF MAIN PRODUCT AS
0000006896 23MAY RESMGR DETECTED TERMINATION OF TASK OUTSIDE OF MAIN PRODUCT AS
0000006913 23MAY RESMGR DETECTED TERMINATION OF TASK OUTSIDE OF MAIN PRODUCT AS
0000006914 23MAY RESMGR DETECTED TERMINATION OF TASK OUTSIDE OF MAIN PRODUCT AS

```

**Figure 6–17. Shadow ISPF Assign Labels**

You can locate a label in any order using the **LOCATE** command, as follows:

1. On the command line of the main **Shadow Mainframe Adapter Server Trace** panel (Figure 6–1), use the **LOCATE** command followed by the assigned label name that you wish to locate. In this case, to find the first occurrence of the “.POINT B” label, type the following:
 

```
1 .POINTB
```
2. Press ENTER. The system will go to the first occurrence of the label. Figure 6–18 shows the first occurrence of the “.POINT B” label, as used in the example.

```

----- Shadow Mainframe Adapter Server Trace --- 21:51:58 22 MAY
01 Cols 001 062
COMMAND ==>
MESSAGEUM DDMMM -----1-----2-----3-----4-----5-----6--
SCROLL ==> PAGE
.POINTB 23MAY RESMGR DETECTED TERMINATION OF TASK OUTSIDE OF MAIN PRODUCT AS
0000006890 23MAY RESMGR DETECTED TERMINATION OF TASK OUTSIDE OF MAIN PRODUCT AS
0000006891 23MAY RESMGR DETECTED TERMINATION OF TASK OUTSIDE OF MAIN PRODUCT AS
0000006892 23MAY RESMGR DETECTED TERMINATION OF TASK OUTSIDE OF MAIN PRODUCT AS
0000006893 23MAY RESMGR DETECTED TERMINATION OF TASK OUTSIDE OF MAIN PRODUCT AS
0000006894 23MAY RESMGR DETECTED TERMINATION OF TASK OUTSIDE OF MAIN PRODUCT AS
0000006895 23MAY RESMGR DETECTED TERMINATION OF TASK OUTSIDE OF MAIN PRODUCT AS
0000006896 23MAY RESMGR DETECTED TERMINATION OF TASK OUTSIDE OF MAIN PRODUCT AS
0000006913 23MAY RESMGR DETECTED TERMINATION OF TASK OUTSIDE OF MAIN PRODUCT AS
0000006914 23MAY RESMGR DETECTED TERMINATION OF TASK OUTSIDE OF MAIN PRODUCT AS

```

**Figure 6–18. Shadow ISPF Locate Labels**

## Finding Character Strings within Messages

The Trace Browse application offers two ways of finding character strings within the text of messages:

- Using the **FIND** command.
- Using the **FIND** command against the columns of the **DISPLAY** command. This method can save time over just using the **FIND** command.

### Using the *FIND* Command

The syntax for the **FIND** command is as follows:

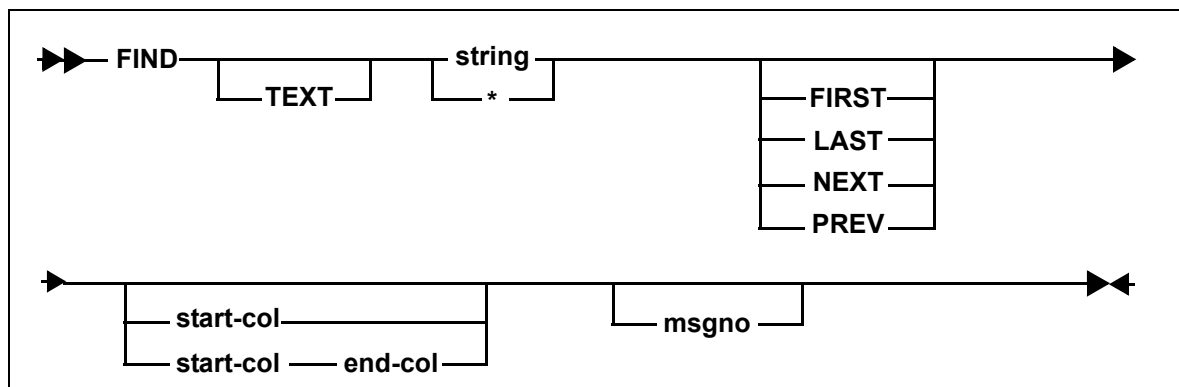

Where:

#### **TEXT**

Specifies an optional keyword indicating that the search is to take place against the text of the message and not against any of the other search columns.

**string**

Specifies the string for which to search in the message text. If there are embedded blanks or if the string is identical to a **FIND** keyword, it must be enclosed in quotes. Both single quotes and double quotes are accepted, with the restriction that a string must begin and end with the same type of quote mark. If you want to include a quote mark (either single or double) within a string, you must “double-up” the quote marks, as follows:

```
FIND 'this ain't good english'
```

Alternatively, you can use one type of quote mark to delimit the string and the other type as data within the string, as follows:

```
FIND "this ain't good english"
```

\*

Indicates that the search string from the previous **FIND** command is to be used.

**FIRST**

Finds the first occurrence of the string.

**LAST**

Finds the last occurrence of the string.

**PREV**

Directs the search direction upward.

**NEXT**

Directs the search direction downward.

**start-column**

Indicates the beginning text column for the search. Columns before start-col are not searched.

**end-column**

Indicates the ending text column for the search. Columns after end-col are not searched. If start-col is specified but end-col is not, end-col is assumed to be start-col + length(string) - 1.

**msgno**

Specifies the number of messages to scan before abandoning the search. By default, 5,000 messages are searched.

**Note:**

Trace browse is able to distinguish between msgno and start-col and/or end-col by examining the magnitude of the numbers. A number larger than 768 is assumed to be a message number and not a column number.



**Example:** The following **FIND** command will search for string “SDB1234W” from the currently displayed top message number, beginning in column 10 and extending to column 30, for 10,000 messages:

```
F 'SDB1234W XYZ' 10 30 10000
```

**ISPF Panel Users.** To use the **FIND** command, do the following:

1. On the command line of the main **Shadow Mainframe Adapter Server Trace** panel (Figure 6–19), use the **FIND** command, followed by your search criteria.
2. Press ENTER. The system finds the first instance of the search criteria. Figure 6–19 shows the results of using the following **FIND** command:

```
f userid ai38ccf
```

```
----- Shadow Mainframe Adapter Server Trace --- 21:51:5  USERID
'AI38CCF' FOUND
COMMAND ===>                                SCROLL ===> PAGE
USERID  ----+----1----+----2----+----3----+----4----+----5----+----6----+----7
AI38CCF RESMGR DETECTED TERMINATION OF TASK OUTSIDE OF MAIN PRODUCT ASID
AI38CCF RESMGR DETECTED TERMINATION OF TASK OUTSIDE OF MAIN PRODUCT ASID
AI38CCF RESMGR DETECTED TERMINATION OF TASK OUTSIDE OF MAIN PRODUCT ASID
AI38CCF RESMGR DETECTED TERMINATION OF TASK OUTSIDE OF MAIN PRODUCT ASID
AI38CCF RESMGR DETECTED TERMINATION OF TASK OUTSIDE OF MAIN PRODUCT ASID
AI38CCF RESMGR DETECTED TERMINATION OF TASK OUTSIDE OF MAIN PRODUCT ASID
```

**Figure 6–19. Shadow ISPF Find Command**

3. Use the **RFIND** command (with no operands) to repeat the most recently executed **FIND** command.

**Shadow Web Interface Users.** To use the **FIND** command, do the following:

1. From the main menu, select **Trace Browse** → **Trace Browse Records**. The system displays the trace browse records.
2. In the **Command** field, use the **FIND** command, followed by your search criteria.
3. Press ENTER. The system finds the first instance of the search criteria. Figure 6–21 shows the results of using the following **FIND** command:

```
f userid ai38ccf
```

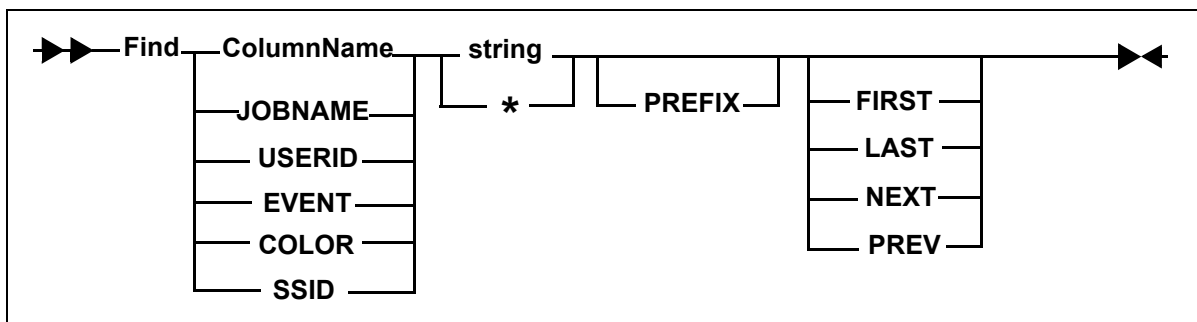

Figure 6–20. Shadow Web Interface Repeat Find Command

- Use the **R**FIND command (with no operands) or click the **Repeat Find** menu choice (  ) from the top of the screen to repeat the most recently executed **FIND** command.

### Using the FIND Command within DISPLAY Columns

The syntax for the **FIND** command within **DISPLAY** columns is as follows:



Where:

#### ColumnName

Specifies one of the following **DISPLAY** columns:

- **JOBNAME:** Searches the **JOBNAME** column. Currently not used.
- **USERID:** Searches the **USERID** column. For example:  
FIND USERID AI38XXX
- **EVENT:** Searches the **EVENT** column. For example:  
FIND EVENT DET

- **COLOR:** Searches the COLOR column. For example:  
F COLOR RED
- **SSID:** Searches the SSID (Shadow Mainframe Adapter Server ID) column. For example:  
F SSID SDBB

**string**

Specifies the string for which to search in the message text. If there are embedded blanks or if the string is identical to a **FIND** keyword, it must be enclosed in quotes. Both single quotes and double quotes are accepted, with the restriction that a string must begin and end with the same type of quote mark. If you want to include a quote mark (either single or double) within a string, you must “double-up” the quote marks, as follows:

```
FIND 'this ain''t good english'
```

Alternatively, you can use one type of quote mark to delimit the string and the other type as data within the string, as follows:

```
FIND "this ain't good english"
```

\*

Indicates that the search string from the previous **FIND** command is to be used. For example:

```
FIND *
```

**PREFIX**

Specifies that the search string is a generic search string and requires that only the prefix characters be entered. If you do not specify the PREFIX, keyword matching is byte-for-byte.

PREFIX is currently not supported for EVENT, COLOR, and TEXT columns.

**FIRST**

(Default) Finds the first occurrence of the string.

**LAST**

Finds the last occurrence of the string. For example:

```
F LAST EVENT DET
```

**PREV**

Directs the search direction upward. For example:

```
F PREV EVENT DET
```

**NEXT**

Directs the search direction downward.

**ISPF Panel Users.** To use the **FIND** command against the columns of the **DISPLAY** command, do the following:

1. On the command line of the main **Shadow Mainframe Adapter Server Trace** panel (Figure 6–21), use the **FIND** command, followed by your search criteria.
2. Press ENTER. The system finds the first instance of the search criteria. Figure 6–21 shows the results of entering the following **FIND** command within a **DISPLAY** column:

```
f event det
```

----- Shadow Mainframe Adapter Server Trace --- 13:17:5										EVENT
'DET' FOUND										
COMMAND ==>										SCROLL ==> PAGE
HH:MM:SS.UUUUUU	CPU TIME	HOST NAME	EVN	TCBADD	-----1-----	-----2-----	-----3----			
13:17:58.680565	000.029S	N/A	DET	8AAE00	RESMGR	DETECTED	TERMINATION OF TA			
13:53:56.298785	000.403S	N/A	DET	8CFC50	RESMGR	DETECTED	TERMINATION OF TA			
16:29:58.217938	000.035S	N/A	DET	8AAE00	RESMGR	DETECTED	TERMINATION OF TA			
10:49:16.694944	000.185S	N/A	DET	8CFC50	RESMGR	DETECTED	TERMINATION OF TA			
10:53:41.439585	000.286S	N/A	DET	8CFC50	RESMGR	DETECTED	TERMINATION OF TA			
11:01:00.366864	000.282S	N/A	DET	8CFC50	RESMGR	DETECTED	TERMINATION OF TA			
11:01:25.454276	000.054S	N/A	DET	8CFC50	RESMGR	DETECTED	TERMINATION OF TA			
11:02:08.064477	000.301S	N/A	DET	8CFC50	RESMGR	DETECTED	TERMINATION OF TA			
11:03:20.989981	000.059S	N/A	DET	8CFC50	RESMGR	DETECTED	TERMINATION OF TA			
11:14:56.359568	000.053S	N/A	DET	8CFC50	RESMGR	DETECTED	TERMINATION OF TA			
11:14:57.254141	000.034S	N/A	DET	8AAE00	RESMGR	DETECTED	TERMINATION OF TA			

**Figure 6–21. Shadow ISPF FIND Command within Display Columns**

3. Use the **RFIND** command (with no operands) to repeat the most recently executed **FIND** command.

**Notes:**

- There is no upper limit for searching columns. An unsuccessful search goes from the starting point to the end of the messages (for both upward and downward searches).
- The **DISPLAY** column does *not* need to be visible for the **FIND** command to work. If the column is not visible, a successful search results in the cursor being placed in the first column of the text field.
- Even though some column names are abbreviated on the panel, you must reference the full column name when you issue the **FIND** command. For example, the **EVENT** column name is displayed on the panel as **EVN**. To find an event, you must use **EVENT**, not **EVN**, as follows:

```
F EVENT DET
```

**Shadow Web Interface Users.** To use the **FIND** command against the columns of the **DISPLAY** command, do the following:

1. From the main menu, select **Trace Browse** → **Trace Browse Records**. The system displays the trace browse records.
2. In the **Command** field, use the **FIND** command, followed by your search criteria.
3. Press **ENTER**. The system finds the first instance of the search criteria. Figure 6–22 shows the results of entering the following **FIND** command within a **DISPLAY** column:

```
f event det
```

The screenshot shows the Shadow Server web interface. At the top, there is a navigation bar with the NEON logo and links for home, neon home, and support. Below this is a menu on the left with options like Product, Storage, Trace Browse, Communications, Database, CICS, IMS, RRS, and TSO. The main area contains a 'Command' input field with 'f event det' entered. To the right of the input field are buttons for 'Scroll Up', 'Scroll Down', 'Submit Command', and 'Repeat Find'. Below the input field is a table titled 'Trace Browse Records' with columns for 'Actions', 'UserID', and 'Record\_Text'. The table contains six rows of data, each with a 'Zoom' link in the Actions column, the UserID 'AI38CCF', and the Record\_Text 'RESMGR DETECTED TERMINATION OF TASK OUTSIDE OF MAIN PRODUCT ASID'.

Actions	UserID	Record_Text
<a href="#">Zoom</a>	AI38CCF	RESMGR DETECTED TERMINATION OF TASK OUTSIDE OF MAIN PRODUCT ASID
<a href="#">Zoom</a>	AI38CCF	RESMGR DETECTED TERMINATION OF TASK OUTSIDE OF MAIN PRODUCT ASID
<a href="#">Zoom</a>	AI38CCF	RESMGR DETECTED TERMINATION OF TASK OUTSIDE OF MAIN PRODUCT ASID
<a href="#">Zoom</a>	AI38CCF	RESMGR DETECTED TERMINATION OF TASK OUTSIDE OF MAIN PRODUCT ASID
<a href="#">Zoom</a>	AI38CCF	RESMGR DETECTED TERMINATION OF TASK OUTSIDE OF MAIN PRODUCT ASID
<a href="#">Zoom</a>	AI38CCF	RESMGR DETECTED TERMINATION OF TASK OUTSIDE OF MAIN PRODUCT ASID

**Figure 6–22. Shadow Web Interface FIND Command within Display Columns**

4. Use the **RFIND** command (with no operands) or click the **Repeat Find** menu choice (  ) from the top of the screen to repeat the most recently executed **FIND** command.

▷ **Notes:**

- There is no upper limit for searching columns. An unsuccessful search goes from the starting point to the end of the messages (for both upward and downward searches).
- The **DISPLAY** column does *not* need to be visible for the **FIND** command to work. If the column is not visible, a successful search results in the cursor being placed in the first column of the text field.
- Even though some column names are abbreviated on the panel, you must reference the full column name when you issue the **FIND** command. For example, the **EVENT** column name is displayed on the panel as **EVN**. To find an event, you must use **EVENT**, not **EVN**, as follows:

```
F EVENT DET
```

## Using Row Information Commands

There are primary commands available that can be used to invoke the special information displays for a particular trace browse row.

**ISPF Panel Users.** The following four primary commands can be used to obtain information about a particular row in ISPF:

- **SDZOOM** is used to invoke the Control Block Browse sub-application. This subapplication presents formatted control block information for the selected row and is used only for product support. By default, F4 is set to execute the **SDZOOM** command.
- **SDINFO** is used to invoke the SQL Explain sub-application. This subapplication presents explanatory text regarding the **SQLCODE** associated with the selected row. By default, F6 is set to execute the **SDINFO** command.
- **SDTRAC** is used to invoke the SQL Trace sub-application. This subapplication presents a trace of all SQL events for the connection ID associated with the selected row. By default, F16 is set to contain the **SDTRAC** command.
- **SDDATA** is used to invoke the SQL Data subapplication. This sub-application presents a formatted SQL Communications Area (**SQLCA**) control block for the selected row. By default, F18 is set to contain the **SDDATA** command.

These commands are used in conjunction with location of the cursor to determine for which row to provide information.

To invoke one of the special information displays, do one of the following:

- Type the appropriate command in the command field, then position the cursor under the line in the display that you are interested in before pressing ENTER.
- Simply place the cursor on the appropriate line and press the PF key associated with the desired command.

**Shadow Web Interface Users.** The following three primary commands can be used to obtain information about a particular row in the Shadow Web Interface:

- **ZOOM** is used to invoke the Control Block Browse sub-application. This subapplication presents formatted control block information for the selected row and is used only for product support.
- **Ittrace** is used to invoke the SQL Trace subapplication. This sub-application presents a trace of all SQL events for the connection ID associated with the selected row.
- **DATA** is used to invoke the SQL Data application. This sub-application presents a formatted SQL Communications Area (SQLCA) control block for the selected row.

To invoke one of these special displays, double click on the applicable button to the left of the row.

## ***Understanding the Order of Trace Browse Events***

As Shadow Mainframe Adapter Server executes a particular SQL statement, several events will be entered into the trace log on both the Mainframe Adapter Server and Mainframe Adapter Client sides. Both logs will perceive the series of events from different perspectives, and they may have a very different account of a single event.

For instance, the Mainframe Adapter Client may execute a SQL statement and simultaneously enter the following events in its trace log:

```
SEND event
RECEIVE event
SQL event          the results are returned
```

The same three events will be logged on the Mainframe Adapter Server side as follows:

```
RECEIVE event    matches the Mainframe Adapter Client SEND event
SQL event        the SQL statement is actually sent to DB2
SEND event       matches the Mainframe Adapter Client RECEIVE
event
```

The Mainframe Adapter Client side appears to be out of order until you consider that the sequences above are actually synchronized operations. If you could view a combined trace log, the SQL statement execution would appear as follows:

```
SEND event      Mainframe Adapter Client side
RECEIVE event   Mainframe Adapter Server side
SQL event       Mainframe Adapter Server side
SEND event      Mainframe Adapter Server side
RECEIVE event   Mainframe Adapter Client side
SQL event       Mainframe Adapter Client side
```

## Printing Trace Browse Information

You can print any information from the Trace Browse application.

**ISPF Panel Users.** To print trace browse information, do one of the following:

- To print a selected line, use the **P** line command in the MSGNO column.
- To print a block of information, use the **PP** line command in the MSGNO column on both the first and last line of the block you want to print out. The trace will appear as shown in Figure 6–23.

```
----- Shadow Mainframe Adapter Server Trace --- 21:51:58 22 MAY
01 Cols 001 062
COMMAND ===>                                SCROLL ===> PAGE
MESSAGE NUM DDMM ---+---1---+---2---+---3---+---4---+---5---+---6---
0000006816 22MAY RESMGR DETECTED TERMINATION OF TASK OUTSIDE OF MAIN PRODUCT AS
0000006817 22MAY RESMGR DETECTED TERMINATION OF TASK OUTSIDE OF MAIN PRODUCT AS
0000006818 22MAY RESMGR DETECTED TERMINATION OF TASK OUTSIDE OF MAIN PRODUCT AS
0000006823 22MAY RESMGR DETECTED TERMINATION OF TASK OUTSIDE OF MAIN PRODUCT AS
0000006824 22MAY RESMGR DETECTED TERMINATION OF TASK OUTSIDE OF MAIN PRODUCT AS
0000006825 22MAY RESMGR DETECTED TERMINATION OF TASK OUTSIDE OF MAIN PRODUCT AS
0000006886 23MAY RESMGR DETECTED TERMINATION OF TASK OUTSIDE OF MAIN PRODUCT AS
0000006889 23MAY RESMGR DETECTED TERMINATION OF TASK OUTSIDE OF MAIN PRODUCT AS
PP          23MAY RESMGR DETECTED TERMINATION OF TASK OUTSIDE OF MAIN PRODUCT AS
0000006891 23MAY RESMGR DETECTED TERMINATION OF TASK OUTSIDE OF MAIN PRODUCT AS
0000006892 23MAY RESMGR DETECTED TERMINATION OF TASK OUTSIDE OF MAIN PRODUCT AS
0000006893 23MAY RESMGR DETECTED TERMINATION OF TASK OUTSIDE OF MAIN PRODUCT AS
0000006894 23MAY RESMGR DETECTED TERMINATION OF TASK OUTSIDE OF MAIN PRODUCT AS
0000006895 23MAY RESMGR DETECTED TERMINATION OF TASK OUTSIDE OF MAIN PRODUCT AS
0000006896 23MAY RESMGR DETECTED TERMINATION OF TASK OUTSIDE OF MAIN PRODUCT AS
0000006913 23MAY RESMGR DETECTED TERMINATION OF TASK OUTSIDE OF MAIN PRODUCT AS
PP          23MAY RESMGR DETECTED TERMINATION OF TASK OUTSIDE OF MAIN PRODUCT AS
```

**Figure 6–23. The PP Line Command (Printed Block Highlighted)**

## The Trace Browse Archival Facility

This section covers the following topics:

- Backups



- Configuring the Shadow Trace Browse Archival Facility
- Using the Trace Browse Archival Facility

## Backups

For archival purposes, you can configure Shadow Mainframe Adapter Server to periodically make automatic backups of the trace. The backups are recorded in exactly the same format as the active trace.



### Notes:

- The data remains in a proprietary format and cannot easily be processed by other utilities.
- Because the data remains in a proprietary format, the Shadow Mainframe Adapter Server's configured security authorization controls cannot easily be circumvented.

When each event is originally recorded within the trace, it is assigned a sequential message number. Message numbering within a newly formatted trace begins at one and increments sequentially. This is continued during product restarts.

All backup operations are performed using these message sequence numbers as a basis. For instance, the Shadow application initiates automatic backup operations based upon the number of new messages collected since the previous backup.

## How It Works

When the trace is backed with a DIV data set, the following occurs:

- The trace is checkpointed periodically to the dataset.
- The trace becomes persistent. This means that when Shadow Mainframe Adapter Server is restarted, the active trace is continued from the point at which the last event was recorded before the shutdown.
- The amount of virtual storage that z/OS must back within system page datasets is reduced; checkpointed pages are paged out of virtual storage.
- Each event is recorded into the next event block within the wraparound trace. The event records consist of a fixed length header and an event-specific recording area. For some event types, the recording area contains the actual text that you see when you view the trace. For other event types, binary information or internal control block images are placed into the recording area, but it is formatted as text when you view the records.

## Benefits and Tradeoffs of the Trace Browse Archival Facility

The Trace Browse Archival Facility yields an extremely useful and powerful diagnostic tool while keeping the run-time overhead of supporting the facility at an absolute minimum. Plus, the following benefits also exist:

- No detail is lost during backup processing.
- The archived data occupies no more DASD space than the original data.
- The archived data can be reviewed almost instantly, since no heavyweight preprocessing of the offline logs into virtual storage is required.
- Data-in-virtual (DIV) pages can be mapped instantly for review without scanning the data to re-create index information.

Individual backups cannot be merged together, since the sequencing of each event record and the indices which point to it are dependent on each event's relative position within the DIV pages. Also, the data remains in a proprietary format and cannot easily be processed by other utilities.



### **Note:**

Because the data remains in a proprietary format, the Shadow Mainframe Adapter Server's configured security authorization controls cannot easily be circumvented.

You should also be aware of the design tradeoffs inherent to this approach:

- The trace data-in-virtual (DIV) dataset cannot be shared between two or more active Shadow Mainframe Adapter Servers.
- The event block slot locations and size of the vector tables is fixed in relation to the total number of event block slots allocated. If you later change the number of event slots (i.e., change the Shadow Mainframe Adapter Server BROWSEMAX startup parameter), consider the following:
  - The trace area will be reformatted at the next startup, with a ***consequential loss of all pre-existing data***.
  - It will be necessary to re-size the data set for the trace browse VSAM file. Based on the BROWSEMAX value, the data set size for the trace browse VSAM file can be calculated by figuring 1K per line.

## Configuring the Shadow Trace Browse Archival Facility

Trace data is either archived automatically based upon your configuration of several startup parameters or it is not archived at all.

### Configuring for Automatic Trace Data Archiving

There are several start-up and dataset parameters that you will need to configure before any of the trace data is backed up. These parameters can be set in the Shadow Mainframe Adapter Server initialization EXEC, SDBxIN00, or they can be set dynamically by using the ISPF panels or the Shadow Web Interface.



#### Doc Reference:

For more information, see the *Shadow Mainframe Adapter Server Started Task Parameter Reference*.

```
"MODIFY PARM NAME ( BROWSEMAX ) VALUE (xxxxxxx) "
```

```
"MODIFY PARM NAME ( BROWSEARCHIVE ) VALUE (AUTO) "
```

```
"MODIFY PARM NAME ( BROWSEARCHIVECOUNT ) VALUE (xxxxxx) "
```

```
"MODIFY PARM NAME ( BROWSEINTERVAL ) VALUE (xx seconds) "
```

```
"MODIFY PARM NAME ( ARCHIVEDSNPREFIX ) VALUE (null) "
```

```
"MODIFY PARM NAME ( ARCHIVEDATACLASS ) VALUE (null) "
```

```
"MODIFY PARM NAME ( ARCHIVEMGMTCLASS ) VALUE (null) "
```

```
"MODIFY PARM NAME ( ARCHIVESTORCLASS ) VALUE (null) "
```

```
"MODIFY PARM NAME ( ARCHIVEDEFCLPARMS ) VALUE (null) "
```

```
"MODIFY PARM NAME ( BROWSEARCHIVE ) VALUE (auto) "
```

```
"MODIFY PARM NAME ( BROWSEARCHIVECOUNT ) VALUE (xx) "
```

```
"MODIFY PARM NAME ( BROWSEARCHIVECUSHION ) VALUE (xx) "
```

Where:

#### **BROWSEMAX**

Specifies the number of messages your trace will hold. Based on this value, the data set size for the trace browse VSAM file can be calculated by figuring 1K per line. The default value is 100,000.



#### **Note:**

Changing the value of this parameter in the Shadow initialization EXEC, SDBxIN00, will cause the trace browse to be reformatted at the next startup, with a *consequential loss of all pre-existing data*.

### **BROWSEARCHIVE**

Activates the automatic backup processing. Must be set to AUTO to activate.

### **BROWSEARCHIVECOUNT**

Specifies the number of messages to be written for each automated archival operation. Recommended value is no more than one-third of the BROWSEMAX value.

### **BROWSEINTERVAL**

Specifies the number of seconds between checkpointing operations. The default is 15, but it can be set between 1 and 300.

### **ARCHIVEDSNPREFIX**

Defines the high-level qualifier used by the subsystem to construct dataset names for trace browse archive files. The value “.Dyyyyddd.Thhmmss” is appended to the qualifier, where yyyyddd is the Julian date and hhmmss is the time of day. This parameter is modifiable after startup.



#### **Note:**

Because there is not a default value, trace browse archival processing cannot be performed if this prefix is not set.

### **ARCHIVEDATACLASS**

Defines the DATACLASS operand value used to define linear clusters for archive data sets. If it is not set, DATACLASS is not specified when the linear datasets are allocated.

### **ARCHIVEMGMTCLASS**

Defines the MGMTCLASS operand value used to define linear clusters for archive datasets. If it is not set, MGMTCLASS is not specified when the linear datasets are allocated.

### **ARCHIVESTORCLASS**

Defines the STORCLASS operand value used to define linear clusters for archive datasets. If it is not set, STORCLASS is not specified when the linear datasets are allocated.

### **ARCHIVEDEFCLPARMS**

Contains additional parameter values that are passed on DEFINE CLUSTER statements generated to define archive backup datasets.

### **BROWSEARCHIVECUSHION**

Specifies the number of messages to be used as a scheduling threshold or cushion for backup operations.

**Note:**

Normally, it is recommended that you begin testing the automatic backup facility by setting the BROWSEARCHIVECOUNT parameter to 30% of the BROWSEMAX count and setting the BROWSEARCHIVECUSHION parameter to 50% of the BROWSEARCHIVECOUNT value.

Shadow Mainframe Adapter Server schedules automatic backup operations using these configured values; however, if it detects that the values are inappropriate, it will override the values during start-up.

**Example**

The following example shows a backup configuration with the BROWSEMAX parameter set to 100,000 and the archived trace dataset going to the SMS storage class SYSSMS:

```
IF 1 = 1 THEN DO          /* ENABLE TRACEBROWSE ARCHIVING */
"MODIFY PARM NAME(BROWSEARCHIVE) VALUE(AUTO)"
"MODIFY PARM NAME(BROWSEARCHIVECOUNT) VALUE(30000)"
/* RECOMMENDED VALUE IS 30% OF BROWSEMAX MAX */
"MODIFY PARM NAME(BROWSEARCHIVECUSHION) VALUE(15000)"
/* RECOMMENDED VALUE IS 50% BROWSEARCHIVECOUNT */
"MODIFY PARM NAME(ARCHIVEDSNPREFIX) VALUE(NEON.SWSS.ARCHIVE)"
"MODIFY PARM NAME(ARCHIVESTORCLASS) VALUE(SYSSMS)"
END
```

**Avoiding a Thrashing Condition**

To avoid a thrashing condition, where the Mainframe Adapter Server constantly builds backups in order to record activity before the trace wraps around, you should set your active trace large enough to record at least a few hours of activity before wraparounds occur. To do this, review the following considerations:

1. Check to see how many trace events are being logged within a given time period and how frequently the trace wraps around. The BROWSEMAX parameter can be set so that the active trace is sized properly.
2. Select the count of messages that will be copied each time an automatic backup operation is scheduled. This count should normally be 20% to 80% of the BROWSEMAX value and is set by the BROWSEARCHIVECOUNT start-up parameter. You want this count value to be sufficiently high so that backup operations are not constantly underway. However, it should also be low enough that even under heavy load, the active trace will not wrap around before activity can be backed up.

**Note:**

Shadow Mainframe Adapter Server does not suspend operation nor stop the recording of new events, even if the new activity begins to overlay messages that have not yet been backed up.

3. Select the count of messages that will be used as a scheduling threshold or cushion for backup operations. This cushion value is used by Shadow Mainframe Adapter Server to avoid creating archives in which some messages have been overlaid due to trace wraparound.

## Using the Trace Browse Archival Facility

To use the Trace Browse Archival Facility, do the following:

1. From the **Shadow Mainframe Adapter Server Primary Option Menu**, select Option 5, SDB Control.
2. Press ENTER. The system displays the **Shadow Mainframe Adapter Server Control Option Menu**.
3. From this menu, select Option 15, Trace Archive. The system displays the **Shadow Mainframe Adapter Server Trace Archive** panel shown in Figure 6–24.

```

----- Shadow Mainframe Adapter Server Trace Archive Facility -----
-----
Option  ===>                                     Subsys: SDBB

1  Status      - Display Trace Browse Archive Status Information

```

**Figure 6–24. Trace Archive Facility**

4. Select one of the following options:
  - Option 1 to view the trace browse archive status information.
  - Option 2 to view trace backup archives.

## Viewing Active Trace Backup/Archive Status

To view the trace browse archive status information, do the following:

1. From the **Shadow Mainframe Adapter Server Trace Archive** (Figure 6–24), select Option 1, Status. The system displays the first **Active Trace Backup/Archive Status** panel shown in Figure 6–25.

```

----- Active Trace Backup/Archive Status -----
Command ==>>>                                     Subsys => SDBW

Active Trace Backup Control Values:
  Active Trace data set          CSD.AI38.SDBW.TRACE
  Highest Message No. Traced    6931
  Last Message Archived         0
  Backup Kickoff Message No     0
  Archive Control Status Word   0000000700008000

Most Recent Backup Information (No-Information):
  Last Backup data set Name     None
  First Message No. in Backup   0
  Messages in This Backup       0
  Backup Requestor              None

```

**Figure 6–25. Backup/Archive Status, Panel 1**

This panel provides the name of the active trace dataset, the latest message information, and the status information for the most recent backup.

2. Press ENTER. The system displays the second **Active Trace Backup/Archive Status** panel shown in Figure 6–26.

```

----- Active Trace Backup/Archive Status -----
Command ==>>>                                     Subsys => SDBW

Automatic Backup Control Parameters:
  Backup Control Option         None
  Messages Per Backup           3000
  Wrap-around Prot. Cushion     1500

Backup data set Allocation Parameters:
  Output data set Name Prefix   CSD.AI38.SDBW.ARCHIVE
  IDCAMS DFSMS Dataclass       No-Value
  IDCAMS DFSMS Managementclass No-Value
  IDCAMS DFSMS Storageclass     SYSSMS
  Additional 'DEFINE CLUSTER' Parameters:
  No-Value

```

**Figure 6–26. Backup/Archive Status, Panel 2**

This panel shows the parameter settings for automatic backup control and for backup data set allocation.

3. Press ENTER. The system displays the third **Active Trace Backup/Archive Status** panel shown in Figure 6–27.

```

----- Active Trace Backup/Archive Status -----
Command ==> Subsys => SDBW

Sample of IDCAMS statement the Mainframe Adapter Server will generate for Archive
Backup data set allocation (based on configured parameters):

DEFINE CLUSTER (
NAME( 'CSD.AI38.SDBW.ARCHIVE.D2001143.T155839' )      -
LINEAR SHR(2,3) KILOBYTES(3204)                      -
STORAGECLASS(SYSSMS )                               )

Note: Size specification is based on 3000 messages per backup.

```

**Figure 6–27. Backup/Archive Status, Panel 3**

This panel gives a sample of the IDCAMS statement that will be generated by the Mainframe Adapter Server for the backup data set allocation. It is based on the parameter values shown in the second panel.

4. Press ENTER. The system displays the fourth and final **Active Trace Backup/Archive Status** panel shown in Figure 6–28.

```

----- Active Trace Backup/Archive Status -----
Command ==> Subsys => SDBW

Active Archive Backup/Cleanup Processing Subtasks:

EFTK      TCB      Requestor-Userid  -----Inflight Command-----
Address   Address   Command-Origin

```

**Figure 6–28. Backup/Archive Status, Panel 4**

This panel displays the subtask information for archive backup/cleanup processing.

## Viewing Trace Backup Archives

To view trace backup archives, do the following:

1. From the **Shadow Mainframe Adapter Server Trace Archive** (Figure 6–24), select Option 2, View Backups. The system displays the **Active Data Set List** panel shown in Figure 6–29.



```

----- Archive data set List ----- Row 1 to 4 of
COMMAND ==>                                SCROLL ==> PAGE
Line Commands:  S - View Archive data set   R - Recall Migrated data set
DSN Qualifier:  CSD.AI38.SDBW.ARCHIVE

S Archive data set Name                      Status  Creation Date/Time
CSD.AI38.SDBW.ARCHIVE.D2000278.T105108    Avail   10/04/2000 10:51:08
CSD.AI38.SDBW.ARCHIVE.D2000278.T105340    Avail   10/04/2000 10:53:40
CSD.AI38.SDBW.ARCHIVE.D2000278.T105740    Avail   10/04/2000 10:57:40
CSD.AI38.SDBW.ARCHIVE.D2000278.T111530    Avail   10/04/2000 11:15:30
*** End Of List ***

```

**Figure 6–29. Archive data set List**

This panel shows the active data set name for which backup will be displayed.

2. To view the archive dataset, type the **S** command to the left of the archive dataset name.
3. Press ENTER. The system will display the **Shadow Mainframe Adapter Server Archive Review** panel shown in Figure 6–30.

```

----- Shadow Mainframe Adapter Server Archive Review ----- 21:08:50 21 SEP
00 Cols 001 060
Command ==>                                Scroll ==> PAGE
Dsn=> CSD.AI38.SDBW.ARCHIVE.D2000278.T105108    Msg=>      0 To 0
HH:MM:SS HOST NAME  ----+-----1-----+-----2-----+-----3-----+-----4-----+-----5-----+-----6
21:08:50 CICSA      ALLOCATE_PIPE EXECUTED - EXCI CICSA - EXCI ALLOCATE PIPE COM
21:08:50 CICSA      OPEN_PIPE EXECUTED - EXCI CICSA - EXCI OPEN PIPE COMPLETED N
21:08:50 CICSA      INIT_USER EXECUTED - EXCI CICSA - EXCI INIT_USER COMPLETED N
21:08:50 CICSA      ALLOCATE_PIPE EXECUTED - EXCI CICSA - EXCI ALLOCATE PIPE COM
21:08:50 CICSA      OPEN_PIPE EXECUTED - EXCI CICSA - EXCI OPEN PIPE COMPLETED N
21:08:50             DRA INITIALIZATION CALL - RETURN CODE ZERO
21:08:50 CICSA      INIT_USER EXECUTED - EXCI CICSA - EXCI INIT_USER COMPLETED N
21:08:50 CICSA      ALLOCATE_PIPE EXECUTED - EXCI CICSA - EXCI ALLOCATE PIPE COM
21:08:50 CICSA      OPEN_PIPE EXECUTED - EXCI CICSA - EXCI OPEN PIPE COMPLETED N
21:08:50 CICSA      INIT_USER EXECUTED - EXCI CICSA - EXCI INIT_USER COMPLETED N
21:08:50 CICSA      ALLOCATE_PIPE EXECUTED - EXCI CICSA - EXCI ALLOCATE PIPE COM
21:08:50 CICSA      OPEN_PIPE EXECUTED - EXCI CICSA - EXCI OPEN PIPE COMPLETED N
21:08:50 CICSA      INIT_USER EXECUTED - EXCI CICSA - EXCI INIT_USER COMPLETED N

```

**Figure 6–30. Archive Review**

This panel shows the trace archive backup for that dataset.

## Using Trace Browse Archival Commands

The Trace Browse Archival Facility provides environment commands that can be used to manually override automatic processes taking place within the archival facility.

To use these commands, do the following:

1. From the **Shadow Mainframe Adapter Server Primary Option Menu**, select Option 7, Shadow Event Facility.
2. Press ENTER. The system displays the **Shadow Mainframe Adapter Server Event Facility Control** panel shown in Figure 6–31.

```

----- Shadow Mainframe Adapter Server Event Facility Control -----
-- Subsystem SDBB
OPTION ===>

  1 Global Variables      - Display and Update Global Variables
  2 SEF Rule Management - Control SEF Event Procedures & Libraries
                        Show Selection Panel at Entry ===> Y
  3 Command Test        - View Results of Interactive Command Requests

```

**Figure 6–31. Shadow Mainframe Adapter Server Event Facility Control**

3. From this menu, select Option 3, Command Test.
4. Press ENTER. The system displays the **SEF - Command Response Display** panel shown in Figure 6–32.

```

SEF - Command Response Display ----- Row 1 to 2 of 2
COMMAND ===>                               SCROLL ===> PAGE

ADDRESS Environment ===> SEF      (SEF, SDB, TSO, or REXX)
Environment Command ===>

-----
      * No output was queued *
----- Return code 0 from SEF cmd "SUBSYS SDBB" -----
**END**

```

**Figure 6–32. SEF Command Response**

5. In the **ADDRESS Environment** field, type SEF.
6. In the **Environment Command** field, type the environment command. Possible commands include the following:
  - **ARCHIVE CLEANUP:** Cleans up counters and any remaining, partially built datasets after an archive backup has failed. The Shadow Mainframe Adapter Server issues this internally at start-up, if an archive backup was in-flight at shutdown.
  - **ARCHIVE BACKUP:** Manually kicks off an archive backup task.
  - **ARCHIVE BACKUP,TOEND:** Manually kicks off an archive backup task. The archive backup will record all remaining messages that had not

been backed up through the point where the **ARCHIVE BACKUP,TOEND** command was issued. Normally a backup stops a few thousand messages (the cushion) before the most recently recorded trace message.

- **ARCHIVE RESET,nnnn**: Resets the last backed-up message number to “nnnn”.
- **ARCHIVE STATUS**: Displays the current status of the archive facility.

The command will be sent to the requested environment and will be scheduled to execute.

## SQL Trace

This section covers the following topics:

- Available Commands
- Column Names
- Invoking SQL Trace

### Available Commands

The SQL Trace application supports all four scrolling commands (**UP**, **DOWN**, **LEFT**, **RIGHT**) and their PF key equivalents or scroll bar equivalents. No other primary commands are supported.

In addition, the ISPF and Shadow Web Interface applications support the SQL trace commands shown in Table 6–4.

**Table 6–4. SQL Trace Commands**

Command Description	ISPF	Web Interface
Displays SQL statement source, SQLCODE, SQLCA, and error messages.	D	Data
Starts the SQL Explain application (requires MVS/Quick-Ref).	E	N/A
Formats the information for the selected row.	F	Format
Displays user SQL information for the selected row.	I	Info
Prints the user trace control block for the selected row.	P	N/A
Displays the user trace control block for the selected row.	S	Block
Displays user detail for the selected row.	U	Detail

To use the SQL trace commands, do one of the following:

- **ISPF panels**: Type the command to the left of the line and press ENTER.
- **Shadow Web Interface**: Click on the selected command.

## Column Names

Table 6–4 provides a description for each column name on the ISPF panels as well as the Shadow Web Interface screen. Sort names are provided for users of the ISPF panels.

**Table 6–5. SQL Trace Column Names**

Column Name	Description	Sort Name (ISPF only)
CURRENT TIME	The current time.	CURRENT
SQL SOURCE	<p>Describes the type of SQL statement being executed. When possible, Shadow Mainframe Adapter Server will save and display the actual SQL statement that was executed. In addition to SQL statements, certain communication actions and internal events also appear in this column, including the following:</p> <ul style="list-style-type: none"> <li>• <b>ATTACH:</b> Used to start a communication session from a Mainframe Adapter Client to a Mainframe Adapter Server.</li> <li>• <b>BIND:</b> Used to synchronize operational parameters between participating Shadow Mainframe Adapter Server systems. This is not a VTAM bind.</li> <li>• <b>LOGON:</b> Sends userid information for authentication.</li> <li>• <b>INTERNAL FETCH:</b> An internal SQL FETCH performed on the Mainframe Adapter Server to fill a prefetch buffer. Used only for block fetch.</li> <li>• <b>BYPASSED FETCH:</b> A FETCH that has been sent to the Mainframe Adapter Server. This FETCH initiates the transmission of prefetch buffers to the Mainframe Adapter Client. The FETCH is not actually executed on the Mainframe Adapter Server side (it is literally bypassed). The actual FETCH request is satisfied from prefetch buffers on the Mainframe Adapter Client system. See “LOCAL FETCH,” below.</li> <li>• <b>LOCAL FETCH:</b> A real, Mainframe Adapter Client side FETCH that is satisfied by the prefetch buffer. See “BYPASSED FETCH,” above.</li> <li>• <b>I-CLOSE-THRD:</b> An internal CLOSE performed on the Mainframe Adapter Server end to close the plan (and terminate the thread) when the communication session with the Mainframe Adapter Client fails. This type of close is always done using the ABRT option (i.e., all changes since the last commit are “rolled back”).</li> <li>• <b>G-CLOSE-THRD:</b> An internal CLOSE performed only on the Mainframe Adapter Client side, when the Mainframe Adapter Client SDB detects that an application has terminated without issuing a close. In keeping with DB2’s rule on this matter, Shadow Mainframe Adapter Server closes with ABRT if the application terminates with an abend and with SYNC if the application terminates normally.</li> </ul>	

Table 6–5. SQL Trace Column Names (*continued*)

Column Name	Description	Sort Name (ISPF only)
SQL MESSAGE	The DSNTIAR-generated SQL message, whenever applicable. When it does not contain an actual DSN message, it contains return and reason code information.	HOST
PLAN NAME	The name of the plan that was used to open a thread to DB2.	PLAN
SQL RC	The most recent return code returned from a DB2 interface module.	SQLRC
SQL REASON	The most recent reason code returned from a DB2 interface module.	REASON
SQL CODE	The current value of the SQLCODE field of the SQLCA. Note that this field is not always relevant. For example, after a call to DSNTIAR, SQLCODE has no meaning.	SQLCODE
SQL STMT-TYPE	The verb of the current SQL statement, or NONE if the current operation is not a SQL statement.	SQLTYPE
STATEMENT NUMBER	The number of the SQL statement being executed. SQL statements are numbered by the SQL preprocessor in the order they are found (lexically) in a source module. If a SQL statement is not being executed, this field is zero.	STMTNO
CURSOR NUMBER	The number of the cursor that is being used. If a SQL statement is not being executed, this field is zero.	CURSOR
LOCKS HELD	Number of locks held.	
CPU TIME	The total amount of CPU time any single user is using. The format depends on how much CPU time the user has used so far: <ul style="list-style-type: none"> <li>Less than 1000 seconds: The format is nnn.nnnn</li> <li>Between 1000 seconds and 100 hours: The format is hh.mm.ss</li> <li>100 hours or more: The format is hhhhh.mm</li> </ul>	DB2
CONNECT TIME	The total amount of time (elapsed) the user has been using Shadow Mainframe Adapter Server .	CONNECT
CURRENT STATE	Indicates what the user's program is doing. The possible values are as follows: <ul style="list-style-type: none"> <li><b>PROCESS:</b> Indicates that either the user's program or DB2 is processing.</li> <li><b>SEND:</b> Indicates that a send operation is in process.</li> <li><b>RECEIVE:</b> Indicates that a receive operation is in process.</li> </ul>	STATE
STATE DURATION	The amount of time that has been spent in the current state (i.e., the amount of time processing, sending, or receiving).	DURATION

**Table 6–5. SQL Trace Column Names (continued)**

<b>Column Name</b>	<b>Description</b>	<b>Sort Name (ISPF only)</b>
<b>FUNCTION CODE</b>	Indicates the type of Shadow Mainframe Adapter Server processing that is currently taking place. The possible values are as follows: <ul style="list-style-type: none"> <li>• <b>DSNALI:</b> Indicates that a DSNALI (call attach) request is being processed.</li> <li>• <b>DSNHLI2:</b> Indicates that a DSNHLI (SQL statement) request is being processed.</li> <li>• <b>DSNTIAR:</b> Indicates that a DSNTIAR (SQLCA message decoding) request is being processed.</li> <li>• <b>LOGON:</b> Indicates that internal logon processing is taking place. Shadow Mainframe Adapter Server must log on to the remote Shadow Mainframe Adapter Server system.</li> <li>• <b>BIND:</b> Indicates that internal bind processing is taking place.</li> <li>• <b>ATTACH:</b> Indicates that internal attach processing is taking place.</li> <li>• <b>PREFETCH:</b> Indicates that internal prefetch processing is taking place (SDB is reading ahead on the current query).</li> </ul>	FUNCTION
<b>TOTAL SENT</b>	Refers to cumulative outbound data.	
TOTAL RAW SENT	The total number of kilobytes that have been queued to be transmitted for this connection. This is the pre-compression amount.	TOSENTR
TOTAL COMPRESSED SENT	The total number of kilobytes that have actually been transmitted. This is the post-compression amount.	TOSENTC
TOTAL PERCENT SENT	The compression percentage.	TOSENTP
<b>CURRENT SENT</b>	Refers to last outbound transmission.	
CURRENT RAW SENT	The number of kilobytes queued to be transmitted for the current send operation. This is the pre-compression amount.	CUSENTR
CURRENT COMPRESSED SENT	The number of kilobytes that have actually been transmitted for the current send operation. This is the post-compression amount.	CUSENTC
CURRENT PERCENT SENT	The compression percentage for the current send operation.	CUSENTP
<b>TOTAL RECEIVED</b>	Refers to cumulative inbound data.	
TOTAL RAW RECEIVED	The total number of kilobytes that have been received by this connection. This is the post-decompression amount.	TORECVR
TOTAL COMPRESSED RECEIVED	The total number of kilobytes that have actually been received. This is the pre-decompression amount.	TORECVC
TOTAL PERCENT RECEIVED	The compression percentage.	TORECVP

**Table 6–5. SQL Trace Column Names (continued)**

Column Name	Description	Sort Name (ISPF only)
<b>CURRENT RECEIVED</b>	Refers to last inbound transmission.	
CURRENT RAW RECEIVED	The number of kilobytes received from the current receive operation. This is the post-decompression amount.	CURECVR
CURRENT COMPRESSED RECEIVED	The number of kilobytes that have actually been received for the current receive operation. This is the pre-decompression amount.	CURECVC
CURRENT PERCENT RECEIVED	The compression percentage for the current receive operation	CURECVP
<b>TELEPROCESSING</b>	Refers to data transfer time.	
MSECS	The amount of time spent in transmitting the data.	TPMSECS
PERCENT	The percentage of the total time spent in teleprocessing.	TPPERCNT
<b>TOTAL TIME</b>	The total end-to-end time for the current operation.	TOTIME

## Invoking SQL Trace

You can invoke the SQL Trace application under the following applications:

- **Attached Users application:** Using the **T** line command
- **Remote Users application:** Using the **T** line command
- **Trace Browse application:** Using the **SDTRAC** primary command to trace a selected row

This section will demonstrate invoking the SQL Trace application using the Remote Users application.

### ISPF Users

To start the SQL Trace application, do the following:

1. From the **Shadow Mainframe Adapter Server Primary Option Menu**, select Option 4, Remote Users.
2. Press ENTER. The system displays the **Shadow Mainframe Adapter Server Remote Users** panel shown in Figure 6–33.
3. Type the **T** line command to the left of the user whose SQL statement you want to trace, as shown in Figure 6–33.

```

----- Shadow Mainframe Adapter Server Remote Users -----
SCR 1 ROW 1 OF 3
COMMAND ==>                                SCROLL ==> PAGE
Line Commands:  C Cancel Thread  E Explain Codes  F Format  I Information
K Kill User  P Print CB  S Show CB  T User Trace  U User Detail

HOST      LAN          HOST          LINK  APPLICATION
USERID    USERID         NAME          TYPE  NAME          NOTE
T AI38PHV  pvu             pvunttest    OTC/IP Not-Set
AI38PHV  pvu             pvutcpip     OTC/IP Not-Set

```

**Figure 6–33. Shadow ISPF Remote Users**

4. Press ENTER. The system displays the first **Shadow Mainframe Adapter Server SQL Trace** panel for the selected user. The panel will look similar to the one in Figure 6–34.

```

----- Shadow Mainframe Adapter Server SQL Trace for AI3      SC
1 ROW 1 OF 16
COMMAND ==>                                SCROLL ==> PAGE
Line Commands:  D Display Data  E Explain Codes  F Format  I Information
P Print CB  S Show CB  U User Detail

CURRENT  SQL
TIME     SOURCE          NOTE
13:43:42 ATTACH
13:43:42 BIND
13:43:42 RACF MESSAGE - ALLOW
13:43:42 AI38PHV
13:43:59 call shadow_cics('exci','excs','exci','dfh$axcs',2,'FILE
13:43:59 DSNHLI INTERNAL COMMIT
13:43:59 DSNHLI INTERNAL OPEN-CURSOR
13:43:59 DSNHLI INTERNAL FETCH
13:43:59 DSNHLI INTERNAL FETCH
13:43:59 DSNHLI INTERNAL CLOSE-CURSOR (1)
13:44:08 call shadow_cics('exci','excs','exci','dfh$axcs',2,'FILE
13:44:08 DSNHLI INTERNAL COMMIT
13:44:08 DSNHLI INTERNAL OPEN-CURSOR
13:44:08 DSNHLI INTERNAL FETCH
13:44:08 DSNHLI INTERNAL FETCH

```

**Figure 6–34. Shadow ISPF SQL Source**

There are seven panels that comprise the SQL Trace application. Use the **LEFT** and **RIGHT** scroll commands (or PF keys) to shift between them.



## Shadow Web Interface Users

To start the SQL Trace application, do the following:

1. From the main menu, select **Communications** → **Remote Users**. The system displays the remote users screen, as shown in Figure 6–35.
2. Double-click the **Utrace** command on the line of the user whose SQL statement you want to trace.

Actions	User ID	LAN Userid	Host Name	Link Type	Application Name	User Parameter	IP Address	Remote	Local	Path ID
<a href="#">Cancel, Format, Userinfo, KILL, Block, Utrace, Udetail</a>	AI38PHV	pvu	pvtucpip	OTC/IP	Not-Set	Not-Set	10.17.16.179	1638	1200	0
<a href="#">Cancel, Format, Userinfo, KILL, Block, Utrace, Udetail</a>	SDBB		10.17.16.69	OTC/IP	Not-Set	Not-Set	10.17.16.69	2791	1200	0

**Figure 6–35. Shadow Web Interface Remote Users**

3. Press ENTER. The system displays the SQL source in a screen similar to that shown in Figure 6–36.

Actions	Time	SQL Source	SQL Message	DB2 Subsystem Name	DB2 Plan Name	SQL Reason Code	SQL Code	SQL Statement Type
<a href="#">Data, Format, Info, Block, Detail</a>	11:18:35	ATTACH	RC 0		Not-Set	00000000	0	ATTACH
<a href="#">Data, Format, Info, Block, Detail</a>	11:18:35	BIND	RC 0		Not-Set	00000000	0	BIND
<a href="#">Data, Format, Info, Block, Detail</a>	11:18:35	RACF MESSAGE - ALLOW	AI38PHV	DSN1	SDBC1010	00000000	0	LOGON
<a href="#">Data, Format, Info, Block, Detail</a>	11:18:35	AI38PHV	RC 0 REASON 00000000 SQLCODE 0	DSN1	SDBC1010	00000000	0	OPEN-THREAD

**Figure 6–36. Shadow Web Interface SQL Source**

Use the vertical and horizontal scrollbars to navigate this screen.



# CHAPTER 7: **Shadow Mainframe Adapter Server: Data Mapping Facility (DMF)**

---

---

This chapter covers the Shadow Data Mapping Facility (DMF), an optional component of Shadow Mainframe Adapter Server, the Mainframe Adapter Server component of the Shadow product.

Topics include:

- Overview
  - How it Works
  - Restrictions
  - Recommendations
- Specifying an ISPF Library or Dataset
  - ISPF Libraries
  - Other Partitioned Datasets
  - Packed Datasets
  - The Shadow Mainframe Adapter Server Mapping Library
- Using the Data Mapping Checklist
- Data Mapping Options
  - Setting Up a Map Default
  - Performing a Map Extract
  - Displaying a Map
  - Copying a Map
  - Refreshing a Map
  - Generating an RPC
  - Merging Maps
  - Generating a Stored Procedure from Maps
  - Generating HTML from Maps
- Using Data Maps in Mainframe Adapter Client Programs

## **Overview**

The Shadow DMF presents a logical view of a data source. A data source can be anything from a COBOL copy book or a CICS transaction COMMAREA to ADABAS file and field definitions. One or more data maps are created for each application program with which Shadow DMF will be used. A data map contains a relational view of the data definitions (for example, COBOL copy books) in the source code. The Shadow DMF contains a map creation facility that automatically reads the data definitions and presents them for modification by the Shadow Mainframe Adapter Server administrator.

Once created, a data map is called “on the fly” using a parameter passed with the Shadow CALL statement. The data map controls the parsing and formatting of the

result set, including the names assigned to columns. By calling different maps, Shadow DMF can return different views or subsets of z/OS data.

The Shadow DMF includes administrative features such as a data map library, the capability to enable and disable individual data maps, and a map refresh feature.

For data sources that will be accessed via a customer-written CALL-based RPC instead of one of the Shadow Interfaces for IMS/TM, IMS/DB, CICS/TS, or VSAM, you can use a DMF map to generate a skeleton RPC written in COBOL. The skeleton contains the row-parsing code. You can add application logic to the skeleton to produce the final RPC.

## ***How it Works***

Data maps are created via a series of ISPF panels that allow the user to specify a dataset containing a compile listing of a program that contains a data definition. A data definition in COBOL is a file definition or data definition; for PLI, it is a DCL statement.

The information (length, format, type, offset, etc.) about each field element is extracted from the data definition and then made available to Shadow Mainframe Adapter Server .

Mainframe Adapter Clients of Shadow Mainframe Adapter Server can use the data maps to manipulate or view the logical or physical data.

## ***Restrictions***

Certain restrictions apply to the Shadow DMF, including non-supported clauses and column extract limits.

### **Non-Supported Clauses**

Data Mapping does not support OCCURS clauses that contain the DEPENDING ON clause.

Whenever the OCCURS clause is used, it appends a numeric suffix to the corresponding column. For example, if you extracted the following on FIELD-A:

```
05    FIELD-A occurs 3 times
```

You would see the following column names:

```
FIELD-A-1  
FIELD-A-2  
FIELD-A-3
```

### **Column Extraction**

The Data Mapping Facility allows up to 2,000 columns to be extracted; however, the Shadow Mainframe Adapter Client only allows up to 1,000 columns to be sent

or received. As a result, columns will need to be disabled in order to reduce the number to within the 1,000 column limit.

### Recommendations

- Use one Mainframe Adapter Server as a “test” Mainframe Adapter Server and a second Mainframe Adapter Server as a “production” Mainframe Adapter Server.
- Use the DD statement SDBMAPP as part of initial setup to identify the datasets that contain the maps for your production Mainframe Adapter Server.
- For each Mainframe Adapter Server, allocate one or more datasets, as needed. To facilitate central control of the production map data set, allocate a “staging” dataset for interim maps.

## Specifying an ISPF Library or Dataset

Within the Data Mapping Facility, there are several panels that require you to specify an ISPF library or dataset name. The information required is very similar from panel to panel and will be detailed in this section for your reference.

### ISPF Libraries

An ISPF library is a cataloged partitioned dataset with a three-level dataset name in the following format:

```
project.group.type
```

To specify an ISPF library, type the library name in the following ISPF fields shown in Figure 7-1.

Listing Library:	Map Library:
Project . . . _____	Project . . . _____
Group . . . . _____	Group . . . . _____
Type . . . . _____	Type . . . . _____
Member . . . _____	Member . . . _____

Figure 7-1. Listing and Map Libraries

**Note:**  
 For convenience, any cataloged data set (partitioned or sequential) with a three-level name can be entered in this fashion under edit, view, or the utilities, even if it is not an ISPF library.

In edit, view, or the utilities (move/copy, foreground, batch, and library), you can concatenate up to four ISPF libraries with the same project and type, as shown in the following examples:

## Example 1

ISPF library:

```
Project . . . payroll
Group . . . smith . . . develop . . . master . . .
Type . . . pli
Member . . . print* (Blank/pattern for member selection list)
```

In this example, the search for all members beginning with “PRINT” would proceed through the following libraries:

- PAYROLL.SMITH.PLI
- PAYROLL.DEVELOP.PLI
- PAYROLL.MASTER.PLI

After a member is selected and edited, the member list is displayed and the edited member is saved in the first library, in this case PAYROLL.SMITH.PLI. As a result, previously developed members become available for you to update in your own library.

## Example 2

ISPF library:

```
Project . . . payroll
Group . . . smith . . . develop . . . master . . .
Type . . . pli
Member . . . print2 (Blank/pattern for member selection list)
```

In this example, the search would only look for one member, “PRINT2”, through the same libraries:

- PAYROLL.SMITH.PLI
- PAYROLL.DEVELOP.PLI
- PAYROLL.MASTER.PLI

## Other Partitioned Datasets

When you want to specify a dataset that is not an ISPF library, type the name under one of the panel headings shown in Figure 7–2 or Figure 7–3.

<p>Other Partitioned Dataset Containing Maps:  Data Set Name. . . _____</p>
---

**Figure 7–2. Specifying a Partitioned Dataset Containing Maps**

```
Other Partitioned Dataset Containing Listing:
Data Set Name. . . _____
```

**Figure 7–3. Specifying a Partitioned Dataset Containing Listing**

You can enter any fully qualified dataset name by enclosing it in single quotes, as in the following example:

```
Data Set Name. . . 'sys1.maclib'
```

If you enter the dataset name, keep the following items in mind:

- If you omit the single quotes, your TSO prefix is left-appended to the dataset name. If you omit the trailing single quote, one will be assumed.
- If you enter an “other” dataset name, you can optionally specify a volume serial. The system catalog is not used when a volume serial is specified.
- Whenever an “other” dataset name is entered, it is used even if an ISPF library is also entered.
- A member name or pattern enclosed in parentheses may follow the dataset name (within the single quotes, if present) for partitioned datasets, as in the following example:

```
Data Set Name. . . 'sys1.maclib(sys*)'
```

Using the move/copy and reset utilities, you can enter a pattern of “\*” to specify all members are to be processed, as follows:

```
Data Set Name. . . 'sys1.maclib(*)'
```



**Note:**

The only way to display a member selection list when using member parts list (option 4.12 or 5.12) is to leave the member name field blank.

- You can reference generation datasets by using a signed or unsigned number in place of a member name. Minus numbers reference previously allocated datasets and positive numbers reference unallocated datasets of the group. You can specify a generation dataset only under an “other” dataset name. The following example references the most recently allocated dataset in the generation data group:

```
Data Set Name. . . 'gds.test(0)'
```

- You can specify a VSAM dataset on any panel with the following prompt:

Other Partitioned, Sequential or VSAM Data Set:

If you request a VSAM dataset from browse, edit, or view, a processor is selected based on configuration table settings.



**Note:**

Partitioned datasets with record format FBS or VBS are not supported.

## ***Packed Datasets***

The “packed” data format was developed to allow more efficient use of direct access data storage devices. In this format, data is stored in a way that replaces any repeating characters with a sequence indicating how many times the character is repeated. In order for data stored in this format to be properly used as input to processing programs such as compilers, the data must first be unpacked and expanded.

ISPF supports packed data format for both storage and retrieval. In general, there are two requirements for the ISPF user of packed datasets:

- When it is desired that ISPF Edit (option 2) store data in packed form, the user must ensure that the active edit profile includes “PACK ON”.
- When using packed format datasets as input to the foreground or batch processing programs, this fact must be communicated to ISPF via the SOURCE DATA PACKED field on the batch or foreground selection panels. This is a requirement if any portion of the input data, including that referenced in COPY or INCLUDE statements, is stored in packed form.

## ***The Shadow Mainframe Adapter Server Mapping Library***

The Shadow Mainframe Adapter Server mapping library is assigned to ddname SDBMAPP in the started task JCL. If you are executing Shadow Mainframe Adapter Server in debug mode, the DD can be allocated to TSO prior to starting the Mainframe Adapter Server.

## **Using the Data Mapping Checklist**

1. Identify the dataset that contains the compiler listings.
2. Allocate a map dataset.
3. From the **Shadow Mainframe Adapter Server Primary Option Menu**, select Option 10, Data Mapping.



4. Press ENTER. The system displays the **Shadow Mainframe Adapter Server Mapping Facility** options menu.
5. From this menu, you can do the following:
  - Use Option 0, Map Default, to create the default settings for the library that will contain user defined data maps.
  - Use Option 1, Map Extract, to create the data map from compiler listings.
  - Use Option 5, Map Refresh, to load the newly created map into the Mainframe Adapter Server.
  - Use Option 2, Map Display, to verify that the map extraction completed correctly.
  - Use Option 4, Map Copy; Option 6, Gen RPC; or Option 7, Map Merge, as needed.
6. Use the **END** command to return to the **Shadow Mainframe Adapter Server Primary Option Menu**.

## Data Mapping Options

From the **Shadow Mainframe Adapter Server Primary Option Menu**, select Option 10, Data Mapping to access the main **Shadow Mainframe Adapter Server Mapping Facility** options panel shown in Figure 7–4.

```

----- Shadow Mainframe Adapter Server Mapping Facility -----
-- Subsystem SDBB
OPTION  ====>

  0  Map Defaults           - Set Mapping defaults
  1  Map Extract           - Extract Maps
  2  Map Display           - Display Maps
  4  Map Copy              - Copy Shadow Maps
  5  Map Refresh           - Refresh Shadow Maps
  6  Gen RPC               - Generate RPC from Maps
  7  Map Merge             - Merge Shadow Maps
  8  Stored Procedure      - Generate a Stored Procedure from Maps
  9  HTML Generation       - Generate HTML from Maps

```

**Figure 7–4. Shadow Mainframe Adapter Server Mapping Facility Panel**

## Setting Up a Map Default

To set the mapping defaults, do the following

1. From the **Shadow Mainframe Adapter Server Mapping Facility** options menu (Figure 7–4), select Option 0, Map Defaults.
2. Press ENTER. The system displays the **Shadow Mainframe Adapter Server Default Map Options** panel shown in Figure 7–5.

```

----- Shadow Mainframe Adapter Server Default Map Options
-----
COMMAND ===> _____

Map Library:
  Project . . . _____
  Group . . . . _____
  Type . . . . _____

Other Partitioned data set Containing Maps:
  Data Set Name. . . _____

NOTE: The Map Library should be allocated as a PDS with a record size
      of at least 1024 bytes

Auto Refresh. . . . . N (Y or N)

```

**Figure 7–5. Shadow Mainframe Adapter Server Default Map Options**

3. Specify the default setting of the library that will contain user defined data maps. This library must meet the following requirements:
  - Be previously allocated as a partitioned organized (PO) dataset.
  - Have a logical record length (LRECL) of at least 1024 bytes. Other information, such as size and number of directory blocks, is usage dependent.
4. If you want the data map to refresh when you exit, in the **Auto Refresh** field, type Y. This option eliminates the need to manually select the Map Refresh option.



**Note:**

The Auto Refresh can incur significant overhead if you have several changes to make and you exit after each change. It is better to either make all changes before exiting or turn off Auto Refresh and use the Map Refresh option when finished.

5. Press ENTER. The message “Profile Saved” appears, indicating that the data set name is saved in the ISPF user profile pool for Shadow Mainframe Adapter Server.

## Performing a Map Extract

1. From the **Shadow Mainframe Adapter Server Mapping Facility** options menu (Figure 7-4), select Option 1, Map Extract.
2. Press ENTER. The system displays the **Shadow Mainframe Adapter Server Mapping Facility** extraction options shown in Figure 7-6.

```

----- Shadow Mainframe Adapter Server Mapping Facility -----
-- Subsystem SDBB
OPTION  ===>

  1  Extract COBOL      - Extract from COBOL listing
  2  Extract PL/I      - Extract from PL/I listing
  5  Extract MFS       - Extract from MFS source
  8  Extract VSAM      - Extract a VSAM definition
  9  Extract Seq       - Extract a Sequential file definition

```

**Figure 7-6. Shadow Mainframe Adapter Server Mapping Facility Extraction Options**

3. Select the program that is applicable. The following listing requirements must apply:
  - **Option 1, Extract COBOL:** The COBOL program must have been compiled using the compiler options XREF(FULL) and MAP.
  - **Option 2, Extract PL/I:** The PL/I program must have been compiled using the compiler options XREF(FULL), MAP, AGGREGATE, and ATTRIBUTES(FULL).
  - **Option 5, Extract MFS:** Extracts are done from the MFS source; it is not compiled.
  - **Option 8, Extract VSAM:** The VSAM program must have been extracted using the COBOL or PL/I listing requirements.
  - **Option 9, Extract Seq:** The sequential file definition must be extracted using the COBOL or PL/I listing requirements
  - **Option 10, Extract Catalog:** No requirements.

The system will display a panel similar to the one shown in Figure 7-7, which shows the panel specific to Option 1, Extract COBOL.

```

----- Shadow Mainframe Adapter Server Map Extract for COBOL
-----
COMMAND ==>> _____

Listing Library:                Map Library:
Project . . . _____        Project . . . _____
Group . . . . _____        Group . . . . _____
Type . . . . _____         Type . . . . _____
Member . . . _____         Member . . . _____

Other Partitioned Data Set Containing Listing:
Data Set Name. . . _____

Other Partitioned Data Set to Contain Map:
Data Set Name. . . _____

Listing Search Criteria: (case sensitive, O=optional R=Required)
Start Search Field (R). _____
End Search Field (O). . _____

```

**Figure 7–7. Map Extract for COBOL**

4. Specify the following information:

- **Listing Library:** Specify the information for the listing dataset, including the **Project**, **Group**, **Type**, and **Member** information. Alternatively, you can use the **Other Partitioned Data Set to Contain Listings** field to specify another dataset for the listing dataset.



**Note:**

The Map Extract requires a listing dataset as input.

- **Map Library:** Specify the information for the map library, including the **Project**, **Group**, **Type**, and **Member** information. Alternatively, you can use the **Other Partitioned Data Set to Contain Map** field to specify another dataset for the map library.



**Note:**

The output from the extract is a data mapping definition that will be placed into the named **Map Library**. The map library member name will be the name associated for this map by Shadow Mainframe Adapter Server .

5. Under **Listing Search Criteria**, specify the **Start Search Field**.

This is used to search the listing dataset for the starting point of the language dependent data declaration. The search criteria must be unique enough to find

the specific declaration to be mapped. For best results, use the full qualified name of the declaration as it appears in the listing.

6. **(Optional)** Under the **Listing Search Criteria**, specify the **End Search Field**.

If this field is left blank, extraction starts with the level number of the line found and continues until an equal or higher level is processed. If the field is not blank, extraction continues until the ending search string is found in the listing.

7. Under the **Listing Search Criteria**, specify the **Offset Zero** parameter.

This indicates whether to set the **Start Search Field** offset to zero, even if it is not a group level or the first definition in a group.

8. Press ENTER. If the extract completes with no errors, a “Extract Successful” message will appear in the upper right hand corner of the panel. At this point, both the map library and Shadow Mainframe Adapter Server contain the mapped structure definition.

## Displaying a Map

To display a map, do the following:

1. From the **Shadow Mainframe Adapter Server Mapping Facility** options menu (Figure 7–4), select Option 2, Map Display.
2. Press ENTER. The system displays the **Shadow Mainframe Adapter Server Data Mapping Block** panel shown in Figure 7–8.

```

----- Shadow Mainframe Adapter Server Data Mapping Block -----
SCR 1 ROW 1 OF 82
COMMAND ===>                                SCROLL ===> PAGE
Line Commands:  P Print Map  S Show Map  D Disable  E Enable
                  K Delete    X Display

STRUCTURE                                -MODIFICATION-
NAME      TYPE    STATUS    LANGUAGE    DATE      TIME    USERID    NOTE
A7500060          Enabled  ADABAS    01/02/13  12:28    AI38PHV
DEV00245          Enabled  ADABAS    01/02/06  09:42    AI38PV
DFH$AXCS          Enabled  COBOL     00/12/19  11:40    AI38PHV
DFSDF2   Screen  Enabled  MFS        00/03/30  12:44    AI38SJT
DFS DSP01 Output Enabled  MFS        00/03/30  12:44    AI38SJT
DFS MI1   Input  Enabled  MFS        00/03/30  12:44    AI38SJT
EMPLOYEE          Enabled  ADABAS    01/02/01  16:47
ESOTLDR           Enabled  VSAM      01/02/08  17:12    AI38WM
EXCIMAP           Enabled  Editor    98/03/24  15:49    AI38GW1
EXCIPROC          Enabled  Sto Proc  01/03/28  13:28    AI38WM
FFO00020          Enabled  COBOL     01/04/04  08:15    AI38WM
FFO05001          Enabled  COBOL     00/04/27  10:55    AI38WM

```

**Figure 7–8. Data Mapping Block, Panel 1**

Figure 7–8 shows the first of two panels for displaying existing data maps. Use the **LEFT** and **RIGHT** scroll commands (or PF keys) to shift between them. Use the listed line commands on map data set members to perform the following functions:

- Print map
- Show map
- Disable
- Enable
- Delete
- Display

You can view the following information on the two **Shadow Mainframe Adapter Server Data Mapping Block** panels:

- **Structure Name:** The member names within the map dataset.
- **Type:** One of the following types of structure:
  - ADABAS
  - Input
  - Output
  - Screen
  - LPTBL
  - Header
  - USER
- **Language:** Determined at the time of the extract. The extracted map is independent of language type.
- **Modification Date and Time:** Used only for informational purposes.
- **Userid:** Used only for informational purposes.
- **Creation Dataset:** Used to create the extracted data map. The extractor's user identification is displayed for informational purposes.

## Viewing the Individual Data Elements

To view individual data elements, do the following:

1. From the **Shadow Mainframe Adapter Server Data Mapping Block** panel (Figure 7–8), type the **X** command to the left of any structure name for which you want to view individual data elements.
2. Press ENTER. The system displays the **Shadow Mainframe Adapter Server Data Mapping Elements** panel for the selected member, similar to the one shown in Figure 7–9.

```

-- Shadow Mainframe Adapter Server Data Mapping Elements for A7500060 --
SCR 1 ROW 1 OF 321
COMMAND ==>                                SCROLL ==> PAGE
Line Commands:  P Print Map  S Show Map  D Disable  E Enable
                  C Change

FIELD           COLUMN
NAME            NAME            NOTE
CUSTOMER_NUMBER  CUSTOMER_NUMBER
F060_CUSTOMER_NUMBER  F060_CUSTOMER_NUMBER
LAST_CHANGE_DATE  LAST_CHANGE_DATE
ASSOCIATION_CODE  ASSOCIATION_CODE
CUSTOMER_NAME     CUSTOMER_NAME
MAILING_ADDRESS_LINE1  MAILING_ADDRESS_LINE1
MAILING_ADDRESS_LINE2  MAILING_ADDRESS_LINE2
CITY_NAME        CITY_NAME
STATE            STATE
ZIP_CODE         ZIP_CODE
ASSOC_MEMBERSHIP_NUMB  ASSOC_MEMBERSHIP_NUMBER
OFFICE_TELEPHONE  OFFICE_TELEPHONE
HOME_TELEPHONE   HOME_TELEPHONE
AR_GROUP_C       AR_GROUP_C
AGING_AR_ENTRY   AGING_AR_ENTRY01
AGING_AR_ENTRY   AGING_AR_ENTRY02
AGING_AR_ENTRY   AGING_AR_ENTRY03
POI_FLAG         POI_FLAG
HOLD_ACTIVITY_FLAG  HOLD_ACTIVITY_FLAG
TEMPORARY_ADDRESS_C  TEMPORARY_ADDRESS_C
TEMPORARY_ADDRESS  TEMPORARY_ADDRESS001
TEMPORARY_ADDRESS  TEMPORARY_ADDRESS002
TEMPORARY_ADDRESS  TEMPORARY_ADDRESS003

```

**Figure 7–9. Data Mapping Elements**

Figure 7–9 shows an example of the first of six panels for viewing the individual data elements. Use the **LEFT** and **RIGHT** scroll commands (or PF keys) to shift between them. Use the listed line commands on member fields to perform the following functions:

- Print map
- Show map
- Disable
- Enable
- Change

You can view the following information on the six **Shadow Mainframe Adapter Server Data Mapping Elements** panels:

- **Field Name:** The name of the field.
- **Column Name:** The name of the column heading. During Map Extract, column names were created using the field names and translating any dash

characters to underscores. The Map Editor can be used to make column names more meaningful for users.

- **Level:** The level in relation to other elements. This is maintained for informational purposes only.
- **Length:** The length of the data element. This is of primary importance in the map element.
- **Format:** The format of the data element. This is of primary importance in the map element. Various valid format types are as follows:
  - Character
  - Binary
  - Date
  - Time
  - Packed
  - Decimal
  - Group
- **Offset:** An offset is maintained as the relative position 0 (zero) displacement from the beginning of the structure. This is of primary importance in the map element.
- **Status:** The status of the field element, which is one of the following:
  - Enabled
  - Disabled
- **Precision:** The element precision.
- **Scale:** The element scale.
- **Linked Structure:** The related structure name.
- **Linked Column:** The related structure column name.
- **Fill Char:** The default fill character.
- **Fill Data:** The default fill data.
- **Original Statement:** The originating statement from which the elements were extracted. For items that were entered via the editor, these will not be available.

## ***Copying a Map***

The Map Copy function allows data maps to be copied to a map library. To copy a map to the map library, do the following:



1. From the **Shadow Mainframe Adapter Server Mapping Facility** options menu (Figure 7–4), select Option 4, Map Copy.
2. Press ENTER. The system displays the **Move/Copy Utility** panel shown in Figure 7–10.

```

                                Move/Copy Utility
Option ==>

C  Copy data set or member(s)      CP Copy and print
M  Move data set or member(s)      MP Move and print
L  Copy and LMF lock member(s)     LP Copy, LMF lock, and print
P  LMF Promote data set or member(s) PP LMF Promote and print

Specify "From" Data Set below, then press Enter key

From ISPF Library:
Project . . . _____ (--- Options C, CP, L, and LP only ---)
Group . . . _____ . . . _____ . . . _____ . . .
Type . . . _____
Member . . . _____ (Blank or pattern for member list,
                        "*" for all members)

From Other Partitioned or Sequential Data Set:
Data Set Name . . . _____
Volume Serial . . . _____ (If not cataloged)

Data Set Password . . _____ (If password protected)

```

**Figure 7–10. Move/Copy Utility**

3. To perform a move or copy operation, type one of the following commands in the **Option** field:
  - **C** to copy
  - **CP** to copy and print
  - **M** to move
  - **MP** to move and print
  - **L** to copy and LMF lock
  - **LP** to copy, LMF lock, and print
  - **P** to LMF promote
  - **PP** to LMF promote and print
4. In the **From ISPF Library** fields, specify the information for the dataset, including the **Project**, **Group**, and **Type** information. If the dataset is partitioned, specify a member name in the **Member** field as follows:
  - To move, copy, or promote a single member, type the member name.
  - To move, copy, or promote all members, type an asterisk (“\*”).
  - To request a member selection list, leave the member name blank or specify a pattern.

Alternatively, for any other partitioned or sequential datasets, you can specify the **From Other Partitioned or Sequential Data Set** fields. Type the **Data Set Name** and **Volume Serial** (volume serial number).

5. If password protected, type the **Data Set Password**.



**Note:**

If you forget to enter a password for a dataset that requires one, or if you enter the password incorrectly, the system will prompt you in standard TSO (line) mode. On TSO/TCAM systems, it may be necessary to press the CLEAR key before responding to the password prompt. If you enter the password incorrectly or encounter any other problems, you may be prompted again to enter the password until you reach a system limit of attempts.

6. Press ENTER.

## Refreshing a Map

To refresh the data maps, from the **Shadow Mainframe Adapter Server Mapping Facility** options menu (Figure 7-4), select Option 5, Refresh Map. There is no ISPF panel for the Refresh Map option. When you select this option, the Data Mapping Facility checks the library for modifications, and then refreshes Shadow Mainframe Adapter Server in core map tables from the library. The “Refresh Successful” message appears on the **Shadow Mainframe Adapter Server Mapping Facility** options menu if the refresh is completed with no errors.

## Generating an RPC

The Gen RPC function generates RPC programs from an extracted data map by generating the SQLBINDCOL statements into a new PDS member. It does this by using the skeleton program provided in the same PDS. The skeleton program contains all the language and application specific code required to perform the RPC task. Within the skeleton are keywords that are needed to substitute information and write the new specified member.

To generate RPC programs, do the following:

1. From the **Shadow Mainframe Adapter Server Mapping Facility** options menu (Figure 7-4), select Option 6, Gen RPC.
2. Press ENTER. The system displays the **Shadow Mainframe Adapter Server RPC Generation Facility** panel shown in Figure 7-11.

```

----- Shadow Mainframe Adapter Server RPC Generation Facility
-----
Command ===> _____

Map Library:          RPC Library:          Skeleton Library:
Project . _____ Project . _____ Project . _____
Group . . _____ Group . . _____ Group . . _____
Type . . _____ Type . . _____ Type . . _____
Member . _____ Member . _____ Member . _____

Other Partitioned data set Containing Map:
Data Set Name. . . _____

Other Partitioned data set to Contain RPC:
Data Set Name. . . _____

Other Partitioned data set Containing Source Skeleton:
Skeleton. . . . . _____

```

**Figure 7–11. RPC Generation Facility**

3. For the **Map Library**, **RPC Library**, and **Skeleton Library**, specify the dataset information.
4. Press ENTER to generate.

## The Skeleton Program

### Example Program

The following is an example of a skeleton COBOL program:

```

CBL APOST
010010 IDENTIFICATION DIVISION.
010020 PROGRAM-ID. DFSSAM02.
010080 ENVIRONMENT DIVISION.
010090 CONFIGURATION SECTION.
010100 SOURCE-COMPUTER. IBM-370.
010110 OBJECT-COMPUTER. IBM-370.
010120 DATA DIVISION.
010130 WORKING-STORAGE SECTION.
      COPY SBCPHD.
      77 SDF-RETURN-CODE PIC S9(05) VALUE 0.
      77 STATEMENT-HANDLE USAGE IS POINTER .
      77 SQL-PRECISION PIC S9(5) COMP VALUE 0.
      77 SQL-SCALE PIC S9(5) COMP VALUE 0.
      77 SQL-COLUMN-LEN PIC S9(5) COMP VALUE 1.
      77 SQL-COLUMN-NAME-LEN PIC S9(5) COMP.
      77 SQL-COLUMN-NUMBER PIC S9(5) COMP.
      77 SQL-COLUMN-NAME PIC X(30).
      77 ERROR-MESSAGE-AREA PIC X(256) VALUE IS SPACES.

```

```

77 TRACE-MESSAGE-AREA      PIC X(256) VALUE IS SPACES.
77 STRING-PTR              PIC S9(5) COMP VALUE IS 1.
77 CONNECTION-HANDLE      USAGE IS POINTER.
77 ENVIRONMENT-HANDLE     USAGE IS POINTER.
77 ERROR-MSG-LENGTH-AREA  PIC S9(5) COMP VALUE 0.
77 NATIVE-ERROR-CODE-AREA PIC S9(5) COMP VALUE 0.
77 SQLSTATE-DATA-AREA     PIC X(6) VALUE IS SPACES.
@DATABUFFER
060110 LINKAGE SECTION.
080010 PROCEDURE DIVISION.
080020 INIT.
    @SQLBINDCOL BEGIN
    MOVE @LENGTH TO SQL-COLUMN-LEN.
    MOVE @COLUMN_NAME_LENGTH TO SQL-COLUMN-NAME-LEN.
    MOVE @COLUMN_NAME TO SQL-COLUMN-NAME.
    MOVE @SEQ TO SQL-COLUMN-NUMBER.
    MOVE @PRECISION TO SQL-PRECISION.
    MOVE @SCALE TO SQL-SCALE.
    CALL 'SDCPBC' USING STATEMENT-HANDLE
        SQL-COLUMN-NUMBER
        SQL-C-DEFAULT
        SQL-SMALLINT
        SQL-PRECISION
        SQL-SCALE
        SQL-NO-NULLS
        @FIELD_NAME
        SQL-COLUMN-LEN
        SQL-COLUMN-NAME
        SQL-COLUMN-NAME-LEN.
    MOVE RETURN-CODE TO SDF-RETURN-CODE.
    IF SQL-INVALID-HANDLE OR SQL-ERROR OR SQL-NO-DATA-FOUND
        PERFORM 0000-ERROR-ROUTINE
    END-IF.
    @SQLBINDCOL END
    CALL 'SDCPH' USING STATEMENT-HANDLE SQL-THROW-DONE.
    MOVE RETURN-CODE TO SDF-RETURN-CODE.
    IF SQL-INVALID-HANDLE OR SQL-ERROR OR SQL-NO-DATA-FOUND
        PERFORM 0000-ERROR-ROUTINE THRU 0000-ERROR-EXIT
    END-IF.
080140 EXIT-RTN.
080160     GOBACK.
    0000-ERROR-ROUTINE.
    MOVE 256 TO SQL-PRECISION.
    IF SQL-INVALID-HANDLE GO TO 0000-ERROR-EXIT.
*****
*IF AN ERROR OCCURS CALL THE SQLEERROR ROUTINE
*****
    CALL 'SDCPSE' USING ENVIRONMENT-HANDLE CONNECTION-HANDLE
        STATEMENT-HANDLE SQLSTATE-DATA-AREA
        NATIVE-ERROR-CODE-AREA
        ERROR-MESSAGE-AREA
        SQL-COLUMN-LEN ERROR-MSG-LENGTH-AREA.
    MOVE RETURN-CODE TO WS-ODBCAPI-RETURN-CODE.
    IF SQL-SUCCESS OR SQL-SUCCESS-WITH-INFO

```

```

PERFORM 0000-ERROR-DISPLAY-ROUTINE THRU
0000-ERROR-DISPLAY-EXIT.
0000-ERROR-EXIT.
0000-ERROR-DISPLAY-ROUTINE.
*****
*   SEND THE ERROR MESSAGE TO THE CLEINT USING SQLRETURNSTATUS
*****
STRING 'HOST ERROR MESSAGE - ' ERROR-MESSAGE-AREA
DELIMITED BY SIZE INTO TRACE-MESSAGE-AREA WITH
POINTER STRING-PTR
END-STRING.
CALL 'SDCPRS' USING CONNECTION-HANDLE TRACE-MESSAGE-AREA
SQL-NTS NATIVE-ERROR-CODE-AREA.
0000-ERROR-DISPLAY-EXIT.

```

### *Program Explanation*

- The following statement will cause the facility to substitute the originally extracted statements into the program at the location where the statement is found:

```
@DATABUFFER
```

- The following statements declare the beginning and ending of the SQLBINDCOL substitution. All of the statements between the begin and end are replicated for the number of ENABLED fields in the map data.

```
@SQLBINDCOL BEGIN
```

```
@SQLBINDCOL END
```

- The following keywords may be contained between the SQLBINDCOL BEGIN and SQLBINDCOL END statements. These keywords are substituted with the proper values for each ENABLED field in the data map.

@LENGTH - the length of the field element

@COLUMN\_NAME\_LENGTH - the length of the column name.

@COLUMN\_NAME - the column name used to identify the field

@TYPE - SQL data type of column data. All DB2 SQL data types are supported except for graphic (DBCS) data.

@SEQ - a sequentially assigned number for this column

@PRECISION - the precision of the field

@SCALE - the scale of the field

@FIELD\_NAME - the field name itself as defined in the

@DATABUFFER -

## Program Considerations

It should be noted that the skeleton may contain as many or as few statements as desired. It does not necessarily have to be a complete program and all keywords need not be used.

For example, a skeleton member containing only the following statements would generate a list of ENABLED field names as defined in the data map:

```
@SQLBINDCOL BEGIN
@FIELD_NAME
@SQLBINDCOL END
```

## Merging Maps

The Map Merge function allows a data map to be concatenated (merged) to a second data map, resulting in a third (output) data map. To merge maps, do the following:

1. From the **Shadow Mainframe Adapter Server Mapping Facility** options menu (Figure 7-4), select Option 7, Map Merge.
2. Press ENTER. The system displays the **Shadow Mainframe Adapter Server Map Merge Facility** panel shown in Figure 7-12.

```
----- Shadow Mainframe Adapter Server Map Merge Facility -----
-----
COMMAND ==> _____

From Map Library:
  Project . . . _____      Member 1. . . _____
  Group . . . . _____      Member 2. . . _____
  Type . . . . _____

OR
Other Partitioned data set Containing Maps:
  Data Set Name 1 . . _____
  Data Set Name 2 . . _____

To Map Library:
  Project . . . _____      Member . . . _____
  Group . . . . _____
  Type . . . . _____      Replace (Y or N) .__

OR
Other Partitioned data set To Contain Map:
  Data Set Name . . . _____
```

**Figure 7-12. Map Merge Facility**

**Note:**

The Map Merge function recalculates the offsets of any merged items from the **Member 2** field of the input map library and writes the contents of the **Member 1** and **Member 2** fields into the **Member** field specified in the **To Map Library** field.

3. Specify the following:
  - **From Map Library:** Specify the dataset names and member names for the files that will be merged, including the **Project**, **Group**, **Type**, and **Member** information. (In the **Member 1** and **Member 2** fields, type the two member names to be merged.) Alternatively, you can use the **Other Partitioned Data Set Containing Maps** field to specify other datasets for the files to be merged.
  - **To Map Library:** Specify information for the resulting merged map library, including the **Project**, **Group**, **Type**, and **Member** information. Alternatively, you can use the **Other Partitioned Data Set to Contain Map** field to specify another dataset for the resulting dataset.
4. Press ENTER to perform the map merge.

## Generating a Stored Procedure from Maps

To generate a stored procedure, do the following:

1. From the **Shadow Mainframe Adapter Server Mapping Facility** options menu (Figure 7–4), select Option 8, Stored Procedure.
2. Press ENTER. The system displays the **Shadow Mainframe Adapter Server Stored Procedure Generation** panel shown in Figure 7–13.

**Doc Reference:**

For more information about generating stored procedures, see the following:

- *Shadow Interface for CICS/TS User Documentation*
- *Shadow Interface for IMS/TM User Documentation*

```

----- Shadow Mainframe Adapter Server Stored Procedure Generation -----
--- Subsystem SDBB
COMMAND ===> _____

Map data set Library:
  Project . . . _____
  Group . . . . _____
  Type . . . . _____

Other Map data set Name:
  Data Set Name. . . _____

Source Data Maps:                               (members in Map data set Library)
  Input Map Name . . . _____
  Output Map Name. . . _____
Interface information:
  Interface Type . . . _                (I = IMS, C = CICS)
  DB2 Subsystem. . . . _____        CICS Transaction ID: _____
  DB2 Plan Name. . . . _____        CICS Program Name: _____
                                          CICS Connection Name: _____

Target names:
  Procedure Name . . . _____        (member name in map data set,required)
  Table Name . . . . . _____        (DB2 table name)

```

**Figure 7–13. Stored Procedure Generation**

## Generating HTML from Maps

To generate HTML from maps, do the following:

1. From the **Shadow Mainframe Adapter Server Mapping Facility** options menu (Figure 7–4), select Option 9, HTML Generation.
2. Press ENTER. The system displays the **Shadow Mainframe Adapter Server HTML Generation** panel shown in Figure 7–14.

```

----- Shadow Mainframe Adapter Server HTML Generation -----
-- Subsystem SDBB
OPTION ===>

1  CICS Auto-HTML          - Generate HTML from CICS Maps

```

**Figure 7–14. HTML Generation**

3. From this menu, you can do following:
  - Select Option 1, CICS Auto-HTML, if you want to generate HTML from CICS maps. The system displays the **Shadow Mainframe Adapter Server BMS HTML Profile Settings** panel shown in Figure 7–15.



```

----- Shadow Mainframe Adapter Server BMS HTML Profile Settings -----
-- Subsystem SDBB
COMMAND ==>

Press Enter to save your changes and continue, or press End to cancel your
changes and return to the prior menu.

More:      +

BMS Customization Orders data set:  *** Required ***
  Project . . . . . Used to hold Customization Orders and Mapset
  Group . . . . . Connections. Must be a PDS with 80-byte fixed
  Type . . . . . length records.
Other BMS Customization Orders data set:
  Data Set Name. . .

-----

BMS Customization Connections data set:  *** Required ***
  Project . . . . . Used to hold Customization Map Connections.
  Group . . . . . Must be a PDS with 80-byte fixed length records.
  Type . . . . .
Other BMS Customization Connections data set:
  Data Set Name. . .

-----

CICS/TS Macro data set:  *** Required ***
  Project . . . . . data set containing CICS/TS 1.3 macros. Must
  Group . . . . . be PDS with 80-byte fixed length records.
  Type . . . . .
Other CICS/TS Macro data set:
  Data Set Name. . .

-----

High-Level Assembler (ASMA90) Load Library  *** Required ***
  Project . . . . . Load Library containing the High-Level Assembler.
  Group . . . . .
  Type . . . . .
Other High-Level Assembler (ASMA90) Load Library
  Data Set Name. . .

-----

BMS Customization Orders Intermediate data set:  *** Optional ***
  Project . . . . . data set used by the HTML generation process.
Must
  Group . . . . . be a sequential data set with 80-byte fixed
length
  Type . . . . .
Other High-Level Assembler (ASMA90) Load Library
  Data Set Name. . .

-----

BMS Customization Orders Debug SYSPRINT data set:  *** Optional ***
  Project . . . . . data set used by the HTML generation process when
  Group . . . . . the Debug option is on. Must be a PDS with
  Type . . . . . 121-byte fixed length records and RECFM=FBA.
Other BMS Customization Orders Debug SYSPRINT data set:

```

**Figure 7–15. HTML from CICS Maps**

- Select Option 2, CICS non-BMS Auto-HTML, if you want to generate HTML for non-BMS CICS transactions. The system displays the **Shadow Mainframe Adapter Server 3270 Non-BMS HTML Profile Settings** panel shown in Figure 7–16.

```

----- Shadow Mainframe Adapter Server 3270 Non-BMS HTML Profile Settings -----
- Subsystem SDBB
COMMAND ==>>
More:      +
3270 Non-BMS Customization Orders data set:  *** Required ***
Project . . . . . Used to hold Customization Orders and Transid
Group . . . . . Connections. Must be a PDS with 80-byte fixed
Type . . . . . length records.
Other 3270 Non-BMS Customization Orders data set:
Data Set Name. . .

-----
3270 Non-BMS Customization Connections data set:  *** Required ***
Project . . . . . Used to hold Customization Map Connections.
Group . . . . . Must be a PDS with 80-byte fixed length records.
Type . . . . .
Other 3270 Non-BMS Customization Connections data set:
Data Set Name. . .

-----
CICS/TS Macro data set:  *** Required ***
Project . . . . . data set containing CICS/TS 1.3 macros. Must be a
Group . . . . . PDS with 80-byte fixed length records.
Type . . . . .
Other CICS/TS Macro data set:
Data Set Name. . .

-----
High-Level Assembler (ASMA90) Load Library  *** Required ***
Project . . . . . Load Library containing the High-Level Assembler.
Group . . . . .
Type . . . . .
Other High-Level Assembler (ASMA90) Load Library
Data Set Name. . .

-----
3270 Non-BMS Customization Orders Intermediate data set:  *** Optional ***
Project . . . . . data set used by the HTML generation process. Must
Group . . . . . be a sequential data set with 80-byte fixed length
Type . . . . . records and RECFM=F.
Other 3270 Non-BMS Customization Orders Debug Intermediate data set:
Data Set Name. . .

-----
3270 Non-BMS Customization Orders Debug SYSPRINT data set:  *** Optional ***
Project . . . . . data set used by the HTML generation process when
Group . . . . . the Debug option is on. Must be a PDS with 80-byte
Type . . . . . fixed length records.
Other 3270 Non-BMS Customization Orders Debug SYSPRINT data set:

```

**Figure 7–16. HTML for Non-BMS CICS Transactions**

# Using Data Maps in Mainframe Adapter Client Programs

The following are examples of the MAP parameter, used for CICS and IMS calls to Shadow Mainframe Adapter Server:

```
call shadow_cics('EXCI','EXCC','EXCI','DFH$AXCS',2,'FILEA ',' 1',' ',120,' ',
'MAP(NAME(EXCI) FIELDS(*))')
```

```
call shadow_ims('IMS','PART','IMSLU62','SAME','3007228','MAP(NAME(PART)
FIELDS(*) FORMAT(HORZ))')
```

```
call shadow_ims('IMS','PART','IMSLU62','SAME','*', 'MAP(NAME(PARTLIST) FIELDS(*)
FORMAT(VERT))')
```

Table 7–1 provides descriptions of the subparameters listed in the examples.

**Table 7–1. Description of Subparameters of MAP Parameter**

MAP Subparameters	Description
NAME	This entry should correspond to the name assigned to the map during extraction.
FIELDS	There are two ways to return data from all columns that are enabled in the map definition: <ul style="list-style-type: none"> <li>Use an asterisk after FIELDS (as shown).</li> <li>Leave out FIELDS altogether.</li> </ul> To exclude some columns, enter the names of the enabled columns you <i>do</i> want returned in the parentheses after FIELDS.
FORMAT	This entry determines whether output will be oriented vertically or horizontally. For IMS, use one of the following: <ul style="list-style-type: none"> <li>FORMAT(HORZ)</li> <li>FORMAT(VERT)</li> </ul> <i>Note:</i> For a CICS call, FORMAT is not valid.



# CHAPTER 8:

# **Shadow Mainframe Adapter Server: Managing System Resources**

---

---

This chapter covers the methods for streamlining the management of system resources, provided by Shadow Mainframe Adapter Server, the Mainframe Adapter Server component of the Shadow product.

Topics include:

- Shadow DVIPA Support
- Using 40K Block Fetch
  - Queries Eligible for Block Fetch
  - Enabling 40K Block Fetch
- Using CPU Time Limits
  - Setting a CPU Time Limit for Shadow Mainframe Adapter Clients
  - Setting a CPU Time Limit for All Mainframe Adapter Clients
- Using Wait Time for All Mainframe Adapter Clients
  - Enabling the External Wait Time Limit
  - Disabling the External Wait Time Limit Mechanism
- Detecting Session Failures
  - Enabling Session Failure Detection
- Setting the Dispatch Priority
  - Enabling Dispatch Priority
- Other System Resource Features

## **Shadow DVIPA Support**

Shadow Mainframe Adapter Server supports Dynamic Virtual IP Addressing (Dynamic VIPA, or DVIPA). This functionality provides a number of important benefits and can be activated by configuring your TCP/IP for DVIPA.

## **Using 40K Block Fetch**

Using block fetch allows performance of certain types of SQL queries by asynchronously preextracting rows (on the Mainframe Adapter Server node) ahead of the current row. The preextracted rows are then sent back to the requesting node in blocks containing multiple rows of data.

This technique provides two important benefits:

- By sending blocks of information, network traffic is minimized.
- Subsequent FETCHs on the requesting node can be satisfied by data that has already been moved to that node.

By default, blocks hold 40K bytes of data. This number is set in the Shadow Mainframe Adapter Server `NETWORKBUFFERSIZE` parameter. The number of blocks that will be used is determined by the Shadow Mainframe Adapter Server `PREFETCH` parameter. As soon as Shadow Mainframe Adapter Server is able to determine that a particular query is eligible for block fetch, it begins fetching rows into the prefetch buffers; however, no transmission of data actually takes place until the first (real) `FETCH` statement reaches the Mainframe Adapter Server.

**Note:**

The maximum number of bytes that is actually sent per transmission (per `VTAM SEND`) is limited to 32K, even though Shadow Mainframe Adapter Server's internal prefetch buffers are larger than this.

Block fetch allows queries that process large portions of tables to be handled much faster without materially affecting single row queries.

There is only one type of query in which performance can be adversely affected by block fetch—a query in which no `DESCRIBE` (or `PREPARE INTO`) is performed in advance of fetching rows. In this case, Shadow Mainframe Adapter Server must internally perform a `DESCRIBE` in order to determine the types of data that may be returned.

In addition, depending on the type of isolation level that is used, the following items must also be taken into account:

- If the plan is bound with the Repeatable Read (RR) option and block fetch is used, many more pages can be locked for update than without block fetch, especially if the number of rows normally extracted by the query is small.
- If the plan is bound with the Cursor Stability (CS) option and block fetch is used, data changes can take place between the time the data is extracted and the time that it is actually used by the application.

## ***Queries Eligible for Block Fetch***

Only “read-only” queries are eligible for block fetch. This type of query occurs in the following situations:

- The `SELECT` statement has a `FOR FETCH ONLY` clause.
- The `SELECT` statement has an `ORDER BY` clause.
- The `SELECT` statement's first `FROM` clause contains more than one table (or view).
- The `SELECT` statement has the `UNION` or `UNION ALL` operator.

- The SELECT statement has the DISTINCT keyword in the first SELECT clause.
- The SELECT statement has a column function in the first SELECT clause.
- The SELECT statement has a HAVING clause in the outside SELECT statement.
- The SELECT statement has a GROUP BY clause in the outside SELECT statement.
- The SELECT statement contains a subquery where the base object of the SELECT statement and the subquery is the same table.

## ***Enabling 40K Block Fetch***

To enable 40K block fetch, set the following Shadow Mainframe Adapter Server parameters either in the Shadow Mainframe Adapter Server SDBxIN00 initialization EXEC or dynamically by using the ISPF panels or the Shadow Web Interface:

```
"MODIFY PARM NAME(BLOCKFETCH) VALUE(YES) "  
"MODIFY PARM NAME(PREFETCH) VALUE(3 BLOCKS) "
```

## **Using CPU Time Limits**

The Shadow Mainframe Adapter Server provides internal CPU time limits. These time limits fall into the following two categories:

- An internal time limit for Shadow Mainframe Adapter Client .
- An external time limit for all Mainframe Adapter Clients.

## ***Setting a CPU Time Limit for Shadow Mainframe Adapter Clients***

Shadow Mainframe Adapter Server includes an internal CPU time limit mechanism. This mechanism limits the amount of CPU time any Shadow Mainframe Adapter Client can use before it is disconnected from the host. This will ensure that a remote Shadow Mainframe Adapter Client connection doesn't continue using CPU time even after the Mainframe Adapter Client becomes hung.



### **Note:**

The limit applies to every session and is reset every time a new session starts.

If a Shadow Mainframe Adapter Client connection exceeds the CPU time limit, Shadow Mainframe Adapter Server will cancel the connection, and then issue a message to the Mainframe Adapter Client and to the trace browse log.

The time limit mechanism is activated only after a unit of work is received from the Shadow Mainframe Adapter Client. It only monitors connections made to DB2.

**Note:**

The internal CPU time limit mechanism does *not* detect time out conditions and will *not* stop runaway queries.

## Enabling the Internal CPU Time Limit

To enable the internal CPU time limit mechanism, set the following parameters on the Shadow Mainframe Adapter Server:

```
"MODIFY PARM NAME(MINCPUTIME)          VALUE(XX)"  
"MODIFY PARM NAME(MAXCPUTIME)          VALUE(XX)"  
"MODIFY PARM NAME(DEFAULTCPUTIME)     VALUE(XX)"
```

Where:

**MINCPUTIME**

Specifies the minimum CPU time value. This value is in seconds and is set by default to 0 seconds (disabled).

**MAXCPUTIME**

Specifies the maximum CPU time value. This value is in seconds and is set by default to 0 seconds (disabled).

**DEFAULTCPUTIME**

Specifies the default CPU time value and is used if a value cannot be obtained from the security package.

## Determining the Internal CPU Time Limits

The time limit will be determined as follows:

1. The initial time limit value is obtained from the ACF2 Lid control block. If this value is not available, the mechanism will use the DEFAULTCPUTIME value as the initial limit.
2. The initial time limit value is compared to the MINCPUTIME value. If the initial limit is smaller than the MINCPUTIME, the minimum value is used.
3. The initial value is compared to the MAXCPUTIME value. If the initial value is larger than the maximum value, the maximum value is used.

After these calculations are done, the time limit mechanism uses the final value to constrain the resources consumed by any Mainframe Adapter Client thread.



## Examples

- Your installation's ACF2 Lid control block defines most people as having a time limit of 10 minutes (600 seconds). However, special users are provided a time limit of 40 minutes (2400 seconds).

To begin, if you want people who are not defined by the ACF2 Lid control block to have a time limit of 10 minutes, you should set the DEFAULTCPU TIME value to 600.

Then, if you want to ensure that no one ever receives less than three minutes (180 seconds) or more than one hour (3600 seconds), set the MINCPU TIME value to 180, and set the MAXCPU TIME value to 3600.

- Your installation's ACF2 Lid control block defines most people as having a time limit of 5 minutes (300 seconds). However, special users are provided a time limit of 90 minutes (5400 seconds).

If you want people who are not defined by the ACF2 Lid control block to have a time limit of 15 minutes, you should set the DEFAULTCPU TIME value to 900.

If the MINCPU TIME value is set to 600 seconds, all users will be allowed a time limit of at least 10 minutes, no matter what the ACF2 Lid control block states.

If the MAXCPU TIME value is set to 3600, those special users with a the extended time limit (90 minutes) will be restricted to one hour of activity.

## Disabling the Internal CPU Time Limit Mechanism

To disable the internal CPU time limit mechanism, set the MINCPU TIME and MAXCPU TIME parameters to zero.

## Setting a CPU Time Limit for All Mainframe Adapter Clients

Shadow Mainframe Adapter Server also includes an external CPU time limit mechanism. This mechanism limits the amount of CPU time *any* Mainframe Adapter Client can use before it is disconnected from the host, keeping a lid on runaway queries and other CPU loops.



### **Note:**

The limit applies to every session and is reset every time a new session starts.

This mechanism involves three distinct limits:

- **The Warning Limit.** When the *warning limit* is exceeded, the mechanism writes a warning message to hard copy describing the user that has exceeded the limit. The format of this message is as follows:

```
SDB4325H CPU TIME LIMIT EXCEEDED FOR userid FROM TCP/IP/LU 6.2
NODE name/IP address in dot notation PLAN plan name CNID
connect id TP program name
```

- **The Error Limit.** When the *error limit* is exceeded, the mechanism writes an error message to hard copy describing the user that has exceeded the limit. The format of this message is as follows:

```
SDB4326S CPU TIME LIMIT EXCEEDED FOR userid FROM TCP/IP/LU 6.2
NODE name/IP address in dot notation PLAN plan name CNID
connect id TP program name
```

- **The Failure Limit.** When the *failure limit* is exceeded, the application thread will be terminated with an X'522' abend.

**Note:**

The Mainframe Adapter Client will not receive a message describing why the connection was terminated; a TCP/IP I/O error will occur when the user tries to perform the next operation.

## Enabling the External CPU Time Limit

To enable the external CPU time limit mechanism, set the following parameters on the Shadow Mainframe Adapter Server:

```
"MODIFY PARM NAME(CHECKLIMITSINTERVAL)    VALUE( xx )"
"MODIFY PARM NAME(WARNINGCPUTIME)         VALUE( xx )"
"MODIFY PARM NAME(ERRORCPUTIME)          VALUE( xx )"
"MODIFY PARM NAME(FAILCPUTIME)           VALUE( xx )"
```

Where:

### CHECKLIMITSINTERVAL

Determines how often the external CPU time limit mechanism will check each task to determine whether it has exceeded any of the time limits. This value is in seconds and is set by default to 15 seconds. This value is used for both external wait and external CPU time limit checking.

### WARNINGCPUTIME

Determines the warning limit of the external CPU time limit mechanism. The value is in seconds and is set by default to 0 seconds (disabled).

**ERRORCPUTIME**

Determines the error limit of the external CPU time limit mechanism. The value is in seconds and is set by default to 0 seconds (disabled).

**FAILCPUTIME**

Determines the error limit of the external CPU time limit mechanism. The value is in seconds and is set by default to 0 seconds (disabled).

**Disabling the External CPU Time Limit Mechanism**

To disable any of the external CPU time limits, set the respective parameter (WARNINGCPUTIME, ERRORCPUTIME, or FAILCPUTIME) to zero.

## Using Wait Time for All Mainframe Adapter Clients

Shadow Mainframe Adapter Server includes an external wait time limit mechanism. This mechanism will limit the amount of time that a connection can remain inactive.

The external wait time limit mechanism involves three distinct limits:

- **The Warning Limit.** When the *warning limit* is exceeded, the mechanism writes a warning message to hardcopy describing the user that has exceeded the limit. The format of this message is as follows:

```
SDB4325H WAIT TIME LIMIT EXCEEDED FOR userid FROM TCP/IP/  
LU 6.2 NODE name/IP address in dot notation PLAN plan  
name CNID connect id TP program name
```

- **The Error Limit.** When the *error limit* is exceeded, the mechanism writes an error message to hardcopy describing the user that has exceeded the limit. The format of this message is as follows:

```
SDB4326S WAIT TIME LIMIT EXCEEDED FOR userid FROM TCP/IP/  
LU 6.2 NODE name/IP address in dot notation PLAN plan  
name CNID connect id TP program name
```

- **The Failure Limit.** When the *failure limit* is exceeded, the application thread will be terminated with an X'522' abend. A message will be sent to the Mainframe Adapter Client indicating that the connection was terminated.

 **Note:**

The Mainframe Adapter Client will not receive a message describing why the connection was terminated; a TCP/IP I/O error will occur when the user tries to perform the next operation.

## ***Enabling the External Wait Time Limit***

To enable the external wait time limit, set the following parameters on the Shadow Mainframe Adapter Server:

```
"MODIFY PARM NAME(CHECKLIMITSINTERVAL)    VALUE(XX)"  
"MODIFY PARM NAME(WARNINGWAITTIME)        VALUE(XX)"  
"MODIFY PARM NAME(ERRORWAITTIME)          VALUE(XX)"  
"MODIFY PARM NAME(FAILWAITTIME)           VALUE(XX)"
```

Where:

### **CHECKLIMITSINTERVAL**

Determines how often the external wait time limit mechanism will check each task to determine whether it has exceeded any of the time limits. This value is in seconds and is set by default to 15 seconds. This value is used for both external wait and external CPU time limit checking.

### **WARNINGWAITTIME**

Determines the warning limit of the external wait time limit mechanism. The value is in seconds and is set by default to 0 seconds (disabled)

### **ERRORWAITTIME**

Determines the error limit of the external wait time limit mechanism. The value is in seconds and is set by default to 0 seconds (disabled)

### **FAILWAITTIME**

Determines the failure limit of the external wait time limit mechanism. This value is in seconds and is set by default to 0 seconds (disabled).

## ***Disabling the External Wait Time Limit Mechanism***

To disable any of the external wait time limits, set the respective parameter (WARNINGWAITTIME, ERRORWAITTIME, or FAILWAITTIME) to zero.

## **Detecting Session Failures**

The Shadow Mainframe Adapter Server can also detect session failures while processing is active. This means that if a user submits a long running SQL statement or RPC and then kills the Mainframe Adapter Client application (or reboots the system), the Mainframe Adapter Server detects that the session is gone and kills the SQL/RPC as soon as the session failure is known to the host.

If the Mainframe Adapter Client application is terminated using task manager (or the UNIX equivalent), the host processing terminates within a few seconds. (The default is 15 seconds.) If the Mainframe Adapter Client system is rebooted or

some part of the network fails, the host does not know about the failure until the KEEPALIVE (TCP/IP parameter) timeout occurs. The KEEPALIVE timer is usually set to 20 minutes, but it can be higher or lower.

## ***Enabling Session Failure Detection***

To enable session failure detection, set the following parameters on the Shadow Mainframe Adapter Server:

```
"MODIFY PARM NAME(CHECKSESSIONS)          VALUE(YES)"
"MODIFY PARM NAME(SESSIONFAILTIME)        VALUE(XX)"
```

Where:

### **CHECKSESSIONS**

Controls whether or not any checking for session failures is done.

### **SESSIONFAILTIME**

Controls how long processing is allowed before we start to check if the session may have failed.

## **Setting the Dispatch Priority**

This feature is very useful for adjusting how Shadow Mainframe Adapter Server performs within the overall system.

## ***Enabling Dispatch Priority***

To enable dispatch priority, set the following parameter on the Shadow Mainframe Adapter Server:

```
"MODIFY PARM NAME(DISPATCH)                VALUE(254)"
```

Where:

### **DISPATCH**

Specifies the main address space dispatch priority. If this parameter is set to zero, the product will not attempt to set its dispatch priority.



### ***Doc Reference:***

For more information, see "Dispatching Priorities" in IBM's manual GC28-1149-4, *MVS/Extended Architecture System Programming Library: Initialization and Tuning*.

## Other System Resource Features

Shadow Mainframe Adapter Server has a number of other features that provide the unparalleled ability to maintain response times within pre-established services levels as numbers of users grow from a few to tens of thousands.

Shadow Mainframe Adapter Server optimizes the use of network resources through data compression and by minimizing the number of network round-trips. Other features include end-to-end multi-threaded capabilities that make the best use of all available hardware facilities for processing on the Mainframe Adapter Client and Mainframe Adapter Server components. In addition, Shadow Mainframe Adapter Server provides optimized network buffering to maximize the bandwidth available for Mainframe Adapter Client/Mainframe Adapter Server computing and a number of advanced connection and processing modes, such as dynamic thread pooling, that can be turned on as required to maximize the throughput of large workloads with minimal CPU consumption. These features, along with the 40K optimized block fetch (see “Using 40K Block Fetch” on page 8-1), provides the Shadow Mainframe Adapter Server with the highest performance in the industry today.

# CHAPTER 9: **Shadow Mainframe Adapter Server: Using Work Load Manager Support**

---

---

This chapter covers Work Load Manager (WLM) support, a feature provided by Shadow Mainframe Adapter Server, the Mainframe Adapter Server component of the Shadow product.

Topics include:

- Overview
  - Enclaves
- WLM Classification of Shadow Transactions
  - Step 1: Create or Select Service Class Definitions
  - Step 2: Create Shadow Mainframe Adapter Server Classification Rules
  - Step 3: Define Service Class Definitions for Shadow Subtasks
  - Step 4: Enable WLM Support within Shadow Mainframe Adapter Server
  - Step 5: Verify Proper WLM Classification
- Running in WLM Compat Mode



### **Doc Reference:**

For detailed information about planning for and using WLM, see *OS/390 V2R9.0 MVS Planning: Workload Management* and *OS/390 V2R9.0 MVS Workload Management Services*.

## Overview



### **Note:**

The WLM functions used by Shadow Mainframe Adapter Server are available only in ESA 5.2 and above.

Shadow's Work Load Manager (WLM) support provides a method for making the best use of the Mainframe Adapter Server's resources, while achieving the best possible response times. With WLM, you can define performance goals, and assign a level of importance to each goal in business terms. The system then matches its resources to the work, as well as determines whether or not the goals are being met by monitoring and adapting its processing.

Goals are specified for the WLM services within Shadow Mainframe Adapter Server in the same way they are specified for z/OS-managed work. This is done by associating incoming work with a service class. This informs the operating

system the performance goal and importance level associated with the work, as well as the address spaces involved in processing the work request.

WLM manages the Mainframe Adapter Server space as an entity, and has no awareness of individual transactions, thus eliminating the following problems:

- Varying response times for transactions of the same type as the Mainframe Adapter Server address space handles varying workloads.
- Controlling access to resources, or accounting for resource usage at the transaction level.

## **Enclaves**

To facilitate implementation of transaction management, WLM provides enclaves. An enclave is a group of one or more z/OS TCBs and SRBs that are logically related (usually through working on the same logical unit of work) and manage the work in entities.

An enclave can be long or short lived. In the Shadow Mainframe Adapter Server implementation, an enclave exists only for the duration of the time that a transaction is being processed.

The benefits of using an enclave to represent a transaction are valuable:

- The resources used to process the transaction can be accounted to the transaction itself, rather than to the address space in which the transaction runs.
- You can assign a performance goal to the enclave, which means that as a transaction consumes system resources, it can switch periods to run with either of the following modes of processing:
  - **Goal mode.** The mode in which the active service policy determines system resource management. SRM specifications in SYS1.PARMIB members IEAIPSxx and IEAICSxx are ignored.
  - **Compatibility (compat) mode.** The mode in which the parameters in SYS1.PARMLIB members IEAOPTxx, IEAICSxx, and IEAIPSxx determine system resource management.

## **WLM Classification of Shadow Transactions**

The WLM classification of Shadow transactions consists of the workloads, service classes, systems, resource groups, service policies, and classification rules in an installation. It is stored in WLM couple datasets. An active service policy is required for WLM support in both goal and compat modes.



There are some steps you will need to follow to classify Shadow transactions. These include:

1. Create or select service class definitions.
2. Create Shadow Mainframe Adapter Server classification rules.
3. Define service class definitions for Shadow subtasks.
4. Enable WLM support within Shadow Mainframe Adapter Server.
5. Verify proper WLM classification.



**Note:**

Steps 1-3 are accomplished within the IBM-supplied WLM ISPF application, SYS1.SBLSCLI0(IWMARIN0).

## Step 1: Create or Select Service Class Definitions

The service class contains work units with similar performance goals, business importance, and resource requirements. A service class can be defined specifically for the Shadow Mainframe Adapter Server or from an existing class (for example, use a TSO service class and define report classes for separating out the activity at report time).



**Note:**

IBM recommends setting up no more than 30 service classes.

It's advisable to create more than one service class if you want to give more importance to some transactions over others. You can also use existing service classes.



**Doc Reference:**

For detailed information about setting service class definitions, see *OS/390 V2R9.0 MVS Planning: Workload Management* and *OS/390 V2R9.0 MVS Workload Management Services*.

## Sample Service Class Definition for Shadow Mainframe Adapter Server

Figure 9–1 shows how a service class for high priority SDB transactions could be defined. This service class has three periods. The first two have percentile response time goals, while the third is a discretionary goal.

```

Service Class Name . . . . . : SDBHOT
Description . . . . . Hot Shadow Mainframe Adapter Server transactions
Workload Name . . . . . ONLINE      (name or ?)
Base Resource Group . . . . . _____ (name or ?)
Specify BASE GOAL information. Action Codes: I=Insert new period,
E=Edit period, D=Delete period.
    ---Period--- -----Goal-----
Action # Duration  Imp.  Description
---
   1    300        2    90% complete within 00:00:00.500
   2    800        4    90% complete within 00:00:02.000
   3                Discretionary

```

**Figure 9–1. Sample Service Class Definition**



**Note:**

The statements are shown as they would appear on the relevant definition screens in the WLM ISPF dialog, provided by IBM for building service policies.

## Step 2: Create Shadow Mainframe Adapter Server Classification Rules

Classification rules determine how incoming work is assigned to a service class. They are specified in terms of transaction qualifiers such as job name or transaction class.

To create classification rules:

1. Create a classification rule and specify SDB as a new subsystem type.
2. Specify the Qualifier Type depending on how you want to classify the work. There are different methods for classifying work within WLM and Shadow and its corresponding Qualifier Type. These include the following:

Userid	UI
DB2 plan name	PN
DB2 subsystem name	SPM (See note 1 below)
Shadow Mainframe Adapter Server subsystem name	SI (See note 2 below)
Mainframe Adapter Client application name as set in the Mainframe Adapter Client data source	TN

Mainframe Adapter Client module name    TN  
 Mainframe Adapter Client internal        TN  
 module name



**Notes:**

- An SPM rule is also used to match the Qualifier Type to whatever is specified in the Shadow Mainframe Adapter Server WLMCLASSDB2 (CLASSIFY USING DB2 SUBSYSTEM IDENTIFIER) parameter. But if the Shadow Mainframe Adapter Server WLMCLASSDB2 (CLASSIFY USING DB2 SUBSYSTEM IDENTIFIER) parameter is set to NO and the Shadow Mainframe Adapter Server WLMCLASSSPM (CLASSIFY USING SUBSYSTEM PARAMETER) parameter is set to YES, a single enclave will be created for all transactions in the Shadow address space on a per connection basis rather than one per transaction. Setting WLMCLASSSPM to YES will cause all other WLMCLASS\* specifications to be ignored.
  - An SI rule is used to match the Qualifier Type to whatever is specified via the Shadow Mainframe Adapter Server WLMCLASSSNAM (WORKMANAGER SUBSYSTEM NAME) parameter, which defaults to the Shadow Mainframe Adapter Server subsystem name. If you set the value of the Shadow Mainframe Adapter Server WLMCLASSSPM (CLASSIFY USING SUBSYSTEM PARAMETER) parameter to NO, an enclave will be created for each transaction.
3. Specify the Qualifier Name used for each classification entry. The qualifier name is dependent on the Qualifier Type being used.
- **Example 1.** If you are using the Qualifier Type UI, you can specify AI38\* as a value to match this rule with all userids beginning with AI38.
  - **Example 2.** If the Qualifier Type is set to TN, you can specify MSACCESS\* as the Qualifier Name for all MS-Access Mainframe Adapter Client applications.
- The order in which the rule is specified is the same order WLM will use to classify the transaction.
4. Specify the service class to use for this classification rule entry as defined in the service class rule created in step 1. You should also specify a default service class that should be used if a qualifier is not matched.

## Sample Classification Rule for Shadow

The rule shown in Figure 9–2 assigns all Shadow transactions from any userid beginning with AI38\* to service class SDBHOT, and it assigns transactions from all other users to the default service class, SDBNORM.

Subsystem Type . . .		SDB		Fold qualifier names? Y (Y or N)	
Description . . . Shadow Mainframe Adapter Server transactions					
Action codes: A=After C=Copy M=Move I=Insert rule					
B=Before D=Delete row R=Repeat IS=Insert Sub-rule					
-----Qualifier-----		-----Class----- Action			
Type	Name	Start		Service	Report
			DEFAULTS:	SDBNORM	_____
_____ 1	UI	AI38*	_____	SDBHOT	_____

**Figure 9–2. Sample Classification Rule**



**Note:**

The statements are shown as they would appear on the relevant definition screens in the WLM ISPF dialog, provided by IBM for building service policies.

## Step 3: Define Service Class Definitions for Shadow Subtasks

The above definitions supply WLM definitions for Shadow Mainframe Adapter Server connections but not for other subtasks which run under the Shadow Mainframe Adapter Server address space. These subtasks manage other components such as the Check Limits task, which monitors limits set on connections. The service class used to prioritize these subtasks are controlled by the sites STC rules. The STC rules may need to be reviewed to ensure proper values.

## Step 4: Enable WLM Support within Shadow Mainframe Adapter Server

In order for the Shadow Mainframe Adapter Server to correctly connect to WLM and run each transaction within the specified WLM enclaves, you must set the following Shadow Mainframe Adapter Server parameters. The parameter settings must match the classification rule definitions made in step 2 (see “Step 2: Create Shadow Mainframe Adapter Server Classification Rules” on page 9-4). You can set these parameters within the Shadow Mainframe Adapter Server initialization EXEC, SDBx.IN00:

```
"MODIFY PARM NAME(WLMCONNECT) VALUE(YES)"
```

Then, depending on how you classified work in step 2, you may need to set the following individual Shadow Mainframe Adapter Server parameters:

- To classify work by userid:

```
"MODIFY PARM NAME(WLMCLASSUSER)      VALUE(YES)"
```

- To classify work by DB2 plan name:

```
"MODIFY PARM NAME(WLMCLASSPLAN)      VALUE(YES)"
```

- To classify work by DB2 subsystem name:

```
"MODIFY PARM NAME(WLMCLASSDB2)       VALUE(YES)"
```

```
"MODIFY PARM NAME(WLMCLASSPM)        VALUE(NO)"
```

- To classify work by Shadow Mainframe Adapter Server subsystem name using a qualifier of SI in the classification rule (each transaction runs in its own enclave):

```
"MODIFY PARM NAME(WLMCLASSDB2)       VALUE(NO)"
```

```
"MODIFY PARM NAME(WLMCLASSPM)        VALUE(NO)"
```

 **Note:**

If WLMCLASSSPM is set to YES, then the settings for WLMCLASSTRAN, WLMCLASSPLAN, WLMCLASSDB2, and WLMCLASSUSER will be ignored.

- To classify work by Shadow Mainframe Adapter Server subsystem name using a qualifier of SPM in the classification rule (the entire connection runs in a single enclave):

```
"MODIFY PARM NAME(WLMCLASSDB2)       VALUE(NO)"
```

```
"MODIFY PARM NAME(WLMCLASSPM)        VALUE(YES)"
```

```
"MODIFY PARM NAME(WLMSUBSYSPARM)     VALUE(xxxxxxxx....)"
```

The value for WLMSUBSYSPARM is whatever is specified in the classification rule using a qualifier type of SPM.

 **Note:**

If WLMCLASSSPM is set to YES, then the settings for WLMCLASSTRAN, WLMCLASSPLAN, WLMCLASSDB2 and WLMCLASSUSER will be ignored.

- To classify work by Mainframe Adapter Client application name:

```
"MODIFY PARM NAME(WLMCLASSTRAN)      VALUE(YES)"
```

```
"MODIFY PARM NAME(WLMTRANNAME)       VALUE(APPLNAME)"
```

- To classify work by Mainframe Adapter Client module name:
 

```
"MODIFY PARM NAME (WLMCLASSTRAN) VALUE (YES) "
```

```
"MODIFY PARM NAME (WLMTRANNAME) VALUE (MODNAME) "
```
- To classify work by Mainframe Adapter Client internal name:
 

```
"MODIFY PARM NAME (WLMCLASSTRAN) VALUE (YES) "
```

```
"MODIFY PARM NAME (WLMTRANNAME) VALUE (INTNAME) "
```

## Shadow WLM Classification Summary Chart

Table 9–1 summarizes the WLM classifications.

**Table 9–1. WLM Classification Summary**

Action	Qualifier	Shadow Mainframe Adapter Server Parameter	Notes
Classify a unit of work	By transaction name	WLMCLASSTRAN	WLMTRANNAME specifies the source for transaction name. WLMCLASSTRAN/USER/PLAN/DB2 can be specified together in any combination.
Classify a unit of work	By userid	WLMCLASSUSER	
Classify a unit of work	By DB2 plan name	WLMCLASSPLAN	
Classify a unit of work	By DB2 subsystem name	WLMCLASSDB2	
Classify a unit of work	By Shadow Mainframe Adapter Server instance	WLMSUBSYSNAM	
Classify a single enclave	For all Shadow Mainframe Adapter Server transactions	WLMSUBSYSPARM WLMCLASSSPM	When WLMCLASSSPM is set to YES, the classification rules for SDB should have a default service class. The rule is only going to be used once during Mainframe Adapter Server initialization. In addition, all other WLMCLASS* specifications to be ignored.

## Step 5: Verify Proper WLM Classification

To verify that the workload is being classified properly, you can enable WLM tracing within the Shadow Mainframe Adapter Server as follows:

1. From the **Shadow Mainframe Adapter Server Primary Option Menu**, go to Option 5.2.
2. Press ENTER. The system displays the **Shadow Mainframe Adapter Server Parameter Groups** panel.

3. Type the **D** line command to the left of the PRODTRACE parameter group.
4. Press ENTER. The system will display the list of parameters within the PRODTRACE parameter group.
5. Find the TRACE WLM API CALLS parameter and type over the existing value in the PARAMETER VALUE column to set the parameter to YES.

**Note:**

You could optionally set this parameter to YES via the following **MODIFY PARM** parameter call within the Shadow Mainframe Adapter Server initialization EXEC, SDBxIN00:

```
"MODIFY PARM NAME(TRACEWLMCALLS) VALUE(YES)"
```

Once the parameter is set, connect with your application and run a transaction. To the right of the message is the information for the enclave. WLM work is being classified by userid (which means that the Shadow Mainframe Adapter Server parameter WLMCLASSUSER was previously set to YES). In the message is the userid and the WLM service class (Srvcls) in which the work was assigned. In the example, the service class NEWWORK was used to run the query to DB2.

## Running in WLM Compat Mode

PARMLIB specifications are used to assign a Shadow Mainframe Adapter Server transaction to a specific performance group. These are only available in compat mode.

To do this, the new SRVCLASS parameter must be used in the IEAICSxx definition for the Shadow Mainframe Adapter Server subsystem, and it must refer to an appropriate performance group.

Sample IEAICSxx specification for Shadow Mainframe Adapter Server:

```
SUBSYS=SDB
SRVCLASS=SDBNORM, PGN=29
```

Sample EAIPxxS specification for Shadow Mainframe Adapter Server:

```
PGN=29, (DMN=nn, DP=F4, ...)
```

In addition to the above, there has to be an active WLM policy that contains an appropriate classification rule for SDB transactions, assigning them to service class SDBNORM. These specifications cause all Shadow Mainframe Adapter Server transactions to be executed in performance group 29, even when the Mainframe Adapter Server address space itself may be in another performance group.



**Note:**

The dispatching priority of the Mainframe Adapter Server address space must be greater than or equal to the dispatching priority of the performance group that will be used to execute the transactions.



**CHAPTER 10:**  
**Shadow Mainframe Adapter  
Server:  
Enterprise Auditing**

---

---

This chapter covers Enterprise Auditing (Transaction Level Security), a feature of Shadow Mainframe Adapter Server, the Mainframe Adapter Server component of the Shadow product.

Topics Include:

- Overview
  - Implementation
  - Key Features
  - Key Benefits
- Prerequisites
- Creating an OS/390 or z/OS Security Environment
  - Prerequisites
  - Caching the OS/390 or z/OS Security Environment
  - Security Considerations
- Using Generic and Extended IDs
  - Mainframe Adapter Client Side Support
  - Host Side

## Support Overview

Shadow Enterprise Auditing was created to support the new and unique security requirements of Internet applications, while operating in the traditional enterprise computing environment. With Shadow Enterprise Auditing, web applications that access z/OS data and transactions can be used by people who do not have mainframe userids. Shadow Enterprise Auditing can also be used with non-Internet applications.

The development of Shadow Enterprise Auditing grew from the need to replace traditional z/OS, Unix, and NT security architecture, since the architecture could not adequately handle the larger volumes of data associated with Internet applications and used by millions of people. In addition, traditional userids have become too costly to create and administer and use too many machine resources required for logging onto the Internet.

## Implementation

Shadow Enterprise Auditing is a mechanism that provides protection for business transactions on the Internet by allowing two entities to conduct a transaction with

privacy and authentication. To accomplish this, Shadow Enterprise Auditing creates a separate, temporary security environment for each transaction that is sent over a connection from a middle-tier Web Server or Application Server to Shadow on the host. The transaction is typically an RPC or stored procedure and the connection is a network session.

Shadow implements Shadow Enterprise Auditing with a host of related new facilities based on two new IDs—the generic (or proxy) and the extended ID. Both of these IDs are provided in addition to the traditional user IDs supported by Shadow. The generic and extended IDs are made available to host applications and are used for auditing, logging, tracing, and tracking. The extended ID contains some type of application-specific user identification such as an e-mail address, SSN, login name, access ID, etc. The architecture is conducive to supporting digital certificates.

## Key Features

Shadow implements Shadow Enterprise Auditing with a host of related new facilities that offer the following benefits as solutions to certain security assumptions:

- **Connections:** Shadow Enterprise Auditing assumes that each middle-tier Application Server (AS) or Web Server will initialize a small number of permanent connections to the host Mainframe Adapter Server.
- **Connection/Session/Thread Reuse:** Shadow Enterprise Auditing assumes that each of the relatively small number of connections will be shared across all of the Internet connections. Each connection can be serially reused an arbitrary number of times by a different Internet user each time.
- **Control Userids:** Given the lack of any relationship between the identity of an Internet user and host userid, and the continuous reuse of each of the pooled host connections, Shadow Enterprise Auditing assumes that all of the connections will be established with a control userid that has sufficient resource access for all of the applications running on the AS/Web Server.
- **Transaction Security:** Because each connection is serially reused, each transaction for a given connection can be executed for a different Internet user. This means that each transaction must have a separate security environment associated with it, and must be appropriate for Internet application.
- **Performance:** It must be possible to establish and access a transaction security environment with essentially no or negligible overhead.
- **Resource Access:** The transaction security data must be available on the host side to control resource access on an application specific, selective basis. The transaction security data must also be available for auditing, logging, tracing, tracking, etc.

## Key Benefits

Shadow Enterprise Auditing support offers the following benefits:

- Provides unique, robust audit trail capability when implementing Web-based applications in a 3-tier environment.
- Enables auditability of a request from an unknown Web user by tagging a unique piece of identifying information to each Web request.
- Provides an effective mechanism for meeting security requirements of Internet applications while operating in a traditional enterprise computing environment.
- Provides an easy-to-use mechanism for creating and maintaining a separate, temporary security environment for each transaction on a per-RPC basis.

## Prerequisites

Before using Shadow Enterprise Auditing, you must make sure that the following prerequisites have been met:

- The Shadow Mainframe Adapter Server component has been installed.
- The Shadow Mainframe Adapter Client component has been installed.
- The Shadow Mainframe Adapter Client component has been configured and connected to the data source.
- The Shadow Mainframe Adapter Client is dated on or after 1999/06/02.
- Shadow has been licensed for the Shadow Event Facility™ (SEF) (optional).
- Shadow has been licensed for Shadow Enterprise Auditing (Transaction Level Security).

## Creating an OS/390 or z/OS Security Environment

The OS/390 or z/OS security environment created by passing the generic ID to SAF is maintained for the duration of RPC execution and will influence what resources the RPC can access.

The following factors must be considered if planning to pass generic IDs to SAF:

- Prerequisites
- Caching the z/OS security environment
- Security considerations

## Prerequisites

Generic IDs can be passed to SAF to create a z/OS security environment for running an RPC. To do this, the following requirements must be met:

- The generic IDs must be valid host userids.
- The TLSDYNAMICUSERIDS Shadow Mainframe Adapter Server parameter must be set to YES.



**Note:**

Setting TLSDYNAMICUSERIDS to YES will only affect the SAF processing of generic IDs. All of the other features and facilities can be used even if the TLSDYNAMICUSERIDS is set to NO.

## Caching the OS/390 or z/OS Security Environment

For performance reasons, the z/OS security environments created by passing generic IDs to SAF are cached. In other words, each generic ID is passed to SAF only once and the z/OS security environment is cached at the address space level. This approach allows use/reuse of generic ID security environment with negligible overhead.

To implement security environment caching, the SHARERUNAUTHACEES Shadow Mainframe Adapter Server parameter value is forced to YES. As a consequence, this product parameter does not have to be set.



**Note:**

There is no Shadow Event Facility™ (SEF) processing of LOGONs for generic IDs even if ATH rules for LOGON have been enabled. The generic ID z/OS security environments are maintained in the cache until the main product address space terminates.

## Security Considerations

There is a possible security exposure associated with using generic IDs with the TLSDYNAMICUSERIDS Shadow Mainframe Adapter Server parameter set to YES. In this case, a z/OS security environment will be created without a password. In addition, Mainframe Adapter Client applications will be able to use the generic ID z/OS security environment without providing a password. This means that only carefully controlled applications (running inside an Application

Server/Web Server) should be allowed to connect to a copy of Shadow that has the parameter `TLSDYNAMICUSERIDS` set to YES.

**Note:**

`TLSDYNAMICUSERIDS` defaults to NO and can only be set to YES using the Shadow initialization EXEC. `TLSDYNAMICUSERIDS` cannot be set to YES after the main product address space initialization has been completed.

If you want to make sure the Mainframe Adapter Client is recognized as a secure Mainframe Adapter Client, you must make sure the Shadow Event Facility™ (SEF) ATH parameter `ATH.AUPWENTL` is set to “1” in an SEF ATH LOGON rule. If it is not set to “1”, the Mainframe Adapter Client will not be recognized as a secure Mainframe Adapter Client, and all Shadow Enterprise Auditing requests from that Mainframe Adapter Client will be ignored.

This can be done using the sample SEF ATH LOGON rule, `LOGONTLS`. This sample rule checks the Mainframe Adapter Client IP address, and if it is set to a certain value, the rule sets the `ATH.AUPWENTL` to 1, thus allowing Shadow Enterprise Auditing to be used from this connection. The IP address to be checked may be changed to reflect your secured Mainframe Adapter Server.

## Using Generic and Extended IDs

Shadow implements Shadow Enterprise Auditing with a host of related new facilities. All of the facilities are based on two new IDs:

- Generic ID
- Extended ID

These two IDs are provided in addition to the traditional userids supported by Shadow. They are optional and can be used either together or separately. In addition, the generic and extended ID values can be used for application debugging, logging, tracing, and auditing purposes. These values also have the advantage that they can be set and/or reset as many times as needed for each connection.

**Note:**

Both the generic ID and extended ID values are only transmitted over the network when they are set for the first time or when they are changed.

### Generic ID

The generic ID is an 8-byte string, which is automatically converted to uppercase and padded with blanks on the right. This ID is made available to host applications and is used for auditing, logging, tracing, tracking, etc. It is specified

as an ASCII string on the Mainframe Adapter Client and is automatically converted to EBCDIC for host processing.

## Extended ID

The extended ID is a variable length 128-byte string. This string is passed from the Mainframe Adapter Client environment to the host. On the host side this ID is made available to host applications and is used for auditing, logging, tracing, tracking, etc. The extended ID is assumed to contain some type of application specific user identifier such as an e-mail address, social security number, login name, access ID, etc. Like the generic ID, the extended ID is specified as an ASCII string on the Mainframe Adapter Client and is automatically converted to EBCDIC for host processing. This means that the extended ID cannot contain binary data such as a digital certificate..

## Mainframe Adapter Client Side Support

The generic and extended IDs are supported on the Mainframe Adapter Client side with the following:

- Mainframe Adapter Client function
- CALL NEONEXEC interface

## Mainframe Adapter Client Function

The Mainframe Adapter Client `SQLSetConnectOption` function supports the generic ID and the extended ID on the Mainframe Adapter Client side. This function can be called at any time to set either value.

The option value for setting these IDs is as follows:

- **Generic ID:** `SQL_NEON_GENERIC_USERID`
- **Extended ID:** `SQL_NEON_EXTENDED_USERID`

### *Generic ID*

The following C example shows how the generic ID values are set:

```
rc = SQLSetConnectOption(hdbc, SQL_NEON_GENERIC_USERID,
(UDWORD) "AI38KPO");
if (rc != SQL_SUCCESS &&
    rc != SQL_SUCCESS_WITH_INFO)
    goto ex1b;
```

### *Extended ID*

The following C example shows how the extended ID values are set:

```
rc = SQLSetConnectOption(hdbc, SQL_NEON_EXTENDED_USERID,
(UDWORD) "I am not a digital certificate");
if (rc != SQL_SUCCESS &&
    rc != SQL_SUCCESS_WITH_INFO)
    goto ex1b;
```

## CALL NEONEXEC Interface

You can use the CALL NEONEXEC interface to set the generic and extended IDs. CALL NEONEXEC can be executed from any Mainframe Adapter Client application that supports the ODBC CALL verb.

### *Generic ID*

The syntax is as follows:

```
CALL NEONEXEC('SETCONNECTOPTION', 1853, "AI38KPO")
```

1853 is the SQLSetConnectOption value for SQL\_NEON\_GENERIC\_USERID.

### *Extended ID*

The syntax is as follows:

```
CALL NEONEXEC('SETCONNECTOPTION', 1854, "AI38KPO")
```

1854 is the SQLSetConnectOption value for SQL\_NEON\_GENERIC\_USERID.

## Host Side Support

The generic ID and the extended ID are supported on the host side using several different mechanisms. Each of these mechanisms is optional and any can be used together. The host mechanisms are as follows:

- APIs
- SMF per-transaction recording
- Trace browse
- Remote users

### APIs

The SQLGetInfo function can be used in host RPCs to access (but not update) the generic ID and the extended ID. The type values for the information are as follows:

- **C:** SQL\_GET\_GENERICID and SQL\_GET\_EXTENDEDEDID
- **Cobol:** SQL-GET-GENERICID and SQL-GET-EXTENDEDEDID
- **ASM:** ODSQGIGN and ODSQGIEX

Both are returned as null-terminated string values.



#### **Notes:**

- The output area for the generic ID should be large enough for the 8-byte string and the 1-byte null terminator.
- The output area for the extended ID should be large enough for the 128-byte string and the 1-byte null terminator.

## SMF Per-Transaction Recording

By setting the SMFTRANSACT Shadow Mainframe Adapter Server parameter to YES, the SMF per-transaction recording is activated to support the generic ID and the extended ID.



**Note:**

The extended ID area in the SMO6 record has room for only the first 50 bytes of the extended ID. A new record format will be provided if the entire extended ID is needed in the future.

## Trace Browse

If a generic ID exists, it will be contained in the USERID column of trace browse for SQL/RPC operations. The generic ID replaces the standard userid in trace browse if the generic ID has been set to a non-blank, non-zero value. This information is only provided for debugging, tracking, tracing, auditing, etc.



**Note:**

The standard userid will be stored in trace browse for non-SQL/RPC operations (such as network I/O) even if the generic ID is set. This means that both the generic ID and the standard userid will normally appear in trace browse for one session.

## Remote Users

The remote users display includes two new columns for the generic ID and the extended ID. These columns will contain their respective values if they have been set.



# CHAPTER 11: *Shadow Mainframe Adapter Server: Supported SMF Fields*

---

---

This chapter covers Shadow Mainframe Adapter Server SMF support, a feature provided by Shadow Mainframe Adapter Server, the Mainframe Adapter Server component of the Shadow product. Shadow SMF provides a means for gathering and recording information used to evaluate system usage.

Topics include:

- Enabling SMF Support
- Enabling SMF Support
- Units of Time
- SMF Record Types
  - SMF Type 01 Records
  - SMF Type 02 Records
  - SMF Type 03 Records
  - SMF Type 04 Records
  - SMF Type 06 Records
  - SMF Type 09 Records
  - SMF Type 10 Records
  - SMF Type 11 Records
  - SMF Type 13 Records
  - SMF Type 14 Records
  - SMF Type 15 Records
  - SMF Type 16 Records
  - SMF Type 17 Records

## **Enabling SMF Support**

To enable Shadow SMF recording, you must specify the following parameter within the Shadow Mainframe Adapter Server initialization EXEC, SDBx.IN00:

```
"MODIFY PARM NAME(SMFNUMBER)          VALUE(XXX)"
```

Where XXX is a number between 000 and 255. If the parameter is set to zero, no logging takes place.

## **Units of Time**

SMF data is expressed in time-of-day (TOD) format, which is an unsigned 64-bit fixed point number where bit 51 is the equivalent to 1 microsecond. The TOD clock is a binary counter where the bit positions of the clock are numbered 0 to 63. This corresponds to the bit positions of a 64-bit unsigned binary integer.

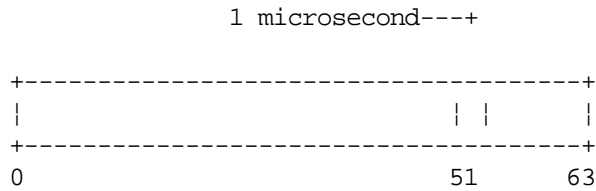

In the basic form, the TOD clock is incremented by adding a 1 in bit position 51 every microsecond. In models with a higher or lower resolution, a different bit position is incremented at a frequency where the rate of advancing the clock is the same as if a one were added in bit position 51 every microsecond. The resolution of the TOD clock is such that the incrementing rate is comparable to the instruction-execution rate of the model.

**Doc Reference:**

For more information on the TOD clock, refer to the *ESA/390 Principles of Operations OS/390 V2.R7*.

## SMF Record Types

The following are the SMF record subtypes for Shadow:

- **Type 01:** Mainframe Adapter Client system records
- **Type 02:** Interval summary records
- **Type 03:** Shadow Event Facility™ (SEF) rule disablement records
- **Type 04:** Global variable records
- **Type 06:** Per transaction SMF records
- **Type 09:** Storage interval summary records
- **Type 10:** APPC/MVS internal summary records
- **Type 11:** APPC/MVS conversation summary SMF records
- **Type 13:** Error logging SMF records
- **Type 14:** Mainframe Adapter Client response time records
- **Type 15:** Successful alteration records of a Shadow product parameter (applies to Shadow Console).
- **Type 16:** Shutdown information and statistics for Broker Mainframe Adapter Servers.
- **Type 17:** Counts for each ADABAS command by Database ID (DBID).

## SMF Type 01 Records

These records are written at the end of every connection. The type of record can be distinguished via the SMO1RCTY field in the SMF record. If this field is set to S, this is the final end-of-session record. If the field is set to F, this is a final interval record showing the usage of CPU time for that specified interval. If this field is set to I, this is an interim interval record. If you are only interested in end-of-session records, you *should always check* the SMO1RCTY field for each 01 record to ensure that it is not an interval record, otherwise incorrect calculations could be interpreted.

A sample SAS program has been provided that can be used to print out these SMF fields. The program is located in the SMFSDB01 member of the NEON.SV040800.CNTL dataset.

### Enabling Type 01 Records

There are no special requirements for enabling type 01 records.

### Type 01 Records

Type 01 records are listed in Table 11–1.

**Table 11–1. Type 01 Records**

Offset	Field Name	Field Type or Value	Description
	SMFHFG	BL1	HEADER FLAG BYTE
	SMFHESA4	B'00010000'	MVS/ESA 4
	SMFHXA	B'00001000'	MVS/XA
	SMFHESA	B'00000100'	MVS/ESA
	SMFHVS2	B'00000010'	VS2
2	SMFHRCTY	BL1	RECORD TYPE
3	SMFHTIME	BL4	RECORD WRITTEN TIME (TIME BIN)
7	SMFHDATE	PL4	RECORD WRITTEN DATE (0CCYYDDDF)
11	SMFHSYID	CL4	SYSTEM IDENTIFICATION (SMFID)
15	SMFHSSID	CL4	SUBSYSTEM ID (SDBB)
19	SMFHSUTY	BL2	RECORD SUBTYPE
21	SMFHVRCD	CL8	SDB VERSION CODE
37	SMO1CLNA	CL16	Mainframe Adapter Client SYSTEM NAME
53	SMO1CLTY	CL8	Mainframe Adapter Client TYPE (COMMUNICATION TYPE)
61	SMO1CLUS	CL8	Mainframe Adapter Client USERID

**Table 11–1. Type 01 Records (continued)**

Offset	Field Name	Field Type or Value	Description
69	SMO1CLCP	D	Mainframe Adapter Client CPU TIME (TIMEUSED MACRO)
77	SMO1SMID	CL4	HOST SYSTEM SMFID
81	SMO1ODVR	XL1	ODBC VERSION CODE
82	SMO1ODRL	XL1	ODBC RELEASE CODE
83	SMO1ODMD	XL2	ODBC MODIFICATION CODE (MONTH/DAY)
85	SMO1ODYR	AL2	ODBC YEAR VALUE
87	SMO1ODMN	AL1	ODBC MONTH VALUE
88	SMO1ODDD	AL1	ODBC DAY VALUE
89	SMO1CNID	XL4	CONNECTION ID
93	SMO1LGTM	XL8	Mainframe Adapter Client LOGON TIME (TOD)
105	SMO1ELTM	XL8	Mainframe Adapter Client ELAPSED TIME (TOD)
113	SMO1WRTO	XL8	Mainframe Adapter Client TOTAL BYTES WRITTEN (RAW)
121	SMO1TOTM	XL4	Mainframe Adapter Client TOTAL RESPONSE TIME IN USECS
125	SMO1HOTM	XL4	Mainframe Adapter Client HOST RESPONSE TIME IN USECS
129	SMO1ABCD	XL2	Mainframe Adapter Client ABEND CODE
131	SMO1USAB	XL2	Mainframe Adapter Client USER ABEND CODE
141	SMO1ADLT	XL8	Mainframe Adapter Client LOGON TIME (ADJUSTED FOR GMT)
149	SMO1IPAD	XL4	IP ADDRESS FOR TCP/IP Mainframe Adapter ClientS
153	SMO1ORUS	CL8	ORIGINAL USERID VALUE
161	SMO1PLAN	CL8	DB2 PLAN NAME
169	SMO1SSNA	CL4	DB2 SUBSYSTEM NAME
173	SMO1DBCP	CL8	DB2 CPU TIME (TOD FORMAT)
181	SMO1NTCP	CL8	NETWORK CPU TIME (TOD FORMAT)
189	SMO1OHCP	CL8	OTHER CPU TIME (TOD FORMAT)
197	SMO1RXCP	CL8	REXX CPU TIME (TOD FORMAT)
205	SMO1RPCP	CL8	RPC CPU TIME (TOD FORMAT)
213	SMO1INST	CL8	ADJUSTED INTERVAL START TIME (TOD FORMAT)

**Table 11–1. Type 01 Records (continued)**

Offset	Field Name	Field Type or Value	Description
221	SMO1SQCN	F	SQL COUNT
238	SMO1RCTY	C	RECORD TYPE (F, I, S)
239	SMO1APLN	H	APPLICATION NAME LENGTH
241	SMO1APNA	CL18	APPLICATION NAME FROM Mainframe Adapter Client
291	SMO1USLN	H	USER PARAMETER LENGTH
293	SMO1USPA	CL100	USER PARAMETER FROM THE Mainframe Adapter ClientS
393	SMO1PDSS	CL4	PRODUCT SUBSYSTEM NAME
397	SMO1CLWT	XL8	Mainframe Adapter Client WAIT TIME (TOD FORMAT)
405	SMO1CLRC	F	Mainframe Adapter Client READ DATA COUNT
409	SMO1LNID	CL100	Mainframe Adapter Client LAN (NETWORK) USERID
509	SMO1HONA	CL16	HOST NAME
525	SMO1ADCT	F	ADABAS COMMAND COUNT

## SMF Type 02 Records

These records are written out at the end of each interval and contain session information for each user connected during that specific interval. All the CPU time used by each user *during* that interval is recorded here.

A sample SAS program has been provided that can be used to print out these SMF fields. The program is located in the SMFSDB02 member of the NEON.SV040800.CNTL data set.

### Enabling Type 02 Records

The following is required for enabling type 02 records:

- You must be licensed for the Shadow Activity Monitor™ (SAM), a component of the Shadow Advanced Controls™ option.
- You must have the Shadow Logging feature enabled.
- You must specify the following parameter within the Shadow Mainframe Adapter Server initialization EXEC, SDBxIN00:

```
"MODIFY PARM NAME(RECORDINGINTERVAL) VALUE(XXXX)"
```

Where *xxxx* is a number between 0000 and 3600 seconds, indicating how often the interval summary records are created. If the parameter is set to zero, no logging takes place.

**Note:**

You can also add or change this parameter dynamically by using the ISPF panels or the Shadow Web Interface™. See the *Shadow Mainframe Adapter Server Started Task Parameter Reference* for instructions.

## Type 02 Records

Type 02 records are listed in Table 11–2.

**Table 11–2. Type 02 Records**

Offset	Field Name	Field Type or Value	Description
	SMFHFG	BL1	HEADER FLAG BYTE
	SMFHESA4	B'00010000'	MVS/ESA 4
	SMFHXA	B'00001000'	MVS/XA
	SMFHESA	B'00000100'	MVS/ESA
	SMFHVS2	B'00000010'	VS2
2	SMFHRCTY	BL1	RECORD TYPE
3	SMFHTIME	BL4	RECORD WRITTEN TIME (TIME BIN)
7	SMFHDATE	PL4	RECORD WRITTEN DATE (0CYDDDF)
11	SMFHSYID	CL4	SYSTEM IDENTIFICATION (SMFID)
15	SMFHSSID	CL4	SUBSYSTEM ID (SDBB)
19	SMFHSUTY	BL2	RECORD SUBTYPE
21	SMFHVRCD	CL8	SDB/SWS VERSION CODE
37	SMO2SMID	CL4	HOST SYSTEM SMFID
41	SMO2PDSS	CL4	PRODUCT SUBSYSTEM NAME
45	SMO2RCTY	C	RECORD TYPE
53	SMO2INST	CL8	INTERVAL START TIME (TOD FORMAT)
61	SMO2SQCN	F	SQL COUNT
77	SMO2CLCP	CL8	Mainframe Adapter Client TASK CPU TIME (TOD FORMAT)
85	SMO2DBCP	CL8	DB2 CPU TIME (TOD FORMAT)
93	SMO2NTCP	CL8	NETWORK CPU TIME (TOD FORMAT)

Table 11–2. Type 02 Records (*continued*)

Offset	Field Name	Field Type or Value	Description
101	SMO2OHCP	CL8	OTHER CPU TIME (TOD FORMAT)
109	SMO2RXCP	CL8	REXX CPU TIME (TOD FORMAT)
117	SMO2RPCP	CL8	RPC CPU TIME (TOD FORMAT)
125	SMO2ELTM	XL8	Mainframe Adapter Client ELAPSED TIME (TOD)
133	SMO2WRTO	XL8	RAW TOTAL BYTES WRITTEN
141	SMO2USCN	F	USER COUNT FOR THIS INTERVAL
145	SMO2MXUS	F	MAX INTERVAL CONCURRENT USERS
149	SMO2RPHW	F	RPC HIGH WATER MARK
153	SMO2RPCU	F	CURRENT NUMBER EXECUTING RPCS

## SMF Type 03 Records

These records track the enablement and disablement of Shadow Event Facility™ (SEF) rules. These records are *only* written at Shadow Mainframe Adapter Server shutdown—they are not written when the rules are disabled/re-enabled.

### Enabling Type 03 Records

The following is required for enabling type 03 records:

- You must be licensed for the Shadow Event Facility™ (SEF), a component of the Shadow Advanced Controls™ option.
- You must specify the following parameter within the Shadow Mainframe Adapter Server initialization EXEC, SDBx.IN00:

```
"MODIFY PARM NAME(SMFEPRODISABLE) VALUE(YES)"
```

This parameter defaults to NO.



#### Note:

You can also add or change this parameter dynamically by using the ISPF panels or the Shadow Web Interface™. See the *Shadow Mainframe Adapter Server Started Task Parameter Reference* for instructions.

### Type 03 Records

Type 03 records are listed in Table 11–3.

**Table 11–3. Type 03 Records**

Offset	Field Name	Field Type or Value	Description
	SMFHFG	BL1	HEADER FLAG BYTE
	SMFHESA4	B'00010000'	MVS/ESA 4
	SMFHXA	B'00001000'	MVS/XA
	SMFHESA	B'00000100'	MVS/ESA
	SMFHVS2	B'00000010'	VS2
2	SMFHRCTY	BL1	RECORD TYPE
3	SMFHTIME	BL4	RECORD WRITTEN TIME (TIME BIN)
7	SMFHDATE	PL4	RECORD WRITTEN DATE (0CYYDDDF)
11	SMFHSYID	CL4	SYSTEM IDENTIFICATION (SMFID)
15	SMFHSSID	CL4	SUBSYSTEM ID (SDBB)
19	SMFHSUTY	BL2	RECORD SUBTYPE
21	SMFHVRCD	CL8	SDB VERSION CODE
37	SM03RLTY	C	RULE TYPE FLAG
38	SM03LACK	XL8	LAST TIME THIS RULE FIRED (TOD FORMAT)
49	SM03PRCN	F	PROCESS COUNT
53	SM03FILI	F	FIRING LIMIT
57	SM03FIMX	F	FIRING HIGH WATER MARK PER INTERVAL
61	SM03RSNM	CL8	RULESET NAME
69	SM03RLNM	CL8	RULE NAME
77	SM03ENTM	BL4	RULE ENABLEMENT TIME (TIME BIN)
81	SM03ENDT	PL4	RULE ENABLEMENT DATE (0CYYDDDF)
85	SM03CR	CL128	RULE CRITERION
213	SM03ENTT	XL4	TOTAL ENABLED TIME IN SECONDS

## ***SMF Type 04 Records***

A single type 04 record is written by the Shadow Mainframe Adapter Server when it is shut down and the Shadow Event Facility™ (SEF) is in use.

### **Enabling Type 04 Records**

To enable type 04 records, you must be licensed for and using the Shadow Event Facility™ (SEF), a component of the Shadow Advanced Controls™ option.



## Type 04 Records

Type 04 records are listed in Table 11–4.

**Table 11–4. Type 04 Records**

Offset	Field Name	Field Type or Value	Description
	SMFHFG	BL1	HEADER FLAG BYTE
	SMFHESA4	B'00010000'	MVS/ESA 4
	SMFHXA	B'00001000'	MVS/XA
	SMFHESA	B'00000100'	MVS/ESA
	SMFHVS2	B'00000010'	VS2
2	SMFHRCTY	BL1	RECORD TYPE
3	SMFHTIME	BL4	RECORD WRITTEN TIME (TIME BIN)
7	SMFHDATE	PL4	RECORD WRITTEN DATE (0CYYDDDF)
11	SMFHSYID	CL4	SYSTEM IDENTIFICATION (SMFID)
15	SMFHSSID	CL4	SUBSYSTEM ID (SDBB)
19	SMFHSUTY	BL2	RECORD SUBTYPE
21	SMFHVRCD	CL8	SDB VERSION CODE
37	SM04_OP_OFFSET	F	OFFSET TO THE PERMANENT SECTION
41	SM04_OP_LENGTH	H	LENGTH OF THE PERMANENT SECTION
43	SM04_OP_NUMBER	H	NUMBER OF PERMANENT SECTIONS
45	SM04_OT_OFFSET	F	OFFSET TO THE TEMPORARY SECTION
49	SM04_OT_LENGTH	H	LENGTH OF THE TEMPORARY SECTION
51	SM04_OT_NUMBER	H	NUMBER OF TEMPORARY SECTIONS
53	SM04_OO_OFFSET	F	OFFSET TO THE OPSVALUE SECTION
57	SM04_OO_LENGTH	H	LENGTH OF THE OPSVALUE SECTION
59	SM04_OO_NUMBER	H	NUMBER OF OPSVALUE SECTIONS
61	SM04_P_NUM_GLOBALS	F	NUMBER OF GLOBAL VARIABLES (PERMANENT SECTION)
65	SM04_P_MAX_BLOCKS	F	MAXIMUM NUMBER OF BLOCKS (PERMANENT SECTION)
69	SM04_P_HIGH_USED	F	HIGH-USED BLOCK COUNT (PERMANENT SECTION)
73	SM04_P_IN_USE_BLKs	F	NUMBER OF IN-USE BLOCKS (PERMANENT SECTION)
77	SM04_P_FREE_BLKs	F	NUMBER OF FREE BLOCKS ON FREE CHAIN (PERMANENT SECTION)

**Table 11–4. Type 04 Records (continued)**

Offset	Field Name	Field Type or Value	Description
81	SM04_P_FREE_AREAS	F	NUMBER OF FREE AREAS ON FREE CHAIN (PERMANENT SECTION)
85	SM04_P_PAGES	F	NUMBER OF PAGES IN GLOBAL WORKSPACE (PERMANENT SECTION)
89	SM04_P_UPDATES	F	GLOBAL VARIABLE UPDATE COUNT (PERMANENT SECTION)
93	SM04_P_CHKPT_INTVL	F	SYSCHK1 CHECKPOINT INTERVAL IN SECONDS
97	SM04_P_CHKPT_COUNT	F	SYSCHK1 CHECKPOINT COUNT (PERMANENT SECTION)
101	SM04_P_CHKPT_RETRY	F	SYSCHK1 CHECKPOINT RETRY COUNT
105	SM04_P_ERRORS	F	GLOBAL VARIABLE ERROR MESSAGE COUNT (PERMANENT SECTION)
109	SM04_T_NUM_GLOBS	F	NUMBER OF GLOBAL VARIABLES (TEMPORARY SECTION)
113	SM04_T_MAX_BLOCKS	F	MAXIMUM NUMBER OF BLOCKS (TEMPORARY SECTION)
117	SM04_T_HIGH_USED	F	HIGH-USED BLOCK COUNT (TEMPORARY SECTION)
121	SM04_T_IN_USE_BLK	F	NUMBER OF IN-USE BLOCKS (TEMPORARY SECTION)
125	SM04_T_FREE_BLK	F	NUMBER OF FREE BLOCKS ON FREE CHAIN (TEMPORARY SECTION)
129	SM04_T_FREE_AREAS	F	NUMBER OF FREE AREAS ON FREE CHAIN (TEMPORARY SECTION)
133	SM04_T_PAGES	F	NUMBER OF PAGES IN GLOBAL WORKSPACE (TEMPORARY SECTION)
137	SM04_T_UPDATES	F	GLOBAL VARIABLE UPDATE COUNT (TEMPORARY SECTION)
141	SM04_T_ERRORS	F	GLOBAL VARIABLE ERROR MESSAGE COUNT (TEMPORARY SECTION)
149	SM04_O_SYS_OPSVAL	F	NORMAL OPSVALUE FUNCTION CALLS
153	SM04_O_GVAC_TOTAL	F	TOTAL INTERNAL OPSVALUE CALLS
157	SM04_O_GVAC_UNKNWN	F	INTERNAL OPSVALUE - UNKNOWN CALLER
161	SM04_O_GVAC_TODC	F	INTERNAL OPSVALUE - TOD CATCHUP
165	SM04_O_GVAC_EVENT	F	INTERNAL OPSVALUE - GLVEVENT
169	SM04_O_JOBID	F	INTERNAL OPSVALUE - GLVJOBID

## SMF Type 06 Records

These records will be written for each inbound Mainframe Adapter Client request. Each SMF transaction record contains information about all the work done on behalf of the Mainframe Adapter Client. The inbound Mainframe Adapter Client request may have caused zero, one, or more SQL operations to be executed.

A sample SAS program has been provided that can be used to print out these SMF fields. The program is located in the SMFSDB06 member of the NEON.SV040800.CNTL data set.

### Enabling Type 06 Records

To enable this type of record, you must specify the following parameter within the Shadow Mainframe Adapter Server initialization EXEC, SDBxIN00:

```
"MODIFY PARM NAME(SMFTRANSACT) VALUE(YES)"
```



#### Note:

You can also add or change this parameter dynamically by using the ISPF panels or the Shadow Web Interface. See the *Shadow Mainframe Adapter Server Started Task Parameter Reference* for instructions.

### Type 06 Records

Type 06 records are listed in Table 11–5.

**Table 11–5. Subtype 06 Records**

Offset	Field Name	Field Subtype or Value	Description
	SMFHF	BL1	HEADER FLAG BYTE
	SMFHESA4	B'00010000'	MVS/ESA 4
	SMFHXA	B'00001000'	MVS/XA
	SMFHESA	B'00000100'	MVS/ESA
	SMFHVS2	B'00000010'	VS2
2	SMFHRCTY	BL1	RECORD TYPE
3	SMFHTIME	BL4	RECORD WRITTEN TIME (TIME BIN)
7	SMFHDATE	PL4	RECORD WRITTEN DATE (0CYYDDDF)
11	SMFHSYID	CL4	SYSTEM IDENTIFICATION (SMFID)
21	SMFHVRCD	CL8	SDB/SWS VERSION CODE
37	SMO6CLNA	CL16	Mainframe Adapter Client SYSTEM NAME

**Table 11–5. Subtype 06 Records (continued)**

Offset	Field Name	Field Subtype or Value	Description
53	SMO6CLTY	CL8	Mainframe Adapter Client TYPE (COMMUNICATION TYPE)
61	SMO6IPAD	XL4	Mainframe Adapter Client IP ADDRESS
65	SMO6CLUS	CL8	Mainframe Adapter Client USERID
73	SMO6CNID	XL4	CONNECTION ID
77	SMO6SQOP	XL2	SQL OPERATION CODE
79	SMO6GNIDP	CL8	GENERIC USERID AREA
87	SMO6EXSZP	H	EXTENDED USERID SIZE
89	SMO6EXIDP	CL50	EXTENDED USERID AREA
102	SMO6GNVL	CL1	VALIDATION OF GENERIC ID
141	SMO6PDSS	CL4	PRODUCT SUBSYSTEM NAME
145	SMO6PLAN	CL8	DB2 PLAN NAME
153	SMO6SSNA	CL4	DB2 SUBSYSTEM NAME
157	SMO6ADLT	XL8	Mainframe Adapter Client LOGON TIME (ADJUSTED FOR GMT)
165	SMO6ADCU	XL8	CURRENT TIME (ADJUSTED FOR GMT)
173	SMO6ELTM	XL8	Mainframe Adapter Client ELAPSED TIME SO FAR (TOD)
181	SMO6SQEL	XL8	CURRENT SQL STATEMENT ELAPSED TIME
189	SMO6SQCP	XL8	CURRENT SQL STATEMENT CPU TIME
197	SMO6SQRC	F	CURRENT SQL STATEMENT RETURN CODE
201	SMO6SQRE	F	CURRENT SQL STATEMENT REASON CODE
205	SMO6SQSQ	F	CURRENT SQL STATEMENT SQL CODE
209	SMO6SQAB	F	CURRENT SQL STATEMENT ABEND CODE
293	SMO6SQLN	F	SQL SOURCE LENGTH
297	SMO6SQSR	F	SQL SOURCE STRING

## **SMF Type 09 Records**

These records are used to monitor Shadow Mainframe Adapter Server storage usage above and below the 16MB line. These records are written at the end of every Shadow Mainframe Adapter Server recording interval (which defaults to 15 minutes).

## Enabling Type 09 Records

To enable type 09 records, you must have the Shadow Logging feature enabled.

## Type 09 Records

Type 09 records are listed in Table 11–6.

**Table 11–6. Type 09 Records**

Offset	Field Name	Field Type or Value	Description
	SMFHFG	BL1	HEADER FLAG BYTE
	SMFHESA4	B'00010000'	MVS/ESA 4
	SMFHXA	B'00001000'	MVS/XA
	SMFHESA	B'00000100'	MVS/ESA
	SMFHVS2	B'00000010'	VS2
2	SMFHRCTY	BL1	RECORD TYPE
3	SMFHTIME	BL4	RECORD WRITTEN TIME (TIME BIN)
7	SMFHDATE	PL4	RECORD WRITTEN DATE (0CYYDDDF)
11	SMFHSYID	CL4	SYSTEM IDENTIFICATION (SMFID)
15	SMFHSSID	CL4	SUBSYSTEM ID (SDBB)
19	SMFHSUTY	BL2	RECORD SUBTYPE
21	SMFHVRCD	CL8	SDB VERSION CODE
37	SMO9SMID	CL4	HOST SYSTEM SMFID
41	SMO9PDSS	CL4	PRODUCT SUBSYSTEM NAME
45	SMO9RCTY	C	RECORD TYPE
53	SMO9INST	CL8	INTERVAL START TIME
77	SMO9MXUS	F	MAX INTERVAL CONCURRENT USER
81	SMO9TSSP	F	TRANSIENT SUBPOOL
85	SMO9TSBE	F	TRANSIENT HI ALLOC BTL
89	SMO9TSAB	F	TRANSIENT HI ALLOC ATL
93	SMO9HWBA	246D	HI ALLOC BTL HI ALLOC ATL

## SMF Type 10 Records

These records are used to monitor APPC/MVS activity and are part of the APPC/MVS Monitor feature of Shadow

## Enabling Type 10 Records

The following is required for enabling type 10 records:

- You must have the Shadow Logging feature enabled.
- You must specify the following parameter within the Shadow Mainframe Adapter Server initialization EXEC, SDBx.IN00:

```
"MODIFY PARM NAME(LOGAPMVSSUM) VALUE(YES)"
```



### Note:

You can also add or change this parameter dynamically by using the ISPF panels or the Shadow Web Interface™. See the *Shadow Mainframe Adapter Server Started Task Parameter Reference* for instructions.

## Type 10 Records

Type 10 records are listed in Table 11–7.

**Table 11–7. Type 10 Records**

Offset	Field Name	Field Type or Value	Description
	SMFHFG	BL1	HEADER FLAG BYTE
	SMFHESA4	B'00010000'	MVS/ESA 4
	SMFHXA	B'00001000'	MVS/XA
	SMFHESA	B'00000100'	MVS/ESA
	SMFHVS2	B'00000010'	VS2
2	SMFHRCTY	BL1	RECORD TYPE
3	SMFHTIME	BL4	RECORD WRITTEN TIME (TIME BIN)
7	SMFHDATE	PL4	RECORD WRITTEN DATE (0CYDDDDF)
11	SMFHSYID	CL4	SYSTEM IDENTIFICATION (SMFID)
15	SMFHSSID	CL4	SUBSYSTEM ID (SDBB)
19	SMFHSUTY	BL2	RECORD SUBTYPE
21	SMFHVRCD	CL8	SDB VERSION CODE
37	SM10SMID	CL4	HOST SYSTEM SMFID
41	SM10PDSS	CL4	PRODUCT SUBSYSTEM NAME
45	SM10RCTY	C	RECORD TYPE
53	SM10INST	XL8	INTERVAL START TIME
77	SM10CVTO	F	TOTAL CONVERSATIONS

**Table 11–7. Type 10 Records (continued)**

Offset	Field Name	Field Type or Value	Description
81	SM10ALTO	F	TOTAL ALLOCATED CONVERSATIONS
85	SM10SNTO	F	TOTAL NUMBER OF SENDS
93	SM10SDTO	D	TOTAL DATA SENT
101	SM10RCTO	F	TOTAL NUMBER OF RECEIVES
109	SM10RDTO	D	TOTAL DATA RECEIVED
117	SM10ACTO	F	TOTAL ACTIVE CONVERSATIONS

## SMF Type 11 Records

These records are used to monitor APPC/MVS activity and are part of the APPC/MVS Monitor feature of Shadow

### Enabling Type 11 Records

The following is required for enabling type 10 records:

- You must have the Shadow Logging feature enabled.
- You must specify the following parameter within the Shadow Mainframe Adapter Server initialization EXEC, SDBxIN00:

```
"MODIFY PARM NAME (LOGAPMVSSUM) VALUE (YES) "
```



#### **Note:**

You can also add or change this parameter dynamically by using the ISPF panels or the Shadow Web Interface™. See the *Shadow Mainframe Adapter Server Started Task Parameter Reference* for instructions.

### Type 11 Records

Type 11 records are listed in Table 11–8.

**Table 11–8. Type 11 Records**

Offset	Field Name	Field Type or Value	Description
	SMFHFG	BL1	HEADER FLAG BYTE
	SMFHESA4	B'00010000'	MVS/ESA 4
	SMFHXA	B'00001000'	MVS/XA
	SMFHESA	B'00000100'	MVS/ESA

**Table 11–8. Type 11 Records (continued)**

Offset	Field Name	Field Type or Value	Description
	SMFHVS2	B'00000010'	VS2
2	SMFHRCTY	BL1	RECORD TYPE
3	SMFHTIME	BL4	RECORD WRITTEN TIME (TIME BIN)
7	SMFHDATE	PL4	RECORD WRITTEN DATE (0CYYDDDF)
11	SMFHSYID	CL4	SYSTEM IDENTIFICATION (SMFID)
15	SMFHSSID	CL4	SUBSYSTEM ID (SDBB)
19	SMFHSUTY	BL2	RECORD SUBTYPE
21	SMFHVRCD	CL8	SDB VERSION CODE
37	SM11SMID	CL4	HOST SYSTEM SMFID
41	SM11PDSS	CL4	PRODUCT SUBSYSTEM NAME
45	SM11RCTY	C	RECORD TYPE
53	SM11INST	XL8	INTERNAL START TIME
77	SM11CVID	XL8	CONVERSATION ID
85	SM11INOT	F	INBOUND/OUTBOUND INDICATOR
89	SM11PLLO	F	PARTNER LU LOCATION
93	SM11CVKN	F	CONVERSATION KIND
97	SM11PLUW	XL26	LOGICAL UNIT OF WORK ID
123	SM11CVCO	XL8	CONVERSATION CORRELATOR
131	SM11USID	CL10	CONVERSATION USERIC
141	SM11SCNM	CL8	SCHEDULER NAME
149	SM11TPNM	CL8	TP NAME
157	SM11LTPN	CL8	LOCAL TP NAME
165	SM11LUNM	CL8	LU NAME
173	SM11PLNM	CL17	PARTNER LU NAME
193	SM11ARTM	XL8	ALLOCATE ARRIVAL TIME
201	SM11AVTM	XL8	CONVERSATION AVAILABLE TIME
209	SM11CSTM	XL8	CONVERSATION START TIME
217	SM11CETM	XL8	CONVERSATION END TIME
225	SM11MDNM	CL8	MODE NAME
233	SM11SYLV	F	SYNCHRONIZATION LEVEL
237	SM11SNT0	F	TOTAL SENDS



**Table 11–8. Type 11 Records (continued)**

Offset	Field Name	Field Type or Value	Description
245	SM11SDTO	D	TOTAL DATA SENT
253	SM11RCTO	F	TOTAL RECEIVES
261	SM11RDTO	D	TOTAL DATA RECEIVED
269	SM11CSTO	F	TOTAL CALLABLE SERVICE
273	SM11LSRC	F	LAST SERVICE RETURN CODE
277	SM11LSRE	F	LAST SERVICE REASON CODE
281	SM11CVST	F	CONVERSATION STATE
285	SM11LSBT	XL8	LAST SERVICE START TIME
293	SM11LSET	XL8	LAST SERVICE END TIME
301	SM11URID	XL16	UNIT OF RECOVERY IDENTIFIER
317	SM11CNID	F	CONNECTION ID
321	SM11CBAD	A	SM11 ADDRESS

## SMF Type 13 Records

These records are used for error recording.

### Type 13 Records

Type 13 records are listed in Table 11–9.

**Table 11–9. Subtype 13 Records**

Offset	Field Name	Field Subtype or Value	Description
	SMFHFG	BL1	HEADER FLAG BYTE
	SMFHESA4	B'00010000'	MVS/ESA 4
	SMFHXA	B'00001000'	MVS/XA
	SMFHESA	B'00000100'	MVS/ESA
	SMFHVS2	B'00000010'	VS2
2	SMFHRCTY	BL1	RECORD TYPE
3	SMFHTIME	BL4	RECORD WRITTEN TIME (TIME BIN)
7	SMFHDATE	PL4	RECORD WRITTEN DATE (0CYYDDDF)
9	SM13GNVL	CL1	VALIDATION OF GENERIC ID
11	SMFHSYID	CL4	SYSTEM IDENTIFICATION (SMFID)

**Table 11–9. Subtype 13 Records (continued)**

Offset	Field Name	Field Subtype or Value	Description
15	SMFHSSID	CL4	SUBSYSTEM ID (SDBB)
19	SMFHSUTY	BL2	RECORD TYPE
21	SMFHVRCD	CL8	SDB VERSION CODE
37	SM13SMID	CL4	HOST SYSTEM SMFID
41	SM13PDSS	CL4	PRODUCT SUBSYSTEM NAME
45	SM13RCTY	C	RECORD TYPE
69	SM13USID	CL8	Mainframe Adapter Client USERID
77	SM13GNID	CL8	GENERIC USERID
85	SM13EXID	CL(2+254)	EXTENDED USERID
341	SM13HONA	CL(2+100)	Mainframe Adapter Client HOST NAME
441	SM13PRTY	CL(2+8)	PROTOCOL TYPE
453	SM13IPAD	XL4	IP ADDRESS FOR IP Mainframe Adapter ClientS
457	SM13LUNA	CL(2+17)	LU NAME FOR LU 6.2 Mainframe Adapter ClientS
477	SM13CNID	F	SESSION ID
481	SM13TMSP	CL8	CURRENT TIMESTAMP
489	SM13LGTM	CL8	LOGON TIMESTAMP
497	SM13APNA	CL(2+18)	APPLICATION NAME
517	SM13PLAN	CL8	DB2 PLAN NAME STRING
525	SM13SSNA	CL4	DB2 SUBSYSTEM NAME STRING
529	SM13CUNM	F	CURSOR NUMBER
533	SM13RC	F	RETURN CODE
537	SM13RECD	F	REASON CODE
541	SM13SQCD	F	SQL CODE
545	SM13ABCD	F	ABEND CODE
549	SM13STNM	F	STATEMENT NUMBER
553	SM13STTY	F	STATEMENT TYPE

## ***SMF Type 14 Records***

These records are written in response to Mainframe Adapter Client response time exception events, which occur when the Mainframe Adapter Client response time exceeds the target response time goal.

**Doc Reference:**

For more information about Mainframe Adapter Client response time monitoring, see Chapter 14, “Shadow Mainframe Adapter Server: Monitoring Mainframe Adapter Client Response Time,” of this guide.

**Enabling Type 14 Records**

There are no special requirements for enabling type 14 records.

**Type 14 Records**

Type 14 records are listed in Table 11–10.

**Table 11–10. Type 14 Records**

Offset	Field Name	Field Type or Value	Description
	SMFHFG	BL1	HEADER FLAG BYTE
	SMFHESA4	B'00010000'	MVS/ESA 4
	SMFHXA	B'00001000'	MVS/XA
	SMFHESA	B'00000100'	MVS/ESA
	SMFHVS2	B'00000010'	VS2
2	SMFHRCTY	BL1	RECORD TYPE
3	SMFHTIME	BL4	RECORD WRITTEN TIME (TIME BIN)
7	SMFHDATE	PL4	RECORD WRITTEN DATE (0CYYDDDF)
11	SMFHSYID	CL4	SYSTEM IDENTIFICATION (SMFID)
15	SMFHSSID	CL4	SUBSYSTEM ID (SDBB)
19	SMFHSUTY	BL2	RECORD SUBTYPE
21	SMFHVRCD	CL8	SDB VERSION CODE
37	SM14RCTY	C	RECORD TYPE
41	SM14APNM	CL32	APPLICATION NAME
73	SM14LNID	CL100	Mainframe Adapter Client NETWORK USERID
173	SM14IPAD	XL4	IP ADDRESS FOR IP Mainframe Adapter ClientS
177	SM14USID	CL8	Mainframe Adapter Client USERID
184	SM14DNDA	CL100	Mainframe Adapter Client DOMAIN NAME
285	SM14TMMI	F	RESPONSE TIME IN MILLISECONDS (THIS IS THE ACTUAL Mainframe Adapter Client RESPONSE TIME FOR THE TRANSACTION THAT PRODUCED THE EXCEPTION EVENT)

**Table 11–10. Type 14 Records (continued)**

Offset	Field Name	Field Type or Value	Description
289	SM14TRTR	F	TOTAL NUMBER OF Mainframe Adapter Client RESPONSE TIME RECORDS
293	SM14SRTR	F	SUM OF THE TOTAL RESPONSE TIME FOR ALL OF THE RECORDS
297	SM14TMGR	F	TOTAL NUMBER OF Mainframe Adapter Client RESPONSE TIME RECORDS THAT MISSED THE RESPONSE TIME GOAL
301	SM14SMGR	F	SUM OF THE TOTAL RESPONSE TIME FOR THE RECORDS THAT MISSED THE RESONSE TIME GOAL
305	SM14TGRT	F	Mainframe Adapter Client RESPONSE TIME GOAL (THIS IS THE ACCEPTABLE RESPONSE TIME)

## SMF Type 15 Records

These records are written whenever a Shadow Console user successfully alters a Shadow product parameter.

### Enabling Type 15 Records

There are no special requirements for enabling type 15 records.

### Type 15 Records

Type 15 records are listed in Table 11–11.

**Table 11–11. Subtype 15 Records**

Offset	Field Name	Field Subtype or Value	Description
	SMFHFG	BL1	HEADER FLAG BYTE
	SMFHESA4	B'00010000'	MVS/ESA 4
	SMFHXA	B'00001000'	MVS/XA
	SMFHESA	B'00000100'	MVS/ESA
	SMFHVS2	B'00000010'	VS2
2	SMFHRCTY	BL1	RECORD TYPE
3	SMFHTIME	BL4	RECORD WRITTEN TIME (TIME BIN)
7	SMFHDATE	PL4	RECORD WRITTEN DATE (0CYYDDDF)
11	SMFHSYID	CL4	SYSTEM IDENTIFICATION (SMFID)
15	SMFHSSID	CL4	SUBSYSTEM ID (SDBB)

**Table 11–11. Subtype 15 Records (continued)**

Offset	Field Name	Field Subtype or Value	Description
19	SMFHSUTY	BL2	RECORD TYPE
21	SMFHVRCD	CL8	SDB VERSION CODE
37	SM15SMID	CL4	HOST SYSTEM SMF ID
41	SM15PDSS	CL4	PRODUCT SUBSYSTEM NAME
45	SM15CLNA	CL16	Mainframe Adapter Client SYSTEM NAME
61	SM15CLTY	CL8	Mainframe Adapter Client COMMUNICATION TYPE
69	SM15IPAD	XL4	IP ADDRESS FOR TCP/IP Mainframe Adapter ClientS
73	SM15CLUS	CL8	Mainframe Adapter Client USERID
81	SM15CNID	XL4	CONNECTION ID
85	SM15GNID	CL8	Mainframe Adapter Client GENERIC USERID
93	SM15FLNA	CL20	Product Parameter Field Name
113	SM15VLLN	F	Field Value Length
117	SM15NWVL	CL256	NEW FIELD VALUE
336	SM15GNVL	CL1	VALIDATION OF GENERIC ID

## SMF Type 16 Records

These records are written at Shadow shutdown and contain information and statistics for Broker Mainframe Adapter Servers.

### Enabling Type 16 Records

There are no special requirements for enabling type 16 records.

### Type 16 Records

Type 16 records are listed in Table 11–12.

**Table 11–12. Type 16 Records**

Offset	Field Name	Field Type or Value	Description
	SMFHFG	BL1	HEADER FLAG BYTE
	SMFHESA4	B'00010000'	MVS/ESA 4
	SMFHXA	B'00001000'	MVS/XA
	SMFHESA	B'00000100'	MVS/ESA

**Table 11–12. Type 16 Records (continued)**

Offset	Field Name	Field Type or Value	Description
	SMFHVS2	B'00000010'	VS2
2	SMFHRCTY	BL1	RECORD TYPE
3	SMFHTIME	BL4	RECORD WRITTEN TIME (TIME BIN)
7	SMFHDATE	PL4	RECORD WRITTEN DATE (0CYYDDDF)
11	SMFHSYID	CL4	SYSTEM IDENTIFICATION (SMFID)
15	SMFHSSID	CL4	SUBSYSTEM ID (SDBB)
19	SMFHSUTY	BL2	RECORD SUBTYPE
21	SMFHVRCD	CL8	SDB VERSION CODE
37	SM16SMID	CL4	HOST SYSTEM SMF ID
41	SM16PDSS	CL4	PRODUCT SUBSYSTEM NAME
45	SM16NAME	CL50	DATA MAPPING STRUCTURE NAME
95	SM16DATE	XL8	CREATION DATE IN STORE CLOCK FORMAT
103	SM16BKSN	CL32	BROKER Mainframe Adapter Server NAME
135	SM16BKSC	CL32	BROKER Mainframe Adapter Server CLASS
167	SM16BKSS	CL32	BROKER Mainframe Adapter Server SERVICE
199	SM16CIXF	CL8	CICS PROGRAM TO TRANSFER TO
207	SM16CICL	H	LENGTH OF CICS COMMAREA
209	SM16CICA	CL250	CICS COMMAREA PASSED
459	SM16BKST	XL1	BROKER SERVICE TYPE X'00' = CICS X'80' = BATCH X'40' = STARTED TASK X'20' = SYBASE X'10' = HTTP
460	SM16BKCP	XL1	PERSISTENT INDICATOR X'80' = PERSISTENT Mainframe Adapter Server X'00' = NOT A PERSISTENT Mainframe Adapter Server
466	SMK6MAXS	H	MAXIMUM Mainframe Adapter ServerS ALLOWED
468	SM16CLNA	F	Mainframe Adapter Client NON-ACTIVITY TIMER
472	SM16SVNA	F	Mainframe Adapter Server NON-ACTIVITY TIMER
476	SM16SVIN	F	Mainframe Adapter Server INACTIVITY TIMEOUT COUNT
480	SM16MAXR	F	MAXIMUM RECEIVES
484	SM16REGC	F	REGISTRATION COUNT

**Table 11–12. Type 16 Records (continued)**

Offset	Field Name	Field Type or Value	Description
488	SM16DREG	F	DEREGISTRATION COUNT
492	SM16RCVC	F	Mainframe Adapter Server RECEIVE COUNT
496	SM16SNDC	F	Mainframe Adapter Server SEND COUNT
500	SM16TIMC	F	Mainframe Adapter Server TIMEOUT COUNT
504	SM16ABNC	F	Mainframe Adapter Server ABEND COUNT
508	SM16WATC	F	Mainframe Adapter Server WAIT COUNT
512	SM16ACTC	F	HIGH WATER Mainframe Adapter Server ACTIVE COUNT
516	SM16ACTT	XL8	TIME HIGH WATER Mainframe Adapter Server ACTIVE COUNT ACHIEVED
524	SM16SUST	XL8	TIME Mainframe Adapter Server WAS LAST SUSPENDED
532	SM16SUSR	F	SUSPENSION SECONDS REMAINING
536	SM16SUSE	CL8	ERROR THAT CAUSED Mainframe Adapter Server TO BE SUSPENDED
540	SM16SUSC	F	Mainframe Adapter Server SUSPENSION COUNT
544	SM16SUEC	F	Mainframe Adapter Server ERROR COUNT

## SMF Type 17 Records

These records are written at session termination whenever the session has accessed an ADABAS database. There is one record written for each Database ID (DBID) referenced and it contains counts of the ADABAS commands issued against the Database

### .Enabling Type 17 Records

In addition to the normal requirements for enabling SMF records, the Product Parameter, ADABASDBIDSMF must be set to YES.

### Type 17 Records

Type 17 records are listed in Table 11–13.

**Table 11–13. Type 17 Records**

Offset	Field Name	Field Type or Value	Description
37	SM17SMID	CK4	HOSSET SYSTEM SMF ID
41	SM17PDSS	CL4	PRODUCT SUBSYSTEM NAME

**Table 11–13. Type 17 Records (continued)**

Offset	Field Name	Field Type or Value	Description
45	SM17ID	CL8	USERID
53	SM17LID	CL8	LOGON USERID
61	SM17DBID	H	DATABASE IDENTIFIER (DBID)
65	SM17A1	F	A1-UPDATE RECORD
69	SM17BT	F	BT-BACKOUT TRANSACTION
73	SM17C1	F	C1-WRITE A CHECKPOINT
77	SM17C3	F	C3-WRITE A CHECKPOINT
81	SM17C5	F	C5-WRITE USER DATA TO LOG
85	SM17E1	F	E1-DELETE RECORD/REFRESH FILE
89	SM17ET	F	ET-END TRANSAT
93	SM17HI	F	HI-HOLD A RECORD
97	SM17L1	F	L1-READ RECORD
101	SM17L4	F	L4-READ AND HOLD RECORD
105	SM17L2	F	L2-READ PHYSICAL SEQUENTIAL
109	SM17L5	F	L5-READ PHYSICAL SEQUENTIAL
113	SM17L3	F	L3-READ LOGICAL SEQUENTIAL
117	SM17L6	F	L6-READ LOGICAL SEQUENTIAL
121	SM17L9	F	L9-READ DESCRIPTOR VALUES
125	SM17LF	F	LF-READ FIELD DEFINITIONS
129	SM17N1	F	N1-ADD A RECORD
133	SM17N2	F	N2-ADD A RECORD
137	SM17RC	F	RC-RELEASE COMMAND
141	SM17RE	F	RE-READ ET USER DATA
145	SM17RI	F	RI-RELEASE RECORD
149	SM17S1	F	S1-FIND RECORDS
153	SM17S2	F	S2-FIND RECORDS
157	SM17S3	F	S3-FIND RECORDS
161	SM17S5	F	S5-FIND COUPLED ISNS
165	SM17S8	F	S8-PROCESS ISN LISTS
169	SM17S9	F	S9-SORT ISN LISTS
173-185			RESERVED







**CHAPTER 12:**

# ***Shadow Mainframe Adapter Server: Limiting Number of Shadow Connections***

---

---

This chapter covers the method for limiting the number of connections to the Shadow Mainframe Adapter Server, the Mainframe Adapter Server component of the Shadow product.

Topics include:

- Overview
- Rejecting Connections
  - Placing Connections in a Queue

## **Overview**

The Shadow Mainframe Adapter Server is licensed for a certain number of connections, and only that number can be logged on to the Mainframe Adapter Server at any one time. If someone tries to log on after that number has been reached, the Shadow Mainframe Adapter Server will either reject that connection or place the connection in a holding queue until someone logs off.

## **Rejecting Connections**

To reject connections when the allowed number has been exceeded, use the **MODIFY PARM** command within the Shadow Mainframe Adapter Server initialization EXEC, SDBxIN00, to set the following parameter:

```
"MODIFY PARM NAME(DB2CONCURRENTMX) VALUE(XXXX) "
```

Where:

### **DB2CONCURRENTMX**

Specifies the maximum number of concurrent DB2 users. This value should be a number between 0 and 2000.

When this parameter value has been reached, the Shadow Mainframe Adapter Server will reject any further connections and return an error message to the Mainframe Adapter Client.

## ***Placing Connections in a Queue***

Use the **MODIFY PARM** command within the Shadow Mainframe Adapter Server initialization EXEC, SDBxIN00, to set the following parameters:

```
"MODIFY PARM NAME(REUSETHREADS)      VALUE(YES) "  
"MODIFY PARM NAME(TARGETTHREADCOUNT) VALUE(XXXX) "
```

Where:

### **REUSETHREADS**

Controls whether or not threads should be reused. If this flag is set, each thread will be reused a number of times if possible. If this flag is not set, a new thread will always be created for each new inbound session. Thread reuse may reduce CPU resource utilization quite considerably when DB2 threads are used frequently and/or Mainframe Adapter Client userids are cached and reused for persistent session support. This value should be set to YES.

### **TARGETTHREADCOUNT**

Controls the target number of threads in some UDP and TCP execution modes. The value controls the number of subtasks created during product startup to handle inbound UDP datagrams and TCP sessions. This value should be a number between 1 and 1000.

Any connections that exceed the TARGETTHREADCOUNT number would queue and wait indefinitely for a new connection to become available. When a connection is released, the new connection will be allowed to connect. Generally this support works best with applications that have coded logic to connect and reconnect frequently based on work being performed, rather than allow idle connections to remain. This also works well with Shadow Mainframe Adapter Server's Virtual Connection Facility support, which controls connections based on units of work.

**CHAPTER 13:**

# ***Shadow Mainframe Adapter Server: Disaster Recovery***

---

---

This chapter covers Disaster Recovery, a feature of Shadow Mainframe Adapter Server, the Mainframe Adapter Server component of the Shadow product.

Topics include:

- Overview
- Disabling the Warning Message Prompt
  - Disabling All Mainframe Adapter Client Prompts
  - Deleting the Host Connection Text String
  - Requesting a Temporary License Code

## **Overview**

When performing disaster recovery or a disaster recovery test, you should be able to run Shadow Mainframe Adapter Server on an unlicensed CPU. When Shadow Mainframe Adapter Server is started on an unlicensed CPU, Shadow Mainframe Adapter Server will issue a single warning at Mainframe Adapter Server startup and then will continue to run normally. Every time Mainframe Adapter Client applications connect to the Shadow Mainframe Adapter Server, a warning message that Shadow is running on an unlicensed CPU will be sent back to the Mainframe Adapter Client applications, and then the Mainframe Adapter Client applications will be allowed to continue normally.



**Note:**

In some cases, this warning message prompting can significantly affect a Mainframe Adapter Client application (especially a 3-tier application) if the application is unattended and no one is available to respond to the prompt.

## **Disabling the Warning Message Prompt**

There are three ways to disable the warning message prompt:

- Disable all Mainframe Adapter Client prompts.
- Delete the host connection text string.
- Request a temporary license code.

## ***Disabling All Mainframe Adapter Client Prompts***

The warning message prompt for the Mainframe Adapter Client can be disabled by setting the NOPM (Disable All Prompts) keyword to YES. This keyword controls whether to disable all interactive prompts or informational message boxes. By setting this keyword to YES, all interactive prompts informational message boxes will be disabled. This feature is required when Shadow Mainframe Adapter Client is being called from an NT service, a Unix daemon process, or any Mainframe Adapter Server type application that cannot be interrupted.



**Note:**

For a 3-tier application, the recommendation is to always set this keyword to YES.

## ***Deleting the Host Connection Text String***

The warning message prompt can be disabled by using the Shadow Mainframe Adapter Server ISPF panel options to set the Shadow Mainframe Adapter Server HOST CONNECTION TEXT STRING (CONNECTIONTEXT) parameter to blank.



**Note:**

You will need to set the HOST CONNECTION TEXT STRING parameter to blank each time the Shadow Mainframe Adapter Server is recycled because the parameter is reset every time the Shadow Mainframe Adapter Server is restarted.

To delete the host connection text string, perform the following steps:

1. From the **Shadow Mainframe Adapter Server Primary Option Menu** (Figure 13–1), select Option 5, SDB Control.

```

----- Shadow Mainframe Adapter Server Primary Option Menu -----
-----
Option ===>

 1 LINK          - Display and control link table           Time      - 12:35
 2 IMS           - IMS Control Facility                     Terminal  - 3278
 3 CICS          - CICS Control Facility                     PF Keys   - 24
 4 REMOTE USER  - Display and control remote users         VV.RR.MM - 04.08.01
 5 SDB CONTROL  - Control Shadow Mainframe Adapter Server   Sub-
sys - SDBB
 6 TRACE BROWSE - Browse Shadow Mainframe Adapter Server trace log
 7 SEF CONTROL  - Control Shadow Event Facility (SEF)
 8 DATABASES    - Monitor and control database access
10 DATA MAPPING - Data Mapping Facility
11 ACI          - Advanced Communications Interface
 D DEBUG       - Debugging Facilities
S SUPPORT      - Display Shadow Mainframe Adapter Server Support Information
T TUTORIAL     - Display information about Shadow Mainframe Adapter Server

```

**Figure 13–1. Shadow Mainframe Adapter Server Primary Option Menu**

2. Press ENTER. The system displays the **Shadow Mainframe Adapter Server Control Option Menu**, as shown in Figure 13–2.

```

----- Shadow Mainframe Adapter Server Control Option Menu -----
----- SDBB -----
OPTION ===>

 1 ISPF Session - Display and modify ISPF/SDB session parameters
 2 SDB Task     - Display and modify SDB main task parameters
 3 SDB Blocks   - Display formatted SDB control blocks
 4 SDB Stats    - Display SDB product statistics
 5 SDB Tokens   - Display and Control tokens
 6 SDB Modules  - Display product module vector table entries
 7 SDB Tasks    - Display product tasks
 9 SDB IP Tree  - Display the IP address tree
10 SDB Prcs Blks - Display the Cross Memory Process Blocks
11 SDB RPC      - RPC Control Facility
12 SDB Copies   - Display information about each copy of the product
13 SDB Storage  - Display virtual storage information
14 SSL Utilities - SSL Key and Certificate Handling Utilities
15 Trace Archive - Trace Browse Archive Facility
17 SDB Group    - Display all remote users in a group
19 NLS Tables   - Display National Language Support tables

```

**Figure 13–2. Shadow Mainframe Adapter Server Control Option Menu**

3. From this menu, select Option 2, SDB Task.
4. Press ENTER. The system displays the **Shadow Mainframe Adapter Server Parameters Groups** (Figure 13–3).

- Type the **D** (Display Parameters) line command to the left of the **PRODLICENSE** group, as shown in Figure 13–3.

```
----- Shadow Mainframe Adapter Server Parameter Groups
---- ROW 1 OF 26
COMMAND ==>                                SCROLL ==> PAGE
Line Commands:  D Display Parameters  F Format  P Print CB  S Show CB

PARAMETER          GROUP
GROUP              DESCRIPTION
PRODADABAS         PRODUCT ADABAS PARAMETERS
PRODAPPCMVS        PRODUCT APPC/MVS PARAMETERS
PRODBROWSE         PRODUCT TRACE BROWSE PARAMETERS
PRODCICS           PRODUCT CICS PARAMETERS
PRODCOMM           PRODUCT COMMUNICATIONS PARAMETERS
PRODFILE           PRODUCT FILE PARAMETERS
PRODGLV            PRODUCT GLOBAL VARIABLE PARAMETERS
PRODIMS            PRODUCT IMS PARAMETERS
D PRODLICENSE      PRODUCT LICENSING PARAMETERS
PRODLOGGING        PRODUCT LOGGING PARAMETERS
PRODMESSAGES       PRODUCT MESSAGES
PRODMODULES        PRODUCT MODULES
PRODMSGQ           PRODUCT MESSAGE QUEUING PARAMETERS
PRODPARM           PRODUCT GENERAL PARAMETERS
PRODREXX           PRODUCT REXX PARAMETERS
PRODRPC            PRODUCT RPC PARAMETERS
PRODRRS            PRODUCT RESOURCE RECOVERY SERVICES PARAMETERS
PRODSECURITY       PRODUCT SECURITY PARAMETERS
PRODSEF            PRODUCT SEF PARAMETERS
PRODSQL            PRODUCT SQL PARAMETERS
PRODSTOR           PRODUCT STORAGE PARAMETERS
PRODTOKEN          PRODUCT TOKEN PROCESSING PARAMETERS
PRODTRACE          PRODUCT TRACE PARAMETERS
PRODWLM            PRODUCT WLM SUPPORT PARAMETERS
PRODALL            ALL PRODUCT PARAMETERS
OBSOLETE           OBSOLETE PRODUCT PARAMETERS
```

**Figure 13–3. Shadow Mainframe Adapter Server Parameter Groups**

- Press ENTER. The system displays the parameters in that group (Figure 13–4).
- In the **PARAMETER VALUE** column, type over the existing value you want to change. Set the value for the parameter **HOST CONNECTION TEXT STRING** to blank, as shown in Figure 13–4.



```

----- Shadow Mainframe Adapter Server Parameters -----
SCR 1 ROW 1 OF 13
COMMAND ==> SCROLL ==> PAGE
Line Commands:  D Display  F Format  P Print CB  S Show CB

PARAMETER                PARAMETER
DESCRIPTION              VALUE
PRODUCT LICENSE CODE STRING  '45R0SRLI46C7MS3SXV5J'
PRODUCT FAMILY CODE PREFIX   '45'
FIRST LICENSED CPU ID       '99999'
PRODUCT EXPIRATION DATE     '2001/11/25'
PRODUCT FEATURE CODE STRING  'A CDE G IJKLM'
CURRENT CPU ID              '10914'
DAYS PRIOR TO EXPIRATION    142
MAXIMUM LICENSED DB2 USERS  2000
MAXIMUM CONCURRENT DB2 USERS 2000
CONCURRENT DB2 USER COUNT   0
CONCURRENT DB2 USER HI-WATER MARK 12
HOST CONNECTION TEXT STRING  ''
OEM VENDOR NAME STRING      'OEM VENDOR'
*END*

```

**Figure 13–4. PRODLICENSE Parameter Group**

8. Press ENTER. If the value was successfully modified, the system will display a “VALUE/S MODIFIED” message in the upper right hand corner of the panel, as shown in Figure 13–5.

```

----- Shadow Mainframe Adapter Server Parameters -----
VALUE/S MODIFIED
COMMAND ==> SCROLL ==> PAGE

```

**Figure 13–5. Return Message for Successfully Modifying a Parameter Value**

## Requesting a Temporary License Code

If neither of the other alternatives for disabling the warning message prompt are acceptable, then please request a temporary license code by contacting Customer Support.



*CHAPTER 14:*

# ***Shadow Mainframe Adapter Server: Monitoring Mainframe Adapter Client Response Time***

---

---

This chapter describes the Mainframe Adapter Client response time monitoring feature available from Shadow Mainframe Adapter Server, the Mainframe Adapter Server component of the Shadow product.

Topics include:

- Overview
- Enabling Mainframe Adapter Client Response Time Monitoring
  - Step 1: Setting the Product Parameter
  - Step 2: Creating the Definitions
  - Step 3: Restarting Shadow Mainframe Adapter Server
- Viewing Mainframe Adapter Client Response Time Information
  - SMF Recording

## **Overview**

Shadow Mainframe Adapter Server offers a facility to monitor Mainframe Adapter Client response time by application. Mainframe Adapter Client response time is the time between the start of the query and the point at which data is returned to the Mainframe Adapter Client side.

To monitor Mainframe Adapter Client response time, the user must specify the following:

- **Application.** The user must specify the application using one of the following:
  - Application name
  - Internal name
  - Module name
- **Response time goal.** The user must set a response time goal for each application.

If the actual Mainframe Adapter Client response time is greater than the specified response time goal, an exception event occurs. The exception event can be used to trigger the SMF recording, which will write SMF records related to the Mainframe Adapter Client response time.

# Enabling Mainframe Adapter Client Response Time Monitoring

The following steps are required to enable Mainframe Adapter Client response time monitoring:

1. Set the Mainframe Adapter Client response time product parameter.
2. Create the definitions required to specify the application(s) and response time goal(s).
3. Restart the Shadow Mainframe Adapter Server to make the Mainframe Adapter Client response time monitoring definitions effective.

## Step 1: Setting the Product Parameter

Before starting the Shadow Mainframe Adapter Server, use the following **MODIFY PARM** command to set the product parameter within the Shadow Mainframe Adapter Server initialization EXEC, SDBxIN00:

```
"MODIFY PARM NAME(MONRESPONSETIME) VALUE(YES) "
```

Where:

### **MONRESPONSETIME**

Must be set to YES to enable Mainframe Adapter Client response time monitoring support.

## Step 2: Creating the Definitions

Add the following **DEFINE** command to the Shadow Mainframe Adapter Server initialization EXEC, SDBxIN00 in order to specify each application name and response time goal for that application:

```
"DEFINE RTMONAPP APPLICATION(appname) ",  
"TIME(time) "
```

Where:

### **appname**

Specifies the application using one of the following:

- Application name (see “Application Names” on page 14-3)
- Internal name
- Module name

### **time**

Specifies the response time goal (in milliseconds).

**Note:**

You can specify up to 30 applications to monitor.

## Application Names

You can specify the application name by setting the APNA (Application Name) keyword to the appropriate value. The application name is sent to the host as part of the logon information. It is normally used to group SQL statements within a plan. If the Application Name is not set, all of the SQL associated with a plan will be considered to be part of one large group.

## Step 3: Restarting Shadow Mainframe Adapter Server

You must restart the Shadow Mainframe Adapter Server for any changes to the application and response time goal definitions to become effective.

## Viewing Mainframe Adapter Client Response Time Information

When the Mainframe Adapter Client response time exceeds the goal value, an exception event results, which can be used to trigger the SMF recording, which will write SMF records related to the Mainframe Adapter Client response time.

## SMF Recording

You can enable SMF recording to write SMF records each time the Mainframe Adapter Client response time exceeds the goal value.

### Prerequisites

- You must enable the Mainframe Adapter Client response time monitor by setting the product parameter and creating the definitions (see “Enabling Mainframe Adapter Client Response Time Monitoring” on page 14-2).
- To enable Shadow SMF recording, you must specify the following parameter within the Shadow Mainframe Adapter Server initialization EXEC, SDBxIN00:

```
"MODIFY PARM NAME(SMFNUMBER) VALUE(XXX)"
```

Where XXX is a number between 000 and 255. If the parameter is set to zero, no logging takes place.

## Viewing SMF Records

The Mainframe Adapter Client response time monitoring feature will write SMF type 14 records. For more information about SMF records and a table describing the offset, field name, field type/value, and description of the Mainframe Adapter Client response time SMF type 14 records, see Chapter 7, “Shadow Mainframe Adapter Server: Data Mapping Facility (DMF),” of this guide.

# Shadow Interface for DB2 Administration





# CHAPTER 15: **Shadow Interface for DB2: Using DB2 Stored Procedures**

---

This chapter guides you through the process of using DB2 stored procedures to access z/OS data, a feature of the Shadow Mainframe Adapter Server, the Mainframe Adapter Server component of the ShadowConnect product.

Topics include:

- Using a DB2 Stored Procedure to Access z/OS Data
  - Prerequisites
  - Preparing a DB2 Stored Procedure
  - Invoking a Stored Procedure
  - Returning Results Sets
  - Using SET CURRENT PATH
  - Troubleshooting DB2 Stored Procedures
  - Samples

## **Using a DB2 Stored Procedure to Access z/OS Data**

The following topics regarding DB2 stored procedures are covered:

- Prerequisites
- Preparing a DB2 Stored Procedure
- Invoking a Stored Procedure
- Returning Results Sets
- Using SET CURRENT PATH
- Troubleshooting DB2 Stored Procedures
- Samples

### ***Prerequisites***

DB2 stored procedures are fully supported by Shadow if the required prerequisites are met.

#### **The Shadow**

Shadow must be at least at v3.1 SVFX3270 and above to support DB2 stored procedures.

#### **DB2**

If you are running DB2 stored procedures, you must be at DB2 v4.1 or above.

**Doc Reference:**

For specific information on writing and using DB2 stored procedures, please refer to the *IBM DB2 Application Programming and SQL Guide*.

## Preparing a DB2 Stored Procedure

You must complete the following steps *on the host side* to properly prepare a DB2 stored procedure:

1. Depending on the version of DB2, do the following:
  - **DB2 v4.1 or v5.1:** Update the DB2 SYSIBM.SYSPROCEDURES table with information regarding the stored procedure.
  - **DB2 v6.1 or above:** The CREATE PROCEDURE statement must be issued to create the DB2 stored procedure.

If any of this information changes, you *must* stop the DB2 stored procedure and restart it using the DB2 **-START** and **-STOP PROCEDURE** command. If you don't, the changes will not take effect.
2. Run the DB2 pre-compiler against the DB2 stored procedure to create the DBRM.
3. Compile the DB2 stored procedure.
4. Link-edit the DB2 stored procedure. The DB2 stored procedure must be placed in a library in the STEPLIB of the DB2 stored procedure address space.
5. Bind the DB2 stored procedure into a DB2 package.
6. You may need to bind the DB2 package for the DB2 stored procedure with the DBRM used by Shadow Mainframe Adapter Server, depending on your version of DB2, as follows:
  - **DB2 v4.1 or v5.1:** You must bind the DB2 package used by the DB2 stored procedure with the DBRM used by Shadow (OPRXSQ) in order for the DB2 stored procedure to be called successfully. This is required only once as long as new stored procedures are all added to the same packlist.
  - **DB2 v6.1 or above:** If the DB2 stored procedure is being executed from the same location, the package for the DB2 stored procedure does not need to be included with the DB2 plan with which you are connecting; however, you will still need to connect using the standard Shadow DB2 plan containing the DBRM used by Shadow (OPRXSQ).

**Note:**

If the 4th character of the plan name is any character other than “R,” “S,” or “U,” the Shadow Mainframe Adapter Client assumes that your application is using a plan that was bound using an isolation level of Cursor Stability.

## Invoking a Stored Procedure

After preparing the stored procedure, you must invoke it.

The syntax for invoking a DB2 stored procedure is as follows:

```
Call schema.procedure-name(parameter,parameter,...)
```

Where:

**schema**

This is the schema as defined in the DB2 SYSIBM.SYSROUTINES table. The schema name specified depends on your version of DB2, as follows:

- **For DB2 v4.1 and v5.1:** This defaults to SYSPROC and must be specified.
- **For DB2 v6.1 or above:** For support of schema names other than SYSPROC, you must be running Shadow Mainframe Adapter Server v4.5 SVFX1691 or above.

**procedure-name**

This is the procedure name in the DB2 catalog.

**parameter**

These are the parameters for the DB2 stored procedures.

This syntax matches the IBM SQL stored procedure naming conventions.

## Returning Results Sets

Shadow supports returning zero or multiple result sets from an IBM DB2 stored procedure. For multiple result set support, you must be running Shadow Mainframe Adapter Server v4.5 SVFX1051 or above. If you are not using the correct level of code and if the DB2 stored procedure returns more than one result set, the remaining result sets are ignored (without any error messages or warnings).

### Coding Cursors in Return Result Sets

Certain issues apply when you are running a DB2 stored procedure that returns a result set. If a COMMIT is performed after a DB2 stored procedure is executed

and before the result set is fetched, the result set will be lost. Since this is a DB2 restriction, there are several options available:

- Before calling the DB2 stored procedure, turn off auto-commit within the Mainframe Adapter Client application.
- Code WITH HOLD in your DB2 stored procedures cursor declarations. When coding DB2 stored procedures, the cursors used in stored procedures should be declared WITH HOLD in addition to WITH RETURN. Otherwise, any COMMIT (either issued by DB2 or by Shadow Mainframe Adapter Server) will destroy the result set(s). If WITH HOLD is not specified and if COMMIT\_ON\_RETURN is set to Y in SYSIBM.SYSPROCEDURES, each stored procedure will not appear to return any result sets, *even if it actually does*.

The following is an example of an EXEC SQL statement in a DB2 stored procedure:

```
EXEC SQL

      DECLARE C1 CURSOR WITH HOLD WITH RETURN

      FOR SELECT ID, NAME, DEPT, JOB,

              YEARS, SALARY, COMM

      FROM Q.STAFF

END-EXEC.
```

However, this has a drawback. Since the cursor is defined as WITH HOLD, a lock will remain on the table in order to preserve the cursor positioning until a ROLLBACK is issued. A ROLLBACK would need to be issued by the Mainframe Adapter Client application to free any locks. A COMMIT will *not* free all the locks.

- Set the Shadow Mainframe Adapter Server parameter AUTOCOMMITCALL to NO, as follows:

```
MODIFY PARM NAME(AUTOCOMMITCALL) VALUE(NO)
```

where:

#### **AUTOCOMMITCALL**

Controls whether or not a COMMIT should be automatically executed after a Shadow or IBM DB2 stored procedure completes execution. The COMMIT is only done if this parameter is set to YES and if AUTO-COMMIT is active for the current host connection. The COMMIT will complete any pending database changes and release some (but not all) locks; however, the COMMIT will also destroy pending result sets for IBM DB2 stored procedures unless the cursors for the IBM DB2 stored procedure result sets are declared with HOLD.

This will cause the Shadow Mainframe Adapter Server to *not* issue a COMMIT immediately after the DB2 stored procedure is executed. Instead, you will get a COMMIT (as long as you are running in auto-commit mode) at the point of the CLOSE-CURSOR after the result set has been fetched.

## Retrieving Column Names

If you want to retrieve column names from any DB2 stored procedures that return result sets, the DESCSTAT DB2 installation parameter *must* be set to YES. (DESCSTAT is set in the DB2 DSNZPARM member at DB2 install time. DSNZPARM is created via the DB2 installation job DSNTIJUZ.)



### Note:

If the DESCSTAT DB2 installation parameter is *not* set to YES, the result set column names will *always* be zero length strings. Some IBM documentation incorrectly implies that this is a BIND parameter. It is not a BIND parameter and must be set as part of the installation of DB2.

## Using SET CURRENT PATH

Shadow supports the SET CURRENT PATH statement as of Shadow Mainframe Adapter Server v4.5 SVFX1976 and above.



### Note:

The SET CURRENT PATH statement executed from the Shadow Mainframe Adapter Client can, at any time, change the current path for all future SQL operations for that connection. The SET CURRENT PATH statement can be executed via the Shadow Mainframe Adapter Client as any other dynamic SQL statement.

Each schema name specified on the SET CURRENT PATH statement can be any valid string up to eight bytes. The SET CURRENT PATH statement can be issued with or without an equal operator between the command and the schema name. In the following example, both statements are valid:

```
SET CURRENT PATH = SYSPROC
SET CURRENT PATH SYSPROC
```

The current path can be up to 254 bytes long, and specify multiple schema names all separated by a comma, as shown in the following example:

```
SET CURRENT PATH = SYSPROC, AI38AAS, AI38KPO

SET CURRENT PATH = NEON, SYSPROC, AI38AAS
```

**Doc Reference:**

For more information on the DB2 SET CURRENT PATH command or information on the SQL path, please reference the *DB2 UDB for OS/390 SQL Reference* manual.

## Troubleshooting DB2 Stored Procedures

Be aware of the following situations that can arise when executing DB2 stored procedures:

- **0 SQLCODE:** It is common to get a 0 (zero) SQLCODE from a stored procedure that actually failed because it could not access the associated package (timestamp errors, etc.). The reason is that all of the DB2 operations attempted by the stored procedure failed and there is no indication why.

In addition, a 0 (zero) SQLCODE can also result from a DB2 stored procedure that is designed to return one or more results sets for at least two reasons:

- All of the EXEC SQL statements in the stored procedure are failing because the required package is not available.
- The cursors used to return the result sets were not declared with WITH HOLD and COMMIT\_ON\_RETURN is set to Y.
- **-204 SQLCODE:** A -204 SQLCODE indicates that the DB2 stored procedure name is unknown to DB2. Unlike Shadow stored procedures, all IBM DB2 stored procedures must be defined in the DB2 catalog.
- **-440 SQLCODE:** A -440 SQLCODE indicates the parameters passed by the application do not match the parameter definitions in the DB2 catalog.
- **-480 SQLCODE:** A -480 SQLCODE indicates that the stored procedure created one or more results without using WITH HOLD cursors and a subsequent COMMIT issued by Shadow Mainframe Adapter Server destroyed those result sets before the DESCRIBE PROCEDURE was completed.
- **+466 SQLCODE:** All stored procedures that actually create result sets exit with a +466 SQLCODE unless the result set is destroyed by a COMMIT (as described in “Coding Cursors in Return Result Sets” on page 15-3). This is neither an error nor a warning. It just means the stored procedure successfully created at least one result set.

## Samples

The following samples are available with the Shadow Interface for DB2:

- **Result Set.** A sample job, DB2PROC1, has been provided in the NEON.SV040800.CNTL dataset that shows how to properly compile and bind a DB2 stored procedure that returns a result set. This sample processes the example stored procedure, DB2PROC1, in the NEON.SV040800.SAMP dataset.
- **Output Parameter.** A sample job, DB2PROC2, has been provided in the NEON.SV040800.CNTL dataset that shows how to properly compile and bind a sample DB2 stored procedure that returns an output parameter. This sample processes the example stored procedure, DB2PROC2, in the NEON.SV040800.SAMP dataset.





**CHAPTER 16:**

# **Shadow Interface for DB2: Shadow Enterprise Transactions (Two-Phase Commit)**

---

---

This chapter provides information for using Shadow Enterprise Transactions (two-phase commit), a licensed feature of Shadow Mainframe Adapter Server, the Mainframe Adapter Server component of the Shadow product.

Topics include:

- Overview
  - RRMS and the Two-Phase Commit
- Prerequisites
  - System Requirements
  - Environment Requirements
  - Choosing an Attachment Facility
- Enabling Two-Phase Commit
  - Shadow Interface for DB2
  - Shadow Mainframe Adapter Server
  - Shadow Mainframe Adapter Client
- Monitoring and Controlling RRS Transactions
  - Displaying Resource Manager Information
  - Displaying Information on Active Transactions
  - Displaying information on Indoubt Transactions
  - Displaying Recovery Table Information
  - Displaying RRS Units of Recovery Information
- Running RRS

## **Overview**

Two-phase commit support is a feature of Shadow Enterprise Transactions™, an optional licensed component of the Shadow Enterprise Transactions supports a variety of two-phase commit protocols, with support for IBM's OS/390 Recovery Resource Management Services (RRMS). This includes the use of the Recoverable Resource Services Attach Facility (RRSAF).

Distributed transactions use a two-phase commit protocol to synchronize related pieces of work that take place in different processes or in different data sources.

The protocol guarantees that the work is either successfully completed by all the processes or not performed at all. The goal is to ensure that each participant in a transaction takes the same action (both are committed or both are rolled back).

After all of the work of the transaction is complete, the application attempts to commit the work by invoking the two-phase commit protocol.

A common example for the use of two-phase commit is a banking application in which a customer wants to transfer a certain amount of money from his savings account to his checking account. Either both updates must be made or neither of them should be made. The protected resource, or in this case the amount being transferred, must hold its integrity in case of hardware or software failures, communication failures, human errors, or a catastrophe.

## ***RRMS and the Two-Phase Commit***

The Shadow product on OS/390 implements two-phase commit through integration with IBM's OS/390 Recoverable Resource Management Services (RRMS). RRMS enables transactional access to a diverse set of resources on OS/390. RRMS also enables transactional resources to resources outside of OS/390 through distributed transaction coordinators.

With the Shadow support of RRMS and distributed transactions available with Shadow 4.8, transactions originating from the Shadow Mainframe Adapter Client can provide updates to DB2 on the mainframe side; other OS/390 and z/OS data sources and transactional resources, including IMS and CICS; and other data sources off the mainframe. Shadow on the OS/390 or z/OS side functions as a local transaction coordinator, communicating with the Mainframe Adapter Client side transaction manager (typically Microsoft MTS or BEA Tuxedo) to allow distributed transactions using the two-phase commit protocol.

### **The RRSAF Component**

The Recoverable Resource Services Attach Facility (RRSAF) is a component of RRMS that allows an OS/390 or z/OS address space to connect to DB2. Significantly, it works with RRMS, allowing updates to a DB2 system to become part of a transaction managed by RRMS. RRSAF also enables two-phase commit to be used by CICS/TS and IMS/TM to coordinate updates to local data sources on the OS/390 platform and to coordinate updates between two distributed data sources, such as Oracle and Sybase.

Before RRSAF, CAF was the primary method provided by DB2 for a non-IBM address space to connect to DB2. CAF is still supported by DB2 and Shadow; however, it does not provide support for distributed transactions. CAF doesn't provide a good facility for reusing connections, and it doesn't provide adequate security for most customers. Using CAF would force all DB2 requests to be under the userid of the Web Server rather than the userid of the actual request. RRSAF provides that "request-level" facility.

## **Prerequisites**

Before using Shadow's two-phase commit support, there are some important factors to be considered. These include the following:

- System requirements
- Environment requirements
- Choosing an attachment facility
- Enabling RRS

## System Requirements

You will need the following system requirements:

- **DB2 v 5.1 or higher.** If a single copy of Shadow must also access a DB2 system at an earlier release, you cannot use RRSAF with that copy of Shadow.
- **Shadow Mainframe Adapter Server v 4.5 or higher.** The Mainframe Adapter Server can use either CAF or RRSAF, but not both. You must choose the method at startup. It cannot be changed without restarting the Mainframe Adapter Server.
- **OS/390 RRS installed and running.** If RRS is not running, all RRSAF requests are rejected by DB2.
- **System Logger Log Streams.** The log streams can either use the coupling facility or be DASD-only. To use DASD-only log streams, you must be at OS/390 release 2.4 or later and put on the following two PTFs:
  - UW43929
  - UW43930



**Note:**

Before OS/390 release 4, the System Logger did not support DASD-only log streams.

## Environment Requirements

You should determine whether you will be using two-phase commit with only DB2, or if you will also be using two-phase commit with IMS or CICS. Each subsystem has certain configuration requirements. Since two-phase commit is an overhead, you want to only enable what is necessary for the subsystem you are using. Everything else should be disabled.

## Choosing an Attachment Facility

Use the following guidelines to help you decide whether to use RRSAF or CAF:

- If you are using CAF and have a virtual storage shortage below 16MB, try RRSAF. It uses more than 2K less per user than CAF and could free up the necessary storage (potentially over 2MB below 16MB storage when over 1,000 DB2 threads are in use).

- If you wish to do distributed two-phase commit transactions using Shadow with DB2 as one of the data sources, you *must* choose RRSAF as the Shadow attachment method.
- If only a small percentage of DB2 updates need two-phase commit transaction support, consider creating a separate copy of Shadow for those updates, and use RRSAF with that copy.
- RRSAF can also be used to improve performance by eliminating the need to have Shadow Mainframe Adapter Server enqueue on DSNALI OPEN-THREAD operations. With RRSAF active, customers can set the Shadow Mainframe Adapter Server AUTOUSERID parameter to NO to eliminate these enqueue operations. RRSAF allows for a sign on operation, which was not supported using CAF. In addition, setting AUTOUSERID to NO eliminates certain problems encountered with OS/390 or z/OS security products.
- RRSAF offers improved performance when used in conjunction with the Shadow Mainframe Adapter Server REUSETHEADS parameter. Since RRSAF allows for the use of a sign-on API, DB2 threads no longer have to be closed and reopened to correctly set the authid when the connection is obtained from the Mainframe Adapter Server's pooled connections.



**Note:**

You must decide which attachment facility to use before initialization time. The attachment facility cannot be changed after initialization.

## Enabling Two-Phase Commit

Enabling two-phase commit involves the following Shadow Components:

- Shadow Interface for DB2
- Shadow Mainframe Adapter Server
- Shadow Mainframe Adapter Client

### ***Shadow Interface for DB2***

If you are a DB2 user, you just have to check with your systems programmer to make sure that RRS has been enabled on the mainframe.

### ***Shadow Mainframe Adapter Server***



**Note:**

The use of RRSAF with Shadow's two-phase commit support requires a Shadow license; however, you do not need a Shadow license if you are using RRSAF with DB2.

Before using two-phase commit, the following requirements must be met:

1. Obtain RACF resource class access.
2. Obtain RRSF resource access.
3. Modify the Shadow Mainframe Adapter Server parameters.

### ***Step 1: Obtain RACF Resource Class Access***

In order for the Shadow Mainframe Adapter Server address space to communicate with RRS, the Shadow Mainframe Adapter Server address space ID needs to have ALTER access to the following RACF resource class:

```
MVSADMIN.RRS.COMMANDS
```



**Note:**

Failing to grant the appropriate access for the Shadow Mainframe Adapter Server address space ID may result in failures within the Shadow Mainframe Adapter Server to properly define its resource manager.

The following RACF commands should be issued by your RACF administrator:

1. Provide access to the resource according to the following example:

```
permit MVSADMIN.** class(facility) id(SDBB) access(alter)
```

Where SDBB is the name of your Shadow Mainframe Adapter Server address space.

2. Refresh the facility class by issuing the following command:

```
setropts refresh class(facility) recast
```

### ***Step 2: Obtain RRSF Resource Access***

In order for applications to be able to connect to DB2 via RRSF, they need to be authorized for the following RRSF resource:

```
ssnm.RRSF
```

Where `ssnm` is the DB2 subsystem ID.



**Note:**

If this resource is not yet defined to your security product, connections to DB2 via RRSF may fail.

The following steps should be completed to grant the appropriate access (for more detailed information regarding defining this resource class, see the *DB2 Administration Guide*):

1. If you have not already established a profile for controlling access from the RRS attachment, define `ssnm.RRSAF` in the DSNR resource class with a universal access authority of `NONE`, as shown in the following command:

```
RDEFINE DSNR (ssnm.RRSAF) UACC(NONE)
```

**Note:**

Optionally, you could define the resource class with a universal access authority of `READ`, so everyone would be authorized to access DB2 via RRSAF. This would eliminate step 3 or any administrative overhead.

2. Activate the resource class using the following command:

```
SETROPTS RACLIST(DSNR) REFRESH
```

3. Provide access to the resource according to the following example:

```
PERMIT ssnm.RRSAF CLASS(DSNR) ID(SYSDSP) ACCESS(READ)
```

Where `SYSDSP` is the userid of the user to whom you wish to grant `READ` permissions.

### ***Step 3: Modify Shadow Mainframe Adapter Server Parameters***

Set the following parameters on the Shadow product within the Shadow Mainframe Adapter Server initialization EXEC, `SDBxIN00`:

**Note:**

The asterisks indicate the parameters you need to set if you are using RRSAF with DB2. If you are using RRSAF with two-phase commit, you must set all of the following parameters.

```
* "MODIFY PARM NAME(RRS) VALUE(YES)"
* "MODIFY PARM NAME(DB2ATTACHFACILITY) VALUE(XXX)"
"MODIFY PARM NAME(RESOURCEMGRNAME) VALUE(NEONRMAAAAAA)"
"MODIFY PARM NAME(RECTABLEENTRIES) VALUE(XXX)"
"MODIFY PARM NAME(TRACERRSEVENTS) VALUE(YES)"
"MODIFY PARM NAME(TRACEFULLRRSDATA) VALUE(NO)"
* "MODIFY PARM NAME(AUTOUSERID) VALUE(NO)"
```

Where:

**RRS**

Is set to `YES` to initialize RRS support.

**DB2ATTACHFACILITY**

Allows the user to control which mechanism to use for the DB2 interface. Possible values are as follows:

- **CAF:** Use the classic Call Attach Facility (CAF).
- **RRS:** Use the new option of Recoverable Resource Services Attach Facility (RRSAF).

 **Notes:**

- You must decide which attachment facility to use before initialization time. The attachment facility cannot be changed after initialization.
- (For users running OS/390 2.7 or below) If you have set DB2ATTACHFACILITY to RRS and you are getting the -925 or -926 return codes from COMMIT/ROLLBACK, you should then set RRS2PCALL to YES. This should resolve the problem.

**RESOURCEMGRNAME**

May be set to the unique sysplex name of the RRS resource manager, which is a Mainframe Adapter Server Distributed Syncpoint Manager (SDSRM). If a default value is not specified, product initialization creates a 32 character name as follows:

- Chars 1-24: NEONRRS.RESOURCE.MANAGER
- Chars 25-28: The Shadow subsystem name (SDBA, SDBB, etc.)
- *Chars 29-32: System SMF ID*

If the name is changed after the system is operational, any incomplete (indoubt) transactions from the previous run will not be able to be completed.

**RECTABLEENTRIES**

May be set to specify the maximum number of entries in the RRS recovery table. The range is from 200 to 400, with 400 being the default value. If the maximum size of the table is exceeded, information on indoubt transactions will be lost.

**TRACERRSEVENTS**

May be set to YES to enable RRS events to be traced via the Trace Browse Facility.

**TRACEFULLRRSDATA**

May be set to NO if you do not want the entire RRS workarea to be traced for RRS events using the Trace Browse Facility. When set to NO, only the amount of data that will fit in a standard message block will be traced.

**AUTOUSERID**

Should be set to NO if you are using DB2. This will eliminate certain enqueue operations required to properly set the DB2 authid at DSNALI OPEN-THREAD time.

## Shadow Mainframe Adapter Client

All users must set the keywords shown in Table 16–1.

**Table 16–1. Shadow Mainframe Adapter Client Keywords for Enabling Two-Phase Commit Support**

Keyword	Description	Value
XAEN (X/OPEN XA Support)	This keyword should be set if the target Mainframe Adapter Server will participate in an X/OPEN XA transaction. The value TWO-PHASE should be used in a situation where the transaction involves more than one resource manager and the target Mainframe Adapter Server supports the two-phase commit protocol. The value TWO-PHASE also allows for the one-phase commit scenario whenever the coordinator thinks it is appropriate. The default is NONE, which implies that no part of the transaction will use the XA protocol.	TWO-PHASE
XAOP (X/OPEN XA Transaction Manager)	This keyword is used to set the XA transaction manager type. This option must be set correctly when participating in a distributed transaction coordinated by a monitor. MSDTC, the Microsoft Distributed Transaction Manager, is used mostly by the MTS applications. Two possible values are available for a BEA Tuxedo coordinated transaction: TUXEDO-TMS identifies that the ODBC connection will be owned by the Tuxedo TMS Mainframe Adapter Server and TUXEDO-SQL identifies that the ODBC connection will be owned by the Tuxedo SQL application Mainframe Adapter Server. The default is NONE, which means that this is not a distributed transaction	TUXEDO-TMS, TUXEDO-SQL, MSDTC, or JTS



### Doc Reference:

For more information about Shadow Mainframe Adapter Client keywords, see Appendix A, “Shadow Mainframe Adapter Client Keywords,” of the *Shadow Mainframe Adapter Client Administration Guide*.

## Monitoring and Controlling RRS Transactions

With the RRS Monitor and Control Database Access application (Figure 16–2), you can view and control the Shadow Mainframe Adapter Server RRS manager and all in-progress two-phase commit protocol transactions that are managed by Shadow.

This feature provides the following options:

- Display resource manager information.



- Display information on active transactions.
- Display information on indoubt transactions.
- Display the recovery table.
- Display information on RRS Units of Recovery.
- Display details of the RRCO control block.

## Displaying Resource Manager Information

The Shadow Mainframe Adapter Server Resource Manager application provides information about the Shadow Mainframe Adapter Server RRS resource manager. RRS is a z/OS component that uses two-phase commit protocol to manage transaction processing across multiple data sources. When Shadow two-phase commit support is enabled, Shadow registers its resource manager with RRS. The Shadow resource manager must be up and connected to RRS for Shadow two-phase commit transaction processing to take place.

### Available Commands

The Resource Manager application supports all four scrolling commands (**UP**, **DOWN**, **LEFT**, **RIGHT**) and their PF key equivalents or scroll bar equivalents. It also supports the primary **SORT** and **LOCATE** commands.

In addition, the ISPF and Shadow Web Interface applications support the commands shown in Table 16–2.

**Table 16–2. Resource Manager Commands**

Command Description	ISPF	Web Interface
Disables the Shadow Resource Manger logically.	D	Disable
Enables the Shadow Resource Manger logically.	E	Enable
Formats the information.	F	Format
Prints the control block.	P	N/A
Displays the control block for the selected row.	S	Block

To use the Resource Manager commands, do one of the following:

- **ISPF panels:** Type the command to the left of the line and press ENTER.
- **Shadow Web Interface:** Click on the selected command.

### Column Names

Table 16–3 provides a description for each column name on the ISPF panels as well as the Shadow Web Interface screen. Sort names are provided for users of the ISPF panels.

**Table 16–3. Resource Manager Column Names**

Column Name	Description	Sort Name (ISPF only)
RRS RESOURCE MANAGER NAME	Name of the Shadow RRS resource manger.	
RRS STATUS	Status of the Shadow Resource Manager application with RRS. This value can be one of the following: <ul style="list-style-type: none"> <li>ACTIVE</li> <li>DOWN</li> <li>NO RRS (the Shadow RRS parameter has not been selected)</li> </ul>	
NEON STATUS	The logical status of the Shadow RRS connection (which can be set by the user). This value can be one of the following: <ul style="list-style-type: none"> <li>ENABLED (allows normal transaction processing)</li> <li>DISABLED (new RRS transactions are prevented from starting)</li> </ul>	
TRANSACTIONS STARTED	Number of transactions started successfully.	
COMMITTS NORMAL	Number of transactions committed normally.	
COMMITTS RECOVERY	Number of transactions committed using the XA recover command.	
COMMITTS PANEL	Number of transactions committed manually using the Shadow panels.	
ROLLBACKS NORMAL	Number of transactions rolled back normally.	
ROLLBACKS RECOVERY	Number of transactions rolled back using the XA recover command.	
ROLLBACKS PANEL	Number of transactions rolled back manually using the Shadow panels.	

## Invoking the Shadow Mainframe Adapter Server RRS Manager Display for ISPF Users

To start the Resource Manager application, do the following:

1. From the **Shadow Mainframe Adapter Server Primary Option Menu**, select Option 8, Databases.
2. Press ENTER. The system displays the **Monitor and Control Database Access** panel, shown in Figure 16–1.

```

----- Monitor and Control Database Access ----- Subsystem SDBW
OPTION  ===>

  1  Databases           - Display and control Database Table
  2  Monitor             - Display Shadow Mainframe Adapter Server performance data
  3  RRS                 - Monitor and control RRS (transactions)

```

**Figure 16–1. Monitor and Control Database Access**

3. From this menu, select Option 3, RRS.
4. Press ENTER. The system displays the **Shadow Mainframe Adapter Server RRS Monitor** panel, shown in Figure 16–2.

```

----- Shadow Mainframe Adapter Server RRS Monitor -----
- Subsystem SDBW
OPTION  ===>

  1  Resource Manager    - Resource manager information
  2  Active Transactions - Information on active transactions
  3  Indoubt Transactions - Information on indoubt transactions
  4  Recovery Table      - Display of recovery table
  5  Units of Recovery   - Information on RRS Units of Recovery

```

**Figure 16–2. Shadow Mainframe Adapter Server RRS Monitor**

5. From this menu, select Option 1, Resource Manager.
6. Press ENTER. The system displays the **Shadow Mainframe Adapter Server RRS Resource Manager** panel, shown in Figure 16–3.

```

----- Shadow Mainframe Adapter Server RRS Resource Manager ----- SCR
1 ROW 1 OF 1
COMMAND  ===>                                SCROLL  ===> PAGE
Line Commands:  D Disable  E Enable  F Format CB  P Print CB
                S Show CB

RESOURCE MANAGER          RRS          NEON
NAME                      STATUS      STATUS          NOTE

```

**Figure 16–3. Shadow Mainframe Adapter Server RRS Resource Manager**

There are two panels that comprise this application. Use the **LEFT** and **RIGHT** scroll commands (or PF keys) to shift between them.

7. Use the available line commands in Table 16–2 on page 16-9 to perform the appropriate function(s).

## Invoking the Shadow Mainframe Adapter Server RRS Manager Display for Shadow Web Interface Users

To start the Resource Manager application, do the following:

1. From the main menu, select **RRS** → **Resource Manager**. The system displays the **Resource Manager** screen, as shown in Figure 16–4.

Actions	Resmgr Name	Rrs State	Neon State	Res Mgr Trxn Starts	Res Mgr Nrml Cmmits	Res Mgr Recv Cmmits	Res Mgr Panl Cmmits	Res Mgr Nrml Cmmits	Res Mgr Recv Cmmits	Res Mgr Panl Cmmits	Res Mgr Req Cmmits	Res Mgr Req Bkouts
<a href="#">DISABLE</a> , <a href="#">ENABLE</a> , <a href="#">Format</a> , <a href="#">Block</a>	NEONRMSDBB	ACTIVE	Enabled	0	0	0	0	0	0	0	507	

**Figure 16–4. Shadow Web Interface RRS Control**

2. Use the available commands in Table 16–2 on page 16-11 to perform the appropriate function(s).

## Displaying Information on Active Transactions

The Shadow Mainframe Adapter Server Active Transactions application allows the viewing of all active RRS transactions running in Shadow.

### Available Commands

The Active Transactions application supports all four scrolling commands (**UP**, **DOWN**, **LEFT**, **RIGHT**) and their PF key equivalents or scroll bar equivalents. It also supports the primary **SORT** and **LOCATE** commands.

In addition, the ISPF and Shadow Web Interface applications support the commands shown in Table 16–4.

**Table 16–4. Active Transaction Commands**

Command Description	ISPF	Web Interface
Displays the z/OS threads participating in the transaction.	D	Display
Formats the information for the selected row.	F	Format
Prints the control block for the selected row.	P	N/A
Displays the control block for the selected row.	S	Block

To use the Active Transactions commands, do one of the following:

- **ISPF panels:** Type the command to the left of the line and press ENTER.
- **Shadow Web Interface:** Click on the selected command.

## Column Names

Table 16–5 provides a description for each column name on the ISPF panels as well as the Shadow Web Interface screen. Sort names are provided for users of the ISPF panels.

**Table 16–5. Active Transaction Column Names**

Column Name	Description	Sort Name (ISPF only)
GTRID LENGTH	The length of the XA global transaction ID.	
GLOBAL TRAN ID	The first 32 bytes of the XA global transaction ID.	GTRID
TRXN BEGIN TIME	The date and time when the transaction began running on Shadow on the z/OS system.	START
Mainframe Adapter Client USERID	The userid passed by the Mainframe Adapter Client.	USERID
RRS STATE	The state of the transaction according to RRS.	
TRANSACTION TYPE	The type of transaction manager on the Mainframe Adapter Client side that is coordinating this transaction: Tuxedo or MVS.	TMTYPE
NUMBER OF THREADS	The number of z/OS threads (1 to 8) participating in the transaction.	
RRSURID	The RRS-assigned Unit of Recovery ID for the first or only thread of this transaction. It can be used to correlate this transaction with an RRS UR.	URID
XID TOKEN	Shadow-assigned token associated with this transaction. It can be used with PROFILE and DISPLAY in the Trace Browse Facility.	XTOKEN
BQUAL LENGTH	The length of the XA branch qualifier.	
BQUAL VALUE	The first 32 bytes of the XA branch qualifier value, up until the last valid byte.	
GTRID 2ND HALF	The second 32 bytes of the XA global transaction ID, up until the last valid byte.	

## Invoking the Shadow Mainframe Adapter Server Active RRS Transactions Display for ISPF Panel Users

To start the Active Transactions application, do the following:

1. From the **Shadow Mainframe Adapter Server Primary Option Menu**, select Option 8, Databases.
2. Press ENTER. The system displays the **Monitor and Control Database Access** panel, shown in Figure 16–5.

```

----- Monitor and Control Database Access ----- Subsystem SDBW
OPTION  ===>

  1  Databases          - Display and control Database Table
  2  Monitor            - Display Shadow Mainframe Adapter Server performance data
  3  RRS                - Monitor and control RRS (transactions)

```

**Figure 16–5. Monitor and Control Database Access**

3. From this menu, select Option 3, RRS.
4. Press ENTER. The system displays the **Shadow Mainframe Adapter Server RRS Monitor** panel, shown in Figure 16–6.

```

----- Shadow Mainframe Adapter Server RRS Monitor -----
- Subsystem SDBW
OPTION  ===>

  1  Resource Manager   - Resource manager information
  2  Active Transactions - Information on active transactions
  3  Indoubt Transactions - Information on indoubt transactions
  4  Recovery Table     - Display of recovery table
  5  Units of Recovery  - Information on RRS Units of Recovery

```

**Figure 16–6. Shadow Mainframe Adapter Server RRS Monitor**

5. From this menu, select Option 2, Active Transactions.
6. Press ENTER. The system displays the **Shadow Mainframe Adapter Server Active Transaction** panel, shown in Figure 16–7.

```

----- Shadow Mainframe Adapter Server Active Transaction -----
SCR 1 ROW 1 OF 0
COMMAND  ===>                                SCROLL ===> PAGE
  Line Commands:  T Trace  F Format  P Print CB  S Show CB

GTRID          XA
LEN            GLOBAL TRANSACTION ID (GTRID) FIRST 32 BYTES          NOTE

```

**Figure 16–7. Shadow Mainframe Adapter Server Active Transaction**

There are three panels that comprise this application. Use the **LEFT** and **RIGHT** scroll commands (or PF keys) to shift between them.

- Use the available line commands in Table 16–4 on page 16-12 to perform the appropriate function(s).

## Invoking the Shadow Mainframe Adapter Server Active RRS Transactions Display for Shadow Web Interface Users

To start the Active Transactions application, do the following:

- From the main menu, select **RRS** → **Active Transactions**. The system displays the **Active Transactions** screen, as shown in Figure 16–8.

Actions	Xa Gtlen	Xa Gtrid	Trxn Start Time	Trxn Userid	Rrs State	Trxn mgr Type	Number Of Threads	Trxn Urid	Xid Token	Trxn Bqual Len	Trxn Bqual	Trxn Gtrid2

**Figure 16–8. Shadow Web Interface Active RRS Transactions**

- Use the available commands in Table 16–4 on page 16-12 to perform the appropriate function(s).

## Displaying information on Indoubt Transactions

The Shadow Mainframe Adapter Server Indoubt Transaction application displays Shadow RRS transactions that are in the indoubt state and allows the user to commit or rollback these transactions.



### **Note:**

The RRS transactions running under Shadow on z/OS may make up just one part of a larger transaction that is being coordinated by the Mainframe Adapter Client side transaction manager (BEA Tuxedo or MTS). Issuing a COMMIT or ROLLBACK here could leave the overall transaction, as well as its data, in an inconsistent state. Extreme care must be used with these commands.

## Available Commands

The Indoubt Transactions application supports all four scrolling commands (**UP**, **DOWN**, **LEFT**, **RIGHT**) and their PF key equivalents or scroll bar equivalents. It also supports the primary **SORT** and **LOCATE** commands.

In addition, the ISPF and Shadow Web Interface applications support the commands shown in Table 16–6.

**Table 16–6. Indoubt Transactions Commands**

Command Description	ISPF	Web Interface
Manually commit the transaction.*	C	Commit
Displays the z/OS threads participating in this transaction.	D	Display
Formats the information for the selected row.	F	Format
Prints the control block for the selected row.	P	N/A
	R	
Displays the control block for the selected row.	S	Block

\*. **Warning:** This can leave the overall Mainframe Adapter Client-side transaction and the data in an inconsistent state.

To use the Indoubt Transactions commands, do one of the following:

- **ISPF panels:** Type the command to the left of the line and press ENTER.
- **Shadow Web Interface:** Click on the selected command.

## Column Names

Table 16–7 provides a description for each column name on the ISPF panels as well as the Shadow Web Interface screen. Sort names are provided for users of the ISPF panels.

**Table 16–7. Indoubt Transactions Column Names**

Column Name	Description	Sort Name (ISPF only)
GLOBAL TRAN ID	The XA global transaction ID assigned by the Mainframe Adapter Client-side transaction manager.	GTRID
TRXN BEGIN TIME	The date and time when the transaction began running on Shadow on the z/OS system.	START
Mainframe Adapter Client USERID	The userid passed by the Mainframe Adapter Client.	USERID



**Table 16–7. Indoubt Transactions Column Names (continued)**

Column Name	Description	Sort Name (ISPF only)
RRS STATE	The state of the transaction according to RRS.	
TRANSACTION TYPE	The type of transaction manager on the Mainframe Adapter Client side that is coordinating this transaction: Tuxedo or MTS.	TMTYPE
NUMBER OF THREADS	The number of z/OS (1 to 8) threads participating in the transaction.	
RRS URID	The RRS-assigned Unit of Recovery ID for the first or only thread of this transaction.	URID
XID TOKEN	Shadow-assigned token associated with this transaction. It can be used with PROFILE and DISPLAY in the Trace Browse Facility.	XTOKEN
BQUAL LENGTH	The length of the XA branch qualifier.	
BQUAL VALUE	The first 32 bytes of the XA branch qualifier value, up until the last valid byte.	
GTRID 2ND HALF	The second 32 bytes of the XA global transaction ID, up until the last valid byte.	

## Invoking the Shadow Mainframe Adapter Server Indoubt RRS Transactions Display for ISPF Panel Users

To start the Indoubt Transactions application, do the following:

1. From the **Shadow Mainframe Adapter Server Primary Option Menu**, select Option 8, Databases.
2. Press ENTER. The system displays the **Monitor and Control Database Access** panel, shown in Figure 16–9.

```

----- Monitor and Control Database Access ----- Subsystem SDBW
OPTION  ===>

  1  Databases          - Display and control Database Table
  2  Monitor           - Display Shadow Mainframe Adapter Server performance data
  3  RRS               - Monitor and control RRS (transactions)

```

**Figure 16–9. Monitor and Control Database Access**

3. From this menu, select Option 3, RRS.
4. Press ENTER. The system displays the **Shadow Mainframe Adapter Server RRS Monitor** panel, shown in Figure 16–10.

```

----- Shadow Mainframe Adapter Server RRS Monitor -----
- Subsystem SDBW
OPTION ===>

1 Resource Manager      - Resource manager information
2 Active Transactions   - Information on active transactions
3 Indoubt Transactions  - Information on indoubt transactions
4 Recovery Table        - Display of recovery table
5 Units of Recovery     - Information on RRS Units of Recovery

```

**Figure 16–10. Shadow Mainframe Adapter Server RRS Monitor**

5. From this menu, select Option 3, Indoubt Transactions.
6. Press ENTER. The system displays the **Shadow Mainframe Adapter Server Indoubt Transaction** panel shown in Figure 16–11.

```

----- Shadow Mainframe Adapter Server Indoubt Transaction ----- SCR
1 ROW 1 OF 0
COMMAND ===>                                SCROLL ===> PAGE
Line Commands:  C Commit  T Trace  F Format CB  P Print CB
                R Rollback S Show CB

GTRID          XA
LEN            GLOBAL TRANSACTION ID (GTRID) FIRST 32 BYTES          NOTE

```

**Figure 16–11. Shadow Mainframe Adapter Server Indoubt Transaction**

There are three panels that comprise this application. Use the **LEFT** and **RIGHT** scroll commands (or PF keys) to shift between them.

7. Use the available line commands in Table 16–6 on page 16-16 to perform the appropriate function(s).

## Invoking the Shadow Mainframe Adapter Server Indoubt RRS Transactions Display for Shadow Web Interface Users

To start the Indoubt Transactions application, do the following:

1. From the main menu, select **RRS → Indoubt Transactions**. The system displays the **Indoubt Transactions** screen, as shown in Figure 16–12.

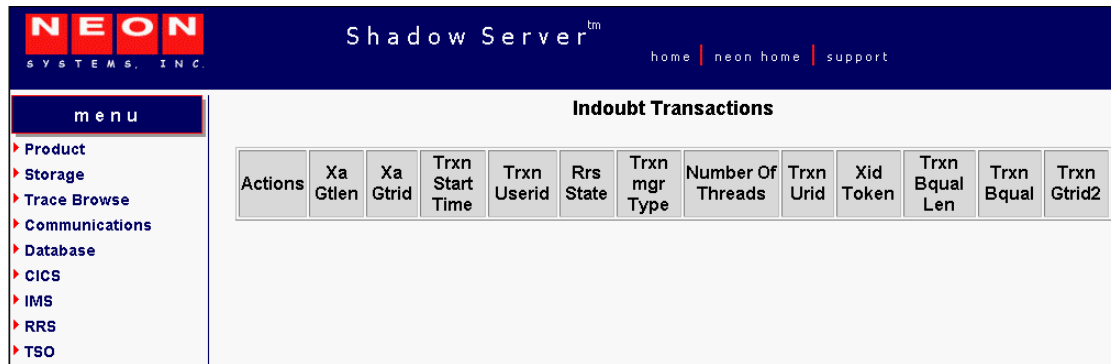

**Figure 16–12. Shadow Web Interface Indoubt RRS Transactions**

- Use the available commands in Table 16–6 on page 16-16 to perform the appropriate function(s).

## Displaying Recovery Table Information

The Shadow Mainframe Adapter Server Recovery Table application displays Shadow RRS transactions that have been put into the Shadow RRS recovery table due to failures of one type or another while the transaction was in progress.

### Available Commands

The Recovery Table application supports all four scrolling commands (**UP**, **DOWN**, **LEFT**, **RIGHT**) and their PF key equivalents or scroll bar equivalents. It also supports the primary **SORT** and **LOCATE** commands.

In addition, the ISPF and Shadow Web Interface applications support the commands shown in Table 16–8.

**Table 16–8. Recovery Table Commands**

Command Description	ISPF	Web Interface
Displays the z/OS threads participating in this transaction.	D	Display
Formats the information for the selected row.	F	Format
Prints the control block for the selected row.	P	N/A
Displays the control block for the selected row.	S	Block

To use the Recovery Table commands, do one of the following:

- **ISPF panels:** Type the command to the left of the line and press ENTER.
- **Shadow Web Interface:** Click on the selected command.

## Column Names

Table 16–9 provides a description for each column name on the ISPF panels as well as the Shadow Web Interface screen. Sort names are provided for users of the ISPF panels.

**Table 16–9. Recovery Table Column Names**

Column Name	Description	Sort Name (ISPF only)
GLOBAL TRAN ID	The XA global transaction ID assigned by the Mainframe Adapter Client-side transaction manager.	GTRID
TRXN BEGIN TIME	The date and time when the transaction began running on Shadow on the z/OS system.	START
Mainframe Adapter Client USERID	The userid passed by the Mainframe Adapter Client.	USERID
RRS STATE	The state of the transaction according to RRS.	
TRANSACTION TYPE	The type of transaction manager on the Mainframe Adapter Client side that is coordinating this transaction: Tuxedo or MTS.	TMTYPE
NUMBER OF THREADS	The number of z/OS (1 to 8) threads participating in the transaction.	
RRS URID	The RRS-assigned Unit of Recovery ID for the first or only thread of this transaction.	URID
XID TOKEN	Shadow-assigned token associated with this transaction. It can be used with PROFILE and DISPLAY in the Trace Browse Facility.	XTOKEN
BQUAL LENGTH	The length of the XA branch qualifier.	
BQUAL VALUE	The first 32 bytes of the XA branch qualifier value, up until the last valid byte.	
GTRID 2ND HALF	The second 32 bytes of the XA global transaction ID, up until the last valid byte.	

## Invoking the Shadow Mainframe Adapter Server Recovery Table Display for ISPF Panel Users

To start the Shadow Mainframe Adapter Server Recovery Table application, do the following:

1. From the **Shadow Mainframe Adapter Server Primary Option Menu**, select Option 8, Databases.
2. Press ENTER. The system displays the **Monitor and Control Database Access** panel, shown in Figure 16–13.

```

----- Monitor and Control Database Access ----- Subsystem SDBW
OPTION ===>

  1 Databases          - Display and control Database Table
  2 Monitor            - Display Shadow Mainframe Adapter Server performance data
  3 RRS                - Monitor and control RRS (transactions)

```

**Figure 16–13. Monitor and Control Database Access**

3. From this menu, select Option 3, RRS.
4. Press ENTER. The system displays the **Shadow Mainframe Adapter Server RRS Monitor** panel, shown in Figure 16–14.

```

----- Shadow Mainframe Adapter Server RRS Monitor -----
- Subsystem SDBW
OPTION ===>

  1 Resource Manager   - Resource manager information
  2 Active Transactions - Information on active transactions
  3 Indoubt Transactions - Information on indoubt transactions
  4 Recovery Table     - Display of recovery table
  5 Units of Recovery  - Information on RRS Units of Recovery

```

**Figure 16–14. Shadow Mainframe Adapter Server RRS Monitor**

5. From this menu, select Option 4, Recovery Table.
6. Press ENTER. The system displays the **Shadow Mainframe Adapter Server Recovery Transaction** panel, shown in Figure 16–15.

```

----- Shadow Mainframe Adapter Server Recovery Transaction ----- SC
1 ROW 1 OF 0
COMMAND ===>                                SCROLL ===> PAGE

  Line Commands:  T Trace  F Format CB  P Print CB  S Show CB

GTRID          XA
LEN  GLOBAL TRANSACTION ID (GTRID) FIRST 32 BYTES          NOTE

```

**Figure 16–15. Shadow Mainframe Adapter Server Recovery Transaction**

There are three panels that comprise this application. Use the **LEFT** and **RIGHT** scroll commands (or PF keys) to shift between them.

7. Use the available line commands in Table 16–8 on page 16-19 to perform the appropriate function(s).

## Invoking the Shadow Mainframe Adapter Server Recovery Table Display for Shadow Web Interface Users

To start the Shadow Mainframe Adapter Server Recovery Table application, do the following:

1. From the main menu, select **RRS** → **Recovery Transactions**. The system displays the **Recovery Transactions** screen, as shown in Figure 16–16.

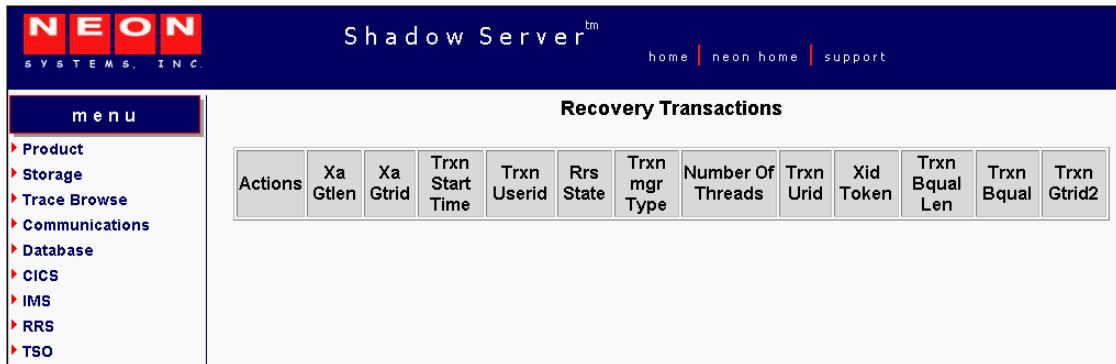

**Figure 16–16. Shadow Web Interface Recovery Transactions**

2. Use the available commands in Table 16–8 on page 16-19 to perform the appropriate function(s).

## Displaying RRS Units of Recovery Information

The Shadow Mainframe Adapter Server Units of Recovery application displays the RRS Units of Recovery (URs) associated with this copy of Shadow.

### Available Commands

The Units of Recovery application supports all four scrolling commands (**UP**, **DOWN**, **LEFT**, **RIGHT**) and their PF key equivalents or scroll bar equivalents. It also supports the primary **SORT** and **LOCATE** commands.

In addition, the ISPF and Shadow Web Interface application support the commands shown in Table 16–10.

**Table 16–10. RRS Units of Recovery Commands**

Command Description	ISPF	Web Interface
Formats the information for the selected row.	F	Format
Prints the control block for the selected row.	P	N/A
Displays the control block for the selected row.	S	Block

To use the Units of Recovery commands, do one of the following:

- **ISPF panels:** Type the command to the left of the line and press ENTER.
- **Shadow Web Interface:** Click on the selected command.

## Column Names

Table 16–11 provides a description for each column name on the ISPF panels as well as the Shadow Web Interface screen. Sort names are provided for users of the ISPF panels.

**Table 16–11. RRS Units of Recovery Column Names**

Column Name	Description	Sort Name (ISPF only)
GLOBAL TRAN ID	The XA global transaction ID assigned by the Mainframe Adapter Client-side transaction manager.	GTRID
TRXN BEGIN TIME	The date and time when the transaction began running on Shadow on the z/OS system.	START
Mainframe Adapter Client USERID	The userid passed by the Mainframe Adapter Client.	USERID
RRS STATE	The state of the transaction according to RRS.	
TRANSACTION TYPE	The type of transaction manager on the Mainframe Adapter Client side that is coordinating this transaction: Tuxedo or MTS.	TMTYPE
NUMBER OF THREADS	The number of z/OS (1 to 8) threads participating in the transaction.	
RRS URID	The RRS-assigned Unit of Recovery ID for the first or only thread of this transaction.	URID
XID TOKEN	Shadow-assigned token associated with this transaction. It can be used with PROFILE and DISPLAY in the Trace Browse Facility.	XTOKEN
BQUAL LENGTH	The length of the XA branch qualifier.	
BQUAL VALUE	The first 32 bytes of the XA branch qualifier value, up until the last valid byte.	
GTRID 2ND HALF	The second 32 bytes of the XA global transaction ID, up until the last valid byte.	
TCB ADDRESS	The initial TCB on which the UR ran. (Zero if the UR was from the recovery table.)	TCB
VCID	The VCID value assigned when this UR started.	VCID
PREPARE RET CODE	The return code from the RRS PREPARE operation. (N/A if the PREPARE operation has not been done).	
COMMIT RET CODE	The return code from the RRS COMMIT operation. (N/A if the RRS COMMIT operation has not been done).	

**Table 16–11. RRS Units of Recovery Column Names (continued)**

Column Name	Description	Sort Name (ISPF only)
ROLLBACK RET CODE	The return code from the RRS ROLLBACK operation. (N/A if the RRS ROLLBACK operation has not been done).	
FORGET RET CODE	The return code from the RRS FORGET operation. (N/A if the RRS FORGET operation has not been done).	
TRANSACTION FLAG 1	Transaction flag 1. Used by Shadow for diagnostics.	
TRANSACTION FLAG 2	Transaction flag 2. Used by Shadow for diagnostics.	
TRANSACTION FLAG 3	Transaction flag 3. Used by Shadow for diagnostics.	
TRANSACTION FLAG 4	Transaction flag 4. Used by Shadow for diagnostics.	
TRANSACTION FLAG 5	Transaction flag 5. Used by Shadow for diagnostics.	
DIAGNOSTIC FLAG 1	Diagnostic flag 1. Used by Shadow for diagnostics.	
DIAGNOSTIC FLAG 2	Diagnostic flag 2. Used by Shadow for diagnostics.	

## Invoking the Shadow Mainframe Adapter Server RRS Units of Recovery Display for ISPF Panel Users

To start the Shadow Mainframe Adapter Server RRS Units of Recovery application, do the following:

1. From the **Shadow Mainframe Adapter Server Primary Option Menu**, select Option 8, Databases.
2. Press ENTER. The system displays the **Monitor and Control Database Access** panel, shown in Figure 16–17.

```

----- Monitor and Control Database Access ----- Subsystem SDBW
OPTION  ====>

   1  Databases           - Display and control Database Table
   2  Monitor             - Display Shadow Mainframe Adapter Server performance data
   3  RRS                 - Monitor and control RRS (transactions)

```

**Figure 16–17. Monitor and Control Database Access**

3. From this menu, select Option 3, RRS.
4. Press ENTER. The system displays the **Shadow Mainframe Adapter Server RRS Monitor** panel, shown in Figure 16–18.



```

----- Shadow Mainframe Adapter Server RRS Monitor -----
- Subsystem SDBW
OPTION ===>

1 Resource Manager      - Resource manager information
2 Active Transactions   - Information on active transactions
3 Indoubt Transactions  - Information on indoubt transactions
4 Recovery Table        - Display of recovery table
5 Units of Recovery     - Information on RRS Units of Recovery

```

**Figure 16–18. Shadow Mainframe Adapter Server RRS Monitor**

5. From this menu, select Option 5, Units of Recovery.
6. Press **Enter**. The system displays the **Shadow Mainframe Adapter Server Units of Recovery** panel, shown in Figure 16–19.

```

----- Shadow Mainframe Adapter Server Units of Recovery D      SCR
1 ROW 1 OF 0
COMMAND ===>                                SCROLL ===> PAGE
Line Commands:  F Format CB  P Print CB  S Show CB  T Trace

GTRID          XA
LEN  GLOBAL TRANSACTION ID (GTRID) FIRST 32 BYTES          NOTE
*END*

```

**Figure 16–19. Shadow Mainframe Adapter Server Units of Recovery**

There are three panels that comprise this application. Use the **LEFT** and **RIGHT** scroll commands (or PF keys) to shift between them.

7. Use the available line commands in Table 16–10 on page 16-22 to perform the appropriate function(s).

## Invoking the Shadow Mainframe Adapter Server RRS Units of Recovery Display for Shadow Web Interface Users

To start the Shadow Mainframe Adapter Server RRS Units of Recovery application, do the following:

1. From the main menu, select **RRS** → **Recovery Transactions**. The system displays the **Units of Recovery** screen, as shown in Figure 16–20.

Rrs State	Trxn mgr Type	Number Of Threads	Trxn Urid	Xid Token	Trxn Bqual Len	Trxn Bqual	Trxn Gtrid2	Tcb Address	Vcid	Prepare rc	Commit rc	Rollbck rc	Forget rc	Trxn Flag1

**Figure 16–20. Shadow Web Interface RRS Units of Recovery**

- Use the available commands in Table 16–10 on page 16-22 to perform the appropriate function(s).

## Running RRS

The best source for understanding what is needed to run RRS is the IBM manual *MVS Programming: Resource Recovery* (GC28-1739), Chapter 8, “Managing RRS,” which refers to the IBM manual *Setting Up a Sysplex* for instructions on how to set up and prepare System Logger Log Streams.

Shadow Mainframe Adapter Client  
for DB2: Appendixes

---



# Shadow Mainframe Adapter Server: Started Task Parameters

---

Shadow is controlled using certain parameters, known as started task parameters. These parameters can be modified depending on the function Shadow is supporting. Modification can take place via the ISPF application or the Shadow Web Interface™ program, whichever you are using.

This chapter will cover the following topics:

- Introduction
- Available Commands
  - Viewing Details about a Parameter
  - Modifying a Started Task Parameter
- Shadow Started Task Parameters

## Introduction

Shadow Mainframe Adapter Server started task parameters are defined initially using the Shadow Mainframe Adapter Server initialization EXEC, SDBxIN00. Some parameters, however, can be modified after setup. These parameters, as well as instructions for their modification, are described in detail in this chapter.

The Started Task Parameter application can be accessed both by the ISPF panels and the Shadow Web Interface™.

## Available Commands

The Started Task Parameter application supports all four scrolling commands (**UP**, **DOWN**, **LEFT**, **RIGHT**) and their PF key equivalents or scroll bar equivalents. It also supports the primary **SORT** and **LOCATE** commands.

In addition, the ISPF and Shadow Web Interface application support the started task parameter commands shown in Table A–12.

**Table A–12. Started Task Parameter Commands**

Command Description	ISPF	Web Interface
To cancel the thread:	D	Display
To format the information for the selected row:	F	Format
To print the associated control block for the selected row:	P	N/A

**Table A–12. Started Task Parameter Commands (continued)**

Command Description	ISPF	Web Interface
To start the control block browse sub-application:	S	Block
To display the parameter explanation:	N/A	MSG
To modify a parameter value:	N/A	Update

To use control block commands, do one of the following:

- **ISPF panels:** Type the command to the left of the line and press ENTER.
- **Shadow Web Interface:** Click on the selected command.

When a line command has completed its action, a note is placed in the NOTE column as a reminder that you issued the command.

## Viewing Details about a Parameter

### For Shadow ISPF Application Users

1. From the **Shadow Mainframe Adapter Server Primary Option Menu** (shown in Figure A–21), select Option 5.2.

```

----- Shadow Mainframe Adapter Server Primary Option Menu -----
-----
Option ==> =5.2

 1 LINK          - Display and control link table           Time      - 10:05
 2 IMS           - IMS Control Facility                     Terminal  - 3278
 3 CICS          - CICS Control Facility                   PF Keys   - 12
 4 REMOTE USER  - Display and control remote users         VV.RR.MM - 04.08.01
 5 SDB CONTROL  - Control Shadow Mainframe Adapter Server   Subsys
- SDBB
 6 TRACE BROWSE - Browse Shadow Mainframe Adapter Server trace log
 7 SEF CONTROL  - Control Shadow Event Facility (SEF)
 8 DATABASES    - Monitor and control database access
10 DATA MAPPING - Data Mapping Facility
 D DEBUG        - Debugging Facilities
 S SUPPORT      - Display Shadow Mainframe Adapter Server Support Information

```

**Figure A–21. Shadow Mainframe Adapter Server Primary Option Menu**

2. Press ENTER. The system displays the **Shadow Mainframe Adapter Server Parameter Groups** panel shown in Figure A–22.

```

----- Shadow Mainframe Adapter Server Parameter Groups -----
---- ROW 1 OF 26
COMMAND ==> SCROLL ==> PAGE
Line Commands:  D Display Parameters  F Format  P Print CB  S Show CB

PARAMETER          GROUP
GROUP              DESCRIPTION
D PRODADABAS       PRODUCT ADABAS PARAMETERS
PRODAPPCMVS        PRODUCT APPC/MVS PARAMETERS
PRODBROWSE         PRODUCT TRACE BROWSE PARAMETERS
PRODCICS           PRODUCT CICS PARAMETERS
PRODCOMM           PRODUCT COMMUNICATIONS PARAMETERS
PRODEVENT          PRODUCT EXCEPTION EVENT PARAMETERS
PRODFILE           PRODUCT FILE PARAMETERS
PRODGLV            PRODUCT GLOBAL VARIABLE PARAMETERS
PRODIMS            PRODUCT IMS PARAMETERS
PRODLICENSE        PRODUCT LICENSING PARAMETERS
PRODLOGGING        PRODUCT LOGGING PARAMETERS
PRODMESSAGES       PRODUCT MESSAGES
PRODMODULES        PRODUCT MODULES
PRODMSGQ           PRODUCT MESSAGE QUEUING PARAMETERS
PRODPARM           PRODUCT GENERAL PARAMETERS
PRODREXX           PRODUCT REXX PARAMETERS
PRODRPC            PRODUCT RPC PARAMETERS
PRODRRS            PRODUCT RESOURCE RECOVERY SERVICES PARAMETERS
PRODSECURITY       PRODUCT SECURITY PARAMETERS
PRODSEF            PRODUCT SEF PARAMETERS
PRODSQL            PRODUCT SQL PARAMETERS
PRODSTOR           PRODUCT STORAGE PARAMETERS
PRODTOKEN          PRODUCT TOKEN PROCESSING PARAMETERS
PRODTRACE          PRODUCT TRACE PARAMETERS
PRODWLM            PRODUCT WLM SUPPORT PARAMETERS
PRODALL            ALL PRODUCT PARAMETERS
OBSOLETE           OBSOLETE PRODUCT PARAMETERS

```

**Figure A–22. Shadow Mainframe Adapter Server Parameter Groups**

3. To the left of the parameter group you would like to view, type D, for display. In this example, the PRODADABAS group will be displayed.
4. Press ENTER. The system displays the **Shadow Mainframe Adapter Server Parameters** panel showing a listing of all the parameters in the selected parameter group and their default values. Figure A–23 shows the **Shadow Mainframe Adapter Server Parameters** panel for the PRODADABAS parameter group.

```

----- Shadow Mainframe Adapter Server Parameters -----
SCR 1 ROW 1 OF 15
COMMAND ===>                                SCROLL ===> PAGE
  Line Commands:  D Display  F Format  P Print CB  S Show CB

  PARAMETER                                PARAMETER
  DESCRIPTION                                VALUE
D ADABAS SUPPORT ACTIVATED                YES
ADABAS READONLY ACTIVATED                NO
ADALNK BYPASS ACTIVATED                  NO
ADABAS SECURITY ACTIVATED                NO
ADABAS DMF SECURITY ACTIVATED            NO
ADABAS UID ADD3 ACTIVATED                NO
ADABAS AUTOMAPPING ACTIVATED            YES
ADABAS AUTOMAPPING CONVERT U TO P       NO
ADABAS AUTOMAPPING CONVERT B TO I       NO
ADABAS DATE FORMAT                       'US'
ADABAS ET BT TARGET                      'A'
ADABAS UPPERCASE SQL                     NO
MAX S COMMAND SEARCH TIME                0 SECONDS
ACI PERSISTENT Mainframe Adapter Server  Mainframe
Adapter Client TIMEOUT

```

**Figure A–23. Parameters within the PRODADABAS Group**

5. To the left any particular parameter, type D to display more information. In this example, more information about the parameter ADABAS SUPPORT ACTIVATED will be displayed.
6. Press ENTER. The system displays the **Parameter Information** panel, showing an explanation of the chosen parameter, as shown in Figure A–24.

```

BROWSE -- Parameter Information ----- Line 00000000 Col 001 065
Command ===>                                Scroll ===> PAGE
***** Top of Data *****
PARM      ADABAS

MESSAGE   ADABAS SUPPORT ACTIVATED

EXPLAIN   Set the ADABAS option to YES if ADABAS support is to be
          activated.  The ADABAS module, ADALNK, must be present
          in the STEPLIB concatenation when this option is set.
***** Bottom of Data *****

```

**Figure A–24. Details for a Specific Parameter**

7. Use the **END** command (or press the F3 key) to return to the **Shadow Mainframe Adapter Server Parameters** panel (Figure A–23).



8. To the left any particular parameter, type F to view information about the parameter value. In this example, the parameter ADABAS SUPPORT ACTIVATED will be displayed again.
9. Press ENTER. The system displays another **Parameter Information** panel, showing the parameter name, the parameter description text (the long name), whether or not it is updatable or ready-only, the maximum and minimum values, and the value, as shown in Figure A–25.

```

BROWSE -- Parameter Information ----- Line 00000000 Col 001 060
Command ==>                               Scroll ==> PAGE
***** Top of Data *****
Parameter Name          ADABAS
Description Text        ADABAS SUPPORT ACTIVATED
Group Name              PRODADABAS
Updatable Parameter     N
Read-Only Parameter     N
Maximum Value           0
Minimum Value           0
Parameter Counter       1
Parameter Value         YES
***** Bottom of Data *****

```

**Figure A–25. Additional Details for a Specific Parameter**

10. Use the **END** command (or press the F3 key) to return to the **Shadow Mainframe Adapter Server Parameters** panel (Figure A–23).

## For Shadow Web Interface Users

1. From the main menu, select **Product** → **Parameter Groups**. The system displays the **Parameter Groups** screen shown in Figure A–26.

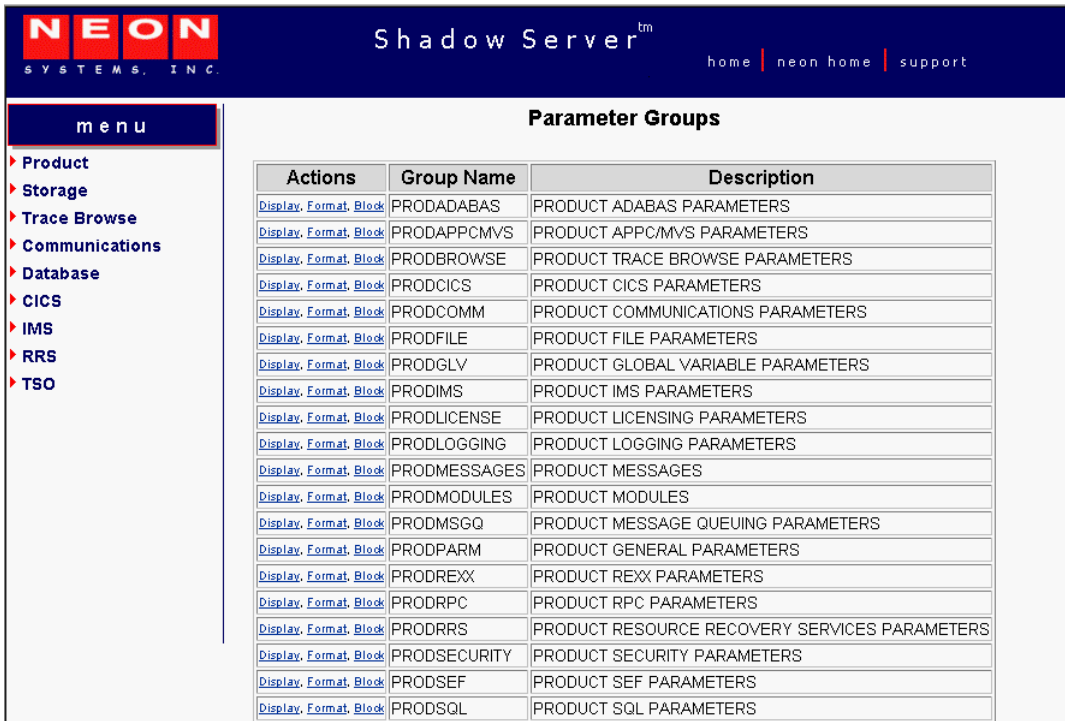

Figure A–26. Shadow Started Task Parameter Groups

- To the left of the parameter group you would like to view, click **Display**. The system displays the **Parameters** panel, showing a list of parameters in that group, as shown in Figure A–27. In this example, the PRODADABAS group is displayed.

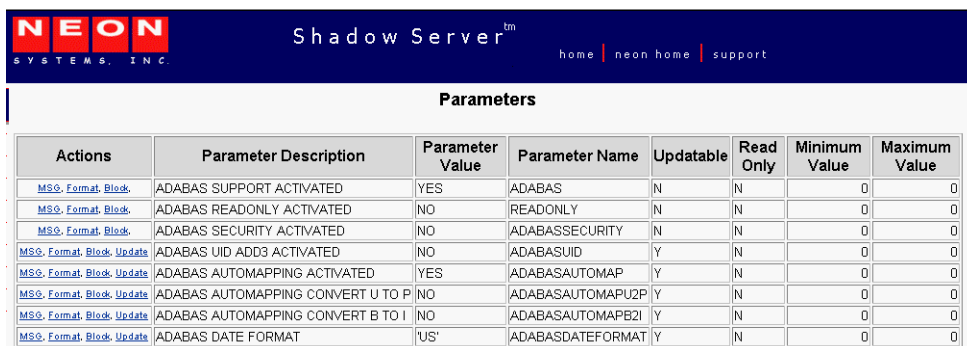
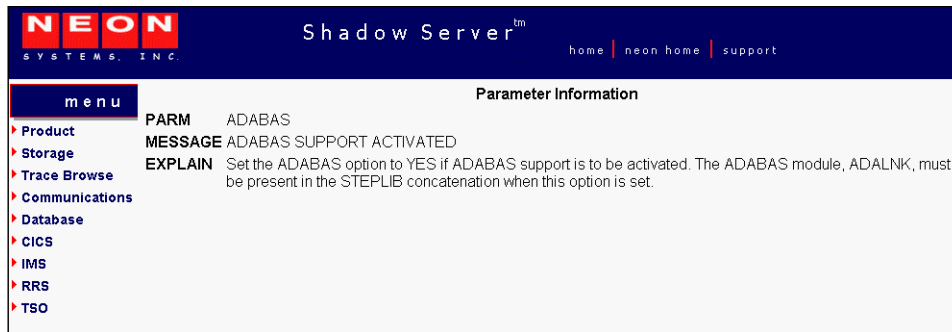

Figure A–27. Parameters within the PRODADABAS Group

- To the left of a parameter, click **MSG** to view the explanation for a parameter. The system displays the **Parameter Information** panel, as shown in Figure A–28. In this example, the parameter ADABAS SUPPORT ACTIVATED is displayed.



**Figure A–28. Details for a Specific Started Task Parameter**

4. Click the **Back** button to return to the previous screen.
5. To the left of a parameter, click **Format** to view additional information about the parameter. The system displays additional details about the parameter, as shown in Figure A–29. In this example, the parameter ADABAS SUPPORT ACTIVATED is displayed again.



**Figure A–29. Additional Details for a Specific Parameter**

6. Click the **Back** button to return to the previous screen.
7. To the left of a parameter, click **Block** to view block information about the parameter. The system displays the **Parameter Block** screen, as shown in Figure A–30. In this example, the parameter ADABAS SUPPORT ACTIVATED is displayed again.

SMPNAME	PARAMETER_NAME	STRING	..ADABAS
SMPENALN	PARAMETER_NAME	LENGTH	6
SMPBFLNA	PARAMETER_NAME	STRING	ADABAS
SMPBPASR	PARAMETER_VALUE		YES
SMPBFLDC	DESCRIPTION	TEXT	ADABAS SUPPORT ACTIVATED
SMPBPAGP	GROUP_NAME	OF PARAM	PRODADABAS
SMPBFAFIN	CHANGE_AFTERINIT		N
SMPBDFL	OUTPUT_ONLY		N
SMPBFLTY	FIELD_TYPE	VALUE	E
SMPBDATY	DATA_TYPE	VALUE	D
SMPBSFSR	SUFFIX		
SMPBCBNA	CONTROL_BLOCK	NAME	OPWK
SMPBCBOF	OFFSET		1050
SMPBCBLN	CBFIELD_LENGTH		34
SMPBCBTY	CBFIELD_TYPE		U
SMPBMXVL	MAXIMUM	VALUE	0
SMPBMNVL	MINIMUM	VALUE	0
SMPBVLCN	VALUE	COUNT	1
SMPBPACN	PARAMETER	COUNTER	1

Parameter Block (00D0)						
*0000	0006C1C4	C1C2C1E2	40404040	40404040	*..ADABAS	*
*0010	40404040	4040E8C5	E2404040	40404040	* YES	*
*0020	40404040	40404040	40404040	40404040	* *	*
*0030	40404040	4040C1C4	C1C2C1E2	40E2E4D7	* ADABAS SUP*	

Figure A–30. Block Information for a Specific Parameter

- Click the **Back** button to return to the previous screen.

## Modifying a Started Task Parameter

There are three ways to modify or update a started task parameter:

- The Shadow Mainframe Adapter Server initialization EXEC, SDBx.IN00, using a **MODIFY PARM** statement.
- From the **Shadow Mainframe Adapter Server Primary Option Menu**, by selecting Option 5.2.
- The Shadow Web Interface.

This chapter will cover the second and third options.

### For Shadow ISPF Application Users

To use the ISPF application to modify Shadow Mainframe Adapter Server parameters, do the following:

- From the **Shadow Mainframe Adapter Server Primary Option Menu** (shown in Figure A–31), select Option 5.2.

```

----- Shadow Mainframe Adapter Server Primary Option Menu -----
-----
Option ==> =5.2

 1 LINK          - Display and control link table           Time      - 10:05
 2 IMS          - IMS Control Facility                     Terminal - 3278
 3 CICS         - CICS Control Facility                     PF Keys  - 12
 4 REMOTE USER - Display and control remote users          VV.RR.MM - 04.08.01
 5 SDB CONTROL  - Control Shadow Mainframe Adapter Server   Subsys
- SDBB
 6 TRACE BROWSE - Browse Shadow Mainframe Adapter Server trace log
 7 SEF CONTROL  - Control Shadow Event Facility (SEF)
 8 DATABASES    - Monitor and control database access
10 DATA MAPPING - Data Mapping Facility
 D DEBUG        - Debugging Facilities
 S SUPPORT      - Display Shadow Mainframe Adapter Server Support Information

```

**Figure A-31. Shadow Mainframe Adapter Server Primary Option Menu**

2. Press ENTER. The system displays the **Shadow Mainframe Adapter Server Parameter Groups** panel shown in Figure A-32.

```

----- Shadow Mainframe Adapter Server Parameter Groups -----
---- ROW 1 OF 26
COMMAND ==> SCROLL ==> PAGE
Line Commands:  D Display Parameters  F Format  P Print CB  S Show CB

PARAMETER          GROUP
GROUP              DESCRIPTION
D PRODADABAS       PRODUCT ADABAS PARAMETERS
PRODAPPCMVS        PRODUCT APPC/MVS PARAMETERS
PRODBROWSE         PRODUCT TRACE BROWSE PARAMETERS
PRODCICS           PRODUCT CICS PARAMETERS
PRODCOMM           PRODUCT COMMUNICATIONS PARAMETERS
PRODEVENT          PRODUCT EXCEPTION EVENT PARAMETERS
PRODFILE           PRODUCT FILE PARAMETERS
PRODGLV            PRODUCT GLOBAL VARIABLE PARAMETERS
PRODIMS            PRODUCT IMS PARAMETERS
PRODLICENSE        PRODUCT LICENSING PARAMETERS
PRODLOGGING        PRODUCT LOGGING PARAMETERS
PRODMESSAGES       PRODUCT MESSAGES
PRODMODULES        PRODUCT MODULES
PRODMSGQ           PRODUCT MESSAGE QUEUING PARAMETERS
PRODPARM           PRODUCT GENERAL PARAMETERS
PRODREXX           PRODUCT REXX PARAMETERS
PRODRPC            PRODUCT RPC PARAMETERS
PRODRRS            PRODUCT RESOURCE RECOVERY SERVICES PARAMETERS
PRODSECURITY       PRODUCT SECURITY PARAMETERS
PRODSEF            PRODUCT SEF PARAMETERS
PRODSQL            PRODUCT SQL PARAMETERS
PRODSTOR           PRODUCT STORAGE PARAMETERS
PRODTOKEN          PRODUCT TOKEN PROCESSING PARAMETERS
PRODTRACE          PRODUCT TRACE PARAMETERS
PRODWLM            PRODUCT WLM SUPPORT PARAMETERS
PRODALL            ALL PRODUCT PARAMETERS
OBSOLETE           OBSOLETE PRODUCT PARAMETERS

```

**Figure A–32. Started Task Parameter Groups**

3. To the left of the selected parameter group, type D to display the parameters within the group. In this case, the group is PRODADABAS is will be displayed.
4. Press ENTER. The system displays the **Shadow Mainframe Adapter Server Parameters** panel showing a listing of all the parameters in the selected parameter group and their default values. Figure A–33 shows the **Shadow Mainframe Adapter Server Parameters** panel for the PRODADABAS parameter group.

```

----- Shadow Mainframe Adapter Server Parameters -----
SCR 1 ROW 1 OF 15
COMMAND ==>
Line Commands:  D Display  F Format  P Print CB  S Show CB
                SCROLL ==> PAGE

PARAMETER          PARAMETER
DESCRIPTION         VALUE
ADABAS SUPPORT ACTIVATED      YES
ADABAS READONLY ACTIVATED     NO
ADALNK BYPASS ACTIVATED       NO
ADABAS SECURITY ACTIVATED      NO
ADABAS DMF SECURITY ACTIVATED  NO
ADABAS UID ADD3 ACTIVATED     NO
ADABAS AUTOMAPPING ACTIVATED  YES
ADABAS AUTOMAPPING CONVERT U TO P  NO
ADABAS AUTOMAPPING CONVERT B TO I  NO
ADABAS DATE FORMAT            'US'
ADABAS ET BT TARGET           'A'
ADABAS UPPERCASE SQL          NO
MAX S COMMAND SEARCH TIME     0 SECONDS
ACI PERSISTENT Mainframe Adapter Server TIMEOUT      Mainframe
Adapter Client

```

**Figure A–33. Parameters within the PRODADABAS Group**

5. For the selected parameter, simply type over the existing value that you want to change in the PARAMETER VALUE column. In this example, the value of ADABAS AUTOMAPPING ACTIVATED will be changed from YES to NO.



**Note:**

If the value is not updatable, you will not be able to type over it.

6. Press ENTER to save the change. If the value was successfully modified, the system will display a “VALUE/S MODIFIED” message in the upper right hand corner of the panel, as shown in Figure A–34.

```

----- Shadow Mainframe Adapter Server Parameters -----
VALUE/S MODIFIED
COMMAND ==>
Line Commands:  D Display  F Format  P Print CB  S Show CB
                SCROLL ==> PAGE

PARAMETER          PARAMETER
DESCRIPTION        VALUE
ADABAS SUPPORT ACTIVATED      YES
ADABAS READONLY ACTIVATED     NO
ADALNK BYPASS ACTIVATED       NO
ADABAS SECURITY ACTIVATED      NO
ADABAS DMF SECURITY ACTIVATED  NO
ADABAS UID ADD3 ACTIVATED     NO
ADABAS AUTOMAPPING ACTIVATED  NO
ADABAS AUTOMAPPING CONVERT U TO P  NO
ADABAS AUTOMAPPING CONVERT B TO I  NO
ADABAS DATE FORMAT            'US'
ADABAS ET BT TARGET           'A'
ADABAS UPPERCASE SQL          NO
MAX S COMMAND SEARCH TIME     0 SECONDS
ACI PERSISTENT Mainframe Adapter Server TIMEOUT      Mainframe
Adapter Client

```

**Figure A–34. Panel Showing Parameter Modification**

7. Use the **END** command (or press the F3 key) to return to the **Shadow Mainframe Adapter Server Parameters** panel (Figure A–33).

## For Shadow Web Interface Users

To use the Shadow Web Interface to modify Shadow Mainframe Adapter Server parameters, do the following:

1. From the main menu, select **Product** → **Parameter Groups**. The system displays the **Parameters Groups** screen shown in Figure A–35.



Actions	Group Name	Description
<a href="#">Display</a> , <a href="#">Format</a> , <a href="#">Block</a>	PRODADABAS	PRODUCT ADABAS PARAMETERS
<a href="#">Display</a> , <a href="#">Format</a> , <a href="#">Block</a>	PRODAPPCMVS	PRODUCT APPC/MVS PARAMETERS
<a href="#">Display</a> , <a href="#">Format</a> , <a href="#">Block</a>	PRODBROWSE	PRODUCT TRACE BROWSE PARAMETERS
<a href="#">Display</a> , <a href="#">Format</a> , <a href="#">Block</a>	PRODCICS	PRODUCT CICS PARAMETERS
<a href="#">Display</a> , <a href="#">Format</a> , <a href="#">Block</a>	PRODCOMM	PRODUCT COMMUNICATIONS PARAMETERS
<a href="#">Display</a> , <a href="#">Format</a> , <a href="#">Block</a>	PRODFILE	PRODUCT FILE PARAMETERS
<a href="#">Display</a> , <a href="#">Format</a> , <a href="#">Block</a>	PRODGLV	PRODUCT GLOBAL VARIABLE PARAMETERS
<a href="#">Display</a> , <a href="#">Format</a> , <a href="#">Block</a>	PRODIMS	PRODUCT IMS PARAMETERS
<a href="#">Display</a> , <a href="#">Format</a> , <a href="#">Block</a>	PRODLICENSE	PRODUCT LICENSING PARAMETERS
<a href="#">Display</a> , <a href="#">Format</a> , <a href="#">Block</a>	PRODLOGGING	PRODUCT LOGGING PARAMETERS
<a href="#">Display</a> , <a href="#">Format</a> , <a href="#">Block</a>	PRODMESSAGES	PRODUCT MESSAGES
<a href="#">Display</a> , <a href="#">Format</a> , <a href="#">Block</a>	PRODMODULES	PRODUCT MODULES
<a href="#">Display</a> , <a href="#">Format</a> , <a href="#">Block</a>	PRODMMSGQ	PRODUCT MESSAGE QUEUING PARAMETERS
<a href="#">Display</a> , <a href="#">Format</a> , <a href="#">Block</a>	PRODPARM	PRODUCT GENERAL PARAMETERS
<a href="#">Display</a> , <a href="#">Format</a> , <a href="#">Block</a>	PRODREXX	PRODUCT REXX PARAMETERS
<a href="#">Display</a> , <a href="#">Format</a> , <a href="#">Block</a>	PRODRPC	PRODUCT RPC PARAMETERS
<a href="#">Display</a> , <a href="#">Format</a> , <a href="#">Block</a>	PRODRRS	PRODUCT RESOURCE RECOVERY SERVICES PARAMETERS
<a href="#">Display</a> , <a href="#">Format</a> , <a href="#">Block</a>	PRODSECURITY	PRODUCT SECURITY PARAMETERS
<a href="#">Display</a> , <a href="#">Format</a> , <a href="#">Block</a>	PRODSEF	PRODUCT SEF PARAMETERS
<a href="#">Display</a> , <a href="#">Format</a> , <a href="#">Block</a>	PRODSQL	PRODUCT SQL PARAMETERS

**Figure A–35. Shadow Mainframe Adapter Server Parameter Groups**

- To the left of the parameter group containing the parameter you would like to modify, click **Display**. The system displays **Parameters** screen, showing the list of parameters in that group, as shown in Figure A–36. In this example, the PRODADABAS is displayed.

Actions	Parameter Description	Parameter Value	Parameter Name	Updatable	Read Only	Minimum Value	Maximum Value
<a href="#">MSG</a> , <a href="#">Format</a> , <a href="#">Block</a>	ADABAS SUPPORT ACTIVATED	YES	ADABAS	N	N	0	0
<a href="#">MSG</a> , <a href="#">Format</a> , <a href="#">Block</a>	ADABAS READONLY ACTIVATED	NO	READONLY	N	N	0	0
<a href="#">MSG</a> , <a href="#">Format</a> , <a href="#">Block</a>	ADABAS SECURITY ACTIVATED	NO	ADABASSECURITY	N	N	0	0
<a href="#">MSG</a> , <a href="#">Format</a> , <a href="#">Block</a> , <a href="#">Update</a>	ADABAS UID ADD3 ACTIVATED	NO	ADABASUID	Y	N	0	0
<a href="#">MSG</a> , <a href="#">Format</a> , <a href="#">Block</a> , <a href="#">Update</a>	ADABAS AUTOMAPPING ACTIVATED	YES	ADABASAUTOMAP	Y	N	0	0
<a href="#">MSG</a> , <a href="#">Format</a> , <a href="#">Block</a> , <a href="#">Update</a>	ADABAS AUTOMAPPING CONVERT U TO P	NO	ADABASAUTOMAPU2P	Y	N	0	0
<a href="#">MSG</a> , <a href="#">Format</a> , <a href="#">Block</a> , <a href="#">Update</a>	ADABAS AUTOMAPPING CONVERT B TO I	NO	ADABASAUTOMAPB2I	Y	N	0	0
<a href="#">MSG</a> , <a href="#">Format</a> , <a href="#">Block</a> , <a href="#">Update</a>	ADABAS DATE FORMAT	'US'	ADABASDATEFORMAT	Y	N	0	0

**Figure A–36. Started Task Parameters for the PRODADABAS Group**

- To the left of the parameter you want to modify, click **Update**. The system displays a screen showing the current value and the new value, as shown in Figure A–37.

**Note:**

The **Update** button is displayed only with those parameters that can be modified. If there is no **Update** button, the parameter value cannot be changed.

The screenshot shows the Shadow Server web interface. At the top, there is a dark blue header with the NEON logo on the left, 'Shadow Server™' in the center, and navigation links 'home | neon home | support' on the right. Below the header is a 'menu' sidebar with a list of categories: Product, Storage, Trace Browse, Communications, Database, CICS, IMS, RRS, and TSO. The main content area is titled 'Current Value:' and contains the text 'The current value for the ADABASAUTOMAP parameter is NO'. Below this is a 'New Value' section with the prompt 'Enter the new value to be assigned to this parameter' and a text input field containing 'NO'. At the bottom of the form are two buttons: 'Update Parameter Value' and 'Cancel'.

**Figure A–37. Modifying Parameter Value**

4. In the **New Value** section, type over the existing value with the new value. In this case the NO will be changed to YES.
5. Click **Update Parameter Value**. The system displays a screen indicating the change was successful, as shown in Figure A–38.

The screenshot shows the Shadow Server web interface after a successful update. The header and menu are the same as in Figure A–37. The main content area is titled 'LAST UPDATE RESULTS' and contains the text 'Modification Successful'. Below this, it states 'The current value of the ADABASAUTOMAP parameter is NO'.

**Figure A–38. Display of Modified Parameter Value**

6. Click the **Back** button to return to the **Parameters** screen (Figure A–36).

## Shadow Started Task Parameters

The following sections provide details about the Shadow started task parameter groups, as well as each parameter contained in the group. The groups include:

- PRODADABAS
- PRODAPPCMVS
- PRODBROWSE
- PRODCICS
- PRODCOMM
- PRODEVENT
- PRODFILE
- PRODGLV
- PRODIMS
- PRODLICENSE
- PRODLOGGING
- PRODMSGQ
- PRODPARM
- PRODREXX
- PRODRPC
- PRODRRS
- PRODSECURITY
- PRODSEF
- PRODSQL
- PRODSTOR
- PRODTOKEN
- PRODTRACE
- PRODWLM
- OBSOLETE

## PRODADABAS

PRODADABAS Parameter Group				
Parameter Name	Parameter Description	Default Value	Update	Output Only
ACIDEFAULTCONNNAME	ACI DEFAULT CONNECTION NAME. This parameter can be set to provide a default connection name for CICS Mainframe Adapter Servers that have older versions of the Shadow Interface for Natural code and do not provide a connection name.	'EXCS'	Yes	No
ACIPERSISTTIMEOUT	ACI PERSISTENT Mainframe Adapter Server TIMEOUT. This parameter controls which timeout value (Mainframe Adapter Client or Mainframe Adapter Server) will be used for persistent Mainframe Adapter Servers.	MAINFRAME ADAPTER CLIENT	Yes	No
ADABAS	ADABAS SUPPORT ACTIVATED. (YES, NO) This parameter controls whether or not ADABAS support is activated. Set the ADABAS option to YES if ADABAS support is to be activated. The ADABAS module, ADALNK, must be present in the STEPLIB concatenation when this option is set.	YES	No	No
ADABASPRUNEMUPE	ADABAS PRUNE RESULT SETS If an ADABAS MU or PE field is specified as with an asterisk notation, such as AI(*), this specifies whether the result set should be "pruned" of unneeded columns - that is, only those columns which contain information are returned rather than all the potential MU or PE columns: <ul style="list-style-type: none"> <li>• <b>NO</b> indicates that no result set pruning is to take place</li> <li>• <b>ALL</b> specifies that all columns which contain no values will be eliminated along with the Count field for each MU/PE.</li> <li>• <b>NOTCOUNT</b> is same as for ALL, but the Count Columns are returned.</li> </ul>	ALL	Yes	No
ADABASAUTOMAP	ADABAS AUTOMAPPING ACTIVATED. (YES, NO) This parameter controls whether or not a customer can turn off the automapping feature.	YES	No	No
ADABASAUTOMAPB2I	ADABAS AUTOMAPPING CONVERT B TO I. (YES, NO) This parameter controls the changing of B format fields to I format. B(2) becomes the short integer, B(4) becomes the integer.	NO	Yes	No

PRODADABAS Parameter Group				
Parameter Name	Parameter Description	Default Value	Update	Output Only
ADABASAUTOMAPU2P	ADABAS AUTOMAPPING CONVERT U TO P. (YES, NO)  This parameter controls the changing of the format of U format fields to P format.	NO	Yes	No
ADABASDATEFORMAT	ADABAS DATE FORMAT.  This parameter specifies the format that the ADABAS date and time fields are to be presented to and sent from Shadow_ADABAS. Valid types are: <ul style="list-style-type: none"> <li>• <b>OD:</b> ODBC format: yyyy-mm-dd</li> <li>• <b>US:</b> (Default) USA format: yyyy/mm/dd</li> <li>• <b>EU:</b> European format: dd.mm.yyyy</li> <li>• <b>UK:</b> United Kingdom format: dd-mm-yyyy</li> </ul>	'US'	Yes	No
ADABASDBIDSMF	ADABAS COMMAND STATISTICS SMF (YES, NO)  This parameter causes one SMF record to be written per DBID accessed at the end of each session. The records contain command usage statistics.	NO	Yes	No
ADABASDMFSEC	ADABAS DMF SECURITY ACTIVATED. (YES, NO)  Set the ADABASDMFSEC parameter if a resource rule is to be constructed consisting of the DMF map name.	NO	No	No
ADABASETBTARGET	ADABAS ET BT TARGET  This parameter controls Shadow's list of ADABAS targets (up to 10) that have been accessed or updated during the Mainframe Adapter Client connection. When a COMMIT or ROLLBACK is performed, this parameter indicates to which ADABAS targets the COMMIT or ROLLBACK will be issued. Possible values are: <ul style="list-style-type: none"> <li>• <b>A:</b> (Default) Accessed and updated databases are in the list. The list is not cleared at COMMIT or ROLLBACK.</li> <li>• <b>U:</b> Only updated targets are included in the list. The list is cleared at COMMIT or ROLLBACK.</li> </ul>	'A'	No	No
ADABASSECURITY	ADABAS SECURITY ACTIVATED. (YES, NO)  This parameter controls whether or not a resource rule is to be constructed consisting of dbid and file.	NO	No	No

PRODADABAS Parameter Group				
Parameter Name	Parameter Description	Default Value	Update	Output Only
ADABASUID	ADABAS UID ADD3 ACTIVATED. (YES, NO)  This parameter controls whether or not the customer can see the Mainframe Adapter Client uid in the ADABAS control block adds 3 field.	NO	No	No
ADABASUBINFOSIZE	ADABAS USER + REVIEW INFO SIZE  Specifies the amount of space to be allocated for the User Information and Review Information combined in the ADABAS User Block. Default is 256 bytes. <b>Maximum Size: 1024</b> <b>Minimum Size: 100</b>	256	No	No
ADABASUPPERCASE	ADABAS UPPERCASE SQL. (YES, NO)  This parameter controls whether or not all ADABAS SQL statements should be upper cased. In effect, this parameter changes the default from SET LOWERCASE to SET UPPERCASE.	NO	Yes	No
ADALNKBYPASS	ADALNK BYPASS ACTIVATED. (YES, NO)  Set the ADALNKBYPASS if you wish to ignore the version and reentrancy check Shadow makes against the ADABAS ADALNK routine.  <b>Caution:</b> You should contact NEON Systems Customer Support before using this parameter. Setting this parameter to yes means that you understand that the ADALNK must be reentrant and be able to accept the 7th parameter known as the "MODIFIED" area as described by the ADALNK source.	NO	No	No
SCOMMANDSEARCHTIME	MAX S COMMAND SEARCH TIME.  This parameter specifies the maximum amount of time permitted for the execution of an SX command. <b>Maximum Time: 65535 Seconds</b> <b>Minimum Time: 0 Seconds</b>	0	Yes	No
READONLY	ADABAS READONLY ACTIVATED. (YES, NO)  This parameter controls whether or not SQL access for ADABAS allows update type requests.	NO	No	No

## PRODAPPCMVS

PRODAPPCMVS Parameter Group				
Parameter Name	Parameter Description	Default Value	Update	Output Only
CHECKCONVIDINTERVAL	<p>CONVID TIMEOUT CHECKING INTERVAL.</p> <p>This parameter controls how often each convid is checked to see if the convid has timed out. If the convid has timed out, the conversation is deallocated and the entry in the conversation id table is removed.</p> <p><b>Caution:</b> Do not change this number unless you identify a situation where this number is inadequate. Call NEON Systems Customer Support for more information.</p> <p><b>Minimum: 1</b> <b>Maximum: 3600</b></p>	<b>15 SECONDS</b>	Yes	No
IMSCNVIDTBSZ	<p>IMS CONVERSATION ID TABLE SIZE.</p> <p>This parameter can be used to specify the size of the table used to maintain the status of active conversations.</p> <p><b>Caution:</b> Do not change this number unless you identify a situation where this number is inadequate. Call NEON Systems Customer Support for more information.</p> <p><b>Minimum: 2048</b> <b>Maximum: 262144</b></p>	<b>32K</b>	No	No
IMSCONVTYPE	<p>DEFAULT IMS CONVERSATION TYPE.</p> <p>This parameter identifies the conversation type on which the service is invoked. The possible values are:</p> <ul style="list-style-type: none"> <li>• <b>Basic:</b> (Default) TPs will format their data into separate records, with record length and data specified, before sending it.</li> <li>• <b>Mapped:</b> (Do not use) TPs will rely on APPC to format the data that the TPs send.</li> </ul> <p><b>Note:</b> This value should be set to Basic or omitted altogether</p>	<b>BASIC</b>	Yes	No

PRODAPPCMVS Parameter Group				
Parameter Name	Parameter Description	Default Value	Update	Output Only
IMSDEALLOCONVTIME	<p>DEALLOC IMS CONV TIME VALUE.</p> <p>This parameter specifies the maximum allowable duration of inactivity for any conversation. The inactive period is defined as the time expired since the last APPC/MVS call.</p> <p><b>Caution:</b> Do not change this number unless you identify a situation where this number is inadequate. Call NEON Systems Customer Support for more information.</p> <p><b>Minimum: 0</b> <b>Maximum: None</b></p>	900 SECONDS	Yes	No
IMSDEFAULTMAPNAME	DEFAULT IMS MAP NAME.	'DFSDSP01'	Yes	No
IMSLOCALLU	<p>DEFAULT IMS LOCAL LUNAME.</p> <p>This parameter specifies the name of the local LU from which the caller's allocate request is to originate. The ability to specify the local LU name allows the caller to associate its outbound conversations with particular LUs. The caller's address space must have access to the named LU. Otherwise, a parameter error return code is returned.</p> <p>This is the new local LU name specified in SYS1.PARMLIB(APPCPMxx). This parameter is optional; the default is to use the APPC base LU defined in SYS1.PARMLIB(APPCPMxx).</p> <p><b>Note:</b> It is recommended that a separate local LU be defined for each Shadow Mainframe Adapter Server you have running using IMS/ APPC. Application developers should be informed of which LU to use with which copy of the Shadow Mainframe Adapter Server.</p> <p><i>The APPC base LU will work in most cases; however, using a separate local LU tends to be a more reliable request.</i></p>	NULL	Yes	No
IMSLUEE0	ACTIVATE DFSLUEE0 EXIT. (YES, NO)	YES	Yes	No
IMSLUEE0ESCSEQ	DFSLUEE0 ESCAPE SEQUENCE.	'<%NE02%>'	Yes	No



PRODAPPCMVS Parameter Group				
Parameter Name	Parameter Description	Default Value	Update	Output Only
IMSMODENAME	<p>DEFAULT IMS MODE NAME.</p> <p>This parameter specifies the mode name designating the network properties for the session to be allocated for the conversation. The network properties include, for example, the class of service to be used. The mode name value of SNASVCMG is reserved for use by APPC/MVS. If a mode name of SNASVCMG is specified on the Allocate service, the request is rejected with a return code of parameter error.</p> <p>If you specify a symbolic destination name in the symbolic destination name parameter, set mode name to blanks to obtain the mode name from the side information.</p> <p>If the partner LU is the same or on the same system as the local LU, mode name is ignored. If the partner LU is on a different system, and you do not specify a symbolic destination name, a blank mode name defaults to any mode in effect for the local and partner LUs, or causes a return code of parametererror.</p>	NULL	Yes	No
IMSPARTNERLU	<p>DEFAULT IMS PARTNER LUNAME.</p> <p>This parameter is the name of the IMS LU defined in SYS1.PARMLIB(APPCPMxx).</p>	'N281AIMS'	Yes	No
IMSQUEUEKEEP TIME	<p>DEFAULT IMS ALLOC QUEUE KEEP TIME VALUE.</p> <p><b>Caution:</b> Do not change this number unless you identify a situation where this number is inadequate. Call NEON Systems Customer Support for more information.</p> <p><b>Minimum: 0</b> <b>Maximum: 3600</b></p>	3600 SECONDS	Yes	No
IMSRVALLOCTIMEOUT	<p>DEFAULT IMS RCVALLOC TIMEOUT VALUE.</p> <p><b>Caution:</b> Do not change this number unless you identify a situation where this number is inadequate. Call NEON Systems Customer Support for more information.</p> <p><b>Minimum: 0</b> <b>Maximum: 3600</b></p>	0 SECONDS	Yes	No
IMSRVALLOCTYPE	<p>DEFAULT IMS RECEIVE ALLOC TYPE.</p> <p>This parameter can be used to specify whether to wait for an inbound allocate and, if so, for how long.</p>	IMMEDIATE	Yes	No

PRODAPPCMVS Parameter Group				
Parameter Name	Parameter Description	Default Value	Update	Output Only
IMSRETURNCONTROL	<p>DEFAULT IMS RETURN CONTROL.</p> <p>This parameter specifies when control is to be returned to the local program within the context of session allocation. Possible values are:</p> <ul style="list-style-type: none"> <li>• <b>SESSION:</b> (Default and recommended value) Specifies to allocate a session for the conversation before returning control to the program. An error in allocating a session is reported on this call.</li> <li>• <b>IMMEDIATE:</b> Specifies to allocate a session for the conversation if a session is immediately available and return control to the program with a return code indicating whether a session is allocated. An error in allocating a session that is immediately available is reported on this call.</li> <li>• <b>CONWINNER:</b> Specifies to allocate a session in which the local LU is the contention winner, before returning control to the program. As contention winner, the LU avoids having to compete with the partner LU to establish the session, thus potentially saving network traffic. An error in allocating a contention winner session for the conversation is reported on this call.</li> </ul>	SESSION	Yes	No
IMSSECURITYTYPE	<p>DEFAULT IMS SECURITY TYPE.</p> <p>This parameter can be used to specify the type of access information the partner LU uses to validate access to the partner program and its resources. Possible values are:</p> <ul style="list-style-type: none"> <li>• <b>NONE:</b> (Default) Omit access security information on this allocation request.</li> <li>• <b>SAME:</b> Use the userid and security profile (if present) from the allocation request that initiated the local program. The password (if present) is not used; instead, the userid is indicated as being already verified. If the allocation request that initiated execution of the local program contained no access security information, then access security information is omitted on this allocation request.</li> </ul> <p>(Continued on next page)</p>	NONE	Yes	No

PRODAPPCMVS Parameter Group				
Parameter Name	Parameter Description	Default Value	Update	Output Only
IMSSECURITYTYPE (Continued)	<p>(Continued from previous page)</p> <ul style="list-style-type: none"> <li><b>PROGRAM:</b> Use the access security information that the local program provides on the call. The local program provides the information by means of the user_id, password, and profile parameters. These values are passed exactly as specified, without folding to uppercase.</li> </ul>	NONE	Yes	No
IMSSYMDEST	<p>DEFAULT IMS SMBOLIC DEST NAME.</p> <p>This parameter specifies a symbolic name representing the partner LU, the partner TP name, and the mode name for the session on which the conversation is to be carried. The symbolic destination name must match that of an entry in the side information dataset. The appropriate entry in the side information is retrieved and used to initialize the characteristics for the conversation.</p> <p>If you specify a symbolic destination name, the partner LU name, mode name, and TP name are obtained from the side information. If you also specify values for the partner LU name, mode name, or TP name parameters on the Allocate service, these values override any obtained from the side information.</p> <p>The symbolic destination name in this field can be from 1 to 8 characters long, with characters from character set 01134. If the symbolic destination name is shorter than eight characters, it must be left-justified in the variable field, and padded on the right with blanks. To not specify a symbolic destination name, set the symbolic destination name parameter value to 8 blanks and provide values for the partner LU name, mode name, and TP name parameters.</p>	NULL	Yes	No

PRODAPPCMVS Parameter Group				
Parameter Name	Parameter Description	Default Value	Update	Output Only
IMSSYNCLEVEL	<p>DEFAULT IMS SYNC LEVEL.</p> <p>This parameter can be used to specify the synchronization levels of the local and partner TP. Possible values are:</p> <ul style="list-style-type: none"> <li><b>NONE:</b> (Default) Program will not perform confirmation processing on this conversation. Programs will not call any services and will not recognize any returned parameters relating to confirmation.</li> <li><b>CONFIRM:</b> Programs can perform confirmation processing on this conversation. The programs can call services and will recognize returned parameters relating to confirmation.</li> </ul>	NONE	Yes	No
IMSTXNTIMEOUT	<p>DEFAULT IMS TXN TIMEOUT VALUE.</p> <p>This parameter can be used to limit the wait time for the completion of a transaction. If the transaction times out, a message is placed in the communication buffer to notify the Mainframe Adapter Client that a time-out has occurred.</p> <p><b>Minimum Value: 0</b> <b>Maximum Value: 300</b></p>	0 SECONDS	Yes	No
IMSSECURITYNOPASS	<p>SUPPORT ATB_SECURITY_PROGRAM_NOPASS REQUESTS. (YES, NO)</p> <p>This parameter controls whether application programs may invoke an APPC connection using the NEON-implemented option of ATB_SECURITY_PROGRAM_NOPASS. When set to NO, this option is not allowed/supported. This connection option allows applications to specify a userid, without a password.</p>	NO	Yes	No
MONITORAPPC/MVS	<p>MONITOR APPC/MVS. (YES, NO)</p> <p>This parameter specifies whether or not to monitor APPC/MVS conversations.</p> <p><b>Caution:</b> Do not change this number unless you identify a situation where this number is inadequate. Call NEON Systems Customer Support for more information.</p>	YES	Yes	No

PRODAPPCMVS Parameter Group				
Parameter Name	Parameter Description	Default Value	Update	Output Only
REALTIMESUMMARY	<p>IN MEMORY REALTIME SUMMARY COUNT.</p> <p>This parameter controls the number of APPC/MVS real-time summary records to keep in memory at one time. If this parameter is set to zero, then no APPC/MVS real-time summary records will be retained in memory. The APPC/MVS summary records kept in memory can be interactively displayed.</p> <p><b>Caution:</b> Do not change this number unless you identify a situation where this number is inadequate. Call NEON Systems Customer Support for more information.</p> <p><b>Minimum: 0</b> <b>Maximum: 360</b></p>	60 INTERVALS	Yes	No

## PRODBROWSE

PRODBROWSE Parameter Group				
Parameter Name	Parameter Description	Default Value	Update	Output Only
ARCHIVEDATACLASS	<p>ARCHIVE DEFINE CLUSTER DATACLASS.</p> <p>This parameter defines the DATACLASS operand value used to define linear clusters for archive datasets. If not set, DATACLASS is not specified when the linear datasets are allocated.</p>	NULL	Yes	No
ARCHIVEDEFCLPARMS	<p>ARCHIVE DEFINE CLUSTER PARAMETERS.</p> <p>This parameter contains additional parameter values which are passed on DEFINE CLUSTER statements generated to define archive backup datasets.</p>	NULL	Yes	No
ARCHIVEDSNPREFIX	<p>ARCHIVE DATASET NAME PREFIX.</p> <p>This parameter defines the high-level qualifier which the subsystem uses to construct datasets names for trace browse archive files. The value “.Dyyyyddd.Thhmmss” is appended to the qualifier, where yyyyddd is the julian date, and hhmmss is the time of day. Trace browse archival processing cannot be performed if this prefix is not set, since there is no default value.</p>	NULL	Yes	No
ARCHIVEMGMTCLASS	<p>ARCHIVE DEFINE CLUSTER MGMTCLASS.</p> <p>This parameter defines the MGMTCLASS operand value used to define linear clusters for archive datasets. If not set, MGMTCLASS is not specified when the linear datasets are allocated.</p>	NULL	Yes	No
ARCHIVESPLITALLO	<p>SPLIT ARCHIVE KILOBYTE ALLOCATION. (YES, NO)</p> <p>This parameter controls the use of primary and secondary space allocation amounts when DEFINE CLUSTER statements are generated to allocate archive and extract trace datasets. Possible values are:</p> <ul style="list-style-type: none"> <li>• <b>YES:</b> Primary and secondary space allocation amounts are requested. Note that when split, the primary and secondary space quantities are expressed in kilobytes and each is 50 percent of the total required.</li> <li>• <b>NO:</b> (Default) Only a primary space quantity, with no secondary space amount is requested.</li> </ul> <p><b>Caution:</b> Use of this parameter is not recommended. It should be set to YES only when the freespace on candidate DASD volumes is fragmented.</p>	NO	Yes	No

PRODBROWSE Parameter Group				
Parameter Name	Parameter Description	Default Value	Update	Output Only
ARCHIVESTORCLASS	<p>ARCHIVE DEFINE CLUSTER STORCLASS.</p> <p>This parameter defines the STORCLASS operand value used to define linear clusters for archive datasets. If not set, STORCLASS is not specified when the linear datasets are allocated.</p>	NULL	Yes	No
BROWSEARCHIVE	<p>BROWSE DATA ARCHIVING OPTION.</p> <p>This parameter controls whether the product produces archives of the wrap-around trace and how the archival procedure is inaugurated. Possible values are:</p> <ul style="list-style-type: none"> <li>• <b>NONE:</b> (Default) Archival of the trace is not supported and only user-requested ARCHIVE EXTRACTs are supported; explicitly requested EXTRACT archives are not considered to be “backup” type archives.</li> <li>• <b>AUTO:</b> Archival is triggered by automatically generating an ARCHIVE BACKUP command.</li> <li>• <b>MESSAGE:</b> The system generates a message when reachieving should be performed, and the generation of the ARCHIVE BACKUP command is not performed automatically.</li> </ul>	NONE	Yes	No
BROWSEARCHIVE-COUNT	<p>BROWSE MESSAGES TO ARCHIVE AT A TIME.</p> <p>This parameter is the number of messages to be written for each automated archival operation. Recommend value is no more than one-third of the BROWSEMAX value.</p>	0 MESSAGES	Yes	No
BROWSEARCHIVE-CUSHION	<p>ARCHIVE BACKUP CUSHION COUNT.</p> <p>This parameter is the number of messages used as a threshold for automated triggering of an archive event and as a guard against archiving overwritten messages.</p> <p>An archive event is scheduled for each group of BROWSEARCHIVECOUNT messages. However, scheduling is deferred until BROWSEARCHIVECUSHION additional messages have been logged.</p> <p>(Continued on next page)</p>	0 MESSAGES	Yes	No

PRODBROWSE Parameter Group				
Parameter Name	Parameter Description	Default Value	Update	Output Only
BROWSEARCHIVE-CUSHION (Continued)	(Continued from previous page) This cushion is required because some messages are updated in place, and allows the system to get beyond the ACTIVE message range before actually copying the messages to a backup. The cushion value is also used if a backup is requested and overlay of previously un-backed-up message is in progress or imminent. The system begins the archive with the next un-archived message, when possible. But if overlay is imminent or in-progress, already, this many messages are skipped in order to ensure that these overlaid messages are not copied.	<b>0 MESSAGES</b>	Yes	No
BROWSEBLOCKS	NUMBER OF BLOCKS IN TRACE BROWSE.	<b>200 BLOCKS</b>	No	No
BROWSEDDNAME	BROWSE DATA SET DDNAME.	<b>'SDBTRACE'</b>	No	No
BROWSEINTERVAL	BROWSE CHECKPOINT INTERVAL. <b>Minimum Value: 1</b> <b>Maximum Value: 300</b>	<b>15 SECONDS</b>	Yes	No
BROWSEMAX	BROWSE MAXIMUM MESSAGE COUNT. This parameter specifies the number of messages your trace will hold. Based on this value, the dataset size for the trace browse VSAM file can be calculated by figuring 1K per line. <b>Note:</b> Changing the value of this parameter in the Shadow initialization EXEC will cause the trace browse to be reformatted at the next startup, with a consequential loss of all pre-existing data.	<b>100000 MESSAGES</b>	No	No
BROWSEWAIT	BROWSE INITIALIZATION WAIT TIME. This parameter controls how long the product will wait for trace browse initialization to complete. This value may need to be raised to allow a very large DIV dataset to be initialized. <b>Minimum Value: 60</b> <b>Maximum Value: 30000</b>	<b>600 SEC</b>	No	No



<b>PRODBROWSE Parameter Group</b>				
<b>Parameter Name</b>	<b>Parameter Description</b>	<b>Default Value</b>	<b>Update</b>	<b>Output Only</b>
CLEARARCHIVE-RECOVERY	<p>CLEAR ARCHIVE RECOVERY STATUS FIELDS. (YES, NO)</p> <p>This parameter, if set to YES during start-up, will cause any in-flight archive recovery and cleanup operations to be bypassed. It does so by clearing the in-flight indicators. Cleanup of an incomplete trace browse archive must be handled manually, since setting this flag causes the Shadow Mainframe Adapter Server to delete all the information needed to invoke automatic cleanup at a later time.</p>	<b>NO</b>	No	No

**PRODCICS**

<b>PRODCICS Parameter Group</b>				
<b>Parameter Name</b>	<b>Parameter Description</b>	<b>Default Value</b>	<b>Update</b>	<b>Output Only</b>
BLINEWMACRO	BLI WITH HTML GENNED W/NEW MACROS (YES, NO)  This parameter specifies whether new or old IBM macros are being used to generate HTML.	<b>YES</b>		
CICSAHTMLGENDSNPFEX	CICS AHTML GEN DSN PREFIX.  This parameter allows the user to specify a dataset name prefix to be used by the CICS AutoHTML generation process whenever it needs to create a temporary dataset.	<b>NULL</b>	Yes	No
CICSCONNECTRETRY	CICS CONNECT RETRY INTERVAL.  This parameter specifies the duration, in seconds, of the interval between attempts to connect to the target CICS region(s).  <b>Minimum Value: 15</b> <b>Maximum Value: None</b>	<b>300 SECONDS</b>	Yes	No
CICSDATACONV	CONVERT NULLS TO BLANKS. (YES, NO)  This parameter controls the conversion of null bytes to blanks for the CICS Transaction Mainframe Adapter Server.	<b>YES</b>	Yes	No
CICSIRCSVCNO	CICS INTERREGION SVC NBR.  This parameter indicates the SVC number which is assigned to the interregion SVC.	<b>X'D8'</b>	No	No
CICSIRCSVCVR	CICS INTERREGION SVC VERSION.  This parameter indicates the version of the interregion SVC which is active on the current system.	<b>NULL</b>	No	Yes
CICSLOADBALANCE	USE CICS STATUS IN LOAD BALANCING. (YES, NO)  This parameter indicates whether or not the CICS transaction queue depth is to be used in load balancing decisions.	<b>NO</b>	Yes	No
CICSMAXCONNECTIONS	MAXIMUM NUMBER OF CONNECTIONS.  This parameter specifies the maximum number of connections which may be defined. This number indicates the total number of connections to all CICS regions.	<b>0</b>	Yes	No

PRODCICS Parameter Group				
Parameter Name	Parameter Description	Default Value	Update	Output Only
CICSPROCOWNER	CICS STORED PROCEDURE OWNER. This parameter allows the user to specify the procedure owner for IMS stored procedure map.	'CICS'	Yes	No
CICSSUBSYSTEM	CICS SUBSYSTEM NAME. This parameter indicates the subsystem name which CICS is defined as using.	'CICS'	No	No
CICSTXNMainframe Adapter ServerNAME	CICS TXN Mainframe Adapter Server NAME. This parameter specifies the name which is used in CICS to define the CICS Transaction Mainframe Adapter Server to CICS.	'SDBB'	No	No
CICSTXNTIMEOUT	TRANSACTION TIMEOUT VALUE. This parameter can be used to limit the wait time for the completion of a transaction. <b>Minimum Value: 0</b> <b>Maximum Value: 300</b>	<b>30 SECONDS</b>	Yes	No
DEFAULTCICSRPCTRAN	DEFAULT CICS RPC TRANSACTION. This parameter specifies the default CICS transaction id for CICS RPC program execution when no transaction id is otherwise specified.	'NEON'	Yes	No
DELETEEXCIMODULES	DELETE EXCI MODULES. (YES, NO) This parameter controls whether or not modules left in storage after an unsuccessful EXCI INIT_USER call should be deleted. This parameter will be set to YES by default until IBM generates a fix for this problem.	<b>YES</b>	Yes	No
DURETRY	SDUMP RETRY DURATION VALUE. This parameter specifies the total time, in seconds, that the external CICS interface is to continue trying to obtain an OS/390 or z/OS system dump using the SDUMP macro. <b>Minimum Value: 0</b> <b>Maximum Value: 30</b>	<b>0 SECONDS</b>	Yes	No
EXCI	INITIALIZE EXCI SUPPORT. (YES, NO) This parameter specifies whether or not the EXCI support is initialized.	<b>YES</b>	No	No
EXCIAPITYPE	EXCI DEFAULT API TYPE This parameter specifies the default APITYPE for EXCI support.	<b>EXCI</b>	Yes	No

<b>PRODCICS Parameter Group</b>				
<b>Parameter Name</b>	<b>Parameter Description</b>	<b>Default Value</b>	<b>Update</b>	<b>Output Only</b>
EXCICALLBYREF	EXCI CALL BY REFERENCE. (YES, NO)  This parameter controls how parameters are passed via the SHADOW_CICS interface. The default method is call by value. If set to YES, the parameter passing method is call by reference.	<b>NO</b>	Yes	No
EXCICONNECTIONNAME	EXCI DEFAULT CONNECTION NAME.  This parameter specifies the default CICS connection name for EXCI support.	<b>'EXCS'</b>	Yes	No
EXCIDATACONV	EXCI CONVERT NULLS TO BLANKS. (YES, NO)  This parameter controls the conversion of null bytes to blanks for the CICS Transaction Mainframe Adapter Server.	<b>YES</b>	Yes	No
EXCIPIEPREALLOC	PREALLOCATE EXCI PIPES. (YES, NO)  This parameter specifies whether or not EXCI pipes are preallocated and opened for use.	<b>YES</b>	No	No
EXCIPIEPREOPEN	PREOPEN EXCI PIPES. (YES, NO)  This parameter specifies whether of not EXCI pipes are preallocated and preopened for use.	<b>YES</b>	No	No
EXTTRACE	EXCI EXTERNAL TRACE.  This parameter specifies whether you want external CICS interface internal tracing, and at what level.	<b>'OFF'</b>	Yes	No
GTF	EXCI GTF TRACE.  This parameter specifies whether all trace entries normally written to the external CICS interface internal trace table are also to be written to an OS/390 or z/OS generalized trace facility (GTF) dataset (if GTF tracing is active).	<b>'OFF'</b>	Yes	No
MDIVIAICICS	EXECUTE MDI RSP VIA CICS. (YES, NO)  This parameter specifies whether or not MDI RSPs are to be executed in the CICS address space.	<b>NO</b>	Yes	No
MSGCASE	EXCI MESSAGE CASE.  This parameter specifies whether the DFHEXxxxx messages are to be issued in mixed- or uppercase.	<b>'MIXED'</b>	Yes	No

PRODCICS Parameter Group				
Parameter Name	Parameter Description	Default Value	Update	Output Only
NEONMRO	INITIALIZE NEON MRO SUPPORT. (YES, NO)  This parameter specifies whether or not the NEONMRO support is initialized.	NO	No	No
SESSIONWAITINTERVAL	SESSION WAIT INTERVAL VALUE.  This parameter specifies the duration of time the task waiting for the EXCI pipe will wait before retrying the DPL request.  <b>Minimum Value: 0</b> <b>Maximum Value: 1000</b>	100 MILLI-SECONDS	Yes	No
SESSIONWAITTIME	SESSION WAIT TIME VALUE.  This parameter specifies the duration of time the caller requesting the EXCI pipe will wait for one to become available.  <b>Minimum Value: 0</b> <b>Maximum Value: 300000</b>	60000 MILLI-SECONDS	Yes	No
TIMEOUT	DPL REQUEST TIMEOUT VALUE.  This parameter specifies the time interval, in hundredths of a second, that the external CICS interface is to wait for a DPL command to complete.  <b>Minimum Value: 1</b> <b>Maximum Value: 2147483647</b>	6000 HUNDREDTHS	Yes	No
TRACESZE	INTERNAL TRACE TABLE SIZE.  This parameter specifies the size in kilobytes of the internal trace table for use by the external CICS interface. This table is allocated in virtual storage above the 16MB line. You should ensure that there is enough virtual storage for the trace table by specifying a large enough region size on the OS/390 or z/OS REGION parameter.  <b>Minimum Value: 16</b> <b>Maximum Value: 1048576</b>	16 KILOBYTES	Yes	No
TRAP	USE EXCI SERVICE TRAP (DFHXCTRA).  This parameter specifies whether the service trap module, DFHXCTRA, is to be used.	'OFF'	Yes	No

**PRODCOMM**

<b>PRODCOMM Parameter Group</b>				
<b>Parameter Name</b>	<b>Parameter Description</b>	<b>Default Value</b>	<b>Update</b>	<b>Output Only</b>
APPLID	VTAM APPLICATION ID.	NULL	Yes	No
BYPASSESENDONEOC	<p>BYPASS EMPTY BUFFER AT END OF CONV. (YES, NO)</p> <p>This parameter will prevent sending the last buffer at connection termination if there is no data and there are no return codes or error messages. This is used to suppress certain SDB4420 messages.</p>	NO	Yes	No
BYPASSCOMPRESSION	<p>BYPASS OUTBOUND DATA COMPRESSION. (YES, NO)</p> <p>This parameter controls if the outbound data stream should be compressed or not. Possible values are:</p> <ul style="list-style-type: none"> <li><b>YES:</b> Outbound data stream will not be compressed. Setting this parameter will increase network load and may reduce host CPU utilization.</li> <li><b>NO:</b> (Default) Normal compression will be used.</li> </ul>	NO	Yes	No
Mainframe Adapter ClientHOSTNAME	<p>Mainframe Adapter Client HOST NAME DATA.</p> <p>This parameter specifies the Host: header sent in an HTTP Mainframe Adapter Client request. HTTP 1.1 requests must have a Host: header.</p>	NULL	Yes	No
Mainframe Adapter ClientREFERRER	<p>Mainframe Adapter Client REFERRER DATA.</p> <p>This parameter specifies the Referrer: header sent in an HTTP Mainframe Adapter Client request. Some Mainframe Adapter Servers may track requests based upon the Referrer: header.</p>	NULL	Yes	No
Mainframe Adapter ClientUSERAGENT	<p>Mainframe Adapter Client USER AGENT DATA.</p> <p>This parameter specifies the User-agent: header sent in an HTTP Mainframe Adapter Client request. The default value is "Mozilla/4.0 (compatible; MSIE 6.0; Windows NT 5.0; Q312461)", which has it imitate an IE browser on a Windows NT machine. Some Mainframe Adapter Servers may depend upon validating various versions of Mainframe Adapter Client software.</p>	'MOZILLA/4.0 (COMPATIBLE; MSIE 6.0; WINDOWS NT 5.0; Q312461)'	Yes	No

PRODCOMM Parameter Group				
Parameter Name	Parameter Description	Default Value	Update	Output Only
CONNECTRETRYINT	<p>CONNECT RETRY INTERVAL.</p> <p>This parameter controls how long the main product address space waits between attempts to connect to any of the TCP/IP subsystems. This field is specified in seconds.</p> <p><b>Minimum Value: 30</b> <b>Maximum Value: None</b></p>	<b>300 SECONDS</b>	Yes	No
CONNECTTIMEOUT	<p>TCP/IP CONNECT READ TIMEOUT VALUE.</p> <p>This parameter is the time-out value for several host operations, as follows:</p> <ul style="list-style-type: none"> <li>For Shadow only: This parameter's most important use is to control how long the host will wait for a Mainframe Adapter Client TCP/IP (IBM, Interlink, and NSC) connection to complete.</li> <li>Interlink TCP/IP code uses this field as the time-out value for directory services requests.</li> </ul>	<b>20</b>	Yes	No
DVIPABINDALL	<p>DYNAMIC VIPA BIND ALL ADDRESSES. (YES, NO)</p> <p>This parameter, if set to YES, allows Shadow to bind two sets of sockets, one to the Dynamic VIPA address, and one set to INADDR_ANY, allowing connections to come in on the main TCP/IP stack IP addresses, as well as on the Dynamic VIPA address.</p>	<b>NO</b>	No	No
GROUPDYNAMICVIPA	<p>GROUP DYNAMIC VIPA IP ADDRESS.</p> <p>This parameter specifies the IP address of the Dynamic VIPA address to bind to for a group address.</p>	<b>NULL</b>	No	No
IBMHSTDOMAIN	<p>IBM HOST DOMAIN NAME.</p>	<b>NULL</b>	Yes	No

PRODCOMM Parameter Group				
Parameter Name	Parameter Description	Default Value	Update	Output Only
IBMPORNUMBER	<p>IBM TCP/IP PORT NUMBER.</p> <p>This parameter sets the port number used to LISTEN for, and ACCEPT all inbound TCP/IP sessions. This port number should be reserved for exclusive use by the main product address space. Each copy of the main product address space will need its own separate port number if TCP/IP is being used. There is a default value for this port number if it is not set in the initialization EXEC.</p> <p><b>Note:</b> The port number can be set to a string of "ANY". This is a special value used to show that the system should assign an ephemeral port number for use by the product.</p>	'0000'	No	No
IBMSSLPORTNUMBER	<p>IBM SSL TCP/IP PORT NUMBER.</p> <p>This parameter sets the port number used to LISTEN for, and ACCEPT all inbound encrypted TCP/IP sessions. This port number should be reserved for use only by the main product address space. Each copy of the main product address space will need its own port number if SSL over TCP/IP is being used. There is a default value for the SSL port number if the value is not set in the initialization EXEC.</p> <p><b>Minimum Value: 0</b> <b>Maximum Value: 32767</b></p>	0	No	No
ITCHOSTDOMAIN	INTERLINK HOST DOMAIN NAME.	NULL	Yes	No
ITCKEEPALIVEOPTION	ITC/IP KEEPALIVE OPTION.	NODATA/ ABORT	Yes	No
ITCKEEPALIVETIME	ITC/IP KEEPALIVE TIME.	15 MINUTES	Yes	No
ITCLISTENQDEPTH	ITC/IP LISTEN QUEUE DEPTH.	5	No	No
ITCMAXBUFFERSIZE	<p>ITC/IP MAXIMUM BUFFER SIZE.</p> <p>This parameter indicates the maximum Interlink TCP/IP buffer size for TREC/TSEND. The default value is obtained from the TIB which is returned via the TINFO call. This parameter can be set by the user to override the TIB value.</p> <p><b>Minimum Value: 512</b> <b>Maximum Value: 32000</b></p>	0	No	No



PRODCOMM Parameter Group				
Parameter Name	Parameter Description	Default Value	Update	Output Only
ITCPORTNUMBER	INTERLINK TCP/IP PORT NUMBER. <b>Minimum Value: 0</b> <b>Maximum Value: 32767</b>	1200	No	No
ITCSSLPORTNUMBER	INTERLINK SSL PORT NUMBER. This parameter sets the port number used to LISTEN for, and ACCEPT all inbound encrypted Interlink TCP/IP sessions. This port number should be reserved for use only by the main product address space. Each copy of the main product address space will need its own port number if SSL over Interlink is being used. There is a default value for the SSL port number if the value is not set in the initialization EXEC. <b>Minimum Value: 0</b> <b>Maximum Value: 32767</b>	0	No	No
ITCSUBSYSTEM	LOCAL ITC/IP SUBSYSTEM NAME.	NULL	Yes	No
ITCTCLOSETIMEOUT	TCLOSE TIMEOUT VALUE. This parameter specifies whether or not the main Interlink TCP/IP listener task waits on a time-out ECB to be posted. This parameter is a circumvention for an invalid CMTC problem which causes the attached task to go to EOT very early and, as a result, the mother task waits indefinitely for a TCLOSE OPTCD=OLD to occur. <b>Minimum Value: 0</b> <b>Maximum Value: 60000</b>	0 MILLI-SECONDS	Yes	No
KEEPALIVE	HTTP PERSISTENT SESSION REUSE SUPPORT. (YES, NO) This parameter determines whether the Shadow Mainframe Adapter Server will honor Connection: and Keep-alive: headers for in-bound HTTP/1.0 requests. Possible values are: <ul style="list-style-type: none"> <li><b>YES:</b> The Shadow Mainframe Adapter Server will attempt to honor in-bound headers which request persistent session support.</li> <li><b>NO:</b> (Default) The Shadow Mainframe Adapter Server ignores in-bound headers which request persistent session support for all HTTP/1.0 requests.</li> </ul>	NO	Yes	No

PRODCOMM Parameter Group				
Parameter Name	Parameter Description	Default Value	Update	Output Only
KEEPALIVELIMIT	<p>HTTP PERSISTENT SESSION RE-USE LIMIT.</p> <p>This parameter sets a limit on how many times an HTTP persistent session is left open for immediate re-use by the downstream user-agent. A small number is recommended when most downstream user-agents are desktop Web browsers. A larger number is recommended when the downstream user-agent is known to be a proxy Mainframe Adapter Server.</p> <p><b>Minimum Value: 1</b> <b>Maximum Value: 512</b></p>	5	Yes	No
KEEPALIVETIMEOUT	<p>HTTP PERSISTENT SESSION RE-USE TIMEOUT.</p> <p>This parameter specifies how long to let persistent sessions wait for another HTTP request to arrive on a session kept open for reuse.</p> <p><b>Minimum Value: 20</b> <b>Maximum Value: 60000</b></p>	4000 MILLI-SECONDS	Yes	No
LINKDISPLAYTYPE	<p>TCPIP Mainframe Adapter Client LINK DISPLAY ARCHITECTURE.</p> <p>This parameter can be set to select the method used to track Mainframe Adapter Client IP connection information. Possible values are:</p> <ul style="list-style-type: none"> <li>• <b>DEFAULT:</b> (Default) The Mainframe Adapter Server bases the organization upon the NETMODE used by the Mainframe Adapter Server.</li> <li>• <b>LINK:</b> The Mainframe Adapter Server organizes Mainframe Adapter Client IP connection information into a linear list and displays it using the ISPF Links application display panel.</li> <li>• <b>TREE:</b> The Mainframe Adapter Server organizes Mainframe Adapter Client IP connection information into a 4-level tree structure, based upon the dot-notation IP address. The information can be displayed using the ISPF IP Tree application display panel.</li> </ul>	DEFAULT	Yes	No

PRODCOMM Parameter Group				
Parameter Name	Parameter Description	Default Value	Update	Output Only
MAXUDPSIZE	<p>MAXIMUM UDP DATAGRAM SIZE.</p> <p>This parameter determines the maximum size of any UDP datagrams sent from the host to a Mainframe Adapter Client. Any buffers larger than this value will be broken into multiple pieces. This value includes the size of the UDP prefix. This means that the actual amount of data sent will be somewhat smaller than the maximum value.</p> <p><b>Minimum Value: 4096</b> <b>Maximum Value: 65536</b></p>	8192 BYTES	Yes	No
MEMBERDYNAMICVIPA	<p>MEMBER DYNAMIC VIPA IP ADDRESS.</p> <p>This parameter specifies the IP address of the Dynamic VIPA address to bind to for a member address</p>	NULL	No	No
MSGROUTEFROM1	<p>MESSAGE ROUTE FROM CONNECTION 1.</p> <p>This parameter specifies names of output device connections that are to be re-routed to other devices.</p>	NULL	No	No
MSGROUTEFROM2	MESSAGE ROUTE FROM CONNECTION 2.	NULL	No	No
MSGROUTETO1_1	MESSAGE ROUTE TO CONNECTION 1.	NULL	No	No
MSGROUTETO1_2	MESSAGE ROUTE TO CONNECTION 2.	NULL	No	No
MSGROUTETO1_3	MESSAGE ROUTE TO CONNECTION 3.	NULL	No	No
MSGROUTETO1_4	MESSAGE ROUTE TO CONNECTION 4.	NULL	No	No
MSGROUTETO1_5	MESSAGE ROUTE TO CONNECTION 5.	NULL	No	No
MSGROUTETO2_1	MESSAGE ROUTE TO CONNECTION 2.	NULL	No	No
MSGROUTETO2_2	MESSAGE ROUTE TO CONNECTION 2.	NULL	No	No
MSGROUTETO2_3	MESSAGE ROUTE TO CONNECTION 3.	NULL	No	No
MSGROUTETO2_4	MESSAGE ROUTE TO CONNECTION 4.	NULL	No	No
MSGROUTETO2_5	MESSAGE ROUTE TO CONNECTION 5.	NULL	No	No
NETMODE	<p>NETWORK EXECUTION MODE.</p> <p>This parameter controls how UDP and TCP/IP are used. The modes control if the main address space handles UDP or TCP/IP sessions and how many tasks are used to accept inbound sessions.</p>	NONE	No	No

PRODCOMM Parameter Group				
Parameter Name	Parameter Description	Default Value	Update	Output Only
NETWORKADJUST	<p>NETWORK BUFFER ADJUSTMENT FACTOR.</p> <p>This parameter controls what fraction of the communication buffer should be reserved to allow for buffer overflow. If the field is set to 20, then 1/20th of the buffer will be reserved. If it is set to 5, 1/5th of the buffer will be reserved. This value should be reduced if buffer overflow errors occur.</p> <p><b>Minimum Value: 3</b> <b>Maximum Value: 100</b></p>	<b>20</b>	Yes	No
NETWORKBUFFERSIZE	<p>MAXIMUM NETWORK I/O BUFFER SIZE.</p> <p>This parameter controls the size of the buffer used to receive blocks of data from the network. A failure will occur if a Mainframe Adapter Client application sends a buffer larger than the maximum size. This value should be raised to allow larger blocks of data to be sent to and from the Mainframe Adapter Client.</p> <p><b>Minimum Value: 0</b> <b>Maximum Value: 4194304</b></p>	<b>512K</b>	No	No
OEASYNCIO	<p>OE SOCKETS ASYNC I/O. (YES, NO)</p> <p>This parameter controls if Async OE Sockets calls should be used or not. Possible values are:</p> <ul style="list-style-type: none"> <li><b>YES:</b> Async I/O will be used with OE Sockets. Async I/O is faster than synchronous I/O, but there are bugs in OE Sockets that sometimes prevent Async I/O from working.</li> <li><b>NO:</b> (Default) Async I/O will not be used with OE Sockets.</li> </ul>	<b>NO</b>	No	No

PRODCOMM Parameter Group				
Parameter Name	Parameter Description	Default Value	Update	Output Only
OEHOSTDOMAIN	<p>OE SOCKETS HOST DOMAIN NAME.</p> <p>This parameter specifies the fully qualified internet host domain name to be used by this Mainframe Adapter Server when constructing fully-qualified HTTP URLs and domain settings for HTTP cookies. The OEHOSTDOMAIN parameter is used only for OE Sockets TCP/IP connections. The IBMHOSTDOMAIN and ITCHOSTDOMAIN parameters set the MVS TCP/IP and Interlink TCP/IP host domains, respectively.</p> <p>The setting of this parameter can have a significant impact on whether web browsers correctly store and later re-transmit HTTP cookie values sent to it from this Mainframe Adapter Server.</p> <p>Many Web browsers will not store HTTP cookies when the domain name is set unless the name contains at least 3 embedded periods (2 periods if the name ends with .com, .edu, .net, .org, .gov, .mil, or .int). Other browsers may fail to transmit cookies properly unless this name is entirely lowercase.</p> <p>For this reason, the Mainframe Adapter Server will automatically convert any value you specify for this parameter to lower case, and will issue a warning message if it does not contain sufficient qualification.</p>	NULL	Yes	No
OEKEEPALIVETIME	<p>OE SOCKETS KEEPALIVE TIME.</p> <p>This parameter utilizes the TCP/IP keepalive facility to detect that a connection is likely no longer valid and force a disconnect. If no data is transferred on a connection in the interval coded here, then the connection is tested and if no response is received, it is disconnected and any resources using it are freed. The smaller the value, the sooner invalid connections will be cleaned up but the possibility of disconnecting slow connections will be greater.</p> <p><b>Minimum Value: 15</b> <b>Maximum Value: 120</b></p>	15 MINUTES	Yes	No

PRODCOMM Parameter Group				
Parameter Name	Parameter Description	Default Value	Update	Output Only
OENLPORTNUMBER	<p>OE NON-LOAD BALANCED PORT NUMBER.</p> <p>This parameter sets the port number used to LISTEN for, and ACCEPT all inbound TCP/IP sessions that should not be considered candidates for load balancing to a different Shadow Mainframe Adapter Server in the same load balancing group. The port number should be reserved for exclusive use by the main product address space. This must be different than the main OEPORTRNUMBER and the OESSLPORT number, if it is used.</p> <p><b>Minimum Value: 0</b> <b>Maximum Value: 32767</b></p>	'1201'	No	No
OEPORTRNUMBER	<p>OE SOCKETS PORT NUMBER.</p> <p>This parameter sets the port number used to LISTEN for, and ACCEPT all inbound OE Sockets TCP/IP sessions. This port number should be reserved for exclusive use by the main product address space. Each copy of the main product address space will need its own separate port number if TCP/IP is being used. There is a default value for this port number if it is not set in the initialization EXEC.</p> <p><b>Note:</b> That the port number can be set to a string of "ANY". This is a special value used to show that the system should assign an ephemeral port number for use by the product.</p>	'1200'	No	No
OESSLPORTNUMBER	<p>OE SOCKETS SSL PORT NUMBER.</p> <p>This parameter sets the port number used to LISTEN for, and ACCEPT all inbound encrypted OE Sockets TCP/IP sessions. This port number should be reserved for use only by the main product address space. Each copy of the main product address space will need its own port number if SSL over OE Sockets is being used. There is a default value for the SSL port number if the value is not set in the initialization EXEC.</p> <p><b>Minimum Value: 0</b> <b>Maximum Value: 32767</b></p>	0	No	No

<b>PRODCOMM Parameter Group</b>				
<b>Parameter Name</b>	<b>Parameter Description</b>	<b>Default Value</b>	<b>Update</b>	<b>Output Only</b>
OESTACK	OE SOCKETS TCP/IP STACK NAME. This parameter is used to specify the name of the OE TCP/IP stack that should be used. For OE TCP/IP, this parameter is optional. If this parameter is not set, then the default OI stack will be used. If this parameter is used to select an OE TCP/IP stack, then the value must be one of the SUBFILESYSTYPE values specified in the PBXPRMxx PARMLIB member.	NULL	No	No
RDBMSINTERFACEPROXY	REMOTE DBMS INTERFACE PROXY. This parameter specifies the host name of the remote DBMS proxy for use by a Mainframe Adapter Client request. Initially, this must be an IP address.	NULL	Yes	No
RDBMSINFCPROXYPORT	REMOTE DBMS PROXY PORT. This parameter specifies the port number of a proxy to use when generating a Mainframe Adapter Client request to a remote DBMS Mainframe Adapter Server to invoke the Shadow interface code on that Mainframe Adapter Server. <b>Minimum Value: 0</b> <b>Maximum Value: 32767</b>	80	Yes	No
RDBMSINTERFACEURL	REMOTE DBMS INTERFACE URL. This parameter specifies the URL path to include when generating a Mainframe Adapter Client request to a remote DBMS Mainframe Adapter Server to invoke the Shadow interface code on that Mainframe Adapter Server. This is part of the support for accessing a remote DBMS.	HTTP://1.2.3.4:80/CG	Yes	No
RDBMSHTTP11	REMOTE DBMS HTTP PROTOCOL 1.1. (YES, NO) This parameter is used to specify that the Mainframe Adapter Client protocol to use to contact the remote Mainframe Adapter Server is HTTP/1.1 instead of the default HTTP/1.0.	NO	Yes	No

PRODCOMM Parameter Group				
Parameter Name	Parameter Description	Default Value	Update	Output Only
SOCKETLINGER	<p>SOCKET LINGER TIME.</p> <p>This parameter controls the socket linger time for IBM TCP/IP and IBM OE Sockets. If set to 0, socket linger is turned off. If set to a non-zero value, the socket linger is turned on and set for the number of seconds specified by this parameter.</p> <p><b>Minimum Value: 0</b> <b>Maximum Value: 120</b></p>	<b>20 SECONDS</b>	No	No
SSLACCEPTTIMEOUT	<p>SSL ACCEPT WAIT TIMEOUT.</p> <p>This parameter determines how long the Mainframe Adapter Server will wait on receives during SSL acceptance processing. This value is used during ACCEPT processing (instead of CONNECTTIMEOUT) because the end user may need to verify the Mainframe Adapter Server certificate or perform other human speed operations.</p> <p><b>Minimum Value: 20</b> <b>Maximum Value: 3600</b></p>	<b>180 SECONDS</b>	Yes	No
TCPMAXSESSIONS	<p>IBM MAXIMUM SESSIONS.</p> <p><b>Minimum Value: 0</b> <b>Maximum Value: 25000</b></p>	<b>200</b>	No	No
TCPMSGLIM	<p>TCP/IP IUCV MESSAGE LIMIT.</p> <p>This parameter displays the final number of IUCV messages that can be concurrently outstanding on each IUCV path. The value will be 10 for IBM MVS TCP/IP API type 2 and 255 for API type 3. This value should not be set and is actually output only at this time.</p> <p><b>Minimum Value: 1</b> <b>Maximum Value: 255</b></p>	<b>0</b>	No	No
TCPNAME	<p>LOCAL TCP/IP STARTED TASK NAME.</p>	<b>NULL</b>	No	No



PRODCOMM Parameter Group				
Parameter Name	Parameter Description	Default Value	Update	Output Only
UDPTIMEOUT	<p>UDP SESSION TIMEOUT.</p> <p>This parameter determines how long UDP session information is kept in memory before it is released. The value should be long enough to allow for some number I/O errors and retries. If the value is too high, large amounts of storage will be used. If the value is too small, retry operations may fail. This value is not related to FAILWAITTIME and does not limit how long an application can wait between sending separate requests to the host.</p> <p><b>Minimum Value: 60</b> <b>Maximum Value: 3600</b></p>	<b>300 SECONDS</b>	No	No
VTAMEXITS	<p>ENABLE VTAM SCIP/LOGON EXITS. (YES, NO)</p>	<b>NO</b>	Yes	No
ZMainframe Adapter ClientDEFAULTURL	<p>ZMainframe Adapter Client IFC DEFAULT URL.</p> <p>This parameter specifies the default URL to be configured on the off host remote DBMS Web Server to refer to the Perl script.</p>	<b>‘/SDNACLIF’</b>	Yes	No
ZMainframe Adapter ClientHTTP11	<p>ZMainframe Adapter Client HTTP PROTOCOL 1.1. (YES, NO)</p> <p>Controls the version of HTTP protocol. YES indicates to use HTTP/1.1 protocol, while NO indicates to use HTTP/1.0 protocol.</p>	<b>NO</b>	Yes	No
ZMainframe Adapter ClientPROXYHOST	<p>ZMainframe Adapter Client INTERFACE PROXY HOST.</p> <p>This parameter specifies the default proxy host for remote DBMS usage. If a proxy is not being used, this parameter can be omitted. Currently, the value must be an IP address, in “dotted decimal” notation.</p>	<b>NULL</b>	Yes	No
ZMainframe Adapter ClientPROXYPORT	<p>ZMainframe Adapter Client PROXY PORT.</p> <p>This parameter specifies the default proxy port for remote DBMS usage. If a proxy is not being used or the proxy port is 80, this parameter can be omitted. The value must be an integer.</p> <p><b>Minimum Value: 1</b> <b>Maximum Value: 65535</b></p>	<b>80</b>	Yes	No

**PRODEVENT**

PRODEVENT Parameter Group				
Parameter Name	Parameter Description	Default Value	Update	Output Only
MONRESPONSETIME	<p>MONITOR RESPONSE TIME FROM Mainframe Adapter Client. (YES, NO)</p> <p>This parameter specifies whether to enable monitoring of the Mainframe Adapter Client response time.</p> <ul style="list-style-type: none"> <li><b>NO:</b> (Default) Mainframe Adapter Client response time will not be monitored.</li> <li><b>YES:</b> Mainframe Adapter Client response time will be monitored if application names have been defined in the Shadow Mainframe Adapter Server initialization EXEC using the <b>DEFINE RTMONAPP</b> statement.</li> </ul>	<b>NO</b>	Yes	No
SCEVENTINTERVAL	<p>SHADOW CONSOLE EVENT SCAN INTERVAL.</p> <p>This parameter determines the time interval (in seconds) to be used between scans of the trace browse buffers to look for installation-defined "events."</p> <p><b>Minimum Value: 1</b> <b>Maximum Value: 60</b></p>	<b>3 SECONDS</b>	Yes	No
SCEVENTMainframe Adapter Server	<p>ACTIVATE SHADOW CONSOLE EVENT Mainframe Adapter Server. (YES, NO)</p> <p>This parameter specifies whether the Shadow Console Event Mainframe Adapter Server will be started if the Shadow Mainframe Adapter Server is licensed for it.</p> <ul style="list-style-type: none"> <li><b>YES:</b> (Default) The Shadow Console Event Mainframe Adapter Server will be started if licensed.</li> <li><b>NO:</b> The Shadow Console Event Mainframe Adapter Server will not be started even if licensed.</li> </ul>	<b>YES</b>	No	No

## PROFILE

PROFILE Parameter Group				
Parameter Name	Parameter Description	Default Value	Update	Output Only
DFHSM	<p>DFHSM SUPPORT ENABLED WITHIN Mainframe Adapter Server. (YES, NO)</p> <p>This parameter specifies whether the Mainframe Adapter Server should pre-initialize DFHSM support during start-up. Possible values are:</p> <ul style="list-style-type: none"> <li><b>YES:</b> Initialization is attempted. If the initialization is successful, authorized DFHSM processing can be performed once start-up has completed. If errors are detected during initialization, warning message(s) are issued and DFHSM support is disabled.</li> <li><b>NO: (Default)</b> No pre-initialization is performed and authorized DFHSM services will be unavailable within the Mainframe Adapter Server.</li> </ul> <p><b>Note:</b> If disabled, no additional DFHSM processing of any kind, including clean-up of outstanding DFHSM MWE control blocks remaining after the last product shutdown is performed.</p>	NO	No	No
DFHSMCLEANUP-INTERVAL	<p>DFHSM PENDING REQUEST CLEANUP INTERVAL.</p> <p>This parameter controls how often a check for pending in-flight HRECALL requests is made. Requests which time out are abandoned by transaction subtasks but must be cleaned up. Failure to free the DFHSM MWE ECBs can leave below-the-line CSA storage areas permanently allocated. The interval value is specified in seconds and should be a factor of one hour. In other words, the value should divide evenly into 3600. The interval is automatically set to 3600 (1 hour) if DFHSM support is not enabled during start-up.</p> <p><b>Minimum Value: 15</b> <b>Maximum Value: 3600</b></p>	3600 SECONDS	Yes	No

PRODFILE Parameter Group				
Parameter Name	Parameter Description	Default Value	Update	Output Only
DFHSM DRAIN	<p>DFHSM DRAIN MODE IS IN EFFECT. (YES, NO)</p> <p>This parameter can be set manually to prevent the Shadow Mainframe Adapter Server from scheduling new HRECALL requests. The Shadow Mainframe Adapter Server continues to monitor already inflight requests for completion and free the associated MWE control blocks. The Shadow Mainframe Adapter Server, itself, will set this parameter to YES if more than 125 pending HRECALL requests are outstanding. It will then restore this parameter to NO once the number of pending requests drops below 100, providing no manual changes to this parameter or to the DFHSMSTATUS parameter are made. Any manual change prevents the Shadow Mainframe Adapter Server from automatically restoring full non-drain processing.</p> <p><b>Note:</b> This parameter is always set to NO by the Shadow Mainframe Adapter Server any time you manually set the DFHSMSTATUS parameter.</p>	NO	Yes	No
DFHSM DRAIN AUTO	<p>Mainframe Adapter Server SHOULD AUTO-RESET DFHSM DRAIN. (YES, NO)</p> <p>This parameter is an output-only field which is set to YES only after the Shadow Mainframe Adapter Server itself has changed DFHSM DRAIN to YES. While this parameter is set to YES, the Shadow Mainframe Adapter Server is responsible for resetting DFHSM DRAIN to NO once sufficient HRECALL completions have been detected to allow new requests to be scheduled. Manually changing either DFHSMSTATUS or DFHSM DRAIN causes this parameter to be set to NO, and prevents the Shadow Mainframe Adapter Server from resetting DFHSM DRAIN automatically.</p>	NO	No	Yes

PROFILE Parameter Group				
Parameter Name	Parameter Description	Default Value	Update	Output Only
DFHSMSTATUS	<p>DFHSM SERVICES ARE OFFLINE/ONLINE.</p> <p>This parameter can be manually set during normal Shadow Mainframe Adapter Server operations to temporarily suspend all Shadow Mainframe Adapter Server interactions with DFHSM. The Shadow Mainframe Adapter Server continues to remember all pending HRECALL requests and will attempt to complete them and free the associated MWE blocks once this parameter is restored to ONLINE. Administrators can use this option to temporarily suspend DFHSM processing during times when DFHSM services are unavailable, or DFHSM is being restarted.</p> <p><b>Note:</b> Whenever this parameter is manually altered, the DFHSM DRAIN parameter is automatically reset to NO.</p>	ONLINE	Yes	No
FILECACHE	<p>DYNAMIC FILE CACHE OPTION.</p> <p>This parameter allows the user to control whether or not to cache data retrieved from files. This will improve performance; however, the file must be closed and re-opened in order to refresh the cache. Valid options are:</p> <ul style="list-style-type: none"> <li>• <b>ALL:</b> (Default) To cache all data.</li> <li>• <b>NONE:</b> To inhibit caching.</li> <li>• <b>DIR:</b> To only cache PDS directories.</li> </ul>	ALL	Yes	No

PRODFILE Parameter Group				
Parameter Name	Parameter Description	Default Value	Update	Output Only
FILEHRECALL	<p>DYNALLOC-TO-DFHSM RECALL CONVERSION.</p> <p>This parameter determines whether or not to internally convert dynamic allocation dataset recall requests to asynchronous DFHSM HRECALL operations. Conversion of these requests can prevent system hangs upon the SYSZTIOT resource. When the DYNALLOC SVC handles dataset recalls internally, long-term enqueues can be generated upon SYSZTIOT if a migrated dataset cannot be recalled quickly. All other DYNALLOC requests stack up behind this enqueue.</p> <p>This parameter is ignored if DFHSM support is not enabled or is currently suspended. This parameter controls recall operations whenever dataset allocation is performed for SDBALLOC operations operating with RECALL set to YES or using the system-wide default action of FILERECALL set to YES.</p> <p>The FILEHRECALL parameter may be set to one of the following values:</p> <ul style="list-style-type: none"> <li>• <b>ALLOCATE:</b> (Default) The DYNALLOC-to-DFHSM recall conversion is not performed. When dataset recall is necessary (and allowed), the DYNALLOC SVC handles dataset in-migration.</li> <li>• <b>CONVERT.</b> Dynamic allocation requests are issued with the “no-migration” flag set on. If DYNALLOC fails with an indication that data recall is required (i.e. SVC 99 error x'278'), DFHSM HRECALL is issued internally as a timed asynchronous request. If the HRECALL completes in the allowed time period, the dynamic allocation request is retried. The dynamic allocation request fails if HRECALL fails or the time period allowed expires.</li> </ul>	ALLOCATE	Yes	No
FILEMESSAGES	<p>CONSOLE MESSAGES FROM DYNAMIC ALLOCATION. (YES, NO)</p> <p>This parameter determines whether or not to allow a dynamic allocation error messages to be displayed upon the system console. This parameter only affects dynamic allocation requests made through the SDBALLOC application programming interface.</p>	YES	Yes	No

PRODFILE Parameter Group				
Parameter Name	Parameter Description	Default Value	Update	Output Only
FILEIOMODE	<p>FILE I/O ADDRESSING MODE.</p> <p>This parameter allows the user to control whether to use the 31 bit addressing mode for file I/O or use the 24-bit addressing mode for file I/O. The 31-bit file I/O processing is limited to systems with DFSMS enabled.</p>	31	Yes	No
FILEMOUNT	<p>MOUNT VOLUMES FOR DYNAMIC ALLOCATION. (YES, NO)</p> <p>This parameter determines whether or not to allow a volume to be mounted to satisfy a dynamic allocation request. This parameter only affects dynamic allocation requests made through the SDBALLOC application programming interface.</p>	YES	Yes	No
FILERECALL	<p>RECALL FILES FOR DYNAMIC ALLOCATION. (YES, NO)</p> <p>This parameter determines whether or not to allow a dataset to be recalled by HSM to satisfy a dynamic allocation request. This parameter only affects dynamic allocation requests made through the SDBALLOC application programming interface.</p>	YES	Yes	No
FILEREXXTOOL-RECALL	<p>FILE REXXTOOL RECALL PROCESSING.</p> <p>This parameter determines whether dataset recall is used when processing Shadow/REXXTools dynamic allocation requests. It specifies how migrated datasets are handled when dynamic allocation is requested. Possible values are:</p> <ul style="list-style-type: none"> <li>• <b>AUTO:</b> (Default) Recall processing is handled as specified by the FILEHRECALL and HRECALLWAIT parameters. Use of this option is recommended for all new customers.</li> <li>• <b>ALLOCATE:</b> Dataset in-migration for requests are handled by dynamic allocation processing. Existing customers may wish to set this option to maintain operational compatibility with previous release of the product (this allows for no time out on recall requests and may lead to hangs within SVC99 upon the SYSZTIOT queue name).</li> <li>• <b>FAIL:</b> Dataset recall is not allowed and if a migrated dataset is requested, the dynamic allocation request fails.</li> </ul>	AUTO	Yes	No

PRODFILE Parameter Group				
Parameter Name	Parameter Description	Default Value	Update	Output Only
FILESECURITY	<p>DYNAMIC FILE SECURITY OPTION.</p> <p>This parameter allows the user to control the userid to use when validating access to a file. The valid operations are:</p> <ul style="list-style-type: none"> <li>• <b>SUBSYS:</b> (Default) Use the userid assigned to the Shadow Mainframe Adapter Server.</li> <li>• <b>USERID:</b> Use the userid assigned to the Mainframe Adapter Client.</li> </ul>	SUBSYS	Yes	No
FILESHAREDEN	<p>DEFINE NEW DDNAMES DYNAMICALLY. (YES, NO)</p> <p>This parameter allows the user to control whether or not to share ddnames whenever possible. If a ddname is already open due to a previous allocation, parameter controls whether or not the ddname can be accessed by multiple users or does the ddname need to be re-allocated to another ddname for a subsequent user.</p>	YES	Yes	No
FILESHAREDEN	<p>DEFINE NEW DSNAMES DYNAMICALLY. (YES, NO)</p> <p>This parameter allows the user to control whether or not to share dataset names when possible. If a dataset is already open due to a previous allocation, parameter controls whether or not the dataset can be accessed by multiple user's or does the dataset need to be re-allocated to another ddname for a subsequent user.</p>	NO	Yes	No
GDGLOCS	<p>GDG LOCATE CATALOG SEARCH. (YES, NO)</p> <p>This parameter allows the user to control how GDG relative generation numbers are located. GDG information is either based upon the GDG status the first time the product dynamically allocates a GDG dataset, or the catalog is searched each time the dataset is allocated. The default is GDG information is based upon the GDG status the first time the product allocates the file.</p>	NO	Yes	No



PRODFILE Parameter Group				
Parameter Name	Parameter Description	Default Value	Update	Output Only
HRECALLWAIT	<p>WAIT TIME LIMIT FOR HRECALL.</p> <p>This parameter determines how long the Mainframe Adapter Server suspends task execution to await recall completion when DFHSM HRECALL is used for dataset in-migration. If set to 0 (zero), HRECALL requests are issued without waiting on completion. Dataset recall is scheduled using DFHSM, but the Shadow Mainframe Adapter Server does not wait on completion. The dataset access operation fails and must be retried later.</p> <p><b>Note:</b> When a 0 (zero) time limit is specified, the Shadow Mainframe Adapter Server does not track HRECALL requests in any way. Any positive number in the range 1 to 32767 determines the number of seconds to await recall completion. If HRECALL does not complete within the allotted time, the original request fails and must be retried.</p> <p><b>Minimum Value: 0</b> <b>Maximum Value: 32767</b></p>	45 SECONDS	Yes	No
HRECALLWAITMAX	<p>MAX HRECALL WAIT TIME FOR SWSALLOC.</p> <p>This parameter determines the maximum HRECALL wait time that may be specified explicitly by an SDBALLOC application programming interface request using the RECALLWAIT() keyword for cases when DFHSMHRECALL is used for dataset in-migration.</p> <p>If an individual SDBALLOC request attempts to specify a longer wait time limit than is imposed by this parameter, the value specified by this parameter is substituted. See "HRECALLWAIT" for a description of the HRECALL wait time limits.</p> <p><b>Minimum Value: 0</b> <b>Maximum Value: 32767</b></p>	45 SECONDS	Yes	No

**PRODGLV**

PRODGLV Parameter Group				
Parameter Name	Parameter Description	Default Value	Update	Output Only
GLOBALADDR	GLOBAL WORKSPACE BLOCK ADDRESS.	X'1523E000'	No	Yes
GLOBALALLOC	NUMBER OF ALLOCATED GLOBAL VARIABLE BLOCKS.	142	No	Yes
GLOBALBACKUP-COUNT	GLOBAL VARIABLE BACKUP COUNT.	0	No	Yes
GLOBALBACKUPEND	GLOBAL LAST BACKUP END TIME.	NONE	No	Yes
GLOBALBACKUP-INTVAL	INTERVAL BETWEEN GLOBAL VARIABLE BACKUPS. <b>Minimum Value: 0</b> <b>Maximum Value: 32767</b>	0 MINUTES	Yes	No
GLOBALBACKUPNEXT	GLOBAL BACKUP NEXT START TIME.	NONE	No	Yes
GLOBALBACKUPPROC	GLOBAL VARIABLE BACKUP PROC NAME.	'SDBBGVBK'	Yes	No
GLOBALBACKUPSTART	GLOBAL LAST BACKUP START TIME.	NONE	No	Yes
GLOBALBLOCKS	GLOBAL CHECKPOINT BLOCK COUNT.	313 PAGES	No	Yes
GLOBALBLOCKSUSED	NUMBER OF GLOBAL VARIABLE BLOCKS IN USE.	83	No	Yes
GLOBALCHECKCOUNT	GLOBAL CHECKPOINT COUNT.	1 CHECKPOINT	No	Yes
GLOBALDATE	GLOBAL LAST CHECKPOINT DATE.	YYYY/MM/DD	No	Yes
GLOBALDIV	GLOBAL VARIABLES SHOULD USE DIV. (YES, NO).	YES	No	No
GLOBALFREE	NUMBER OF FREE GLOBAL VARIABLE BLOCKS.	0	No	Yes
GLOBALFREEAREAS	NUMBER OF FREE AREAS IN GLOBAL WORKSPACE.	0	No	Yes
GLOBALINTERVAL	GLOBAL VARIABLES CHECKPOINT INTERVAL. <b>Minimum Value: 1</b> <b>Maximum Value: 300</b>	15 SECONDS	Yes	No
GLOBALLENGTH	GLOBAL WORKSPACE BLOCK LENGTH.	256 BYTES	No	Yes
GLOBALMAX	MAXIMUM NUMBER OF GLOBAL VARIABLES. <b>Minimum Value: 1</b> <b>Maximum Value: None</b>	5000	No	No
GLOBALMSGS	GLOBAL ERROR MESSAGE COUNT.	0	No	Yes

PRODGLV Parameter Group				
Parameter Name	Parameter Description	Default Value	Update	Output Only
GLOBALNEXT	GLOBAL WORKSPACE NEXT FREE OFFSET.	X'00000100'	No	Yes
GLOBALPAGES	GLOBAL WORKSPACE AREA SIZE IN PAGES.	313 PAGES	No	Yes
GLOBALPOOL	GLOBAL WORKSPACE FREE POOL OFFSET.	X'00000000'	No	Yes
GLOBALREBUILD	REBUILD GLOBAL VARIABLE DATABASE.	NONE	Yes	No
GLOBALRETRY	GLOBAL CHECKPOINT RETRY COUNT.	0 CHECKPOINTS	No	Yes
GLOBALSIZE	GLOBAL WORKSPACE BLOCK SIZE.	1250K	No	Yes
GLOBALSUBPOOL	GLOBAL VARIABLES SUBPOOL NUMBER.	TWO	No	No
GLOBALTCB	GLOBAL WORKSPACE TCB ADDRESS.	X'008D1368'	No	Yes
GLOBALTEMPADDR	TEMPORARY GLOBAL WORKSPACE BLOCK ADDRESS.	X'154A8000'	No	Yes
GLOBALTEMPMAX	MAXIMUM NUMBER OF TEMPORARY GLOBAL VARIABLES. <b>Minimum Value: 1</b> <b>Maximum Value: None</b>	5000	No	No
GLOBALTEMPWARNIV	INTERVAL BETWEEN TEMP GLV BLOCKS USED WARNINGS. <b>Minimum Value: 1</b> <b>Maximum Value: 32767</b>	5 MINUTES		
GLOBALTEMPWARNTH	TEMP GLOBAL BLOCKS USED WARNING THRESHOLD. <b>Minimum Value: 1</b> <b>Maximum Value: 100</b>	80%	Yes	No
GLOBALTIME	GLOBAL LAST CHECKPOINT TIME.	'HH:MM:SS'	No	Yes
GLOBALTOKEN	GLOBAL WORKSPACE TOKEN ID.	X'FE38D5800000000'	No	Yes
GLOBALUPDATE	GLOBAL VARIABLES UPDATE COUNT.	0	No	Yes
GLOBALUPDATECHECK	GLOBAL CHECKPOINT UPDATE COUNT.	0	No	Yes
GLOBALUSED	NUMBER OF GLOBAL VARIABLES IN USE.	83	No	Yes
GLOBALWARNINTVAL	INTERVAL BETWEEN GLOBAL BLOCKS USED WARNINGS. <b>Minimum Value: 1</b> <b>Maximum Value: 32767</b>	5 MINUTES	Yes	No

PRODGLV Parameter Group				
Parameter Name	Parameter Description	Default Value	Update	Output Only
GLOBALWARNTHRESH	GLOBAL BLOCKS USED WARNING THRESHOLD. <b>Minimum Value: 1</b> <b>Maximum Value: 100</b>	80%	Yes	No
GLVCHAINMAX	MAXIMUM NUMBER OF CHAINED GLV UPDATES. <b>Minimum Value: 1</b> <b>Maximum Value: 32767</b>	1000	Yes	No
GLVPENDINGMAX	MAXIMUM NUMBER OF PENDING GLV EPROCS. <b>Minimum Value: 1</b> <b>Maximum Value: 32767</b>	100	No	No

**PRODIMS**

PRODIMS Parameter Group				
Parameter Name	Parameter Description	Default Value	Update	Output Only
APPC/IMS	INITIALIZE APPC/IMS SUPPORT. (YES, NO)	YES	No	No
CONVERTNULLS	CONVERT NULLS TO BLANKS. (YES, NO)  This parameter controls the conversion of null bytes to blanks for the IMS Transaction Mainframe Adapter Server. IMS messages may contain MID/MOD indicators which need to be converted to blanks.	NO	Yes	No
DBCTL	INITIALIZE DBCTL SUPPORT. (YES, NO)	YES	No	No
IMSAIBINTERFACE	USE AIB INTERFACE FOR DBCTL. (YES, NO)	NO	No	No
IMSCNV3FCHAR	CONVERT X'3F' TO THIS HEX VALUE.  This parameter will cause mapped fields to be set to this value when the first byte of the field is X'3F'.	X'3F'	Yes	No
IMSLTERMCHARSUBS	LTERM NAME CHARACTER SUBSTITUTION.  This parameter allows character substitution to be performed on the LTERM name derived by use of the LTERM facility. It enables you to selectively substitute a character in the derived LTERM name with a differing character value. The parameter is 16 bytes in length. The first 8 bytes represent the LTERM mask (compare) values and the 8 eight bytes represent the replace values. All 16 bytes must be provided. The character "A" in a mask byte indicates no substitution will occur for the selected byte.  <b>Note:</b> This parameter may be used in conjunction with the IMS LTERM Facility.  <b>Example:</b> The following parameter value would cause the LETERM name sent to IMS to be modified by replacing the "\$" in byte 1 of the LTERM name with "A" and changing the "#" in byte 8 to "B":  IMSLTERMCHARSUBS(\$-----#A-----B)	NULL	Yes	No

PRODIMS Parameter Group				
Parameter Name	Parameter Description	Default Value	Update	Output Only
IMSLTERMTABLESEQ	LTERM ASSIGNMENT TABLE SEQUENCE. This parameter allows the user to control LTERM assignments based upon userid or TCP/IP address when initiating transactions to IMS. Valid options are: <ul style="list-style-type: none"> <li><b>USERID:</b> (Default) Userid match will determine the LTERM name.</li> <li><b>IP ADDRESS:</b> TCP/IP address will determine the LTERM name.</li> <li><b>NONE:</b> Do not assign an LTERM.</li> </ul>	<b>USERID</b>	Yes	No
IMSCCLASS	SNAP DUMP SYSOUT OUTPUT CLASS.	<b>'A'</b>	Yes	No
IMSDDNAME	DDNAME USED TO ALLOCATE RESLIB.	<b>'CCTLDD'</b>	Yes	No
IMSDLIPRMLOC	IMS DLI PARAMETER LIST LOCATION.	<b>ABOVE</b>	Yes	No
IMSDSNAME	DSNAME OF THE DRA RESLIB.	<b>'IMS.RESLIB'</b>	Yes	No
IMSFPBUFFERS	FAST PATH BUFFERS PER THREAD.	<b>0</b>	Yes	No
IMSFPOVERFLOW	FAST PATH OVERFLOW BUFFERS.	<b>0</b>	Yes	No
IMSFUNCLEVEL	FUNCTION LEVEL OF PRODUCT REGION.	<b>X'01'</b>	Yes	No
IMSGROUPNAME	APPLICATION GROUP NAME.	<b>'NONE'</b>	Yes	No
IMSID	IMSID OF THE DBCTL REGION.	<b>'IMS1'</b>	No	No
IMSMAPATTR	MAP IMS ATTRIBUTE FIELDS. (YES, NO) This parameter is used to control whether or not IMS attributes are to be mapped.	<b>YES</b>	Yes	No
IMSMAXTHREADS	MAXIMUM NUMBER OF THREADS. This parameter is the maximum number of allowed DBT threads to be active at one time.	<b>10</b>	Yes	No
IMSMINTHREADS	MINIMUM NUMBER OF THREADS. This parameter is set to the desired amount of DBT threads to open initially when Shadow connects to IMS.	<b>3</b>	Yes	No
IMSNBABUFFERS	TOTAL NUMBER OF NBA BUFFERS.	<b>0</b>	Yes	No
IMSODBA	ACTIVATE IMS/ODBA SUPPORT. (YES, NO) This parameter controls whether the system will initialize the Shadow Mainframe Adapter Server Support for IMS/ODBA.	<b>NO</b>	No	No

<b>PRODIMS Parameter Group</b>				
<b>Parameter Name</b>	<b>Parameter Description</b>	<b>Default Value</b>	<b>Update</b>	<b>Output Only</b>
IMSOTMA	IMS/OTMA INITIALIZE OPTION. (YES, NO)  This parameter is used to control the initialization of Shadow Mainframe Adapter Server Support for ISM/OTMA.	<b>NO</b>	No	No
IMSOTMADEFCON	IMS/OTMA DEFAULT CONNECTION NAME.  This parameter is used to specify a default IMS OTMA connection ID. This allows IMS/OTMA requests to avoid specifying the IMS connection id within an IMS/OTMA request parameter list when the target IMS system is defined as the default IMS connection ID.	<b>IMS1SDBB</b>	Yes	No
IMSOTMADEFMAP	IMS/OTMA DEFAULT MAP NAME.  This parameter is used to specify a default IMS map name to be used for IMS/OTMA requests.	<b>'DFSDSP01'</b>	Yes	No
IMSOTMADEFSEC	IMS/OTMA DEFAULT SECURITY TYPE.  This parameter is used to specify a default IMS/OTMA security type for IMS/OTMA requests which have not passed any security related information within the IMS/OTMA API request.	<b>PROGRAM</b>	Yes	No
IMSPROCOWNER	IMS STORED PROCEDURE OWNER.  This parameter allows the user to specify the procedure owner for IMS stored procedure map.	<b>'IMS'</b>	Yes	No
IMSSUFFIX	SUFFIX OF THE DFSPRPXX MODULE.	<b>'00'</b>	Yes	No
IMSTIMEOUT	DRA TERM TIMEOUT VALUE.	<b>10</b>	Yes	No
IMSUSERID	USERID OF THE PRODUCT REGION.	<b>NULL</b>	Yes	No
IMSWAITTIME	IDENTIFY RETRY WAIT TIME.	<b>60</b>	Yes	No
MAXODBACONNECT	MAXIMUM ODBA STARTUP TABLES.  This parameter controls the maximum number of different IMS/ODBA startup tables that can be used at one time.	<b>8</b>	No	No

## PRODLICENSE

PRODLICENSE Parameter Group				
Parameter Name	Parameter Description	Default Value	Update	Output Only
CONNECTIONTEXT	HOST CONNECTION TEXT STRING.	NULL	Yes	No
CURRENTCPU	CURRENT CPU ID.	'10914'	No	No
DB2CONCURRENTCN	CONCURRENT DB2 USER COUNT.	0	No	No
DB2CONCURRENTHW	CONCURRENT DB2 USER HI-WATER MARK.	12	No	No
DB2CONCURRENTMX	MAXIMUM CONCURRENT DB2 USERS. <b>Minimum Value: 0</b> <b>Maximum Value: 2000</b>	2000	Yes	No
DB2LICCONCURMX	MAXIMUM LICENSED DB2 USERS.	2000	No	No
EXPIRATIONDATE	PRODUCT EXPIRATION DATE.	YYYY/MM/DD	No	No
EXPIRATIONDAYS	DAYS PRIOR TO EXPIRATION.		No	No
FIRSTCPU	FIRST LICENSED CPU ID.	'99999'	No	No
LICENSECODE	PRODUCT LICENSE CODE STRING.		No	No
OEMVENDOR	OEM VENDOR NAME STRING.	'OEM VENDOR'	Yes	No
PRODEXTFEAT	PRODUCT EXTENDED FEATURE CODE STRING.  The extended feature code string (OPMSFEBS) is a bit string (currently 32 bytes long) that indicates the active product features. The first 26 bits correspond to the 26 character product feature string (OPMSFESR). The remaining 230 bits are available for extended features.		No	No
PRODFAMILY	PRODUCT FAMILY CODE PREFIX.	'45'	No	No
PRODFEATURES	PRODUCT FEATURE CODE STRING.		No	No



## PRODLOGGING

PRODLOGGING Parameter Group				
Parameter Name	Parameter Description	Default Value	Update	Output Only
ENABLEINTERVAL	<p>ENABLE INTERVAL PROCESSING. (YES, NO)</p> <p>This product parameter controls if interval processing should be done or not. If this product parameter is set to YES, then interval and interval summary records will be created. These records can be displayed, written to SMF, and logged using DB2 tables.</p>	YES	No	No
LOGAPMVSSUM	<p>LOG APPC/MVS SUMMARY INFO IN A TABLE. (YES, NO)</p> <p>This parameter controls if APPC/MVS interval summary information should be logged or not. APPC/MVS interval summary information is logged by inserting rows into a DB2 table. One row is inserted at the end of each recording level.</p>	NO	Yes	No
LOGAPMVSSUMTABLE	<p>TABLE NAME FOR APPC/MVS SUMMARY LOGGING.</p> <p>This parameter is used to set the name of the DB2 table used to log APPC/MVS interval summary information. A row is inserted into this table at the end of each recording interval, if APPC/MVS interval summary recording is active.</p>	'SHADOW. APMVSSUM'	Yes	No
LOGDB2PLNAME	<p>DB2 PLAN NAME FOR LOGGING OPERATIONS.</p> <p>This parameter controls the plan name used for all SQL operations initiated by Shadow to log performance data. If this parameter is set, then all logging operations will use the specified name. If this parameter is not set, then each logging operation will use the default DB2 plan name, set by DEFAULTDB2PLAN.</p>	NULL	Yes	No
LOGDB2SUBSYS	<p>DB2 SUBSYSTEM FOR LOGGING OPERATIONS.</p> <p>This parameter controls the DB2 subsystem used for all SQL operations. If this parameter is set, then all logging operations will be routed to the specified DB2 subsystem. If this parameter is not set, then each logging operation will be routed to the DB2 subsystem that the operation was associated with or the default DB2 subsystem if the operation was not associated with any DB2 subsystem.</p>	'DSN1'	No	No

PRODLOGGING Parameter Group				
Parameter Name	Parameter Description	Default Value	Update	Output Only
LOGDELAY	<p>LOG DELAY TIME INTERVAL.</p> <p>This parameter controls how long the logging task will delay after it completes processing some set of logging requests. This is done to avoid too many starts and stops with the associated overhead of connecting to DB2 and then releasing the DB2 connection.</p> <p><b>Minimum Value: 1</b> <b>Maximum Value: 300</b></p>	30 SECONDS	Yes	No
LOGERRORS	<p>LOG EACH ERROR IN A TABLE. (YES, NO)</p> <p>This parameter controls if error information should be logged or not. Error information is logged by inserting rows into a DB2 table. One row is inserted for each error detected by the Shadow Mainframe Adapter Server address space or reported by an application running under the Shadow Mainframe Adapter Server address space.</p>	NO	Yes	No
LOGERRORSTABLE	<p>TABLE NAME FOR ERROR LOGGING.</p> <p>This parameter is used to set the name of the DB2 table used to log errors. A row is inserted into this table each time the product (Shadow Mainframe Adapter Server) detects an error. Errors can also be reported by applications running under the control of the Shadow Mainframe Adapter Server address space.</p> <p><b>Note:</b> Error logging can be turned on and off at any time.</p>	'SHADOW. ERRORLOG'	Yes	No
LOGFAILURELIMIT	<p>LOGGING FAILURE LIMIT.</p> <p>This parameter controls how many logging requests can be pending before a failure exception will occur. Failure exceptions are passed to SEF (if enabled) for processing. If SEF is not enabled, if there are no SEF rules for the logging failure exception, or if the SEF rules take no action, the default action will be taken. The default action is to clear the queue of pending logging requests and discard all of them.</p> <p><b>Minimum: 0</b> <b>Maximum: 100000</b></p>	5000 REQUESTS	Yes	No

PRODLOGGING Parameter Group				
Parameter Name	Parameter Description	Default Value	Update	Output Only
LOGINTERVALS	LOG EACH INTERVAL IN A TABLE. (YES, NO)  This parameter controls if session interval information should be logged or not. Session interval information is logged by inserting rows into a DB2 table. One row is inserted for each session at the end of each recording interval and at session termination time.	YES	Yes	No
LOGINTERVALSTABLE	TABLE NAME FOR INTERVAL LOGGING.  This parameter is used to set the name of the DB2 table used to log interval information. A row is inserted into this table at the end of each recording interval, if interval recording is active.	'SHADOW. INTERVALS'	Yes	No
LOGMEMORYAPPC/MVS	IN MEMORY APPC/MVS INTERVAL COUNT.  This parameter controls the number of APPC/MVS summary records to keep in memory at one time. If this parameter is set to zero, then no APPC/MVS summary records will be retained in memory. Setting this parameter to zero will not prevent APPC/MVS interval recording from being performed. The APPC/MVS summary records kept in memory can be interactively displayed.  <b>Minimum Value: 0</b> <b>Maximum Value: 1000</b>	<b>500</b> <b>INTERVALS</b>	Yes	No
LOGMEMORY-INTERVALS	IN MEMORY SUMMARY INTERVAL COUNT.  This parameter controls the number of interval summary records to keep in memory at one time. If this parameter is set to zero, then no interval summary records will be retained in memory. Setting this parameter to zero will not prevent interval recording from being performed. The interval summary records kept in memory can be interactively displayed.  <b>Minimum Value: 0</b> <b>Maximum Value: 1000</b>	<b>200</b> <b>INTERVALS</b>	Yes	No

PRODLOGGING Parameter Group				
Parameter Name	Parameter Description	Default Value	Update	Output Only
LOGRETAINAPMVSSUM	<p>LOG APPC/MVS SUMMARY RETENTION PERIOD.</p> <p>This parameter controls the number of days to wait before automatically deleting rows from the APPC/MVS summary table. In other words, all rows older than the number of days will be deleted. If this value is zero, then rows will never be automatically deleted from the APPC/MVS summary table.</p> <p><b>Minimum Value: 0</b> <b>Maximum Value: 999999</b></p>	0 DAYS	Yes	No
LOGRETAINERRORS	<p>LOG ERRORS RETENTION PERIOD.</p> <p>This parameter controls the number of days to wait before automatically deleting rows from the error logging table. In other words, all rows older than the number of days will be deleted. If this value is zero, then rows will never be automatically deleted from the error logging table.</p> <p><b>Minimum Value: 0</b> <b>Maximum Value: 999999</b></p>	30 DAYS	Yes	No
LOGRETAININTERVALS	<p>LOG INTERVAL RETENTION PERIOD.</p> <p>This parameter controls the number of days to wait before automatically deleting rows from the interval summary table. In other words, all rows older than the number of days will be deleted. If this value is zero, then rows will never be automatically deleted from the interval summary table.</p> <p><b>Minimum Value: 0</b> <b>Maximum Value: 999999</b></p>	5 DAYS	Yes	No
LOGRETAINSESSIONS	<p>LOG SESSION RETENTION PERIOD.</p> <p>This parameter controls the number of days to wait before automatically deleting rows from the sessions table. In other words, all rows older than the number of days will be deleted. If this value is zero, then rows will never be automatically deleted from the sessions table.</p> <p><b>Minimum Value: 0</b> <b>Maximum Value: 999999</b></p>	5 DAYS	Yes	No

PRODLOGGING Parameter Group				
Parameter Name	Parameter Description	Default Value	Update	Output Only
LOGRETAINSQL	LOG SQL SOURCE RETENTION PERIOD. This parameter controls the number of days to wait before automatically deleting SQL from the SQL source table. In other words, all rows older than the number of days will be deleted. If this value is zero, then rows will never be automatically deleted from the SQL source table. <b>Minimum Value: 0</b> <b>Maximum Value: 999999</b>	<b>5 DAYS</b>	Yes	No
LOGRETAINURLS	LOG URLS RETENTION PERIOD. This parameter controls the number of days to wait before automatically deleting rows from the URLs table. In other words, all rows older than the number of days will be deleted. If this value is zero, then rows will never be automatically deleted from the URLs table. <b>Minimum Value: 0</b> <b>Maximum Value: 999999</b>	<b>30 DAYS</b>	Yes	No
LOGSESSIONS	LOG EACH SESSION IN A TABLE. (YES, NO) This parameter controls if session information should be logged or not. Session information is logged by inserting rows into a DB2 table. One row is inserted for each session at session termination time.	<b>YES</b>	Yes	No
LOGSESSIONSTABLE	TABLE NAME FOR SESSION LOGGING. This parameter is used to set the name of the DB2 table used to log session information. A row is inserted into this table as part of session termination, if session logging is active.	<b>'SHADOW. SESSIONS'</b>	Yes	No
LOGSOURCETABLE	TABLE NAME FOR SQL SOURCE. This parameter is used to set the name of the DB2 table used to log SQL source for conversion from dynamic SQL to static SQL. Each SQL statement is stored in one or more rows of this table.	<b>'SHADOW. SQLSOURCE'</b>	Yes	No
LOGSQLSOURCE	LOG SQL SOURCE IN A TABLE. (YES, NO) This parameter controls if SQL source information should be logged or not. SQL source information is logged by inserting rows into a DB2 table. One row is inserted for each SQL statement when the SQL statement is processed. The logged SQL source is used to convert dynamic SQL to static SQL.	<b>NO</b>	Yes	No

<b>PRODLOGGING Parameter Group</b>				
<b>Parameter Name</b>	<b>Parameter Description</b>	<b>Default Value</b>	<b>Update</b>	<b>Output Only</b>
LOGSTORAGE	LOG STORAGE USAGE IN A TABLE. (YES, NO)  This parameter controls if storage information should be logged or not. Storage information is logged by inserting rows into a DB2 table.	<b>YES</b>	Yes	No
LOGSTORAGETABLE	TABLE NAME FOR STORAGE LOGGING.  This parameter is used to set the name of the DB2 table used to log storage information. A row is inserted into this table at the end of each recording level, if storage logging is active.	<b>'SHADOW. STORAGE'</b>	Yes	No
LOGURLS	LOG URLS IN A TABLE. (YES, NO)  This parameter controls if URLs should be logged or not. URL information is logged by inserting rows into a DB2 table. One row is inserted for each URL when the URL is processed. The logged URL information can be used for any installation purpose.	<b>NO</b>	Yes	No
LOGURLSTABLE	TABLE NAME FOR URL LOGGING.  This parameter is used to set the name of the DB2 table used to log URLs. A row is inserted into this table as part of the processing of each URL, if URL logging is active.	<b>'SHADOW. URLS'</b>	Yes	No
LOGUSERID	USERID FOR ALL LOGGING OPERATIONS.  This parameter controls the DB2 userid used for all SQL operations. This userid must have enough authority to update (insert) all of the tables modified by the logging task. If this field is not set, the main product address space userid is used for all update operations.	<b>'SDBB'</b>	Yes	No
LOGWAIT	LOG WAIT TIME INTERVAL.  This parameter controls how long the logging task will wait when there is no work to do. When this interval expires some general work (such as deleting obsolete rows) may be executed.  <b>Minimum Value: 60</b> <b>Maximum Value: 43200</b>	<b>86400 SECONDS</b>	Yes	No

PRODLOGGING Parameter Group				
Parameter Name	Parameter Description	Default Value	Update	Output Only
LOGWARNINGLIMIT	<p>LOGGING WARNING LIMIT.</p> <p>This parameter controls how many logging requests can be pending before a warning exception will occur. Warning exceptions are passed to SEF (if enabled) for processing. If SEF is not enabled, or if there are no SEF rules for the logging warning exception, or if the SEF rules take no action, the default action will be taken. The default action is to issue an error message describing the exception to the system console.</p> <p><b>Minimum Value: 0</b> <b>Maximum Value: 100000</b></p>	<b>3000 REQUESTS</b>	Yes	No
RECORDINGINTERVAL	<p>INTERVAL RECORDING PERIOD.</p> <p>This parameter controls how often interval summary and per-Mainframe Adapter Client SMF and/or SQL records are created. These records show what resources were used during the current recording interval. The interval value is specified in seconds and should be a factor of one hour. In other words, the value should divide evenly into 3600.</p> <p><b>Minimum Value: 1</b> <b>Maximum Value: 3600</b></p>	<b>900 SECONDS</b>	Yes	No
TERMINATELOGGING	<p>TERMINATE LOGGING PROCESSING. (YES, NO)</p> <p>This parameter controls if logging processing should terminate or not. If this parameter is turned on, logging processing will end and can not be restarted. This parameter can be set at any time and will always terminate logging processing.</p>	<b>NO</b>	Yes	No

**PRODMSGQ**

<b>PRODMSGQ Parameter Group</b>				
<b>Parameter Name</b>	<b>Parameter Description</b>	<b>Default Value</b>	<b>Update</b>	<b>Output Only</b>
INPUTQNAME01	IBM/MQ INPUT QUEUE NAME - 01. The INPUTQNAME parameter identifies the name of the input queue to read messages from.	NULL	No	No
INPUTQNAME21	IBM/MQ INPUT QUEUE NAME - 02. The INPUTQNAME parameter identifies the name of the input queue to read messages from.	NULL	No	No
INPUTQNAME03	IBM/MQ INPUT QUEUE NAME - 03. The INPUTQNAME parameter identifies the name of the input queue to read messages from.	NULL	No	No
INPUTQNAME04	IBM/MQ INPUT QUEUE NAME - 04. The INPUTQNAME parameter identifies the name of the input queue to read messages from.	NULL	No	No
INPUTQNAME05	IBM/MQ INPUT QUEUE NAME - 05. The INPUTQNAME parameter identifies the name of the input queue to read messages from.	NULL	No	No
INPUTQNAME06	IBM/MQ INPUT QUEUE NAME - 06. The INPUTQNAME parameter identifies the name of the input queue to read messages from.	NULL	No	No
INPUTQNAME07	IBM/MQ INPUT QUEUE NAME - 07. The INPUTQNAME parameter identifies the name of the input queue to read messages from.	NULL	No	No
INPUTQNAME08	IBM/MQ INPUT QUEUE NAME - 08. The INPUTQNAME parameter identifies the name of the input queue to read messages from.	NULL	No	No
INPUTQNAME09	IBM/MQ INPUT QUEUE NAME - 09. The INPUTQNAME parameter identifies the name of the input queue to read messages from.	NULL	No	No
INPUTQNAME10	IBM/MQ INPUT QUEUE NAME - 10. The INPUTQNAME parameter identifies the name of the input queue to read messages from.	NULL	No	No
MODELQNAME01	IBM/MQ MODEL QUEUE NAME - 01. The MODELQNAME parameter identifies the name of the model queue to use.	NULL	No	No
MODELQNAME02	IBM/MQ MODEL QUEUE NAME - 02. The MODELQNAME parameter identifies the name of the model queue to use.	NULL	No	No



<b>PRODMSGQ Parameter Group</b>				
<b>Parameter Name</b>	<b>Parameter Description</b>	<b>Default Value</b>	<b>Update</b>	<b>Output Only</b>
MODELQNAME03	IBM/MQ MODEL QUEUE NAME - 03. The MODELQNAME parameter identifies the name of the model queue to use.	NULL	No	No
MODELQNAME04	IBM/MQ MODEL QUEUE NAME - 04. The MODELQNAME parameter identifies the name of the model queue to use.	NULL	No	No
MODELQNAME05	IBM/MQ MODEL QUEUE NAME - 05. The MODELQNAME parameter identifies the name of the model queue to use.	NULL	No	No
MODELQNAME06	IBM/MQ MODEL QUEUE NAME - 06. The MODELQNAME parameter identifies the name of the model queue to use.	NULL	No	No
MODELQNAME07	IBM/MQ MODEL QUEUE NAME - 07. The MODELQNAME parameter identifies the name of the model queue to use.	NULL	No	No
MODELQNAME08	IBM/MQ MODEL QUEUE NAME - 08. The MODELQNAME parameter identifies the name of the model queue to use.	NULL	No	No
MODELQNAME09	IBM/MQ MODEL QUEUE NAME - 09. The MODELQNAME parameter identifies the name of the model queue to use.	NULL	No	No
MODELQNAME010	IBM/MQ MODEL QUEUE NAME - 10. The MODELQNAME parameter identifies the name of the model queue to use.	NULL	No	No
QMGRNAME01	IBM/MQ QUEUE MANAGER NAME - 01. The QMGRNAME parameter identifies the name of a queue manager with which to connect to.	NULL	No	No
QMGRNAME02	IBM/MQ QUEUE MANAGER NAME - 02. The QMGRNAME parameter identifies the name of a queue manager with which to connect to.	NULL	No	No
QMGRNAME03	IBM/MQ QUEUE MANAGER NAME - 03. The QMGRNAME parameter identifies the name of a queue manager with which to connect to.	NULL	No	No
QMGRNAME04	IBM/MQ QUEUE MANAGER NAME - 04. The QMGRNAME parameter identifies the name of a queue manager with which to connect to.	NULL	No	No
QMGRNAME05	IBM/MQ QUEUE MANAGER NAME - 05. The QMGRNAME parameter identifies the name of a queue manager with which to connect to.	NULL	No	No

<b>PRODMSGQ Parameter Group</b>				
<b>Parameter Name</b>	<b>Parameter Description</b>	<b>Default Value</b>	<b>Update</b>	<b>Output Only</b>
QMGRNAME06	IBM/MQ QUEUE MANAGER NAME - 06. The QMGRNAME parameter identifies the name of a queue manager with which to connect to.	NULL	No	No
QMGRNAME07	IBM/MQ QUEUE MANAGER NAME - 07. The QMGRNAME parameter identifies the name of a queue manager with which to connect to.	NULL	No	No
QMGRNAME08	IBM/MQ QUEUE MANAGER NAME - 08. The QMGRNAME parameter identifies the name of a queue manager with which to connect to.	NULL	No	No
QMGRNAME09	IBM/MQ QUEUE MANAGER NAME - 09. The QMGRNAME parameter identifies the name of a queue manager with which to connect to.	NULL	No	No
QMGRNAME10	IBM/MQ QUEUE MANAGER NAME - 10. The QMGRNAME parameter identifies the name of a queue manager with which to connect to.	NULL	No	No
USRINPQNAME01	IBM/MQ USER INPUT QUEUE NAME - 01. The USRINPQNAME parameter identifies the name of the remote queue to write messages to.	NULL	No	No
USRINPQNAME02	IBM/MQ USER INPUT QUEUE NAME - 02. The USRINPQNAME parameter identifies the name of the remote queue to write messages to.	NULL	No	No
USRINPQNAME03	IBM/MQ USER INPUT QUEUE NAME - 03. The USRINPQNAME parameter identifies the name of the remote queue to write messages to.	NULL	No	No
USRINPQNAME04	IBM/MQ USER INPUT QUEUE NAME - 04. The USRINPQNAME parameter identifies the name of the remote queue to write messages to.	NULL	No	No
USRINPQNAME05	IBM/MQ USER INPUT QUEUE NAME - 05. The USRINPQNAME parameter identifies the name of the remote queue to write messages to.	NULL	No	No
USRINPQNAME06	IBM/MQ USER INPUT QUEUE NAME - 06. The USRINPQNAME parameter identifies the name of the remote queue to write messages to.	NULL	No	No
USRINPQNAME07	IBM/MQ USER INPUT QUEUE NAME - 07. The USRINPQNAME parameter identifies the name of the remote queue to write messages to.	NULL	No	No
USRINPQNAME08	IBM/MQ USER INPUT QUEUE NAME - 08. The USRINPQNAME parameter identifies the name of the remote queue to write messages to.	NULL	No	No

<b>PRODMSGQ Parameter Group</b>				
<b>Parameter Name</b>	<b>Parameter Description</b>	<b>Default Value</b>	<b>Update</b>	<b>Output Only</b>
USRINPQNAME09	IBM/MQ USER INPUT QUEUE NAME - 09. The USRINPQNAME parameter identifies the name of the remote queue to write messages to.	NULL	No	No
USRINPQNAME10	IBM/MQ USER INPUT QUEUE NAME - 10. The USRINPQNAME parameter identifies the name of the remote queue to write messages to.	NULL	No	No
USRROUTQNAME01	IBM/MQ USER OUTPUT QUEUE NAME - 01. The USROUTQNAME parameter identifies the name of the output queue to write messages to.	NULL	No	No
USRROUTQNAME02	IBM/MQ USER OUTPUT QUEUE NAME - 02. The USROUTQNAME parameter identifies the name of the output queue to write messages to.	NULL	No	No
USRROUTQNAME03	IBM/MQ USER OUTPUT QUEUE NAME - 03. The USROUTQNAME parameter identifies the name of the output queue to write messages to.	NULL	No	No
USRROUTQNAME04	IBM/MQ USER OUTPUT QUEUE NAME - 04. The USROUTQNAME parameter identifies the name of the output queue to write messages to.	NULL	No	No
USRROUTQNAME05	IBM/MQ USER OUTPUT QUEUE NAME - 05. The USROUTQNAME parameter identifies the name of the output queue to write messages to.	NULL	No	No
USRROUTQNAME06	IBM/MQ USER OUTPUT QUEUE NAME - 06. The USROUTQNAME parameter identifies the name of the output queue to write messages to.	NULL	No	No
USRROUTQNAME07	IBM/MQ USER OUTPUT QUEUE NAME - 07. The USROUTQNAME parameter identifies the name of the output queue to write messages to.	NULL	No	No
USRROUTQNAME08	IBM/MQ USER OUTPUT QUEUE NAME - 08. The USROUTQNAME parameter identifies the name of the output queue to write messages to.	NULL	No	No
USRROUTQNAME09	IBM/MQ USER OUTPUT QUEUE NAME- 09. The USROUTQNAME parameter identifies the name of the output queue to write messages to.	NULL	No	No
USRROUTQNAME10	IBM/MQ USER OUTPUT QUEUE NAME- 10. The USROUTQNAME parameter identifies the name of the output queue to write messages to.	NULL	No	No
MSGIDFILTER	IBM/MQ MESSAGE FILTER (MSGID). The MSGIDFILTER parameter identifies the msgid which is used to filter MQGET calls.	'X'E2C8C1C4D 6E640C4C9	No	No

<b>PRODMSGQ Parameter Group</b>				
<b>Parameter Name</b>	<b>Parameter Description</b>	<b>Default Value</b>	<b>Update</b>	<b>Output Only</b>
Mainframe Adapter ServerCORRID	IBM/MQ Mainframe Adapter Server CORRELATION ID. The Mainframe Adapter ServerCORRID parameter identifies the correlation id used to identify Mainframe Adapter Server messages.	'X'E2C8C1C4D 6E640E2C5	No	No

**PRODPARM**

<b>PRODPARM Parameter Group</b>				
<b>Parameter Name</b>	<b>Parameter Description</b>	<b>Default Value</b>	<b>Update</b>	<b>Output Only</b>
ADJUSTREGIONSIZE	AUTO-ADJUST TSO USER REGION SIZE.  This parameter allows this address space to automatically adjust the region size of TSO users connecting to the Shadow Mainframe Adapter Server address space.	<b>2147483647</b>	Yes	No
AUTOCANCELTM	AUTOMATIC CANCEL AT PRODUCT TERMINATION. (YES, NO)  This parameter indicates if Mainframe Adapter Client processing subtasks will be cancelled by the Shadow Mainframe Adapter Server during shutdown, following the Shadow Mainframe Adapter Server Mainframe Adapter ClientQUIESCEDELAY parameter time (if any). If this parameter is set to NO, Mainframe Adapter Client processing subtasks are abandoned by the Shadow Mainframe Adapter Server at the end of the SHUTDOWNWAIT parameter time period and the product's main task may be terminated by the system within an SA03 abend.	<b>YES</b>	Yes	No
BASEINTERVAL	BASE TIME SLICE INTERVAL.  This parameter is used with the time slicing mechanism.  <b>Minimum Value: 0</b> <b>Maximum Value: 1000000</b>	<b>0 MILLI-SECONDS</b>	Yes	No
BYPASSID	BYPASS SYSTEM NAME.  This parameter specifies that certain subsystems be bypassed. During initialization, existing subsystems on this OS/390 or z/OS image are searched for valid DB2 entries. At least one other ISV is placing a character string in the SSVT field that normally points to the DB2 ERLY block. Shadow attempts to use the character string as an address. Although our own ESTAE logic recovers an SVC dump is created if a slip trap is set for 0C4 abends within Shadow. When set to ON, this parameter will bypass DB2 SSCT checking for the named subsystem.	<b>NULL</b>	Yes	No

PRODPARM Parameter Group				
Parameter Name	Parameter Description	Default Value	Update	Output Only
CANCELWAITTIME	<p>MAINFRAME ADAPTER CLIENT CANCEL WAIT TIME VALUE.</p> <p>This parameter controls how long the product waits between Mainframe Adapter Client thread termination events during product shutdown. The product automatically terminates Mainframe Adapter Client threads during product termination. Because some IBM products cannot handle large number of thread termination events in a short period of time, the product throttles Mainframe Adapter Client thread terminations.</p> <p><b>Minimum Value: 0</b> <b>Maximum Value: 10000</b></p>	<b>3000 MILLI-SECONDS</b>	Yes	No
CHECKLIMITS-INTERVAL	<p>CPU/WAIT LIMITS CHECKING INTERVAL.</p> <p>This parameter controls how often each Mainframe Adapter Client task is checked for a violation of any execution limit. The interval value is specified in seconds and should be a factor of one hour. In other words, the value should divide evenly into 3600.</p> <p><b>Minimum Value: 1</b> <b>Maximum Value: 3600</b></p>	<b>15 SECONDS</b>	Yes	No
CHECKDATAINTERVAL	<p>KEY DATA CHECKING INTERVAL.</p> <p>This parameter controls how often certain key data fields are checked for consistency and validity. If any of these fields are found to be in error, it is fixed so that normal product execution can be continued. The interval value is specified in seconds and should be a factor of one hour. In other words, the value should divide evenly into 3600.</p> <p><b>Minimum Value: 1</b> <b>Maximum Value: 3600</b></p>	<b>60 SECONDS</b>	Yes	No
CHECKSESSIONS	<p>CHECK THE STATUS OF EACH SESSION. (YES, NO)</p> <p>This parameter controls if a communication session is checked on a periodic basis. If set to yes and it detects a session terminated because the Mainframe Adapter Client application terminated, the Mainframe Adapter Client system failed, or because of a network failure, then all work running on the host running on behalf of the Mainframe Adapter Client is terminated.</p>	<b>NO</b>	Yes	No

PRODPARM Parameter Group				
Parameter Name	Parameter Description	Default Value	Update	Output Only
CHECKSTORAGE-INTERVAL	<p>STORAGE CHECKING INTERVAL. (YES, NO)</p> <p>This parameter controls how often statistics for allocated storage are gathered within Shadow. A value of zero turns this function off.</p> <p><b>Minimum Value: 0</b> <b>Maximum Value: 3600</b></p>	<b>60 SECONDS</b>	Yes	No
Mainframe Adapter ClientQUIESCEDELAY	<p>MAINFRAME ADAPTER CLIENT TASK QUIESCE DELAY.</p> <p>This parameter controls how long the product waits during shutdown for Mainframe Adapter Client processing subtasks to end normally. This delay time value is only used when the Shadow Mainframe Adapter Server AUTOCANCELTM parameter is set to YES. It can be used to throttle overall product shutdown processing to allow sufficient time for transaction threads to terminate normally before they are cancelled using CALLRTM. This quiesce delay occurs before the SHUTDOWNWAIT parameter time interval begins.</p> <p><b>Minimum Value: 0</b> <b>Maximum Value: 1800</b></p>	<b>10 SECONDS</b>	Yes	No
COMPEXECDSNAME	COMPILED REXX EXEC DATA SET NAME.	<b>NULL</b>	Yes	No
DBCSTABLENAME	<p>DEFAULT DBCS TABLE NAME.</p> <p>This parameter allows the user to define a default DBCS table for DBCS character translation.</p>	<b>NULL</b>	Yes	No
DEFAULTCPUTIME	<p>DEFAULT DEFAULT CPU TIME.</p> <p>This parameter specifies the default CPU time value (in seconds) that is used with the internal CPU time limit mechanism if a default value cannot be obtained from the security package (ACF2 or RACF).</p> <p><b>Minimum Value: 0</b> <b>Maximum Value: 600</b></p>	<b>0 SECONDS</b>	Yes	No

PRODPARM Parameter Group				
Parameter Name	Parameter Description	Default Value	Update	Output Only
DISPATCH	<p>MAIN ADDRESS SPACE DISPATCH PRIORITY.</p> <p>This parameter sets the dispatch priority of the Shadow Mainframe Adapter Server. The default value of 254 defines a very high priority and needs to be matched against system requirements. If the Shadow Mainframe Adapter Server WLMCONNECT parameter is set to YES, this parameter is ignored. Otherwise, if this parameter is set to zero, then the product will not attempt to set its dispatch priority, and it will rely on system priority definitions.</p> <p><b>Minimum Value: 0</b> <b>Maximum Value: 255</b></p>	254	No	No
DLLIBDDNAME	DIRECTED LOAD DDNAME.	NULL	No	No
DSPC	<p>INITIALIZE DSPC SUPPORT. (YES, NO)</p> <p>This parameter controls whether or not the DSPC support is initialized.</p>	NO	No	No
ERRORCPU TIME	<p>ERROR CPU TIME VALUE.</p> <p>This parameter determines the error limit (in seconds) of the external CPU time limit mechanism.</p>	0 SECONDS	Yes	No
ERRORWAITTIME	<p>ERROR WAIT TIME VALUE.</p> <p>This parameter determines the error limit (in seconds) of the external wait time limit mechanism.</p>	0 SECONDS	Yes	No
EXECDSNAME	REXX EXEC DATA SET NAME.	'CSD.AI38. SV040800. EXECFB'	Yes	No
EXTRAINTERVAL	<p>EXTRA TIME SLICE INTERVAL.</p> <p>This parameter is used with the time slicing mechanism.</p> <p><b>Minimum Value: 1</b> <b>Maximum Value: 10000</b></p>	0 MILLI-SECONDS	Yes	No
FAILCPU TIME	<p>FAIL CPU TIME VALUE.</p> <p>This parameter determines the failure limit (in seconds) of the external CPU time limit mechanism.</p>	0 SECONDS	Yes	No
FAILEXCLUSIVETIME	FAIL EXCLUSIVE LOCK TIME VALUE.	0 SECONDS	Yes	No
FAILSHARETIME	FAIL SHARE LOCK TIME VALUE.	0 SECONDS	Yes	No



<b>PRODPARM Parameter Group</b>				
<b>Parameter Name</b>	<b>Parameter Description</b>	<b>Default Value</b>	<b>Update</b>	<b>Output Only</b>
FAILSQLCPUTIME	FAIL SQL CPU TIME VALUE.	<b>120 SECONDS</b>	Yes	No
FAILUPDATETIME	FAIL UPDATE LOCK TIME VALUE.	<b>0 SECONDS</b>	Yes	No
FAILWAITTIME	FAIL WAIT TIME VALUE. This parameter determines the failure limit (in seconds) of the external wait time limit mechanism.	<b>0 SECONDS</b>	Yes	No
GROUPDIRECTOR	PERFORM GROUP DIRECTOR ROLE. (YES, NO) This parameter indicates that a member of the group take the role of director. The director will only accept inbound connections and pass them to a member of the group which is determined to be the most acceptable in terms of load and resource availability. The group director will not support an application execution environment. This will provide for a more robust load balancing group.	<b>NO</b>	Yes	No
GROUPNAME	LOAD BALANCING GROUP NAME. This parameter controls which group, if any, the current copy of the Mainframe Adapter Server belongs to. Groups are used for load balancing across multiple copies (separate subsystems) of the product. All copies that belong to the same group (i.e., have exactly the same GROUPNAME) automatically load balance between each other. If this value is not set, then the current copy does not belong to any group.	<b>NULL</b>	Yes	No
HIGHMODULEDATE	HIGH MODULE ASSEMBLE DATE. This parameter contains the assemble date of the module that was assembled latest in the product. This parameter is provided for NEON Systems Customer Support purposes and cannot be changed.	<b>'YYYY/MM/DD'</b>	No	Yes
HIGHMODULETIME	HIGH MODULE ASSEMBLE TIME. This parameter contains the assemble time of the module that was assembled latest in the product. This parameter is provided for NEON Systems Customer Support purposes and cannot be changed.	<b>'HH.MM'</b>	No	Yes
HIGHMODULENAME	HIGH MODULE NAME. This parameter contains the name of the module that was assembled latest in the product. This parameter is provided for NEON Systems Customer Support purposes and cannot be changed.		No	Yes

PRODPARM Parameter Group				
Parameter Name	Parameter Description	Default Value	Update	Output Only
HIGHMODULEVERSION	HIGH MODULE VERSION. This parameter contains the version of the module that was assembled latest in the product. This parameter is provided for NEON Systems Customer Support purposes and cannot be changed.	'04.08.01'	No	Yes
ISPLLIBDSNAME	ISPLLIB DATA SET NAME.	'CSD.AI38. SV040800. LOAD'	Yes	No
ISPMLIBDSNAME	ISPMLIB DATA SET NAME.	'CSD.AI38. SV040800. NEONMLIB'	Yes	No
ISPLLIBDSNAME	ISPLLIB DATA SET NAME.	'CSD.AI38. SV040800. NEONPLIB'	Yes	No
ISPSLIBDSNAME	ISPSLIB DATA SET NAME.	NULL	Yes	No
ISPTLIBDSNAME	ISPTLIB DATA SET NAME.	'CSD.AI38. SV040800. NEONTLIB'	Yes	No
KILLWAITPOST	KILL WAITING THREADS WITH POST. (YES, NO) This parameter controls how threads that have exceeded a wait limit are killed. Only threads that have exceeded a wait limit are influenced by this parameter. Possible values are: <ul style="list-style-type: none"> <li><b>YES:</b> (Default) The thread is terminated by posting the pending thread with a code that ends the pending network read operation and rolls back any database changes.</li> <li><b>NO:</b> The thread is killed with either a system or user abend.</li> </ul>	YES	Yes	No
MAXABENDRATE	MAXIMUM ABEND RATE ALLOWED. This parameter should be set to zero to turn off abend rate checking within Shadow. If it has a non-zero value, the value set will be used against the rate to determine if Shadow should terminate. <b>Minimum: 0</b> <b>Maximum: 1</b>	0.1	Yes	No

PRODPARM Parameter Group				
Parameter Name	Parameter Description	Default Value	Update	Output Only
MAXCMDRATE	<p>MAX COMMAND RATE ALLOWED.</p> <p>This parameter should be set to zero to turn off the command rate checking within Shadow. If a non-zero value is used, the value set will be used against the rate to determine if Shadow should terminate.</p> <p><b>Minimum Value: 0</b> <b>Maximum Value: 3</b></p>	3.0	Yes	No
MAXCPU TIME	<p>DEFAULT MAXIMUM CPU TIME.</p> <p>This parameter specifies the maximum CPU time value, in seconds, used with the internal CPU time limit mechanism.</p>	0 SECONDS	Yes	No
MAXLOGRATE	<p>MAX LOGREC RATE ALLOWED.</p> <p>This parameter should be set to zero to turn off logging rate checking within Shadow. If a non-zero value is used, the value set will be used against the rate to determine if Shadow should terminate logrec recording during estae processing.</p> <p><b>Minimum Value: 0</b> <b>Maximum Value: 1</b></p>	0.01	Yes	No
MAXMSGRATE	<p>MAX MESSAGE RATE ALLOWED.</p> <p>This parameter should be set to zero to turn off the message rate checking within Shadow. If a non-zero value is used, the value set will be used against the rate to determine if Shadow should terminate.</p> <p><b>Minimum Value: 0</b> <b>Maximum Value: 10.0</b></p>	10.0	Yes	No
MAXSEPSHUTDOWN-WAIT	<p>MAXIMUM PUBLISH SHUTDOWN WAIT TIME.</p> <p>This parameter specifies the maximum amount of time that the SEP Publish Control task should wait at shutdown for Publish Source and Destination tasks to complete.</p> <p><b>Minimum Value: 5</b> <b>Maximum Value: 950</b></p>	60 SECONDS	Yes	No
MINCPU TIME	<p>DEFAULT MINIMUM CPU TIME.</p> <p>This parameter specifies the minimum CPU time value, in seconds, used with the internal CPU time limit mechanism.</p>	0 SECONDS	Yes	No

PRODPARM Parameter Group				
Parameter Name	Parameter Description	Default Value	Update	Output Only
MVSPROCLPCALLS	PERFORM MVSPROCLP CALLS. (YES, NO)  This parameter maintains whether or not OE MVSPROCLP calls are made a transaction runtime. Necessary for java support when compiled by hpj.	NO	Yes	No
NEVERREDIRECT	NEVER REDIRECT A SESSION. (YES, NO)  This parameter determines whether sessions should ever be transferred to another Shadow Mainframe Adapter Server. When set to YES, sessions will never be redirected to another Shadow Mainframe Adapter Server.  <b>Note:</b> When set to YES, the Shadow Mainframe Adapter Server will still accept sessions from other Shadow Mainframe Adapter Servers.	NO	Yes	No
PROCESS	INITIAL PROCESS BLOCK COUNT.  This parameter needs to be equal to IMSMAXTHREADS plus the number of users that will be using the Shadow ISPF/SDF dialogs.  <b>Minimum Value: 5</b> <b>Maximum Value: 250</b>	10 BLOCKS	No	No
PROCESSEP	PROCESS A SET OF ENTRY POINTS. (YES, NO)  This parameter specifies whether or not a set of entry points should be processed. This option is for System Engineering use and should only be used when directed by NEON Systems Customer Support.	NO	No	No
PROCESSPC	PROCESS A SET OF PCS. (YES, NO)  This parameter specifies whether or not a set of PCs should be processed. This option is for System Engineering use and should only be used when directed by NEON Systems Customer Support.	NO	No	No
PROCESSVC	PROCESS A SET OF SVCS. (YES, NO)  This parameter specifies whether or not a set of SVSs should be processed. This option is for System Engineering use and should only be used when directed by NEON Systems Customer Support.	NO	No	No

PRODPARM Parameter Group				
Parameter Name	Parameter Description	Default Value	Update	Output Only
PROCESSTCB	TCB TO BE MONITORED.  This parameter specifies the address of a TCB that should be monitored by a set of routines. If this value is not set, then all TCBs will be monitored by these routines. If this value is set, then only one TCB will be processed by these routines. This option is for System Engineering use and should only be used when directed by NEON Systems Customer Support.	X'00000000'	Yes	No
QUICKREFOPTIONS	QUICKREF INVOCATION OPTIONS.	<b>CMD</b>	Yes	No
QUIESCESYSTEMTYPE	QUIESCE SYSTEM TYPE.  This parameter is used to indicate whether the termination of all Mainframe Adapter Client connections is to be performed immediately, or through attrition.	<b>ATTRITION</b>	Yes	No
REUSETHEADS	REUSE SESSION THREADS. (YES, NO)  This parameter controls if threads should be reused or not. Possible values are: <ul style="list-style-type: none"> <li><b>YES:</b> Each thread will be reused a number of times if possible. Thread reuse may reduce CPU resource utilization quite considerably when DB2 threads are used frequently and/or Mainframe Adapter Client userids are cached and reused for persistent session support.</li> <li><b>NO:</b> (Default) A new thread will always be created for each new inbound session.</li> </ul>	<b>NO</b>	Yes	No
SCAUTHINTERVAL	SHADOW CONSOLE Mainframe Adapter Server AUTHORIZATION INTERVAL.  This parameter defines the time limit (in hours) that an authorized Shadow Console Mainframe Adapter Server may be authorized before it has to revalidate itself.  <b>Minimum Value: 1</b> <b>Maximum Value: 24</b>	<b>6</b>	Yes	No

PRODPARM Parameter Group				
Parameter Name	Parameter Description	Default Value	Update	Output Only
SCMAXMainframe Adapter Server	SHADOW CONSOLE MAXIMUM AUTHORIZED Mainframe Adapter ServerS.  This parameter defines the maximum number of authorized Shadow Console Mainframe Adapter Servers that can be active at any one time. When this number is exceeded, authorization will be denied to all new Shadow Console Mainframe Adapter Servers.  <b>Minimum Value: 8</b> <b>Maximum Value: 1024</b>	24	No	No
SESSIONFAILTIME	SESSION FAILURE TIME LIMIT VALUE.  This parameter controls how long a remote application task (a task running on behalf of a Mainframe Adapter Client) can be in processing state (RPC, SQL, REXX) before the product will check if the network session is still active or not. In some cases, a remote Mainframe Adapter Client application will start some long running processing (for example a complex SQL statement) and then the remote application will end or the Mainframe Adapter Client system will fail or the network will fail. In any of these cases, the SESSIONFAILTIME parameter control how long before the product checks to see if the network session with the remote Mainframe Adapter Client system is still active or not.	15 SECONDS	Yes	No
SESSIONQUEUE-ADDRESS	SESSION TRANSFER QUEUE ADDRESS.  This parameter displays the address of the session transfer queue header. This parameter is used for display purposes only.	X'15081000'	No	Yes
SHUTDOWNWAIT	SHUTDOWN WAIT TIME VALUE.  This parameter controls how long the product will wait to shutdown. This is actually the number of seconds that the main product task will wait for all of its subtasks to terminate.  <b>Minimum Value: 0</b> <b>Maximum Value: 3600</b>	60 SECONDS	Yes	No
SUPPRESS522	SUPPRESS U522 LOGREC ENTRIES. (YES, NO)  This parameter specifies whether U522 abends (Shadow fail wait time exceeded) should have their logrec entries suppressed.	NO	Yes	No

PRODPARM Parameter Group				
Parameter Name	Parameter Description	Default Value	Update	Output Only
SWILOGONTIMEOUT	<p>SHADOW WEB INTERFACE (SWI) LOGON TIMEOUT.</p> <p>This parameter determines the maximum time an Shadow Web Interface™ (SWI) logon remains valid when a user is idle. An idle user logon to the application must be re-entered when the time limit expires.</p> <p><b>Minimum Time: 5</b> <b>Maximum Time: 245</b></p>	<b>10 MINUTES</b>	Yes	No

PRODPARM Parameter Group				
Parameter Name	Parameter Description	Default Value	Update	Output Only
SWIURLNAME	<p>SHADOW WEB INTERFACE (SWI) URL PREFIX.</p> <p>This parameter specifies the prefix string used to recognize HTTP requests for access to the built-in Shadow Web Interface™ (SWI). SWI implements most of the administrative and diagnostic facilities which are available to TSO/E users via the Shadow Mainframe Adapter Server's ISPF-based dialogs.</p> <p><b>Note:</b> An authorized OS/390 or z/OS userid and password are required to gain access to this built-in application.</p> <p>The SWIURLNAME prefix string may be from 1 to 64 bytes in length. The characters you select for this prefix string should contain only byte values commonly used to form internet URLs. The string may be entered with or without a leading "/" (forward slash) character; the Shadow Mainframe Adapter Server will supply a leading forward slash if SWIURLNAME begins with any other non-blank character. (It is suggested that you avoid the use of any characters except letters, digits, forward slash ("/"), and the underbar ("_") character.)</p> <p>If this parameter is set to one or more blanks, the Shadow Web Interface (SWI) is <i>not</i> enabled. All Web browser access to the administrative and control facilities of the built-in SWI application will be rejected. Specify a single blank for this parameter if you wish to disable SWI.</p> <p><b>Note:</b> You must explicitly set this parameter to blank in order to disable HTTP access to administrative utilities via the Shadow Web Interface (SWI).</p> <p>For all Shadow Mainframe Adapter Server products except Shadow Web Server, the default value for this parameter is "SWICNTL". An HTTP request for the URL, "/SWICNTL", will provide browser access to the SWI application.</p> <p>If you intend to use SWI, it is strongly suggested that you supply the internet domain name at start-up by setting the IBMHOSTDOMAIN, ITCHOSTDOMAIN, or OEHOSTDMAIN parameters, also.</p> <p>(Continued on next page)</p>	'SWINCTL'	No	No



PRODPARM Parameter Group				
Parameter Name	Parameter Description	Default Value	Update	Output Only
SWIURLNAME (Continued)	(Continued from previous page) To access the Shadow Web Interface (SWI), it is necessary that you direct your browser to the domain:port being used by the product and request the SWI URL. <b>Examples:</b> <ul style="list-style-type: none"> <li>http://domain:port/SWICNTL will access this facility when the SWIURLNAME parameter is set to SWICNTL</li> <li>http://domain:port/ will access this facility when the SWIURLNAME parameter is set to "/.</li> </ul>	'SWINCTL'	No	No
TARGETTHREAD-COUNT	TARGET UDP/TCP THREAD COUNT. This parameter controls the target number of threads in some UDP and TCP execution modes. The value controls the number of subtasks created during product startup to handle inbound UDP datagrams and TCP sessions. <b>Minimum Value: 1</b> <b>Maximum Value: 1000</b>	<b>100 THREADS</b>	No	No
TERMINATEINTERVAL	TERMINATE INTERVAL PROCESSING (YES, NO) This parameter controls if interval processing should terminate or not. If this parameter is turned on, interval processing will end and can not be restarted. This parameter can be set at any time and will always terminate interval processing.	<b>NO</b>	Yes	No
THREADDTIMEOUT	THREAD TIMEOUT WAIT TIME. This parameter controls how long a thread will wait for new work to be assigned to it. When the time limit is reached the thread terminates. Setting too small a value will cause thread churning. Setting too high a value may leave too many idle threads. <b>Minimum Value: 1</b> <b>Maximum Value: 3600</b>	<b>300 SECONDS</b>	Yes	No

PRODPARM Parameter Group				
Parameter Name	Parameter Description	Default Value	Update	Output Only
THREADREUSELIMIT	<p>THREAD REUSE LIMIT VALUE.</p> <p>This parameter controls how many times a thread can be used to handle a session before it terminates. Setting a value too small will cause additional CPU resources to be used. Setting a value too high may cause storage leakage.</p> <p><b>Note:</b> A zero or one value will prevent all thread reuse.</p> <p><b>Minimum Value: 0</b> <b>Maximum Value: 10000000</b></p>	100 SESSIONS	Yes	No
TRACEBROWSECOUNT	<p>TRACE BROWSE REVERIFY COUNT.</p> <p>This parameter specifies the number of trace browse records over the maximum before the severe warning messages are reissued.</p> <p><b>Minimum Value: 1000</b> <b>Maximum Value: 1000000</b></p>	1000000	Yes	No
TRACEBROWSE-MAXLIMIT	<p>MAX TRACE BROWSE RECORD COUNT.</p> <p>This parameter specifies the maximum number of trace browse records allowed before the severe warning message is issued. During production initialization, this limit is checked against the current trace browse record count. If this number is exceeded, the trace browse log is cleared.</p> <p><b>Minimum Value: 2000</b> <b>Maximum Value: 2000000000</b></p>	2000000000	Yes	No
USECANCELTHREAD	<p>USE THE DB2 CANCEL THREAD COMMAND. (YES, NO)</p> <p>This parameter controls if the DB2 CANCEL THREAD command should be used to terminate SQL operations that have exceeded installation limits. Possible values are:</p> <ul style="list-style-type: none"> <li><b>YES:</b> The CANCEL THREAD command is used.</li> <li><b>NO:</b> (Default) The TCB is terminated using CALLRTM. The USERABENDKILL parameter determines the type of abend created using CALLRTM.</li> </ul> <p>The purpose of this parameter is to avoid possible IRLM outages caused by DB2 threads being killed with an abend.</p> <p><b>Note:</b> This parameter can only be used with releases of DB2 that support the CANCEL THREAD command (DB2 4.1 and later).</p>	NO	Yes	No

PRODPARM Parameter Group				
Parameter Name	Parameter Description	Default Value	Update	Output Only
USERABENDKILL	<p>KILL THREADS WITH USER ABEND. (YES, NO)</p> <p>This parameter controls how connections and thus tasks or threads are terminated. When this parameter is set to YES, CALLRTM is invoked using a user abend code and the RETRY=NO option. The purpose of this parameter is to avoid possible IRLM outages due to DB2 threads killed with X22 system abend codes. The use of this parameter should coincide with the setting of the following SLIP traps.</p> <p>SLIP SET , C=U0222 , ID=U222 , A=NODUMP , END SLIP SET , C=U0322 , ID=U322 , A=NODUMP , END SLIP SET , C=U0522 , ID=U522 , A=NODUMP , END</p>	YES	Yes	No
WAITINTERVAL	<p>WAIT TIME SLICE INTERVAL.</p> <p><b>Minimum Value: 0</b> <b>Maximum Value: 100000</b></p>	<b>0 MILLI-SECONDS</b>	Yes	No
WARNINGCPUTIME	<p>WARNING CPU TIME VALUE.</p> <p>This parameter determines the warning limit (in seconds) of the external CPU time limit mechanism.</p>	<b>0 SECONDS</b>	Yes	No
WARNINGWAITTIME	<p>WARNING WAIT TIME VALUE.</p> <p>This parameter determines the warning limit (in seconds) of the external wait time limit mechanism.</p>	<b>0 SECONDS</b>	Yes	No

**PRODREXX**

<b>PRODREXX Parameter Group</b>				
<b>Parameter Name</b>	<b>Parameter Description</b>	<b>Default Value</b>	<b>Update</b>	<b>Output Only</b>
REXXDEFAULTADDRESS	DEFAULT HOST COMMAND ENVIRONMENT FOR REXX PGMS.	'TSO'	Yes	No
REXXMAXCLAUSES	MAXIMUM NUMBER OF REXX CLAUSES. <b>Minimum Value: -1</b> <b>Maximum Value: None</b>	<b>1000000</b>	Yes	No
REXXMAXCOMMANDS	MAXIMUM NUMBER OF HOST COMMANDS. <b>Minimum Value: -1</b> <b>Maximum Value: None</b>	<b>100000</b>	Yes	No
REXXMAXPGMSIZE	MAXIMUM REXX PROGRAM SIZE IN BYTES. <b>Minimum Value: 32768</b> <b>Maximum Value: None</b>	<b>1048616</b>	Yes	No
REXXMAXQUEUE	MAXIMUM EXTERNAL DATA QUEUE SIZE. <b>Minimum Value: 1</b> <b>Maximum Value: 8192</b>	<b>3000</b>	Yes	No
REXXMAXSAYS	MAXIMUM NUMBER OF SAY STATEMENTS. <b>Minimum Value: -1</b> <b>Maximum Value: None</b>	<b>100000</b>	Yes	No
REXXMAXSECONDS	MAXIMUM SECONDS OF EXECUTION TIME. <b>Minimum Value: -1</b> <b>Maximum Value: 100000000</b>	<b>-1</b>	Yes	No
REXXMAXSTRING-LENGTH	MAXIMUM LENGTH OF ANY STRING IN A REXX PROGRAM. <b>Minimum Value: 128</b> <b>Maximum Value: 32000</b>	<b>32000</b>	Yes	No

**PRODRPC**

<b>PRODRPC Parameter Group</b>				
<b>Parameter Name</b>	<b>Parameter Description</b>	<b>Default Value</b>	<b>Update</b>	<b>Output Only</b>
CALLMAXROWS	<p>MAXIMUM NUMBER OF ROWS FROM A CALL RPC.</p> <p>This parameter is the maximum number of rows a CALL RPC can generate. If a CALL RPC tries to generate more rows than this value, it will receive an error. If this value is set to zero, then there is no limit on the number of rows a CALL RPC can generate.</p> <p><b>Minimum Value: 0</b> <b>Maximum Value: 1000000000</b></p>	<b>10000 ROWS</b>	Yes	No
CALLROWSSIZE	<p>INITIAL ROW AREA SIZE FOR A CALL RPC.</p> <p><b>Minimum Value: 0</b> <b>Maximum Value: 1000000000</b></p>	<b>20000 BYTES</b>	Yes	No
CHECKRPCAUTHORITY	<p>CHECK RPC EXECUTION AUTHORITY. (YES, NO)</p> <p>This parameter controls if the SEF and ACF2/RACF should be used to check if each user has the authority to execute each RPC. Possible values are:</p> <ul style="list-style-type: none"> <li><b>YES:</b> The SEF and ACF2/RACF will be used to verify RPC execution authority.</li> <li><b>NO:</b> (Default) All users will be allowed to execute all RPCs. Of course, the RPC can always provide its own security.</li> </ul>	<b>NO</b>	Yes	No
DEFAULTRPCPARAM	<p>DEFAULT RPC PARAMETER STRING.</p> <p>This parameter is used to set the default parameter string passed to RPC programs. This field is only used if no parameter is specified using the Shadow Event Facility (SEF) and if this parameter is set to a non-blank value. This parameter can be used to pass runtime options to language environments such as NOSTAE and NOSPIE.</p>	<b>NULL</b>	Yes	No
FAILENQHOLDTIME	FAIL ENQUEUE HOLD TIME VALUE.	<b>0 SECONDS</b>	Yes	No

PRODRPC Parameter Group				
Parameter Name	Parameter Description	Default Value	Update	Output Only
LE370ENVIRONMENT	<p>ENABLE LE/370 ENVIRONMENT FOR RPCS. (YES, NO)</p> <p>This parameter controls if an LE/370 pre-initialized environment should be created for executing RPCs in the main product address space. Possible values are:</p> <ul style="list-style-type: none"> <li><b>YES:</b> An LE/370 environment is created for each task used to run RPCs.</li> <li><b>NO:</b> The LE/370 pre-initialized environments are not used to run RPCs. Using LE/370 pre-initialized environments reduces the resource requirements required to execute RPCs.</li> </ul>	NONE	No	No
LE370EXITS	<p>ENABLE LE/370 SERVICE ROUTINE EXITS. (YES, NO)</p> <p>This parameter controls if a set of LE/370 service routine exits should be enabled or not. If this parameter is set to YES, then the service routines will be for messages, storage, and contents management. The service routine exits are provided by the product and provide detailed LE/370 tracing information.</p>	NO	Yes	No
LE370LIBKEEP	<p>ENABLE LIBKEEP FOR LE/370. (YES, NO)</p>	NO	Yes	No
LE370MSGEXIT	<p>ENABLE LE/370 MESSAGE ROUTINE EXIT. (YES, NO)</p> <p>This parameter controls if the LE/370 message exit service routine should be enabled or not. If this parameter is set to YES, then the message exit service routine is enabled to handle LE/370 messages. The product message exit copies each message into trace browse. The message exit can not be used in some cases because of bugs in LE/370. The symptom is message loops in LE/370 initialization.</p>	NO	Yes	No

PRODRPC Parameter Group				
Parameter Name	Parameter Description	Default Value	Update	Output Only
LERPCOPTIONS	LE/370 RPC ENCLAVE RUNTIME OPTIONS.  This parameter allows you to set the Language Environment runtime options used by the system when invoking internal High-Level Language (HLL) components. This parameter only applies to the enclave used for RPC processing. A separate field is used to provide runtime options for the enclave used for SSL.	'HEAP(,,ANY), STACK(,,ANY), STORAGE(,,,4K), BELOWHEAP(4K,,), LIBSTACK(4K,,), ALL31(CON)'	Yes	No
ODBCALLRPCS	Mainframe Adapter ClientS CAN USE ODBC CALL RPC'S. (YES, NO)	YES	Yes	No
PARAMPLIST	PASS PARAMETERS USING AN OS PLIST. (YES, NO)	NO	Yes	No
PBFU	ADD 1 NULL BYTE TO COLUMN FOR POWERBUILDER. (YES, NO)  This parameter when set will cause one additional byte to be added to the precision of the column. This byte will serve as a NULL termination indicator for PowerBuilder Mainframe Adapter Clients.	NO	Yes	No
PRELOAD	PRELOAD REENTRANT RPC MODULES. (YES, NO)  This parameter controls whether the product will attempt to preload customer-written application programs from the dataset allocated to the SDBRPCPL ddname during start-up. If the SDBRPCPL ddname is not allocated by the started-task JCL, no preloading is performed. All load modules within the allocated dataset should be flagged as REENTRANT, REUSEABLE, and RMODE(ANY). Do not allow non-reentrant or RMODE(24) modules to reside in this library.  (Continued on next page)	YES	No	No

PRODRPC Parameter Group				
Parameter Name	Parameter Description	Default Value	Update	Output Only
PRELOAD (Continued)	(Continued from previous page) The advantages of using PRELOAD from SDBRPCPL are twofold: <ul style="list-style-type: none"> <li>Frequently used customer-written modules are loaded at start-up and remain in storage during Mainframe Adapter Server operations.</li> <li>The in-storage directory of the SDBRPCPL load library can be refreshed dynamically using the ISPF Option 5.11 panels.</li> </ul> <b>Note:</b> The in-storage director for the SDBRPCPL library cannot be refreshed after start-up.	YES	No	No
PREPARECALLRPCS	MAINFRAME ADAPTER CLIENTS CAN PREPARE ODBC CALL RPCS. (YES, NO) This parameter controls if a CALL SQL statement can be prepared or not. Possible values are: <ul style="list-style-type: none"> <li><b>YES:</b> (Default) ODBC Mainframe Adapter Client applications will be allowed to prepare CALL SQL statements. Note that the CALL SQL statement will actually be executed at prepare time so that result set information can be made available after the prepare is completed. Even if this parameter is set to YES, CALL SQL statements with parameter markers cannot be prepared.</li> <li><b>NO:</b> CALL SQL statements cannot be prepared.</li> </ul>	YES	Yes	No
ROLLBACKRPCABEND	EXECUTE ROLLBACK AFTER RPC ABEND. (YES, NO) This parameter specifies whether a COMMIT or a ROLLBACK should be executed after an RPC abends. If this parameter is set, then a ROLLBACK will be executed after each RPC abend. If this parameter is not set, then a COMMIT will be executed.	NO	Yes	No
RPC01SPECIALREQ	RPC01 WITH SPECIAL REQUIREMENTS. (YES, NO)	NULL	Yes	No
RPC02SPECIALREQ	RPC02 WITH SPECIAL REQUIREMENTS. (YES, NO)	NULL	Yes	No



<b>PRODRPC Parameter Group</b>				
<b>Parameter Name</b>	<b>Parameter Description</b>	<b>Default Value</b>	<b>Update</b>	<b>Output Only</b>
RPC03SPECIALREQ	RPC03 WITH SPECIAL REQUIREMENTS. (YES, NO)	NULL	Yes	No
RPC04SPECIALREQ	RPC04 WITH SPECIAL REQUIREMENTS. (YES, NO)	NULL	Yes	No
RPC05SPECIALREQ	RPC05 WITH SPECIAL REQUIREMENTS. (YES, NO)	NULL	Yes	No
RPC06SPECIALREQ	RPC06 WITH SPECIAL REQUIREMENTS. (YES, NO)	NULL	Yes	No
RPC07SPECIALREQ	RPC07 WITH SPECIAL REQUIREMENTS. (YES, NO)	NULL	Yes	No
RPC08SPECIALREQ	RPC08 WITH SPECIAL REQUIREMENTS. (YES, NO)	NULL	Yes	No
RPC09SPECIALREQ	RPC09 WITH SPECIAL REQUIREMENTS. (YES, NO)	NULL	Yes	No
RPC10SPECIALREQ	RPC10 WITH SPECIAL REQUIREMENTS. (YES, NO)	NULL	Yes	No
RPC11SPECIALREQ	RPC11 WITH SPECIAL REQUIREMENTS. (YES, NO)	NULL	Yes	No
RPC12SPECIALREQ	RPC12 WITH SPECIAL REQUIREMENTS. (YES, NO)	NULL	Yes	No
RPC13SPECIALREQ	RPC13 WITH SPECIAL REQUIREMENTS. (YES, NO)	NULL	Yes	No
RPC14SPECIALREQ	RPC14 WITH SPECIAL REQUIREMENTS. (YES, NO)	NULL	Yes	No
RPC15SPECIALREQ	RPC15 WITH SPECIAL REQUIREMENTS. (YES, NO)	NULL	Yes	No
RPC16SPECIALREQ	RPC16 WITH SPECIAL REQUIREMENTS. (YES, NO)	NULL	Yes	No
RPC17SPECIALREQ	RPC17 WITH SPECIAL REQUIREMENTS. (YES, NO)	NULL	Yes	No
RPC18SPECIALREQ	RPC18 WITH SPECIAL REQUIREMENTS. (YES, NO)	NULL	Yes	No
RPC19SPECIALREQ	RPC19 WITH SPECIAL REQUIREMENTS. (YES, NO)	NULL	Yes	No
RPC20SPECIALREQ	RPC20 WITH SPECIAL REQUIREMENTS. (YES, NO)	NULL	Yes	No
RPC21SPECIALREQ	RPC21 WITH SPECIAL REQUIREMENTS. (YES, NO)	NULL	Yes	No

<b>PRODRPC Parameter Group</b>				
<b>Parameter Name</b>	<b>Parameter Description</b>	<b>Default Value</b>	<b>Update</b>	<b>Output Only</b>
RPC22SPECIALREQ	RPC22 WITH SPECIAL REQUIREMENTS. (YES, NO)	NULL	Yes	No
RPC23SPECIALREQ	RPC23 WITH SPECIAL REQUIREMENTS. (YES, NO)	NULL	Yes	No
RPC24SPECIALREQ	RPC24 WITH SPECIAL REQUIREMENTS. (YES, NO)	NULL	Yes	No
RPC25SPECIALREQ	RPC25 WITH SPECIAL REQUIREMENTS. (YES, NO)	NULL	Yes	No
RPC26SPECIALREQ	RPC26 WITH SPECIAL REQUIREMENTS. (YES, NO)	NULL	Yes	No
RPC27SPECIALREQ	RPC27 WITH SPECIAL REQUIREMENTS. (YES, NO)	NULL	Yes	No
RPC28SPECIALREQ	RPC28 WITH SPECIAL REQUIREMENTS. (YES, NO)	NULL	Yes	No
RPC29SPECIALREQ	RPC29 WITH SPECIAL REQUIREMENTS. (YES, NO)	NULL	Yes	No
RPC30SPECIALREQ	RPC30 WITH SPECIAL REQUIREMENTS. (YES, NO)	NULL	Yes	No
RPC31SPECIALREQ	RPC31 WITH SPECIAL REQUIREMENTS. (YES, NO)	NULL	Yes	No
RPC32SPECIALREQ	RPC32 WITH SPECIAL REQUIREMENTS. (YES, NO)	NULL	Yes	No
RPC33SPECIALREQ	RPC33 WITH SPECIAL REQUIREMENTS. (YES, NO)	NULL	Yes	No
RPC34SPECIALREQ	RPC34 WITH SPECIAL REQUIREMENTS. (YES, NO)	NULL	Yes	No
RPC35SPECIALREQ	RPC35 WITH SPECIAL REQUIREMENTS. (YES, NO)	NULL	Yes	No
RPC36SPECIALREQ	RPC36 WITH SPECIAL REQUIREMENTS. (YES, NO)	NULL	Yes	No
RPC37SPECIALREQ	RPC37 WITH SPECIAL REQUIREMENTS. (YES, NO)	NULL	Yes	No
RPC38SPECIALREQ	RPC38 WITH SPECIAL REQUIREMENTS. (YES, NO)	NULL	Yes	No
RPC39SPECIALREQ	RPC39 WITH SPECIAL REQUIREMENTS. (YES, NO)	NULL	Yes	No
RPC40SPECIALREQ	RPC40 WITH SPECIAL REQUIREMENTS. (YES, NO)	NULL	Yes	No

PRODRPC Parameter Group				
Parameter Name	Parameter Description	Default Value	Update	Output Only
RPC41SPECIALREQ	RPC41 WITH SPECIAL REQUIREMENTS. (YES, NO)	NULL	Yes	No
RPC42SPECIALREQ	RPC42 WITH SPECIAL REQUIREMENTS. (YES, NO)	NULL	Yes	No
RPC43SPECIALREQ	RPC43 WITH SPECIAL REQUIREMENTS. (YES, NO)	NULL	Yes	No
RPC44SPECIALREQ	RPC44 WITH SPECIAL REQUIREMENTS. (YES, NO)	NULL	Yes	No
RPC45SPECIALREQ	RPC45 WITH SPECIAL REQUIREMENTS. (YES, NO)	NULL	Yes	No
RPC46SPECIALREQ	RPC46 WITH SPECIAL REQUIREMENTS. (YES, NO)	NULL	Yes	No
RPC47SPECIALREQ	RPC47 WITH SPECIAL REQUIREMENTS. (YES, NO)	NULL	Yes	No
RPC48SPECIALREQ	RPC48 WITH SPECIAL REQUIREMENTS. (YES, NO)	NULL	Yes	No
RPC49SPECIALREQ	RPC49 WITH SPECIAL REQUIREMENTS. (YES, NO)	NULL	Yes	No
RPC50SPECIALREQ	RPC50 WITH SPECIAL REQUIREMENTS. (YES, NO)	NULL	Yes	No
RPCAMODE24	SUPPORT AMODE(24)RPCS. (YES, NO)  This parameter controls whether or not RPCs executing in AMODE(24) should be supported. Possible values are: <ul style="list-style-type: none"> <li><b>YES.</b> RPCs executing in AMODE(24) will be correctly supported.</li> <li><b>NO.</b> (Default) RPCs will fail. RMODE(24) RPCs are always supported.</li> </ul> <b>Note:</b> Setting this parameter to YES will increase 24-bit storage requirements and reduce RPCs handling capacity.	NO	Yes	No
RPCCURRENT	CURRENTLY ACTIVE RPC VALUE.  This parameter is used to display the number RPCs that are currently executing. This parameter cannot be used to modify the current RPC execution count.	0 RPCS	No	Yes

PRODRPC Parameter Group				
Parameter Name	Parameter Description	Default Value	Update	Output Only
RPCCURRENTWAIT	<p>NUMBER OF RPC'S CURRENTLY WAITING.</p> <p>This parameter is used to display the number of RPC's that are currently waiting. An RPC can be waiting to execute because the maximum concurrent number of RPCs allowed (RPCMAX) has been exceeded.</p>	<b>0 RPCS</b>	No	Yes
RPCDEFAULTSCHEMA	<p>RPC DEFAULT SCHEMA NAME.</p> <p>This parameter is used to determine whether an unqualified stored procedure name (one without a period to specifically indicate a schema) should be run as a NEON stored procedure or an IBM stored procedure.</p>	<b>'NEON'</b>	Yes	No
RPCHIGH	<p>CONCURRENT RPC HIGH VALUE.</p> <p>This parameter is a display only field. The number of currently executing RPCs, contained in RPCCURRENT, is compared against the value in RPCHIGH. When RPCCURRENT is greater than RPCHIGH, RPCHIGH is replaced with the value in RPCCURRENT.</p>	<b>0 PRCS</b>	No	No
RPCMAX	<p>MAXIMUM CONCURRENT RPC'S ALLOWED.</p> <p>This parameter controls the maximum number of RPCs that are allowed to concurrently execute. Any thread that needs to execute an RPC after the limit is reached will be forced to wait. If this parameter is not set, then there is no limit on the number of RPCs that can concurrently execute.</p> <p><b>Minimum Value: 0</b> <b>Maximum Value: 10000</b></p>	<b>0 RPCS</b>	Yes	No
RPCSUBPOOL	<p>EXEC CICS GETMAIN SIMULATION SUBPOOL.</p> <p>This parameter is used to simulate the EXEC CICS GETMAIN interface for RPCs executing in the main product address space. All storage requests from RPCs are satisfied from this subpool. The entire subpool is released at the end of RPC execution. This subpool is not used to get or free storage in any actual CICS address space.</p> <p><b>Minimum Value: 0</b> <b>Maximum Value: 127</b></p>	<b>9</b>	Yes	No

<b>PRODRPC Parameter Group</b>				
<b>Parameter Name</b>	<b>Parameter Description</b>	<b>Default Value</b>	<b>Update</b>	<b>Output Only</b>
RUNIBMPROCEDURES	RUN IBM STORED PROCEDURES INTERNALLY. (YES, NO)  This parameter specifies whether or not IBM stored procedures should be executed inside the main Mainframe Adapter Server address space or using a DB2 stored procedure address space. If this parameter is set to YES, IBM stored procedures will be executed inside the main product address space. Otherwise, they will be executed in a DB2 stored procedures address space.	<b>NO</b>	No	No
SE01	SYSTEM ENGINEERING FLAG 01. (YES, NO)  This parameter is for internal use only. It is for development purposes and should never be set for any other reason.	<b>NO</b>	Yes	No
SE02	SYSTEM ENGINEERING FLAG 02. (YES, NO)  This parameter is for internal use only. It is for development purposes and should never be set for any other reason.	<b>NO</b>	Yes	No
SE03	SYSTEM ENGINEERING FLAG 03. (YES, NO)  This parameter is for internal use only. It is for development purposes and should never be set for any other reason.	<b>NO</b>	Yes	No
SE04	SYSTEM ENGINEERING FLAG 04. (YES, NO)  This parameter is for internal use only. It is for development purposes and should never be set for any other reason.	<b>NO</b>	Yes	No
SE05	SYSTEM ENGINEERING FLAG 05. (YES, NO)  This parameter is for internal use only. It is for development purposes and should never be set for any other reason.	<b>NO</b>	Yes	No
SEVERRPCABEND	SEVER SESSION IF RPC ABENDS. (YES, NO)  This parameter specifies whether the session should be terminated upon an RPC abend. This flag is used to avoid various high-level language runtime environment problems.	<b>YES</b>	Yes	No

**PRODRRS**

PRODRRS Parameter Group				
Parameter Name	Parameter Description	Default Value	Update	Output Only
RECTABLEENTRIES	<p>RECOVERY TABLE ENTRIES.</p> <p>This parameter specifies the maximum number of entries in the RRS recovery table. Entries are placed in the RRS recovery table when two-phase commit transactions are in doubt due to error conditions that develop during processing of the transaction. The default value is 400 entries and the minimum number of entries that will be accepted is 200. If the maximum size of the table is exceeded, information on in-doubt transactions will be lost.</p>	0	No	No
RESOURCEMGRNAME	<p>RESOURCE MANAGER NAME.</p> <p>This parameter specifies the sysplex unique name of the RRS Resource Manager (which is an SDSRM). See the <i>IBM Programming: Resource Recovery</i> manual (GC28-1739) for valid naming conventions.</p> <p>If not specified, a 32-character name will be created as follows:</p> <ul style="list-style-type: none"> <li>Chars 1-24: NEONRRS.RESOURCE.MANAGER</li> <li>Chars 25-28: The Shadow subsystem name such as SDBA, SDBB, etc.</li> <li>Chars 29-32: System SMF ID</li> </ul> <p><b>Note:</b> If the name is changed, any incomplete (in-doubt) transactions from the previous run will not be able to be completed.</p>	'NEONRRS. RESOURCE. MANAGER SDBBDEV1'	No	No
RRS	<p>INITIALIZE RRS SUPPORT. (YES, NO)</p> <p>This parameter activates RRS support. This parameter must be set to YES to activate RRS.</p>	NO	No	No
RRS2PCALL	<p>RRS 2PC FOR ALL TRANSACTIONS. (YES, NO)</p> <p>This parameter determines whether or not RRS 2-phase commit processing should be done for all transactions in this address space.</p>	NO	No	No

<b>PRODRRS Parameter Group</b>				
<b>Parameter Name</b>	<b>Parameter Description</b>	<b>Default Value</b>	<b>Update</b>	<b>Output Only</b>
RRSDELETEDSNARRS	ISSUE DELETES FOR DSNARRS. (YES, NO)  This parameter determines whether Shadow will artificially keep the use count for module DSNARRS down by issuing OS/390 or z/OS DELETES whenever DSNRLI is invoked. This parameter will be defaulted to YES until IBM/DB2 resolves this problem. It avoids an abend 906-8 at RRSAF OPEN THREAD (actually DB2 IDENTIFY).	<b>YES</b>	Yes	No
RRSCICS	RRS CICS SUPPORT. (YES, NO)  This parameter specifies if RRS CICS support is active.	<b>NO</b>	Yes	No
RRSIMSTM	RRS IMS/TM SUPPORT. (YES, NO)  This parameter specifies if RRS IMS/TM support is active.	<b>NO</b>	Yes	No

**PRODSECURITY**

PRODSECURITY Parameter Group				
Parameter Name	Parameter Description	Default Value	Update	Output Only
ACF2SAFCALL	<p>ACF2 ENVIRONMENT SUPPORTS SAF CALLS. (YES, NO)</p> <p>This parameter allows the customer to control when and if they will use SAF support for ACF2.</p> <p><b>Note:</b> This parameter only applies to resource rules; logon processing uses SAF in ACF2 releases which support it. This parameter does not apply to the Shadow Web Server.</p>	YES	Yes	No
ALLOCSECURITYHIGH	<p>SECURITY BLOCKS CAN BE ALLOCATED &gt; 16MB. (YES, NO)</p> <p>This parameter shows if ACF2 and RACF (SAF) control blocks will be allocated above or below the 16 MB line. This parameter is not read only. The value can be set. However, it is normally based on the release of the security subsystem.</p>	YES	Yes	No
AUTOSUPPLYVOLSER	<p>AUTOMATICALLY SUPPLY VOLSER FOR SWSECURE API. (YES, NO)</p> <p>This parameter controls whether the SDBECURE API automatically retrieves and supplies a VOLSER for dataset authorization requests. When set to YES, a VOLSER is automatically retrieved and supplied when a VOLSER is not already supplied by the caller.</p> <p>Supplying a VOLSER on dataset authorization checking requests prevents access to datasets that have a RACF discrete security profile. Without the VOLSER, RACF may indicate that authorization to a dataset is allowed, even though a subsequent OPEN attempt may fail with an S913 system abend.</p> <p><b>Note:</b> The system never attempts to supply a VOLSER in the following situations:</p> <ul style="list-style-type: none"> <li>For API requests that are issued while running in a cross-memory environment. (Certain types of SEF ATH rules operate in cross-memory mode.)</li> <li>If the dataset has been migrated to offline storage by DFHSM or other space management product.</li> </ul>	NO	Yes	No



PRODSECURITY Parameter Group				
Parameter Name	Parameter Description	Default Value	Update	Output Only
BYPASSEF	<p>BYPASS SEF FOR RECONNECT PROCESSING. (YES, NO)</p> <p>This product parameter controls if SEF should be invoked when a Mainframe Adapter Client reconnects to the Shadow Mainframe Adapter Server. This is a performance enhancement used to speed up processing when an ODBC Mainframe Adapter Client reconnects to the Mainframe Adapter Server. This is important if VCF is in use. This parameter cannot be changed after product initialization because of security restrictions.</p>	NO	No	No
CENSORAPIDATAVALUES	<p>CENSOR VARIOUS API DATA VALUES. (YES, NO)</p> <p>This parameter indicates if display of various API data should be restricted to authorized users. If off, display of the data is unrestricted.</p>	NO	Yes	No
CENSORSSEAPIDATA-VALS	<p>CENSOR SSL VARIOUS API DATA VALUES. (YES, NO)</p> <p>This parameter indicates if display of various API data for SSL sessions should be restricted to authorized users. If off, display of the data is unrestricted.</p>	NO	Yes	No
CENSORTRACEWRITES	<p>CENSOR ALL TRACE WRITES</p> <p>If set to YES, all potentially sensitive data is censored from trace data before it is written. In this situation, it will be impossible to review trace data and obtain sensitive data from it. It may also make problem determination more difficult, because ALL data may be censored from certain records.</p>	NO	Yes	No
Mainframe Adapter ClientLOGON	<p>Mainframe Adapter ClientS CAN BE AUTHENTICATED BY NOS. (YES, NO)</p>	NO	Yes	No

PRODSECURITY Parameter Group				
Parameter Name	Parameter Description	Default Value	Update	Output Only
Mainframe Adapter ClientLOGONLOGOPT	<p>NORMAL Mainframe Adapter Client LOGON RACF LOG= OPTION</p> <p>If Mainframe Adapter ClientLOGONLOGOPT is set to ASIS, then normal Mainframe Adapter Client logo is issued with LOG=ASIS in effect. If the parameter is set to ALL, then normal Mainframe Adapter Client logon is issued with LOG=ALL in effect. If the parameter is set to NONE, then normal Mainframe Adapter Client logon is issued with LOG=NONE in effect. This option applies only to RACF systems and is also used for Mainframe Adapter Client logoff operations. You MUST set the SAFVERSION start-up parameter to "1.9" for this option to have any effect. This option is IGNORED if SAFVERSION is set to the default ("1.8") value.</p>	ASIS		
Mainframe Adapter ClientLOGONSTATOPT	<p>NORMAL Mainframe Adapter Client LOGON RACF STAT= OPTION</p> <p>If Mainframe Adapter ClientLOGONSTATOPT is set to ASIS, then normal Mainframe Adapter Client logons are issued with STAT=ASIS in effect. If the parameter is set to NO, then normal Mainframe Adapter Client logons are issued with STAT=NO in effect. This option applies only to RACF systems. You MUST set the SAFVERSION start-up parameter to "1.9" for this option to have any effect. This option is IGNORED if SAFVERSION is set to the default ("1.8") value.</p>	ASIS	Yes	No

PRODSECURITY Parameter Group				
Parameter Name	Parameter Description	Default Value	Update	Output Only
FORCESECURITYLOW	<p>FORCE ALL ACEES BLKS BELOW-THE-LINE. (YES, NO)</p> <p>This parameter controls whether ACEE blocks will be unconditionally allocated below the 16 MB line. This parameter overrides any other setting. In order to acquire ACEE blocks above the line, ALLOCSECURITYHIGH must be YES and this parameter must be set to NO. The ALLOCSECURITYHIGH parameter is normally set to the correct value based on the release level of the security subsystem being used, and therefore represents the eligibility of above-the-line ACEE blocks. However, above-the-line ACEE blocks can produce intermittent and unpredictable S0C4 ABENDS within OS/390 or z/OS dataset OPEN and CLOSE processing. If you are using only DB2 services, you may wish to allocate ACEE blocks above the line, but if you run user-written programs which use OS/390 or z/OS QSAM, BPAM, BSAM, or VSAM datasets, you should probably set this parameter to YES.</p>	NO	Yes	No
FORCESHAREDACEELOW	<p>FORCE SHARED ACEE BLKS BELOW-THE-LINE. (YES, NO)</p> <p>This parameter controls whether all shared ACEE blocks will be unconditionally allocated below the 16 MB line. This parameter applies <i>only</i> to ACEE blocks that will be shared by more than one subtask within the system. When set to YES, this parameter allows you to use below-the-line storage for only the shared ACEE blocks, but without using the FORCESECURITYLOW option to place <i>all</i> ACEE blocks below the line.</p>	NO	Yes	No

PRODSECURITY Parameter Group				
Parameter Name	Parameter Description	Default Value	Update	Output Only
GETLOGONMESSAGES	<p>GET ALL SAF LOGON MESSAGES. (YES, NO)</p> <p>This parameter controls if all of the messages from SAF LOGON processing should be obtained or not. Possible values are:</p> <ul style="list-style-type: none"> <li><b>YES:</b> All of the messages will be obtained. Note that setting this parameter to YES will force the security control blocks to be located below the 16 MB line.</li> <li><b>NO:</b> (Default) Only a subset of the SAF LOGON messages will be obtained from the SAF interface, however, it will be possible to locate the security control blocks above the 16 MB line.</li> </ul>	NO	Yes	No
HEXIPSOURCE	<p>USE HEXADECIMAL IP ADDRESS AS SOURCE. (YES, NO)</p> <p>This parameter is used to indicate that the SOURCE for SAF calls should be set to the hexadecimal form of the IP address for Mainframe Adapter Clients connected using TCP/IP. The four byte binary IP address is converted to an eight byte upper case hexadecimal string. This string is used as the SOURCE for SAF calls. The SOURCE is where the SAF request is presumed to have come from. This used to mean terminal name and now has other meanings as well.</p> <p><b>Note:</b> This parameter only applies to TCP/IP connections.</p>	NO	Yes	No
LERUNTIMEOPTS	<p>LE/370 SSL ENCLAVE RUNTIME OPTIONS.</p> <p>This parameter allows you to set the Language Environment runtime options used by the system when invoking internal High-Level Language (HLL) components. This parameter only applies to the enclave used for SSL processing. A separate field is used to provide runtime options for the enclave used for RPCs.</p>	NULL	Yes	No

PRODSECURITY Parameter Group				
Parameter Name	Parameter Description	Default Value	Update	Output Only
PASSEMPYGROUPNAME	<p>PASS EMPTY GROUP NAME TO RACROUTE. (YES, NO)</p> <p>This parameter specifies if a SAF-based RACROUTE REQUEST=VERIFY call should pass a NULL group name on the request. Passing a NULL group name allows a user-written SAF exit routine, such as ICHRTX00, to manipulate the group name, even though Shadow does not furnish or otherwise process RACF-type group names.</p>	NO	Yes	No
PASSIMSGROUPNAME	<p>PASS SAF GROUP NAME TO IMS. (YES, NO)</p> <p>This parameter specifies whether or not to pass the SAF group name to IMS. Passing the SAF group name in the PROFILE parameter allows the group name, associated with the USERID, to appear in the I/O PCB of the IMS transaction.</p>	YES	Yes	No
PROTECTRESALL	<p>PROTECT UNDEFINED RESOURCES. (YES, NO)</p> <p>This parameter controls how Shadow will deal with unprotected resources. Possible values are:</p> <ul style="list-style-type: none"> <li>• <b>YES:</b> Shadow will fail unprotected resources with a resource not defined to RACF message.</li> <li>• <b>NO:</b> (Default) Shadow will allow access to unprotected resources.</li> </ul>	NO	Yes	No

PRODSECURITY Parameter Group				
Parameter Name	Parameter Description	Default Value	Update	Output Only
PROVIDEPASSWORDS	<p>PROVIDE PASSWORDS FOR LOGON RULES. (YES, NO)</p> <p>This parameter controls whether or not passwords will be provided to LOGON rules. Possible values are:</p> <ul style="list-style-type: none"> <li>• <b>YES:</b> Passwords will be provided to LOGON rules.</li> <li>• <b>NO:</b> (Default) Passwords will not be provided to LOGON rules.</li> <li>• <b>CHANGE:</b> Passwords can be changed in LOGON ATH rules. Changing a password in a LOGON ATH rule does not change the password in the security product. It only changes the password used for the current connection to the host. This parameter cannot be changed after product initialization for security reasons.</li> </ul> <p><b>Note:</b> Passwords are provided as plaintext strings or they are set to blanks.</p>	NO	No	No
RACFGROUPLIST	CHECK RACF GROUP LIST FLAG (YES, NO)	NO	Yes	No
RECONNLOGONLOGOPT	<p>RECONN MAINFRAME ADAPTER CLIENT LOGON RACF LOG= OPTION</p> <p>If RECONNLOGONLOGOPT is set to ASIS, then VCF-reconnect logo is issued with LOG=ASIS in effect. If the parameter is set to ALL, then VCF-reconnect logon is issued with LOG=ALL in effect. If the parameter is set to NONE, then reconnect Mainframe Adapter Client logon is issued with LOG=NONE in effect. This option applies only to RACF systems and is also used for Mainframe Adapter Client logoff operations. You MUST set the SAFVERSION start-up parameter to "1.9" for this option to have any effect. This option is IGNORED if SAFVERSION is set to the default ("1.8") value.</p>	ASIS	Yes	No

PRODSECURITY Parameter Group				
Parameter Name	Parameter Description	Default Value	Update	Output Only
RECONNLOGONSTATOPT	<p>RECONN MAINFRAME ADAPTER CLIENT LOGON RACF STAT= OPTION</p> <p>If RECONNLOGONSTATOPT is set to NO, then VCF-reconnect logon are issued with STAT=ASIS in effect. If the parameter is set to NO, then VCF-reconnect logons are issued with STAT=NO in effect. This option applies only to RACF systems. You MUST set the SAFVERSION start-up parameter to "1.9" for this option to have any effect. This option is IGNORED if SAFVERSION is set to the default ("1.8") value.</p>	ASIS	Yes	No
RESOURCETYPE	RESOURCE TYPE FOR RESOURCE RULES.	'NON'	Yes	No
RULESETSEFAUTH	<p>RULESET SEFAUTH() OVERRIDE.</p> <p>This parameter indicates whether the SEFAUTH() settings for individual rulesets are to to be honored or overridden on a global basis. The ruleset SEFAUTH() setting determines whether SEF directly checks each command request to see if the end user has MVS authorization to the underlying ruleset before performing an operation on behalf of the user. Examples of such operations are enabling a rule, setting a rule's auto-enable flag, or putting a ruleset into offline status.</p> <p>This checking is in addition to checking the the end user's authorization to use SEF facilities, which is always performed using the SEF resource in the Shadow Mainframe Adapter Server's resource class list.</p> <p>In addition, MVS will <i>always</i> perform an authorization check if an end-user attempts to browse, edit, or delete a ruleset member under ISPF.</p> <p>(Continued on next page)</p>	NOOVERRIDE	Yes	No

PRODSECURITY Parameter Group				
Parameter Name	Parameter Description	Default Value	Update	Output Only
RULESETSEFAUTH (Continued)	<p>(Continued from previous page)</p> <p>The SEFAUTH option specifies only how requests are handled when they are processed within the SEF subtask inside the Mainframe Adapter Server on behalf of a user request.</p> <p>SEFAUTH specifies the level of operation that will <i>not</i> require authorization in order to proceed. A lower level of SEFAUTH means that less control is placed over the operations on rules.</p> <p>This parameter can be set to override SEFAUTH as follows:</p> <ul style="list-style-type: none"> <li>• <b>NOOVERRIDE:</b> (Default) Each individual ruleset's SEFAUTH() setting is honored.</li> <li>• <b>NONE:</b> All ruleset-level SEFAUTH settings are ignored and this setting is used instead. At this level, SEF never checks the end user's authorization for any operation.</li> <li>• <b>READ:</b> All ruleset-level SEFAUTH settings are ignored and this setting is used instead. At this level, SEF does not check the end user's authorization when performing a read-only operation (such as displaying a ruleset member list or status of an individual rule). SEF will check the end user's authorization for single-member-update operations or for mass member updates.</li> <li>• <b>UPDATE:</b> All ruleset-level SEFAUTH settings are ignored and this setting is used instead. At this level, SEF does not check authorization for read-only and single-member-update operations (such as enabling a rule or setting a rule's auto-enable flag). SEF will check the end user's authorization for mass member updates or for changing the status of an entire ruleset.</li> <li>• <b>ALL:</b> All ruleset-level SEFAUTH settings are ignored and this setting is used instead. At this level, specifies that SEF always checks the end user's authorization for each operation.</li> </ul> <p><b>Note:</b> This parameter is not used when SEFV3COMPATIBLE is set to YES; it is available only for V4+ SEF configurations.</p>	NOOVERRIDE	Yes	No



PRODSECURITY Parameter Group				
Parameter Name	Parameter Description	Default Value	Update	Output Only
SAFVERSION	SAF PARAMETER LIST VERSION. This parameter controls the version of the SAF parameter list passed to the SAF interface. Some operands such as POE (port-of-entry) can only be used with later versions of the SAF parameter list.	1.8	Yes	No
SECURITYMODE	SHARED SECURITY MODE. This parameter controls how security environments are shared. Possible values are: <ul style="list-style-type: none"> <li><b>NONE:</b> (Default) Security environments cannot be shared.</li> <li><b>BASIC:</b> Some sharing of security environments is possible.</li> </ul> <b>Note:</b> This field cannot be changed after product initialization because of security restrictions.	NONE	No	No
SECURITYMSGSUPP	SUPPRESS MESSAGES FROM RESOURCE CHECKS. (YES, NO) This parameter determines whether the product issues RACP security resource check requests with MSGSUPP=YES specified. If resource validation fails, a TSO user is not notified of the authorization failure.	NO	Yes	No
SECURITYPACKAGE	SECURITY PRODUCT.	RACF (DEPENDING ON SECURITY PRODUCT)	N/A	Yes
SECURITYVERSION	SECURITY PRODUCT VERSION.	'2.60' (DEPENDING ON SECURITY PRODUCT)	No	Yes
SHARERUNAUTHACEES	SHARE/CACHE RUNAUTH ACEE BLOCKS. (YES, NO) This parameter determines whether all explicitly specified RUNAUTH userids and ACEE control blocks are cached and globally shared by all WWW transaction subtasks. Sharing of RUNAUTH userid control blocks in this way may significantly reduce the CPU overhead associated with the use of third-party-proxy userid processing. This option operates independently of thread re-use and Mainframe Adapter Client userid/ACEE caching operations.	NO	No	No

PRODSECURITY Parameter Group				
Parameter Name	Parameter Description	Default Value	Update	Output Only
SSL	<p>SSL CONNECTIONS SUPPORTED. (YES, NO)</p> <p>This parameter determines whether SSL connections to the Mainframe Adapter Server will be supported. If not enabled, SSL sessions are not supported. SSL connections require that the OS/390 or z/OS LE/370 run-time modules be present in the LINKLIST or STEPLIB libraries, and that the SSL support modules, distributed separately, be within the STEPLIB library.</p>	NO	No	No
SSLMainframe Adapter ClientAUTH	<p>SSL Mainframe Adapter Client AUTHENTICATION</p> <p>Specifies which type of Mainframe Adapter Client certificate authentication will be performed by the Mainframe Adapter Server. Allowed values are,</p> <ul style="list-style-type: none"> <li>• NONE - No Mainframe Adapter Client authentication will be performed. This is the default.</li> <li>• LOCAL - The Mainframe Adapter Clients certificate will be verified using the local key database file or RACF keyring.</li> <li>• LDAPSSL - The Mainframe Adapter Clients certificate will be verified using the key database of the X500 Mainframe Adapter Server with an SSL connection to the Mainframe Adapter Server.</li> <li>• LDAP - The Mainframe Adapter Clients certificate will be verified using the key database of the X500 Mainframe Adapter Server.</li> <li>• PASSTHRU - the Mainframe Adapter Clients certificate will not be verified.</li> </ul> <p>(Note that the two LDAP options are not currently available.</p>	NONE	No	No
SSENLCLAVETERMINATE	<p>TERMINATE LE ENCLAVE AT SSL CLOSE. (YES, NO)</p> <p>This parameter determines whether the Mainframe Adapter Server will terminate the transaction subtask's LE/370 enclave after any SSL connection is closed. This option is for System Engineering only and should only be used when directed by NEON Systems Customer Support.</p>	NO	No	No

PRODSECURITY Parameter Group				
Parameter Name	Parameter Description	Default Value	Update	Output Only
SSLINITIALIZED	<p>SSL SUPPORT HAS BEEN INITIALIZED. (YES, NO)</p> <p>This parameter is only used to show if SSL initialization was successfully completed. Possible values are:</p> <ul style="list-style-type: none"> <li><b>YES:</b> SSL support is ready for use.</li> <li><b>NO:</b> (Default) SSL cannot be used.</li> </ul>	NO	No	Yes
SSLINSTALLTYPE	<p>SSL INSTALLED SUPPORT.</p> <p>This parameter is a read-only value, set during product initialization. It provides the type of SSL which is installed/supported in the system.</p>	NONE	No	Yes
SSLKEYLABEL	<p>SSL KEY LABEL.</p> <p>This parameter specifies the label of the key (i.e., certificate) to be used by OS/390 System SSL services. See the <i>OS/390 System SSL Programming Guide and Reference</i> for information on key labels. This parameter is only used when SSLTYPE is OS390 or AUTO (OS/390 SSL support must be installed).</p>	NULL	No	No
SSLKEYPATH	<p>SSL KEY DATABASE.</p> <p>This parameter specifies the HFS path and file name of the OS/390 System SSL services key database. The key database is used to store digital certificates. See the <i>OS/390 System SSL Programming Guide and Reference</i> for information on how to build a key database. This parameter is only used when SSLTYPE is OS390 or AUTO (OS/390 SSL support must be installed).</p>	NULL	No	No
SSLKEYSTASH	<p>SSL PASSWORD STASH FILE.</p> <p>This parameter specifies the HFS path and file name of the OS/390 System SSL services stash file. The stash file is used to store encrypted passwords for key databases. See the <i>OS/390 System SSL Programming Guide and Reference</i> for information on how to build a password stash file. This parameter is only used when SSLTYPE is OS390 or AUTO (OS/390 SSL support must be installed).</p>	NULL	No	No

PRODSECURITY Parameter Group				
Parameter Name	Parameter Description	Default Value	Update	Output Only
SSLTYPE	<p>SSL IMPLEMENTATION TO USE.</p> <p>This parameter is used to request the type of SSL support to be used. Possible values are:</p> <ul style="list-style-type: none"> <li>• <b>AUTO:</b> Use OS/390 SSL services if detected; otherwise use SSLeay.</li> <li>• <b>SSLEAY:</b> (Default) Use SSLeay (software encryption only).</li> <li>• <b>OS390:</b> Use OS/390 SSL services. These use the hardware cryptographic compressor if one is installed.</li> </ul>	SSLEAY	No	No
SSLUSERID	<p>SSL RESOURCE MANAGER TASK USERID.</p> <p>This parameter specifies a highly-privileged userid under which the SSL resource manager subtask operates. If not specified, the SSL resource manager operates using the subsystem's address space level userid. This userid must be authorized to open and read the SSL private key and certificate files. Use of a separate userid for this task prevents other transaction subtasks, and the Mainframe Adapter Server, itself, from accessing this highly confidential information. NEON Systems strongly recommends that the private key and certificate files be defined to the security subsystem as highly restricted, with full auditing. The SSLUSERID should be authorized for read-only access to these files.</p>	NULL	No	No
STANDARDUSERID	<p>DEFAULT WWW RULE RUNAUTH USERID.</p> <p>This parameter specifies the OS/390 or z/OS userid under which Web transactions, by default, run. The userid specified is made the effective userid for web transactions unless WWW rules override this value. If the parameter is set to NONE, then the subsystem's userid is used.</p>	'NONE'	No	No

<b>PRODSECURITY Parameter Group</b>				
<b>Parameter Name</b>	<b>Parameter Description</b>	<b>Default Value</b>	<b>Update</b>	<b>Output Only</b>
TLSDYNAMICUSERIDS	IMPLEMENT DYNAMIC USERIDS FOR TLS. (YES, NO)  This parameter controls whether the generic userids supplied by a Shadow Enterprise Auditing enabled connection will be made active prior to most operations in Shadow. The SEF logon rule sets the Shadow Enterprise Auditing-enabled option and this option determines if the supplied generic userid will be used for RPC invocations, DB2 threads (only for RRSAF), CICS transactions, etc.	<b>YES</b>	No	No

**PRODSEF**

PRODSEF Parameter Group				
Parameter Name	Parameter Description	Default Value	Update	Output Only
ATHINDEX	AUTHORIZATION EPROCS INDEX POINTER.	X'00000000'	No	Yes
EPROINDEX	EPROCS SET INDEX POINTER	X'158CED38'	No	Yes
EPROSOURCETEXT	SAVE SOURCE TEXT WITH SEF EPROCS. (YES, NO)	YES	Yes	No
EXCINDEX	EXCEPTION EPROCS INDEX POINTER.	X'00000000'	No	Yes
GLVINDEXT	GLOBAL VARIABLE EPROCS INDEX POINTER.	X'00000000'	No	Yes
MSGDRAINRATE	ADDRESS SPACE MESSAGE DRAIN RATE. <b>Minimum Value: 1</b> <b>Maximum Value: 32767</b>	10	Yes	No
MSGTHRESHOLD	ADDRESS SPACE MESSAGE THRESHOLD. <b>Minimum Value: 10</b> <b>Maximum Value: 32767</b>	1000	Yes	No
NOCATCHUP	SUPPRESS TOD CATCHUP PROCESSING. (YES, NO).	YES	No	No
RPCINDEX	RPC EPROCS INDEX POINTER.	X'00000000'	No	Yes
SEFACTIVE	SEF PROCESSING ACTIVE. (YES, NO).	YES	No	No
SEFCMDQUEUE	ADDRESS SEF COMMAND QUEUE SIZE. <b>Minimum Value: 1</b> <b>Maximum Value: None</b>	128 ACTIONS	No	No
SEFDEFAULTADDRESS	DEFAULT HOST COMMAND ENVIRONMENT FOR SEF RULES.	'SEF'	Yes	No
SEFDESC	SEF MESSAGES DESCRIPTOR CODES.	X'0000'	Yes	No
SEFDEST	SEF MESSAGES DESTINATION BLOCK.	X'C200000000000000'	Yes	No
SEFEXECQUEUE	SEF EXECUTE QUEUE ADDRESS.	X'1579B000'	No	Yes
SEFFIRELIMIT	SEF GLOBAL EPROCS FIRING LIMIT.	10000	Yes	No

PRODSEF Parameter Group				
Parameter Name	Parameter Description	Default Value	Update	Output Only
SEFGLVEVENTS	GLV EVENTS ARE SUPPORTED. (YES, NO)  This parameter determines if GLV events are supported by the system. If set to YES, GLV events are generated and processed. Support for GLV events has a significant impact on virtual storage used by the subsystem. It is recommended that you <i>not</i> casually enable processing GLV events.	NO	No	No
SEFINITREXX	SEF INITIALIZATION REXX PROGRAM NAME.	'SDBBINEF'	No	No
SEFLIMITDISABLE	DISABLE SEF EPROCS IF FIRING LIMIT EXCEEDED. (YES, NO)	NO	Yes	No
SEFMAXCLAUSES	MAXIMUM NUMBER OF SEF REXX CLAUSES.  <b>Minimum Value: 1</b> <b>Maximum Value: None</b>	10000	Yes	No
SEFMAXCOMMANDS	MAXIMUM NUMBER OF SEF HOST COMMANDS.	400	Yes	No
SEFMAXPGMSIZE	MAXIMUM SEF PROGRAM SIZE IN BYTES.  <b>Minimum Value: 32768</b> <b>Maximum Value: None</b>	1048616	Yes	No
SEFMAXQUEUE	DEFAULT EXTERNAL QUEUE SIZE.  <b>Minimum Value: 1</b> <b>Maximum Value: None</b>	100	No	No
SEFMAXSAYS	MAXIMUM NUMBER OF SEF SAY STATEMENTS.	1000	Yes	No
SEFMAXSECONDS	MAXIMUM SECONDS OF SEF EXECUTION TIME.  <b>Minimum Value: 1</b> <b>Maximum Value: None</b>	10	Yes	No
SEFROUTE	SEF MESSAGES ROUTE CODES.	X'0000'	Yes	No
SEFSIZE	SEF WORK SPACE SIZE.  <b>Minimum Value: 49152</b> <b>Maximum Value: None</b>	262144 BYTES	No	No
SEFSUBPOOL	SEF STORAGE SUBPOOL NUMBER.	TWO	No	No

PRODSEF Parameter Group				
Parameter Name	Parameter Description	Default Value	Update	Output Only
SEFV3COMPATIBLE	SEF USES V3 FORMAT CONFIGURATION PARAMETERS. (YES, NO)  Possible values are: <ul style="list-style-type: none"> <li><b>YES:</b> Specifies that SEF should use version 3.1.1 and below compatible configuration parameters. For version 3.1.1 and below, SEF rulesets are designated by providing the dataset name prefix and suffix values and allowing SEF to locate the rulesets using a catalog search.</li> <li><b>NO:</b> (Default) Specifies that version 4+ configuration parameters are used. For version 4+, DEFINE RULESET statements must be coded in the initialization routine, and the following product parameters are ignored: EPROPREFIX, EPROSUFFIX, EPROALTFIX, AUTHEPROSET, TYPEPROSET, and WWWEPROSET.</li> </ul> <b>Note:</b> Existing customers that are using version 3.1 compatible configuration to define SEF rulesets must first upgrade to use version 4+ DEFINE RULESET configuration statements. HFS access is not provided when the Shadow Mainframe Adapter Server's SEFV3COMPATIBLE startup parameter is set to YES.	NO	No	No
SMFEPRODISABLE	SEF EPROC DISABLEMENT SMF RECORDING. (YES, NO)	NO	Yes	No
SQLINDEX	SQL EPROCS INDEX POINTER.	X'00000000'	No	Yes
TODINDEX	TIME-OF-DAY EPROCS INDEX POINTER.	X'00000000'	No	Yes
TSODESC	ADDRESS TSO MESSAGES DESCRIPTOR CODES.	X'0000'	Yes	No
TSODEST	ADDRESS TSO MESSAGES DESTINATION BLOCK.	X'0000000000000000'	Yes	No
TSOROUTE	ADDRESS TSO MESSAGES ROUTE CODES.	X'0000'	Yes	No
TYPINDEX	TYP EPROCS INDEX POINTER.	X'00000000'	No	Yes
WWWINDEX	WWW EPROCS INDEX POINTER.	X'00000000'	No	No



**PRODSQL**

<b>PRODSQL Parameter Group</b>				
<b>Parameter Name</b>	<b>Parameter Description</b>	<b>Default Value</b>	<b>Update</b>	<b>Output Only</b>
ADDITIONALSQDATA	<p>SEND ADDITIONAL DATA WITH SQL. (YES, NO)</p> <p>This parameter is used to control whether or not additional data should be sent to the host as part of each SQL operation. The additional data is needed to support per-SQL security processing. Possible values are:</p> <ul style="list-style-type: none"> <li><b>YES:</b> Additional data will be sent with all SQL operations.</li> <li><b>NO:</b> (Default) Only the standard data will be sent with each SQL operation.</li> </ul>	<b>NO</b>	Yes	No
ALWAYS SAVESQL	<p>ALWAYS SAVE SQL SOURCE. (YES, NO)</p>	<b>YES</b>	Yes	No
AUTOCOMMITCALL	<p>AUTOMATIC COMMIT AFTER CALL. (YES, NO)</p> <p>This parameter controls if a COMMIT should be automatically executed after a NEON or IBM DB2 stored procedure completes execution. The COMMIT is only done if this parameter is set to YES and if AUTO-COMMIT is active for the current host connection. The COMMIT will complete any pending database changes and release some (but not all) locks; however, the COMMIT will also destroy pending result sets for IBM DB2 stored procedures unless the cursors for the IBM DB2 stored procedure result sets are declared with HOLD.</p>	<b>YES</b>	Yes	No
AUTOCOMMITCC	<p>AUTOMATIC COMMIT AT CLOSE CURSOR. (YES, NO)</p>	<b>YES</b>	Yes	No
AUTOSTATICCOMMIT	<p>COMMIT AFTER DEFERRED CLOSE FOR AUTO-STATIC SQL. (YES, NO)</p>	<b>NO</b>	Yes	No
AUTOSTATICDEFER	<p>DEFER CLOSE FOR AUTO-STATIC SQL. (YES, NO)</p>	<b>YES</b>	Yes	No
AUTOSTATICSQL	<p>Mainframe Adapter ClientS CAN USE AUTO-STATIC SQL. (YES, NO)</p>	<b>NO</b>	Yes	No

PRODSQL Parameter Group				
Parameter Name	Parameter Description	Default Value	Update	Output Only
AUTOUSERID	AUTOMATIC USERID PROPAGATION. (YES, NO)  This parameter specifies whether to use automatic userid propagation. For more information, see "Step 4: (Optional) Install the DSN3@ATH Exit" within Chapter 4, "Shadow Interface for DB2: Installation," of the <i>Shadow Interface for DB2 User Documentation</i> .	YES	Yes	No
BLOCKFETCH	USE BLOCK FETCH. (YES, NO).	YES	Yes	No
BYPASSNEWPLANS	USE ONLY OLD STYLE DB2 PLANS. (YES, NO).  This parameter controls whether the system will always treat DB2 plans as the old style regardless if they have packaged support or not.	NO	No	No
CLOSEWITHDATA	CLOSE CURSOR EVEN WITH PENDING DATA. (YES, NO)  This parameter controls if the cursor of a SELECT result set should be closed before all of the rows have been sent back to the Mainframe Adapter Client. Setting this field to YES will allow a COMMIT to be executed before all of the result set rows have been transmitted back to the ODBC Mainframe Adapter Client application. Of course, the COMMIT will only be executed if COMMIT after close cursor has been requested.	NO	Yes	No
CREATEGLOBAL	CREATE GLOBAL TEMPORARY TABLES. (YES, NO)  This parameter controls if Global Temporary Tables (GTTs) should be created dynamically whenever a missing table is detected. Possible values are: <ul style="list-style-type: none"> <li><b>YES:</b> (Default) A Global Temporary Table will be created whenever a PREPARE of an insert shows that the table does not exist.</li> <li><b>NO:</b> A Global Temporary Table will not be created and the INSERT will fail.</li> </ul>	YES	Yes	No

PRODSQL Parameter Group				
Parameter Name	Parameter Description	Default Value	Update	Output Only
DB2ATTACHFACILITY	<p>DB2 ATTACH FACILITY TYPE.</p> <p>This parameter allows the user to control which mechanism to use for the DB2 interface. Possible values are:</p> <ul style="list-style-type: none"> <li>• <b>CAF:</b> (Default) Use the classic Call Attach Facility (CAF), using the DSNALI interface module.</li> <li>• <b>RRSAF:</b> Use the new option of Recoverable Resource Services Attach Facility (RRSAF), which can be used for DB2 v5.1 and above systems. The new facility allows the capability of a 2-phase commit through the attachment facility. Its interface routine is DSNRLI.</li> </ul>	CAF	No	No
DB2VERSION	<p>DB2 VERSION NUMBER.</p> <p>This parameter allows a user to specify the DB2 version to which they are connecting. This is only used if a DB2 version cannot be determined by Shadow Mainframe Adapter Server.</p>	'2.3.0'	Yes	No
DEFAULTDB2PLAN	DEFAULT DB2 PLAN NAME.	'SDBC1010'	Yes	No
DEFAULTDB2PROCTABLE	DEFAULT STORED PROCEDURE TABLE NAME.	'SHADOW. PROCEDURES'	Yes	No
DEFAULTDB2SUBSYS	DEFAULT DB2 SUBSYSTEM NAME.	'DSN1'	No	No
DYNAMICSQL	Mainframe Adapter ClientS CAN USE DYNAMIC SQL. (YES, NO)	YES	Yes	No
ENABLEMDIAPI	<p>ENABLE MDI API ENTRY POINTS. (YES, NO)</p> <p>This parameter controls if the MDI API should be enabled in the host address space. Possible values are:</p> <ul style="list-style-type: none"> <li>• <b>YES:</b> All of the MDI entry points will be available for use by application programs (including COBOL programs using DYNAM).</li> <li>• <b>NO:</b> (Default) The MDI API entry points will only be available to programs that link-edit the MDI interface routines statically.</li> </ul>	NO	No	No

PRODSQL Parameter Group				
Parameter Name	Parameter Description	Default Value	Update	Output Only
EXPANDEDSQLBLOCKS	<p>SEND LARGER SQL CONTROL BLOCKS. (YES, NO)</p> <p>This parameter is used to control whether or not larger control blocks should be sent to the host as part of each SQL operation. The additional data is needed to support new SQL related features. Possible values are:</p> <ul style="list-style-type: none"> <li><b>YES:</b> (Default) Expanded control blocks will be sent for all SQL operations (assuming the Mainframe Adapter Client is capable of handling larger SQL control blocks).</li> <li><b>NO:</b> Only standard control blocks will be used for SQL processing.</li> </ul>	YES	Yes	No
GETSECONDARYLIST	<p>EXTRACT DB2 SECONDARY USERID LIST. (YES, NO)</p> <p>This parameter controls whether or not the secondary userid list should be extracted for each DB2 thread. Possible values are:</p> <ul style="list-style-type: none"> <li><b>YES:</b> The DB2 secondary authorization ID list will be obtained just after the connection to DB2 has completed.</li> <li><b>NO:</b> (Default) No DB2 secondary userid processing will be done. The only reason to ever set this parameter to NO is when a problem is encountered extracting the DB2 secondary userid list.</li> </ul>	NO	Yes	No
GRANTGLOBAL	<p>GRANT ALL TO PUBLIC ON GLOBAL TABLES. (YES, NO)</p>	YES	Yes	No
HOSTFUNCTIONALLEVEL	<p>HOST FUNCTIONAL LEVEL.</p> <p>This parameter is only used to show what level of code the host is running. This value is passed back to the Mainframe Adapter Client so that the Mainframe Adapter Client will know what host capabilities are usable. This parameter cannot be set and is intended for NEON Systems Customer Support use only.</p> <p><b>Minimum Value: 0</b> <b>Maximum Value: 255</b></p>	2	Yes	No
IDENTIFYDSNHLI	<p>IDENTIFY DSNHLI2 AS DSNHLI. (YES, NO)</p>	YES	No	No
IGNOREDCODE01	<p>IGNORED SQLCODE NUMBER 1.</p>	0	Yes	No
IGNOREDCODE02	<p>IGNORED SQLCODE NUMBER 2.</p>	0	Yes	No

PRODSQL Parameter Group				
Parameter Name	Parameter Description	Default Value	Update	Output Only
IGNOREDCODE03	IGNORED SQLCODE NUMBER 3.	0	Yes	No
IGNOREDCODE04	IGNORED SQLCODE NUMBER 4.	0	Yes	No
IGNOREDCODE05	IGNORED SQLCODE NUMBER 5.	0	Yes	No
IGNOREDCODE06	IGNORED SQLCODE NUMBER 6.	0	Yes	No
IGNOREDCODE07	IGNORED SQLCODE NUMBER 7.	0	Yes	No
IGNOREDCODE08	IGNORED SQLCODE NUMBER 8.	0	Yes	No
IGNOREDCODE09	IGNORED SQLCODE NUMBER 9.	0	Yes	No
IGNOREDCODE10	IGNORED SQLCODE NUMBER 10.	0	Yes	No
LOOKASIDESIZE	AUTO-STATIC LOOKASIDE BUFFER SIZE. <b>Minimum Value: 0</b> <b>Maximum Value: 100000</b>	400	Yes	No
MAXDB2ACTIVETHREADS	MAXIMUM DB2 ACTIVE THREADS.	0	No	No
MAXROWS	MAXIMUM NUMBER OF ROWS TO FETCH.  This parameter controls how many rows will be fetched. If this value is zero, then there is no limit on the number of rows in a result set. If this value is non-zero, then SQLCODE +100 will be simulated as soon as the maximum number of rows is FETCHed. <b>Note:</b> The actual number of rows FETCHed will be the minimum of the value below and the number of rows in the result set. <b>Minimum Value: 0</b> <b>Maximum Value: 100000000</b>	0 ROWS	Yes	No
MAXTIMERONS	MAXIMUM TIMERON VALUE.	0.0 TIMERONS	Yes	No
MDICICSDATFORM	MDI FORMATTIME DEFAULT FORMAT.  This parameter controls the default date format to use when the MDI support for the CICS FORMATTIME API is used. This format is used if the FORMATTIME request does not explicitly specify a date format to use.	MMDDYY	Yes	No

PRODSQL Parameter Group				
Parameter Name	Parameter Description	Default Value	Update	Output Only
MDIERRORCODE	<p>USE MDI ERROR CODE AS NATIVE CODE. (YES, NO)</p> <p>This parameter controls whether or not MDI error code values should be converted to ODBC native error codes. Possible values are:</p> <ul style="list-style-type: none"> <li><b>YES:</b> The MDI error code is converted to the ODBC native error code (if possible).</li> <li><b>NO:</b> (Default) The MDI error code is traced but otherwise not used.</li> </ul>	NO	Yes	No
MDISQLSTATE	<p>ADD SQLSTATE TO MDI MESSAGE TEXT. (YES, NO)</p> <p>This parameter controls if the SQLSTATE value from an MDI RPC should be concatenated onto the end of the message text from the MDI RPC.</p> <ul style="list-style-type: none"> <li><b>YES:</b> The SQLSTATE string will be added to the end of the message text.</li> <li><b>NO:</b> (Default) The SQLSTATE string will not be included in the message text from the MDI RPC.</li> </ul>	NO	Yes	No
MDISTORAGEVALUE	<p>MDI INITIAL GETMAIN STORAGE VALUE.</p> <p>This parameter controls the initial value of all storage returned from the MDI EXEC CICS GETMAIN interface. This value is used to initialize all storage obtained using this mechanism. The default is to set acquired storage to binary zeros (low values). Any other character value can be used.</p>	X'00'	Yes	No
ODBCCATALOGLEVEL	<p>ODBC OPTIMIZED CATALOG LEVEL.</p> <p><b>Minimum Value: 0</b> <b>Maximum Value: 255</b></p>	3	Yes	No

PRODSQL Parameter Group				
Parameter Name	Parameter Description	Default Value	Update	Output Only
ODBCOVERHTTP	<p>CHECK FOR ODBC Mainframe Adapter ClientS USING HTTP. (YES, NO)</p> <p>This parameter controls if ODBC Mainframe Adapter Clients can use HTTP to communicate with the host. If this flag is set to YES, then all new Mainframe Adapter Client TCP/IP connections will be checked for HTTP headers. Otherwise, this checking will not be done and any attempt to run ODBC over HTTP will cause serious errors.</p> <p><b>Note:</b> Setting this flag to YES does add a small amount of overhead to non-HTTP session initialization overhead.</p>	NO	Yes	No
OPTROWS	<p>OPTIMAL NUMBER OF ROWS TO RETURN.</p> <p>This parameter controls how many rows will be returned each time the Mainframe Adapter Client application asks for rows from a result set. If this value is zero, then there is no limit on the number of rows returned to the Mainframe Adapter Client application (other than buffer size). If this value is non-zero, then only the specified number of rows will be returned to the Mainframe Adapter Client application each time the Mainframe Adapter Client application asks for more rows. Of course, a smaller number of rows will be returned (perhaps zero) if not enough rows are available to be returned.</p> <p><b>Minimum Value: 0</b> <b>Maximum Value: 30000</b></p>	0 ROWS	Yes	No
PREFETCH	<p>PREFETCH QUEUE BLOCK COUNT.</p> <p>This parameter parameter controls how many blocks of rows should be FETCHed from DB2. These blocks of rows are used to build the compressed row buffers that are sent to an ODBC application from the Mainframe Adapter Server. This value should only be changed if the buffers being transmitted from the Mainframe Adapter Server to an ODBC Mainframe Adapter Client application are not full.</p> <p><b>Note:</b> This parameter value should <i>not</i> be changed unless it is recommended by NEON Systems Customer Support.</p> <p><b>Minimum Value: 1</b> <b>Maximum Value: 50</b></p>	3 BLOCKS	Yes	No

PRODSQL Parameter Group				
Parameter Name	Parameter Description	Default Value	Update	Output Only
PREFETCHROWS	<p>PREFETCH ROWS FOR BLOCK FETCH. (YES, NO)</p> <p>This parameter controls if additional rows should be FETCHed from DB2 while a Mainframe Adapter Client ODBC application is processing rows FETCHed earlier. Possible values are:</p> <ul style="list-style-type: none"> <li><b>YES:</b> Additional rows will be FETCHed from DB2 while the ODBC Mainframe Adapter Client is handling previous rows.</li> <li><b>NO:</b> (Default) The FETCH processing will not be overlapped.</li> </ul> <p><b>Note:</b> This parameter value should <i>not</i> be set to YES unless it is recommended by NEON Systems Customer Support.</p>	NO	Yes	No
PRESENBLOCKS	<p>PRESEND BLOCKS TO THE Mainframe Adapter Client. (YES, NO)</p> <p>This parameter controls if blocks of rows should be sent from the Mainframe Adapter Server to the ODBC Mainframe Adapter Client application before the ODBC Mainframe Adapter Client application requests the rows.</p> <ul style="list-style-type: none"> <li><b>YES:</b> Blocks of rows will be pre-sent.</li> <li><b>NO:</b> (Default) Blocks of rows will not be pre-sent.</li> </ul> <p><b>Note:</b> This parameter is not supported at this time. This parameter value should <i>not</i> be set to YES unless it is recommended by NEON Systems Customer Support.</p>	NO	Yes	No
ROLLBACKPOSITIVERC	<p>ROLLBACK AFTER POSITIVE SQL CODES. (YES, NO)</p> <p>This parameter controls whether or not a ROLLBACK operation will be performed after an operation with a positive SQLCODE.</p>	NO	Yes	No



PRODSQL Parameter Group				
Parameter Name	Parameter Description	Default Value	Update	Output Only
SPECIALTABLEPREFIX	<p>SPECIAL TABLE PREFIX.</p> <p>This parameter is used to specify the SQL table prefix used to identify special tables. The prefix is actually the authorization ID that designates the owner of the table. If a SQL statement that refers to a table with an authorization ID equal to this value is detected, special processing is done. The special processing includes executing a stored procedure that populates the special table with data for use by the original SQL statement.</p>	'NEON'	Yes	No
SQLMAXCOLUMNS	<p>MAXIMUM NUMBER OF SQL COLUMNS.</p> <p>This parameter is used to set the maximum number of columns that can be returned from an SQL operation.</p> <p><b>Note:</b> The Mainframe Adapter Client must also be able to handle the number of SQL columns specified using this value.</p>	1000	No	No
SQLMAXLOBSIZE	<p>MAXIMUM LARGE OBJECT SIZE.</p> <p>This parameter is used to set the maximum size of a Large Object (LOB) that can be returned in a result set from a NEON RPC. It is specified in megabytes.</p>	64	Yes	No
STATICSQL	<p>Mainframe Adapter Clients CAN USE STATIC SQL. (YES, NO)</p>	YES	Yes	No
TRACENEWPLANS	<p>TRACE NEW PLAN DBRM SELECTIONS. (YES, NO)</p> <p>When this parameter is set to YES, an entry will be made in trace browse for each call to DB2 to show the new DBRM selected with its statement and cursor numbers.</p>	NO		

PRODSQL Parameter Group				
Parameter Name	Parameter Description	Default Value	Update	Output Only
UPCASEMESSAGES	<p>UPCASE MESSAGES SENT TO A Mainframe Adapter Client. (YES, NO)</p> <p>This parameter is used to control whether or not all messages should be converted to upper case before they are sent back to a Mainframe Adapter Client application. This step is required to support the Japanese language because Japanese EBCDIC has no lowercase letters. Possible values are:</p> <ul style="list-style-type: none"><li>• <b>YES:</b> All messages are converted to uppercase.</li><li>• <b>NO:</b> (Default) The messages are not converted to uppercase.</li></ul>	NO	Yes	No

**PRODSTOR**

<b>PRODSTOR Parameter Group</b>				
<b>Parameter Name</b>	<b>Parameter Description</b>	<b>Default Value</b>	<b>Update</b>	<b>Output Only</b>
CSA	CSA STORAGE UTILIZATION.	<b>0K</b>	N/A	Yes
CSALIMIT	CSA STORAGE UTILIZATION LIMIT. <b>Minimum Value: 1024</b> <b>Maximum Value: 2097152</b>	<b>15K</b>	Yes	No
DATASIZE	SYSTEM DATA AREA DEFAULT BLOCK SIZE.  This parameter specifies the amount of storage that will be acquired for a new system data area block unless a larger block is needed. A larger block will be needed if the current object will not fit into an empty system data area block. This parameter should only be set under the specific guidance of the NEON Systems Customer Support group. <b>Minimum Value: 512</b> <b>Maximum Value: 65536</b>	<b>1K</b>	Yes	No
DATASPACEEXTENT	DATA SPACE EXTENT SIZE.  This parameter is used to specify the increment size when a dataspace is extended. Size is rounded up to the next 4K boundary. <b>Minimum Value: 16384</b> <b>Maximum Value: 2147483647</b>	<b>1024K</b>	Yes	No
DATASPACEINIT	DATA SPACE INITIAL SIZE.  This parameter is used the specify the initial size of a dataspace when it is created. Note that this number can be different from the threshold number, and logically should be larger. Size is rounded up to the next 4K boundary. <b>Minimum Value: 16384</b> <b>Maximum Value: 2147483647</b>	<b>1024K</b>	Yes	No
DATASPACEMAXIMUM	DATA SPACE MAXIMUM SIZE.  This parameter is used to specify the maximum size a dataspace can be extended to. Size is rounded up to the next 4K boundary. <b>Minimum Value: 1048576</b> <b>Maximum Value: 2147483647</b>	<b>4096K</b>	Yes	No
DATASPACEHRESH	DATA SPACE THRESHHOLD SIZE.  This parameter is used to specify when data should be stored in a dataspace. Size is rounded up to the next 4K boundary. <b>Minimum Value: 16384</b> <b>Maximum Value: 2147483647</b>	<b>1024K</b>	Yes	No

PRODSTOR Parameter Group				
Parameter Name	Parameter Description	Default Value	Update	Output Only
ECSA	ECSA STORAGE UTILIZATION.	244K	N/A	Yes
ECSALIMIT	ECSA STORAGE UTILIZATION LIMIT. <b>Minimum Value: 262144</b> <b>Maximum Value: 16777216</b>	4096K	Yes	No
EMINPRIV	EPRIVATE MINIMUM STORAGE REQUIRED.  This parameter is used to control the minimum amount of above the 16 MB line storage that must be available for new inbound sessions to be handled. If this much storage is not available, new inbound sessions will be rejected. If this parameter is set to zero, then the amount of above the 16 MB line storage will not be checked for each new connection.  <b>Minimum Value: 0</b> <b>Maximum Value: 8388608</b>	4096K	Yes	No
EPRIV	EPRIVATE STORAGE UTILIZATION.	145327K	N/A	Yes
ERRORSTACKSIZE	ERROR STACK SIZE.  This parameter is the amount of storage acquired for each process for error processing. This value should be raised if stack underflow errors occur. This parameter should only be set under the specific guidance of the NEON Systems Customer Support group.	16K	Yes	No
IGNORESTGUNDERFLOW	IGNORE STG ACCTNG UNDERFLOW ERRORS. (YES, NO)  This parameter can be set to YES to suppress generation of MSG3203 and subsequent failing of storage get/free requests. When set to YES, errors are ignored. Storage underflow errors are often, but not always, encountered when long-running SQL operations are cancelled and subsequent end-of-task cleanup processing is bypassed. In such circumstances, the Mainframe Adapter Server's storage accounting counters may not be updated properly. This option should only be used on advice from NEON Systems technical support.	NO	Yes	No

PRODSTOR Parameter Group				
Parameter Name	Parameter Description	Default Value	Update	Output Only
LSQATHRESHOLD	<p>THRESHOLD STORAGE VALUE FOR LSQA.</p> <p>This parameter is used to control the number of active users within Shadow. If set, the value coded is compared at logon time to the amount of storage available to be allocated to LSQA. When the amount available falls below the coded value, the logon is rejected with an out of storage message.</p> <p><b>Note:</b> This is LSQA, not ELSQA. This is below the line storage.</p> <p><b>Minimum Value: 0</b> <b>Maximum Value: 1048576</b></p>	0K	Yes	No
MINPRIV	<p>PRIVATE MINIMUM STORAGE REQUIRED.</p> <p>This parameter is used to control the minimum amount of below the 16 MB line storage that must be available for new inbound sessions to be handled. If this much storage is not available, new inbound sessions will be rejected. If this parameter is set to zero, then the amount of below the 16 MB line storage will not be checked for each new connection.</p> <p><b>Minimum Value: 0</b> <b>Maximum Value: 2097152</b></p>	300K	Yes	No
PRIMARYSTACKHW	<p>PRIMARY STACK HI-WATER.</p> <p>This parameter is the maximum usage of the stack for all threads.</p>	0K	N/A	Yes
PRIMARYSTACKMAX	<p>PRIMARY STACK MAXIMUM.</p> <p>This parameter sets an upper limit on the primary stack size. This parameter should only be set under the specific guidance of the NEON Systems Customer Support group.</p>	416K	Yes	No
PRIMARYSTACKSIZE	<p>PRIMARY STACK SIZE.</p> <p>This parameter is the amount of storage acquired for each process for normal processing. This value should be raised if stack underflow errors occur. This parameter should only be set under the specific guidance of the NEON Systems Customer Support group.</p>	352K	Yes	No
PRIV	PRIVATE STORAGE UTILIZATION.	1054K	N/A	Yes

PRODSTOR Parameter Group				
Parameter Name	Parameter Description	Default Value	Update	Output Only
PRIVTHRESHOLD	<p>THRESHOLD STORAGE VALUE FOR PRIVATE.</p> <p>This parameter is used to control the number of active users within Shadow. If set, the value coded is compared at logon time to the amount of storage available to be allocated to private. When the amount available falls below the coded value, the logon is rejected with an out of storage message.</p> <p><b>Note:</b> This is private storage, not extended private. This is below the line storage.</p> <p><b>Minimum Value: 0</b> <b>Maximum Value: 1048576</b></p>	0K	Yes	No
RESERVEEHIGH	<p>RESERVED EXTENDED HIGH AREA SIZE.</p> <p>This parameter is used to determine how much extended high private should be reserved during product initialization. This storage is obtained during product startup and is released at the start of product shutdown. The storage is released to assure that the termination routines will always have enough storage to properly execute.</p> <p><b>Minimum Value: 0</b> <b>Maximum Value: 4194304</b></p>	0K	No	No
RESERVEELOW	<p>RESERVED EXTENDED LOW AREA SIZE.</p> <p>This parameter is used to determine how much extended low private should be reserved during product initialization. This storage is obtained during product startup and is released at the start of product shutdown. The storage is released to assure that the termination routines will always have enough storage to properly execute.</p> <p><b>Minimum Value: 0</b> <b>Maximum Value: 4194304</b></p>	0K	No	No
RESERVEELSQA	<p>RESERVED ELSQA AREA SIZE.</p> <p>This parameter is used to determine how much ELSQA should be reserved during product initialization. This storage is obtained during product startup and is released at the start of product shutdown. The storage is released to assure that the termination routines will always have enough storage to properly execute.</p> <p><b>Minimum Value: 0</b> <b>Maximum Value: 4194304</b></p>	0K	No	No

PRODSTOR Parameter Group				
Parameter Name	Parameter Description	Default Value	Update	Output Only
RESERVEHIGH	RESERVED HIGH PRIVATE AREA SIZE. This parameter is used to determine how much high private should be reserved during product initialization. This storage is obtained during product startup and is released at the start of product shutdown. The storage is released to assure that the termination routines will always have enough storage to properly execute. <b>Minimum Value: 0</b> <b>Maximum Value: 1048576</b>	0K	No	No
RESERVELOW	RESERVED LOW PRIVATE AREA SIZE. This parameter is used to determine how much low private should be reserved during product initialization. This storage is obtained during product startup and is released at the start of product shutdown. The storage is released to assure that the termination routines will always have enough storage to properly execute. <b>Minimum Value: 0</b> <b>Maximum Value: 1048576</b>	0K	No	No
RESERVELSQA	RESERVED LSQA AREA SIZE. This parameter is used to determine how much LSQA should be reserved during product initialization. This storage is obtained during product startup and is released at the start of product shutdown. The storage is released to assure that the termination routines will always have enough storage to properly execute. <b>Minimum Value: 0</b> <b>Maximum Value: 1048576</b>	0K	No	No
SHARESUBPOOLZERO	SHARE SUBPOOL ZERO STORAGE. (YES, NO) This parameter indicates whether subpool zero is to be shared between tasks. When subpool zero is shared, applications must explicitly free any storage allocated in subpool zero since shared subpool storage is not released at end of task. If the Mainframe Adapter Server is accessing VSAM files between multiple tasks under the same ddname, this value should be set to YES; otherwise, this value should be set to NO. If this value is set to YES, the Mainframe Adapter Server should be recycled on a daily basis to free orphaned subpool zero storage.	NO	Yes	No

PRODSTOR Parameter Group				
Parameter Name	Parameter Description	Default Value	Update	Output Only
STACKINCREMENT-AMOUNT	PRIMARY STACK INCREMENT AMOUNT. This parameter is used to increase the default primary stack size in response to short on stack storage condition(s). This parameter should only be set under the specific guidance of the NEON Systems Customer Support group.	16K	Yes	No



**PRODTOKEN**

<b>PRODTOKEN Parameter Group</b>				
<b>Parameter Name</b>	<b>Parameter Description</b>	<b>Default Value</b>	<b>Update</b>	<b>Output Only</b>
CHECKTOKENSINTERVAL	TOKEN TIMEOUT CHECKING INTERVAL. This parameter controls how often each token is checked to see if the token has timed out. If the token has timed out, the token and the associated data (if any) are released. The interval value is specified in seconds and should be a factor of one hour. In other words, the value should divide evenly into 3600. <b>Minimum Value: 1</b> <b>Maximum Value: 3600</b>	<b>15 SECONDS</b>	Yes	No
CURRENTTOKENADDRESS	LAST ALLOCATED TOKEN ENTRY ADDRESS. This read-only parameter contains the address of the last token entry allocated by the system.	<b>X'00000000'</b>	N/A	Yes
CURRENTTOKENBLOCK	LAST ALLOCATED TOKEN BLOCK ADDRESS. This read-only parameter contains the address of the last token control block allocated for storage of new token entries.	<b>X'00000000'</b>	N/A	Yes
ENABLETOKENEXC	ENABLE TOKEN EXPIRATION EXC RULE. (YES, NO) This parameter enables token expiration processing to fire an SEF EXC rule.	<b>NO</b>	Yes	No
TOKENBLOCKCOUNT	NUMBER OF TOKEN BLOCKS.	<b>0 BLOCKS</b>	No	No
TOKENBLOCKPTR	FIRST TOKEN BLOCK ADDRESS	<b>X'00000000'</b>	No	No
TOKENENTRYCOUNT	NUMBER OF TOKEN ENTRIES.	<b>0 TOKENS</b>	No	No
TOKENSALLOCATED	NUMBER OF TOKENS ALLOCATED.	<b>0 TOKENS</b>	No	No
TOKENSDELETED	NUMBER OF TOKENS DELETED.	<b>0 TOKENS</b>	No	No
TOKENSINUSE	NUMBER OF TOKENS IN USE.	<b>0 TOKENS</b>	No	No
TOKENSTIMEDOUT	NUMBER OF TOKENS TIMED OUT.	<b>0 TOKENS</b>	No	No
TOKENSTORAGE	TOKEN VALUE STORAGE UTILIZATION. This read-only parameter shows the amount of storage currently allocated for storage of token data values. It does not include the storage allocated for the system-managed token blocks and token entries; only the size of the data values assigned to tokens is included in this total.	<b>0K</b>	N/A	Yes

<b>PRODTOKEN Parameter Group</b>				
<b>Parameter Name</b>	<b>Parameter Description</b>	<b>Default Value</b>	<b>Update</b>	<b>Output Only</b>
TOKENTIMEOUT	DEFAULT TOKEN TIMEOUT VALUE. <b>Minimum Value: 1</b> <b>Maximum Value: 200000000</b>	<b>3600</b> <b>SECONDS</b>	Yes	No

## PRODTRACE

PRODTRACE Parameter Group				
Parameter Name	Parameter Description	Default Value	Update	Output Only
ACITRACEIN	TRACE ACI INPUT BUFFER. (YES, NO)  This parameter determines whether or not to trace the ACI input buffers at execution time into trace browse.	NO	Yes	No
ACITRACEOUT	TRACE ACI OUTPUT BUFFER. (YES, NO)  This parameter determines whether or not to trace the ACI output buffers at execution time into trace browse.	NO	Yes	No
ADABASECHOMainframe Adapter Client	TRACE ADABAS ECHO Mainframe Adapter Client TRACE REQUESTS. (YES, NO)  This parameter causes the Mainframe Adapter Client trace information to be echoed to trace browse.	YES	Yes	No
ADABATRACEALLCMDS	TRACE ADABAS ALL ADABAS COMMANDS. (YES, NO)  This parameter causes all ADABAS commands to be logged in trace browse.	NO	Yes	No
DEBUGSEFWAIT	DEBUG SEF INITIALIZATION WAIT. (YES, NO)  This parameter can be set on to debug SEF initialization wait processing. This parameter should only be set under the specific guidance of the NEON Systems Customer Support group.	NO	Yes	No
DEBUGSGMG	DEBUG FLAG FOR SGMG ROUTINE. (ON, OFF)	OFF	Yes	No
EPROTRACE	TRACE SEF EPROCS PROCESSING. (YES, NO)  This parameter controls tracing for SEF event/rule processing. Possible values are: <ul style="list-style-type: none"> <li><b>YES:</b> (Default) This parameter causes after-execution tracing to be performed for SEF event/rule processing.</li> <li><b>NO:</b> Only the before-execution trace record is logged.</li> </ul> <b>Note:</b> The default value of YES is recommended for Shadow and very strongly recommended for Shadow Web Server.	YES	Yes	No

PRODTRACE Parameter Group				
Parameter Name	Parameter Description	Default Value	Update	Output Only
PRECISECPU	<p>OBTAIN PRECISE CPU TIME INFORMATION. (YES, NO)</p> <p>This parameter controls how CPU time information is obtained. If this parameter is set to YES, highly accurate CPU time information is obtained at a greater CPU cost. Otherwise, a less accurate (but faster) mechanism is used to obtain CPU time. The CPU time information is used to build SMF records.</p>	NO	Yes	No
SMFFULLSQL	<p>TRACE FULL SQL SOURCE IN SMF. (YES, NO)</p> <p>This parameter controls how much SQL source is included in SMF records. Possible values are:</p> <ul style="list-style-type: none"> <li>• <b>YES:</b> The full SQL source will always be included in each SMF record.</li> <li>• <b>NO:</b> (Default) Only the first 256 bytes of the SQL source will be included in each SMF record.</li> </ul> <p><b>Note:</b> In practice, only about 32,000 bytes of SQL source can be included in an SMF record.</p>	NO	Yes	No
SMFNUMBER	<p>SMF RECORD NUMBER.</p> <p>(Used with Shadow only) This parameter controls SMF recording. To enable SMF recording, set SMFNUMBER to desired number. If set to zero, no logging takes place.</p> <p><b>Minimum Value: 0</b> <b>Maximum Value: 255</b></p>	0	Yes	No
SMFTRACEASTEXT	<p>TRACE SMF RECORDS AS TEXT. (YES, NO)</p> <p>This parameter controls the tracing of SMF records. Possible values are:</p> <ul style="list-style-type: none"> <li>• <b>YES:</b> Each SMF record is copied into trace browse just before it is written out to SMF.</li> <li>• <b>NO:</b> (Default) SMF records are not copied into Trace Browse as text records.</li> </ul> <p><b>Note:</b> SMF records are only copied into trace browse for debugging purposes, so this flag should only be set to YES to debug SMF record problems.</p>	NO	Yes	No

<b>PRODTRACE Parameter Group</b>				
<b>Parameter Name</b>	<b>Parameter Description</b>	<b>Default Value</b>	<b>Update</b>	<b>Output Only</b>
SMFTRANSACT	<p>SMF PER-TRANSACTION RECORDING. (YES, NO).</p> <p>This parameter controls the creation of SMF transaction records. Possible values are:</p> <ul style="list-style-type: none"> <li><b>YES:</b> An SMF record will be created for each inbound Mainframe Adapter Client request.</li> <li><b>NO:</b> (Default) No per-transaction records will be created.</li> </ul> <p>Each SMF transaction record contains information about all of the work done on behalf of the Mainframe Adapter Client. The inbound Mainframe Adapter Client request may have caused zero, one, or more SQL operations to be executed.</p>	<b>NO</b>	Yes	No
THREADLEVELTRACE	<p>ISOLATE MODULE TRACE TO THREAD LEVEL. (YES, NO)</p> <p>This parameter controls the tracing activities of the TRACEENTRY, TRACEEXIT, and TRACEDATA routines. Possible values are:</p> <ul style="list-style-type: none"> <li><b>YES:</b> The routines isolate tracing to one or more enabled subtask threads.</li> <li><b>NO:</b> (Default) The routines generate tracing for all exits within the entire product.</li> </ul>	<b>NO</b>	Yes	No
TRACE	<p>PRODUCT TRACE OPTION.</p> <p>This parameter sets the overall level of communication (LU 6.2 and/or TCP/IP) tracing for the product. Trace messages generated using this parameter are sent to the OS/390 or z/OS log, not to trace browse. Use of this parameter is not recommended. This parameter should only be set under the specific guidance of the NEON Systems Customer Support group.</p>	<b>TERMINATION</b>	Yes	No

PRODTRACE Parameter Group				
Parameter Name	Parameter Description	Default Value	Update	Output Only
TRACE24GETS	<p>ONLY TRACE 24-BIT GETMAIN STR EVENTS. (YES, NO)</p> <p>This parameter controls whether or not only 24-bit GETMAIN STR events are traced. Possible values are:</p> <ul style="list-style-type: none"> <li><b>YES:</b> (Default) Only 24-bit GETMAIN STR events will be traced using trace browse. Note that the event type will be STR.</li> <li><b>NO:</b> All STR events from the system trace will be traced including 24-bit GETMAINs.</li> </ul>	YES	Yes	No
TRACEABENDEVENTS	<p>TRACE ABEND EVENTS. (YES, NO)</p> <p>This parameter determines whether abend events in the Shadow Mainframe Adapter Server address space or in an RPC are traced. When set to YES, abends that occur either in the Shadow Mainframe Adapter Server address space or in an RPC are traced.</p>	YES	Yes	No
TRACEABENDRETRYINFO	<p>TRACE ABEND RETRY INFORMATION. (YES, NO)</p> <p>This parameter controls whether or not the retry registers and other information is traced whenever an enabled retry stack frame can be located during ESTAE recovery processing. The retry information, if any, is traced along with the original abend SDWA image, when possible, even if retry is not possible and the abend is percolated.</p>	YES	Yes	No
TRACEABENDSDWARC1	<p>TRACE ABEND SDWARC1 IMAGE. (YES, NO)</p> <p>This parameter controls whether the SDWARC1 control block image is traced for ABEND events. TRACEABENDEVENTS must also be on. The SDWARC1 control block contains access and control register values at the point of an abnormal termination.</p>	YES	Yes	No

PRODTRACE Parameter Group				
Parameter Name	Parameter Description	Default Value	Update	Output Only
TRACEAPPCDATA	TRACE FULL APPC/MVS DATA. (YES, NO)  This parameter controls whether the full APPC/MVS data for APPC/MVS events is traced or not. Possible values are: <ul style="list-style-type: none"> <li><b>YES:</b> The complete APPC/MVS data for APPC/MVS events will be traced using trace browse.</li> <li><b>NO:</b> (Default) The full APPC/MVS data will not be traced.</li> </ul>	NO	Yes	No
TRACEAPPCMVSEVENTS	TRACE APPC/MVS EVENTS. (YES, NO)	YES	Yes	No
TRACEAPPCMVSMN	TRACE APPC/MVS MONITOR. (YES, NO)  This parameter controls whether the APPC/MVS Monitor data collection APIs are to be traced. This parameter should only be turned on if the monitor is not functioning correctly.	NO	Yes	No
TRACEAPPCMVSSR	TRACE APPC/MVS SEND/RECV. (YES, NO)	YES	Yes	No
TRACEATTACHEVENTS	TRACE ATTACH EVENTS. (YES, NO)	YES	Yes	No
TRACEAUTHEVENTS	TRACE AUTHORIZATION EVENTS. (YES, NO)	NO	Yes	No
TRACEBROWSEGROUP1	TRACE BROWSE FLAG GROUP 1.	X'226EB07E'	Yes	No
TRACEBROWSEGROUP2	TRACE BROWSE FLAG GROUP 2.	X'580FB332'	Yes	No
TRACEBROWSEGROUP3	TRACE BROWSE FLAG GROUP 3.	X'E8004F00'	Yes	No
TRACEBROWSEGROUP4	TRACE BROWSE FLAG GROUP 4.	X'00000000'	Yes	No
TRACEEVENTS	TRACE MAINFRAME ADAPTER CLIENT PROGRAM EVENTS. (YES, NO)  This parameter causes events associated with C-programs running in Shadow Mainframe Adapter Server's address space to be traced.	YES	Yes	No
TRACECICSEVENTS	TRACE CICS EVENTS. (YES, NO)	YES	Yes	No

PRODTRACE Parameter Group				
Parameter Name	Parameter Description	Default Value	Update	Output Only
TRACMainframe Adapter ClientHTTPAPI	<p>TRACE Mainframe Adapter Client HTTP API EVENTS. (YES, NO)</p> <p>This parameter specifies tracing of HTTP Mainframe Adapter Client API calls made when sending a Mainframe Adapter Client HTTP request. Note that tracing Mainframe Adapter Client API calls will also trace some of the headers and data sent for the request, so separately tracing HTTP Mainframe Adapter Client headers and HTTP Mainframe Adapter Client data may be redundant. There are more API calls, so tracing may be needed to diagnose some problems. Tracing HTTP Mainframe Adapter Client headers and HTTP Mainframe Adapter Client data will trace <i>all</i> the headers and data, while the API trace will trace only the headers or data sent or retrieved by the application.</p>	NO	Yes	No
TRACMainframe Adapter ClientHTTPSTATS	<p>TRACE Mainframe Adapter Client HTTP STATISTICS. (YES, NO)</p> <p>This parameter specifies tracing of HTTP Mainframe Adapter Client statistics after processing a Mainframe Adapter Client HTTP request.</p>	NO	Yes	No
TRACMainframe Adapter ClientRECVDATA	<p>TRACE Mainframe Adapter Client HTTP DATA RECEIVED. (YES, NO)</p> <p>This parameter specifies tracing of HTTP Mainframe Adapter Client data received after sending a Mainframe Adapter Client HTTP request.</p>	NO	Yes	No
TRACMainframe Adapter ClientRECVHDR	<p>TRACE Mainframe Adapter Client HTTP HEADERS RECEIVED/ (YES, NO)</p> <p>This parameter specifies tracing of HTTP Mainframe Adapter Client headers received after sending a Mainframe Adapter Client HTTP request.</p>	NO	Yes	No
TRACMainframe Adapter ClientSENDDATA	<p>TRACE Mainframe Adapter Client HTTP DATA SENT. (YES, NO)</p> <p>This parameter specifies tracing of HTTP Mainframe Adapter Client data sent when sending a Mainframe Adapter Client HTTP request.</p>	NO	Yes	No



PRODTRACE Parameter Group				
Parameter Name	Parameter Description	Default Value	Update	Output Only
TRACEMainframe Adapter ClientSENDHDR	TRACE Mainframe Adapter Client HTTP HEADERS SENT. (YES, NO)  This parameter specifies tracing of HTTP Mainframe Adapter Client headers sent when sending a Mainframe Adapter Client HTTP request.	NO	Yes	No
TRACECURSOR	TRACE CURSOR STATUS. (YES, NO)	NO	Yes	No
TRACECURSORADDRESS	TRACE CURSOR ADDRESS. (YES, NO)	NO	Yes	No
TRACEDATA	TRACE MODULE DATA.  This parameter is for debugging purposes only and should be used only under the guidance of NEON Systems Customer Support.	X'07FE'	Yes	No
TRACEDETACHEVENTS	TRACE DETACH EVENTS. (YES, NO)	YES	Yes	No
TRACEDISABLEEVENTS	TRACE DISABLE EVENTS. (YES, NO)	YES	Yes	No
TRACEENABLEEVENTS	TRACE ENABLE EVENTS. (YES, NO)	YES	Yes	No
TRACEEXCEPTIONEVENTS	TRACE EXCEPTION EVENTS. (YES, NO)	YES	Yes	No
TRACEEXCIDPLEVENTS	TRACE EXCI DPL EVENTS. (YES, NO)	YES	Yes	No
TRACEEXCIEVENTS	TRACE EXCI EVENTS. (YES, NO)	YES	Yes	No
TRACEFILEEVENTS	TRACE FILE EVENTS. (YES, NO)  This parameter controls if file-related processing events are logged to the wrap-around trace.	YES	Yes	No
TRACEFULLDPLDATA	TRACE FULL DPL DATA. (YES, NO)  This parameter controls whether the entire COMMAREA for DPL events is traced. Possible values are: <ul style="list-style-type: none"> <li><b>YES:</b> The complete COMMAREA for DPL events will be traced using trace browse.</li> <li><b>NO:</b> (Default) The full COMMAREA will not be traced.</li> </ul>	NO	Yes	No

PRODTRACE Parameter Group				
Parameter Name	Parameter Description	Default Value	Update	Output Only
TRACEFULLREADDATA	TRACE ALL SEGMENTS OF READ. (YES, NO)  This parameter controls whether all segments of an OE Sockets read are traced. As each segment of an OE Socket is read, the information regarding that segment and the first xxx bytes of data is optionally traced. Normally, this does not present a problem. But if large LOBs are being transmitted to Shadow, a large number of secondary READ EXECUTED trace records are generated which can clutter up the tracebrowse. If this parameter is set to NO (the default), only the first segment is traced.	NO	Yes	No
TRACEFULLRRSDATA	TRACE FULL RRS DATA. (YES, NO)  This parameter controls whether or not the entire RRS work area will be traced for RRS events using trace browse. Possible values are: <ul style="list-style-type: none"> <li>• <b>YES:</b> The complete RRSAREA for RRS events will be traced using trace browse.</li> <li>• <b>NO:</b> (Default) Only the amount of data that will fit in a standard message block will be traced.</li> </ul>	NO	Yes	No
TRACEGLVEVENTS	TRACE GLOBAL VARIABLE EVENTS. (YES, NO)	YES	Yes	No
TRACEHLLNQDEQ	TRACE PRODUCT HLL ENQ/DEQ ACTIVITY. (YES, NO)  This parameter controls tracing of any ENQ or DEQ operations generated by HLL PRODUCT components via the internal-use-only API. When the parameter is set to YES, such operations are traced.	NO	Yes	No
TRACEHSMEVENTS	TRACE DFHSM EVENTS AS FILE EVENTS. (YES, NO)  This parameter controls whether DFHSM request processing operations are traced as FILE events. The TRACEFILEEVENT parameter must also be set to YES for this parameter to have any effect.	NO	Yes	No
TRACEIBMMQEVENTS	TRACE IBM/MQ EVENTS. (YES, NO)	YES	Yes	No
TRACEIBMMQGP	TRACE IBM/MQ MGET/MPUT EVENTS. (YES, NO)	NO	Yes	No

PRODTRACE Parameter Group				
Parameter Name	Parameter Description	Default Value	Update	Output Only
TRACEIMSDLIEVENTS	TRACE IMS DLI EVENTS.	NO	Yes	No
TRACEIMSEVENTS	TRACE IMS EVENTS. (YES, NO)  This parameter causes all events related to retrieving IMS data to be traced.	YES	Yes	No
TRACEINTERVAL	TRACE INTERVAL PROCESSING. (YES, NO)  This parameter controls the tracing of interval processing. Possible values are: <ul style="list-style-type: none"> <li>• <b>YES:</b> A text message is written into trace browse just before each type of interval processing is performed. This parameter should be set to YES only to debug problems with interval processing.</li> <li>• <b>NO:</b> (Default) A text message is not added to trace browse as part of interval processing.</li> </ul> <b>Note:</b> Interval processing is performed in either case.	NO	Yes	No
TRACEITCIPAPI	API TRACING FOR ITC/IP EVENTS. (YES, NO).	NO	Yes	No
TRACEITCIPDATA	TRACE FULL INTERLINK TCP/IP DATA. (YES, NO)  This parameter controls whether the full Interlink TCP/IP data for Interlink read/write events is traced or not. Possible values are: <ul style="list-style-type: none"> <li>• <b>YES:</b> The complete Interlink TCP/IP data for Interlink read/write events will be traced using trace browse.</li> <li>• <b>NO:</b> (Default) The full Interlink TCP/IP data will not be traced.</li> </ul> <b>Note:</b> This parameter only controls tracing for Interlink TCP/IP.	NO	Yes	No
TRACEITCIPEVENTS	TRACE ITC/IP EVENTS. (YES, NO)	YES	Yes	No
TRACEITCIPGTF	GTF TRACING FOR ITC/IP EVENTS. (YES, NO)	NO	Yes	No
TRACEITCIPRW	TRACE ITC/IP READ/WRITE EVENTS. (YES, NO)	NO	Yes	No

PRODTRACE Parameter Group				
Parameter Name	Parameter Description	Default Value	Update	Output Only
TRACELU62DATA	TRACE FULL LU 6.2 DATA. (YES, NO)  This parameter controls whether the full LU 6.2 data for LU 6.2 read/write events is traced or not. Possible values are: <ul style="list-style-type: none"> <li><b>YES:</b> The complete LU 6.2 data for LU 6.2 read/write events will be traced using trace browse.</li> <li><b>NO:</b> (Default) The full LU 6.2 data will not be traced.</li> </ul>	NO	Yes	No
TRACELU62DETAIL	TRACE DETAILED LU 6.2 EVENTS. (YES, NO)	NO	Yes	No
TRACELU62EVENTS	TRACE LU 6.2 EVENTS. (YES, NO)	NO	Yes	No
TRACELU62RDWR	TRACE LU 6.2 READ/WRITE EVENTS. (YES, NO).	NO	Yes	No
TRACEMERGE	MERGE SUCCESSFUL FETCH EVENTS. (YES, NO)  This parameter controls the merging of successful external fetches. Setting this parameter to YES will merge successful external fetches which belong to the same cursor and thread.	YES	Yes	No
TRACEMERGETHROW	MERGE SUCCESSFUL THROW EVENTS. (YES, NO)	YES	Yes	No
TRACENOEVENTS	TRACE NO EVENT TYPE EVENTS. (YES, NO).  This parameter enables the trace browse to trace events that are of an unknown event type.	NO	Yes	No
TRACENTRY	TRACE MODULE ENTRY.  This parameter is for debugging purposes only and should be used only under the guidance of NEON Systems Customer Support.	X'07FE'	Yes	No
TRACEOEDATA	TRACE FULL OE SOCKETS DATA. (YES, NO)  This parameter controls whether the full OE Sockets data for OE Sockets read/write events is traced or not. Possible values are: <ul style="list-style-type: none"> <li><b>YES:</b> The complete OE Sockets data for OE Sockets read/write events will be traced using trace browse.</li> <li><b>NO:</b> (Default) The full OE Sockets data will not be traced.</li> </ul>	NO	Yes	No

PRODTRACE Parameter Group				
Parameter Name	Parameter Description	Default Value	Update	Output Only
TRACEOEEVENTS	TRACE IBM OE SOCKETS EVENTS. (YES, NO)  This parameter controls whether or not IBM OE Sockets TCP/IP events should be traced. Possible values are: <ul style="list-style-type: none"> <li><b>YES:</b> (Default) IBM OE Sockets TCP/IP events will be traced.</li> <li><b>NO:</b> IBM OE Sockets TCP/IP events will not be traced.</li> </ul>	YES	Yes	No
TRACEOERW	TRACE OE SOCKETS READ/WRITE EVENTS. (YES, NO)  This parameter controls whether or not IBM OE Sockets TCP/IP read/write events should be traced. Possible values are: <ul style="list-style-type: none"> <li><b>YES:</b> (Default) IBM OE Sockets TCP/IP read/write events will be traced.</li> <li><b>NO:</b> IBM OE Sockets TCP/IP read/write events will not be traced.</li> </ul>	YES	Yes	No
TRACEOERWSTART	TRACE OE SOCKETS R/W EVENT START. (YES, NO)  This parameter controls if the start of IBM OE Sockets TCP/IP read/write events should be traced or not. Possible values are: <ul style="list-style-type: none"> <li><b>YES:</b> The initialization of IBM OE TCP/IP read/write events will be traced.</li> <li><b>NO:</b> (Default) The initialization will not be traced.</li> </ul>	NO	Yes	No
TRACEOTMABUFFER-DATA	TRACE OTMA BUFFER CONTENT DATA. (YES, NO)	NO	Yes	No
TRACEOTMADETAIL	TRACE OTMA DETAILED EVENTS. (YES, NO)	NO	Yes	No
TRACEOTMAEVENTS	TRACE OTMA EVENTS. (YES, NO)  This parameter is used to control the tracing of IMS/OTMA events.	NO	Yes	No
TRACEPUBLISH	TRACE EVENT PUBLISHER. (YES, NO)  This parameter is used to control tracing of Shadow Event Publisher Mainframe Adapter Servers. Specifying YES causes all calls to be traced.	NO	Yes	No

PRODTRACE Parameter Group				
Parameter Name	Parameter Description	Default Value	Update	Output Only
TRACEPUBLISHFLOW	TRACE EVENT PUBLISHER FLOW. (YES, NO)  This parameter is used to control tracing of the Shadow Event Publisher module flow. Specifying YES causes the module flow to be traced.	NO	Yes	No
TRACEPUBLISHSQL	TRACE EVENT PUBLISHER SQL. (YES, NO)  This parameter is used to control tracing of Shadow Event Publisher SQL calls. Specifying YES causes SQL calls to be traced.	NO	Yes	No
TRACEQSDetail	TRACE QS DETAIL EVENTS. (YES, NO)  This parameter is specific to the Shadow Query Mainframe Adapter Server. Care should be used when setting this parameter to YES. This parameter causes detail trace records to be written to trace browse for every thread connected to a DB2 system that is also connected to the Shadow Query Mainframe Adapter Server. At a minimum, one record per SQL statement will be written, whether or not the statement is of interest to the Shadow Query Mainframe Adapter Server. For statements of interest, one record per GTT, plus two records per row inserted into the GTT, will be written to trace browse.	NO	Yes	No
TRACEREXXEXEC	TRACE REXX EXECUTION. (YES, NO)	NO	Yes	No
TRACERPCEVENTS	TRACE ODBC CALL RPC EVENTS. (YES, NO)	YES	Yes	No
TRACERPCSQL	TRACE SQL FROM RPCS. (YES, NO)  This parameter controls whether or not SQL from RPCs executed by the product will be traced. Possible values are: <ul style="list-style-type: none"> <li><b>YES:</b> Static and dynamic SQL from RPCs will be traced.</li> <li><b>NO:</b> (Default) The SQL from RPCs will not be traced.</li> </ul> <b>Note:</b> This parameter only applies to RPCs executed in the main product address space.	NO	Yes	No

PRODTRACE Parameter Group				
Parameter Name	Parameter Description	Default Value	Update	Output Only
TRACERRSAF	TRACE RRSAF REQUESTS. (YES, NO)  This parameter can be set to YES so that an entry will be made in trace browse for each call to DSNRLI for RRSAF requests.	NO	Yes	No
TRACERRSEVENTS	TRACE RRS EVENTS. (YES, NO)  This parameter specifies whether or not RRS events will be traced via trace browse.	YES	Yes	No
TRACERRSXXXEVENTS	TRACE RRS XXX EVENTS. (YES, NO)	NO	Yes	No
TRACESCDetails	TRACE SHADOW CONSOLE DETAILS. (YES, NO)  This parameter can be set to YES to cause numerous entries to be made in the trace browse for CALL SHADOW_Mainframe Adapter Server requests.	NO	Yes	No
TRACESECURITYDATA	TRACE SECURITY DATA. (YES, NO)  This parameter controls tracing of security data. The only current security data is messages from logon processing. These messages are copied into trace browse as text if this parameter is set to YES.	NO	Yes	No
TRACESQLERRORS	TRACE SQL ERRORS DETECTED IN RPCS. (YES, NO)  This parameter controls whether or not SQL errors detected in RPCs executed by the product will be traced. Possible values are: <ul style="list-style-type: none"> <li>• <b>YES:</b> SQL errors detected in RPCs will be traced.</li> <li>• <b>NO:</b> (Default) The SQL errors detected in RPCs will not be traced.</li> </ul> <b>Note:</b> This parameter only applies to RPCs executed in the main product address space.	NO	Yes	No

PRODTRACE Parameter Group				
Parameter Name	Parameter Description	Default Value	Update	Output Only
TRACESQLEVENTS	<p>TRACE SQL EVENTS. (YES, NO).</p> <p>This parameter controls whether SQL events are traced or not. Possible values are:</p> <ul style="list-style-type: none"> <li><b>YES:</b> SQL events will be traced using trace browse.</li> <li><b>NO:</b> (Default) SQL events will not be traced.</li> </ul> <p><b>Note:</b> This parameter does not control the tracing of SQL events from the logging task. SQL events from the logging task are traced as SQM events. SQL events can be filtered using the trace browse profile facility.</p>	YES	Yes	No
TRACESQLSOURCE	<p>TRACE FULL SQL SOURCE. (YES, NO)</p> <p>This parameter controls whether the full SQL source for SQL events is traced or not. Possible values are:</p> <ul style="list-style-type: none"> <li><b>YES:</b> The complete SQL source for SQL events will be traced using trace browse.</li> <li><b>NO:</b> (Default) The full SQL source will not be traced.</li> </ul>	NO	Yes	No
TRACESQMEVENTS	<p>TRACE SQL EVENTS FROM LOGGING. (YES, NO)</p> <p>This parameter controls whether SQL events from the logging task are traced or not. Possible values are:</p> <ul style="list-style-type: none"> <li><b>YES:</b> (Default) SQL events from the logging task will be traced using trace browse. Note that the event type will be SQM, not SQL.</li> <li><b>NO:</b> SQL events from the logging task will not be traced.</li> </ul> <p><b>Note:</b> This parameter only controls the tracing of SQL events from the logging task. The tracing of all other SQL events is controlled using the TRACESQLEVENTS parameter. SQL events can be filtered using the trace browse profile facility.</p>	YES	Yes	No



<b>PRODTRACE Parameter Group</b>				
<b>Parameter Name</b>	<b>Parameter Description</b>	<b>Default Value</b>	<b>Update</b>	<b>Output Only</b>
TRACESRPFUNCTION	TRACE SERVICE PROVIDER FUNCTIONS. (YES, NO)  This parameter can be set to YES to cause the service requester/provider interface to generate trace messages during internal operations. This parameter should only be set under the specific guidance of the NEON Systems Customer Support group.	<b>NO</b>	Yes	No
TRACESSLACCEPT	TRACE SSL ACCEPT CALLS. (YES, NO)  This parameter controls whether or not SSL accept calls are traced.	<b>YES</b>	Yes	No
TRACESSLACCEPTSTATES	TRACE SSL ACCEPT STATES. (YES, NO)  This parameter controls whether or not SSL acceptance processing stages are traced.	<b>YES</b>	Yes	No
TRACESSLCLOSE	TRACE SSL CLOSE CALLS. (YES, NO)  This parameter controls whether or not SSL close calls are traced.	<b>YES</b>	Yes	No
TRACESSLEVENTS	TRACE SSL EVENTS. (YES, NO)  This parameter controls whether or not SSL-related processing events are logged to the wrap-around trace.	<b>YES</b>	Yes	No
TRACESSLFILEBIO	TRACE SSL FILE INTERCEPTS. (YES, NO)  This parameter controls whether or not SSL file operation intercepts are traced.	<b>NO</b>	Yes	No
TRACESSLHARDWARE	TRACE GSK SSL H/W ASSIST LEVEL. (YES, NO)  This parameter controls whether the GSK_SSL_HW_DETECT_MESSAGE variable is set on in the environment. For later versions of the GSK SSL implementation, this causes a message to be traced indicating the level of hardware cryptographic support installed on the system.	<b>NO</b>	Yes	No
TRACESSLREAD	TRACE SSL READ CALLS. (YES, NO)  This parameter controls whether or not SSL read calls are traced.	<b>YES</b>	Yes	No

PRODTRACE Parameter Group				
Parameter Name	Parameter Description	Default Value	Update	Output Only
TRACESSLTCPPIO	TRACE SSL TCP/IP INTERCEPTS. (YES, NO)  This parameter controls whether or not SSL TCP/IP intercept operations are traced.	NO	Yes	No
TRACESSLVERSION	TRACE SSL CODE VERSION. (YES, NO)  This parameter controls whether or not SSL_ACCEPT and SSL_GET_CTX operations trace the SSLeay version string.	NO	Yes	No
TRACESSLWRITE	TRACE SSL WRITE CALLS. (YES, NO)  This parameter controls whether or not SSL write calls are traced.	YES	Yes	No
TRACESTACK	TRACE STACK USAGE. (YES, NO)  This parameter controls whether or not stack trace is on.	NO	Yes	No
TRACESTATICSQL	TRACE STATIC SQL SOURCE. (YES, NO)	NO	Yes	No
TRACESTORAGEEVENTS	TRACE STORAGE EVENTS. (YES, NO)  This parameter causes all trace storage getting and freeing events to be traced.	NO	Yes	No
TRACESTREVENTS	TRACE STR EVENTS FROM SYSTEM TRACE. (YES, NO)  This parameter controls whether or not STR events from the system trace are traced. Possible values are: <ul style="list-style-type: none"> <li>• <b>YES:</b> (Default) STR events from the system trace will be traced using trace browse. Note that the event type will be STR.</li> <li>• <b>NO.</b> STR events from the system trace will not be traced. The system trace referred to here is a feature of the product, not the operating system.</li> </ul> <b>Note:</b> This parameter only controls the tracing of system events. The actual processing of these events is controlled by the PROCESSEP, PROCESSPC, and PROCESSSVC product parameters.	YES	Yes	No

PRODTRACE Parameter Group				
Parameter Name	Parameter Description	Default Value	Update	Output Only
TRACETCPIPDATA	<p>TRACE FULL TCP/IP DATA. (YES, NO)</p> <p>This parameter controls whether the full TCP/IP data for TCP/IP read/write events is traced or not. Possible values are:</p> <ul style="list-style-type: none"> <li><b>YES:</b> The complete TCP/IP data for TCP/IP read/write events will be traced using trace browse.</li> <li><b>NO:</b> (Default) The full TCP/IP data will not be traced.</li> </ul> <p><b>Note:</b> This parameter only controls tracing for non-OE IBM TCP/IP.</p>	NO	Yes	No
TRACETCPIPEVENTS	<p>TRACE TCP/IP EVENTS. (YES, NO)</p> <p>This parameter controls if IBM TCP/IP events should be traced or not. Possible values are:</p> <ul style="list-style-type: none"> <li><b>YES:</b> (Default) IBM TCP/IP events will be traced.</li> <li><b>NO:</b> IBM TCP/IP events will not be traced.</li> </ul> <p><b>Note:</b> A separate parameter is used to control whether the simulated external events for IBM TCP/IP are traced or not. The parameter that controls the tracing of external interrupts is TRACETCPIPEXTINT.</p>	YES	Yes	No
TRACETCPIPEXTINT	<p>TRACE TCP/IP EXTERNAL INTERRUPT EVENTS. (YES, NO)</p> <p>This parameter controls if IBM TCP/IP external interrupt events should be traced or not. Possible values are:</p> <ul style="list-style-type: none"> <li><b>YES:</b> The simulated external interrupts used by IBM TCP/IP will be traced.</li> <li><b>NO:</b> (Default) The simulated external interrupts used by IBM TCP/IP will not be traced.</li> </ul>	NO	Yes	No

PRODTRACE Parameter Group				
Parameter Name	Parameter Description	Default Value	Update	Output Only
TRACETCPIRDWR	TRACE TCP/IP READ/WRITE EVENTS. (YES, NO)  This parameter controls if IBM TCP/IP read/write events should be traced or not. Possible values are: <ul style="list-style-type: none"> <li><b>YES:</b> IBM TCP/IP read/write events will be traced.</li> <li><b>NO:</b> (Default) IBM TCP/IP read/write events will not be traced.</li> </ul>	NO	Yes	No
TRACETEXTEVENTS	TRACE TEXT EVENTS. (YES, NO)	YES	Yes	No
TRACETODEVENTS	TRACE TOD EVENTS. (YES, NO)	YES	Yes	No
TRACETSOEVENTS	TRACE TSO EVENTS. (YES, NO)  This parameter controls if out-board TSO Mainframe Adapter Server events are logged to the wrap-around trace.	YES	Yes	No
TRACEWLMCALLS	TRACE WLM API CALLS. (YES, NO)  This parameter is used to control tracing of Shadow Mainframe Adapter Server calls to the WLM APIs for transaction management. If YES is specified, all calls will be traced.	NO	Yes	No
TRACEWTOMODULES	WTO MODULE ENTRY/EXIT MESSAGES. (YES, NO)  This parameter is for debugging purposes only and should be used only under the guidance of NEON Systems Customer Support.	NO	Yes	No
TRACEXIT	TRACE MODULE EXIT.  This parameter is for debugging purposes only and should be used only under the guidance of NEON Systems Customer Support.	X'07FE'	Yes	No
TSOSRVTRACEOPER	TRACE TSOSRV OPERATIONS. (YES, NO)  This parameter indicates whether TSO Mainframe Adapter Server dispatching and control operations should be traced.	NO	Yes	No
VSAMTRACECICS	TRACE VSAM CICS EXECUTION. (YES, NO)	NO	Yes	No

**PRODWLM**

<b>PRODWLM Parameter Group</b>				
<b>Parameter Name</b>	<b>Parameter Description</b>	<b>Default Value</b>	<b>Update</b>	<b>Output Only</b>
WLMCLASSDB2	<p>CLASSIFY USING DB2 SUBSYSTEM IDENTIFIER. (YES, NO)</p> <p>This parameter controls whether or not WLM will use the DB2 subsystem ID when classifying Shadow Mainframe Adapter Server transactions. If YES is specified, WLM will use the DB2 subsystem ID as a criterion when looking for a classification rule match. When the subsystem ID is used for classification, the Shadow Mainframe Adapter Server will establish a unique enclave for each transaction. WLM classification rules can assign this enclave to a service class with velocity or response goals and one or more periods.</p>	<b>NO</b>	Yes	No
WLMCLASSPLAN	<p>CLASSIFY USING DB2 PLAN NAME. (YES, NO)</p> <p>This parameter controls whether or not WLM will use the DB2 plan name when classifying Shadow Mainframe Adapter Server transactions. If YES is specified, WLM will use the DB2 plan name as a criterion when looking for a classification rule match.</p>	<b>NO</b>	Yes	No
WLMCLASSSPM	<p>CLASSIFY USING SUBSYSTEM PARAMETER. (YES, NO)</p> <p>This parameter controls whether or not WLM will use the subsystem parameter (WLMSUBSYSPARM) when classifying Shadow Mainframe Adapter Server transactions. If YES is specified, WLM will use the subsystem parameter as a criterion when looking for a classification rule match.</p>	<b>NO</b>	No	No
WLMCLASSTRAN	<p>CLASSIFY USING TRANSACTION NAME. (YES, NO)</p> <p>This parameter controls whether or not WLM will use the transaction name when classifying Shadow Mainframe Adapter Server transactions. If YES is specified, WLM will use the Shadow transaction name as a criterion when looking for a classification rule match.</p>	<b>NO</b>	Yes	No

<b>PRODWLM Parameter Group</b>				
<b>Parameter Name</b>	<b>Parameter Description</b>	<b>Default Value</b>	<b>Update</b>	<b>Output Only</b>
WLMCLASSUSER	<p>CLASSIFY USING USERID. (YES, NO)</p> <p>This parameter controls whether or not WLM will use the userid when classifying Shadow Mainframe Adapter Server transactions. If YES is specified, WLM will use the userid as a criterion when looking for a classification rule match.</p>	<b>NO</b>	Yes	No
WLMCONNECT	<p>INITIALIZE WLM SUPPORT. (YES, NO, COMPAT)</p> <p>This parameter specifies whether or not the Shadow Mainframe Adapter Server address space is to attempt to connect to the OS/390 Work Load Manager (WLM) as a WLM work manager. If YES is specified, the Shadow Mainframe Adapter Server will use WLM enclaves for transaction execution.</p>	<b>YES</b>	No	No
WLMGROUPNAME	<p>SHADOW Mainframe Adapter Server LOCATION FOR SYSPLEX ROUTING.</p> <p>This parameter is used in conjunction with the WLMNETID, WLMLUNAME, and WLMHOSTNAME parameters to register the Shadow Mainframe Adapter Server address space with WLM sysplex routing services. The WLMGROUPNAME specified is used as the value for LOCATION when registering with WLM sysplex routing services. The sysplex routing services use the LOCATION, NETWORK_ID.LUNAME, and, optionally, HOSTNAME to uniquely identify an instance of the Shadow Mainframe Adapter Server within a sysplex.</p> <p>If the Cisco Workload Agent is used, the GROUPNAME in the Service Application Mapping configuration file should match the value specified for WLMGROUPNAME.</p> <p>WLMGROUPNAME is specified as an arbitrary character string up to 18 bytes long. There is no default for this parameter. If this parameter is not specified, the Shadow Mainframe Adapter Server will not register with WLM sysplex routing services.</p>	<b>NULL</b>	No	No

PRODWLM Parameter Group				
Parameter Name	Parameter Description	Default Value	Update	Output Only
WLMHOSTNAME	<p>SHADOW Mainframe Adapter Server HOSTNAME FOR SYSPLEX ROUTING.</p> <p>This parameter is used in conjunction with the WLMGROUPNAME, WLMNETID and WMLLUNAME parameters to register the Shadow Mainframe Adapter Server address space with WLM sysplex routing services.</p> <p>WLMHOSTNAME is an optional parameter and is specified as an arbitrary character string up to 64 bytes long. This parameter is ignored if WLMGROUPNAME is not specified. There is no default host name.</p>	NULL	No	No
WMLLUNAME	<p>SHADOW Mainframe Adapter Server LUNAME FOR SYSPLEX ROUTING.</p> <p>This parameter is used in conjunction with the WLMGROUPNAME, WLMNETID and WLMHOSTNAME parameters to register the Shadow Mainframe Adapter Server address space with WLM sysplex routing services. The value specified for WMLLUNAME is used for LUNAME when registering with WLM sysplex routing services.</p> <p>WMLLUNAME is an optional parameter and is specified as an arbitrary character string up to 8 bytes long. This parameter is ignored if WLMGROUPNAME is not specified.</p>	NULL	No	No
WLMNETID	<p>SHADOW Mainframe Adapter Server NETID FOR SYSPLEX ROUTING.</p> <p>This parameter is used in conjunction with the WLMGROUPNAME, WMLLUNAME and WLMHOSTNAME parameters to register the Shadow Mainframe Adapter Server address space with WLM sysplex routing services. The value specified for WLMNETID is used for NETWORK_ID when registering with WLM sysplex for routing services.</p> <p>WLMNETID is an optional parameter and is specified as an arbitrary character string up to 8 bytes long. This parameter will be ignored if WLMGROUPNAME is not specified.</p>	NULL	No	No
WLMSUBSYSNAM	<p>WORKMANAGER SUBSSYSTEM NAME.</p> <p>This parameter is used to identify the Shadow Mainframe Adapter Server address space. The combination of WLMSUBSYSTEM and WLMSUBSYSNAM uniquely identifies an address space to WLM. This parameter defaults to the Shadow Mainframe Adapter Server subsystem ID.</p>	<b>(SHADOW Mainframe Adapter Server SUBSYSTEM NAME)</b>	No	No

PRODWLM Parameter Group				
Parameter Name	Parameter Description	Default Value	Update	Output Only
WLMSUBSYSPARM	<p>WORKMANAGER SUBSYSTEM PARAMETER.</p> <p>This parameter can be used to provide an arbitrary identifier for this Shadow Web Server address space. This parameter in conjunction with the WLMCLASSSPM parameter, can be used to classify all work for this Shadow Mainframe Adapter Server address space into a particular WLM service class.</p>	NULL	No	No
WLMSUBSYSTEM	<p>WORKMANAGER SUBSYSTEM TYPE.</p> <p>This parameter is used to specify the subsystem type to be used for the Shadow Mainframe Adapter Server address space. The subsystem type is used to select the transaction classification rules, which determine the WLM service class to be used for a transaction. This parameter defaults to the first three characters of the Shadow subsystem ID.</p>	'SDB'	No	No
WLMTRANNAME	<p>TRANSACTION NAME SOURCE.</p> <p>This parameter specifies which value will be used as the transaction name when classifying Shadow Mainframe Adapter Server transactions. The WLMTRANNAME parameter is used in conjunction with WLMCLASSTRAN=YES. The possible values are:</p> <ul style="list-style-type: none"> <li>• <b>APPLNAME:</b> (Default) The application name set in the Mainframe Adapter Client ODBC data source will be used as the transaction name.</li> <li>• <b>MODNAME:</b> The name of the application using the Mainframe Adapter Client ODBC driver will be used as the transaction name.</li> <li>• <b>INTNAME:</b> The Mainframe Adapter Client application executable internal name will be used as the transaction name.</li> </ul>	APPLNAME	Yes	No



## Obsolete

Obsolete Parameters				
Parameter Name	Parameter Description	Default Value	Update	Output Only
AUTHPROSET	AUTHORIZATION RULESET NAME.	'ATH'	No	No
EPRIVLIMIT	EPRIVATE STORAGE UTILIZATION LIMIT.  This parameter was used to control how much extended private area storage the product should be allowed to allocate. This parameter is now obsolete. Extended private area storage is now managed by the system to provide maximum reliability and availability.  <b>Minimum Value: 1048576</b> <b>Maximum Value: 2147483647</b>	2097151K	N/A	Yes
EPROALTFIX	SEF RULESET DATASET NAMES ALTERNATE PREFIXES.	NULL	No	No
EPROPREFIX (see note on page	SEF RULESET DATASET NAMES PREFIX.	'SDB.SV040500'	No	No
EPROSUBSYS	SEF RULESET DATASETS SUBSYSTEM NAME.	NULL	No	No
EPROSUFFIX	SEF RULESET DATASET NAMES SUFFIX.	'EXEC'	No	No
EXECDATASETNAME	REXX EXEC DATA SET NAME.	'CSD.AI38.SV040500.E'	Yes	No
FREEACEEBLOCKS	FREE ACEE CONTROL BLOCKS. (YES, NO)  This parameter controls if a RACROUTE DELETE command should be issued out of end-Of-task processing to free the ACEE created for ODBC threads. The default should be YES. However, this causes abends in RACF processing in some cases (IBM bugs).	NO	Yes	No
LOGEXCEPTIONSTABLE	TABLE NAME FOR SQL EXCEPTIONS. <b>This function has been replaced by the use of the LOGSQLERRORS.</b>	'SHADOW.SQLEXCEPTION'	Yes	No
MAXLONGVARCHAR	MAXIMUM LONG VARCHAR DATA LENGTH.  This parameter specifies the maximum allowable length of a LONG VARCHAR field. Under some circumstances the maximum must be set low so that LONG VARCHAR data can be sent using a 32K buffer.  <b>Note:</b> The actual data can not be longer than the value set.	1000000 BYTES	Yes	No

Obsolete Parameters				
Parameter Name	Parameter Description	Default Value	Update	Output Only
PRELOADEXECs	PRELOAD REXX EXECs INTO STORAGE. (YES, NO)	NO	Yes	No
PRIVLIMIT	PRIVATE STORAGE UTILIZATION LIMIT.  This parameter was used to control how much below the 16 MB line private area storage the product should be allowed to allocate. This parameter is now obsolete. Below the 16 MB line private area storage is now managed by the system to provide maximum reliability and availability.  <b>Minimum Value: 131072</b> <b>Maximum Value: 8388608</b>	12288K	N/A	Yes
RUNSDF	Mainframe Adapter ClientS CAN USE THE SDF PROGRAM. (YES, NO)	NO	Yes	No
TRACEMESSAGEEVENTS	TRACE MESSAGE EVENTS. (YES, NO)	NO	Yes	No
TRACEREMOTERPC	TRACE REMOTE PROCESSING RPC. (YES, NO)	NO	Yes	No
TRANSACTIONTIMEOUT	TRANSACTION TIMEOUT VALUE.  This parameter can be used to limit the wait time for the completion of a transaction. If the transaction times out, a message is placed in the communication buffer to notify the Mainframe Adapter Client that a time-out has occurred.	0 SECONDS	Yes	No
TYPEPROSET	TYP RULESET NAME.	'TYP'	No	No
USECMCO	USE CMCO CONTROL BLOCKS. (YES, NO)  This parameter forces a different set of control blocks to be used to send SQL requests between two hosts. Mainframe to mainframe SQL processing is no longer supported by Shadow Mainframe Adapter Server on the host. This parameter is obsolete and should never be set or used in any way.	NO	Yes	No
USECMOF	USE CMOF CONTROL BLOCKS. (YES, NO)  This parameter forces a different set of control blocks to be used to send SQL requests between two hosts. Mainframe to mainframe SQL processing is no longer supported by Shadow Mainframe Adapter Server on the host. This parameter is obsolete and should never be set or used in any way.	NO	Yes	No

**Note:**

EPROPREFIX, EPROSUFFIX, and EPROSUBSYS are not obsolete for customers using Version 3.1.1 or below of SEF configuration parameters. For more information, see SEFV3COMPATIBLE on page 111 of this chapter.

