

File Manager for z/OS V7R1



# Addenda to V7R1 User's Guides and Customization Guide



File Manager for z/OS V7R1



# Addenda to V7R1 User's Guides and Customization Guide



---

# Contents

**About this document . . . . . v**

---

## **Part 1. PTF/APAR Documentation Changes . . . . . 1**

**UK39593, UK08097, UK08098, UK08099 3**

PK66473 . . . . . 3  
Changes to the User's Guide and Reference for  
IMS . . . . . 4  
PK68098 . . . . . 18  
Changes to the User's Guide and Reference . . . . . 22  
PK70108 . . . . . 23  
Changes to the User's Guide and Reference . . . . . 23

**UK34896, UK34897, UK34898, UK34899,  
UK34900, UK34901, UK34902, UK34903,  
UK34904, UK34905 . . . . . 25**

PK60896 . . . . . 26  
Changes to the User's Guide . . . . . 26  
Changes to the User's Guide and Reference for  
IMS . . . . . 27

**PK55097 . . . . . 29**

**UK31651, UK31652, UK31653, UK31654,  
UK31655, UK31656, UK31657, UK31658,  
UK31659, UK31660, UK31661, UK31662. 31**

PK55164 . . . . . 31  
Changes to the User's Guide and Reference . . . . . 32

**UK28623, UK28624, UK28625, UK28626,  
UK28627, UK28628, UK28629, UK28630,  
UK28631, UK28632 . . . . . 35**

PK45233 . . . . . 35  
Changes to the User's Guide and Reference for  
DB2 Data . . . . . 35

**UK27934, UK27939, UK27941, UK27939,  
UK27942 . . . . . 37**

PK48836 . . . . . 37  
Changes to the Customization Guide . . . . . 38  
PK49243 . . . . . 39  
Changes to the Customization Guide . . . . . 39

**UK26398, UK26399, UK26401, UK26402,  
UK26403, UK26404 . . . . . 41**

PK45551 . . . . . 41  
Changes to the User's Guide and Reference for  
CICS . . . . . 41

**UK25481, UK25482, UK25483, UK25484,  
UK25485, UK25486 . . . . . 43**

PK44677 . . . . . 43  
Changes to the User's Guide and Reference . . . . . 44

**UK24878, UK24879, UK24880, UK24893,  
UK24898, UK24899, UK24906 . . . . . 45**

PK43546 . . . . . 45  
Changes to the User's Guide and Reference for  
CICS . . . . . 46

**UK22513, UK22524, UK22525, UK22526,  
UK22528, UK22529 . . . . . 47**

PK38471 . . . . . 47  
Changes to the User's Guide and Reference for  
IMS . . . . . 47

**UK21782, UK21784, UK21785, UK21789 49**

PK37318 . . . . . 49  
Changes to the User's Guide and Reference for  
CICS . . . . . 50

**UK19762, UK19763, UK19764, UK19765,  
UK19771 . . . . . 53**

PK33688 . . . . . 53  
Changes to the User's Guide and Reference . . . . . 53  
PK33920 . . . . . 54  
Changes to the User's Guide and Reference . . . . . 55

**UK19102, UK19103, UK19104, UK19115,  
UK19116, UK19135, UK19136, UK19139. 57**

PK31764 . . . . . 57  
Changes to the User's Guide and Reference . . . . . 58  
Changes to the User's Guide and Reference for  
IMS Data . . . . . 59

---

## **Part 2. General Documentation Changes . . . . . 61**

**Customization Guide (SC19-1036-02) 63**

Change #1 October 2007 . . . . . 63  
Change #2 October 2007 . . . . . 63  
Change #3 October 2007 . . . . . 63  
CCSIDWARNIGNORE. . . . . 63  
CCSIDWARN. . . . . 64  
Change #4 December 2007 . . . . . 65

**User's Guide and Reference  
(SC19-1037-00) . . . . . 67**

Change #11: December 2008 . . . . . 67  
Change #10 September 2007 . . . . . 67  
Change #9 September 2007 . . . . . 67

Change #8 August 2007 . . . . .	68
Change #7 August 2007 . . . . .	68
Change #6 August 2007 . . . . .	68
Change #5 April 2007 . . . . .	68
Change #4 March 2007 . . . . .	69
Change #3 December 2006 . . . . .	69
Change #2 (November 2006). . . . .	69
Chapter 17, "Functions" . . . . .	69
Change #1 (November 2006). . . . .	70
Chapter 7, "Managing data sets" . . . . .	70
Chapter 17, "Functions" . . . . .	71

<b>User's Guide and Reference for DB2 Data (SC19-1038-01) . . . . .</b>	<b>73</b>
---	-----------

<b>User's Guide and Reference for IMS Data (SC18-9657-01) . . . . .</b>	<b>75</b>
---	-----------

Change #1 August 2007 . . . . .	75
---------------------------------	----

<b>User's Guide and Reference for CICS (SC19-1040-00) . . . . .</b>	<b>77</b>
Change #1 September 2007 . . . . .	77
Change #2 September 2007 . . . . .	77
Change #3 September 2007 . . . . .	77
Change #4 September 2007 . . . . .	77

---

<b>Part 3. Appendixes. . . . .</b>	<b>79</b>
------------------------------------	-----------

<b>Index . . . . .</b>	<b>81</b>
------------------------	-----------

---

## About this document

This document provides details of all the APAR service fixes that impact upon documentation, for IBM File Manager for z/OS Version 7.1, since the most recent edition of the product manuals in September 2006. These editions are:

- Customization Guide (SC19-1036-02) - Third Edition
- User's Guide and Reference (SC19-1037-00) - First Edition
- User's Guide and Reference for DB2 Data (SC19-1038-01) - Second Edition
- User's Guide and Reference for IMS Data (SC19-1039-01) - Second Edition
- User's Guide and Reference for CICS (SC19-1040-00) - First Edition

The Addendum document is divided into two parts:

- **Part One: PTF/APAR Documentation Changes**

This section lists the changes to the File Manager for z/OS Version 7 Release 1 documentation that are required to reflect new behavior resulting from the application of APAR fixes.

The fixes are listed by PTF number, in reverse date order, so that the most recently released fix appears at the beginning of the document. Each description shows:

- The set of PTF numbers in the release
- The date of the PTF release
- The APARs included in the released fix
- Details of those APAR changes that affect documentation
- Page references for the manuals affected by the change

**Notes:**

1. This document does NOT describe those APAR fixes that do not have an impact upon documentation.
2. The enhancements and corrections described in this section are only available after applying the listed PTFs for the APAR.

- **General Documentation Changes**

This section describes enhancements, corrections and updates in the documentation for File Manager for z/OS Version 7 Release 1. These changes are not associated with PTF numbers, as they do not require the application of any code updates.

The changes are grouped by manual and listed within each section in reverse date order. That is, the most recent documentation change appears at the beginning of each manual section.





## Part 1. PTF/APAR Documentation Changes

<b>UK39593, UK08097, UK08098, UK08099</b> . . . . .	3	Chapter 25. "Customizing File Manager/CICS" . . . . .	39
PK66473 . . . . .	3	<b>UK26398, UK26399, UK26401, UK26402,</b>	
Changes to the User's Guide and Reference for		<b>UK26403, UK26404</b> . . . . .	41
IMS . . . . .	4	PK45551 . . . . .	41
Chapter 11, "Batch Reference", subsection		Changes to the User's Guide and Reference for	
"Batch Edit (IEB)", "Retrieval using a view" . . . . .	4	CICS . . . . .	41
Chapter 11, "Batch Reference", subsection		Chapter 9, "Messages" . . . . .	41
"Batch Edit (IEB)", "Retrieval without a view" . . . . .	10	Chapter 11, "FM/CICS panels and fields" . . . . .	42
PK68098 . . . . .	18	<b>UK25481, UK25482, UK25483, UK25484,</b>	
Changes to the User's Guide and Reference . . . . .	22	<b>UK25485, UK25486</b> . . . . .	43
Chapter 15, "Panels and fields" . . . . .	22	PK44677 . . . . .	43
PK70108 . . . . .	23	Changes to the User's Guide and Reference . . . . .	44
Changes to the User's Guide and Reference . . . . .	23	Chapter 17, "Functions" . . . . .	44
Chapter 7, "Managing data sets" . . . . .	23	<b>UK24878, UK24879, UK24880, UK24893,</b>	
<b>UK34896, UK34897, UK34898, UK34899,</b>		<b>UK24898, UK24899, UK24906</b> . . . . .	45
<b>UK34900, UK34901, UK34902, UK34903,</b>		PK43546 . . . . .	45
<b>UK34904, UK34905</b> . . . . .	25	Changes to the User's Guide and Reference for	
PK60896 . . . . .	26	CICS . . . . .	46
Changes to the User's Guide . . . . .	26	Chapter 9, "Messages" . . . . .	46
Chapter 4, "Creating and editing templates" . . . . .	26	<b>UK22513, UK22524, UK22525, UK22526,</b>	
Chapter 15, "Panels and fields" . . . . .	27	<b>UK22528, UK22529</b> . . . . .	47
Changes to the User's Guide and Reference for		PK38471 . . . . .	47
IMS . . . . .	27	Changes to the User's Guide and Reference for	
Chapter 9, "Panels and fields" . . . . .	27	IMS . . . . .	47
<b>PK55097</b> . . . . .	29	Chapter 9, "Panels and fields" . . . . .	47
<b>UK31651, UK31652, UK31653, UK31654,</b>		Chapter 11, "Functions" . . . . .	47
<b>UK31655, UK31656, UK31657, UK31658,</b>		<b>UK21782, UK21784, UK21785, UK21789</b> . . . . .	49
<b>UK31659, UK31660, UK31661, UK31662</b> . . . . .	31	PK37318 . . . . .	49
PK55164 . . . . .	31	Changes to the User's Guide and Reference for	
Changes to the User's Guide and Reference . . . . .	32	CICS . . . . .	50
Chapter 8, Using File Manager Utilities . . . . .	32	Chapter 2, "Getting started with FM/CICS" . . . . .	50
Chapter 14, Panels and fields . . . . .	32	Chapter 9, "Messages" . . . . .	51
<b>UK28623, UK28624, UK28625, UK28626,</b>		Chapter 11, "FM/CICS panels and fields" . . . . .	52
<b>UK28627, UK28628, UK28629, UK28630,</b>		<b>UK19762, UK19763, UK19764, UK19765, UK19771</b> . . . . .	53
<b>UK28631, UK28632</b> . . . . .	35	PK33688 . . . . .	53
PK45233 . . . . .	35	Changes to the User's Guide and Reference . . . . .	53
Changes to the User's Guide and Reference for		Chapter 17, "Functions" . . . . .	53
DB2 Data . . . . .	35	PK33920 . . . . .	54
Chapter 12, "Generating batch JCL for DB2		Changes to the User's Guide and Reference . . . . .	55
utility jobs" . . . . .	35	Chapter 17, "Functions" . . . . .	55
<b>UK27934, UK27939, UK27941, UK27939, UK27942</b> . . . . .	37	<b>UK19102, UK19103, UK19104, UK19115,</b>	
PK48836 . . . . .	37	<b>UK19116, UK19135, UK19136, UK19139</b> . . . . .	57
Changes to the Customization Guide . . . . .	38	PK31764 . . . . .	57
Appendix A, "File Manager options" . . . . .	38	Changes to the User's Guide and Reference . . . . .	58
Chapter 4, "Customizing the File Manager		Chapter 7, "Managing data sets" . . . . .	58
security environment" . . . . .	38	Chapter 15, "Panels and fields" . . . . .	58
Chapter 26, "Customizing the File		Chapter 17, "Functions" . . . . .	59
Manager/CICS security environment" . . . . .	38		
PK49243 . . . . .	39		
Changes to the Customization Guide . . . . .	39		

Changes to the User's Guide and Reference for  
IMS Data . . . . . 59  
    Chapter 9, "Panels and fields" . . . . . 59

---

## UK39593, UK08097, UK08098, UK08099

Release Date: 12 September 2008

This set of PTFs contains the following APAR fixes:

APAR #	APAR Abstract	Doc Impact
PK66344	Getting different results for total space in DVT output.	None.
PK66473	Batch FM/IMS does not seem to provide the same functionality regarding template/views as foreground does.	User's Guide and Reference for IMS (SC19-1039-01).
PK68000	FM/DB2 Copy utility does not copy graphic columns when the tables are stored in unicode.	None.
PK68098	File Manager - various problems found internally Q3 2008	User's Guide and Reference (SC19-1037-00)
PK70108	File Manager generated wrong JCL using FCH function.	User's Guide and Reference (SC19-1037-00)
PK70112	ABEND0C4 occurred at FMNMAIN during table edit.	None.
PK70375	Format SNGL results in ABEND0C4 in module FMNMAIN CSECT FMNRDRFS.	None.

---

### PK66473

#### Initial problem description

In IEB/IBB batch the field references can only be specified on the:

- 1. WHERE clause of the DELIMS, GETIMS, ISRTIMS, REPLIMS and VIEWPOSN functions for the first layout of a segment.
- 2. SET clause of the ISRTIMS function for the first layout of a segment.
- 3. SET clause of the REPLIMS function for the current layout associated with the segment being replaced.

In IEB/IBB batch the VIEWIMS function does not allow:

- 4. Segment layouts to be deselected.
- 5. Selection criteria to be specified for individual segment layouts. The criteria will be placed on the first layout for a segment.

Miscellaneous issues:

- 6. The SETRC IEB/IBB batch function does not allow a value of zero to be specified.

- 7. In browse or edit, after accessing a terminal MSDB data base and attempting to access a HALDB, DEDB, full function or non-terminal MSDB database using a dynamic PSB, FM/IMS receive message 'DFS0919I KEYLEN SPECIFICATION TOO SMALL. KEY LEN SHOULD BE --xxxxx BYTES'. FM/IMS then abends U919.

**Outline of solution**

FM/IMS has been modified to:

- Allow the user to qualify the field references or field names names with either a relative layout number or layout name on the:
  - 1. WHERE clause for the DELIMS, GETIMS,ISRTIMS, REPLIMS and VIEWPOSN IEB/IBB batch functions.
  - 2. SET clause for the ISRTIMS IEB function.
  - 3. SET clause for the REPLIMS IEB function.
- 4. Allow the specification of the layouts that are selected for a segment when creating the view using the VIEWIMS IEB/IBB batch function.
- 5. Allow the specification of the selection criteria for individual segment layouts when creating the view using the VIEWIMS IEB/IBB batch function.
- 6. Allow a value of '0' to be specified for the SETRC IEB/IBB batch function.
- 7. Ensure the flag which specifies a database is a terminal MSDB is switched off and hence the dynamic PSB which is generated has the correct keylen specified.

**Documentation impact**

This APAR requires changes to be made to:

- User's Guide and Reference for IMS (SC18-1039-01)

## **Changes to the User's Guide and Reference for IMS**

### **Chapter 11, "Batch Reference", subsection "Batch Edit (IEB)", "Retrieval using a view"**

Replace these syntax diagrams and the description of parameters that follow each diagram:

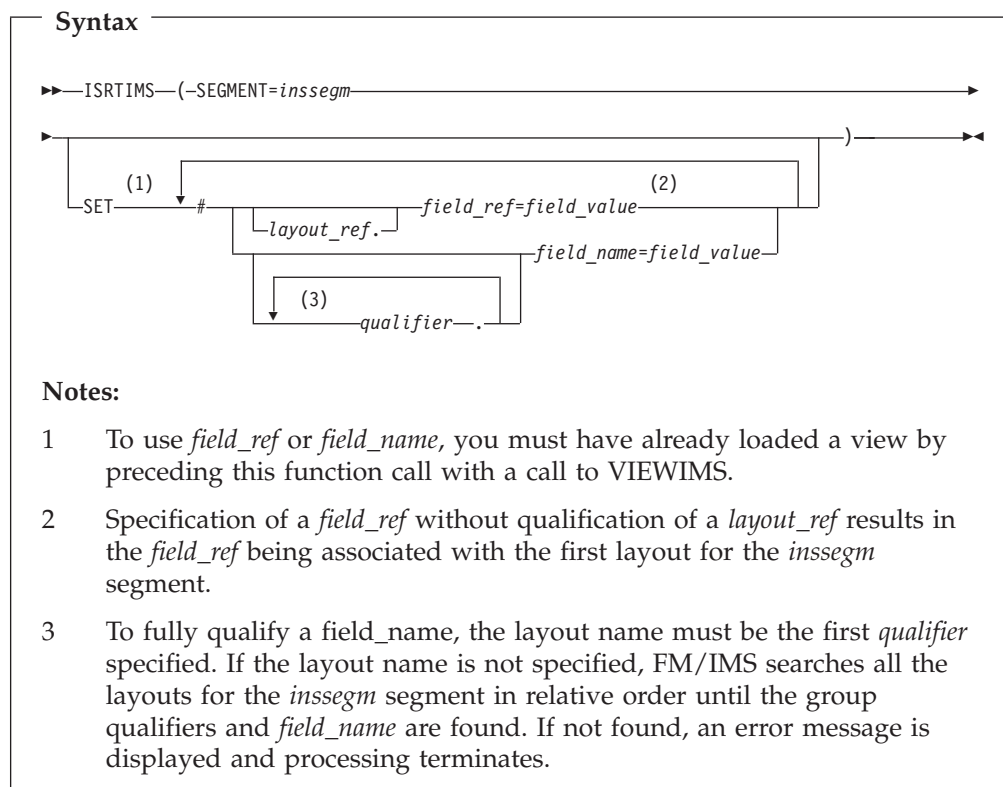
*field\_name*

A field name.

*field\_ref*

A field reference number of the field within the layout. This can be obtained by printing the view/template using the VIEWIMS DESCRIBE clause or browsing the view/template online.

*field\_value*

The value of the field specified by *field\_ref* or *field\_name*.

*inssegm*

The name of the segment you want to insert. This must be a child of the current segment.

*layout\_ref*

The relative number of layout within a segment. This can be obtained by printing the view/template using the VIEWIMS DESCRIBE clause.

*qualifier*

One or more qualifiers that identify the field name (*field\_name*). The first qualifier is the segment layout name. Subsequent qualifiers (if any) are the group fields used to identify the specified field name. Omitting the layout name or group fields causes FM/IMS to search the segment layouts for the specified qualifiers and field name.

**Note:** The layout names and group fields can be obtained by printing the view/template using the VIEWIMS DESCRIBE clause or browsing the view/template online.

**Syntax**

```

    ►► REPLIMS ([-SEGMENT=repsegm]
    ► SET (1) # [layout_ref.] field_ref=field_value (2)
    ► [qualifier.] field_name=field_value
    ► (3)
  
```

**Notes:**

- 1 To use *field\_ref* or *field\_name*, you must have already loaded a view by preceding this function call with a call to VIEWIMS.
- 2 Specification of a *field\_ref* without qualification of a *layout\_ref* results in the *field\_ref* being associated with the current layout for the *repsegm* segment.
- 3 To fully qualify a field name, the layout name must be the first *qualifier* specified. If the layout name is not specified, FM/IMS searches the current the layout for the *repsegm* segment being replaced. If the group qualifiers and field name are not found, FM/IMS searches all the layouts for the *repsegm* segment in relative order until the group qualifiers and field name are found. If not found, an error message is displayed and processing terminates.

*field\_name*

A field name.

*field\_ref*

A field reference number of the field within the layout. This can be obtained by printing the view/template using the VIEWIMS DESCRIBE clause or browsing the view/template online.

*field\_value*

The value of the field specified by *field\_ref* or *field\_name*.

*layout\_ref*

The relative number of layout within a segment. This can be obtained by printing the view/template using the VIEWIMS DESCRIBE clause.

*qualifier*

One or more qualifiers that identify the field name (*field\_name*). The first qualifier is the segment layout name. Subsequent qualifiers (if any) are the group fields used to identify the specified field name. Omitting the layout name or group fields causes FM/IMS to search the current *repsegm* segment layout for the specified qualifiers and field name. If not found, then all *repsegm* segment layouts are searched for the specified qualifiers and field name.

**Note:** The layout names and group fields can be obtained by printing the view/template using the VIEWIMS DESCRIBE clause or browsing the view/template online.

*repsegm*

The name of the segment you want to replace.

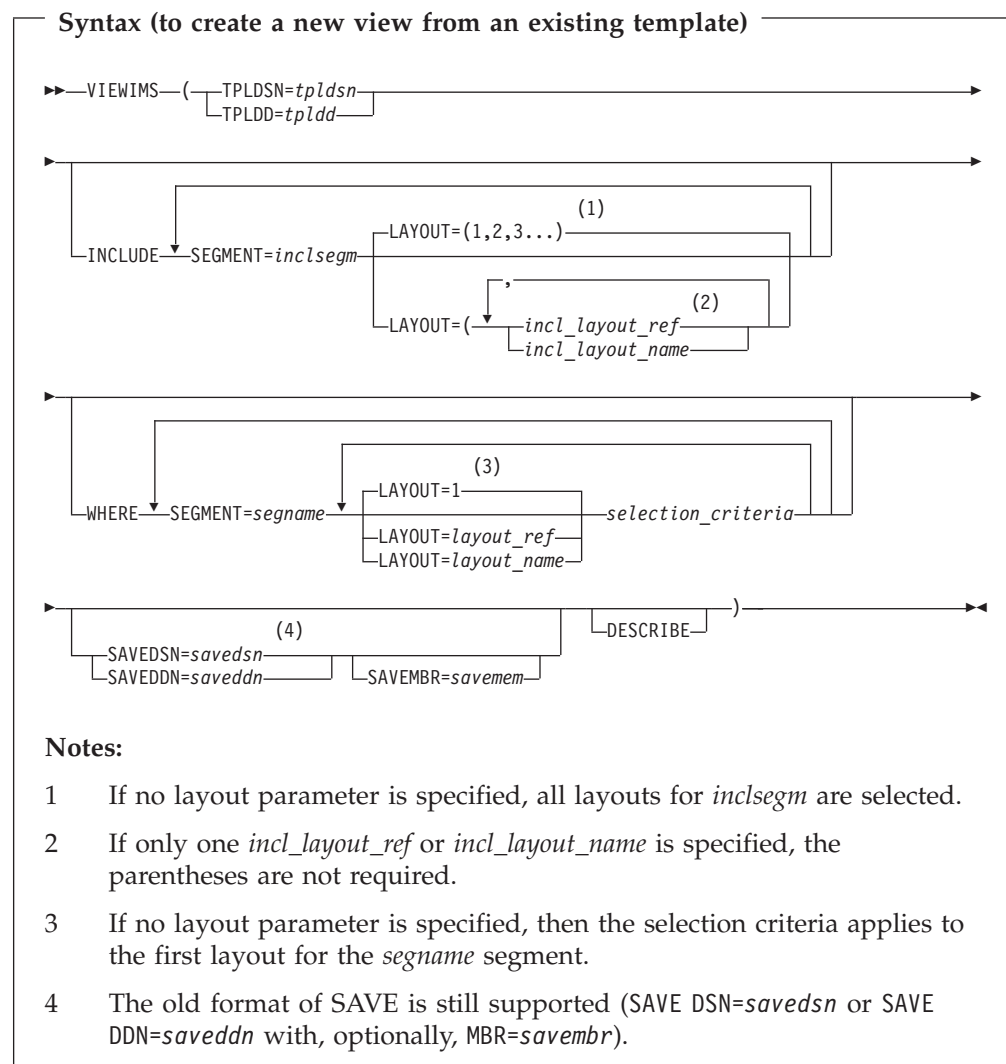

If you specify the DESCRIBE parameter, then VIEWIMS prints a report showing the structure of the view or template for each segment in the database.

*incl\_layout\_name*

The name of the *inclsegm* segment layout to be selected in the view. You can obtain this by printing the view/template with the VIEWIMS DESCRIBE clause or browsing the view/template online.

*incl\_layout\_ref*

The relative number of the layout within the *inclsegm* segment that is selected in the view. You can obtain this by printing the view/template with the VIEWIMS DESCRIBE clause.

*inclsegm*

The name of a segment to be included in the view.

If you call the GETIMS function with the USING\_VIEW parameter, then only the included in the view is retrieved.

However, if you omit the INCLUDE clause entirely, then all segments are included in the view.

*layout\_name*

The name of the layout within the *segname* segment to which the selection criteria are to apply. This can be obtained by printing the view/template using the VIEWIMS clause or browsing the view/template online.

*layout\_ref*

The relative number of the layout within a segment to which the selection criteria are to apply. This can be obtained by printing the view/template using the VIEWIMS DESCRIBE clause.

*saveddn*

The DDNAME containing the data set into which the view is to be saved. If the data set is a PDS, you must also specify the SAVEMBR=*savemem* parameter.

*savedsn*

The name of the data set into which the view is to be saved. If the data set is a PDS, you must also specify the MBR=*savemem* parameter.

*savemem*

The member of the PDS specified by the DSN, SAVEDSN, DDN, or SAVEDDN parameter into which the view is to be saved.

*segname*

The name of a segment for which you want to specify field selection criteria.

*selection\_criteria*

Field selection criteria for the *segname* segment. Determines which segment occurrences are retrieved by calls to the GETIMS function with the USING\_VIEW parameter.

*tpldd*

The DDNAME containing the template data set that is used as a basis to create a view. The template for the DBD must have already been created online in FM/IMS.

*tpldsn*

The name of the data set containing the template that is used as a basis to create a view. The template for the DBD must have already been created on-line in FM/IMS.

*viewdd*

The DDNAME containing one of the following:

- The sequential data set containing the view.
- The PDS containing the view. You then specify the member name in *viewmem*.

*viewsdn*

One of:

- The name of the sequential data set containing the view.
- The name of the PDS containing the view. (You then specify the member name in *viewmem*.)

*viewmem*

The member name of the view.



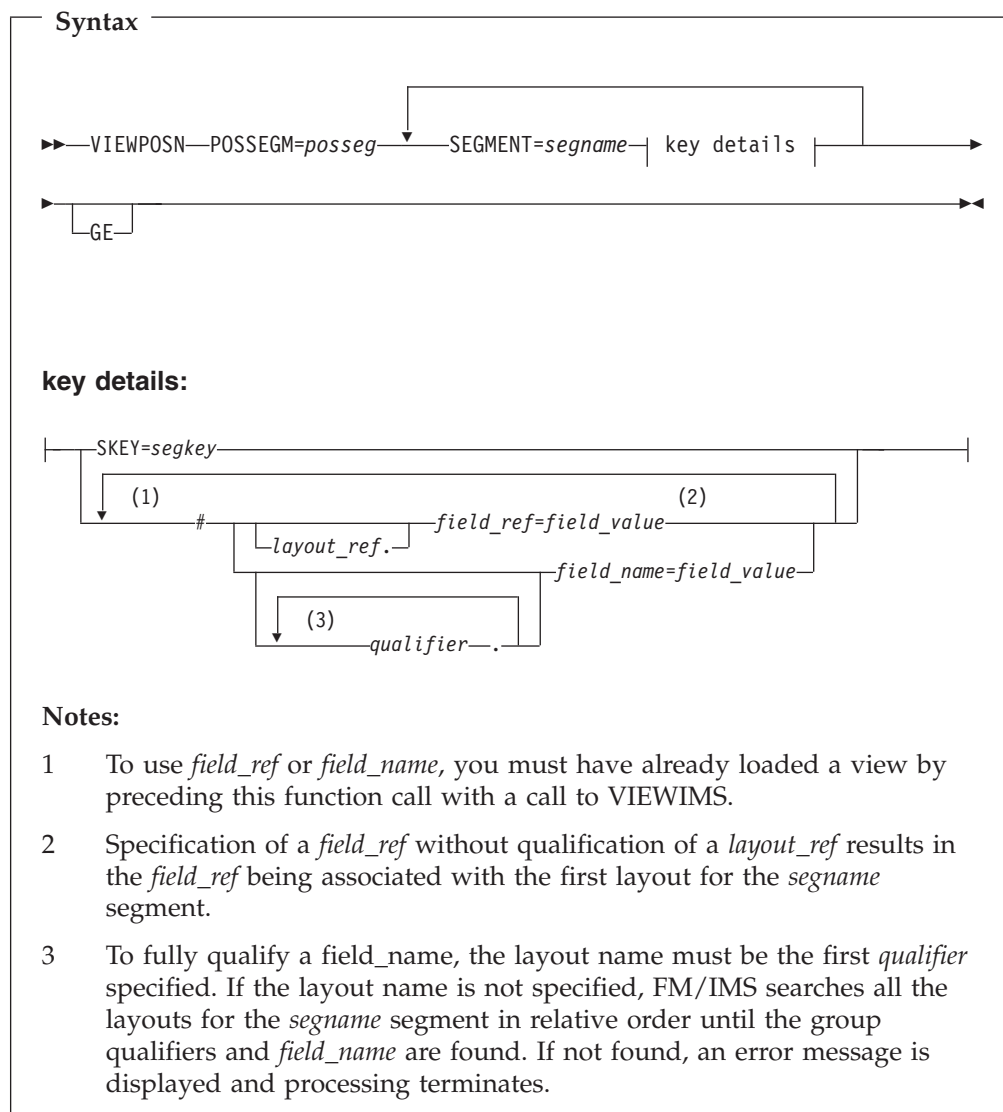

*field\_name*

A field name.

*field\_ref*

A field reference number of the field within the layout. This can be obtained by printing the view/template using the VIEWWIMS DESCRIBE clause or browsing the view/template online.

*field\_value*

The value of the field specified by *field\_ref* or *field\_name*.

*layout\_ref*

The relative number of layout within a segment. This can be obtained by printing the view/template using the VIEWWIMS DESCRIBE clause.

*posseg*

The name of the segment you want to position on.

*qualifier*

One or more qualifiers that identify the field name (*field\_name*). The first qualifier is the segment layout name. Subsequent qualifiers (if any) are the

group fields used to identify the specified field name. Omitting the layout name or group fields causes FM/IMS to search the segment layouts for the specified qualifiers and field name.

**Note:** The layout names and group fields can be obtained by printing the view/template using the VIEWIMS DESCRIBE clause or browsing the view/template online.

*segname*

The name of a segment in the hierarchical path of the segment you want to position on.

**Chapter 11, "Batch Reference", subsection "Batch Edit (IEB)", "Retrieval without a view"**

Replace these syntax diagrams and the description of parameters that follow each diagram:

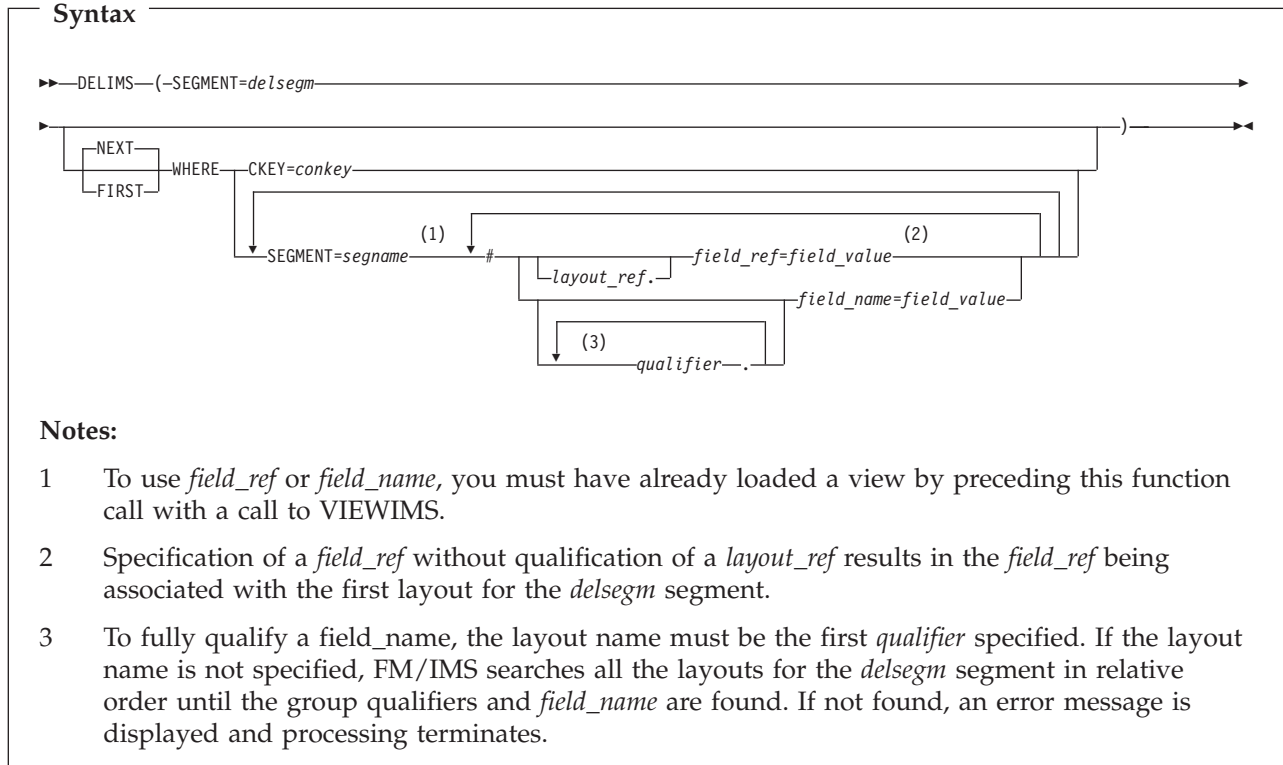

*conkey* The concatenated key of the segment you want to delete.

If you specify the concatenated key of a segment that you have already deleted, then DELIMS produces a nonzero return code, and does not delete any segment.

*delsegm*

The name of the segment you want to delete.

*field\_name*

The name of a key field in the *segname* segment, as specified in the template or view.

*field\_ref*

The reference number of a key field in the *segname* segment, as specified in

the template or view. This can be obtained by printing the view/template using the VIEWIMS DESCRIBE clause or browsing the view/template online.

*field\_value*

The value of the key field specified by *field\_ref* or *field\_name*.

**FIRST** Deletes the first segment in the database that satisfies the WHERE clause.

*layout\_ref*

The relative number of layout within *segname* segment. This can be obtained by printing the view/template using the VIEWIMS DESCRIBE clause.

**NEXT** Deletes the next segment in the database after the current segment that satisfies the WHERE clause.

*qualifier*

One or more qualifiers that identify the field name (*field\_name*). The first qualifier is the segment layout name. Subsequent qualifiers (if any) are the group fields used to identify the specified field name. Omitting the layout name or group fields causes FM/IMS to search the segment layouts for the specified qualifiers and field name.

**Note:** The layout names and group fields can be obtained by printing the view/template using the VIEWIMS DESCRIBE clause or browsing the view/template online.

*segname*

The name of a segment in the hierarchical path of the segment that you want to delete.

**Syntax (without a view)**

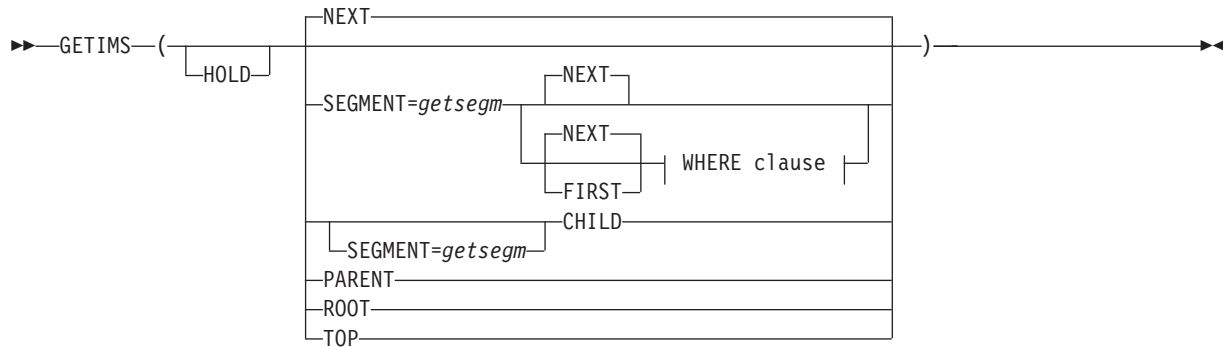

**WHERE clause:**

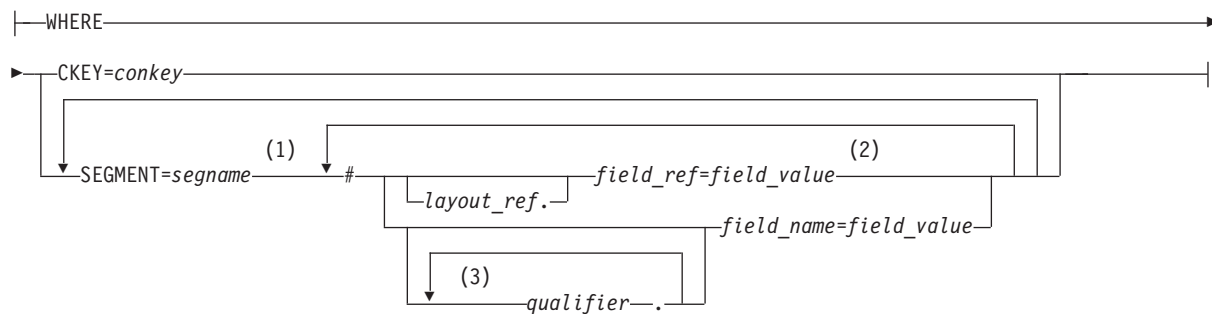

**Notes:**

- 1 To use *field\_ref* or *field\_name*, you must have already loaded a view by preceding this function call with a call to VIEWIMS.
- 2 Specification of a *field\_ref* without qualification of a *layout\_ref* results in the *field\_ref* being associated with the first layout for the *segname* segment.
- 3 To fully qualify a *field\_name*, the layout name must be the first *qualifier* specified. If the layout name is not specified, FM/IMS searches all the layouts for the *segname* segment in relative order until the group qualifiers and *field\_name* are found. If not found, an error message is displayed and processing terminates.

**CHILD**

Retrieves the next segment in the hierarchical path of the current segment. If you also specify *SEGMENT=getsegm*, then GETIMS retrieves the next segment of that name in the hierarchical path of the current segment.

*conkey* The concatenated key of the segment you want to retrieve.

*field\_name*

The name of a key field in the *segname* segment, as specified in the template or view. This can be obtained by printing the view/template using the VIEWIMS DESCRIBE clause or browsing the view/template online.

*field\_ref*

A field reference number of the field within the layout. This can be

obtained by printing the view/template using the VIEWIMS DESCRIBE clause or browsing the view/template online.

*field\_value*

The value of the key field specified by *field\_ref* or *field\_name*.

**FIRST** Retrieves the first segment in the database that satisfies the WHERE clause.

*getsegm*

The name of the segment you want to retrieve. If you also specify CHILD, then GETIMS retrieves the next hierarchically dependent segment with this name. Otherwise, the default value is NEXT, and GETIMS retrieves the next segment with this name, regardless of hierarchy.

**HOLD**

Retrieves the segment with a hold. Code this parameter when the GETIMS call is followed by a REPLIMS call without a WHERE clause, or a DELIMS call without a WHERE clause.

If the segment or one of its parents has a nonunique key or no key, this parameter is mandatory. Without it, the REPLIMS call or DELIMS call fails. The REPLIMS call or DELIMS call will not fail if the segment and its parents have unique keys but, if you do code it, your EXEC executes less DL/I calls and runs more efficiently.

*layout\_ref*

The relative number of layout within *segname* segment. This can be obtained by printing the view/template using the VIEWIMS DESCRIBE clause.

**NEXT** Retrieves the next segment in the database after the current segment.

**PARENT**

Retrieves the parent segment of the current segment.

If the current segment is a root segment, then GETIMS retrieves that same segment. To avoid looping in this situation, you can use the FMSEGNM REXX variable to check the name of the current segment.

*qualifier*

One or more qualifiers that identify the field name (*field\_name*). The first qualifier is the segment layout name. Subsequent qualifiers (if any) are the group fields used to identify the specified field name. Omitting the layout name or group fields causes FM/IMS to search the segment layouts for the specified qualifiers and field name.

**Note:** The layout names and group fields can be obtained by printing the view/template using the VIEWIMS DESCRIBE clause or browsing the view/template online.

**ROOT**

Retrieves the root segment in the hierarchical path of the current segment.

*segname*

The name of a segment in the hierarchical path of the segment that you want to retrieve.

**TOP** Retrieves the first root segment in the database.

**Syntax**

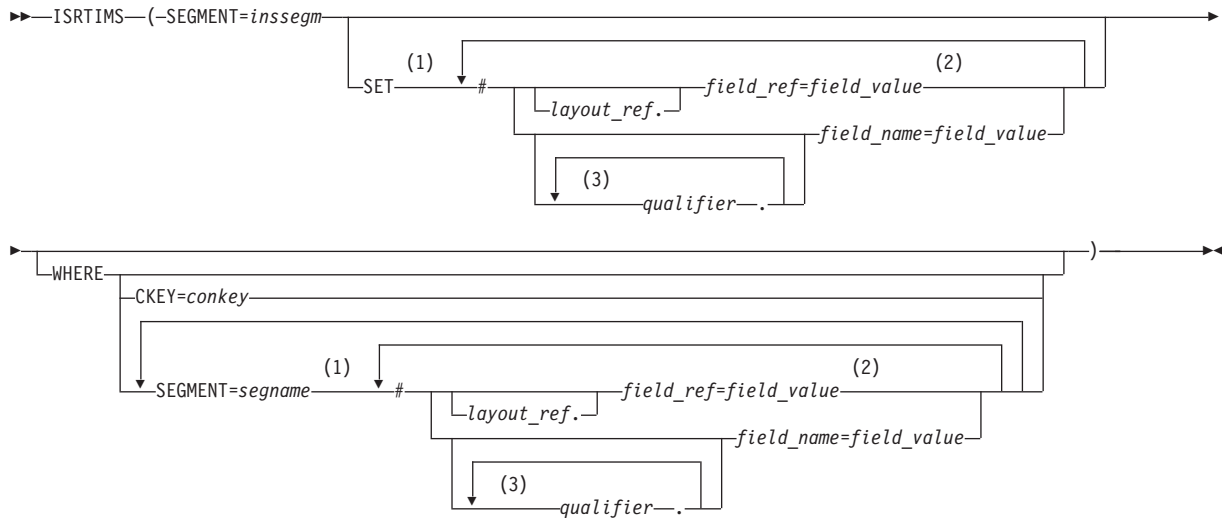

**Notes:**

- 1 To use *field\_ref* or *field\_name*, you must have already loaded a view by preceding this function call with a call to VIEWIMS.
- 2 Specification of a *field\_ref* without qualification of a *layout\_ref* results in the *field\_ref* being associated with the first layout for the *inssegm* segment if specified on the SET clause, or the *segname* segment if specified on the WHERE clause.
- 3 To fully qualify a *field\_name*, the layout name must be the first *qualifier* specified. If the layout name is not specified, FM/IMS searches all the layouts for the segment in relative order until the group qualifiers and *field\_name* are found. If not found, an error message is displayed and processing terminates.

*conkey* The concatenated key of the parent of the segment you want to insert.

*field\_name*  
A field name.

*field\_ref*  
A field reference number of the field within the layout. This can be obtained by printing the view/template using the VIEWIMS DESCRIBE clause or browsing the view/template online.

*field\_value*  
The value of the field specified by *field\_ref* or *field\_name*.

*inssegm*  
The name of the segment you want to insert. This must be a child of the segment that you specify in the WHERE clause, or, if you omit the WHERE clause, a child of the current segment.

*layout\_ref*  
The relative number of layout within *segname* segment. This can be obtained by printing the view/template using the VIEWIMS DESCRIBE clause.

*qualifier*

One or more qualifiers that identify the field name (*field\_name*). The first qualifier is the segment layout name. Subsequent qualifiers (if any) are the group fields used to identify the specified field name. Omitting the layout name or group fields causes FM/IMS to search the segment layouts for the specified qualifiers and field name.

**Note:** The layout names and group fields can be obtained by printing the view/template using the VIEWIMS DESCRIBE clause or browsing the view/template online.

*segname*

The name of a segment in the hierarchical path of the parent of the segment that you want to insert.

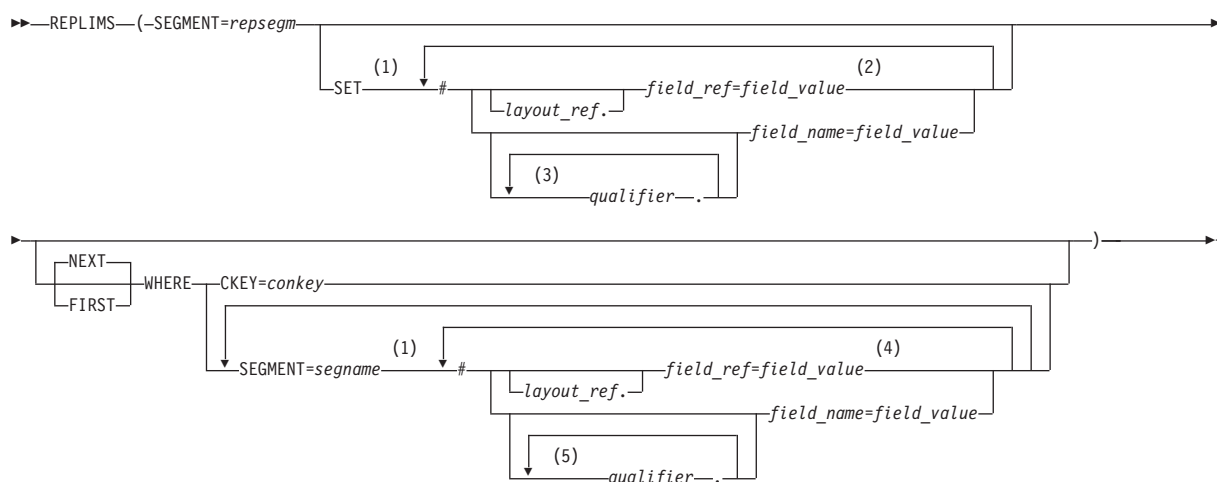
**Syntax****Notes:**

- 1 To use *field\_ref* or *field\_name*, you must have already loaded a view by preceding this function call with a call to VIEWIMS.
- 2 Specification of a *field\_ref* without qualification of a *layout\_ref* results in the *field\_ref* being associated with the current layout for the *repsegm* segment that is being replaced
- 3 To fully qualify a field name, the layout name must be the first *qualifier* specified. If the layout name is not specified, FM/IMS searches the current the layout for the *repsegm* segment being replaced. If the group qualifiers and field name are not found, FM/IMS searches all the layouts for the *repsegm* segment in relative order until the group qualifiers and field name are found. If not found, an error message is displayed and processing terminates.
- 4 Specification of a *field\_ref* without qualification of a *layout\_ref* results in the *field\_ref* being associated with the first layout for the *segname* segment.
- 5 To fully qualify a field name, the layout name must be the first *qualifier* specified. If the layout name is not specified, FM/IMS searches all the layouts for the *segname* segment in relative order until the group qualifiers and field name are found. If not found, an error message is displayed and processing terminates.

*conkey* The concatenated key of the segment you want to update.

*field\_name* A field name.

<i>field_ref</i>	A field reference number of the field within the layout. This can be obtained by printing the view/template using the VIEWIMS DESCRIBE clause or browsing the view/template online.
<i>field_value</i>	The value of the field specified by <i>field_ref</i> or <i>field_name</i> .
<b>FIRST</b>	Replaces the first segment in the database that satisfies the WHERE clause.
<i>layout_ref</i>	The relative number of layout within <i>segname</i> segment. This can be obtained by printing the view/template using the VIEWIMS DESCRIBE clause.
<b>NEXT</b>	Replaces the next segment in the database after the current segment that satisfies the WHERE clause.
<i>qualifier</i>	<p>One or more qualifiers that identify the field name (<i>field_name</i>). The first qualifier is the segment layout name. Subsequent qualifiers (if any) are the group fields used to identify the specified field name.</p> <p>Omitting the layout name or group fields causes FM/IMS:</p> <ul style="list-style-type: none"> <li>• For the SET clause, to search the current <i>repsegm</i> segment layout for the specified qualifiers and field name. If not found, then all <i>repsegm</i> segment layouts are searched for the specified qualifiers and field name.</li> <li>• For the WHERE clause, to search all the <i>segname</i> segment layouts for the specified qualifiers and field name.</li> </ul> <p><b>Note:</b> The layout names and group fields can be obtained by printing the view/template using the VIEWIMS DESCRIBE clause or browsing the view/template online.</p>
<i>repsegm</i>	The name of the segment you want to update.
<i>segname</i>	The name of a segment in the hierarchical path of the segment that you want to update.



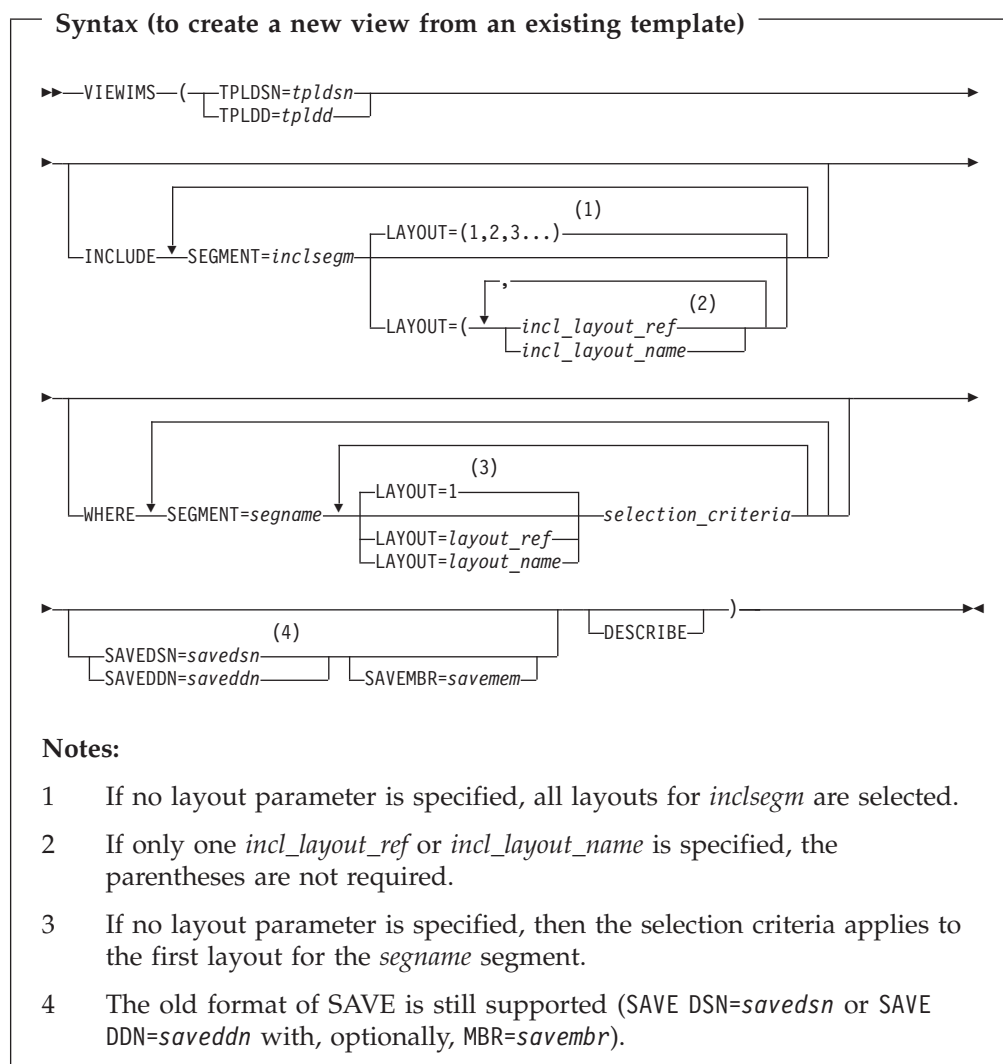

If you specify the DESCRIBE parameter, then VIEWIMS prints a report showing the structure of the view or template for each segment in the database.

#### *incl\_layout\_name*

The name of the *inclsegm* segment layout to be selected in the view. You can obtain this by printing the view/template with the VIEWIMS DESCRIBE clause or browsing the view/template online.

#### *incl\_layout\_ref*

The relative number of the layout within the *inclsegm* segment that is selected in the view. You can obtain this by printing the view/template with the VIEWIMS DESCRIBE clause.

#### *inclsegm*

The name of a segment to be included in the view.

If you call the GETIMS function with the USING\_VIEW parameter, then only the included in the view is retrieved.

However, if you omit the INCLUDE clause entirely, then all segments are included in the view.

*layout\_name*

The name of the layout within the *segname* segment to which the selection criteria are to apply. This can be obtained by printing the view/template using the VIEWIMS clause or browsing the view/template online.

*layout\_ref*

The relative number of the layout within a segment to which the selection criteria are to apply. This can be obtained by printing the view/template using the VIEWIMS DESCRIBE clause.

*savедdn*

The DDNAME containing the data set into which the view is to be saved. If the data set is a PDS, you must also specify the SAVEMBR=*savemem* parameter.

*savedsn*

The name of the data set into which the view is to be saved. If the data set is a PDS, you must also specify the MBR=*savemem* parameter.

*savemem*

The member of the PDS specified by the DSN, SAVEDSN, DDN, or SAVEDDN parameter into which the view is to be saved.

*segname*

The name of a segment for which you want to specify field selection criteria.

*selection\_criteria*

Field selection criteria for the *segname* segment. Determines which segment occurrences are retrieved by calls to the GETIMS function with the USING\_VIEW parameter.

*tpldd*

The DDNAME containing the template data set that is used as a basis to create a view. The template for the DBD must have already been created on-line in FM/IMS.

*tpldsn*

The name of the data set containing the template that is used as a basis to create a view. The template for the DBD must have already been created on-line in FM/IMS.

*viewdd*

The DDNAME containing one of the following:

- The sequential data set containing the view.
- The PDS containing the view. You then specify the member name in *viewmem*.

*viewdsn*

One of:

- The name of the sequential data set containing the view.
- The name of the PDS containing the view. (You then specify the member name in *viewmem*.)

*viewmem*

The member name of the view.

## PK68098

### Initial problem description

An improper message may be displayed while inserting new IMS segments.

2. Load module compare prints incorrect output for DATE and MODE options.
3. Base audit report does not contain any template information.
4. 'Additional print options' panel not displayed when option selected on 'Print Temporary Storage Entry' panel.
5. When PDS and nonPDS datasets are included as input to batch DSC, DSP or FCH functions job may terminate with RC=16 and no message to indicate what the error is.
6. File Manager will abend S978 when using the DSC utility to generate a batch job using a member selection list to identify the member to be copied.
7. If a copybook is used when comparing data sets and the copybook contains multiple record definitions with no selection criteria only the first record in the copybook is being used when comparing record lengths for a match.
8. When browsing the compile listing after an error under FM/CICS the the message 'Value out of range' is produced and scrolling is not possible.
9. Template edit is not detecting a change when a scrambling value list has been deleted.
10. Workbench copybook member name being incorrectly updated with member name provided in data set name field after a CC command.
11. ABENDS978-04 running template build utility with batch execution.
12. When a start key is entered on the Data Set Print utility entry panel for a NONVSAM data set the message 'Must be record number' is displayed on the cursor is position on the command line.
13. The pulldown option is not protected when in the Temporary and Output Data Set Allocation option panels.
14. The Print Audit Trail Report may abends0c4 when an incomplete audit log data set is provided as input.
15. Select command requires extra enter when selecting single member.
16. IMS segment length changes via the length field are not honored during an insert or repeat.
17. ABENDSOC4 running a procedure with TFLD function and no template.
18. The member name field is not being cleared on the 'Advanced Member Selection' panel when it is cleared on the previous panel.
19. File Manager CICS may abends0c4 when first started.
20. An expanding change for a variable length record may incorrectly retain trailing blanks.
21. The 'sorted by' field on the 'Display VTOC' panels may be incorrectly interpreted when abbreviated.
22. If a column range is specified when using the Find/Change utility to change JCL the from column is being ignored.
23. The PARM parameter may be split incorrectly causing invalid JCL to be generated when a JCL statement is changed using the Find/Change utility.

24. When using the FCH utility and the length of 'change to' value is longer than the length of the 'change from' value and the JCL option has been selected changes will not be made to statements other than JCL statements.

25. When using the FCH function in batch with multiple Change commands supplied and these commands include a column range the column range may not be honoured.

26. When using the FCH utility and the length of the 'change to' value is longer than the length of the 'change from' value and the JCL option has been selected, changes will not be made to statements other than JCL statements.

27. When using the edit or browse function and the 'Edit Template' option has been selected and the template contains long names File Manager may abendS0C4.

28. When using the Find/Change utility to change JCL and a trailing space is specified in the Change command no match will be found because trailing spaces are not included in the logical JCL statement built by File Manager. The same problem would occur for the Find command.

29. The Find/Change utility does not recognize the VCONTEXT command when the JCL option has been selected.

30. When using a formatted compare numeric fields which have the same attributes but do not contain valid numeric data are being flagged as invalid and are not compared.

31. File Manager is not including invalid data fields as unmatched when the 'Changed data only' only option has been selected.

32. File Manager may ABEND0C4 when comparing data sets using templates and the old template contains more record definitions than the new template(PFM03312).

33. Unmatched numeric fields are not being reported when comparing data sets using a template.

34. XML tag </RECORD> in wrong position.

35. In FM/DB2 Object List utility, when listing plans and issuing the prefix command RBI against a plan and entering a '?' in the PKLIST field an ISPF Dialog Error occurs.

36. The fields CACHE and ACQUIRE are incorrectly populated in the DB2 'Bind Application Plan' panel.

37. Compare utility may abends0c4 when comparing multiple members of PDSs or PDSEs.

38. Compare utility may abends978 when the 'Batch execution' option has been selected and the old data set is a PDS or PDSE and a member mask is specified.

#### Outline of solution

File Manager has been updated such that:

1. Navigation is not attempted during an IMS insert operation.
2. DATE and MODE in the CSECTC or LMODC parameters now produce the correct output.
3. Template information, if it exists, is now printed on first page of the Detailed Statistics and on the Summary Statistics page.

4. The 'Additional print options' panel will be displayed when the option is selected on the 'Print Temporary Storage Entry' panel.
5. When processing a concatenated data set File Manager will check to see that the data set organisations are the same.
6. File Manager will not abend when requested to generate a batch job when using the DSC utility with a member selection list.
7. File Manager will check all records in the copybook when selecting records.
8. The insert record length will not be displayed as zero under CICS when a browse listing function is running.
9. The removal of value lists will be detected as a template change when editing the scrambling attributes.
10. Fix copybook member name updating to correctly check data set name for member before updating.
11. Freemain for selection list has been corrected.
12. The File Manager utilities print, copy and compare will not accept a Start key value when processing a nonvsam data set.
13. The correct pulldown option will be protect when in the Base and DB2 Temporary and Output Data Set Allocation option panels.
14. File Manager will not abend when producing an Audit Trail Report from an incomplete audit log file.
15. When selecting a single member off a list hold processing will not apply.
16. The IMS segment header (for variable length IMS segments) will be correctly updated, honoring the length field update.
17. TFLD function corrected to check for template existence.
18. The member name field in the 'Advanced Member Selection' panel will be cleared if no member name was supplied on the previous panel.
19. File Manager CICS will not abend when initially started.
20. A record wide change command that potentially expands a variable length record with trailing blanks will consider the trailing blanks before setting the new record length.
21. The minimum length of some 'sorted by' values on the 'Display VTOC' panels has been increased to ensure the correct value is selected when an alternate value has been entered.
22. The from column will be taken into consideration when finding/changing non-JCL records when the JCL option has been selected.
- 23a. If a PARM statement is enclosed in quotes and there are multiple quoted parameters separated by a comma and the statement needs to be continued, the parameters after the comma will be continued on a second JCL record.
- 23b. If there is more than one keyword on the last record of a changed JCL statement and the record has been expanded and will no longer fit into one record, the record will be split on the last keyword.
24. File Manager has been updated in order to correctly calculate the to column for non JCL statements, when the JCL option is selected.

- 25.The column range supplied with batch Change commands will be honoured.
- 26.File Manager has been updated in order to correctly calculate the column for non JCL statements, when the JCL option is selected.
- 27.File Manager will no longer abends0c4 when editing a DB2 table containing containing a number of long names.
- 28.Trailing spaces will be included in the logical JCL statement against which the Find or Change parameter is compared. Note that this occurs only for the last statement of a (continued or single) JCL statement. Trailing spaces in other statements forming part of a continued JCL statement continue to be ignored (they are not part of the logical JCL statement).
- 29.The VCONTEXT command parameters will be taken into consideration when producing the Find/Change utility report and the LIST=LONG and JCL options have been specified.
- 30.When using a formatted compare numeric fields which have the same attributes will be compared as character strings. This prevents fields with the same underlying data from flagging the record as containing invalid data.
- 31.File Manager will include invalid data fields in the unmatched report when the 'Changed data only' only option has been selected. 32.The 01 level comparison loop has been corrected.
- 33.File Manager will report unmatched numeric fields when data sets are compared using a template.
- 34.XML output has been corrected.
- 35-36. File Manager DB2 component has been changed to correct the problems.
- 37.The Compare utility will no longer abends0c4 when comparing members in PDSs or PDSEs.
- 38.The Compare utility will no longer abends978 when comparing members in PDSs or PDSEs.

#### Documentation impact

This APAR requires changes to be made to the User's Guide and Reference (SC19-1239-00).

## Changes to the User's Guide and Reference

### Chapter 15, "Panels and fields"

In the section "Compare Utility: Options panel", replace the existing description for the **Always show SELECTed fields** option to:

#### Always show SELECTed fields

Specify / to show SELECTed fields in formatted comparison reports. The option is intended to allow you to ensure that certain fields that you have SELECTed are always printed, regardless of whether they are changed or not. This option has effect only if the **Show changed fields only** option has been selected and only if the SELECTed fields have been mapped.

---

**PK70108****Initial problem description**

1. If a column range is specified when using the Find/Change utility to change JCL the from column is being ignored.
2. The PARM parameter may be split incorrectly causing invalid JCL to be generated when a JCL statement is changed using the Find/Change utility.
3. When using the FCH utility and the length of 'change to' value is longer than the length of the 'change from' value and the JCL option has been selected changes will not be made to statements other than JCL statements.
4. When using the Find/Change utility to change JCL and a trailing space is specified in the Change command no match will be found because trailing spaces are not included in the logical JCL statement built by File Manager. The same problem would occur for the Find command.
5. The Find/Change utility does not recognize the VCONTEXT command when the JCL option has been selected.

**Outline of solution**

1. The starting position to be used when finding/changing data records when the JCL option has been specified was not including the starting column if specified.
2. If the last record of a continued changed JCL statement will not fit in the space provided it is always being continued following the JCL continuation guidelines, which may lead to undesired results when substitution variables are present.
3. The wrong to column was being calculated. The routine FMNCHJCL appends a character to the JCL string and this character was being included in the to column calculation.
4. Trailing spaces are not included in the logical JCL statement against which the Find or Change parameter is compared.
5. The VCONTEXT command is ignored when THE JCL option has been selected.

**Documentation impact**

This APAR requires changes to be made to the User's Guide and Reference (SC19-1037-00).

**Changes to the User's Guide and Reference****Chapter 7, "Managing data sets"**

In the section, "Working with files or members containing JCL", change the definition for *Parameter part* to:

*Parameter part*

Contains the contents of the first character after the *name part*, including any blanks after the last character of the *parameter part*.





# UK34896, UK34897, UK34898, UK34899, UK34900, UK34901, UK34902, UK34903, UK34904, UK34905

Release Date: 2 April 2008

This set of PTFs contains the following APAR fixes:

APAR #	APAR Abstract	Doc Impact
PK59006	Compare incorrectly flags all records as being changed.	None.
PK59123	Generated JCL from template update utility is incorrect.	None.
PK59763	Inplace edit of NONVSAM data set with pad on corrupts data.	None.
PK60382	Trying to view database in FM/IMS with 2 DBD libs, results in error.	None.
PK60482	Unable to open a VSAM file under FM/CICS When file is in a different region.	None.
PK60486	Using FM 3.5 on indirect cataloged datasets results in S0C4.	None.
PK60551	File Manager DDNAME FMNIN not freed by PL/I compiler.	None.
PK60566	Comparing arrays of different sizes, an incorrect number of array elements may be reported.	None.
PK60568	FM getting 878-10 abend trying to browse a large file.	None.
PK60896	Inconsistent behaviour for Preserve copybook library option.	User's Guide and Reference (SC19-1037-00) User's Guide and Reference for IMS (SC19-1039-01)
PK61212	Unable to edit a VSAM file w/alternate index in FM/CICS unless file defined with add and delete attributes.	None.
PK61279	File Manager Korean cumulative service Q1 2008.	None.
PK61594	Corrupted data is displayed on a help panel "FMNRFCP1(Japanese) for FIND/CHANGE utility FIND command.	None.

**Initial problem description**

1. The Preserve copybook library option and Use library data sets option are both being ignored when a template is updated from the member list with File Manager base Option 7.4.
2. The Preserve copybook library option and Specify library data sets option are both being ignored when a template is updated from the member list with File Manager/IMS Option 4.4.
3. The Override compiler options on the Compiler Language Selection panel is not persistent.

**Outline of solution**

The interactive interface for template update will now honor the Preserve copybook library and Use library data sets options when invoked from option 7.4.

For IMS, the interactive interface will honor the Preserve copybook library and Specify library data sets options when invoked from option 4.4.

The Preserve copybook library option will be able to be set from the Compiler language selection options panel to make it generally available to control the behaviour of the template update when invoked from places other than the template update utility.

All values on the Compiler language selection panel will persist after being set.

**Documentation impact**

This APAR requires changes to be made to:

- User's Guide and Reference (SC19-1037-00)
- User's Guide and Reference for IMS (SC19-1039-01)

## Changes to the User's Guide

**Chapter 4, "Creating and editing templates"**

In the section "Managing templates", subsection "Setting your template processing options", after subsection "Overriding Compiler options", add this new subsection:

**Determining the search order for your copybooks**

The **Preserve copybook library** option allows you to determine the search order File Manager uses when looking for a specified copybook.

To determine the search order for your copybooks:

1. Select the **Compiler Language Selection** option from the **Options** pull-down menu.

File Manager displays the Compiler Language Selection pull-down menu.

2. Select the **Preserve copybook library** option.

Selecting this option causes the template update to attempt to locate the copybook in the data set in which it was originally found.

Not selecting this option, or if the copybook cannot be located, causes the template update to search the library data sets in order for the first occurrence of the copybook.

The option only applies to template update.

You can also access the **Preserve copybook library** option on the Compiler Language Selection panel.

### Chapter 15, "Panels and fields"

In the section "Compiler Language Selection panel":

- Replace the existing screen capture with:

```

Process  Options  Help
-----
File Manager          Compiler Language Selection

Language Selection:
Specify Default Compiler
1  1. COBOL           Use the COBOL compiler
   2. PL/I            Use the PL/I compiler
   3. Auto detect     Determine which compiler to use.

Processing Options:
Enter "/" to select option
_  Override compiler options for template update
_  Preserve copybook library

Command ==>
F1=Help   F2=Split   F3=Exit   F4=CRetrieve F7=Backward F8=Forward
F9=Swap   F10=Actions F12=Cancel

```

Figure 1. Compiler Language Selection

- After the description for the processing option **Override compiler options for template update**, add:

#### **Preserve copybook library**

Ensures that, if a copybook still exists in the library that it was previously found in and that library is in the list that the update is using, then that version of the copybook is used if:

- This option is not selected, or
- The copybook no longer exists in the library it was previously found in, or
- That library is not in the list the update is using then the utility searches the libraries in the order they are listed and uses the first version of the copybook that it finds.

## Changes to the User's Guide and Reference for IMS

### Chapter 9, "Panels and fields"

In the section "Compiler Language Selection panel":

- Replace the existing screen capture with:

```

Process  Options  Help
-----
FM/IMS                               Compiler Language Selection

Language Selection:
Specify Default Compiler
 3 1. COBOL           Use the COBOL compiler
 2. PL/I             Use the PL/I compiler
 3. Auto detect      Determine which compiler to use.

Processing Options:
Enter "/" to select option
_ Override compiler options for template update
_ Preserve copybook library

Command ==>
F1=Help   F2=Split   F3=Exit   F4=CRetriev  F7=Backward  F8=Forward
F9=Swap   F10=Actions F12=Cancel

```

Figure 2. Compiler Language Selection panel

- After the description for the processing option **Override compiler options for template update**, add“:

**Preserve copybook library**

Ensures that, if a copybook still exists in the library that it was previously found in and that library is in the list that the update is using, then that version of the copybook is used if:

- This option is not selected, or
- The copybook no longer exists in the library it was previously found in, or
- That library is not in the list the update is using then the utility searches the libraries in the order they are listed and uses the first version of the copybook that it finds.

---

## PK55097

Release Date: **1 April 2008**

APAR PK55097:

Change to the following document:

- User's Guide and Reference for DB2 Data (SC19-1038-01)

Replace Chapter 18 of this document with the following chapter:



---

## UK31651, UK31652, UK31653, UK31654, UK31655, UK31656, UK31657, UK31658, UK31659, UK31660, UK31661, UK31662

Release Date: 3 December 2007

This set of PTFs contains the following APAR fixes:

APAR #	APAR Abstract	Doc Impact
PK53815	File Manager Korean cumulative service Q4 2007.	None.
PK54187	Japanese characters are garbaged in panel FMNSHFS.	None.
PK54911	Using a CHANGE primary command with a null search string does not work as documented.	None.
PK55164	Entering a long DSN in File Manager 3.5 results in no entry found.	User's Guide and Reference (SC19-1037-00)
PK56128	File Manager view load module information is incorrect.	None.
PK56241	FM/MVS abend S0C4-11 FMNMAIN FMNEDIT X'1950'.	None.
PK56250	When using a template with multiple record types, the CEDIT function is not working as expected.	None.

---

### PK55164

#### Initial problem description

1. No data sets found error may be reported by 3.5 DVT when specifying a dataset with a name of exactly 44 characters.
2. File Manager may abend0C4 S0C4 when I EB used to process a stopped DEDB area or an unavailable partition (PFM02738).
3. Start, Length and Offset values may get truncated on template related panels and printouts (PFM03159).
4. Overriding start position positioning from "Record Sampling" panel does not work correctly in Editor (PFM03169).
5. LOCATE PREV command in Editor SNGL view may cause an abend S0C4 abend0C4 (PFM03243).
6. VSAM data set rename lacks simplicity (PFM03248).

#### Outline of solution

- 1/2/4/5. Program logic has been corrected.

- 3. File Manager will be enhanced to support values up to 10 digits.
- 6. File Manager is being enhanced to introduce a dedicated VSAM data set RENAME function.

**Documentation impact**

- This APAR requires changes to be made to:
- User’s Guide and Reference (SC19-1037-00)

## Changes to the User’s Guide and Reference

### Chapter 8, Using File Manager Utilities

In the section, "Managing Catalog Entries", subsection "Altering an existing Catalog Entry":

Add after step #2:

"To rename a VSAM data set (CLUSTER and its corresponding components), enter REN(ame) in the line command field adjacent to the entry you want to change. A VSAM Entry Rename panel for the data type of your data set is displayed, showing the data set information that can be changed. The component names of a VSAM CLUSTER are adjusted based on the newly-entered data set name as outlined further on in this section. If you require a finer degree of control over the component names, then use the ALTER command to adjust component names manually. To change any additional VSAM parameters, use the ALTER command as described further on in this section."

### Chapter 14, Panels and fields

- Add the new **VSAM Entry Rename** panel as pictured here:

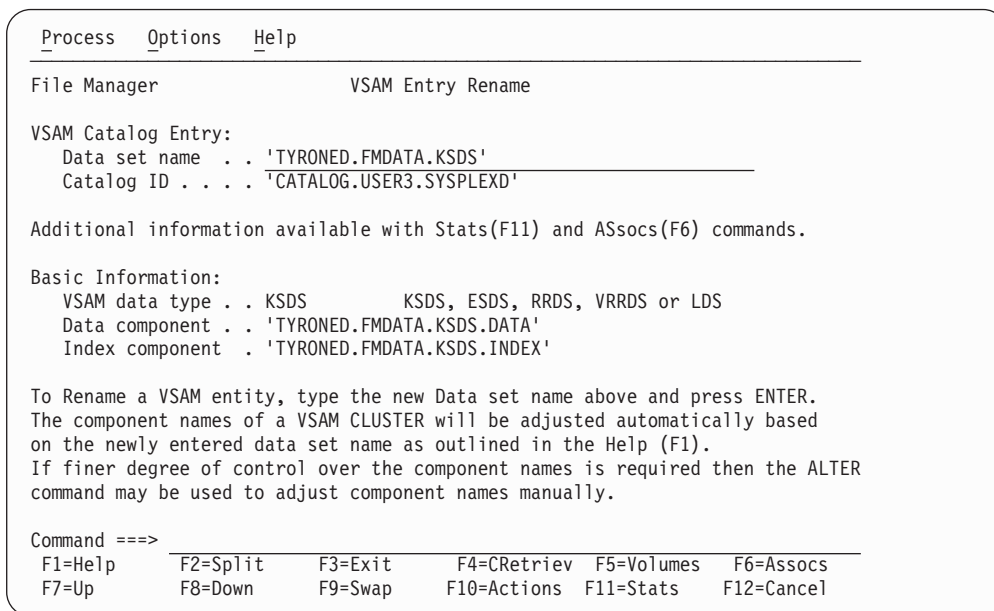

Figure 3. VSAM Entry Renamepanel

Parent panels:

- Catalog Services Data Set list panel
- Display VTOC Data Set List panel

Related tasks and examples:

- Managing Catalog Entries



- **Display VTOC Data Set List panel:**

In the section, "Available commands", replace **RENAME (R)** and its description with:

**RENAME (REN)**

This is a synonym for Alter with non-VSAM data sets and it works identically. For VSAM data sets it invokes a separate VSAM Entry Rename panel.

- **Catalog Services: Data Set List panel:**

- Add:

**RENAME (REN)**

This is a synonym for Alter with non-VSAM data sets and it works identically. For VSAM data sets it invokes a separate VSAM Entry Rename panel.

- Change **RECALL (R)** to **RECALL (REC)**.



---

# UK28623, UK28624, UK28625, UK28626, UK28627, UK28628, UK28629, UK28630, UK28631, UK28632

Release Date: 31 August 2007

This set of PTFs contains the following APAR fixes:

APAR #	APAR Abstract	Doc Impact
PK45233	FM/DB2 7.1 UNLOAD utility generates an incorrect template.	User's Guide and Reference for DB2 Data (SC19-1038-01)

---

## PK45233

### Initial problem description

The File Manager utilities option (3.9) generates an incorrect File Manager template when generating control statements for the DB2 UNLOAD utility under some circumstances.

### Outline of solution

File Manager DB2 component has been updated to correct the problem. If the DB2 UNLOAD utility NOPAD option is selected, FM/DB2 will not attempt to create a template that describes the output from the DB2 UNLOAD utility.

### Documentation impact

This APAR requires changes to be made to the User's Guide and Reference (SC18-9655-01).

## Changes to the User's Guide and Reference for DB2 Data

### Chapter 12, "Generating batch JCL for DB2 utility jobs"

In the description for "UNLOAD (tables)", make the following changes:

- Replace:

"Create and save a COBOL or PL/I template that describes the unloaded data"  
with:

"Create and save a File Manager Base template that describes the unloaded data"

- Move existing item 8 to immediately after item 4 (item 8 becomes item 5).  
Renumber all subsequent items.

- Replace existing item 5 with the following:

"On the UNLOAD Utility "To" panel, specify the sequential data set that is the target of the unload by entering the 'To' data set details using the Data set name and, optionally, the Volume fields."

- Add the following at the end of item 6:

"The data format used by the DB2 UNLOAD utility is fixed. Therefore if you specify a copybook or template data set, the copybook or template should reflect the DB2 UNLOAD data format to avoid data mismatch problems."

(new paragraph)

"When a template is specified for the DB2 unload data set, it must be a File Manager Base template - a FM/DB2 template cannot be used."

(new paragraph)

"When the "allow padding" option is not selected on the DB2 UNLOAD utility options panel, FM/DB2 cannot generate a template that describes the unloaded data. In this situation all fields related to template processing are protected when the UNLOAD utility 'To' panel is displayed and the template usage option is set to 5 (NONE)."

- Add a new item (9) in place of item 8.

"You can review the DB2 UNLOAD options by selecting the "view UNLOAD options" field. No changes can be made when the DB2 UNLOAD utility options panel is displayed. To make changes return to the DB2 UNLOAD utility 'From' panel and select "edit UNLOAD options".

- Replace the Section headed "Mapping of the null indicator byte" with the following:

#### **Null indicator byte processing**

The DB2 UNLOAD utility data format uses a single byte for the DB2 null value, located immediately before the data for each nullable column, in the output data set. The value in this byte is set to x'00' if the column contains a value and x'FF' when the column contains the DB2 null value. The DB2 UNLOAD utility will automatically place the appropriate value in the null indicator byte in the output data set.

FM/DB2 will automatically generate a File Manager Base template when the template processing option is set to 3 or 4 on the "To" panel. This template will include field(s) for the null indicator byte(s) as appropriate.

When a copybook is used to describe the output data, FM/DB2 will attempt to generate a reasonable mapping between the template for the DB2 object and the template for the output data set. The data format used by the DB2 UNLOAD utility is fixed, therefore the data format described by the copybook should reflect this format, to avoid data mismatch problems.

The DB2 null indicator byte in a user-specified copybook is successfully mapped when:

- It immediately precedes a nonvarying target field, or precedes the length field of a varying target field.
- The null indicator byte does not overlap any field that has already been mapped.
- The field name for the null indicator byte contains "NULL". In this case, FM/DB2 documents the mapping as comments in the generated JCL for the DB2 UNLOAD utility.

Other types of mapping, or null indicator byte usage are not supported, including:

- A copybook that would map a nullable DB2 column to a data field without a null indicator byte.
- A copybook that would map a not-nullable DB2 column to a data field with a null indicator byte.
- A copybook that uses null indicator fields that are not one byte in length, or are not located immediately before the data for the column to which they pertain.

---

## UK27934, UK27939, UK27941, UK27939, UK27942

Release Date: 10 August 2007

This set of PTFs contains the following APAR fixes:

APAR #	APAR Abstract	Doc Impact
PK42421	FILE MANAGER internal changes to PL/I processing.	None
PK43403	FM/IMS GET NEXT failed.	None
PK46707	Error message is not removed from the FM/DB2 4.3 screen after correcting problem.	None
PK47749	FM/CICS fails trying to access a queue name consisting of unprintable hex values.	None
PK48755	FILE MANAGER inserting comment card for change command.	None
PK48836	FM/CICS provides no means to restrict access to the edit function of cics resources.	Customization Guide (SC19-1036-02)
PK48934	On the 'row selection criteria' panel, equals sign is missing.	None
PK49243	Enable ATTN for TSO command processing while displaying FM panel.	Customization Guide (SC19-1036-02)
PK49395	Incorrect or missing information in VTOC analysis for indirect and extended system VOLSERS.	None
PK49556	FM 3.5 VTOC display does not process storage groups correctly.	None
PK49576	CICS hangs after a browse/edit of CICS TD queue data.	None

---

### PK48836

#### Initial problem description

File Manager has no ability to secure the update functions in either the base product or FM/CICS.

#### Outline of solution

A new security installation option SEC, with a default value of NO allowing for backwards compatibility, has been implemented to allow users

to optionally secure the currently unprotected update functions in both File Manager Base and CICS, components.

**Documentation impact**

This APAR requires changes to be made to:

- Customization Guide (SC19-1036-02)

## Changes to the Customization Guide

### Appendix A, "File Manager options"

Add the following new option to this appendix:

SEC:

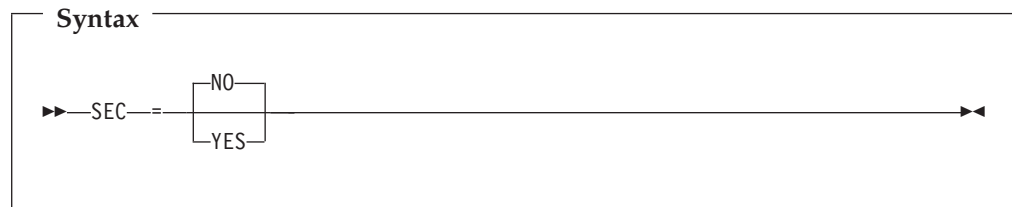

**SEC** specifies whether or not update functions are to be protected in File Manager base function or in File Manager/CICS.  
**NO** update functions are not protected.  
**YES** update functions can be protected.

**Note:** To protect update functions in File Manager base function set SEC=YES in FMN0POPT. To protect update functions in File Manager/CICS set SEC=YES in FMN3POPT. Setting this option in FMN2POPT has no effect in File Manager/DB2.

### Chapter 4, "Customizing the File Manager security environment"

Add the following to this chapter:

If FMN0POPT has been assembled with SEC=YES specified then the following functions will be protected by the new facility class, FILEM.BASE.UPDATE.

**DSC** Data set copy  
**DSE** Data set edit  
**DSEB** Data set edit batch  
**DSG** Data set create  
**DSU** Data set update  
**FCH** Find/Change (Note - only protected if function attempts update command)

The normal security checking of FILEM.FUNCTION.*function\_code* applies to the above functions when SEC=YES has been specified.

### Chapter 26, "Customizing the File Manager/CICS security environment"

Add the following to this chapter:

If FMN3POPT has been assembled with SEC=YES specified then the following functions will be protected by the new facility class, FILEM.CICS.UPDATE.

**CDE** CICS transient data edit  
**CFE** CICS file edit

CTE	CICS temporary storage edit
DSC	Data set copy
DSE	Data set edit
DSEB	Data set edit batch
DSG	Data set create
DSU	Data set update
FCH	Find/Change (Note - only protected if function attempts update command)

The normal security checking of FILEM.FUNCTION.*function\_code* applies to the above functions when SEC=YES has been specified.

---

## PK49243

### Changes to the Customization Guide

#### Chapter 25. "Customizing File Manager/CICS"

Section, "Customizing the batch procedure"

Add the following bullet to step 2, "Modify FMN3CICB in your library":

If the name of the TCP/IP address space is not the default value of 'TCPIP', uncomment the SYSTCPD DD statement and change *#tcpparms* to the data set and member name that contains the appropriate TCPIPJOBNAME parameter.





---

## UK26398, UK26399, UK26401, UK26402, UK26403, UK26404

Release Date: 2 July 2007

This set of PTFs contains the following APAR fixes:

APAR #	APAR Abstract	Doc Impact
PK45551	FM/CICS support for extended addressability ESDS within CICS.	User's Guide and Reference for CICS (SC19-1040-00)
PK45560	ISPF statistics of a member may get changed by DSU even if the member has not been actually updated.	None.

---

### PK45551

#### Initial problem description

1. CICS Transaction Server V3R2 introduces support for an extended format, extended addressing ESDS data set (or "extended ESDS") within CICS.
2. Key start position not allowed for paths defined to CICS.
3. ILLOGIC error condition raised when listing many resources from two or more interconnected CICS regions.
4. Insufficient error reporting when the CICS socket interface has not been started on the CICS region.
5. Inefficient use of internal buffer when listing CICS resources.

#### Outline of solution

1. FM/CICS has been enhanced to support extended ESDSs when running on CICS TS 3.2.
2. FM/CICS has been enhanced to allow key start positions for paths.
3. Internal logic error corrected.
4. A new error message will be issued when FM/CICS encounters an error during initialization due to the CICS socket interface not being active.
5. Internal logic error corrected.

#### Documentation impact

This APAR requires changes to be made to:

- User's Guide and Reference for CICS (SC19-1040-01)

## Changes to the User's Guide and Reference for CICS

### Chapter 9, "Messages"

In the section "FM/CICS logon and message log messages", add the following three messages:

---

**FMNCA042** Trace requested, message log error,  
**RESOURCE:** *resource*, **FUNCTION**  
*function*

**Explanation:** You have requested FM/CICS tracing, but an error was encountered with the transient data queue defined as the FM/CICS message log. FM/CICS tracing writes data to the message log, and therefore FM/CICS cannot perform tracing until the error with this resource has been resolved. The *function* is the operation File Manager attempted to perform against the queue. The *resource* is the name of the transient data queue defined to FM/CICS as the message log on the MSGL option in FMN3POPT. Refer to the *File Manager Customization Guide* for further details about the FM/CICS message log.

**User response:** Look up the condition and error code displayed in message FMNCA0023 for the listed function in *CICS Application Programming Reference* for further information.

---

**FMNCA043** CICS socket interface abend, interface may not be started

**Explanation:** FM/CICS encountered an abend when attempting to invoke the CICS socket interface. The CICS socket interface is required to communicate with the FM batch address space. The abend may be due to the CICS socket interface not being started on the CICS region.

**User response:** Issue the EZAO CICS transaction (if available) to view the status and start the CICS socket interface, then rerun the FM/CICS transaction.

---

**FMNCA065** *hh:mm:ss.ms* trace message

**Explanation:** Various tracing information as requested during FM/CICS initialization.

**User response:** None.

## Chapter 11, "FM/CICS panels and fields"

Add the following new description under the "Attributes" field description of the File Information panel:

### EXTENDED

This VSAM data set uses extended relative byte addressing.

---

## UK25481, UK25482, UK25483, UK25484, UK25485, UK25486

Release Date: 7 June 2007

This set of PTFs contains the following APAR fixes:

APAR #	APAR Abstract	Doc Impact
PK42052	Entering invalid line command in FM/IMS browse results in being forced out of browse.	None
PK42532	FM DB2 gets SSID XXXX not defined.	None
PK44332	Full source of COBOL program (instead of copybook) not working for some batch functions.	None
PK44459	ABEND013-20 allocating temporary datasets in FM/IMS due to unusual SMS defaults.	None
PK44523	ABEND0C4 in FMN2SCON if no FMN2SSDM SSID=DEFAULT in FMN2POPT.	None
PK44677	Disk record may get damaged with a premature EOF record after saving altered data.	User's Guide and Reference (SC19-1037-00)
PK44832	FM/IMS edit, using the next command (F11) in conjunction with a changed field, results in a display of an unexpected segment.	None

---

### PK44677

#### Initial problem description

Disk record may get damaged with a premature EOF record after saving altered data.

DVT batch processing does not allow you to limit the amount of data provided on the volume list output which causes long processing time.

DVT online and batch processing may abend S0C4 S0C4 or abend S878 S878 attempting to process non-standard disk volumes (PFM02683).

#### Outline of solution

Program logic has been corrected.

DVT program logic has been enhanced to provide a LIMITED=NO | YES processing keyword.

**Documentation impact**

This APAR requires changes to be made to the User's Guide and Reference (SC18-9655-01).

**Changes to the User's Guide and Reference**

**Chapter 17, "Functions"**

In function DVT, add a new parameter, LIMITED:

1. Replace the syntax diagram for the DVT function with the following:

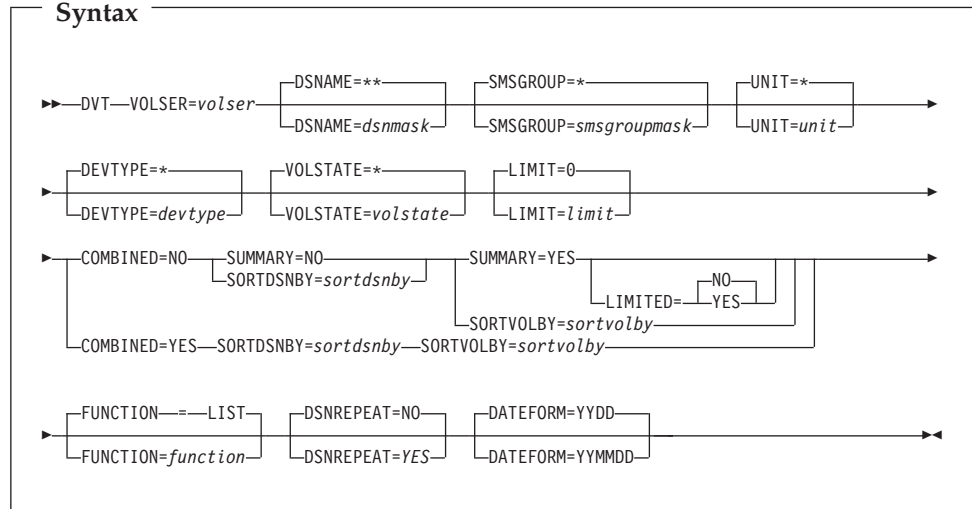

2. After the description for the SUMMARY keyword, add the following text:

**LIMITED**

Determines where the volume summary list (SUMMARY=YES) contains detailed (NO) or limited (YES) data about the number of datasets located on the volumes processed. Specifying LIMITED=YES provides faster response times.

**NO** Detailed dataset information included in the volume summary list.

**YES** No dataset counts provided in the volume summary list.

---

## UK24878, UK24879, UK24880, UK24893, UK24898, UK24899, UK24906

Release Date: 16 May 2007

This set of PTFs contains the following APAR fixes:

APAR #	APAR Abstract	Doc Impact
PK40713	FM/DB2 is not recognizing the new location name.	None.
PK40801	GEN command generates DDL for all the tables, tablespaces, etc.	None.
PK40817	FMN0117I "invalid value for parameter OBJIN" and FMN0019I when trying to print a DB2 file with DBP in batch mode.	None.
PK43486	Comparing records uses the wrong template layout.	None.
PK43546	FM/CICS should detect not-available/busy connections when verifying code level on interconnected CICS systems.	User's Guide and Reference for CICS (SC19-1040-00)
PK44009	Detect invalid LRECL(0) with PS datasets to avoid potential S0C9 abends.	None.
PK44240	Using browse/edit, a file while creating a new template, runtemp command gives invalid command. FM/CICS used from a CICS region.	None.
PK44418	ABENDU0999 REASON 771, invalid expression processing template.	None.

---

### PK43546

#### Initial problem description

File Manager for CICS does not allow a way to control which connected CICS regions FM/CICS links to.

#### Outline of solution

A new option, CONN, in the FM/CICS options module, FMN3POPT, allows users to enter the name of a transient data queue that contains a list of APPLIDs for connected CICS regions that FM/CICS should link to. When specified, FM/CICS will only attempt to link to the CICS regions entered in this list.

**Documentation impact**

This APAR requires changes to be made to:

- User's Guide and Reference for CICS (SC19-1040-00)

**Changes to the User's Guide and Reference for CICS****Chapter 9, "Messages"**

In the section "FM/CICS logon and message log messages", add the following two messages:

---

**FMNCA040 Connection tdqueue error, RESOURCE:**  
*resource, FUNCTION: function*

**Explanation:** File Manager has encountered an error while processing the connection transient data queue. File Manager reads this queue (if specified) to obtain a list of APPLIDs of connected CICS regions where FM/CICS has been installed to process remote resources. The *function* is the operation File Manager attempted to perform against the queue. The *resource* is the name of the transient data queue defined to FM/CICS on the CONN option in FMN3POPT.

**User response:** Look up the condition and error code displayed in message FMNCA023 for the listed function in *CICS Application Programming Reference* for further information.

---

**FMNCA041 Connection tdqueue incorrectly defined, RESOURCE:** *resource*

**Explanation:** The connection transient data queue is incorrectly defined. File Manager reads this queue (if specified) to obtain a list of APPLIDs of connected CICS regions where FM/CICS has been installed to process remote resources. The *resource* is the name of the transient data queue defined to FM/CICS on the CONN option in FMN3POPT. This resource must be defined as an extrapartition, input tdqueue with a record length no larger than 80 bytes.

**User response:** Correctly define the connection transient data queue. Refer to *File Manager Customization Guide* for further information.

---

## UK22513, UK22524, UK22525, UK22526, UK22528, UK22529

Release Date: 6 March 2007

This set of PTFs contains the following APAR fixes:

APAR #	APAR Abstract	Doc Impact
PK38471	FMN1OPT and/or the FM settings do not allow more than 3 RESLIB definitions.	User's Guide and Reference for IMS (SC18-9657-01)

---

### PK38471

#### Initial problem description

FM/IMS only allows the specification of three IMS RESLIB data sets.

#### Outline of solution

FM/IMS has been enhanced to support the specification and usage of up to six IMS RESLIBs.

#### Documentation impact

This APAR requires changes to be made to:

- User's Guide and Reference for IMS (SC18-9657-01)

## Changes to the User's Guide and Reference for IMS

### Chapter 9, "Panels and fields"

In the section "DLI Mode Data Sets panel", recapture the DLI Mode Data Sets panel.

Under the RESLIB header, add entries for the new fields: Data set name #4, Data set name #5, and Data set name #6. Text should be the same as that for Data set name #3.

### Chapter 11, "Functions"

In the sections "IEB (IMS Edit Batch)", "ILB (IMS Load)", "IPR (IMS Print)", and "IXB (IMS Extract)" add the following optional parameters to the DLI parameter section of the syntax diagrams.:

```
RESLIB4=reslib4  
RESLIB5=reslib5  
RESLIB6=reslib6
```

In the section "IEB (IMS Edit Batch)", change the entry header:

```
RESLIB2=reslib2/RESLIB3=reslib3
```

to:

```
RESLIB2=reslib2/RESLIB3=reslib3/RESLIB4=reslib4/RESLIB5=reslib5/  
RESLIB6=reslib6
```





---

## UK21782, UK21784, UK21785, UK21789

Release Date: 8 February 2007

This set of PTFs contains the following APAR fixes:

APAR #	APAR Abstract	Doc Impact
PK37318	File Manager CICS performance enhancements.	User's Guide and Reference for CICS (SC19-1040-00)

---

### PK37318

#### Initial problem description

1. Response times when processing large CICS resources through File Manager for CICS were exceptionally large.
2. Attempting to process a transient data queue with more than 32,771 records through FM/CICS causes FM to fail with system abend 878-14. Addressed by PTM PFM02148.
3. Editing a transient data queue through FM/CICS and specifying a record limit that is larger than the number of records in the queue causes the last record to be repeated when the queue is saved. Addressed by PTM PFM02306.
4. The insert length for a temporary storage queue increments every time an edit is invoked for the queue and a record is added. Also, the insert length for an intrapartition transient data queue is always 80 regardless of the largest record in the queue. Addressed by PTM PFM02312.
5. Output from the VERCICS command does not display the File Manager version. Addressed by PTM PFM02343.
6. The applid of the CICS region is not available through the FM/CICS interface.
7. Logon messages that have been translated into a language that requires the terminal to support mixed EBCDIC and double-byte character set (DBCS) fields are not being displayed.

#### Outline of solution

1. When sequentially reading and writing records to CICS resources, File Manager will request and populate a larger buffer with numerous records. This reduces the amount of TCP/IP requests between the File Manager batch job and CICS.
2. File Manager will now display error message FMNBA009 when the required storage to process an intrapartition transient data queue exceeds 2GB. File Manager will also now accurately determine the maximum record length of a TD queue instead of using a default value of 32k.
3. The algorithm has been corrected to correctly calculate the total number of records in a sequential data set when a specified record limit exceeds the total number of records in the file.

4. File Manager will now set the insert length of a temporary storage queue and intrapartition transient data queue equal to the largest record size that has been read in the queue.
5. The VERCICS command will now display version information.
6. The applid of the local CICS region will now be displayed on the Primary Option Menu. Also, output from the VERCICS command will now display the CICS applid of each interconnected CICS region that has FM/CICS installed.
7. File Manager for CICS will now obtain information about the CICS terminal prior to addressing the FM/CICS logon messages. If the selected language requires the terminal to support mixed EBCDIC and DBCS fields, and the terminal contains this support, the translated logon messages will be used. If the selected language requires the terminal to support mixed EBCDIC and DBCS fields, and the terminal does not contain this support, the default English logon messages will be used.

#### Documentation impact

This APAR requires changes to be made to:

- User's Guide and Reference for CICS (SC19-1040-00)

## Changes to the User's Guide and Reference for CICS

### Chapter 2, "Getting started with FM/CICS"

In the section "Checking the level of connected CICS systems":

- Before Figure 2 (Window showing the level of connected CICS systems), add:  
The VERCICS command queries the version, PTF, and level information of FM/CICS on the local and connected CICS regions. The retrieved information is then compared against the version, PTF, and level of the running File Manager batch job and the results are displayed. Any FM/CICS value that differs from the FM batch job is also highlighted.  
Any difference in version, PTF, or level can cause a failure due to services not being available in the downlevel instances. A difference may be due to maintenance not being applied to the FM/CICS instance or the FM/CICS programs may not have been refreshed in the CICS region after maintenance was applied.
- Replace Figure 2 with the following:

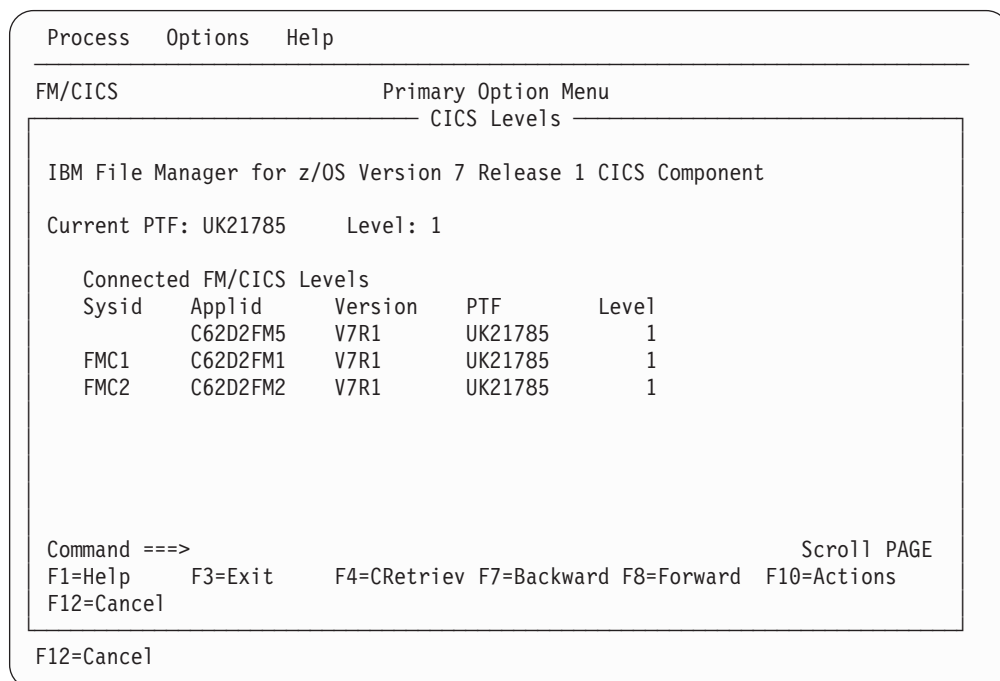

Figure 4. Window showing the level of connected CICS systems

The Primary Option Menu has been updated to include "CICS Applid" in the right column of the panel. It has replaced the field that was previously "Version".

As a result, in the section "Setting your default processing options", replace Figure 7 (Options pull-down menu) with:

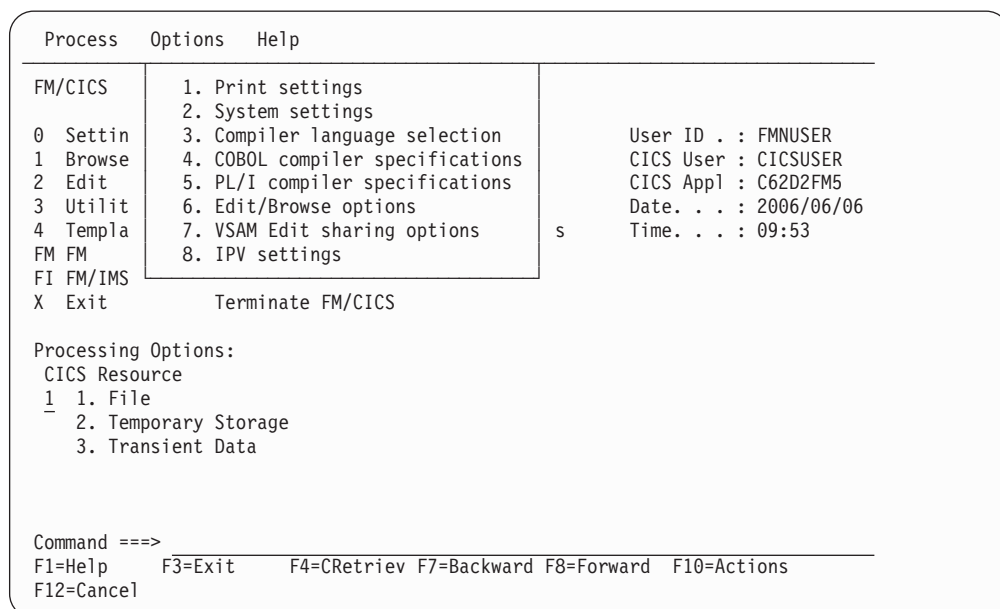

Figure 5. Options pull-down menu

## Chapter 9, "Messages"

In the section "File Manager messages", replace the details for messages FMNBB254 and FMNBB256 with:

**FMNBB254** You are running a higher level of File Manager in the batch job than in at least one of the connected CICS regions. This could lead to failures due to services being unavailable. Use the command VERCICS to verify the current levels of File Manager for CICS that are running and ensure all regions with a lower level are upgraded appropriately.

**Explanation:** This message indicates a mismatch in buffer layout between the batch job and FM/CICS most likely due to maintenance not being applied to all instances of FM/CICS. This mismatch can lead to severe errors if not resolved.

**User response:** Use the VERCICS command to display the level of FM/CICS on all connected CICS regions. Correct all instances that are running at a lower level from the running File Manager batch job. A difference in level may be due to maintenance not being applied to the FM/CICS instance or the FM/CICS programs

may not have been refreshed in the CICS region after maintenance was applied.

**FMNBB256 Warning - PTF mismatch**

**Explanation:** You are running different maintenance levels of File Manager in the batch job and FM/CICS in one or more of the connected CICS regions. This indicates that FM/CICS in one or more region may be downlevel and therefore not contain all available services or resolutions for problems provided by more recent levels of maintenance.

**User response:** Use the VERCICS command to display the PTF level of FM/CICS on all the connected CICS regions. Correct all instances that are running at a different PTF level from the running File Manager batch job. A difference in PTF level may be due to maintenance not being applied to the FM/CICS instance or the FM/CICS programs may not have been refreshed in the CICS region after maintenance was applied.

**Chapter 11, "FM/CICS panels and fields"**

The Primary Option Menu has been updated to include "CICS Applid" in the right column of the panel. It has replaced the field that was previously "Version".

As a result, in the section "Primary Option Menu panel", replace Figure 28 (File Manager Primary Option Menu panel) with:

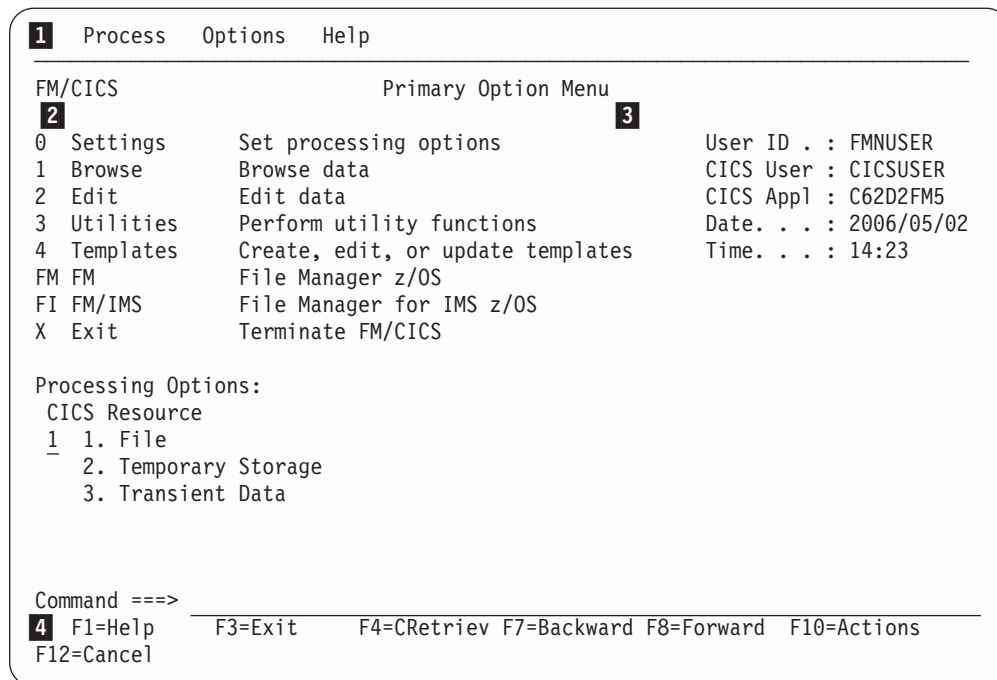

Figure 6. Primary Option Menu panel

---

## UK19762, UK19763, UK19764, UK19765, UK19771

Release Date: 23 November 2006

This set of PTFs contains the following APAR fixes:

APAR #	APAR Abstract	Doc Impact
PK33302	File Manager LIBDEF dropped.	None.
PK33688	File Manager may go into a loop following a DB2 error.	User's Guide and Reference (SC19-1037-00) User's Guide and Reference for DB2 Data (SC19-1038-01)
PK33920	"FMN0607I File Manager abended with code 840c4000" received when trying to enter selection criteria for a copybook.	User's Guide and Reference (SC19-1037-00)

---

### PK33688

#### Initial problem description

1. File Manager DB2 may loop (hang) following an error (ABEND) in DB2.
2. File Manager abends when problem allocating temporary data set using 3.4 VS command (PK25408).

#### Outline of solution

1. File Manager DB2 has been updated to correct the problem.
2. File Manager DB2 component has been changed to display a warning when there is a problem allocating a temporary data set, instead of abending.

#### Documentation impact

- This APAR requires changes to be made to:
- User's Guide and Reference (SC19-1037-00)

## Changes to the User's Guide and Reference

### Chapter 17, "Functions"

In the section, "SET (Set Processing Options)", add the following to the syntax diagram:



In the descriptions following the syntax diagram, add the following:

#### TEMPHLQ

TEMPHLQ specifies an installation-specific high-level qualifier for the temporary data sets created during a File Manager session. You can specify

any valid qualifier, including multilevel if required, up to a total length of 24 characters. If you specify &USER. for any part of the qualifier, this is replaced with the user's userid. A multilevel qualifier with symbols follows the same rules as in the specification of a data set name with symbolic parameters in JCL procedures. Thus, a single period used after a symbol combines the symbol with the text following it (See Example 1 below); a period separating parts of a multilevel qualifier must be doubled (see Example 2 below).

**Example 1**

If the userid is XXXX, then specifying &USER.1.TEMP results in a high-level-qualifier of XXX1.TEMP

**Example 2**

If the userid is ZZZZ then specifying FMN.&USER..ABCD results in a high-level-qualifier of FMN.ZZZZ.ABCD

**Notes:**

1. The TEMPHLQ parameter can be up to 24 characters long. However, temporary data sets can have different lengths, and the system part of the data set name may be longer than 20 characters. In this case, minor levels of TEMPHLQ are ignored, to the extent that the final data set name is less than or equal to 44 characters.
2. Concatenation of &USER.string could result in a part of the high-level qualifier being longer than 8 characters. In this case, the string is shortened to the extent that the final part of the qualifier is 8 characters long.

**PK33920****Initial problem description**

1. ABENDS0C4 in IRXINIT, ABENDS978 in ISPF, ABENDS0C4, ABEND S0C4, or unpredictable results after specifying template criteria using the by field panels and RG operators.
2. DSC may copy records truncating them (because of record length difference between input and output). No specific return code value is associated with such condition and value of 0 is being returned.
3. Error "FMN0355I Record size (80) invalid for FIXED,90 output" may be reported and changed member corrupted (PK33455).
4. "Invalid name" reported with long dataset names and mismatched quotes (PFM02209).
5. Data Set List 3.4, ALTER command missing update capability on ISPF panels (PFM002200).
6. Update of CICS file record results in error message and record being deleted (PFM02223) for KSDS with secondary AIX and no ADD/WRITE status.
7. The hex display setting for alphanumeric fields is lost after the template is updated. (AX reset to AN)

**Outline of solution**

1. The storage overlay has been fixed.
2. File Manager will be enhanced to provide a customizable return code for the conditions of dsc\_rectrc (record truncation occurred) and dsc fldtrc (field truncation occurred). These return codes will default to 0 (to match

existing behavior) and can be user-customized using the procedures described in the File Manager Customization Guide.

3. Program logic has been corrected to allow for JCL records to be up to 160 bytes, regardless of PAD setting. Only data in columns 1 - 72 is considered to be JCL statements, data past column 72 will be treated as non-changeable sequence numbers/comments. Note that when change causes a JCL record to spill over and cause a continuation record to be created then any data in columns 72-end-of-record will be copied from the original record to the newly inserted record.

4. Program logic has been changed to not add the missing closing quote for dataset names exceeding 44 characters.

5. SCS ALTER panels have been corrected.

6. Edit capability of CICS KSDS files with secondary AIX will require that the file has ADD and WRITE enabled. Otherwise the EDIT will not be allowed.

7. File Manager has been updated to correct the problem.

#### **Documentation impact**

This APAR requires changes to be made to:

- User's Guide and Reference (SC19-1037-00)

## **Changes to the User's Guide and Reference**

### **Chapter 17, "Functions"**

In the section, "FCH (Find/Change)", in the description for the JCL=YES option, replace the following text:

"If a logical line is changed and requires more physical records, the file is rewritten. The data in columns 73-80 for new physical records is copied from the last related original physical record."

with

"If a logical line is changed and requires more physical records, the file is rewritten. The data in columns 73-record length for new physical records is copied from the last related original physical record. Data past column 72 is treated as non-changeable sequence numbers or comments."





---

## UK19102, UK19103, UK19104, UK19115, UK19116, UK19135, UK19136, UK19139

Release Date: 1 November 2006

This set of PTFs contains the following APAR fixes:

APAR #	APAR Abstract	Doc Impact
PK31554	Cumulative APAR for File Manager V7 problems addressed after code freeze up to general availability.	None.
PK31764	WIDEPRT option support.	User's Guide and Reference (SC19-1037-00) User's Guide and Reference for IMS Data (SC19-1039-01)
PK33537	FM/IMS Japanese panel FMN1ST00 has incorrect data.	None.

---

### PK31764

#### Initial problem description

File Manager allocates the PRINTDSN print output dataset (online) and SYSPRINT (batch) at RECFM=VBA LRECL=32756 which may cause problems with third-party software while post-processing the output. Also if the print output dataset has been pre-allocated by the user then the dataset attributes will be overwritten by the above defaults.

The Compare utility does not provide for old changed and old matched records to be written to output data sets.

The edit and browse options offer only a combined option to SHOW not selected and suppressed records. The CAPS setting was not available on the options panel.

#### Outline of solution

File Manager has been enhanced to provide an installation setting (WIDEPRT=YES | NO) to allow for an option to customize the wide (LRECL=32756) or narrow (LRECL=137) print output/ SYSPRINT dataset allocation. Changes have been documented in the respective File Manager Manuals.

The Compare utility will now support the creation of output data sets containing old matched and old changed records.

Edit and Browse options have been enhanced to provide separate selectable options for the SHOW settings for Not selected records and Suppressed records and to provide the CAPS option. The layout of the options panel has been revised to group related items and to display the related command for changing the option value while in a edit or browse session. For CAPS install option support, the installation option EDITCAPS has been added to the installation options macro.

**Documentation impact**

- This APAR requires changes to be made to:
  - User’s Guide and Reference (SC19-1037-00)
  - User’s Guide and Reference for IMS Data (SC19-1039-01)

**Changes to the User’s Guide and Reference**

**Chapter 7, "Managing data sets"**

In the section, "Printing from File Manager", under the subsection "Setting your Print Processing Options":

- In step 4, after the option RECLIMIT, add a new option:

**WIDEPR**

Whether the maximum print line length for print output is used

**Chapter 15, "Panels and fields"**

In the section, "Set Print Processing Options panel (option 0.1)":

- Replace the panel shown with the following:

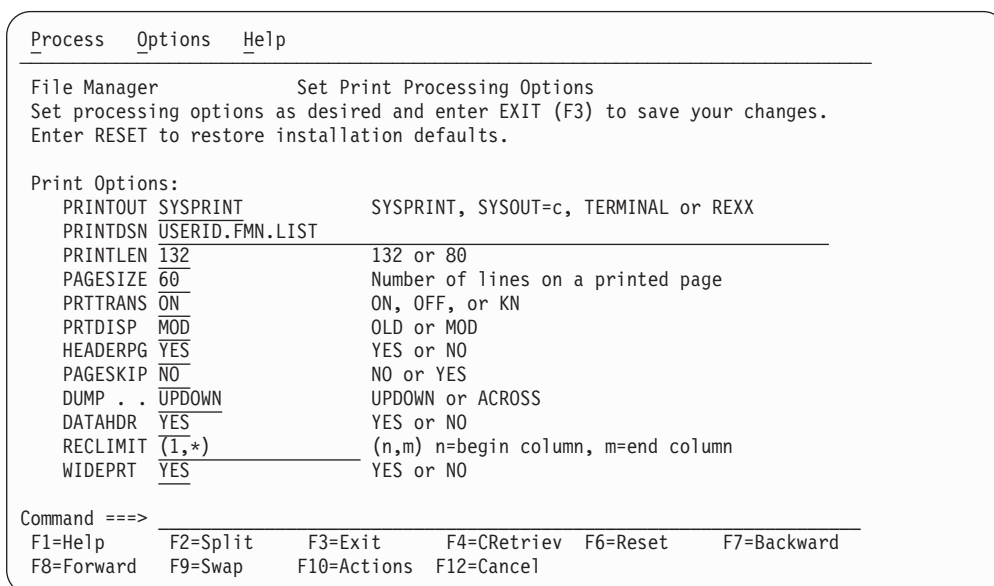

Figure 7. Set Print Processing Options

- In the list of descriptions that follows the panel, after the description for **RECLIMIT**, add:

**WIDEPR**

Specifies whether the maximum print line length for print output is set to 32760 or limited to 132.

**Note:** This setting only applies when the output dataset is newly-allocated during execution. It is ignored for pre-allocated print output datasets.

**YES** For to-be-allocated (new) print output datasets (online) or for SYSPRINT allocation (in batch), File Manager uses the maximum record length/blocksize of 32756/32760 and record format of VBA.

**NO** The to-be-allocated (new) print output datasets (online) or for

SYSPRINT allocation (in batch), File Manager uses the record length/blocksize of 133/137 and record format of VBA.

## Chapter 17, "Functions"

In the function, SET (Set Processing Options):

- Add a new option, WIDEPR, to the syntax diagram (after the RECLIMIT option):



- In the list of descriptions that follows the syntax diagram, add the following (after the description for RECLIMIT)":

### WIDEPR

Specifies the maximum print line length for print output.

**YES** Maximum print line length is 32760.

**NO** Maximum print line length is 132.

## Changes to the User's Guide and Reference for IMS Data

### Chapter 9, "Panels and fields"

In the section, "Set Print Processing Options panel":

- Replace the panel shown with the following:

<u>P</u> rocess	<u>O</u> ptions	<u>H</u> elp
FM/IMS	Set Print Processing Options	
Set processing options as desired and enter EXIT (F3) to save your changes. Enter RESET to restore installation default values.		
Print Options:		
PRINTOUT	SYSPRINT	SYSPRINT, SYSOUT=c, TERMINAL or REXX
PRINTDSN	FMUSER.FMN.LIST	
PRINTLEN	132	132 or 80
PAGESIZE	60	Number of lines on a printed page
PRTRANS	ON	ON, OFF, or KN
HEADERPG	YES	YES or NO
PAGESKIP	NO	NO or YES
DUMP . .	UPDOWN	UPDOWN or ACROSS
DATAHDR	YES	YES or NO
RECLIMIT	(1,*)	(n,m) n=begin column, m=end column
WIDEPR	YES	YES or NO
Command ==>		
F1=Help	F2=Split	F3=Exit
F4=CRetriev	F6=Reset	F7=Backward
F8=Forward	F9=Swap	F10=Actions
F12=Cancel		

Figure 8. Set Print Processing Options panel

- In the list of descriptions that follows the panel, after the description for RECLIMIT, add:

### WIDEPR

Specifies whether the maximum print line length for print output is set to 32760 or limited to 132.

## PK31764

**Note:** This setting only applies when the output dataset is newly-allocated during execution. It is ignored for pre-allocated print output datasets.

**YES** For to-be-allocated (new) print output datasets (online) or for SYSPRINT allocation (in batch), FM/IMS uses the maximum record length/blocksize of 32756/32760 and record format of VBA.

**NO** The to-be-allocated (new) print output datasets (online) or for SYSPRINT allocation (in batch), FM/IMS uses the record length/blocksize of 133/137 and record format of VBA.

## Part 2. General Documentation Changes

<b>Customization Guide (SC19-1036-02)</b> . . . . .	63	Chapter 17, "Functions" . . . . .	69
Change #1 October 2007 . . . . .	63	Change #1 (November 2006). . . . .	70
Change #2 October 2007 . . . . .	63	Chapter 7, "Managing data sets" . . . . .	70
Change #3 October 2007 . . . . .	63	Chapter 17, "Functions" . . . . .	71
CCSIDWARNIGNORE. . . . .	63		
CCSIDWARN. . . . .	64		
Change #4 December 2007 . . . . .	65		
<b>User's Guide and Reference (SC19-1037-00)</b> . . . . .	67	<b>User's Guide and Reference for DB2 Data</b>	
Change #11: December 2008 . . . . .	67	<b>(SC19-1038-01)</b> . . . . .	73
Change #10 September 2007 . . . . .	67		
Change #9 September 2007 . . . . .	67	<b>User's Guide and Reference for IMS Data</b>	
Change #8 August 2007 . . . . .	68	<b>(SC18-9657-01)</b> . . . . .	75
Change #7 August 2007 . . . . .	68	Change #1 August 2007 . . . . .	75
Change #6 August 2007 . . . . .	68		
Change #5 April 2007 . . . . .	68	<b>User's Guide and Reference for CICS</b>	
Change #4 March 2007 . . . . .	69	<b>(SC19-1040-00)</b> . . . . .	77
Change #3 December 2006 . . . . .	69	Change #1 September 2007 . . . . .	77
Change #2 (November 2006). . . . .	69	Change #2 September 2007 . . . . .	77
		Change #3 September 2007 . . . . .	77
		Change #4 September 2007 . . . . .	77

This section describes enhancements and updates in the documentation for File Manager for z/OS Version 7 Release 1. These changes are not associated with individual APAR or PTF numbers, as they do not require the application of any code updates.

The changes are grouped by manual and listed within each section in reverse date order. That is, the most recent documentation change appears at the beginning of each manual section.



---

## Customization Guide (SC19-1036-02)

---

### Change #1 October 2007

#### Chapter 1, "Preparing to Customize File Manager"

Section, "Modifying the TSO logon procedure"

Add the following at the end of this section:

If you plan to use options 8.1 or 8.2 (HFS browse or edit), ensure that the following BCP target libraries are concatenated, as follows, when you invoke File Manager.

SBPXEXEC concatenated to SYSEXEC DDname  
SBPXMENU concatenated to ISPMLIB DDname  
SBXPENU concatenated to ISPLLIB DDname  
SBPXTENU concatenated to ISPTLIB DDname

If you do not have these libraries available, you may get 'panel not found' errors when you invoke 8.1 or 8.2.

---

### Change #2 October 2007

#### Chapter 25. "Customizing File Manager/CICS"

Section, "Customizing the batch procedure"

Add the following bullet to step 2, "Modify FMN3CICB in your library":

If the name of the TCP/IP address space is not the default value of 'TCPIP', uncomment the SYSTCPD DD statement and change *#tcpparms* to the data set and member name that contains the appropriate TCPIPJOBNAME parameter.

---

### Change #3 October 2007

#### Appendix B. "File Manager/DB2 Options"

Add the following option to FMN2SSDM:

### CCSIDWARNIGNORE

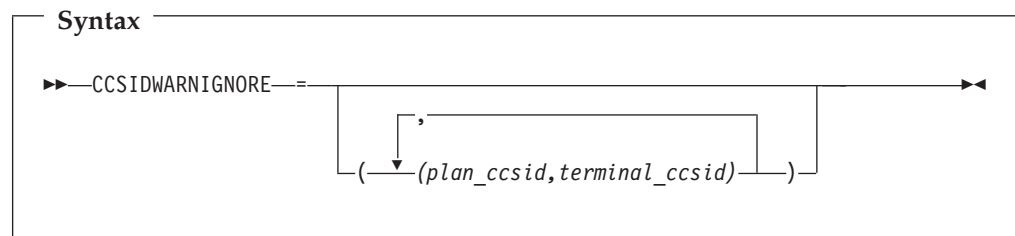

#### CCSIDWARNIGNORE

controls whether the CCSID Warning message will be displayed when File Manager/DB2 connects to a DB2 subsystem, if the CCSID of the terminal differs from the CCSID of the plan. File

Manager/DB2 connects to a DB2 subsystem when the application is first entered or when the DB2 SSID is changed.

This option is used in conjunction with the CCSIDWARN option in the FMN2POPI macro.

An option is provided to allow you to stop the displaying of the CCSID Warning message when there is a mismatch between the terminal CCSID and the SSID plan CCSID.

Each parameter contains two CCSIDs. These are the CCSID of the plan and the CCSID of the terminal. These CCSIDs are separated by a comma and the whole parameter is enclosed in parentheses.

Up to five pairs of CCSIDs may be specified. If more than one pair is specified the parameters must be separated by a comma and the parameters must be enclosed in an outer pair of parentheses.

If you do not specify CCSIDWARNIGNORE in your FMN2SSDM macro, the default is no parameters.

Add the following option to FMN2POPI:

## CCSIDWARN

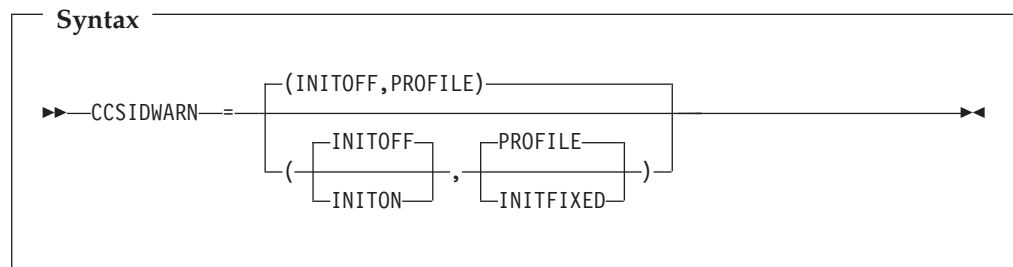

**CCSIDWARN** controls whether a warning message will be displayed when File Manager/DB2 connects to a DB2 subsystem, if the CCSID of the terminal differs from the CCSID of the plan. File Manager/DB2 will connect to a DB2 subsystem when the application id first entered or when the DB2 SSID is changed.

This option is used in conjunction with the CCSIDWARNIGNORE option in the FMN2SSDM macro.

Options are provided to allow you to:

- Set the initial value of the system CCSID Warning message option for new File Manager/DB2 users.
- Force the system CCSID Warning message option for all File Manager/DB2 users; alternatively allow File Manager/DB2 users to control the initial setting using the new system option, that is saved in the user's ISPF profile.

There are two sub-parameters to CCSIDWARN. You do not have to specify them all in FMN2POPI, but if you do so, they must be in the order shown in the syntax diagram. If you specify more than one, they must be separated by commas and enclosed in parentheses.

If you do not specify CCSIDWARN at all in your FMN2POPI macro, the default setting of (INITOFF,PROFILE) is used.



**Note:** This option only applies to DB2 Release 7 and later.

The sub-parameters are described below.

**INITOFF, INITON**

determines the initial system CCSID Warning message option setting in the user's profile, when the profile is first created.

For users with an existing File Manager/DB2 profile, the effect depends on the setting of the second parameter (described below). If INITFIXED is specified for the second parameter, then every File Manager/DB2 edit session begins with either the system CCSID Warning message option not being set if INITOFF is specified, or the system CCSID Warning message option being set if INITON is specified.

**PROFILE, INITFIXED**

determines if the user can alter the initial setting of system CCSID Warning message option in File Manager/DB2 edit.

INITFIXED prevents the user from altering the initial setting of the system CCSID Warning message option.

PROFILE allows the user to change this initial setting and it is preserved between File Manager/DB2 sessions in the user's profile.

---

## Change #4 December 2007

### Chapter 12. "Customizing FM/DB2"

Examples of FMM2POPI macros:

In the description of each example, remove the last sentence in note 5 in each case.

### Appendix B. "File Manager/DB2 Options"

EDITCAPS option:

Replace the note at the end of the description of the EDITCAPS option with the following notes:

**Notes:**

1. EDITCAPS can also be specified in the FMN0POPI macro, which appears at the start of the FMN2POPT definition. Specifying EDITCAPS in the FMN0POPI macro has no effect on the FM/DB2 editor. To change the EDITCAPS behaviour in an FM/DB2 edit session, the EDITCAPS option must be specified in the FMN2POPI macro.
2. The EDITCAPS option available for the File Manager base function has no effect in FM/DB2.



---

## User's Guide and Reference (SC19-1037-00)

---

### Change #11: December 2008

Chapter 17, "Functions", section "External REXX functions"

- In the list of functions at the beginning of the section:
  - In the description for RSTR\_OUT, add the sentence:  
"(Can be used in FASTREXX condition expressions.)"
  - In the description for SAVE\_OUT, add the sentence:  
"(Can be used in FASTREXX condition expressions.)"
- In the subsection, "RSTR\_OUT", after the syntax diagram add the sentence:  
"(Can be used in FASTREXX condition expressions.)"
- In the subsection, "SAVE\_OUT", after the syntax diagram add the sentence:  
"(Can be used in FASTREXX condition expressions.)"

---

### Change #10 September 2007

Chapter 17, "Functions"

Section, "DSU (Data Set Update)"

- In the **Usage notes** section, add the following note:

**Note:** DFSMS-compressed datasets are not supported (for use with DSU).

---

### Change #9 September 2007

Chapter 3, "Viewing data sets"

Section "Manipulating your view of the data", subsection "Scrolling to see data"

- Change the first note from:  
"If you specify the MAX parameter or a number of records greater than the number of subsequent records, File Manager displays the "\*\*\*\* End of data \*\*\*\*" indicator. You can then press Previous function key (F10) to view the last selected record."  
to  
"If you specify a number of records greater than the number of subsequent records, File Manager displays the "\*\*\*\* End of data \*\*\*\*" indicator. You can then press the Previous function key (F10) to view the last selected record."
- Change the second note from:  
"If you specify the MAX parameter or a number of records greater than the number of prior records, the first selected record is displayed."  
to  
"If you specify the MAX parameter, the first selected record is displayed. If you specify a number of records greater than the number of prior records, File Manager displays the "\*\*\*\* Top of data \*\*\*\*" indicator. You can then press the Next function key (F11) to view the first selected record."

---

## Change #8 August 2007

### Chapter 16, "Primary commands"

#### Section, "BOUNDS primary command"

- After the sentence, "This command is only available in CHAR, HEX or LHEX display formats", add the sentence:  
"It is not available at all when using a segmented record template."

---

## Change #7 August 2007

### Chapter 16, "Primary commands"

#### Section, "FIND primary command"

- Change the syntax diagram to show:

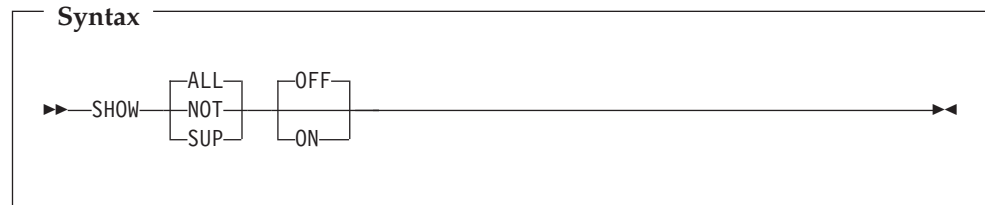

---

## Change #6 August 2007

### Chapter 16, "Primary commands"

#### Section, "RESET primary command"

- Change the first paragraph:  
"In the Browse or Edit panels, the RESET command "cleans up" the displayed data. You use RESET to turn off the highlighting of strings found by the FIND command and hide all not-selected and suppressed records (equivalent to entering SHOW ALL OFF)."  
to:  
"In the Browse or Edit panels, the RESET command "cleans up" the displayed data. You use RESET to turn off the highlighting of strings found by the FIND command and, when using a template, to restore the state of the SHOW and SHADOW settings to the defaults as set in the Editor Options panels."
- Further down, change the paragraph:  
"Hides all not-selected and suppressed records previously shown with the SHOW primary command. (equivalent to entering SHOW ALL OFF)"  
to:  
"When using a template, restores the state of the SHOW and SHADOW settings to the defaults as set in the Editor Options panels."

---

## Change #5 April 2007

### Chapter 17, "Functions"

#### Section, "SET (Set Processing Options)"

- In the description for **ASCII**, change the last paragraph

"This processing option applies to all tape input and output functions except: Initialize Tape, Tape Browse, Tape Label Display, Tape to Labeled Tape, Tape to Tape Compare and Tape Update. For Tape Label Display, ASCII translation is automatically performed when needed. For Initialize Tape and Tape Browse, you can specify ASCII input or output when invoking the function. For the other functions, translation is not supported by File Manager."

to

"This processing option applies to all tape input and output functions except: Initialize Tape, Tape Browse, Tape Label Display, and Tape Update. For Tape Label Display, ASCII translation is automatically performed when needed. For Initialize Tape and Tape Browse, you can specify ASCII input or output when invoking the function. For the other (non-tape) functions, ASCII translation is not supported by File Manager."

---

## Change #4 March 2007

### Chapter 15, "Panels and fields"

In the section "Edit Entry panel", under "**Inplace edit**" replace

"You must select **Inplace edit** when using any of the following:..."

with

"**Inplace edit** is implied when using any of the following:..."

---

## Change #3 December 2006

### Chapter 18, "File Manager messages"

Add the following new message:

#### FMN0052I

The template has been corrupted and must be created again before it can be used. Reason code rc.

#### Explanation:

The template has been corrupted and cannot be used.

#### User Response:

Recreate the template. If the problem still occurs, save any system error information and contact your system support.

---

## Change #2 (November 2006)

### Chapter 17, "Functions"

Section, "DSU (Data Set Update) - batch only"

- In the description for **KEY=key (VSAM only)**, change the following text

"A key for KSDS records, or a slot number for RRDS records. The maximum key length is 30 characters. The first record with a key or slot value greater than or equal to key is the first record printed. If you omit the key and skip values, printing begins with the first record in the data set."

to

"A key for KSDS records, or a slot number for RRDS records. The maximum key length is 30 characters. The first record with a key or slot value greater than or

equal to key is the first record updated. If you omit the key and skip values, updating begins with the first record in the data set."

- In the description for **PROC=proc**, change the following text  
"Member name of a REXX procedure that you want to use to process each record before it is printed, or an asterisk (\*) to indicate the REXX procedure is inline. If you specify a member name, you must define an FMNEXEC ddname that identifies the PDS containing the member. If you specify \*, the procedure is read from SYSIN immediately following the control statement for the current function. The inline procedure is terminated by a record containing a slash and a plus sign (/+) in columns 1-2. For more information about using REXX procedures to process records before they are printed, see..."

to

"Member name of a REXX procedure that you want to use to process each record before it is updated, or an asterisk (\*) to indicate the REXX procedure is inline. If you specify a member name, you must define an FMNEXEC ddname that identifies the PDS containing the member. If you specify \*, the procedure is read from SYSIN immediately following the control statement for the current function. The inline procedure is terminated by a record containing a slash and a plus sign (/+) in columns 1-2. For more information about using REXX procedures to process records before they are updated, see..."

---

## Change #1 (November 2006)

### Chapter 7, "Managing data sets"

Section, "Comparing data sets"

- Replace the third paragraph:  
"Record selection can be performed at the record level using the **Start key**, **Skip count**, and **Compare count** fields, or at the field level using conditional expressions defined in the template, or at a combination of both levels. The start key (or slot) and skip count are honored before field level selection takes place."  
with:  
"Record selection can be performed at the record level using the **Start key**, **Skip count**, and **Compare count** fields, or at the field level using conditional expressions defined in the template, or at a combination of both levels. The **Start key** (or slot) and **Skip count** fields are honored before field level selection takes place. The **Number of differences to report** option allows you to limit the number of differences reported by the compare operation."
- After the three bullet points following "You can use the Compare Utility to:", add two new bullet points:
  - Restrict the number of differences reported with the Compare Utility option, **Number of differences to report**.
  - Create output data sets containing records identified as inserted, deleted, old and new changed records, and old and new matched records. (These data sets can only be created if the synchronization option, **Read-ahead**, has *not* been selected.)

Subsection, "Comparing data sets without using a template"

- After Step 15 ("If your data is in a sequential data set or..."), add a new step:  
**16.** If required, in **Number of differences to report**, specify the maximum number of differences (found in the compare operation) that you want reported.
- Increment the numbers of the steps that follow by 1.

## Chapter 17, "Functions"

Section, "DSM (Data Set Compare)"

- Under "**Purpose**", add a new bullet point:
  - Create output data sets containing records identified as inserted, deleted, old and new changed records, and old and new matched records. (These data sets can only be created if the synchronization option, **SYNCH=READAHEAD**, has *not* been specified.)
- Under "**Usage Notes**", add a new item to the list following "Select the records to be compared, using:":
  - The "Number of differences to report" option





---

## **User's Guide and Reference for DB2 Data (SC19-1038-01)**

There are no general documentation changes.



---

# User's Guide and Reference for IMS Data (SC18-9657-01)

---

## Change #1 August 2007

Chapter 10, "Commands"

Section, "FIND primary command"

- Change the syntax diagram to show:

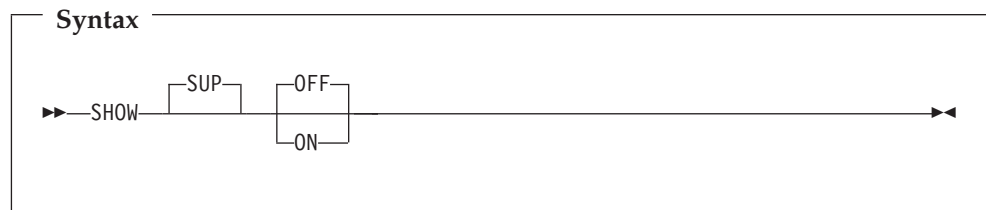



---

# User's Guide and Reference for CICS (SC19-1040-00)

---

## Change #1 September 2007

### Chapter 1, "FM/CICS overview"

#### Section, "Editing CICS files"

- After the sentence, "The CICS resources that are supported are:", change the first bullet item from:
  - Files (VSAM only).to:
  - Files (VSAM and data tables only).

---

## Change #2 September 2007

### Chapter 3, "Viewing and changing CICS resources"

#### Section, "Editing CICS files"

- At the end of the section (just before "RELATED TOPICS"), add the following note:

**Note:** FM/CICS requests against CICS data tables not owned by the local CICS region always use function shipping (cross-memory services are not used).

---

## Change #3 September 2007

### Chapter 10, "FM/CICS panels and fields"

#### Section, "File Information panel"

- For the description of **Type** in the "General" field descriptions, add this sentence:  
"For CICS data tables, Type contains TABL."
- At the end of the section (just before "Parent panels"), add these 3 "General" field descriptions:

**Table name** Shown for coupling facility data tables and is the coupling facility data table name.

**Table pool** Shown for coupling facility data tables and is the name of the coupling facility data table pool in which the coupling facility data table resides.

**Max records** Shown for data tables and indicates the maximum number of records that the data table for this file can hold. A value of 0 may indicate the resource was defined with NOLIMIT.

---

## Change #4 September 2007

### Chapter 10, "FM/CICS panels and fields"

#### Section, "CICS File Selection List panel"

- For the description of **Type**, add this sentence:  
"For CICS data tables, Type contains TABL."



---

## Part 3. Appendixes





---

## Index

### P

PK31764  
UK19102, UK19103, UK19104,  
UK19115, UK19116, UK19135,  
UK19136, UK19139 57

PK33688  
UK19762, UK19763, UK19764,  
UK19765, UK19771 53

PK33920  
UK19762, UK19763, UK19764,  
UK19765, UK19771 54

PK37318  
UK21782, UK21784, UK21785,  
UK21789 49

PK38471  
UK22513, UK22524, UK22525,  
UK22526, UK22528, UK22529 47

PK43546  
UK24878, UK24879, UK24880,  
UK24893, UK24898, UK24899,  
UK24906 45

PK44677  
UK25481, UK25482, UK25483,  
UK25484, UK25485, UK25486 43

PK45233  
UK28623, UK28624, UK28625,  
UK28626, UK28627, UK28628,  
UK28629, UK28630, UK28631,  
UK28632 35

PK45551  
UK26398, UK26399, UK26401,  
UK26402, UK26403, UK26404 41

PK48836  
UK27934, UK27939, UK27941,  
UK27939, UK27942 37

PK49243  
UK27934, UK27939, UK27941,  
UK27939, UK27942 39

PK55097 29

PK55164  
UK31651, UK31652, UK31653,  
UK31654, UK31655, UK31656,  
UK31657, UK31658, UK31659,  
UK31660, UK31661, UK31662 31

PK60896  
UK34896, UK34897, UK34898,  
UK34899, UK34900, UK34901,  
UK34902, UK34903, UK34904,  
UK34905 26

PK66473  
UK39593, UK39596, UK39605,  
UK39606, UK39611, UK39642,  
UK39647, UK39648, UK39650 3, 18

PK70108  
UK39593, UK39596, UK39605,  
UK39606, UK39611, UK39642,  
UK39647, UK39648, UK39650 23

### U

UK19102  
PK31764 57

UK19102, UK19103, UK19104, UK19115,  
UK19116, UK19135, UK19136, UK19139

PK31544 57

PK31764 57

UK19103  
PK31764 57

UK19104  
PK31764 57

UK19135  
PK31764 57

UK19136  
PK31764 57

UK19139  
PK31764 57

UK19762  
PK33688 53

PK33920 54

UK19762, UK19763, UK19764, UK19765,  
UK19771

PK33688 53

UK19763  
PK33688 53

PK33920 54

UK19764  
PK33688 53

PK33920 54

UK19765  
PK33688 53

PK33920 54

UK19771  
PK33688 53

PK33920 54

UK21782  
PK37318 49

UK21782, UK21784, UK21785, UK21789  
PK37318 49

UK21784  
PK37318 49

UK21785  
PK37318 49

UK21789  
PK37318 49

UK22513  
PK38471 47

UK22513, UK22524, UK22525, UK22526,  
UK22528, UK22529

PK38471 47

UK22524  
PK38471 47

UK22525  
PK38471 47

UK22526  
PK38471 47

UK22528  
PK38471 47

UK22529  
PK38471 47

UK24878  
PK43546 45

UK24878, UK24879, UK24880, UK24893,  
UK24898, UK24899, UK24906

PK43546 45

UK24879  
PK43546 45

UK24880  
PK43546 45

UK24893  
PK43546 45

UK24898  
PK43546 45

UK24899  
PK43546 45

UK24906  
PK43546 45

UK25481  
PK44677 43

UK25481, UK25482, UK25483, UK25484,  
UK25485, UK25486

PK44677 43

UK25482  
PK44677 43

UK25483  
PK44677 43

UK25484  
PK44677 43

UK25485  
PK44677 43

UK25486  
PK44677 43

UK26398  
PK45551 41

UK26398, UK26399, UK26401, UK26402,  
UK26403, UK26404

PK45551 41

UK26399  
PK45551 41

UK26401  
PK45551 41

UK26402  
PK45551 41

UK26403  
PK45551 41

UK26404  
PK45551 41

UK27934  
PK48836 37

PK49243 39

UK27934, UK27939, UK27941, UK27939,  
UK27942

PK48836 37

UK27939  
PK48836 37

PK49243 39

UK27941  
PK48836 37

PK49243 39

UK27942  
PK48836 37

UK27942 (continued)		UK34897	
PK49243	39	PK60896	26
UK28623		UK34898	
PK45233	35	PK60896	26
UK28623, UK28624, UK28625, UK28626,		UK34899	
UK28627, UK28628, UK28629, UK28630,		PK60896	26
UK28631, UK28632		UK34900	
PK45233	35	PK60896	26
UK28624		UK34901	
PK45233	35	PK60896	26
UK28625		UK34902	
PK45233	35	PK60896	26
UK28626		UK34903	
PK45233	35	PK60896	26
UK28627		UK34904	
PK45233	35	PK60896	26
UK28628		UK34905	
PK45233	35	PK60896	26
UK28629		UK39593	
PK45233	35	PK66473	3
UK28630		PK68098	18
PK45233	35	PK70108	23
UK28631		UK39593, UK39596, UK39605, UK39606,	
PK45233	35	UK39611, UK39642, UK39647, UK39648,	
UK28632		UK39650	
PK45233	35	PK70108	3
UK31651		UK39596	
PK55164	31	PK66473	3
UK31651, UK31652, UK31653, UK31654,		PK68098	18
UK31655, UK31656, UK31657, UK31658,		PK70108	23
UK31659, UK31660, UK31661, UK31662		UK39605	
PK53815	31	PK66473	3
PK54187	31	PK68098	18
PK54911	31	PK70108	23
PK55164	31	UK39606	
PK56128	31	PK66473	3
PK56241	31	PK68098	18
PK56250	31	PK70108	23
UK31652		UK39611	
PK55164	31	PK66473	3
UK31653		PK68098	18
PK55164	31	PK70108	23
UK31654		UK39642	
PK55164	31	PK66473	3
UK31655		PK68098	18
PK55164	31	PK70108	23
UK31656		UK39647	
PK55164	31	PK66473	3
UK31657		PK68098	18
PK55164	31	PK70108	23
UK31658		UK39648	
PK55164	31	PK66473	3
UK31659		PK68098	18
PK55164	31	PK70108	23
UK31660		UK39650	
PK55164	31	PK66473	3
UK31661		PK68098	18
PK55164	31	PK70108	23
UK31662			
PK55164	31		
UK34896			
PK60896	26		
UK34896, UK34897, UK34898, UK34899,			
UK34900, UK34901, UK34902, UK34903,			
UK34904, UK34905			
PK60896	25		





Printed in USA

Spine information:



File Manager for z/OS V7R1

Addenda to V7R1 User's Guides and Customization  
Guide