



IBM Power Systems

IBM i™ High Availability Options 2008 PUG – Charring Cross Hotel, London



David Tulloch
System i Technical Consultant
IBM Systems and Technology Group
david_tulloch@uk.ibm.com

RAS - Reliability, Availability and Serviceability

Hardware Service

- Automatic Failure Notification
- Concurrent maintenance
- Predictive Failure Analysis & Reporting
- HMC (Hdw Maint Console)

Power Subsystem

- Redundant power supplies
- Dual line cords
- Redundant cooling fans
- Dedicated UPS Monitoring Interface
- Concurrent maintenance

Memory – CPU

- Error detection & correction
- Memory scrubbing
- Array repair at IPL using redundant array bits
- CPU Gard, CPU Sparring and Capacity on Demand
- "Chip kill" technology
- Redundant bit steering

Disk Subsystem

- RAID 5/6 protection
- Disk Mirroring protection
- SAN Multipath
- ESS/DS redundant cache
- Concurrent maintenance
- Add disk concurrently
- Move data concurrently
- i5/OS Automatic Failure Notification



I/O Subsystem

- Hot pluggable PCI cards
- Concurrent maintenance
- Dynamic hardware resource reallocation
- Redundant HSL loops
- IOP reset
- Virtual IP, route fault tolerance, load balancing

Disk Protection Options

RAID-5 / RAID-6

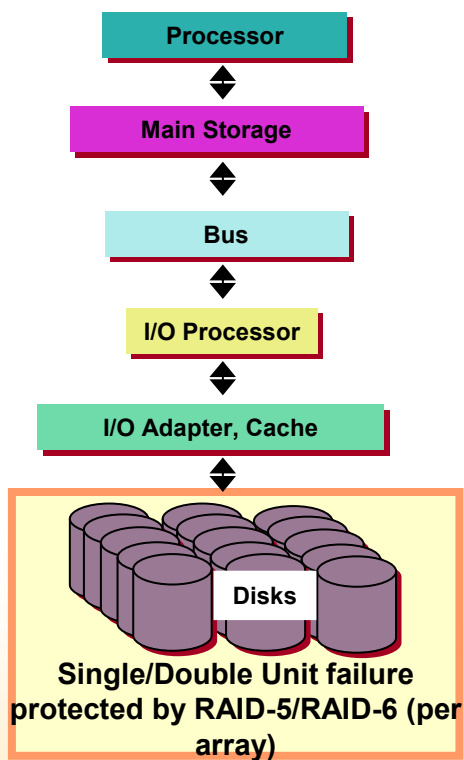

Write cache protection for 5738/2780/2757 controllers

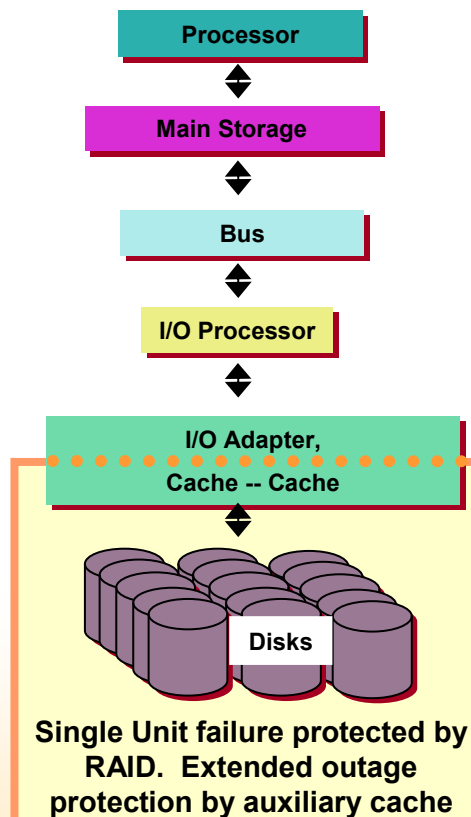

Mirroring

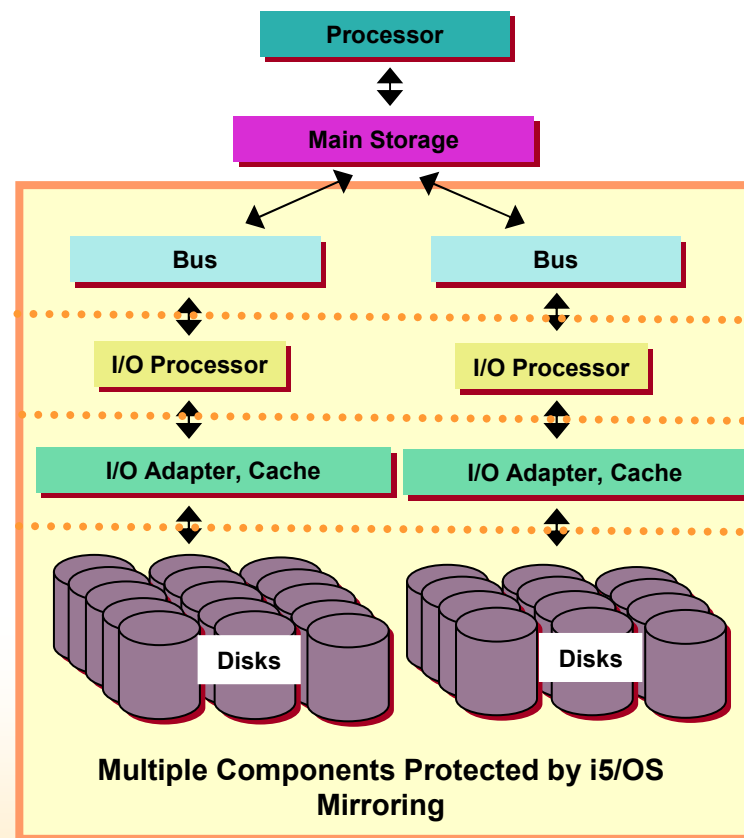

If not mirroring disk controllers, aux write cache makes sense

What is an Independent ASP (IASP)

- An IASP is a set of DASD units which contain a collection of user objects and the necessary system data (storage management directories, object ownership and authorization information) such that the IASP can be taken offline or brought online independent of system activity on other ASPs.
- Can be made available and made unavailable to the server without restarting the system.
- Identified by device name.
- Overflow not allowed.
- Can be switched between systems in a clustered environment
- Each ASP group has a separate namespace and database
 - They do not overlap
- VRYCFG or WRKCFGSTS used to independently bring online or take offline
 - VRYCFG <aspname> *DEV *ON** to vary on
 - WRKCFGSTS *DEV *ASP** to view current status

IASP Terminology

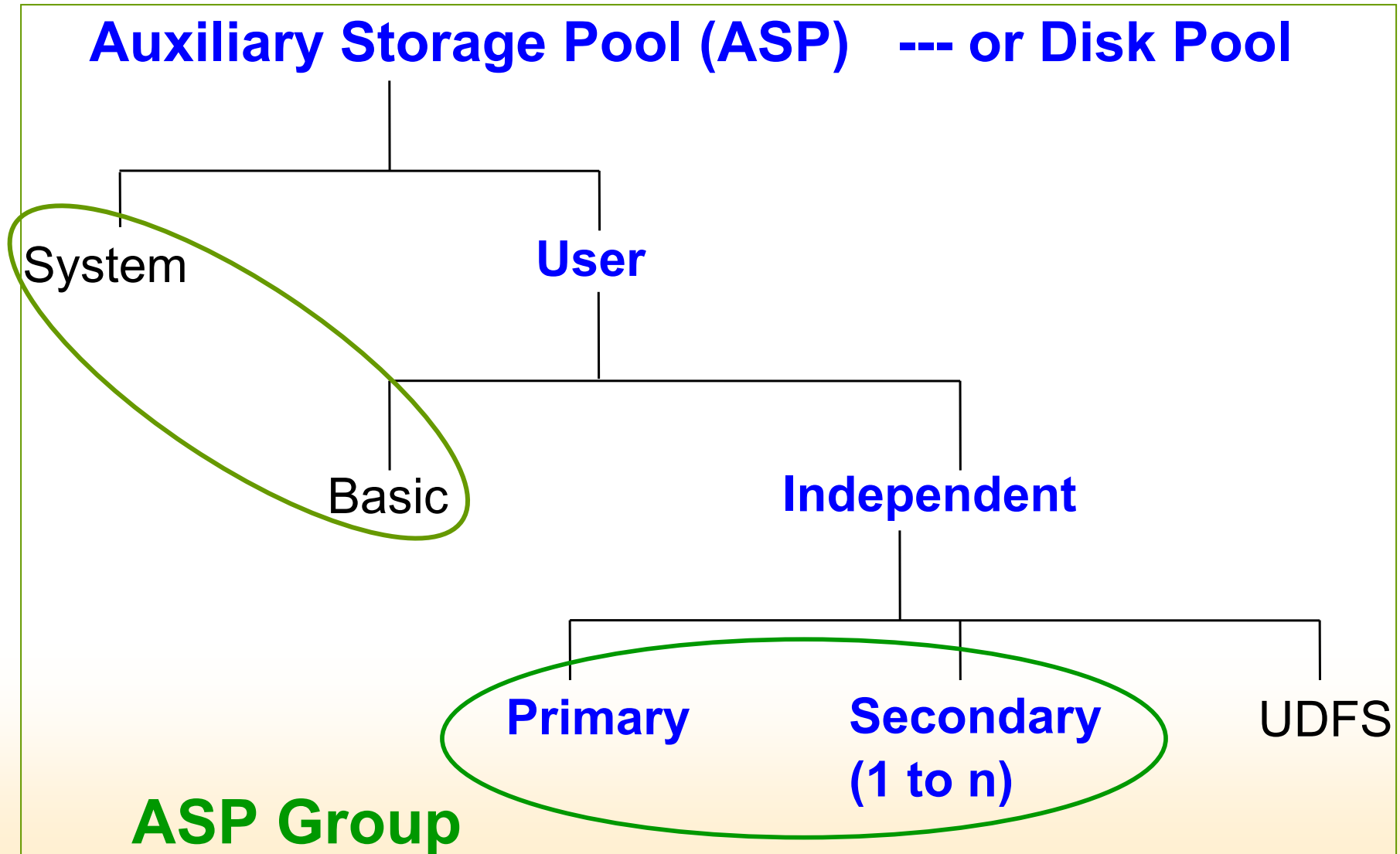

Types of ASPs

▪ Basic ASP

- ASP numbers 2-32
- Linked to system ASP
- Cannot be independently varied on or off
- Will overflow into system ASP
- Primarily used to isolate journal receivers from the data in the system ASP

▪ Independent ASP

- Can be independently varied on and off
- Can be switchable between systems
- Identified by ASP number (33 – 255) and also by device description
- Three types of IASP
 - UDFS
 - Primary
 - Secondary

Types of Independent Auxiliary Storage Pools

- **UDFS IASP**

- Can only contain IFS objects
- Slightly faster vary on time than a Primary IASP

- **Primary IASP**

- Can contain IFS and library objects
- Accessed via SETASPGRP
- May have 0 or more secondary IASPs grouped with it

- **Secondary IASP**

- Can contain IFS and library objects
- Grouped with one Primary IASP
- Varied on and off with the Primary IASP
- Used to isolate journal receivers from the data (similar to a Basic ASP)

Library name space

*SYSBAS

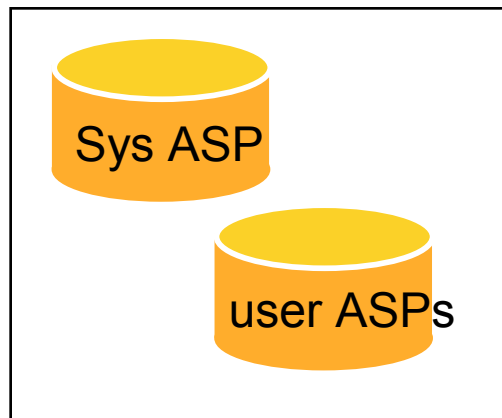

IASPs can be grouped together into an ASP group. *SYSBAS and an ASP group together becomes the "library name space"

ASP Group

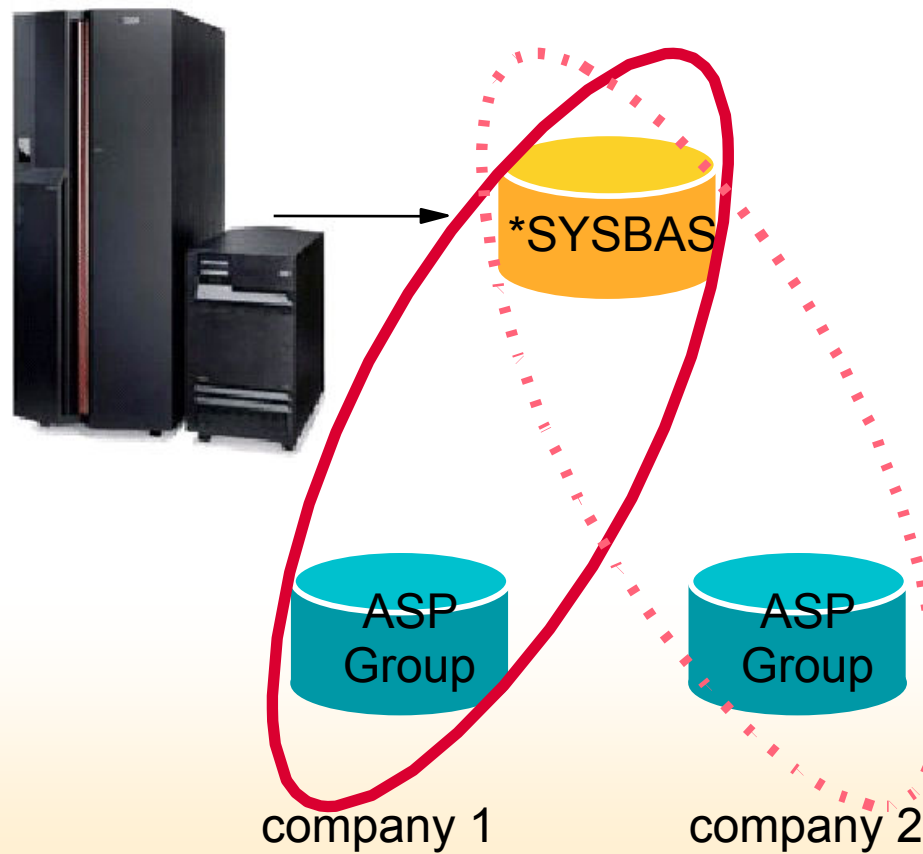
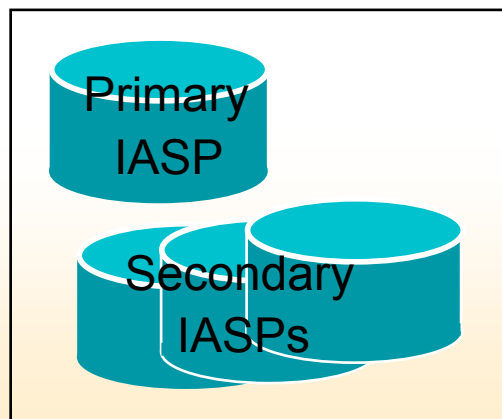

Multiple Databases = Multiple Name Spaces

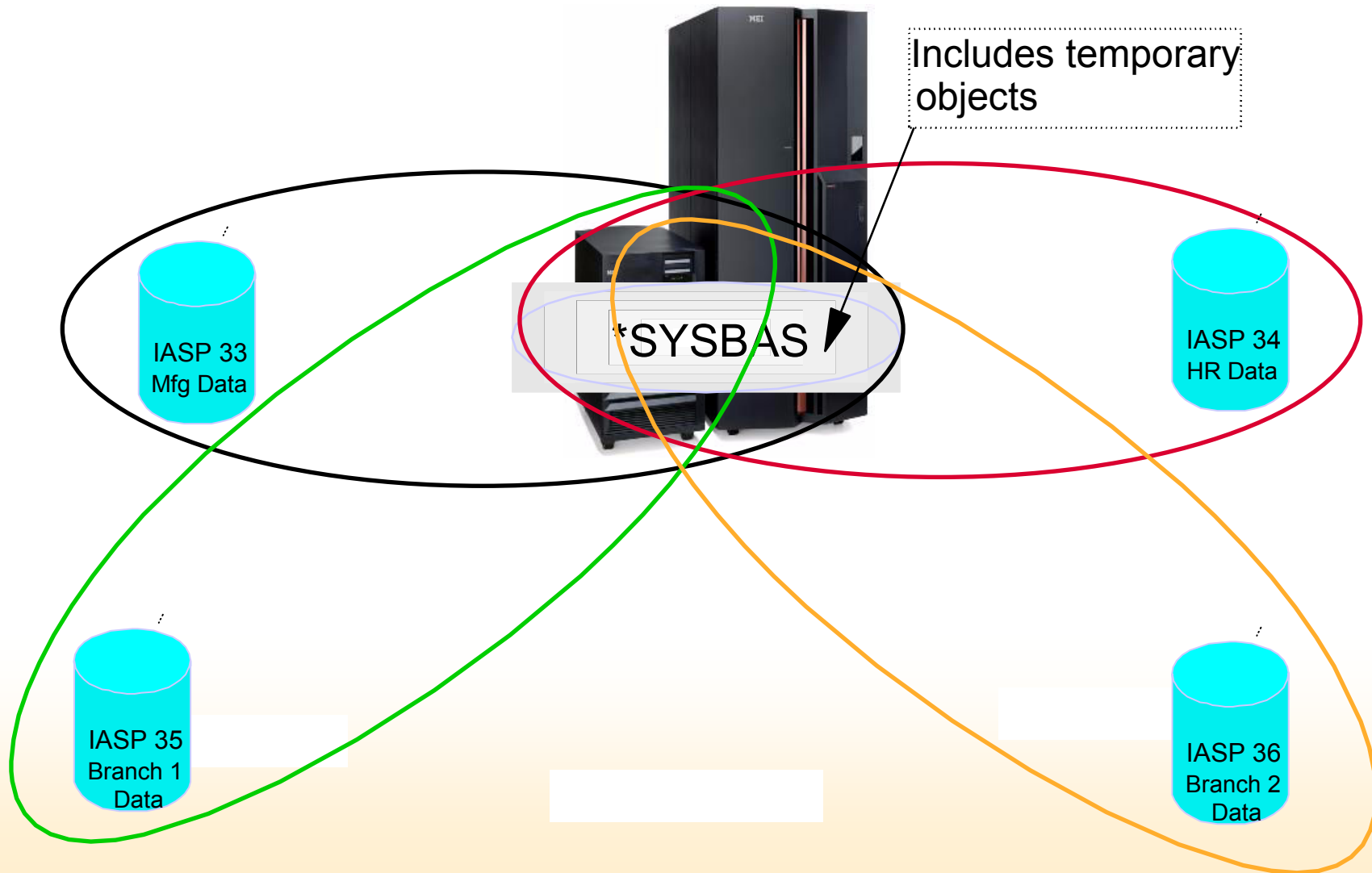

IASP Object Types

Supported

*ALRTBL +	*FTR	*PGM +
*BLKSF	*GSS	*PNLGRP
*BNDDIR	*IGCDCT	*PSFCFG
*CHTFMT	*JOBID +	*QMFORM
*CHRSF	*JRN	*QMQRV
*CLD	*JRNRCV	*QRYDFN
*CLS +	*LIB +	*SBSD +
*CMD	*LOCALE	*SCHIDX
*CRQD	*MEDDFN	*SPADCT
*CSI	*MENU	*SQLPKG
*DIR	*MGTCOL	*SQLUDT
*DSTMF	*MODULE	*SRVPGM
*DTAARA	*MSGF	*STMF
*DTADCT	*MSGQ +	*SVRSTG
*DTAQ	*NODGRP	*SYMLNK
*FCT	*NODL	*TBL
*FIFO	*OUTQ	*USRIDX
*FILE +	*OVL	*USRQ
*FNTRSC	*PAGDFN	*USRSPC
*FNTTBL	*PAGSEG	*VLDL
*FORMDF	*PDG	*WSCST

NOT Supported

*AUTHLR	*JOBQ
*AUTL	*JOBSCD
*CFGL	*LIND
*CNL	*MODD
*COSD	*M36
*CRG	*M36CFG
*CSPMAP	*NTBD
*CSPTBL	*NWID
*CTLD	*NWSD
*DDIR	*PRDAVL
*DEVD	*PRDDFN
*DOC	*PRDL0D
*EDTD	*RCT
*EXITRG	*SOCKET
*FLR	*SSND
*IGCSRT	*S36
*IGCTBL	*USRPRF
*IPXD	

Virtual Tape

Announced Feb 06

- Integrated with i5/OS - V5R4 onwards
- Similar performance as save/restore to/from a save file
- Eliminates save file limitations
 - Single library only
 - No savsys capability
 - No parallel support
 - Size limitations
- Virtual tape volumes managed:
 - Using existing Image Catalog commands (used for virtual optical)
 - Using iSeries Navigator GUI
- Virtual tape volumes stored as IFS stream files
 - Can be FTP'ed to other systems and partitions
 - Can be duplicated to real tape devices (DUPTAP)

Considerations

- Additional DASD Requirements
- No Install from SAVSYS Virtual Volume
 - D-IPL Only from Media
- May Not Be Faster
 - Tape Technology
 - System Configuration and Environment
- Data Compaction Not Supported
- Data Compression Support
 - DTACPR(*YES) Parameter on Save Commands
 - Default is *NO
 - Significant Performance Impact if S/W compression used

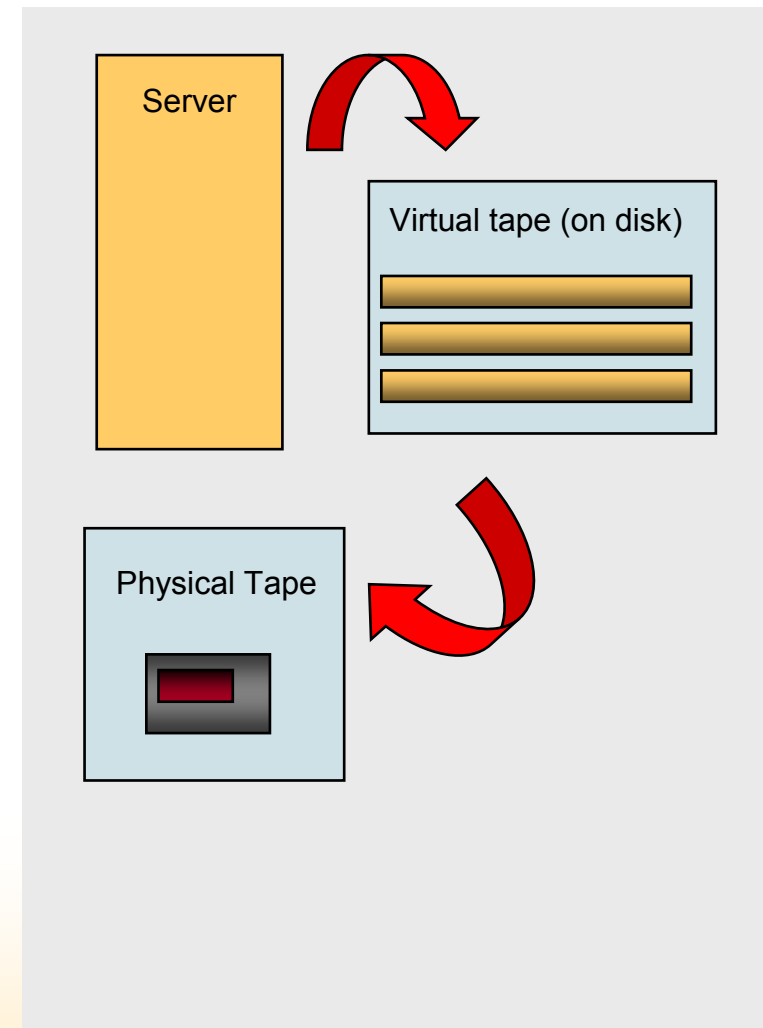

New with V5R4: Virtual Tape

Image catalog

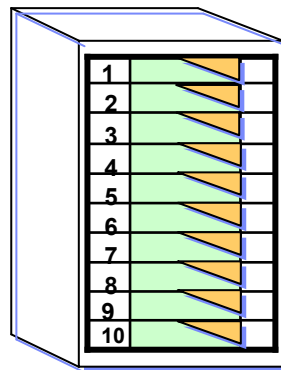

Up to 256
virtual tape
volumes

LODIMGCLG



Virtual
Tape
Device

Save/Restore

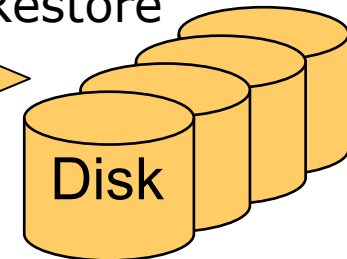

Any ASP or iASP

Save/Restore Performance Benchmarks

See Chapter 15 of the Performance Capabilities Reference manual for benchmark details.

This publication can be found at the following url: <http://www-03.ibm.com/servers/eserver/series/perfmgmt/resource.html>

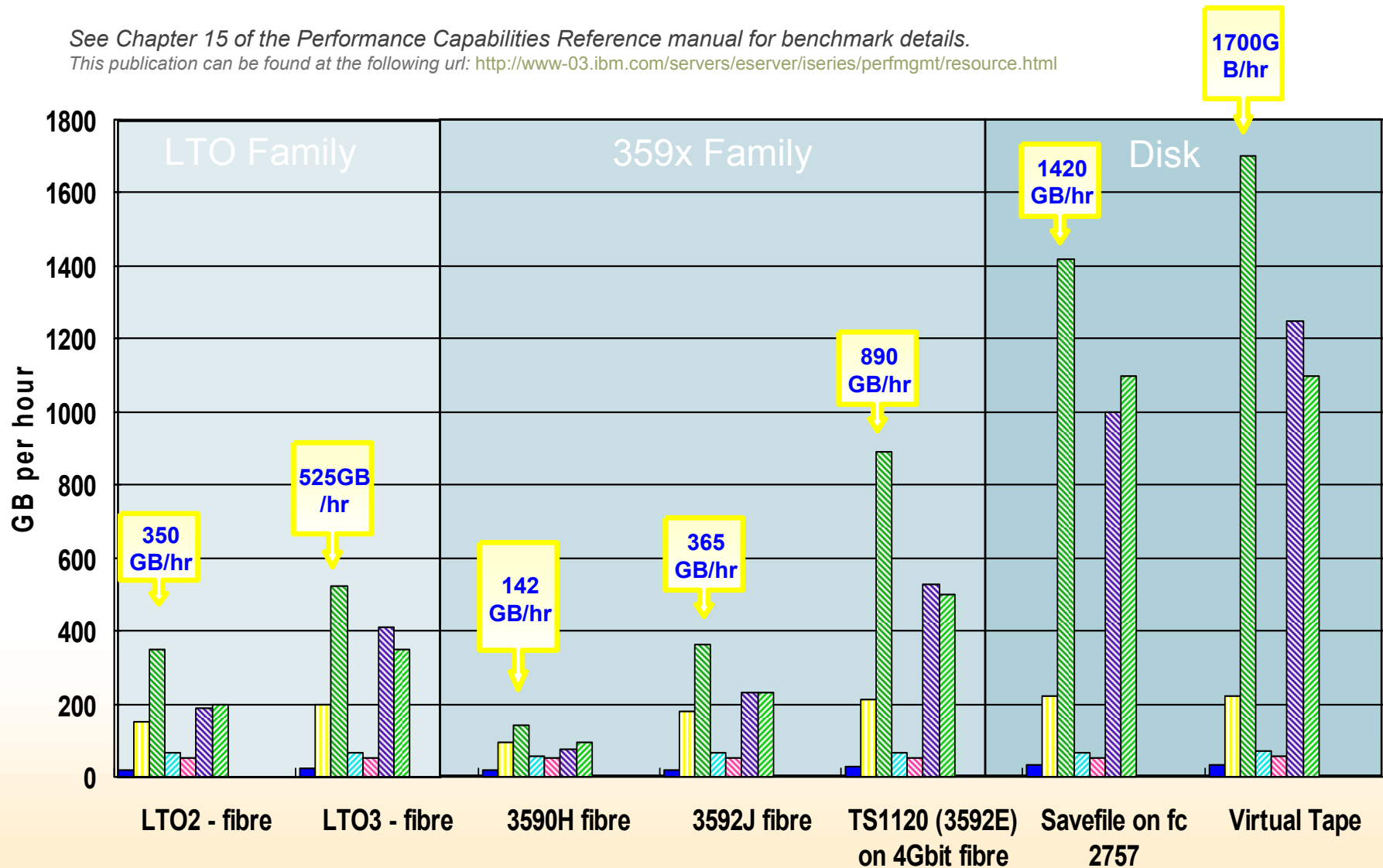

IBM DataMirror iCluster®

- **IBM i5/OS logical replication product**
 - Software based solution
 - Optimized for near continuous data recoverability
 - Can provide unlimited geographic dispersion
 - Selectable object replication for lower bandwidth

- **IBM DataMirror iCluster**
 - Asynchronous data replication for disaster recovery
 - Can be adapted for high availability operations
 - Backup copy available for tape backups & data access
 - Active-Active replication with iBalance

- **IBM DataMirror iCluster SMB**
 - Near continuous data recoverability for SMB customers
 - Backup copy available for tape backups & data access

- **Benefits**
 - Software based HA/DR solution from IBM
 - SMB customers looking for basic data recoverability

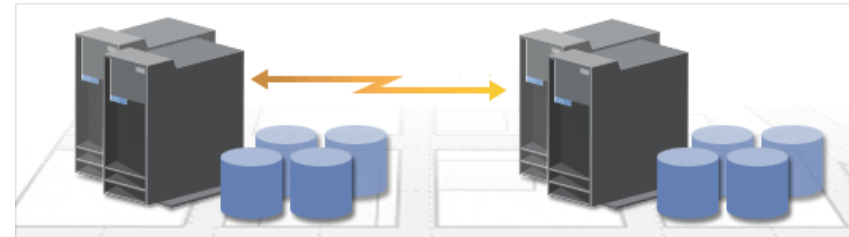

Supported Releases

- IBM i V6R1, V5R4, V5R3

Product Number

- 5733-ICL
- 5733-ICS

Prerequisites

- IBM i Option 12, Host Servers
- IBM TCP/IP Connectivity Utilities



IBM iCluster for i Enhancements

- **IBM i product for disaster recovery**
 - Software based logical replication solution

- **iCluster offering simplification**
 - One product top to bottom
 - iCluster SMB withdrawn Dec 31
 - Price reduced/aligned with PowerHA

- **iCluster 5.2**
 - Usability & performance enhancements
 - Faster switching and startup
 - Sync check consolidation and automation
 - Now uses System License Keys
 - PTFs generated and installed with i

- **Benefits**
 - IBM product with IBM support
 - Scalable from small enterprises to large

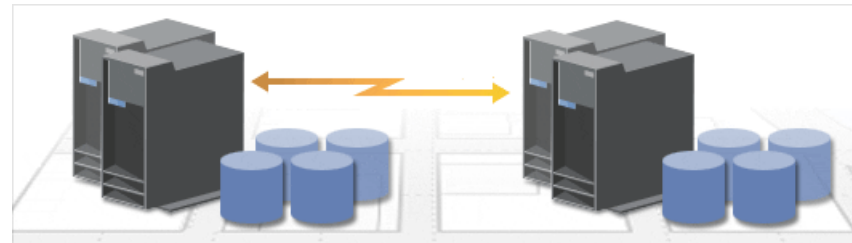

Announce:
GA:

Oct 7
Nov 14



PowerHA for i

- **IBM storage based clustering product**
 - Can enable near continuous application service
 - Minimize impact from planned & unplanned outages
 - Simple Web-based management

- **IBM® i and SAN based mirroring**
 - IASP data synchronously replicated for Cross Site Mirroring
 - Geographic Mirroring – IBM i synchronous mirroring
 - Metro Mirror - DS8000™ synchronous mirroring
 - Global Mirror - DS8000 asynchronous mirroring

- **IBM i Cluster Management**
 - Enables automatic or manual failover
 - Keeps systems in sync
 - Establishes a heartbeat between the systems
 - Backup recovery operations via Flash Copy

- **Benefits**
 - Hardware based HA/DR solution from IBM
 - Solution requiring minimal day to day administration
 - Trusted on demand role swap operations
 - Many commercial applications IASP enabled
 - Estimate over 500 IASP solutions deployed

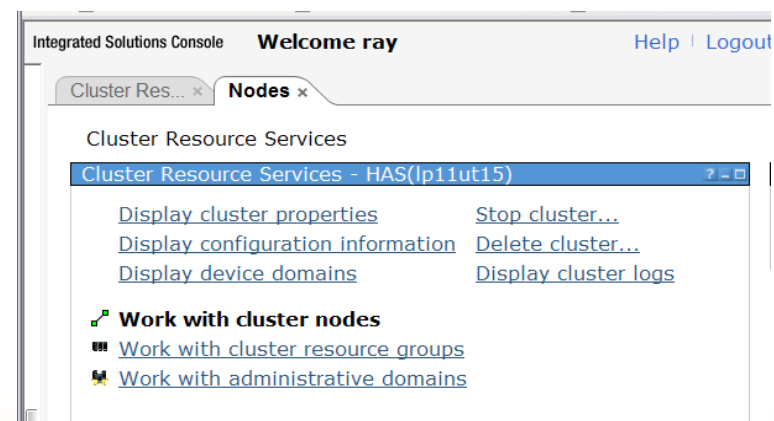
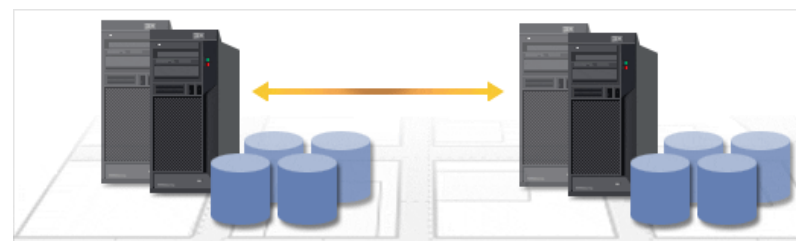

Supported Release
V6R1

Prerequisites
HA Switchable Resources (option 41)

Product Structure

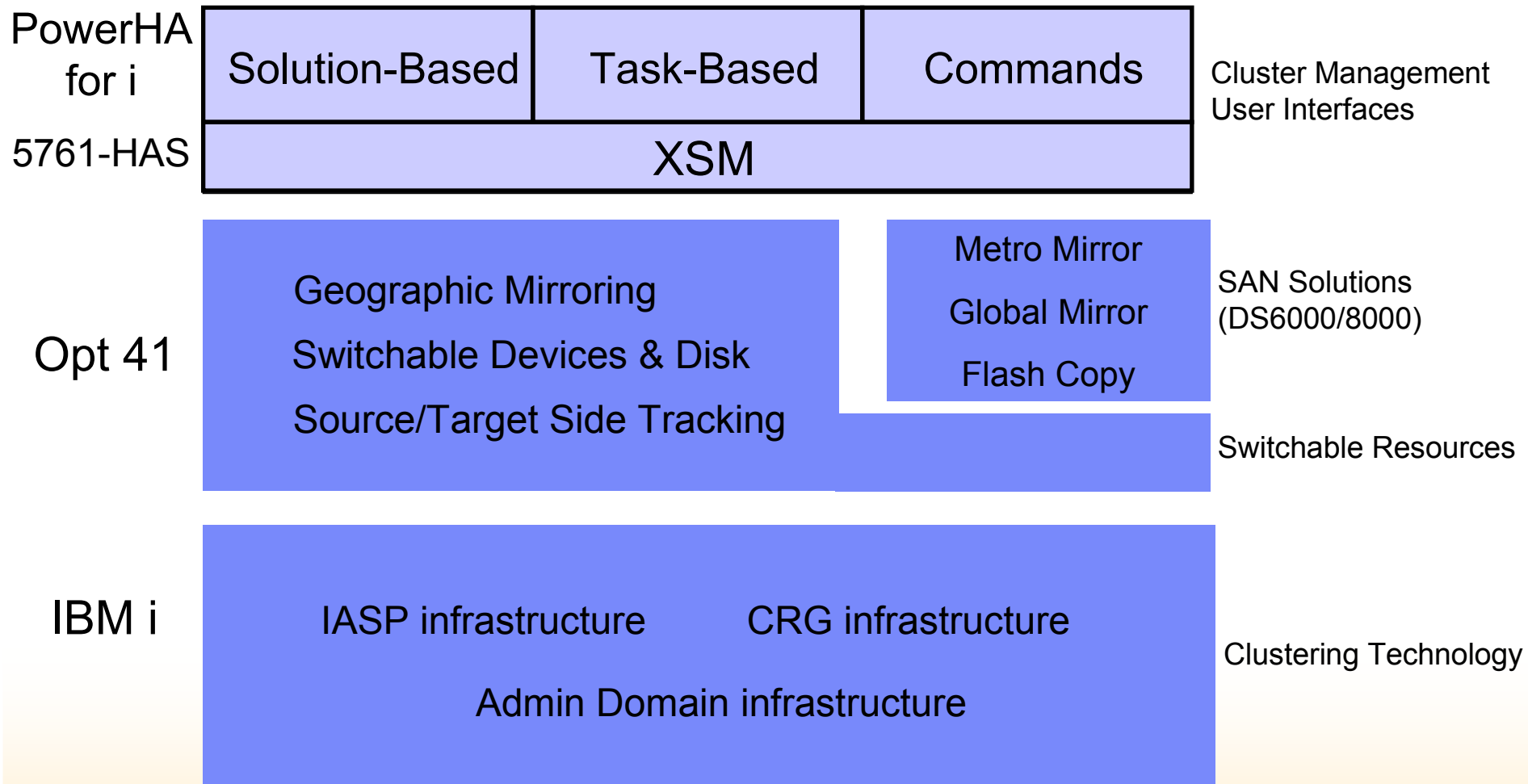

IBM and System i SAN Focus

Continuous, consistent IBM investment

- 4GB Smart IOA Dual Port (IOPless)
- IPL from Tape via SAN
- Tagged Command Queuing
- Header Strip Merge
- 4 Gb Fiber
- Advanced 'DS on iSeries' education
- SAN on iSeries Redbook - 3
- BRMS support for FlashCopy environment
- Boot from San (2847 IOA)
- CLI - Command Line Interface
- Additional i5/OS LUN sizes for increased flexibility
- SAN on iSeries Redbook - 2
- i5/OS Multipath fiber
- 2Gb fiber
- iSeries Copy Services for IBM TotalStorage (a.k.a. Toolkit)
- Disk Magic and OS/400 Performance Tools coordination
- Enhance ESS cache algorithms for iSeries
- SAN on iSeries Redbook - 1
- 1 Gb Fiber

...and more to come....

2008

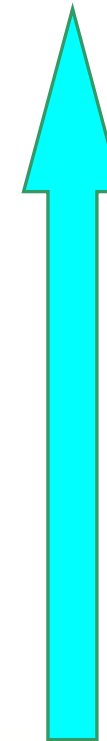

2001

IBM i Storage Directions

Historically

Integrated plus High End External Storage

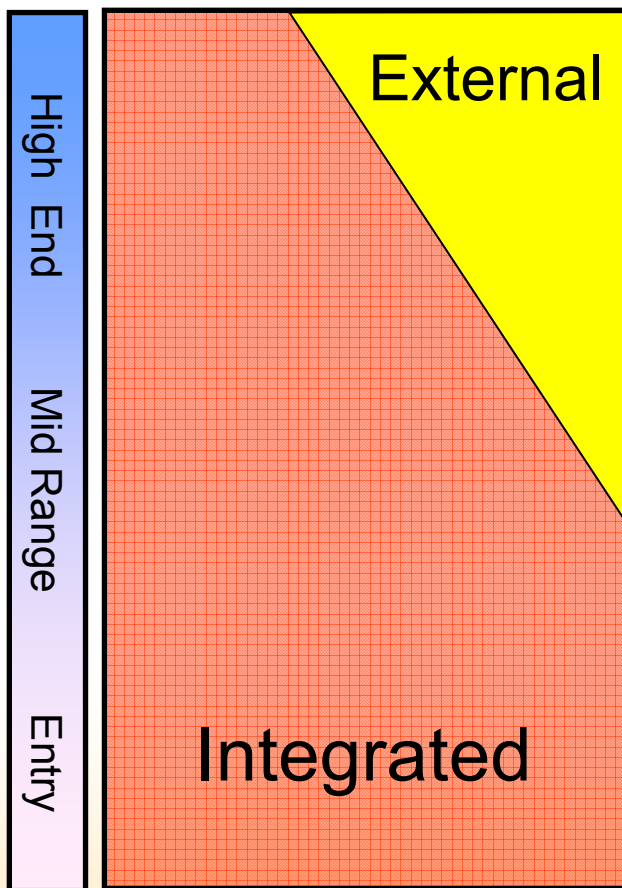

POWER6 and beyond

Complementary Options

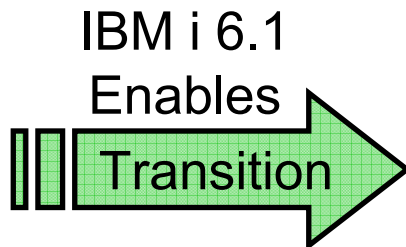
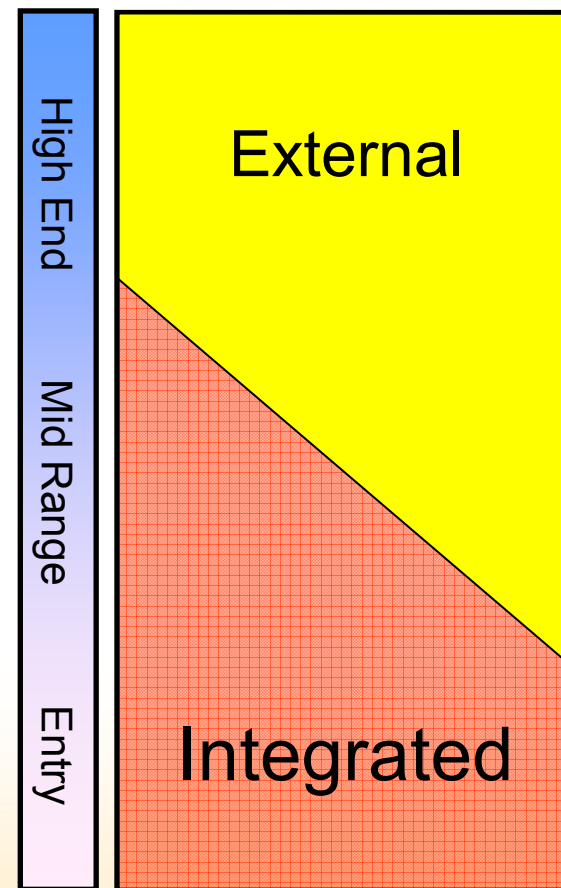

Flexible SAN Options on POWER6 via Fibre

- **DS8000 Enterprise Storage Solution**

- Supported on #5749, #5774 new dual port Smart-IOA card and earlier FC card generations

- **DS6000 Midrange to Enterprise Storage Solution**

- Not supported on #5749, #5774 new dual port Smart-IOA card, earlier FC card generations provide support.

- **DS4000/5000 Midrange Storage Solution**

- Supported via VIOS running on POWER6 System i and JS12/JS22 Blades at V6R1



SAN Enhancements



- **New Fibre Channel Adapters**
 - 4Gbit, IOless, Dual Port Adapters
 - Improve performance
 - Increase capacity with up to 64 LUNs per port (8-fold increase in density!!)
 - Enhance flexibility with support for disk & tape attachment
 - Add support for booting off tape
 - IBM i V6R1, POWER6 systems, and DS8000

- **Support for IBM's Midrange Storage Solution**
 - DS4700, DS4800 and DS5000 supported by VIOS with IBM i virtual partitions



Greatly Enhanced SAN Disk Performance for IBM i

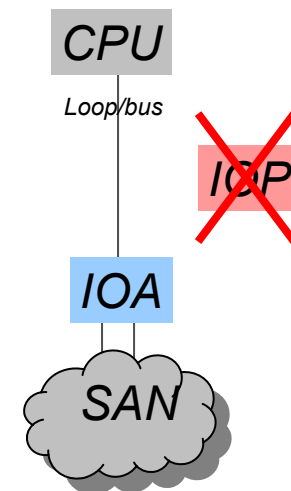
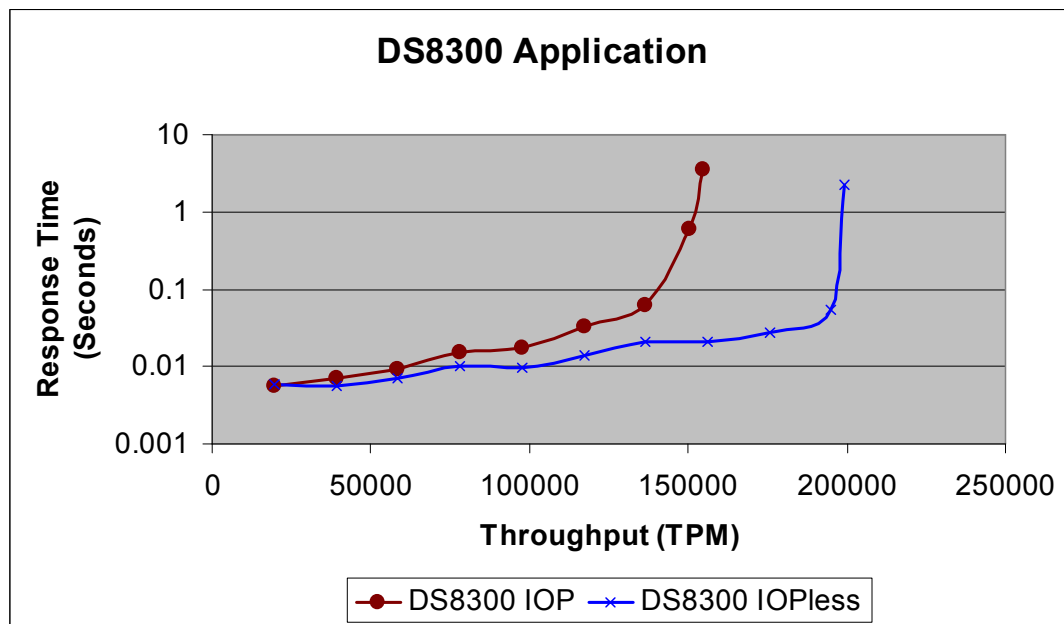

- Configuration the same except the Fibre Channel cards.
- 8 IOP-IOA pairs replaced by 4 smart IOAs.
- Smart IOA performance wins.



Current SAN implementation

- Multipath IOP/IOA combination connection to external storage
- This just a graphic and does not represent an actual config

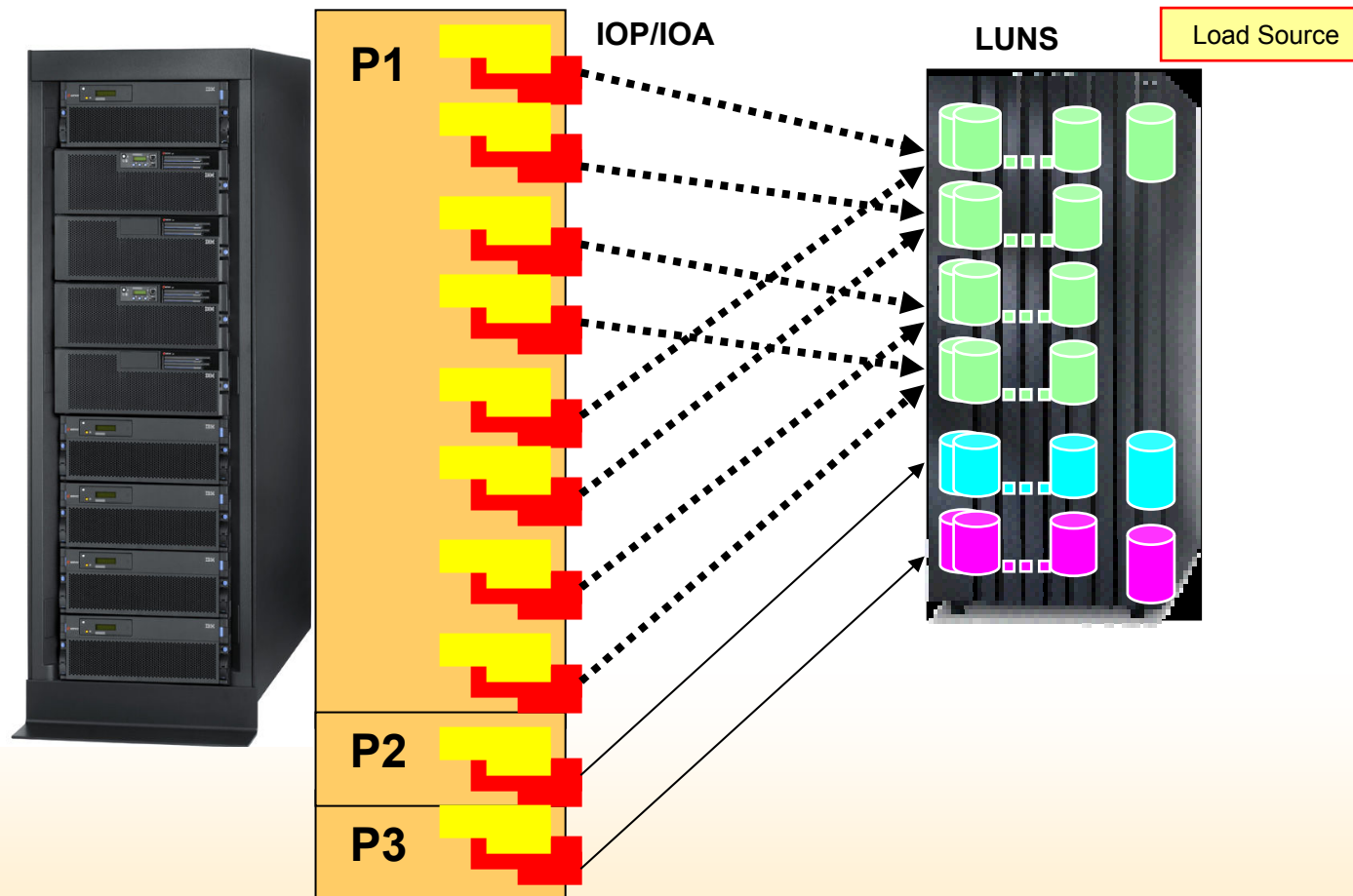

POWER6 and V6R1 SAN implementation

- Multipath Smart IOA combination connection to external storage

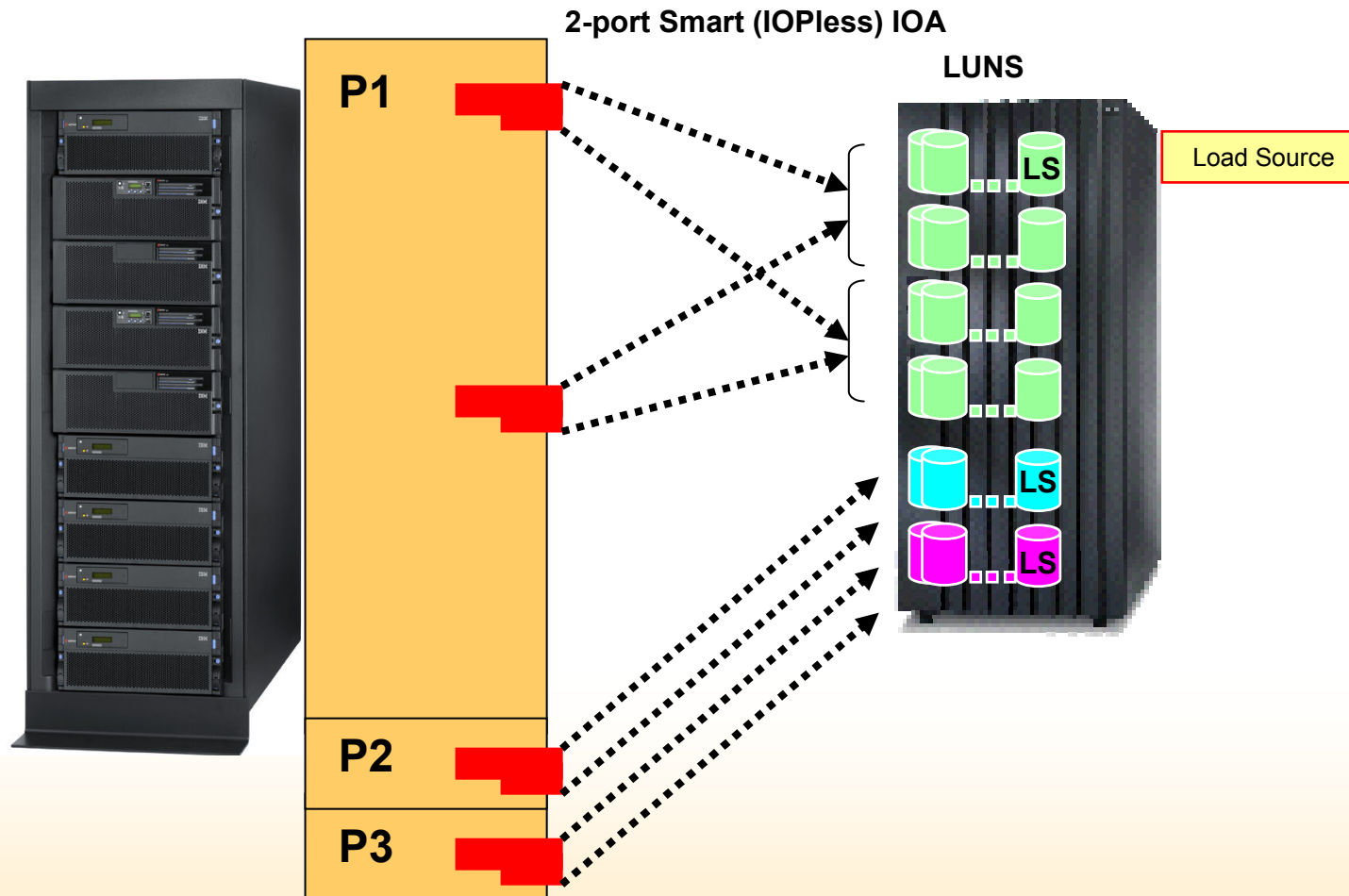

* All statements regarding IBM's future direction and intent are subject to change or withdrawal without notice, and represent goals and objectives only.

VIOS Storage Connectivity Big Picture

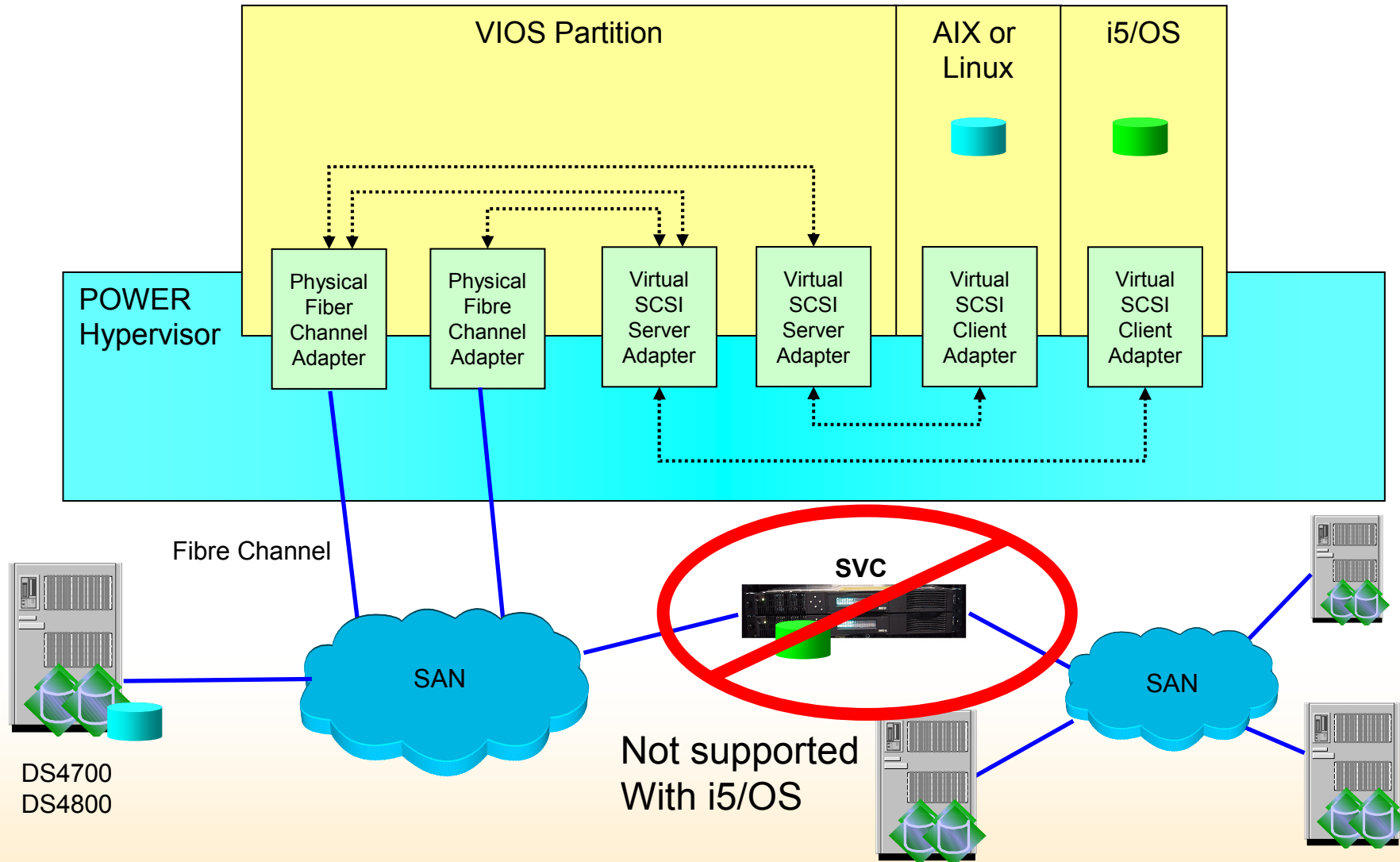

Assess System i Availability Technologies

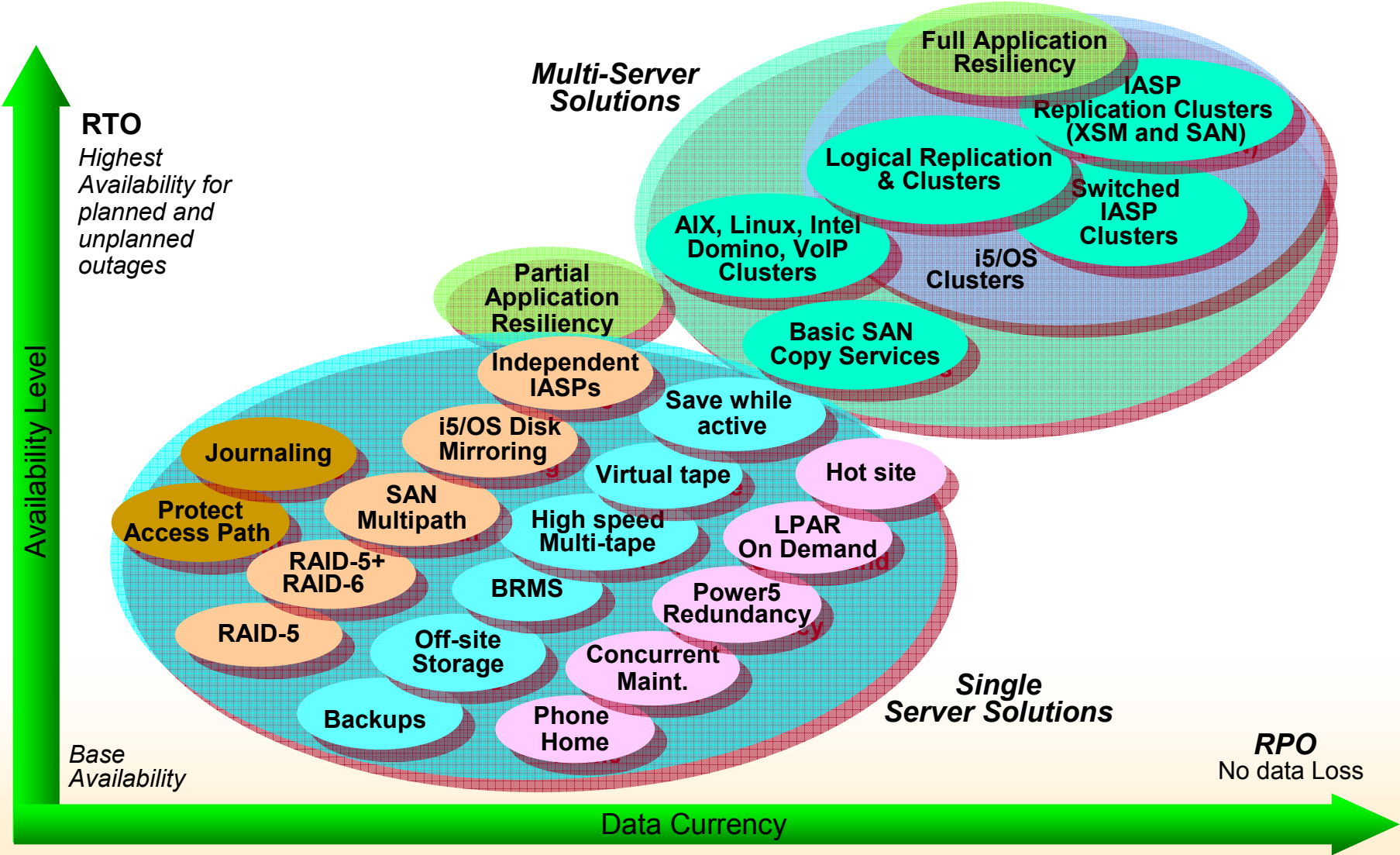

IBM i Data Resiliency Positioning

Logical replication

OS based replication

Storage based replication

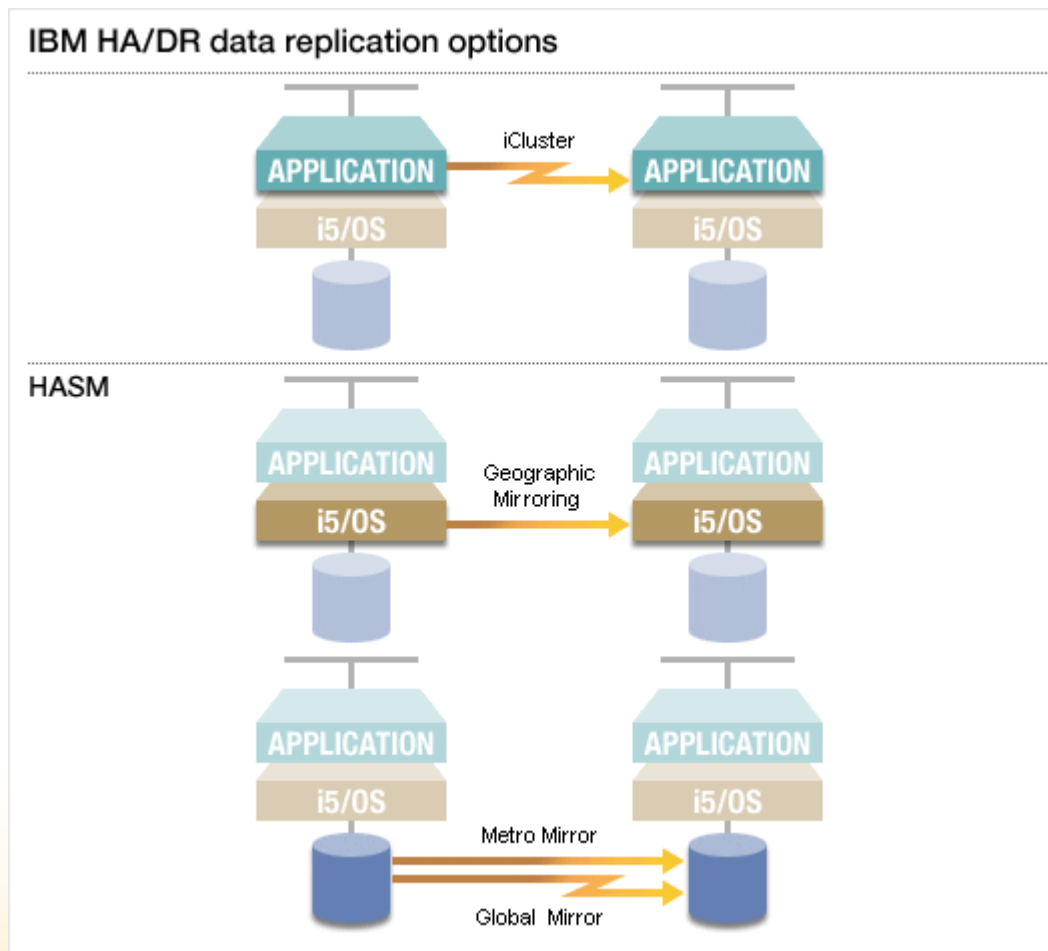

Asynchronous
Journal based replication
Over TCP/IP
Disk subsystem agnostic

Synchronous
IBM i based replication
Over TCP/IP
Disk subsystem agnostic

Synchronous or Asynchronous
Storage-based replication
Over Fiber Channel or FCIP
DS8000,DS6000™

IBM i5/OS Multi System Data Resiliency

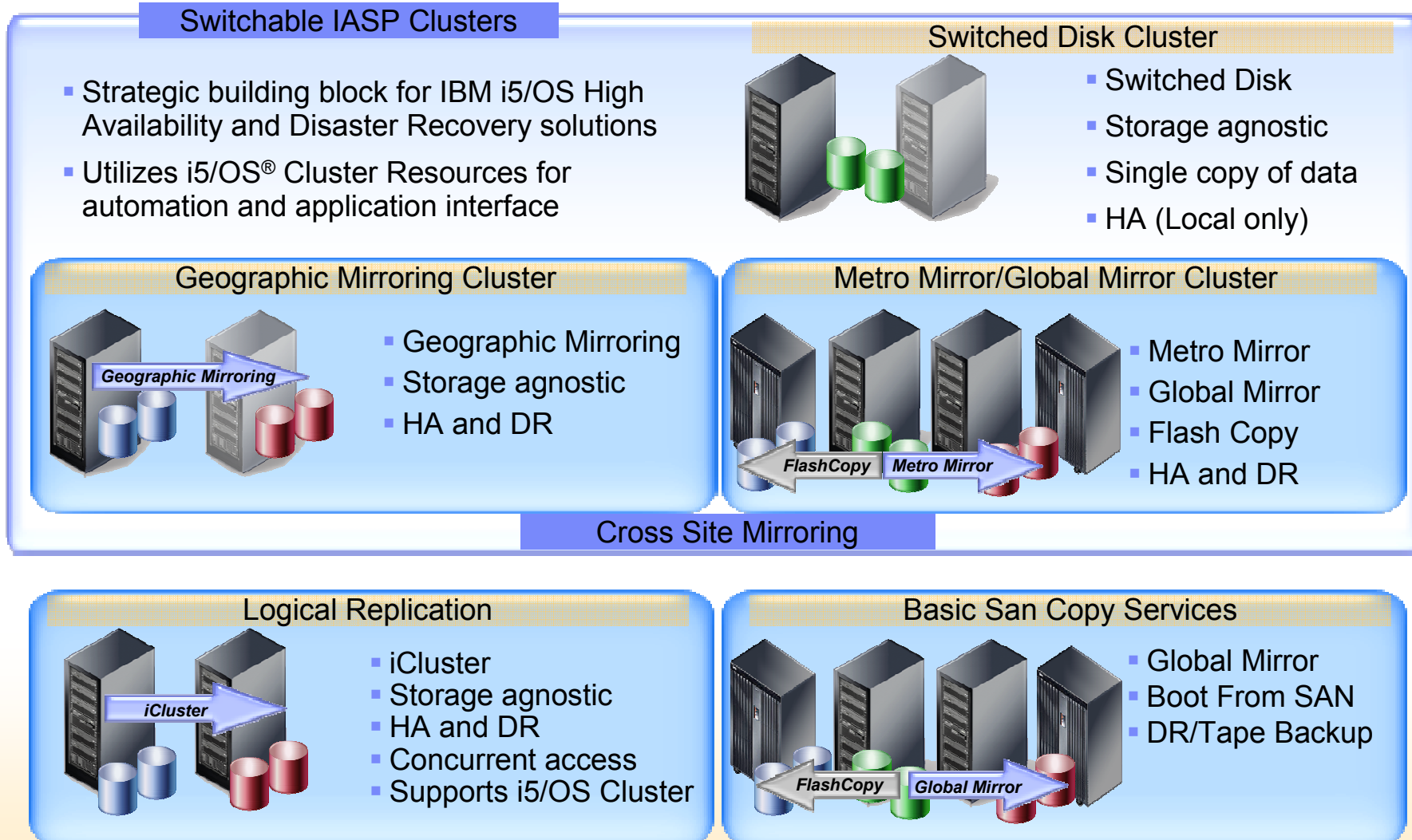

System i Availability Strategy - IASPs

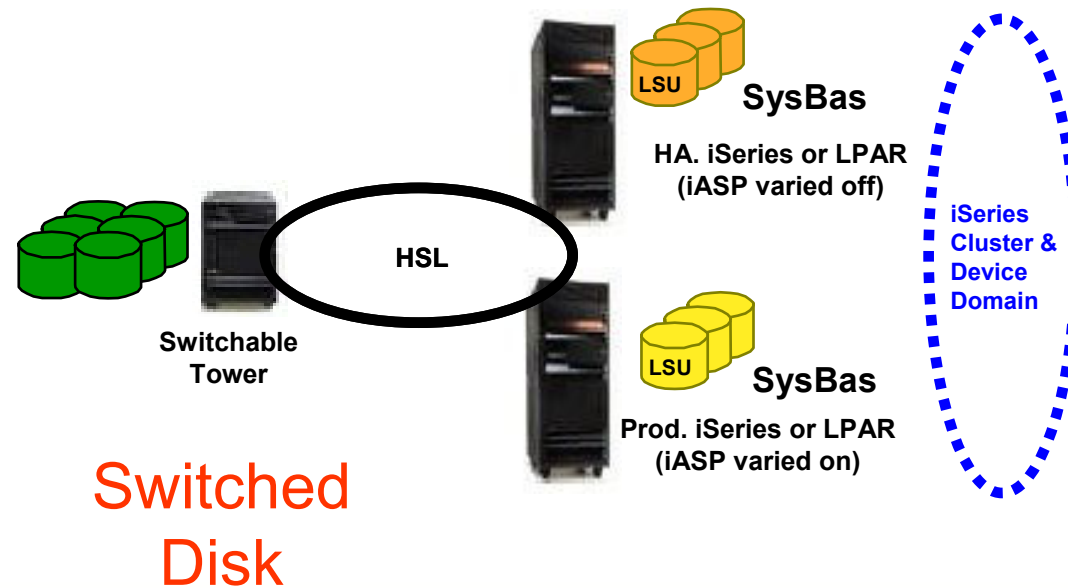

System i Availability Strategy - IASPs

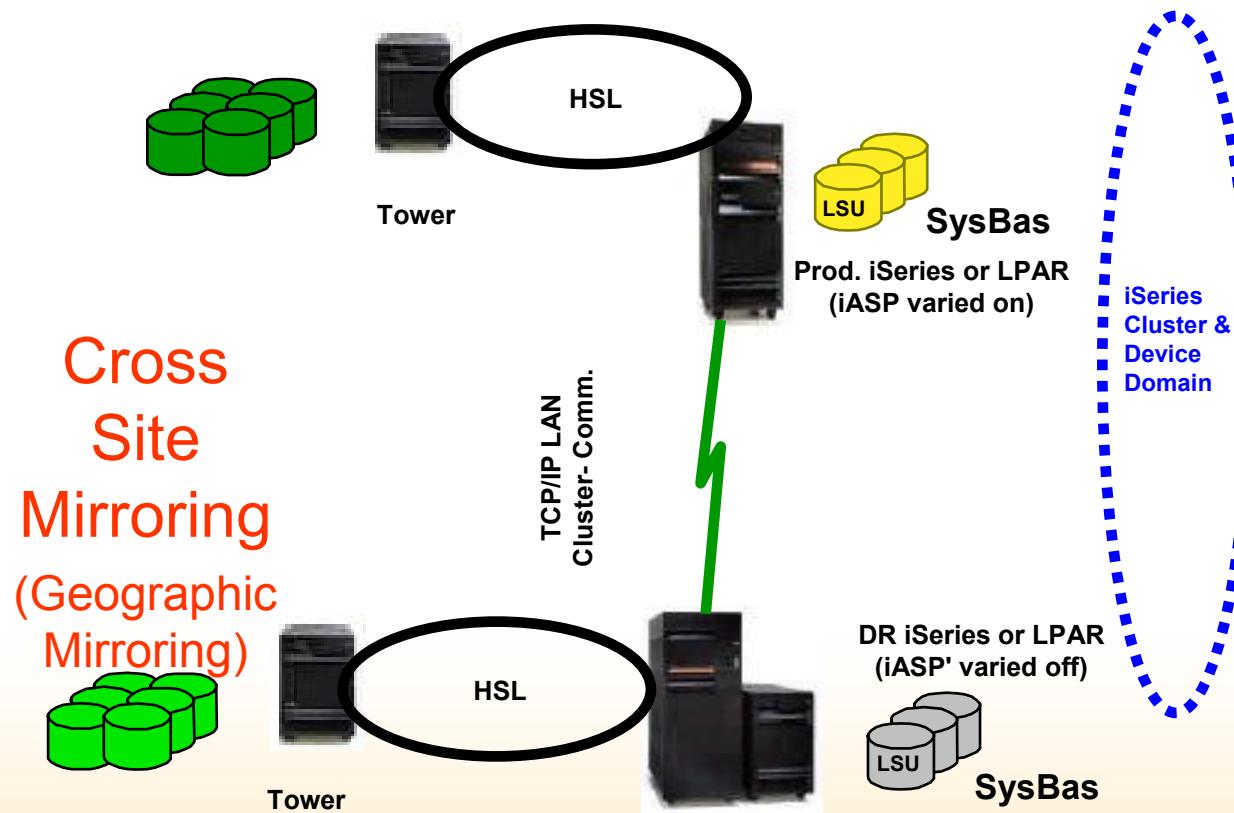

System i Availability Strategy - IASPs

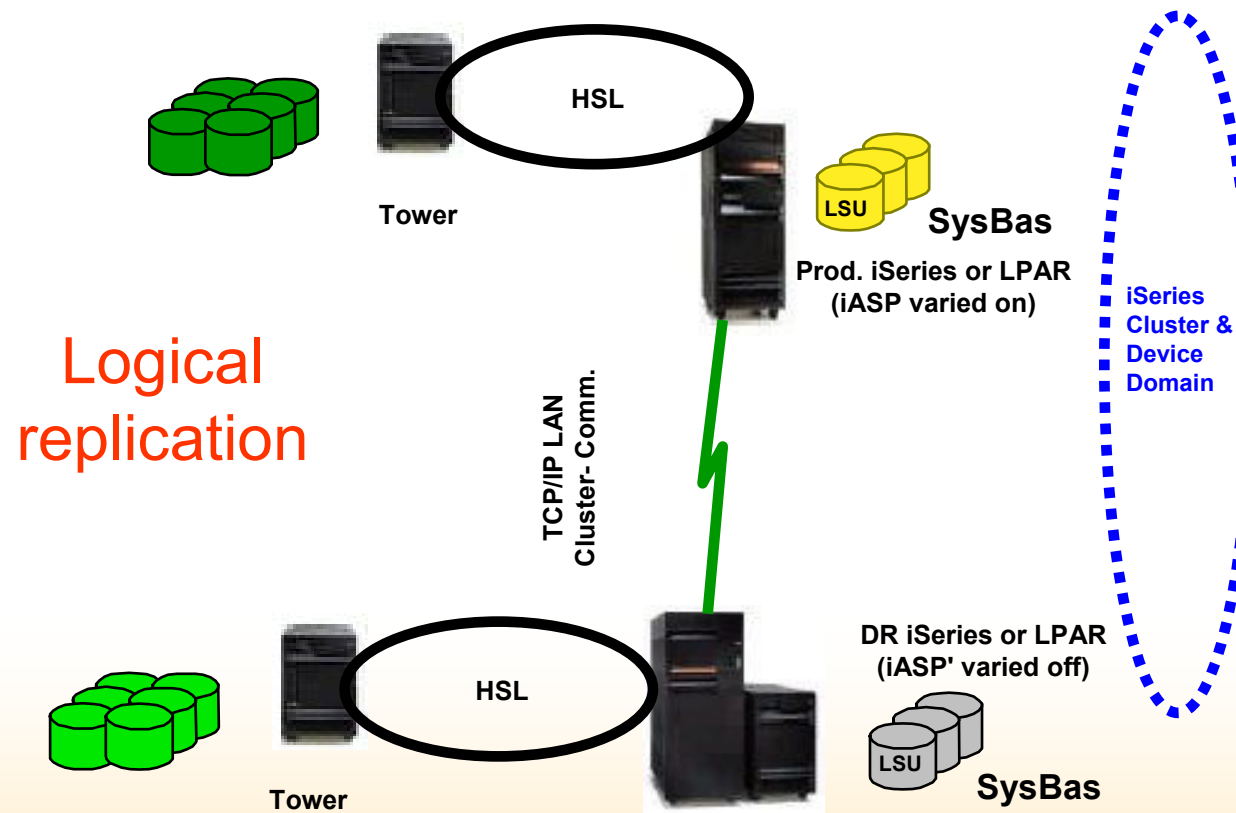

System i Availability Strategy - IASPs

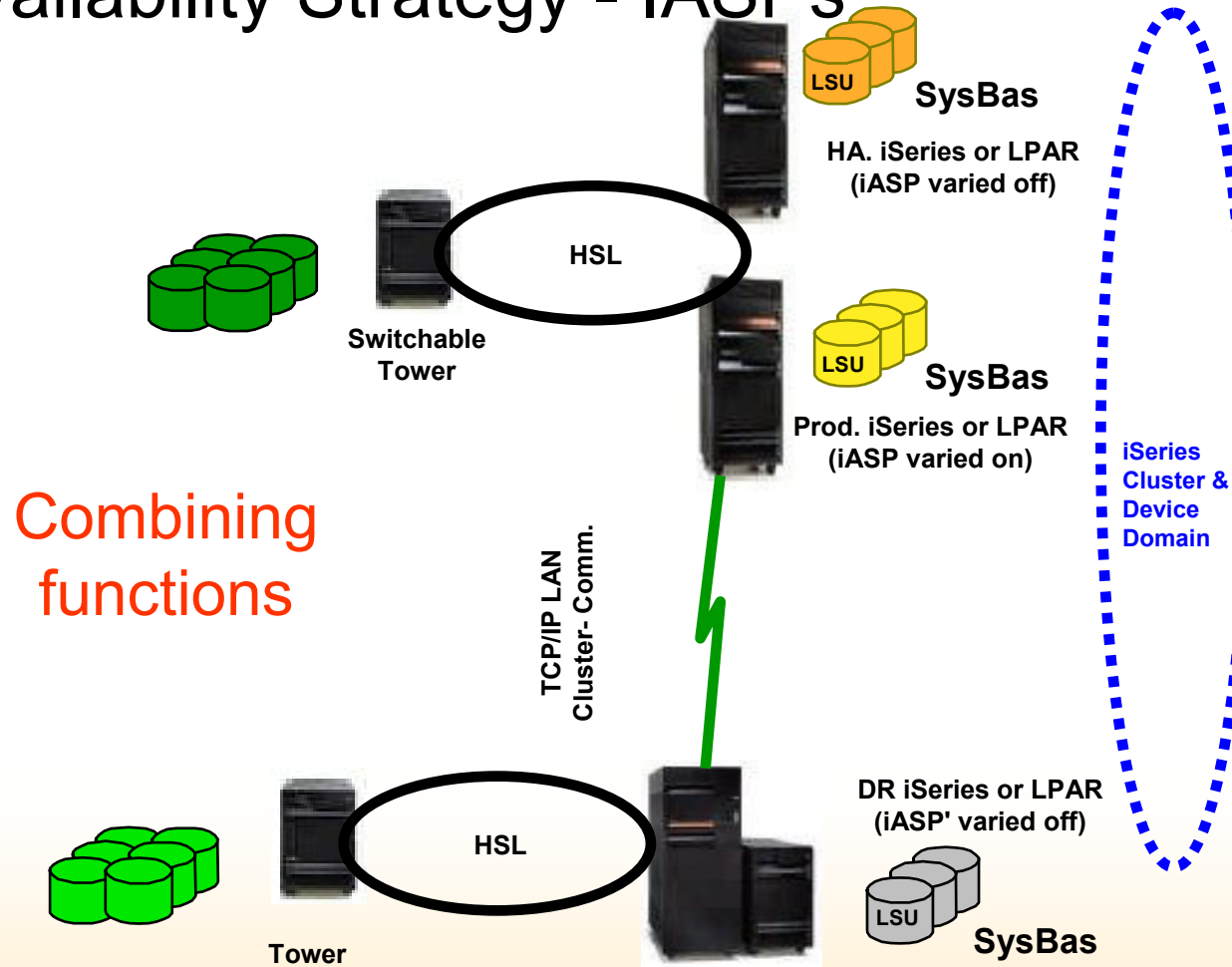

Data and Disaster Center Availability with Metro or Global Mirror (with Copy Services Toolkit)

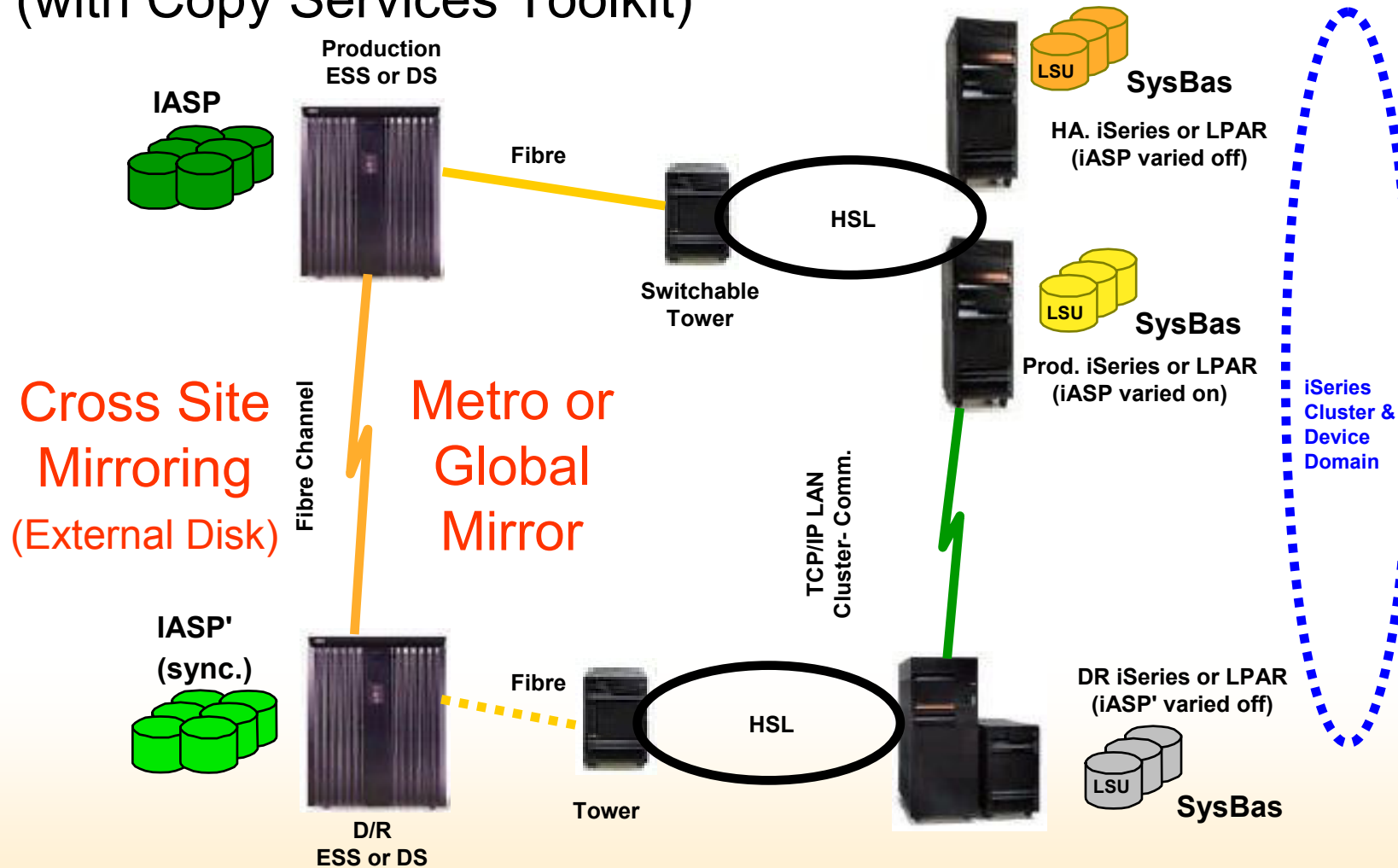

IBM i Business Resiliency Choices

Features, Benefits and Considerations

Feature	Benefit	Products	Considerations
Storage-Based	<ul style="list-style-type: none"> ✓ Replication of all data written to disk ✓ Virtually unlimited geographic distance when using asynchronous ✓ Generally implemented for DR and HA (synchronous) ✓ Can be cluster controlled ✓ Synchronous (Metro Mirror only) or asynchronous network transmission (Global Mirror only) ✓ No manual management of replicated objects required ✓ FlashCopy means second copy of data can be used for fast backups, development, testing, etc. ✓ Order of changes is preserved via DS8000 and Metro Mirror ✓ Resolution of out of synch conditions (objects or data) is under control of DS8000 	<p>IBM Metro Mirror IBM Global Mirror IBM FlashCopy®</p> <p><i>Can be used alone or with IASPs & Toolkit</i> <i>Note: used with IBM TotalStorage® DS8000</i></p>	<ul style="list-style-type: none"> • Network Bandwidth (all data and objects are replicated to second system) • Only supported via external SAN storage • No concurrent access to second copy of data • IF not using IASPs, system IPL required for switching to backup copy • Additional disk for Consistency Groups (Global Mirror only)
Operating System-Based	<ul style="list-style-type: none"> ✓ Page replication controlled by operating system ✓ Ordering of changes is preserved by the operating system ✓ No manual management of replicated objects required ✓ Synchronous network data transmission ✓ Is cluster controlled ✓ Supports external or internal storage ✓ Only vary on of IASP is required for switching to backup system ✓ Resolution of out of synch conditions (objects or data) is under control of i5/OS ✓ Generally implemented for HA 	<p>Independent Auxiliary Storage Pools (IASP) Cross Site Mirroring (XSM) High Availability Solutions Manager (HASM) (implemented with XSM and IASP) (V6R1 only)</p>	<ul style="list-style-type: none"> • Network Bandwidth (all data and objects in an IASP are replicated to the second system) • Distance limitations • No concurrent access to second copy of data • Prior to V5R4 no source side tracking • Requires IASP implementation
Logical Replication	<ul style="list-style-type: none"> ✓ Selective data/object replication may reduce network overhead ✓ Virtually unlimited geographic distance ✓ Concurrent access to second data copy (for backups, read only access, etc.) ✓ No special hardware configuration requirements ✓ Choice of synchronous or asynchronous network transmission of data (synchronous only with remote journaling) ✓ Generally implemented for DR and HA ✓ Can be cluster controlled ✓ Can be used alone or with other HA technology choices ✓ Supports external or internal storage ✓ No IPLs required for switching. When used in conjunction with IASP—vary on of IASP is required ✓ Ordering of changes controlled by HA ISV software interfaces 	<p>IBM: IBM DataMirror iCluster Maximum Availability: www.maximumavailability.com Trader's: http://www.quick-edd.com/uk/index_uk.htm Vision Solutions: http://www.visionsolutions.com</p>	<ul style="list-style-type: none"> • Possible apply lags on target system for changes in high volume environments • Management to ensure all new objects are replicated • Bandwidth has to be sufficient for replicated objects and data , and to ensure no data send lag • Resolution of out of synch conditions (data or objects) is not under control of i5/OS

IBM i V6R1 Quiesce Function

- Enables database suspend for any ASP
- Use for offline backup
- Especially valuable for IASP backup operations
 - Detach IASP in Geographic Mirror or FlashCopy
- Backup will still be considered 'abnormal' but much friendlier
- Works best with applications running commitment control
- Applications without commitment control may be OK but **TEST**

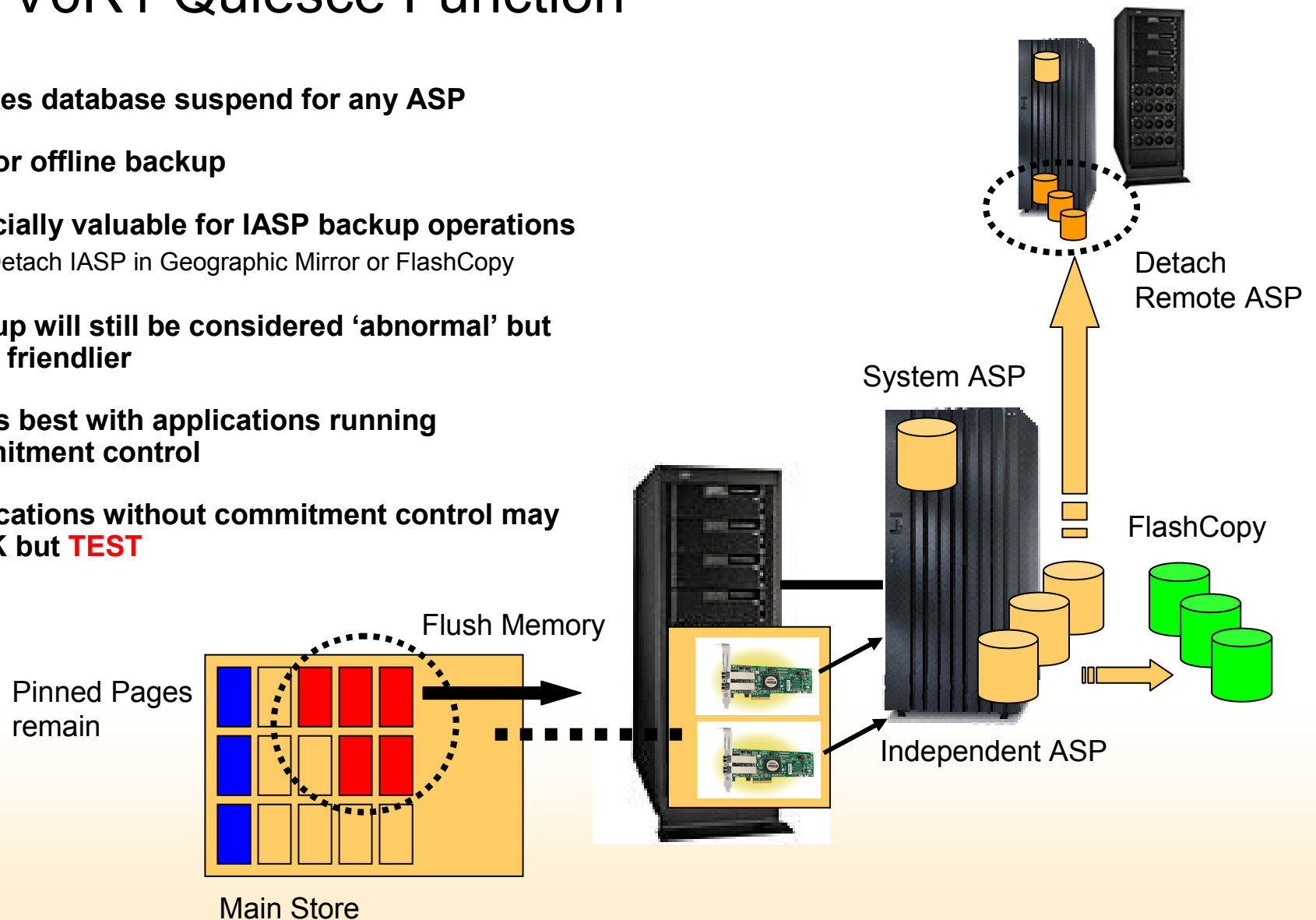

Data Resilience technologies - Logical Replication

Most widely deployed data resiliency topology for iSeries

- Typically deployed via an HA Business Partner solution package
 - E.g. Lakeview Technologies, Vision Solutions, Datamirror, Maximum Availability, iTera, Traders

Replication done on object basis (file, data area, program, etc.) near real-time

- OS/400 Journaling provides transport mechanism

Benefits:

- Rapid activation of production environment on backup server via role-swap operation
- Replicated data can be concurrently accessed for backups or other read-only apps
- Very flexible (any hardware, various OS release, most ISV software, etc.)

Considerations:

- Complexity of setup and maintenance
- Consistency between journaled and non-journaled objects

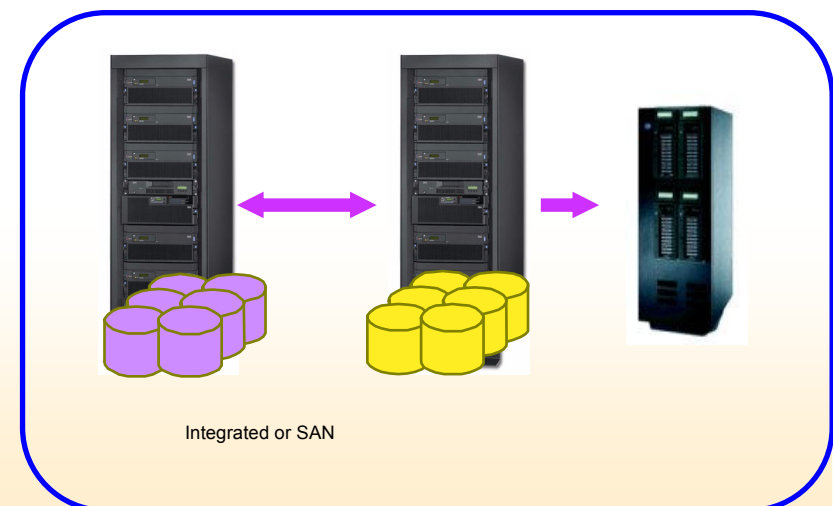

Data Resilience technologies – switchable iASPs

iASPs – Independent Auxiliary Storage Pools

- Switch disks between partitions or servers

Benefits:

- Provides support for planned maintenance

Considerations:

- Single point of failure – only one set of disks
- Limited by cabling distance
- No 'read-only' copy

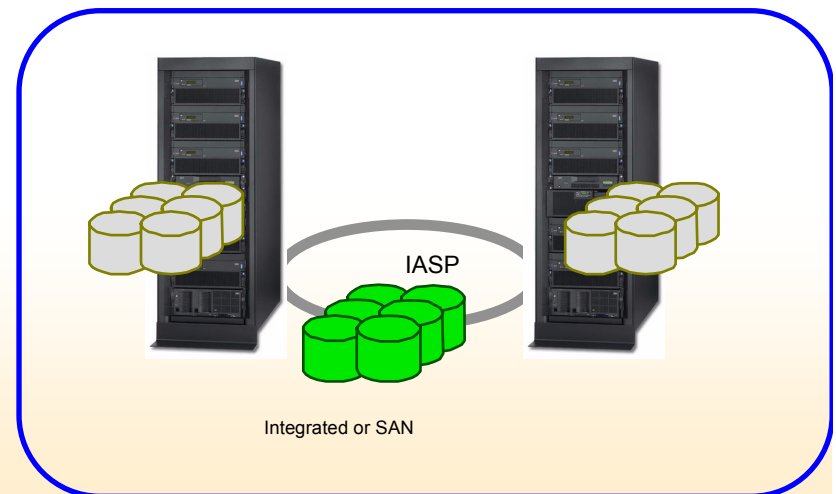

Data Resilience technologies – Cross Site Mirroring (XSM)

Utilises switchable iASPs

- Can be internal or external disk

Benefits:

- Only objects in iASPs are copied
- Simpler to manage – everything in iASP is copied

Considerations:

- Application must support iASPs
- Disks split between system ASP and iASPs
 - Plan for performance
- No 'read-only' copy on target side

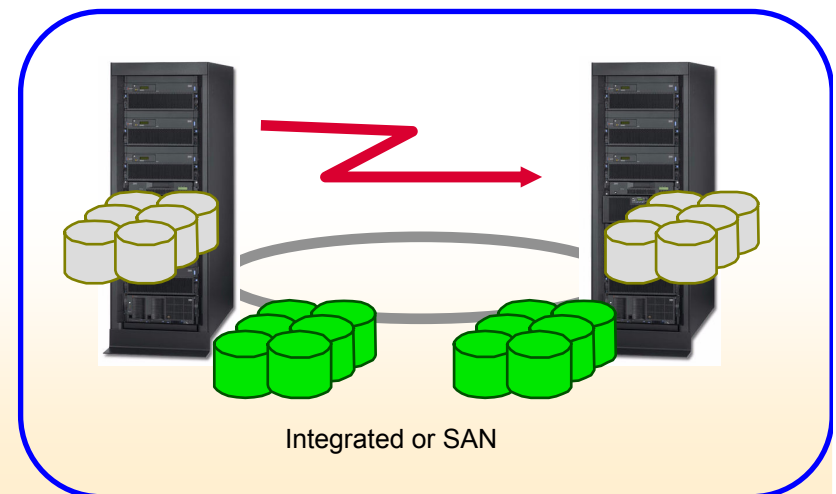

Data Resilience technologies – TotalStorage mirroring

SAN-based replication

- Bit level copy
- Synchronous (Metro mirror) or asynchronous (Global mirror)

Benefits:

- Standard cross-platform solution
- Simpler to manage – everything is automatically copied – but requires SAN skills

Considerations:

- To mirror entire system, requires boot from SAN – only supported on POWER5
- No 'read-only' copy on target side
- When role swap, abnormal IPL on target
 - D/R rather than HA solution
- If mirroring everything (temp objects, system objects)
 - Requires high bandwidth
 - > Consider combining with iASPs

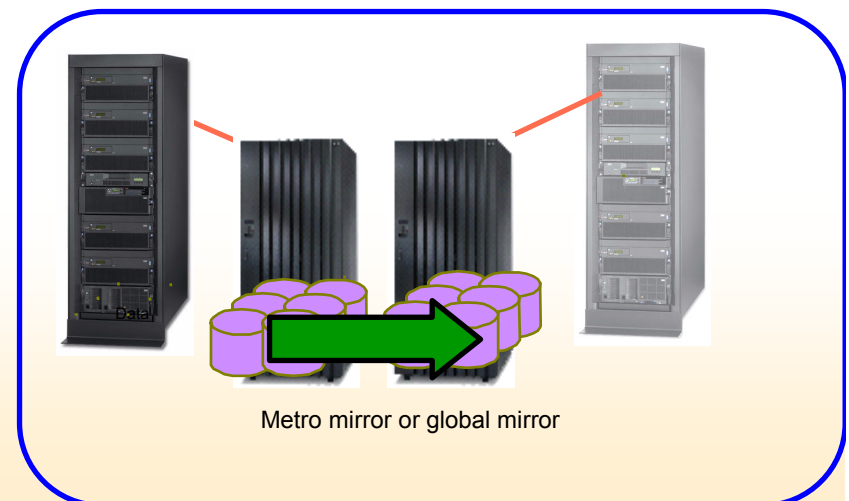

Data Resilience technologies – TotalStorage mirroring with iASPs and Copy services toolkit

SAN-based replication

- Bit level copy
- Synchronous (Metro mirror) or asynchronous (Global mirror)

Benefits:

- Standard cross-platform solution
- Only objects in iASPs are copied – less bandwidth required
- Simpler to manage – everything in iASP is copied – but requires SAN skills

Considerations:

- Application must support iASPs
- Disks split between system ASP and iASPs
 - Plan for performance
- No 'read-only' copy on target side
- Requires Copy services toolkit

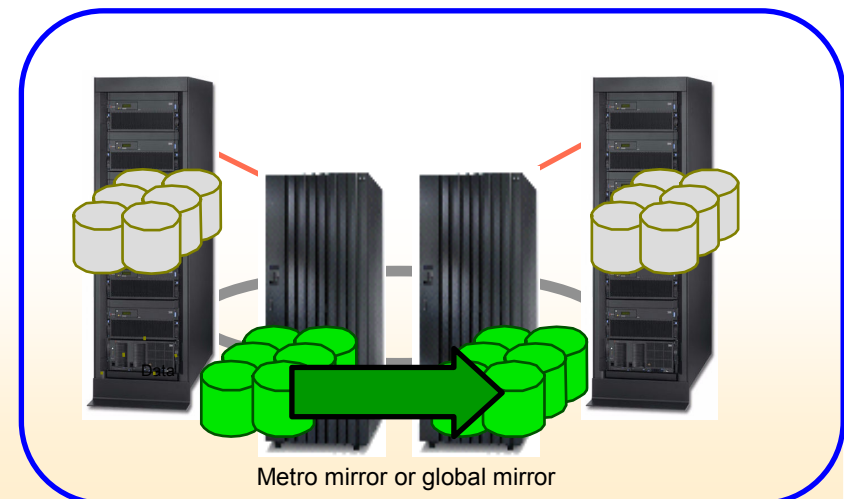

The New Capacity BackUp Edition Highlights

- ✓ Dramatic new flexibility enables CBU Editions to support the full range of business resiliency requirements from Disaster Recovery to High Availability
- ✓ Clients may now permanently activate standby processors to support additional applications or high availability operations
- ✓ Clients may now use processors on a CBU Edition to provide failover/role-swap for processors on its “paired” production system without purchasing additional i5/OS licenses or Enterprise Enablement features, when the respective primary system processors are inactive
- ✓ Additional CBU Edition offerings deliver CBU options to a broader set of mid-market and enterprise clients
 - i520 (1w, 1-2w)
 - i525 (1-2w)
 - i550 (1-4w)
 - i570 (1-4w, 1-8w, 2-16w)
 - i595 (2-16w, 4-32w)
 - CBU Editions to support Standard & Enterprise Edition primary systems

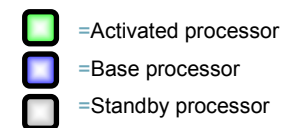

www.ibm.com/systems/i/hardware/cbu

System i Capacity BackUp Edition Offering

- **Offering intended for:**
 - Cost Effective disaster recovery for multiple environments including i5/OS, AIX and Linux
 - Dynamic HA clustering environments
 - Standard & Enterprise Edition Systems
- **Offering *now* enables:**
 - Purchase of permanent processor activations
 - Temporary transfer of i5/OS license entitlements from primary to CBU system
 - Temporary transfer of enterprise enablement entitlements* from primary to CBU system (assuming systems have 5250 OLTP capability)

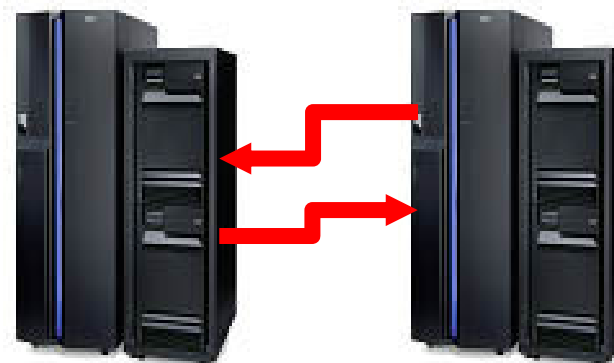

Prerequisites

- Primary server must be a 825/870/890 or a matching model 520/525/550/570/595
- Primary server must be equal to or larger than its CBU pairing
- If primary is Enterprise Edition, paired with CBU Enterprise Edition (both have 5250 OLTP). If primary is Standard Edition, paired with CBU Standard Edition.
- Registration of primary system and CBU Edition is required prior to CBU order (new box or MES upgrade) being manufactured. Go to: www.ibm.com/systems/i/hardware/cbu

* Enterprise enablement 5xx terminology, but the concept applies to 8xx primary systems. If a processor's worth of 5250 capacity is not being used on the primary 8xx Enterprise Edition system, it can be temporarily transferred to a CBU Edition system

Positioning The HA & CBU Editions

	HA Edition	Earlier CBU Edition	Enhanced CBU Edition
Disaster Recovery	Yes	Yes	Yes
High Availability	Yes	No	Yes
Solutions/options which allow edition to be ordered:			
HA ISV Solutions	Yes	Yes	Yes
Independent Auxiliary Storage Pools	No	Yes	Yes
Cross Site Mirroring (XSM)	No	Yes	Yes
IBM DS8000	No	Yes	Yes
Permanent processor activations	Yes	No	Yes
Temporary i5/OS, AIX 5L, Linux entitlement transfers	No	No	Yes
Temporary enterprise enablement entitlement transfers	No	No	Yes
Pre-requisite of a primary system	Yes	No	Yes
Upgrade into edition from 810/825/870/890	No	No	Yes
Registration of primary system to qualify	Yes	No	Yes
No charge On/Off CoD if primary system down by disaster	No	Yes	Yes
Primary system must be same size or larger	Yes	No	Yes

Example: CBU for HA / Failover (planned/unplanned outages)

Client wants to use a CBU system to support planned outages for their production system

1. Purchase i570 2/16w CBU Edition
2. Purchase 6 additional permanent processor activations for CBU Edition
3. Register at CBU website to enable 7 processors on CBU as eligible for temporary transfer of i5/OS license entitlement and Enterprise Enablement features

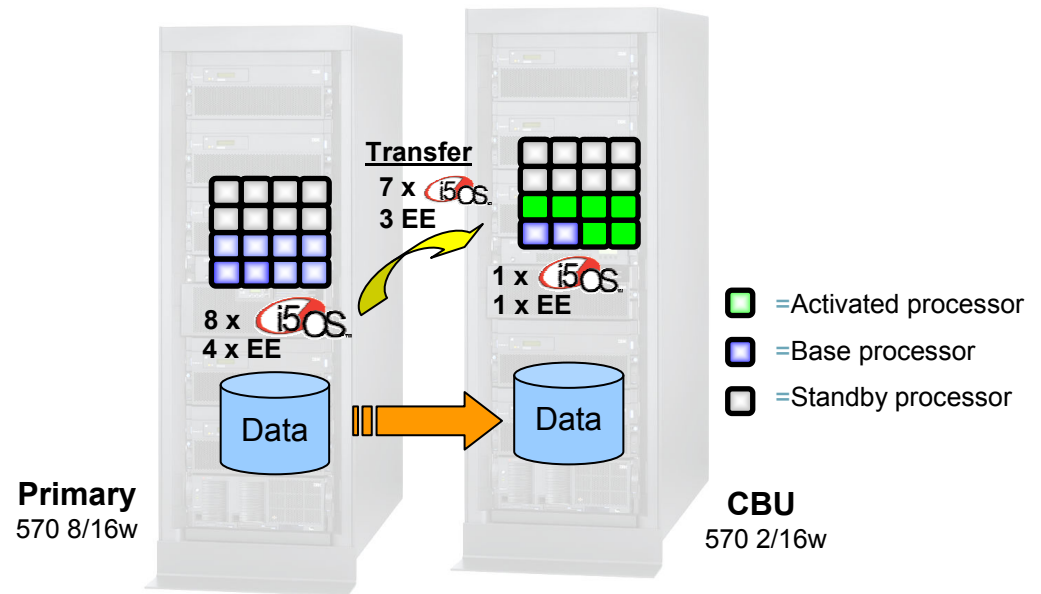

570 8/16w Enterprise Edition -8 base processors -1 base i5/OS license & 1 EE	£481K
Additional permanent processor activations (0)	£0K
i5/OS licenses (7 x £43K)	£305K
Enterprise Enablements (all)	£107K
Total	£893K

570 2/16w CBU Enterprise Edition -2 base processors -1 base i5/OS license & 1 EE	£252K
Additional permanent processor activations (6)	£45K
Additional i5/OS licenses (0)	£0K
Additional Enterprise Enablements (0)	£0K
Total	£297K

Prices are for illustration only and are subject to change without notice

What is Switched Disk and XSM

Standalone IASP

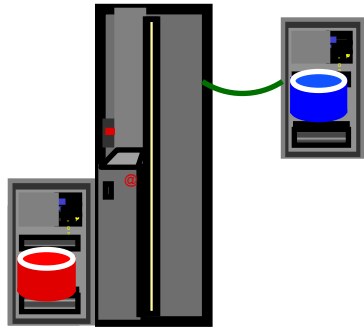

Switched Disk

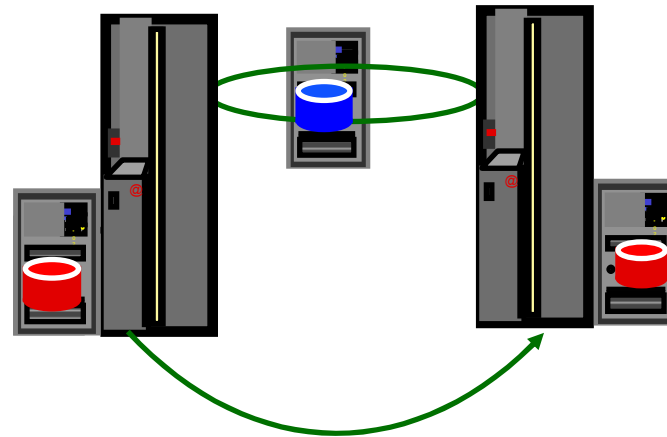

Cross Site Mirroring

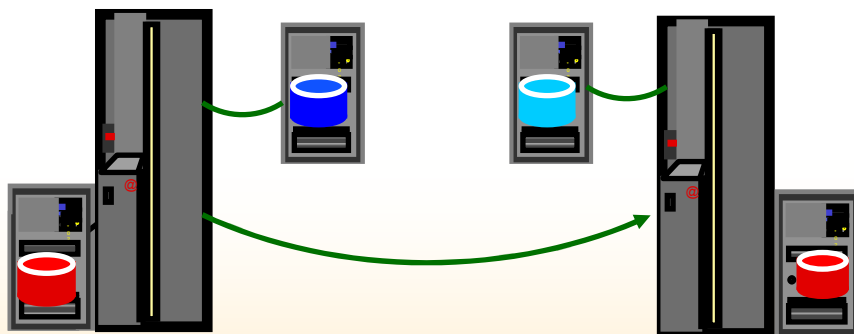

Switched Disk and XSM

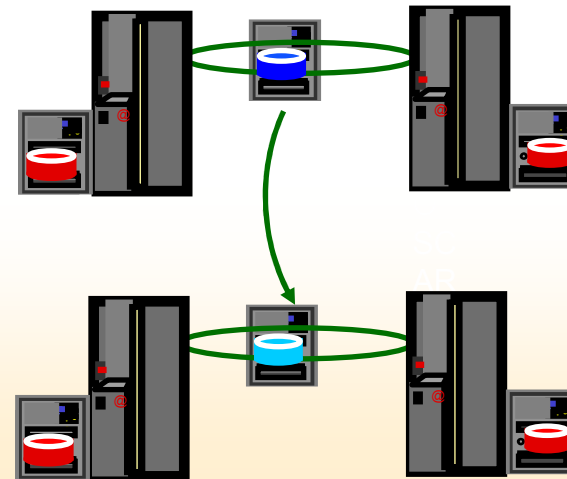

TS7520/TS7530 Product Overview



TS7530 Virtualization Engine Announcement

- **Announced: May 13, 2008**
- **General Availability: June 13, 2008**
- **New HW Based compression support**
 - Optional feature code: up to 2 cards per Server
 - Potentially reduce disk space
 - Potentially increased backup performance utilizing compression
- **1TB drive integration**
 - Scalable configurations up to 1.7PB useable - RAID 5
 - Support for new TS7530 and existing TS7520
 - RAID 6
- **New Server refresh**
- **RETAIN Call Home Support**
- **System i Support**

TS7500 Virtualization Basics

- **Emulates most recent IBM Tape Libraries and Drives:**
 - TS3500, TS3100, TS3200, TS3310, TS3400, 3582, 3583
 - LTO2, LTO3, LTO4, 3592, TS1120, TS1130

- **Physically attaches most recent IBM Tape Libraries and Drives:**
 - TS3500, TS3100, TS3200, TS3310, TS3400, 3494, 3582, 3583
 - LTO2, LTO3, LTO4, 3592, TS1120, TS1130

Supported by multiple backup applications

- IBM Tivoli Storage Manager
- BRMS
- Symantec Netbackup
- HP Dataprotector

Over 55 Years of Tape Innovation

- **Starting in 1952**
 - IBM 726 Tape Unit
 - **7,500 characters per second**
 - 100 bits per inch
- **and continuing in 2008**
 - IBM TS1130 Tape Drive
 - **up to 160MBps¹**
 - up to 1TB¹

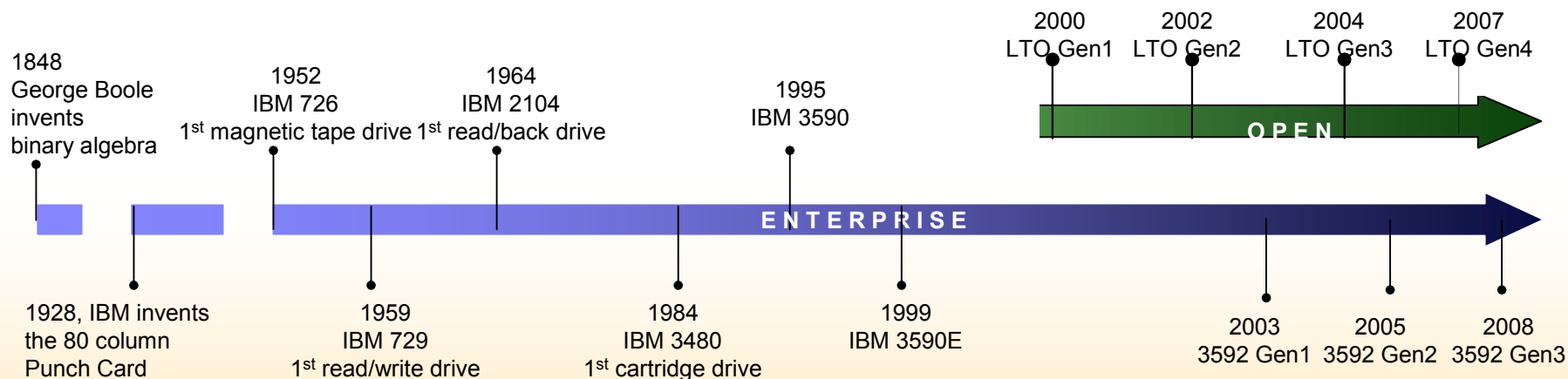

¹ represents maximum native performance or cartridge capacity

TS1130 Tape Drive Overview

- **Fastest 1TB Tape Drive**
- **3rd Generation of 3592 enterprise tape drive roadmap**
 - 160MBps performance (up to 350MBps at 3:1 compression)
 - 1TB native capacity cartridges (up to 3TB at 3:1 compression)
 - Re-Writable and Write Once Read Many (WORM)
 - 4Gbps dual ported fibre
 - Supports data encryption and key management
 - MES upgrade for TS1120 available (3592-EU6)
- **Attaches to**
 - All IBM Systems (IBM System z™ via TS1120 Controller)
 - Selected HP and Sun Microsystems servers
 - Selected versions of Microsoft Windows™
 - Selected Linux editions
- **Supported in**
 - IBM TS3400, TS3500 and 3494 tape libraries
 - IBM 3592 C20 silo compatible frame
 - IBM 7014 Rack



TS1130 = 3592-E06/EU6 = Jaguar 3

New for Gen 3 – TS1120 to TS1130 Drive Upgrade

- **New Model 3592-EU6**
 - Existing 3592-E05 canister upgraded to be functionally equivalent to the 3592-E06
 - Upgrade ordered via MES Model Conversion
 - 3592-EU6 inherits the 3592-E05 serial number
 - 3592-EU6 will assume only any remaining warranty entitlements or the service status of 3592-E05 that has been upgraded
- **Model upgrades beyond the EU6 will not be available**



TS1130 Media Compatibility

- Supports 3592 rewriteable and WORM cartridges
- Supports three cartridge lengths
 - JJ and JR cartridges provide rapid access to data
 - JA and JW cartridges provide fast access to data or high capacity
 - JB and JX extended data cartridges provide higher capacity



- **Gen 1, Gen 2 or Gen 3 cartridge formats supported**
 - TS1130 tape drives can read Gen 1 and read and write Gen 2 formats
 - TS1120 tape drives can read or write Gen 1 or Gen 2 formats
 - 3592 J1A tape drives can read or write the Gen 1 format

3592 Cartridge Media		TS1130 Tape Drive		TS1120 Tape Drive		3592 J1A Tape Drive	
Type	Format	Capacity	Performance	Capacity	Performance	Capacity	Performance
JJ / JR	Gen 1	60GB	71MBps	60GB	50MBps	60GB	40MBps
	Gen 2	100GB	143MBps	100GB	104MBps		
	Gen 3	128GB	143MBps				
JA / JW	Gen 1	300GB	71MBps	300GB	50MBps	300GB	40MBps
	Gen 2	500GB	143MBps	500GB	104MBps		
	Gen 3	640GB	143MBps				
JB / JX	Gen 2	700GB	150MBps	700GB	104MBps		
	Gen 3	1TB	160MBps				

TS1130 Tape Drive Operation

- **Five servo bands**
 - Servo bands recorded during manufacturing
 - Multiple servo locations within each band
- **Four data bands**
 - 288 tracks per band (1152 tracks)
 - Drive takes 72 'passes' to write a full tape
- **Data is written to 16 tracks at a time**
 - Cartridges are available in three lengths or capacities
 - Cartridges are available in re-writable and write once read many (WORM)

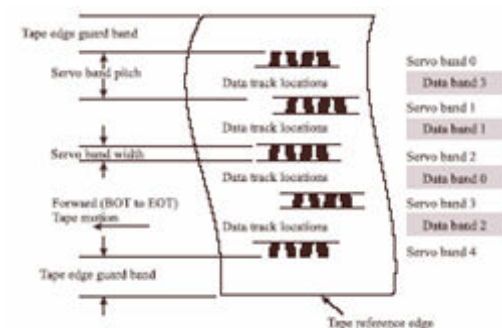
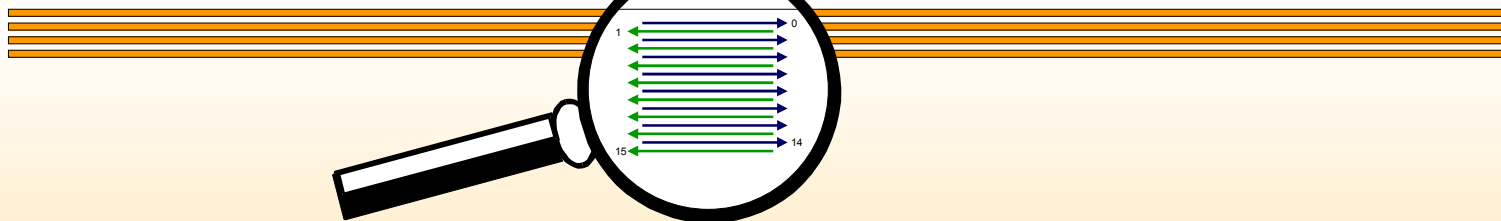
Beginning
of Tape

Speed Matching

- **Drive dynamically compensates for slow server**
- **Automatically adjusts data rates to**
 - 163, 134, 109, 83, 56, 43 MBps for 3592 JB cartridges initialized in Gen 3 format
 - 150, 127, 104, 78, 52, 40 MBps for 3592 JB cartridges initialized in Gen 2 format
 - 71, 59, 47, 36, 24, 19, 13 MBps for 3592 JA cartridges initialized in Gen 1 format
- **Effectively minimizes backhitching**
- **Extends the life of the media**
- **Increases performance**
- **Increases throughput**
 - Adjust tape speed based on host data rate
 - Calculates effective host data rate (EHDR)
 - Optimizes data rate by selecting optimal EHDR
 - Forces speed changes mid-wrap if advantageous
 - Minimizes time to record data

Thank You & Questions?



Trademarks

The following are trademarks of the International Business Machines Corporation in the United States and/or other countries. For a complete list of IBM Trademarks, see www.ibm.com/legal/copytrade.shtml: AIX, AIX 5L, BladeCenter, Blue Gene, DB2, e-business logo, eServer, IBM, IBM Logo, Infoprint, IntelliStation, iSeries, pSeries, OpenPower, POWER5, POWER5+, Power Architecture, TotalStorage, Websphere, xSeries, z/OS, zSeries

The following are trademarks or registered trademarks of other companies:

Java and all Java based trademarks and logos are trademarks of Sun Microsystems, Inc., in the United States and other countries or both

Microsoft, Windows, Windows NT and the Windows logo are registered trademarks of Microsoft Corporation in the United States, other countries, or both.

Intel, Intel logo, Intel Inside, Intel Inside logo, Intel Centrino, Intel Centrino logo, Celeron, Intel Xeon, Intel SpeedStep, Itanium, and Pentium are trademarks or registered trademarks

of Intel Corporation or its subsidiaries in the United States and other countries.

UNIX is a registered trademark of The Open Group in the United States and other countries or both.

Linux is a trademark of Linus Torvalds in the United States, other countries, or both.

Other company, product, or service names may be trademarks or service marks of others.

NOTES:

Any performance data contained in this document was determined in a controlled environment. Actual results may vary significantly and are dependent on many factors including system hardware configuration and software design and configuration. Some measurements quoted in this document may have been made on development-level systems. There is no guarantee these measurements will be the same on generally-available systems. Users of this document should verify the applicable data for their specific environment.

IBM hardware products are manufactured from new parts, or new and serviceable used parts. Regardless, our warranty terms apply.

Information is provided "AS IS" without warranty of any kind.

All customer examples cited or described in this presentation are presented as illustrations of the manner in which some customers have used IBM products and the results they may have achieved. Actual environmental costs and performance characteristics will vary depending on individual customer configurations and conditions.

This publication was produced in the United States. IBM may not offer the products, services or features discussed in this document in other countries, and the information may be subject to change without notice. Consult your local IBM business contact for information on the product or services available in your area.

All statements regarding IBM's future direction and intent are subject to change or withdrawal without notice, and represent goals and objectives only.

Information about non-IBM products is obtained from the manufacturers of those products or their published announcements. IBM has not tested those products and cannot confirm the performance, compatibility, or any other claims related to non-IBM products. Questions on the capabilities of non-IBM products should be addressed to the suppliers of those products.

Prices are suggested US list prices and are subject to change without notice. Starting price may not include a hard drive, operating system or other features. Contact your IBM representative or Business Partner for the most current pricing in your geography.

Any proposed use of claims in this presentation outside of the United States must be reviewed by local IBM country counsel prior to such use.

The information could include technical inaccuracies or typographical errors. Changes are periodically made to the information herein; these changes will be incorporated in new editions of the publication. IBM may make improvements and/or changes in the product(s) and/or the program(s) described in this publication at any time without notice.

Any references in this information to non-IBM Web sites are provided for convenience only and do not in any manner serve as an endorsement of those Web sites. The materials at those Web sites are not part of the materials for this IBM product and use of those Web sites is at your own risk.

IBM makes no representation or warranty regarding third-party products or services including those designated as ServerProven, ClusterProven or BladeCenter Interoperability Program products. Support for these third-party (non-IBM) products is provided by non-IBM Manufacturers.

IBM may have patents or pending patent applications covering subject matter in this document. The furnishing of this document does not give you any license to these patents. Send license inquires, in writing, to IBM Director of Licensing, IBM Corporation, New Castle Drive, Armonk, NY 10504-1785 USA.