



System z Enables Solutions For A Smarter Planet

Smart Work On System z

Service Oriented Finance Automated Its Loan Processing In 2008

We automated our loan processing with WebSphere and it's great! We reduced loan processing time and our loan volumes increased 59%.



Service Oriented Finance CEO, 2008

Changing Business Conditions

But times have changed. We need to be more careful who we loan money to.



Service Oriented Finance CEO, 2009

Change The Rules, Not The Process

It sounds like we need a new business process!



**Service Oriented Finance
CIO**

You don't have to replace the process – simply adjust it!



IBM

Service Oriented Finance Automated Their Loan Process With WebSphere On System z

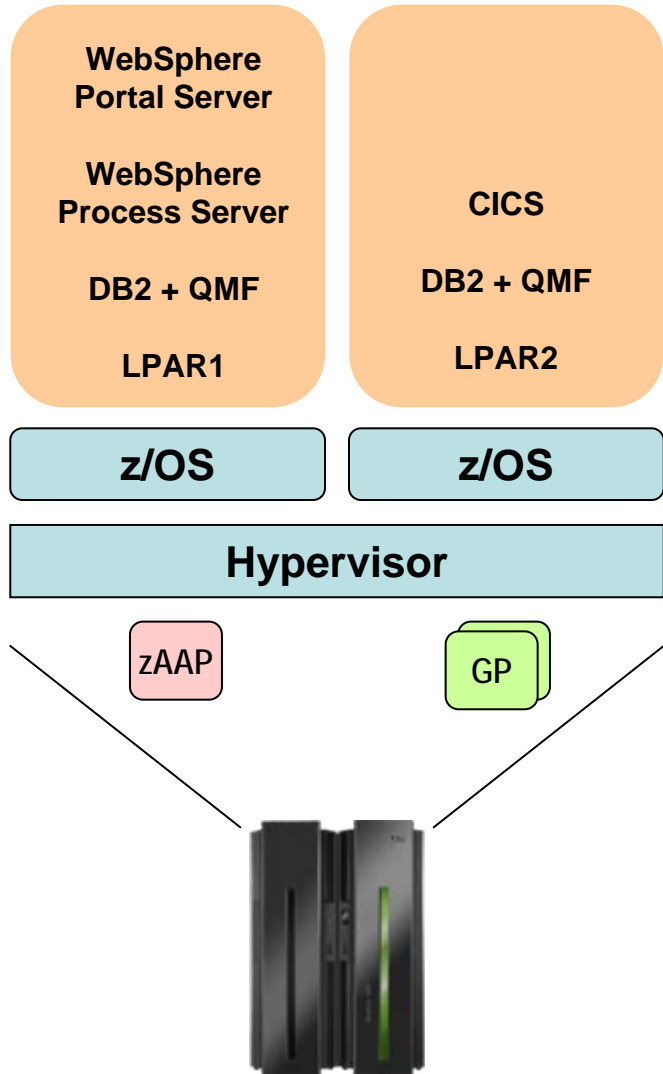
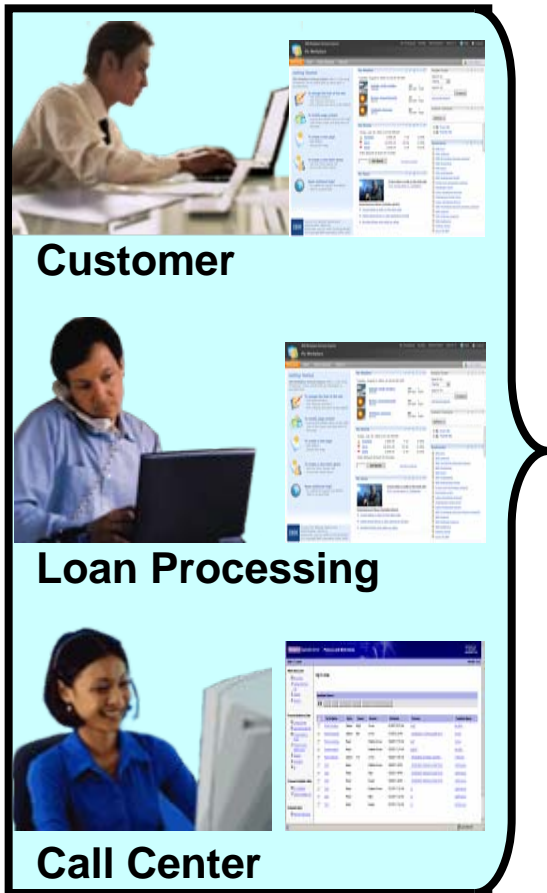

- System z:**
- Lowest cost
 - Performance from co-location
 - Quality of service

The Current Loan Process

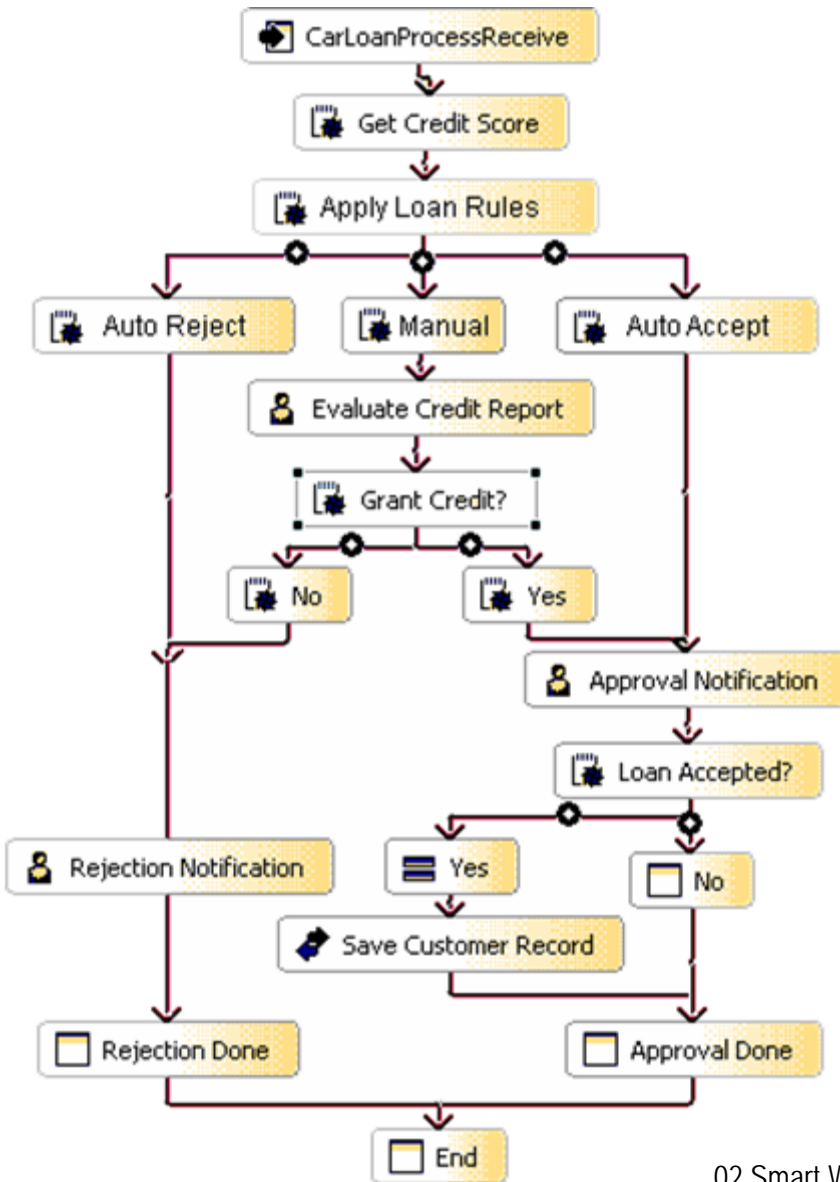

Key Features:

- Automated process management reduces processing time and eliminates paper
 - ▶ Efficient inclusion of human tasks, such as manual approval
 - ▶ Automatic access to back end systems
 - ▶ Instant status and tracking of each loan application
- System z is the lowest cost deployment platform

DEMO: The Current Loan Process



Tracy applies for a car loan from Service Oriented Finance

Car Loan Application

Loan Type: New Car Used Car

Loan Term: 24 36 48 60 72

Loan Amount Requested:

Application Type: Individual Application Joint Application

Customer #:

First Name:

Last Name:

Address:

City:

State:

Zip:

Phone:

Email:

What Changes Do You Need To Make?

We need to impose a maximum loan limit and require better credit ratings from applicants.



**Service Oriented Finance
CEO**



**Service Oriented Finance
CIO**

Business Rules Let You Adapt Quickly To Business Change

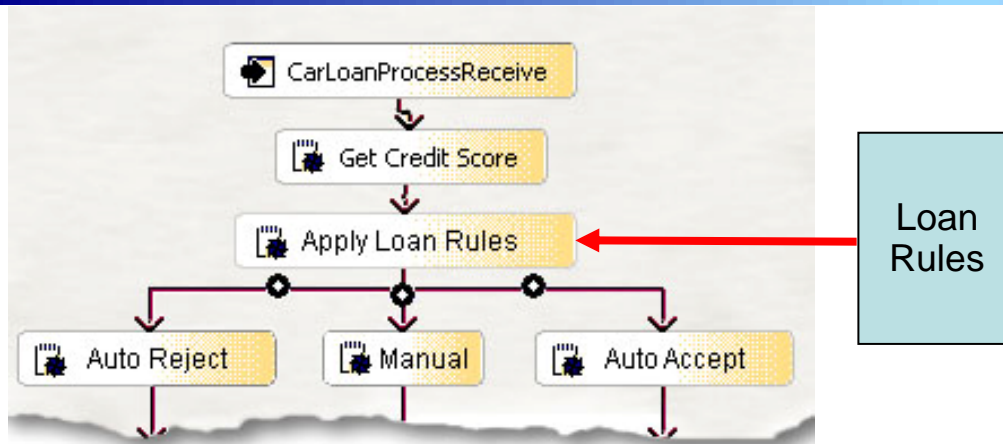

WebSphere Process Server externalizes business rules so they can be adjusted by business managers in production, without requiring development changes to the process

- ▶ Business rules are typically used to adjust thresholds
- ▶ Business rules easily changed with a browser after the process is deployed
- ▶ New rules take effect immediately without having to redeploy

Example: Change The Business Rules

Current car loan rules

- ▶ Default analysis result is **manual**
- ▶ If **credit score** is less than **500** analysis result is set to **auto reject**
- ▶ If **credit score** is greater than **700** analysis result is set to **auto accept**

New car loan rules

- ▶ Default analysis result is **manual**
- ▶ If **loan amount** is greater than **30,000** analysis result is set to **auto reject**
- ▶ If **credit score** is less than **650** analysis result is set to **auto reject**
- ▶ If **credit score** is greater than **720** analysis result is set to **auto accept**

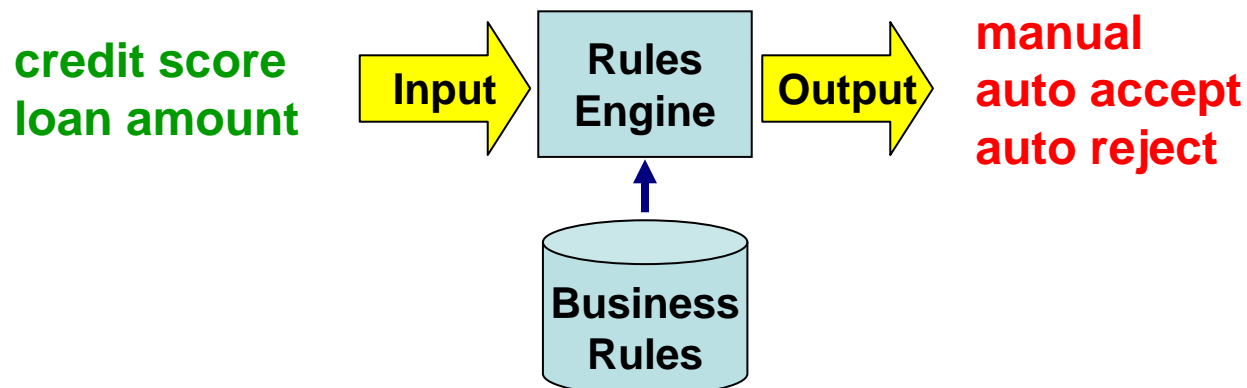

DEMO: Change The Rules

Welcome FENG | [Logout](#) | [Help](#)

> AnalyzeCreditScoreRuleGroup > executeRule

Edit Mode: AnalyzeCreditScoreRuleSet - Ruleset

Messages:

General Information

Last Published	Feb 24, 2009 07:45 (Local Time)	Status	*Original
Description	<input type="text"/>		

Rules

Name	Rule	Action
ManualRule1	Set default analysis result to <input type="text" value="Manual"/>	<input type="button" value="↓"/> <input type="button" value="Delete"/>
AutoRejectRule	If credit score is less than <input type="text" value="500"/> then analysis result is <input type="text" value="Auto Reject"/>	<input type="button" value="↓"/> <input type="button" value="↑"/> <input type="button" value="Delete"/>
AutoAcceptRule	If credit score is greater than <input type="text" value="700"/> , then analysis result is <input type="text" value="Auto Accept"/>	<input type="button" value="↑"/> <input type="button" value="Delete"/>

- 1. impose a maximum loan limit
- 2. require better credit ratings

and click "Add" button.

Item	Rule	Action
Template_AutoRejectRule	<input type="checkbox"/> If credit score is less than <input type="text"/> then analysis result is <input type="text" value="Auto Reject"/>	<input type="button" value="Add"/>
Template_AutoAcceptRule	<input type="checkbox"/> If credit score is greater than <input type="text"/> , then analysis result is <input type="text" value="Auto Accept"/>	<input type="button" value="Add"/>
Template_MaxLoanRule	<input type="checkbox"/> <input type="text" value="MaxLoanRule"/> If loan amount is greater than <input type="text" value="30000"/> , set analysis result to <input type="text" value="Auto Reject"/>	<input type="button" value="Add"/>
Template_ManualRule1	<input type="checkbox"/> Set default analysis result to <input type="text" value="Manual"/>	<input type="button" value="Add"/>



SOF's Loan Analyst, JC Feng, needs to change the rules

There Were Some Other Changes Made To The Process

We need a volunteer from the audience who has a mobile phone with text messaging. How about YOU?



DEMO: The Loan Application With The New Rules



Car Loan Application

Loan Type: New Car Used Car

Loan Term: 24 36 48 60

Loan Amount Requested:

Application Type: Individual Application Joint Application

Customer #:

First Name:

Last Name:

Address:

City:

State:

Zip:

Phone:

Email:



Tracy applies for a car loan from Service Oriented Finance, after the change of rules

Making More Revisions To The Business Process

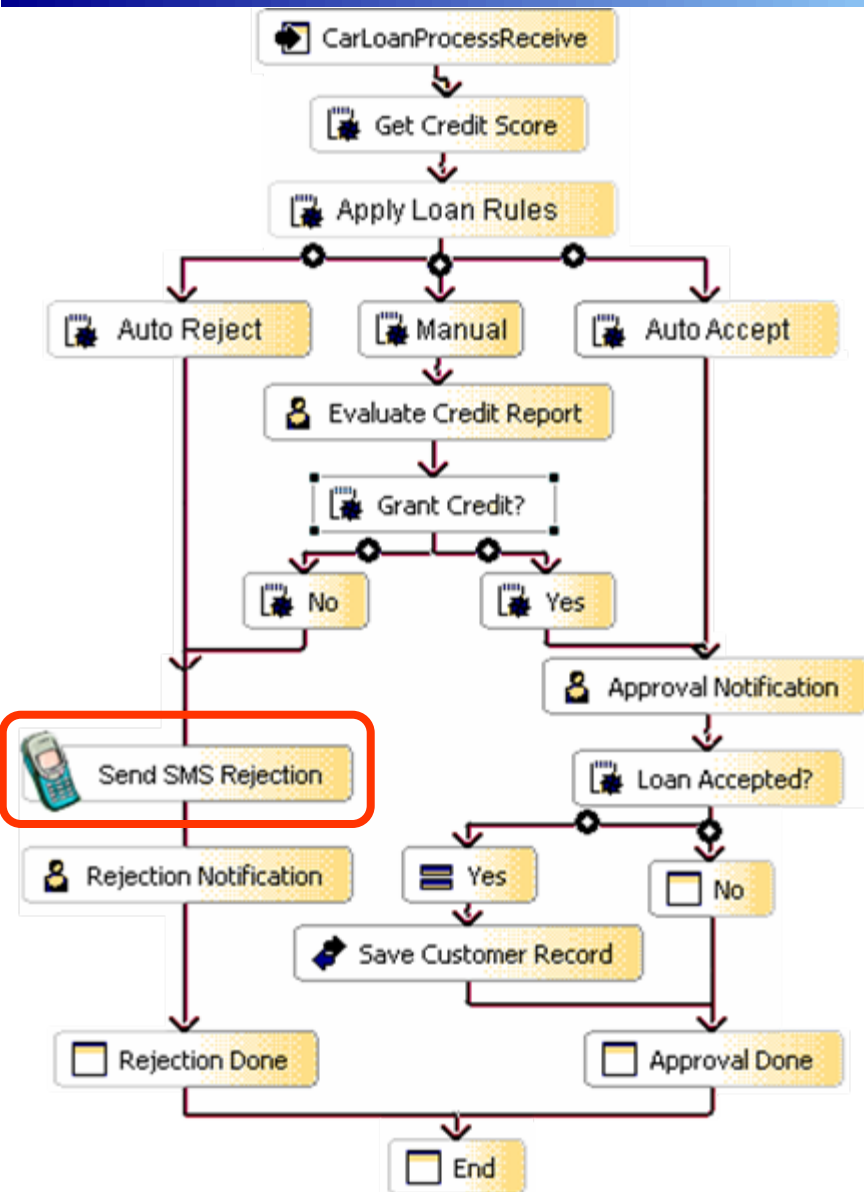

- In the demo we added a notification sent to a mobile phone via SMS using the phone number provided
- It's fast and easy to revise and redeploy an existing business process
 - ▶ Change the order of activity steps
 - ▶ Add one or more new activities
 - ▶ Use a different service provider
- Service Component Architecture (SCA) makes it easy
 - ▶ Tool can easily insert “send SMS alert” activity into flow

Service Component Architecture (SCA) Is The Foundation For Process Flexibility

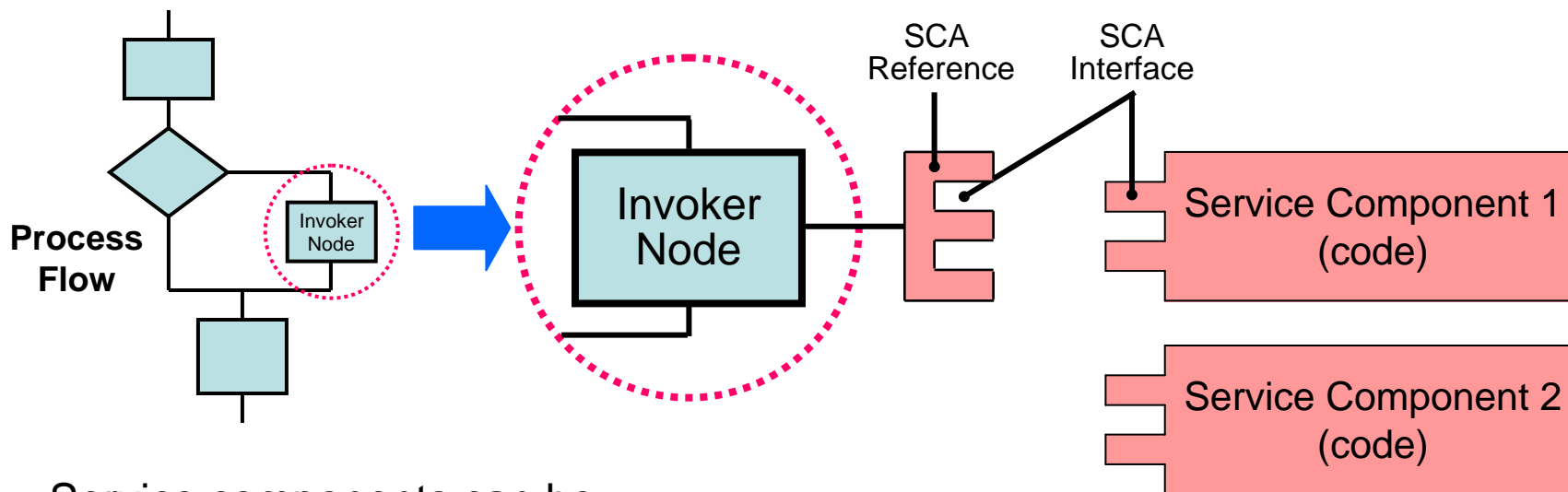

Service components can be

- ▶ Wired-in to the reference at assembly time
- ▶ Changed at assembly time
- ▶ And, as we'll see, selected or substituted at runtime

Types of service components

- ▶ EJB code
- ▶ Proxies to call Web services (e.g. a CICS transaction wrapped as a Web service)
- ▶ Proxies to send a task to a human
- ▶ Proxies that make decisions about what to do at run time



Service Oriented Finance Needs Even More Flexibility

There are other scenarios where we need process flexibility.



**Service Oriented Finance
CEO**

IBM has the most suite of flexible process capabilities.



IBM

Process Flex Points Are Built On Service Component Architecture

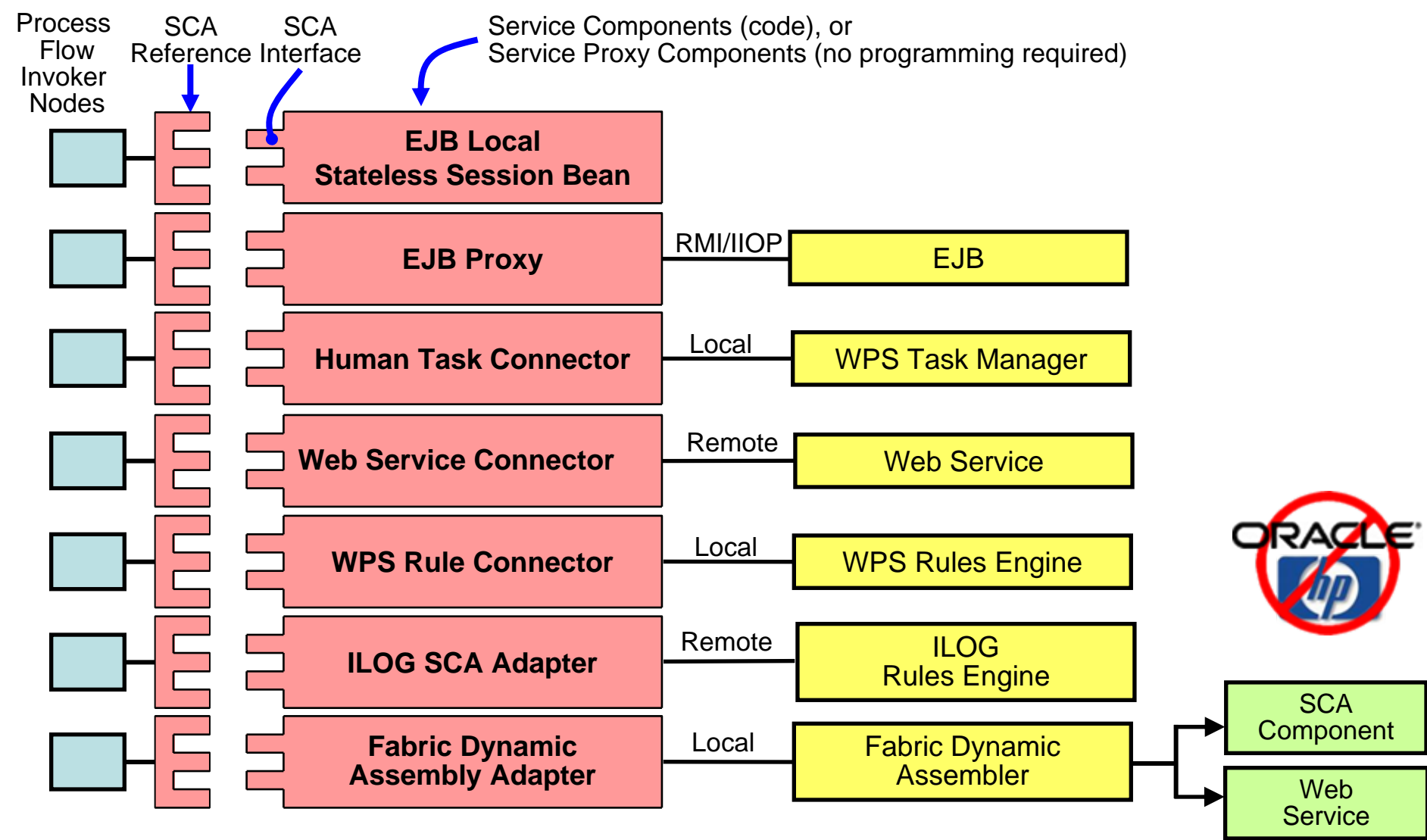

SOF Is Now An Agile Business, But There Are New Requirements

There are many experts that determine our business policies. We need the process to follow these policies.

...n thresholds
! to the new
ent, and
posure.

We want to use the process worldwide, but laws require different handling in some countries.

**Service Oriented Finance
CEO**

**Manager,
International
Markets**

IBM can satisfy them!

Local Variations

We want to deploy a common process but we need to handle variations in local environments.



**Manager,
International
Markets**

WebSphere Business Services Fabric is unique in it's ability to do this !



IBM

WebSphere Business Fabric Permits A Common Process To Be Adapted To Localities

- **PROBLEM:** Need to deploy same process worldwide, with localized differences

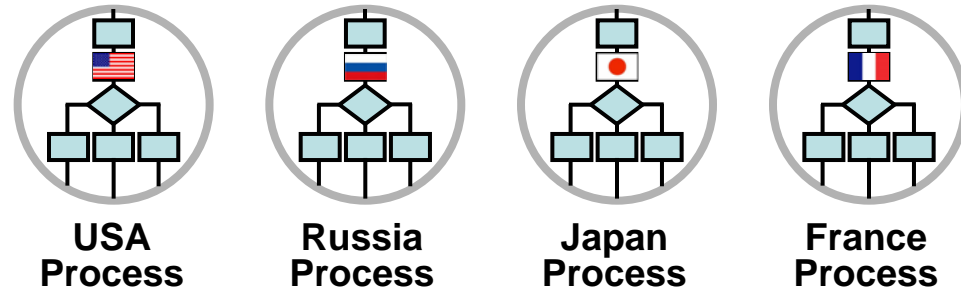

- ▶ Customizing separate copies is cumbersome and costly, and complicates version control

- **SOLUTION:** Fabric supports a **common process** by selecting, **at runtime**, the service required for each request

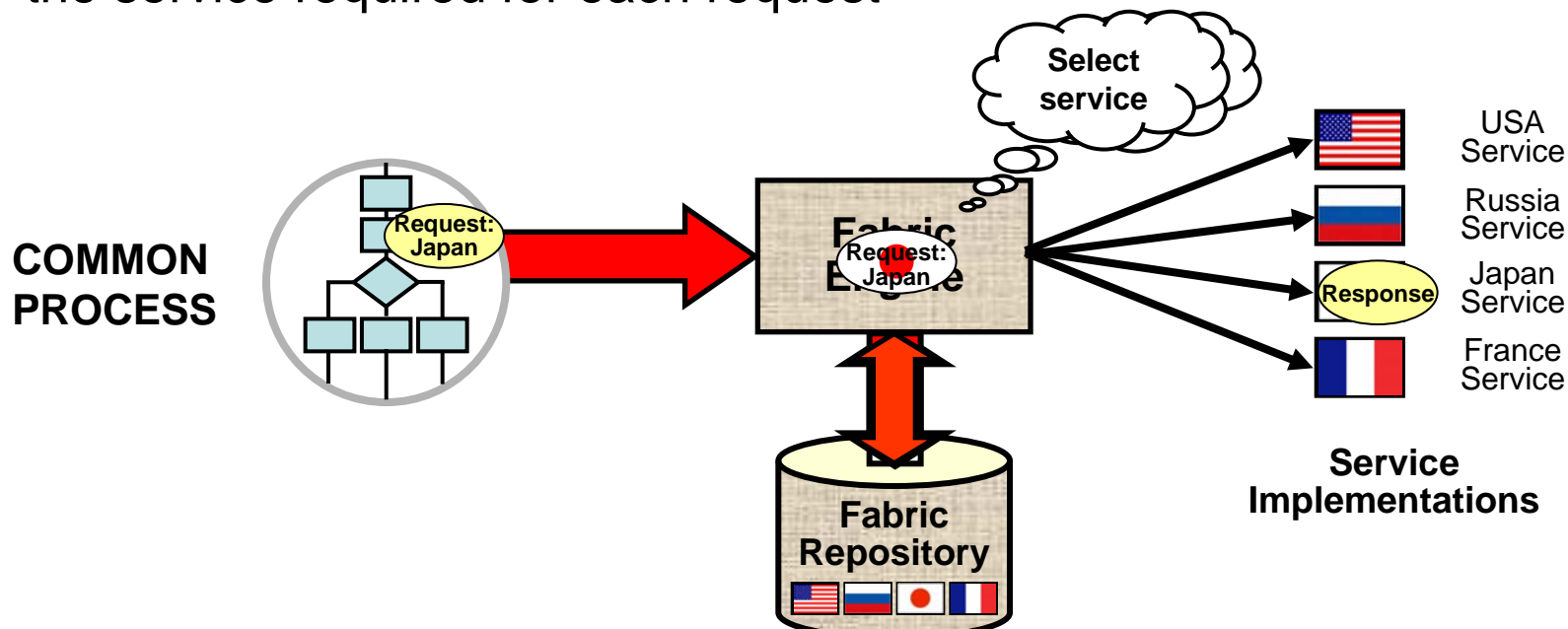

There are many experts that determine our business policies. We need to capture this expertise and use it to make process decisions.



Business User

ILOG is a great way to capture expertise in complex rule sets.



IBM

ILOG Captures Expertise As Business Rules For Re-Use In Business Processes

We need to impose a maximum loan limit and require better credit ratings from applicants.

Loan limit

Rule

Credit rating

Rule



Business Processes
invoke business rules

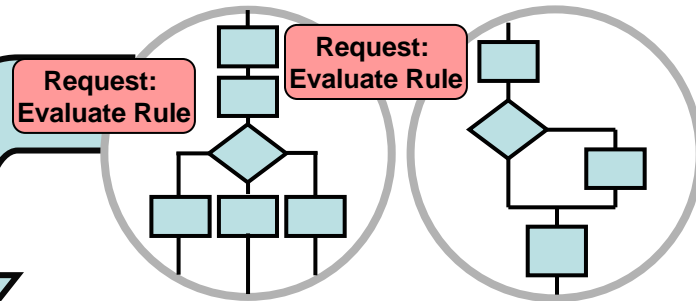

Experts **create business rules**
and save them in the Rules
Repository

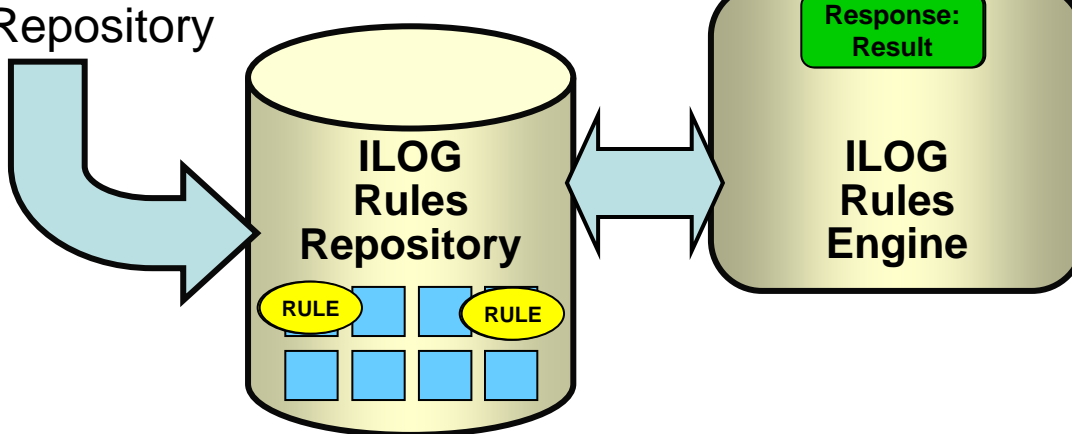

ILOG Rules Engine
**evaluates a specified
rule** from the Repository
and returns result to the
Business Process

ILOG Repository **captures business
rules** for re-use in Business Processes



Why Deploy This Process On System z?

- A Smart SOA implementation requires high quality of service from the deployment platform
 - ▶ Workload Management to handle peak demand
 - ▶ Scalability and Clustering
 - ▶ Continuous Availability/Disaster Recovery
 - ▶ Rock-solid Security
- Running on the same server provides performance advantages
- Lowest cost!



IBM Smart SOA Software Runs On System z

- WebSphere Process Server
- WebSphere Enterprise Service Bus
- WebSphere Application Server
- WebSphere Service Registry and Repository
- WebSphere Business Events
- WebSphere Business Services Fabric
- WebSphere Business Modeler Publishing Server
- WebSphere Business Monitor
- ILOG jRules



Co-location Performance Advantages

- Mainframes already house the core DB2, CICS and IMS applications and data for the business
 - ▶ Quickly expose these assets as services
- Deploying WebSphere Process Server, WebSphere Portal Server, and the assets they use in the same LPAR provides better performance and throughput



On-Line Banking Benchmark Demonstrates Performance Advantages Of Co-location

Separate Machines

150 tps

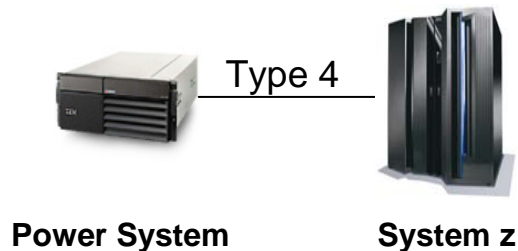
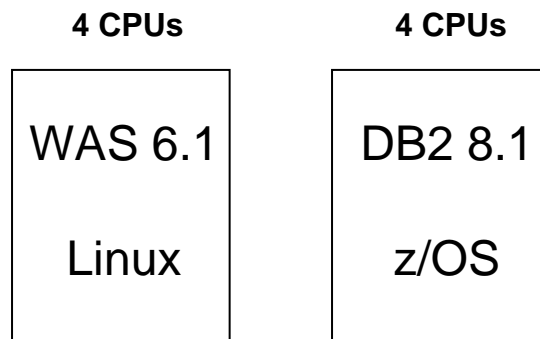

Same LPAR

243 tps

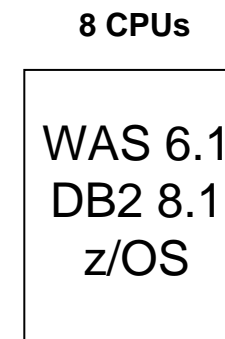

z Series Server : z9-EC, 8 X 1.7 GHz, 64 GB RAM

Deploy WebSphere Process Management Application on Mainframe vs. HP Servers

Existing Mainframe



Existing Disaster Recovery Site



Add 1 LPAR for New Web Application w 1.28TB storage

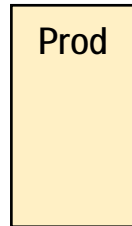

1,624 MIPS additional workload

And Add Disaster Recovery w 1.28TB storage

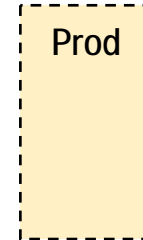

3 year cost of acquisition \$3.15M

Existing z10:
2 GP 1,720 MIPS
DB2 and utilities
With 20TB storage

Existing:
1 GP processor for hot disaster switch-over
1 "dark" DR processor
With 20TB storage

Incremental:
1 zAAP 920 MIPS WPS & Portal (85%)
1 GP 541 MIPS DB2
80 MIPS WPS & 83 MIPS Portal (15%)
2 GB memory

Capacity Backup:
1 GP
1 zAAP

Or Add HP Integrity Superdome 9140 Server w 1.67TB storage



201,977*
Performance Units

And Add Disaster Recovery w 1.67TB storage



201,977*
Performance Units

3 year cost of acquisition \$14.36M

*Production Performance Units required = 1,624 x 122 = 198,128

