

Telelogic D00RS

DXL Reference Manual



Telelogic DOORS
DXL Reference Manual
Release 9.1

Before using this information, be sure to read the general information under the "Notices" chapter on page 829.

This edition applies to **VERSION 9.1, Telelogic DOORS** and to all subsequent releases and modifications until otherwise indicated in new editions.

© **Copyright IBM Corporation 1993, 2008**

US Government Users Restricted Rights—Use, duplication or disclosure restricted by GSA ADP Schedule Contract with IBM Corp.

Table of Contents

Chapter 1	About this manual	1
	Typographical conventions	1
	Related documentation	2
Chapter 2	Introduction	3
	Developing DXL programs	3
	Browsing the DXL library	5
	Language fundamentals	6
	Lexical conventions	9
	Constants	11
	Identifiers	13
	Types	14
	Declarations	14
	Expressions	17
	Statements	19
	Basic functions	22
Chapter 3	New in DXL for DOORS 9.0	27
	Discussions	27
	Discussion Types	27
	Properties	28
	Iterators	31
	Operations	33
	Triggers	35
	Example	36
	Descriptions	38
	View Descriptions	38
	Attribute Type Descriptions	38
	Attribute Definition Descriptions	40
	Filtering	41
	HTML	41
	HTML Control	42
	HTML Edit Control	52
	Miscellaneous	53
Chapter 4	New in DXL for DOORS 9.1	55
	Regular Expressions	55
Chapter 5	Fundamental types and functions	57
	Operations on all types	57
	Operations on type bool	59
	Operations on type char	60
	Operations on type int	63

Operations on type real 66
 Operations on type string 70

Chapter 6 General language facilities 75

Files and streams 75
 Configuration file access 83
 Dates 90
 Skip lists 96
 Regular expressions 101
 Text buffers 105
 Arrays 115

Chapter 7 Operating system interface 121

Operating system commands 121
 Windows registry 128
 Interprocess communications 131
 System clipboard functions 134

Chapter 8 Customizing DOORS 137

Color schemes 137
 DOORS Explorer options 139
 Locales 141
 Codepages 148
 Message of the day 151
 Database Properties 153

Chapter 9 DOORS database access 155

Database properties 155
 Group and user manipulation 167
 Group and user management 175
 LDAP 182
 LDAP Configuration 183
 LDAP server information 185
 LDAP data configuration 189
 Telelogic Directory Server 194

Chapter 10 DOORS hierarchy 199

About the DOORS hierarchy 199
 Item access controls 200
 Hierarchy clipboard 201
 Hierarchy information 204
 Hierarchy manipulation 208
 Items 210
 Folders 213
 Projects 216
 Looping within projects 221

Chapter 11	Modules	223
	Module access controls.....	223
	Module references	224
	Module information	227
	Module manipulation	231
	Module display state	236
	Baselines	239
	Baseline Set Definition.....	247
	Baseline Sets	256
	History.....	265
	Descriptive modules	274
	Recently opened modules.....	276
	Module Properties	279
Chapter 12	Electronic Signatures	283
	Signature types	283
	Controlling Electronic Signature ACL	283
	Electronic Signature Data Manipulation	287
	Examples.....	292
Chapter 13	Objects	301
	About objects	301
	Object access controls	301
	Finding objects	303
	Current object.....	308
	Navigation from an object.....	309
	Object management	312
	Information about objects	316
	Selecting objects	318
	Object searching	319
	Miscellaneous object functions	320
Chapter 14	Links	325
	About links and link module descriptors.....	325
	Link creation.....	326
	Link access control.....	326
	Finding links	327
	Versioned links	331
	Link management.....	334
	Default link module	339
	Linksets	339
	External Links.....	342
	DOORS URLs	346
Chapter 15	Attributes	353
	Attribute values.....	353
	Attribute value access controls.....	359

	Multi-value enumerated attributes	361
	Attribute definitions.	362
	Attribute definition access controls	373
	Attribute types	374
	Attribute type access controls	380
	Attribute type manipulation	381
	DXL attribute	385
Chapter 16	Access controls	389
	Controlling access	389
	Locking.	398
	Example programs.	399
Chapter 17	Templates	403
	Template functions	403
	Template expressions	404
Chapter 18	Dialog boxes	407
	Icons.	407
	Message boxes	410
	Dialog box functions	413
	Dialog box elements	424
	Common element operations	424
	Simple elements for dialog boxes	446
	Choice dialog box elements.	460
	View elements	465
	Text editor elements	473
	Buttons	476
	Canvases.	480
	Complex canvases	495
	Toolbars	506
	Colors.	510
	Simple placement.	516
	Constrained placement	519
	Progress bar	525
	DBE resizing	528
	HTML Control	529
	HTML Edit Control	539
Chapter 19	DOORS window control	541
	The DXL Library and Addins menus.	541
	Module status bars.	543
	DOORS built-in windows.	544
	Module menus	546
Chapter 20	Display control	559

	Filters.....	559
	Filtering on multi-valued attributes.....	568
	Sorting modules.....	569
	Views.....	573
	View access controls.....	584
	View definitions.....	587
	Columns.....	596
	Scrolling functions.....	603
	Layout DXL.....	604
Chapter 21	Partitions.....	609
	Partition concepts.....	609
	Partition definition management.....	609
	Partition definition contents.....	612
	Partition management.....	618
	Partition information.....	621
	Partition access.....	626
Chapter 22	OLE objects.....	629
	Embedded OLE objects and the OLE clipboard.....	629
	OLE Information Functions.....	638
	Picture object support.....	644
	Automation client support.....	656
	Controlling DOORS from applications that support automation.....	664
Chapter 23	Triggers.....	667
	Introduction to triggers.....	667
	Trigger constants.....	672
	Trigger definition.....	674
	Trigger manipulation.....	677
	Drag-and-drop trigger functions.....	684
Chapter 24	Page setup functions.....	695
	Page attributes status.....	695
	Page dimensions.....	696
	Document attributes.....	699
	Page setup information.....	702
	Page setup management.....	704
Chapter 25	Tables.....	707
	Table concept.....	707
	Table constants.....	707
	Table management.....	708
	Table manipulation.....	712
	Table attributes.....	720

Chapter 26	Rich text.	723
	Rich text processing.	723
	Rich text strings.	730
	Enhanced character support.	740
	Importing rich text.	744
	Diagnostic perms.	744
Chapter 27	Spelling Checker	749
	Constants and general functions.	749
	Language and Grammar.	758
	Spelling Dictionary.	767
	Miscellaneous Spelling.	770
	Spelling\Dictionary Examples.	771
Chapter 28	Database Integrity Checker	775
	Database Integrity Types.	775
	Database Integrity Perms.	776
Chapter 29	Discussions	785
	Discussion Types.	785
	Properties.	785
	Iterators.	789
	Operations.	791
	Triggers.	793
	Example.	794
Chapter 30	General functions.	797
	Error handling.	797
	Archive and restore.	800
	Locking.	812
	HTML functions.	820
	htmlhelp.	821
	Broadcast Messaging.	822
Chapter 31	Character tables.	823
	Character codes and their meanings.	823
	Table of symbols.	824
Chapter 32	Contacting customer support.	825
	Contacting IBM Rational Software Support.	825
	What to do before you contact Support.	825
	Sending an automated problem report form.	826
	Other information.	828
Chapter 33	Notices.	829

Trademarks830

Index..... 833

x |

Chapter 1

About this manual

Welcome to version 9.1 of Telelogic® DOORS® (DOORS), a powerful tool that helps you to capture, track and manage your user requirements.

DXL (DOORS eXtension Language) is a scripting language specially developed for DOORS. DXL is used in many parts of DOORS to provide key features, such as file format importers and exporters, impact and traceability analysis and inter-module linking tools. DXL can also be used to develop larger add-on packages such as CASE tool interfaces and project management tools. To the end user, DXL developed applications appear as seamless extensions to the graphical user interface. This capability to extend or customize DOORS is available to users who choose to develop their own DXL scripts.

The DXL language is for the more technical user, who sets up programs for the end-user to apply. DXL takes many of its fundamental features from C and C++. Anyone who has written programs in these or similar programming languages should be able to use DXL.

This book is a reference manual for DXL for version 9.1 of DOORS. Refer to it if you wish to automate simple or complex repetitive tasks, or customize your users' DOORS environment. It assumes that you know how to write C or C++ programs.

Typographical conventions

The following typographical conventions are used in this manual:

Typeface or Symbol	Meaning
Bold	Important items, and items that you can select, including buttons and menus. For example: Click Yes to continue.
<i>Italics</i>	Book titles
Courier	Commands, files, and directories; computer output. For example: Edit your <code>.properties</code> file.
>	A menu choice. For example: Select File > Open . This means select the File menu, then select the Open command from it.

Each function or macro is first introduced by name, followed by a declaration or the syntax, and a short description of the operation it performs. These are supplemented by examples where appropriate.

Related documentation

The following table describes where to find information in the DOORS documentation set:

For information on	See
What's new in version 9.1 of DOORS	The Telelogic DOORS readme file
How to install DOORS	<i>Telelogic DOORS Installation Guide</i>
How to set up licenses to use DOORS	<i>Telelogic Lifecycle Solutions Licensing Guide</i>
How to use DOORS	<i>Getting Started with Telelogic DOORS</i> <i>Using Telelogic DOORS</i>
How to write requirements	<i>Get it Right the First Time</i>
How to set up and manage DOORS	<i>Managing Telelogic DOORS</i>
The DXL programming language	<i>DXL Reference Manual</i>
How to integrate DOORS with other applications	<i>Telelogic DOORS API manual</i>

You'll find PDF versions of these manuals on:

- The Telelogic Lifecycle Solutions DVD
- Our Support web site at <https://support.telelogic.com>

Chapter 2

Introduction

This chapter describes the DXL Interaction window, DXL library, and the basic features of DXL. It covers the following topics:

- Developing DXL programs
- Browsing the DXL library
- Language fundamentals
- Lexical conventions
- Constants
- Identifiers
- Types
- Declarations
- Expressions
- Statements
- Basic functions

Developing DXL programs

You can use the DXL Interaction window to develop small DXL programs.

For large-scale program development, you should use a third party editing tool when coding, and then load your code into the DXL Interaction window to execute and debug it. You can set up a menu option in DOORS to run your third party editing tool.

To use the DXL Interaction window:

1. In either the DOORS Explorer or a module window, click **Tools > Edit DXL**.

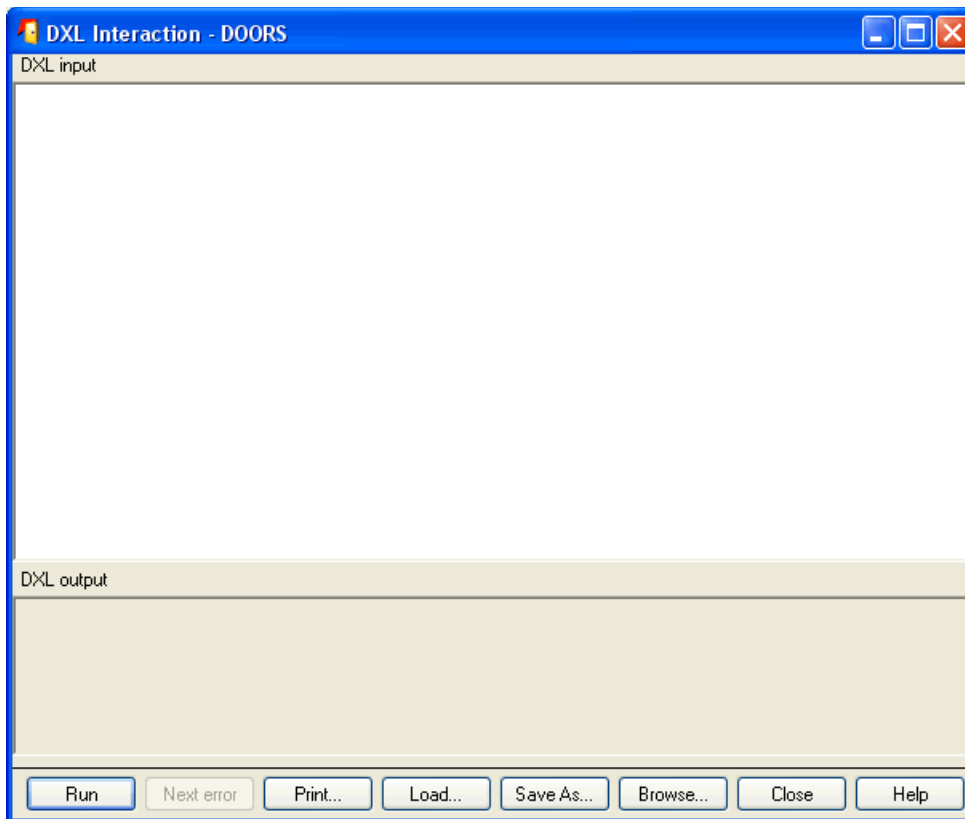

2. Either type or load your program into the DXL input pane.

To load the contents of a file, click **Load**. To load a program from the DXL library, click **Browse**.

3. To run the program in the DXL input pane, click **Run**.

Any error messages that are generated are displayed in the DXL output pane.

To see the next error message, click **Next error**. The contents of the DXL input pane scroll to the line of source code that caused the error displayed in the DXL output pane.

4. To print the contents of the DXL input pane with line numbers, click **Print**.

5. To save the contents of the DXL input pane to file, click **Save As**.

Right-click anywhere in the DXL input pane to display a pop-up menu with the sub-menus **File**, **Edit**, and **Search**. The **Edit** sub-menu options have standard Windows functions. The **File** sub-menu options are described in the following table:

File	Description
Load	Loads the contents of a text file into the DXL input pane. You can also use drag-and-drop to load a file directly from Windows Explorer.

File	Description
Save	Saves changes you made to the text in the DXL input pane.
Save as	Saves the contents of the DXL input pane to another file.
New	Clears the DXL input pane. If you have made changes to the text that have not yet been saved, you are asked if you want to save them.

The **Search** sub-menu options are described in the following table:

Search	Description
Search	Finds a string of text in the DXL input pane. The search is case-sensitive.
Again	Repeats the search.
Replace	Replaces one string of text with another. You can replace text strings one at a time or all at once.
Goto line	Moves the cursor to the start of a specified line. (This is useful when debugging DXL programs because errors are indicated against line numbers.)

Browsing the DXL library

The DXL library is in the DOORS home directory's `/lib/dxl` folder.

You can browse the DXL library when you are:

- Using the DXL Interaction window, by clicking the **Browse** button to find a program to run.
- Creating a DXL attribute, by clicking the **Browse** button to find a program to use for the attribute (see “DXL attribute,” on page 385).
- Creating a layout DXL column, by clicking the **Browse** button to find a program to use for the layout DXL column (see “Layout DXL,” on page 604).

You see the DXL Library window. The DXL programs and the buttons you see depend on where you were when you clicked the **Browse** button.

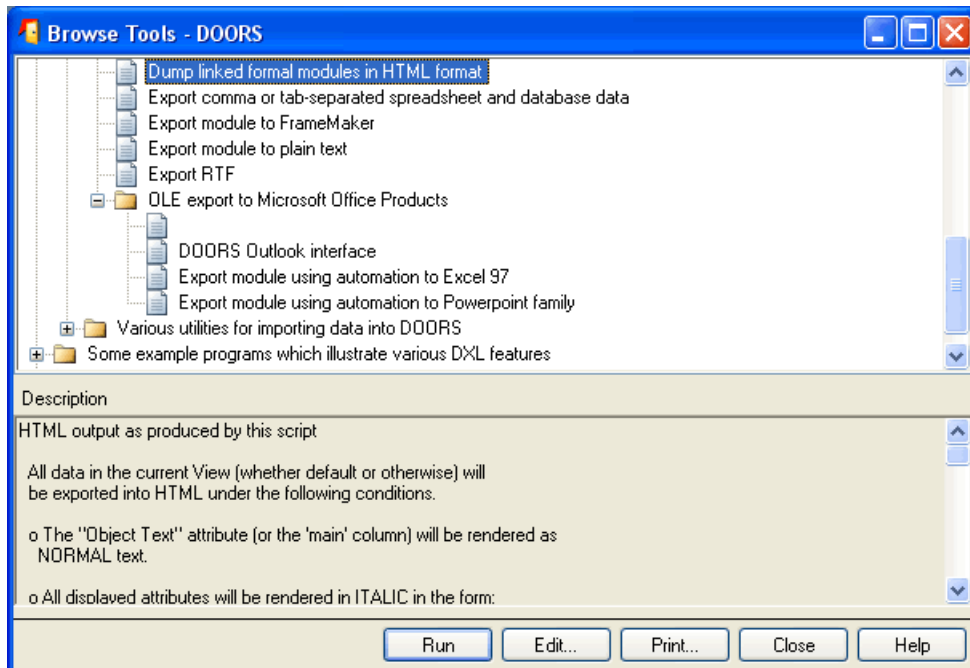

Button	Action
Run	Runs the selected program in your DXL Interaction window.
Edit	Edits the selected program.
Print	Prints the selected program.

Language fundamentals

DXL is layered on an underlying programming language whose fundamental data types, functions and syntax are largely based on C and C++. To support the needs of script writing, there are some differences. In particular, concepts like main program are avoided, and mandatory semicolons and parentheses have been discarded.

Auto-declare

In DXL there is a mechanism called auto-declare, which means that a user need not specify a type for a variable. For example, in the script:

```
i=5
print i
```

the interpreter declares a new variable and deduces from the assignment that its type is `int`.

Because DXL is case-sensitive, there is a potential hazard when relying on this mechanism to type variables. If you make a mistake when typing a variable name, the interpreter assumes that a new variable is being used, which creates errors that are hard to find.

This feature can be disabled by adding the line:

```
XFLAGS_ &=~AutoDeclare_
```

to the bottom of the file `$DOORSHOME/lib/dxl/startup.dxl`.

Syntax

The syntactic style is more like natural language or standard mathematical notation. Consider the function:

```
string deleteUser(string name)
```

This can be called as follows:

```
deleteUser "Susan Brown"
```

The lack of semicolons is possible through DXL's recognition of the end of a line as a statement terminator, except when it follows a binary operator. This means you can break an expression like `2+3` over a line by making the break after the `+` sign. A comment ending in a dash (`//-`) also allows line continuation.

As in C, `==` is used for equality, while `=` is used for assignment. Unlike C or Pascal, concatenation of symbols is a valid operation.

Parsing

Statement or expression parsing is right associative and has a relatively high precedence. Parenthesis has the highest precedence.

Because `sqrt` is defined as a function call that takes a single type real argument:

```
sqrt 6.0
```

is recognized as a valid function call, whereas in C it is:

```
sqrt(6.0)
```

So, the C statement:

```
print(sqrt(6.0))
```

can be:

```
print sqrt 6.0
in DXL.
```

The following script declares a function `max`, which takes two type `int` arguments:

```
int max(int a, b) {
    if a < b then return b else return a
}
print max(2, 3)
```

The call of `max` is parsed as `print (max (2, 3))`, which is valid. The statement:

```
print max 2,3
```

would generate errors. Because the comma has a lower precedence than concatenation, it is parsed as:

```
((print max(2)),3)
```

If in doubt, use the parentheses, and separate statements for concatenation operations.

Naming conventions

As a general rule, DXL reserves identifiers ending in one or more underscores (`_`, `__`) for its own use. You should not use functions, data types or variables with trailing underscores, with the exception of those documented in this manual.

Names introduced as data types in DXL, such as `int`, `string`, `Module` and `Object`, must not be used as identifiers. The fundamental types such as `int` and `string` are in lower case. DOORS specific types all start with an upper case letter to distinguish them from these, and to allow their lower case versions to be used as identifiers.

Loops

In DXL, loops are treated just like any other operator, and are **overloaded**, that is, declared to take arguments and return values of more than one type. The loop notation used is as follows:

```
for variable in something do {
    ...
}
```

The for loops all iterate through all values of an item, setting `variable` to each value in turn.

Note: When using for loops, care must be taken when deleting items within the loop and also opening and closing items within a for loop. For example, if `variable` is of type `Module` and `something` is of type `Project`, and within the for loop a condition is met that means one of the modules will be deleted, this should not be done within the for loop as it can lead to unexpected results. A recommended method is to use a skip list to store the modules and to do any manipulation required using the contents of the skip list.

Lexical conventions

Semicolon and end-of-line

DXL diverges from C in that semicolons can be omitted in some contexts, with end-of-line (**newline**) causing statement termination. Conversely, newline does not cause statement termination in other contexts. This is a useful property; programs look much better, and in practice the rules are intuitive. The rules are:

- Any newlines or spaces occurring immediately after the following tokens are ignored:

```

;      ,      ?      :      =      (      +      *      [
&      -      !      ~      /      %      <<      >>      <>
<      >      <=     >=     ==     !=     ^      |      &&
and    ||     or     ^^     +=     -=     *=     /=     %=
<<=    >>=    &=     |=     ^=     <-     :=     =>     ..
.      ->    ::     \

```

- Any newlines before an `else` or a `)` are ignored. All other newlines delimit a possibly empty statement.
- Multiple consecutive areas of white space containing newlines are treated as single newlines.
- The recognition of a newline can be avoided by prefixing it with an empty `//` comment or a comment ending in `-`.

Comments

The characters `/*` start a comment which terminates with the characters `*/`. This style of comment does *not* nest.

The characters `//` start a comment which terminates at the end of the line on which it occurs. The end-of-line is not considered part of the comment unless the comment is empty or the final character is `-`. This latter feature is useful for adding comments to a multi-line expression, or for continuing a concatenation expression over two lines.

Notably, comments which immediately follow conditional statements can cause code to behave unexpectedly.

The following program demonstrates some comment forms:

```

/* Some comment examples (regular C comment) */
int a          // a C++ style comment
int b = 1 +    // We need a trailing - at the end      -
              2    // to prevent a syntax error between
                  // "+" and the newline

```

```

print //
    "hello" // the // after print causes
            // the following newline to be
            // ignored
/*
{
    int C      // this whole block is commented out
}
*/

```

Identifiers

An identifier is an arbitrarily long sequence of characters. The first character must be a letter; the rest of the identifier may contain letters, numerals or either of the following two symbols:

– ‘

DXL is case sensitive (upper- and lower-case letters are considered different).

The following words are reserved for use as keywords, and must not be used otherwise:

and	bool	break	by	case	char
const	continue	default	do	else	enum
for	if	in	int	module	object
or	pragma	real	return	sizeof	static
struct	string	switch	then	union	void
while					

The following keywords are not currently supported in user programs, but are reserved for future use:

case	const	default	enum
struct	switch	union	

A keyword is a sequence of letters with a fixed syntactic purpose within the language, and is not available for use as an identifier.

File inclusion

To include files into DXL scripts, you can use either of the following:

```

#include "file"
#include <file>

```

Absolute or relative path names can be used. Relative paths must be based on one of the following forms depending on the platform:

```
$DOORSHOME/lib/dx1      (UNIX)
$DOORSHOME\\lib\\dx1    (Windows)
```

where `DOORSHOME` is defined in a UNIX[®] environment variable, or on Windows platforms in the registry. The Windows-style file separator (`\`) must be duplicated so that DXL does not interpret it as a meta-character in the string.

If the `addins` directory is defined in a UNIX environment variable or the Windows registry, this directory is also searched, so relative path names can be with respect to the `addins` directory.

Note: The UNIX shell file name specification form `~user/` is not supported.

Pragmas

Pragmas modify the background behavior of the DXL interpreter, for example:

```
pragma runLim, int cyc
```

sets the time-out interval `cyc` as a number of DXL execution cycles. The time-out is suppressed if `cyc` is set to zero, as shown in the following example:

```
pragma runLim, 0          // no limit
pragma runLim, 1000000    // explicit limit
```

There is also a pragma for setting the size of the DXL run-time stack, which is used as follows:

```
pragma stack, 10000
```

Constants

Integer constants

An integer constant consisting of a sequence of digits is interpreted as octal if it begins with a 0 (digit zero); otherwise it is interpreted as decimal.

A sequence of digits preceded by `0x` or `0X` is interpreted as a hexadecimal integer.

A sequence of 0s or 1s preceded by `0b` is interpreted as a binary number, and converted to an integer value.

Character constants

A character constant is a character enclosed in single quotes, as in `'x'`. The value of a character constant is defined to be of type `char`.

Certain non-graphic characters, the single quote and the backslash, can be represented according to the following escape sequences:

Character	Escape sequence
newline	<code>\n</code>
horizontal tab	<code>\t</code>
backspace	<code>\b</code>
carriage return	<code>\r</code>
form-feed	<code>\f</code>
backslash	<code>\\</code>
single quote	<code>\'</code>
bit pattern	<code>\ddd</code>
any other character	<code>\c</code>

The escape `\ddd` consists of the backslash followed by 1, 2, or 3 octal digits.

Any other character that is escaped is passed straight through.

Type real constants

A type `real` consists of an integer part, a decimal point, a fraction part, an `e` or `E`, and an integer exponent. The integer and fraction part both consist of a sequence of digits.

You can omit either the integer part or the fraction part, but not both. You can omit either the decimal point or the exponent with its `e` or `E`. You can add a sign to the exponent.

Example

```
1.0
0.1
1e10
1.2E30
```

The null constant

The constant `null` is used as a polymorphic value to indicate a null value. You can use it for any derived type (see “Derived types,” on page 14). You can use it for both assignment to variables and conditional tests on variables.

Example

```
Object obj = null
```



```

if (null obj) {
    ack "This object is empty"
}

```

Strings

A string literal, of type `string` and storage class `static`, is a sequence of characters surrounded by double quotes, as in `"apple"`.

Within a string the double quote (") must be preceded by a backslash (\). For example `"Pear\""` is the string `Pear"` in quotes. In addition, you can use the same escape sequences as described in “Character constants,” on page 11, including the newline character.

Identifiers

Identifiers denote variables, functions, types and values. You can introduce an identifier into a program by declaration or by immediate declaration. Immediate declaration is when an undeclared identifier is used as the left hand side of an assignment statement.

Variables

Variables represent regions of computer memory. The meaning of the value stored in a variable is determined by the type of the identifier used to access the variable.

Unassigned variables contain the unassigned pattern, which is checked on all references. In this way, errors with unassigned variables are avoided, and an accurate error message is reported.

Scope

Once declared, an identifier has a region of validity within the program known as its `scope`.

In general, identifiers are in scope following their declaration within the current block, and are available within nested blocks. Identifiers can be hidden by re-declaration in nested blocks. For example, the following code prints a 4 and then a 3 in the output pane of the DXL Interaction window.

```

int i = 3
if (true) {
    int i = 4
    print i "\n"
}
print i "\n"

```

Types

Fundamental types

DXL has the following base types:

Base type	Description
<code>bool</code>	Denotes the domain of values <code>true</code> and <code>false</code> , which are provided as predefined constants.
<code>char</code>	Is similar to the C character type.
<code>int</code>	Is the only integer type provided in DXL. On all platforms, integers are signed, and have a precision of 32 bits.
<code>real</code>	Is like C's double type, with a precision of 64 bits.
<code>void</code>	Is the type with no values; its main use is in declaring functions that do not return a result.
<code>string</code>	Is similar to the derived C type <code>char*</code> .

Derived types

DXL supports arrays, functions and references. An internal class facility provides new non-fundamental types, referred to as **built-in** types, such as `Object`, `Module` and `Template`. DXL does not support class creation by user programs.

Declarations

Declarations are the mechanism used to associate identifiers with variables, functions or values.

Declarators

DXL follows C in its declarator syntax. However, only the simple forms should be necessary in DXL programs.

DXL extends C style arrays by allowing a variable to define the bounds of the array. The number of elements in an array is available by using the `sizeof` function.

Unlike C, DXL arrays can have only one dimension.

In addition to the normal C declarator forms, DXL provides the C++ reference declarator `&`.

DXL uses the ANSI C method of supplying a function's formal parameters in the declarator itself with each argument given as a fully specified type.

The following script gives some example declarations:

```
int i, j, k      // declare 3 integers
int n = 4       // declare an integer and
                // initialize it
bool a[2]       // declare an array of type bool
                // of size 2
int b[n]        // declare an integer array of
                // size n
print sizeof a  // prints "2"
```

Note: A declaration of the form 'int n = {1,2,3}' is not supported.

Immediate declaration

Immediate declaration is a DXL extension from C, which means that the first use of an undeclared variable is also a declaration. It must be used in a context where an unambiguous value is given to it, for example the left hand side of an assignment statement:

```
i = 2
print i
```

Once declared, the identifier must be used consistently.

Function definitions

DXL functions are very close to the style of ANSI C functions. The following script gives some examples:

```
// define a function to find the maximum of
// two integers
int i
int max(int a, b) {
    return a < b ? b : a
} // max

// This function applies f to every element in a,
// using an accumulation variable r which is
// initialized to base.
int apply_accumulate(int base, int a[], int f(int, int)) {
    int r = base
    for (i = 0; i < sizeof a; i++) {
        r = f(r, a[i])
    }
}
```

```

        return r
    } // apply_accumulate
int a[5]
print "Filling an array:\n\n"
for (i = 0; i < sizeof a; i++) {
    a[i] = random 1000
    print a[i] "\n"
} // for
print "largest number was: "
print apply_accumulate(0, a, max)
// print largest element in a

```

Line 3 defines the function `max`, which has two parameters of type `int` and returns a type `int`. One difference from ANSI C is that the parameter type specifier `int` need not be repeated before the `b` parameter.

Line 10 declares a function parameter `f`. Note that `f`'s parameters do not include redundant identifiers.

Operator functions

You can redefine DXL operators by prefixing the operator with `::` to turn it into an identifier.

Example

This example defines a multiplication operator that applies to strings and integers.

```

string ::*(string s, int n) {
    string x = ""
    int i
    for i in 0 : n-1 do {
        x = x s
    }
    return x
}
print ("apple " * 4)

```

This prints out:

```
apple apple apple apple
```

If you wish to overload the concatenation operator, which is normally represented by a space, use the symbol `...`

```

string ::...(real r, int n) {
    string s = ""
    int i
    // concatenate the string to a space

```

```

    // n times
    for i in 0:n-1 do {
        s=s r " "
    }

    return s
}

print (2.45 3) "\n"           // try it out

```

The program prints the string:

```
2.450000 2.450000 2.450000
```

Expressions

This section outlines the major differences between C and DXL expressions. The operations defined on DXL fundamental types are explained in “Fundamental types and functions,” on page 57.

Reference operations

DXL supports C++ style reference operations. References are like `var` parameters in Pascal or Ada, which means they provide an alias to a variable, not a copy. To declare a reference variable its name must be preceded by an ampersand (&).

Example

This example is a program to swap two integers. In C you have explicitly to pass the address of the variables to be swapped and then de-reference them within the body of the function. This is not required in DXL.

```

// swap two integers
void swap (int &a, &b) {
    int temp
    temp = a; a = b; b = temp
}

int x = 2
int& z = x           // z is now an alias for x
int y = 3
print x " " y "\n"
swap(z, y)          // equivalent to swap(x,y)
print x " " y "\n"

```

This program prints the string:

```
2 3
3 2
```

Overloaded functions and operators

Most functions and operators can be declared to take arguments and return values of more than one type.

Example

This example overloads a commonly used identifier `print` to provide an object printer.

```
// Overload print to define an Object printer
void print(Object o) {
    string h = o."Object Heading"
    string t = o."Object Text"
    print h ":\n\n" t "\n"
}
print current Object
```

Function calls

DXL allows calls of functions defined without parameters to omit the empty parenthesis, except where the call appears as a function argument or any other context where a function name is valid. Function calls with single arguments can also omit the parenthesis, but beware of concatenation's high precedence when the argument passed is an expression.

Note: When overloading functions, ensure that the first declaration of the function does not have a void parameter, e.g. `void print(void)`. This may lead to unexpected results. Furthermore, function calls of the form `void print(int i=0, int g=0)` should also not be used.

Example

```
void motto() {           // parameterless
    print "A stitch in time saves nine.\n"
} // motto
int square(int x) {
    return x*x
} // square
motto                   // call the function
print square 9         // two function calls
```

Casts

Because of DXL's overloading facility, it is easy to write expressions that have more than one possible interpretation; that is, they are ambiguous. **Casts** are used to pick which interpretation is required. Casts in DXL come in two forms:

```
expression type
(type expression)
```

In the first form, the type name can appear after the expression, as in:

```
o = current Object
```

In the second form, the type may come first, but the whole expression must be within parenthesis:

```
o = (Object current)
```

Range

A range expression extracts a substring from a string, or substring from a buffer, and is used in regular expression matching. It has two forms:

```
int from : int to
int from : int to by int by
```

Examples are given with the functions that use ranges.

Statements

This section describes how to construct statements in DXL.

Compound statements

Compound statements are also referred to as **blocks**.

Several statements can be grouped into one using braces { . . . }.

Conditional statements

The `if` statement takes an expression of type `bool`, which must be in parenthesis. If the expression evaluates to `true`, it executes the following statement, which can be a block. If the expression evaluates to `false`, an optional `else` statement is executed.

As an alternative form, the parenthesis around the condition can be dropped, and the keyword `then` used after the condition.

Example

```
int i = 2, j = 2
if (i < 3) {
    i += 2
} else {
    i += 3
}
```

```
if i == j then j = 22
```

The then form does not work with a condition that starts with a component in parenthesis, for example:

```
if (2 + 3) == 4 then print "no"
```

generates a syntax error.

DXL also supports the C expression form:

```
2 + 3 == 5 ? print "yes" : print "no"
```

Loop statements

DXL has three main loop (iteration) statements. It supports the C forms:

```
for (init; cond; increment) statement
```

```
while (cond) statement
```

and a new form:

```
for type1 v1 in type2 v2 do
```

where *type1* and *type2* are two types, possibly the same; *v1* is a reference variable and *v2* is a variable, which can be a range expression (see “Range,” on page 19). This form is heavily used in DXL for defining type-specific loops.

Example

```
int x
int a=2
int b=3
for (x=1; x <= 11; x+=2) {
    print x
}
while (a==2 and b==3) {
    print "hello\n";
    a = 3
}
for x in 1 : 11 by 2 do {
    print x
}
```

In this example, the first loop is a normal C `for` loop; the second is a normal C `while` loop. Note that DXL offers the `keyword` and `as` as an alternative to `&&`.

The last form in the example uses a `range` statement, which has the same semantics as the first C-like loop.

Break statement

The `break` statement causes an immediate exit from a loop. Control passes to the statement following the loop.

Example

```
int i = 1
while (true){
    print i++
    if (i==10){
        break
    }// if (i==10)
}// while (true)
```

Continue statement

The `continue` statement effects an immediate jump to the loop's next test or increment statement.

Example

```
int i = 1
while (true){
    if (i==4) { // don't show 4
        i++
        continue
    }// if (i==4)
    print i++
    if (i==10){
        break
    }// if (i==10)
}// while (true)
```

Return statement

The `return` statement either exits a void function, or returns the given value in any other function.

Note: Care should be taken when using the `return` statement. For example, assigning a value to a variable where the assignment is a function, and that function returns no value, can lead to unexpected values being assigned to the variable.

Example

```
// exit void function
void print(Object o) {
    if (null o)
        return string h = o."Object Heading"
    print h "\n"
} // print
// return given value
int double(int x) {
    return x + x // return an integer
} // double
print double 111
```

Null statement

The null (empty) statement has no effect. You can create a null statement by using a semicolon on its own.

Example

```
int a = 3
if (a < 2) ; else print a
```

Basic functions

This section defines some basic functions, which can be used throughout DXL.

of

This function is used as shown in the following syntax:

```
of (argument)
```

Returns the passed argument, which can be of any type. It has no other effect. It is used to clarify code.

Example

```
if end of cin then break
```

sizeof

This function is used as shown in the following syntax:

```
sizeof(array[])
```

Returns the number of elements in the array, which can be of any type.

Example

```
string strs[] = {"one", "two", "three"}
int ints[] = {1, 2, 3, 4}
print sizeof strs // prints 3
print sizeof ints // prints 4
```

halt

Declaration

```
void halt()
```

Operation

Causes the current DXL program to terminate immediately. This is very useful if an error condition is detected in a program.

Example

```
if (null current Module) {
    ack "program requires a current module"
    halt
}
```

checkDXL

Declaration

```
string checkDXL[File](string code)
```

Operation

Provides a DXL mechanism for checking DXL code.

The `checkDXL` function analyzes a DXL program and returns the string that would have been produced in the DXL Interaction window had it been run on its own.

The `checkDXLFile` function analyzes a file and returns the error message that would have been produced in the DXL Interaction window had the file been run.

Example

```
string errors =
    checkDXL("int j = 3 \n print k + j")
if (!null errors)
    print "Errors found in dxl string:\n" errors
    "\n"
```

would produce the following in the DXL Interaction window's output pane.

Errors found in dxl string:

```
-E- DXL: <Line:2> incorrect arguments for (+)
-E- DXL: <Line:2> incorrect arguments for function (print)
-E- DXL: <Line:2> undeclared variable (k)
```

sort

Declaration

```
void sort(string stringArray[])
```

Operation

Sorts the string array *stringArray*. The sort function handles string arrays containing non-ASCII characters, as do the string and Buffer comparison operators.

Example

```
int noOfHeadings = 0
Object o
for o in current Module do {
    string oh = o."Object Heading"
    if (!null oh) noOfHeadings++
}
string headings[noOfHeadings]
int i = 0
for o in current Module do {
    string oh = o."Object Heading"
    if (!null oh) headings[i++] = oh
}
sort headings
for (i = 0; i < noOfHeadings; i++) print headings[i] "\n"
```

activateURL

Declaration

```
void activateURL(string url)
```

Operation

This is equivalent to clicking on a URL in a formal module.

batchMode, isBatch

Declaration

```
bool batchMode()
```

```
bool isBatch()
```

Operation

Both functions return `true` if DOORS is running in batch mode, and `false` if DOORS is running in interactive mode.

Chapter 3

New in DXL for DOORS 9.0

This chapter describes features that are new in DOORS 9.0:

- Discussions
- Descriptions
- Filtering
- HTML
- Miscellaneous

Discussions

- Discussion Types
- Properties
- Iterators
- Operations
- Triggers
- Example

Discussion Types

Discussion

Represents a discussion.

Comment

Represents a comment in a discussion.

DiscussionStatus

Represents the status of a discussion. The possible values are `Open` and `Closed`.

Properties

The following tables describe the properties available for the discussion and comment types. Property values can be accessed using the . (dot) operator, as shown in the following syntax:

variable.property

where:

variable is a variable of type `Discussion` or `Comment`

property is one of the discussion or comment properties

Discussion

Property	Type	Extracts
status	DiscussionStatus	The status of the discussion: whether it is open or closed.
summary	string	The summary text of the discussion, which may be null
createdBy	User	The user who created the discussion, if it was created in the current database. Otherwise it returns null.
createdByName	string	The name of the user who created the discussion, as it was at the time of creation.
createdByFullName	string	The full name of the user who created the discussion, as it was at the time of creation.
createdOn	Date	The date and time the discussion was created.
createdDataTimestamp	Date	The last modification timestamp of the object or module that the first comment in the discussion referred to.
lastModifiedBy	User	The user who added the last comment to the discussion, or who last changed the discussion status
lastModifiedByName	string	The username of the user who added the last comment to the discussion, or who last changed the discussion status.
lastModifiedByFullName	string	The full name of the user who added the last comment to the discussion, or who last changed the discussion status.
lastModifiedOn	Date	The date and time the last comment was added, or when the discussion status was last changed.
lastModifiedDataTimestamp	Date	The last modification timestamp of the object or module that the last comment in the discussion referred to.

Property	Type	Extracts
<code>firstVersion</code>	<code>ModuleVersion</code>	<p>The version of the module the first comment was raised against.</p> <p>Note: If a comment is made against the current version of a module and the module is then baselined, this property will return a reference to that baseline. If the baseline is deleted, it will return the deleted baseline.</p>
<code>lastVersion</code>	<code>ModuleVersion</code>	<p>The version of the module the latest comment was raised against. See note for the <code>firstVersion</code> property above.</p>
<code>firstVersionIndex</code>	<code>string</code>	<p>The baseline index of the first module version commented on in the discussion. Can be used in comparisons between module versions.</p>
<code>lastVersionIndex</code>	<code>string</code>	<p>The baseline index of the last module version commented on in the discussion. Can be used in comparison between module versions.</p>

Comment

Property	Type	Extracts
<code>text</code>	<code>string</code>	The plain text of the comment.
<code>moduleVersionIndex</code>	<code>string</code>	The baseline index of the module version against which the comment was raised. Can be used in comparisons between module versions.
<code>status</code>	<code>DiscussionStatus</code>	The status of the discussion in which the comment was made.
<code>moduleVersion</code>	<code>ModuleVersion</code>	The version of the module against which the comment was raised. Note: If a comment is made against the current version of a module and the module is then baselined, this property will return a reference to that baseline. If the baseline is deleted, it will return the deleted baseline.
<code>onCurrentVersion</code>	<code>bool</code>	True if the comment was raised against the current version of the module or an object in the current version.
<code>changedStatus</code>	<code>bool</code>	Tells whether the comment changed the status of the discussion when it was submitted. This will be true for comments which closed or re-opened a discussion.
<code>dataTimestamp</code>	<code>Date</code>	The last modified time of the object or module under discussion, as seen at the commenting users client at the time the comment was submitted.
<code>createdBy</code>	<code>User</code>	The user that created the comment. Returns null if the user is not in the current user list.
<code>createdByName</code>	<code>string</code>	The username of the user who created the comment.
<code>createdByFullName</code>	<code>string</code>	The full name of the user who created the comment.
<code>createdOn</code>	<code>Date</code>	The data and time when the comment was created.
<code>discussion</code>	<code>Discussion</code>	The discussion containing the comment.

Iterators

for Discussion in Type

Syntax

```
for disc in Type do {
...
}
```

where:

disc is a variable of type `Discussion`

Type is a variable of type `Object`, `Module`, `Project` or `Folder`

Operation

Assigns the variable *disc* to be each successive discussion in *Type* in the order they were created. The first time it is run the discussion data will be loaded from the database.

The `Module`, `Folder` and `Project` variants will not include discussions on individual objects.

The `Folder` and `Project` variants are provided for forward compatibility with the possible future inclusion of discussions on folders and projects. They perform no function in DOORS 9.0.

for Comment in Discussion

Syntax

```
for comm in disc do {
...
}
```

where:

comm is a variable of type `Comment`

disc is a variable of type `Discussion`

Operation

Assigns the variable *comm* to be each successive comment in *disc* in chronological order. The first time it is run on a discussion in memory, the comments will be loaded from the database. Note that if a discussion has been changed by a refresh (e.g. in terms of the last `Comment` timestamp) then this will also refresh the comments list.

The discussion properties will be updated in memory if necessary, to be consistent with the updated list of comments.

Operations

create (Discussion)

Declaration

```
string create(target, string text, string summary, Discussion& disc)
```

Operation

Creates a new `Discussion` about `target`, which can be of type `Object` or `Module`. Returns null on success, error string on failure. Also add `text` as the first comment to the discussion.

addComment

Declaration

```
string addComment(Discussion disc, target, string text, Comment& comm)
```

Operation

Adds a `Comment` about `target` to an open `Discussion`. Note that `target` must be an `Object` or `Module` that the `Discussion` already relates to. Returns null on success, error string on failure.

closeDiscussion

Declaration

```
string closeDiscussion(Discussion disc, target, string text, Comment& comm)
```

Operation

Closes an open `Discussion` `disc` by appending a closing comment, specified in `text`. Note that `target` must be an `Object` or `Module` that `disc` already relates to. Returns null on success, error string on failure.

reopenDiscussion

Declaration

```
string reopenDiscussion(Discussion disc, target, string text, Comment& comm)
```

Operation

Reopens a closed `Discussion` `disc` and appends a new comment, specified in `text`. Note that `target` must be an `Object` or `Module` that `disc` already relates to. Returns null on success, error string on failure.

delete (Discussion)

Declaration

```
string delete (Discussion& d)
```

Operation

Deletes the specified `Discussion` if the user has the permission to do so. Returns null on success, or an error string on failure.

sortDiscussions

Declaration

```
void sortDiscussions ({Module m|Object o|Project p|Folder f}, property, bool ascending)
```

Operation

Sorts the discussions list associated with the specified item according to the given *property*, which may be a date, or a string property as listed in the discussions properties list. String sorting is performed according to the lexical ordering for the current user's default locale at the time of execution.

If the discussion list for the specified item has not been loaded from the database, this perm will cause it to be loaded.

The `Folder` and `Project` forms are provided for forward compatibility with the possible future inclusion of discussions on folders and projects. They perform no function in 9.0.

getDiscussions

Declaration

```
string getDiscussions ({Module m|Object o|Project p|Folder f})
```

Operation

Refreshes from the database the `Discussion` data for the specified item in memory. Returns null on success, or an error on failure.

getObjectDiscussions

Declaration

```
string getObjectDiscussions (Module m)
```

Operation

Refreshes from the database all `Discussions` for all objects in the specified module. Returns null on success, or an error on failure

getComments

Declaration

```
string getComments (Discussion d)
```

Operation

Refreshes from the database the comments data for the specified `Discussion` in memory. Returns null on success, or an error on failure.

Note: The `Discussion` properties will be updated if necessary, to be consistent with the updated comments list.

mayModifyDiscussionStatus

Declaration

```
bool mayModifyDiscussionStatus (Discussion d, Module m)
```

Operation

Checks whether or not the current user has rights to close or re-open the specified discussion on the specified module.

baselineIndex

Declaration

```
string baselineIndex (Module m)
```

Operation

Returns the baseline index of the specified `Module`, which may be a baseline or a current version. Can be used to tell whether or not a `Comment` can be raised against the given `Module` data in a given `Discussion`.

Note: A `Comment` cannot be raised against a baseline index which is less than the `lastVersionIndex` property of the `Discussion`.

Triggers

Trigger capabilities have been expanded so that triggers can now be made to fire before or after a `Discussion` or a `Comment` is created.

As follows:

	pre	post
Comment	x	x

	pre	post
Discussion	x	x

comment

Declaration

```
Comment comment(Trigger t)
```

Operation

Returns the `Comment` with which the supplied `Trigger` is associated, null if not a `Comment` trigger.

discussion

Declaration

```
Discussion discussion(Trigger t)
```

Operation

Returns the `Discussion` with which the supplied `Trigger` is associated, null if not a `Discussion` trigger.

dispose (Discussion/Comment)

Declaration

```
void dispose({Discussion& d|Comment& c})
```

Operation

Disposes of the supplied `Comment` or `Discussion` reference freeing the memory it uses.

Can be called as soon as the reference is no longer required.

Note: The disposing will take place at the end of the current context.

Example

```
// Create a Discussion on the current Module, with one follow-up Comment...
Module m = current
Discussion disc = null
create(m, "This is my\nfirst comment.", "First summary", disc)
Comment cmt
```



```

addComment(disc, m, "This is the\nsecond comment.", cmt)

// Display all Discussions on the Module
for disc in m do
{
    print disc.summary " (" disc.status ") \n"
    User u = disc.createdBy
    string s = u.name
    print "Created By: " s "\n"
    print "Created By Name: \"\" disc.createdByName \"\" \n"
    print "Created On: " stringOf(disc.createdOn) "\n"
    u = disc.lastModifiedBy
    s = u.name
    print "Last Mod By: " s "\n"
    print "Last Mod By Name: \"\" disc.lastModifiedByName \"\" \n"
    print "Last Mod On " stringOf(disc.lastModifiedOn) "\n"
    print "First version: " (fullName disc.firstVersion) " [" //-(
        (versionString disc.firstVersion) ") \n"
    print "Last version: " (fullName disc.lastVersion) " ["
        (versionString disc.lastVersion) ") \n"
    Comment c
    for c in disc do
    {
        print "Comment added by " (c.createdByName) " at " //-(
            (stringOf(c.createdOn)) " : \n"
        print "Module Version: " (fullName c.moduleVersion) " [" //-(
            (versionString c.moduleVersion) ") \n"
        print "Data timestamp: " (stringOf c.dataTimestamp) "\n"
        print "Status: " c.status " (" (c.changedStatus ? "Changed" //-(
            : "Unchanged") ") \n"
        print "On current: " c.onCurrentVersion "\n"
        print c.text "\n"
    }
}

```

```
}
```

Descriptions

This section describes the DXL support in DOORS for the new description functionality.

- View Descriptions
- Attribute Type Descriptions
- Attribute Definition Descriptions

View Descriptions

setViewDescription

Declaration

```
void setViewDescription (ViewDef vd, string desc)
```

Operation

Sets the description for a view where *vd* is the view definition handle.

getViewDescription

Declaration

```
string getViewDescription (ViewDef vd)
```

Operation

Returns the description for a view where *vd* is the view definition handle.

Attribute Type Descriptions

setDescription

Declaration

```
AttrType setDescription (AttrType at, string desc, string &errMess)
```

Operation

Sets the description for the specified attribute type. Returns null if the description is not successfully updated.

modify

Declaration

```
AttrType modify (AttrType at, string name, string codes[], int values, int
colors, string desc[], [int arrMaps[],] string &errMess)
```

Operation

Modifies the supplied attribute type with the corresponding values and descriptions. Can be used to update the descriptions of old enumeration types.

The optional *arrMaps* argument specifies existing index values for enumeration values, allowing for their re-ordering.

create

Declaration

```
AttrType create (string name, string codes[], int values[], int colors[], string
desc[], string &errMess)
```

Operation

The new *descs[]* argument allows the creation of a new enumeration based attribute type, whose enumerations use those descriptions. Returns null if creation is not successful.

description property

Both attribute types themselves, and the enumeration values they may contain, have a new *description* property. It can be accessed by using the dot (.) operator.

Example

```
AttrType at
string desc
int i
...
//To get the description of the attribute type
desc = at.description
...
//To get the description of the enumeration values with index i
```

```
desc = at.description[i]
```

Attribute Definition Descriptions

description property

Attribute definitions can now contain a `description` property. It can be accessed by using the dot (`.`) operator.

Example

```
Module m = current
AttrDef ad = find(m, "AttrName")
print ad.description
```

description (create)

Attribute definition descriptions can be specified during their creation.

Example

```
AttrDef ad = create object (description "My description") (type "string") //-
              (default "defvalue") (attribute "AttrName")
```

description (modify)

Attribute definition descriptions can be altered by using the `modify` perm is one of the following ways. Note the new `setDescription` property constant.

Example1

```
Module m = current
AttrDef ad = find(m, "AttrName")
modify (ad, module (description "New Description") (type "string") //-
              (default "New default") (attribute "New Name"))
```

Example2

```
Module m = current
AttrDef ad = find(m, "AttrName")
modify (ad, setDescription, "New description text")
```

Filtering

This section describes the DXL support in DOORS for the new module explorer filtering functionality added in DOORS 9.0.

applyFiltering

Declaration

```
void applyFiltering (Module)
```

Operation

Sets the module explorer display to reflect the current filter applied to the specified module.

unApplyFiltering

Declaration

```
void unApplyFiltering (Module)
```

Operation

Switches off filtering in the module explorer for the specified module.

applyingFiltering

Declaration

```
bool applyingFiltering (Module)
```

Operation

Returns a boolean indicating whether filtering is turned on in the module explorer for the specified module.

HTML

This section describes the DXL support the HTML functionality added in DOORS 9.0.

- HTML Control
- HTML Edit Control

HTML Control

The section describes the DXL support for the HTML control added in DOORS 9.0.

Note: Some of the functions listed below take an ID string parameter to identify either a frame or an HTML element. In each of these methods, frames or elements nested within other frames are identified by concatenating the frame IDs and element IDs as follows: `<top frame ID>/[<sub frame ID>/...]<element ID>`.

In methods requiring a frame ID, passing `null` into this parameter denotes the top level document.

These methods refer to all frame types including IFRAME and FRAME elements.

htmlView

Declaration

```
DBE htmlView (DB parentDB, int width, int height, string URL, bool
before_navigate_cb(DBE element, string URL, string frame, string postData), void
document_complete_cb(DBE element, string URL), bool navigate_error_cb(DBE
element, string URL, string frame, int statusCode), void progress_cb(DBE
element, int percentage))
```

Operation

Creates an HTML view control where the arguments are defined as follows:

parentDB	The dialog box containing the control.
width	The initial width of the control.
height	The initial height of the control.
URL	The address that will be initially loaded into the control. Can be null to load a blank page (about:blank).

parentDB`before_navigate_cb`**The dialog box containing the control.**

Fires for each document/frame before the HTML window/frame navigates to a specified URL. It could be used, amongst other things, to intercept and process the URL prior to navigation, taking some action and possibly also navigating to a new URL.

The return value determines whether or not to cancel the navigation. Returning `false` cancels the navigation.

Its arguments are defined as follows:

- `element`: The HTML control itself
- `URL`: The address about to be navigated to.
- `frame`: The frame for which the navigation is about to take place.
- `postData`: The data about to be sent to the server if the HTTP POST transaction is being used.

`document_complete_cb`

Fires for each document/frame once they are completely loaded and initialized. It could be used to start functionality required after all the data has been received and is about to be rendered, for example, parsing the HTML document.

Its arguments are defined as follows:

- `element`: The HTML control itself
- `URL`: The loaded address.

`navigate_error_cb`

Fires when an error occurs during navigation. Could be used, for example, to display a default document when internet connectivity is not available.

Its arguments are defined as follows:

- `elements`: The HTML control itself.
- `URL`: The address for which navigation failed.
- `frame`: The frame for which the navigation failed.
- `statusCode`: Standard HTML error code.

`progress_cb`

Used to notify about the navigation progress, which is supplied as a percentage.

set(html callback)

Declaration

```
void set (DBE HTMLView, bool event_cb(DBE element, string ID, string tag, string event_type))
```

Operation

Attaches a callback to HTML control element that receives general HTML events. The `ID` argument identifies the element that sourced the event, the `tag` argument identifies the type of element that sourced the event, and the `event_type` argument identifies the event type. Note that the only event types currently supported are `click` and `dblclick`.

If this function is used with an incorrect DBE type, a DXL run-time error occurs.

set(html URL)

Declaration

```
void set (DBE HTMLView, string URL)
```

Operation

Navigates the given *HTMLView* to the given *URL*.

Can only be used to navigate the top level document and cannot be used to navigate nested frame elements.

setURL

Declaration

```
void setURL (DBE HTMLView, string ID, string URL)
```

Operation

Navigates the frame identified by *ID* to the given *URL*. The ID may be null.

getURL

Declaration

```
string getURL (DBE HTMLView, string ID)
```

Operation

Returns the URL for the currently displayed frame as identified by its *ID*. The ID may be null.

get(HTML view)

Declaration

```
string get (DBE HTMLView)
```

Operation

Returns the URL currently displayed in the given *HTMLView*, if there is one.

get(HTML frame)

Declaration

```
Buffer get (DBE HTMLView, string ID)
```

Operation

Returns the URL for the currently displayed frame as identified by its *ID*.

set(HTML view)

Declaration

```
string set (DBE HTMLView, Buffer HTML)
```

Operation

Sets the HTML fragment to be rendered inside the <body> tags by the HTML view control directly. This allows the controls HTML to be constructed dynamically and directly rendered.

setHTML

Declaration

```
string setHTML (DBE HTMLView, string ID, Buffer HTML)
```

Operation

Sets the HTML fragment to be rendered inside the <body> tags by the HTML view controls frame as identified by *ID*. This allows the HTML of the given document or frame to be constructed dynamically and directly rendered.

Note: The contents of the frame being modified must be in the same domain as the parent HTML document to be modifiable. A DXL error will be given on failure (for example, if the wrong type of DBE is supplied).

getHTML

Declaration

```
Buffer getHTML (DBE HTMLView, string ID)
```

Operation

Returns the currently rendered HTML fragment inside the <body> tags of the document or frame as identified by its *ID*.

getBuffer

Declaration

```
Buffer getBuffer (DBE HTMLView)
```

Operation

Returns the currently rendered HTML.

getInnerText

Declaration

```
string getInnerText (DBE HTMLView, string ID)
```

Operation

Returns the text between the start and end tags of the first object with the specified *ID*.

setInnerText

Declaration

```
void setInnerText (DBE HTMLView, string ID, string text)
```

Operation

Sets the text between the start and end tags of the first object with the specified *ID*.

getInnerHTML

Declaration

```
string getInnerHTML (DBE HTMLView, string ID)
```

Operation

Returns the HTML between the start and end tags of the first object with the specified *ID*.

setInnerHTML

Declaration

```
void setInnerHTML (DBE HTMLView, string ID, string html)
```

Operation

Sets the HTML between the start and end tags of the first object with the specified *ID*.

Note: The innerHTML property is read-only on the col, colGroup, framSet, html, head, style, table, tBody, tFoot, tHead, title, and tr objects.

Example

```
DB dlg
DBE htmlCtrl
DBE htmlBtn
DBE html

void onTabSelect(DBE whichTab){
    int selection = get whichTab
}

void onSetHTML(DBE button){
    Buffer b = create
    string s = get(htmlCtrl)
    print s
    b = s
    set(html, b)
    delete b
}

void onGetInnerText(DBE button){
    string s = getInnerText(html, "Text")
    confirm(s)
}

void onGetInnerHTML(DBE button){
    string s = getInnerHTML(html, "Text")
    confirm(s)
}

void onGetAttribute(DBE button){
    string s = getAttribute(html, "Text", "Align")
```

```
        confirm(s)
    }

void onSetInnerText(DBE button) {
    Buffer b = create
    string s = get(htmlCtrl)
    setInnerText(html, "Text", s)
}

void onSetInnerHTML(DBE button) {
    Buffer b = create
    string s = get(htmlCtrl)
    setInnerHTML(html, "Text", s)
}

void onSetAttribute(DBE button) {
    Buffer b = create
    string s = getAttribute(html, "Text", "Align")
    if (s == "left"){
        s = "center"
    }
    else if (s == "center"){
        s = "right"
    }
    else if (s == "right"){
        s = "left"
    }

    setAttribute(html, "Text", "align", s)
}

bool onHTMLBeforeNavigate(DBE dbe, string URL, string frame, string body){
    string buttons[] = {"OK"}
```

```

        string message = "Before navigate - URL: " URL "\r\nFrame: " frame
"\r\nPostData: " body "\r\n"
        print message ""
        return true
    }

void onHTMLDocComplete(DBE dbe, string URL){
    string buttons[] = {"OK"}
    string message = "Document complete - URL: " URL "\r\n"
    print message ""
    string s = get(dbe)
    print "url: " s "\r\n"
}

bool onHTMLLError(DBE dbe, string URL, string frame, int error){
    string buttons[] = {"OK"}
    string message = "Navigate error - URL: " URL "; Frame: " frame "; Error: "
error "\r\n"
    print message ""
    return true
}

void onHTMLProgress(DBE dbe, int percentage){
    string buttons[] = {"OK"}
    string message = "Percentage complete: " percentage "%\r\n"
    print message
    return true
}

dlg = create("Test", styleCentered | styleThemed | styleAutoparent)
htmlCtrl = text(dlg, "Field:", "<html><body>\r\n<p id=\"Text\"
align=\"center\">Welcome to <b>DOORS <i>ERS</i></b></p>\r\n</body></html>",
200, false)
htmlBtn = button(dlg, "Set HTML...", onSetHTML)
DBE getInnerTextBtn = button(dlg, "Get Inner Text...", onGetInnerText)

```

```

DBE getInnerHTMLBtn = button(dlg, "Get Inner HTML...", onGetInnerHTML)
DBE getAttributeBtn = button(dlg, "Get Attribute...", onGetAttribute)
DBE setInnerTextBtn = button(dlg, "Set Inner Text...", onSetInnerText)
DBE setInnerHTMLBtn = button(dlg, "Set Inner HTML...", onSetInnerHTML)
DBE setAttributeBtn = button(dlg, "Set Attribute...", onSetAttribute)

```

```

DBE frameCtrl = frame(dlg, "A Frame", 800, 500)

```

```

string strTabLabels[] = {"One", "Two"}
DBE tab = tab(dlg, strTabLabels, 800, 500, onTabSelect)

```

```

htmlCtrl->"top"->"form"
htmlCtrl->"left"->"form"
htmlCtrl->"right"->"unattached"
htmlCtrl->"bottom"->"unattached"

```

```

htmlBtn->"top"->"spaced"->htmlCtrl
htmlBtn->"left"->"form"
htmlBtn->"right"->"unattached"
htmlBtn->"bottom"->"unattached"

```

```

getInnerTextBtn->"top"->"spaced"->htmlCtrl
getInnerTextBtn->"left"->"spaced"->htmlBtn
getInnerTextBtn->"right"->"unattached"
getInnerTextBtn->"bottom"->"unattached"

```

```

getInnerHTMLBtn->"top"->"spaced"->htmlCtrl
getInnerHTMLBtn->"left"->"spaced"->getInnerTextBtn
getInnerHTMLBtn->"right"->"unattached"
getInnerHTMLBtn->"bottom"->"unattached"

```

```

getAttributeBtn->"top"->"spaced"->htmlCtrl
getAttributeBtn->"left"->"spaced"->getInnerHTMLBtn
getAttributeBtn->"right"->"unattached"

```

```
getAttributeBtn->"bottom"->"unattached"
```

```
setInnerTextBtn->"top"->"spaced"->htmlBtn
setInnerTextBtn->"left"->"aligned"->getInnerTextBtn
setInnerTextBtn->"right"->"unattached"
setInnerTextBtn->"bottom"->"unattached"
```

```
setInnerHTMLBtn->"top"->"spaced"->htmlBtn
setInnerHTMLBtn->"left"->"spaced"->setInnerTextBtn
setInnerHTMLBtn->"right"->"unattached"
setInnerHTMLBtn->"bottom"->"unattached"
```

```
setAttributeBtn->"top"->"spaced"->htmlBtn
setAttributeBtn->"left"->"spaced"->setInnerHTMLBtn
setAttributeBtn->"right"->"unattached"
setAttributeBtn->"bottom"->"unattached"
```

```
frameCtrl->"top"->"spaced"->setInnerTextBtn
frameCtrl->"left"->"form"
frameCtrl->"right"->"form"
frameCtrl->"bottom"->"form"
```

```
tab->"top"->"inside"->frameCtrl
tab->"left"->"inside"->frameCtrl
tab->"right"->"inside"->frameCtrl
tab->"bottom"->"inside"->frameCtrl
```

```
html = htmlView(dlg, 800, 500, "http://news.bbc.co.uk", onHTMLBeforeNavigate,
onHTMLDocComplete, onHTMLError, onHTMLProgress)
```

```
html->"top"->"inside"->tab
html->"left"->"inside"->tab
html->"right"->"inside"->tab
html->"bottom"->"inside"->tab
```

```
realize (dlg)
```

```
show (dlg)
```

HTML Edit Control

The section describes the DXL support for the HTML edit control added in DOORS 9.0.

The control behaves in many ways like a rich text area for entering formatted text. It encapsulates its own formatting toolbar allowing the user to apply styles and other formatting.

htmlEdit

Declaration

```
DBE htmlEdit (DB parentDB, string label, int width, int height)
```

Operation

Creates an HTML editor control inside *parentDB*.

htmlBuffer

Declaration

```
Buffer getBuffer (DBE editControl)
```

Operation

Returns the currently rendered HTML fragment shown in the control. The fragment includes everything inside the <body> element tag.

set (HTML edit)

Declaration

```
void set (DBE editControl, Buffer HTML)
```

Operation

Sets the HTML to be rendered by the edit control. The HTML fragment should include everything inside, but not including, the <body> element tag.

Example

```
DB MyDB = create "hello"
DBE MyHtml = htmlEdit(MyDB, "HTML Editor", 400, 100)

void mycb (DB dlg){

    Buffer b = getBuffer MyHtml
    string s = stringOf b
    ack s
}

apply (MyDB, "GetHTML", mycb)
set (MyHtml, "Initial Text")
show MyDB
```

Miscellaneous

delete (regexp)

Declaration

```
void delete (Regexp)
```

Operation

New in DOORS 9.0 this perm deletes the supplied regular expression and frees the memory used by it.

getTDSSOToken

Declaration

```
string getTDSSOToken (string& ssoToken)
```

Operation

Fetches a TDS single sign-on token for the current session user.

Returns null on success, or an error on failure.

getUrl (SSO)

Declaration

```
string getUrl ({database|Module|ModName_|ModuleVersion|Object|Folder| \\-  
              Project|Item} [, bool incSSOToken])
```

Operation

The new optional boolean parameter provides the ability to include the current session user single sign-on token in the URL.

backSlasher

Declaration

```
string backSlasher (string s)
```

Operation

Returns the provided string correctly backslashed and trimmed.

Chapter 4

New in DXL for DOORS 9.1

This chapter describes features that are new in DOORS 9.1:

- Regular Expressions

Regular Expressions

regexp2

Declaration

```
Regex regexp2(string expression)
```

Operation

Creates a regular expression. Its behavior will not be changed to match the legacy behavior of `regexp()`. Should be used in all new regular expression code.

Chapter 5

Fundamental types and functions

This chapter describes the functions and operators that can be used on the fundamental types of the core language underlying DXL:

- Operations on all types
- Operations on type `bool`
- Operations on type `char`
- Operations on type `int`
- Operations on type `real`
- Operations on type `string`

Operations on all types

The concatenation operator and the functions `print` and `null` can be used with all fundamental types.

Concatenation (base types)

The space character is the concatenation operator, which is shown as `<space>` in the following syntax:

```
bool b <space> string s
real r <space> string s
char c <space> string s
int i <space> string s
string s1 <space> string s2
```

For type	A space character
<code>bool</code>	Concatenates string <code>s</code> onto the evaluation of <code>b</code> (<code>true</code> or <code>false</code>), and returns the resulting string.
<code>real</code>	Concatenates string <code>s</code> onto real number <code>r</code> , and returns the resulting string.
<code>char</code>	Concatenates the string <code>s</code> onto the character <code>c</code> and returns the result as a string.
<code>int</code>	Concatenates the string <code>s</code> onto the integer <code>c</code> and returns the result as a string.
<code>string</code>	Concatenates string <code>s2</code> onto string <code>s1</code> and returns the result as a string.

Concatenation must be used when printing derived types. An example of a derived type is `o.` "Object text", where `o` is an object. If a string is not concatenated to the end of the print statement, a DXL error will occur, in this case.

Example

```
print "square root of 2 is " (sqrt 2.0) "\n"
char nl = '\n'
print "line one" nl "line two"
print (getenv "DOORSHOME") "/lib/dx1"
print o."Object text" ""
```

print (base types)

Declaration

```
void print(bool x)
void print(real r)
void print(char c)
void print(int i)
void print(string s)
```

Operation

For type	Prints
<code>bool</code>	The string <code>true</code> in the DXL output window if <code>x</code> is <code>true</code> ; otherwise prints <code>false</code> .
<code>real</code>	The passed real number <code>r</code> in the DXL output window, using a precision of 6 digits after the radix character.
<code>char</code>	The character <code>c</code> in the DXL output window.
<code>int</code>	Integer <code>i</code> in the DXL output window, with a trailing newline.
<code>string</code>	The string <code>s</code> in the DXL output window without a trailing newline.

Example

```
print (2.2 * 2.2) // prints 4.840000
print 'a'
print "Hello world\n"
```

null

The `null` function either returns the null value for the type, or tests whether a variable has the null value for its type.

Declaration

```
type null()
bool null(type x)
```

Operation

The first form returns the following values depending on the value of *type*:

Type	Return value
bool	false
char	character of ASCII code 0
int	0
real	0.000000
string	a null string ("")

The second form returns `true` if *x* has a null value as follows:

Type	Null value
bool	false or null
char	null
int	0 or null
real	Any 0 value with any number of decimal places or null
string	"" or null

You can use the value `null` to assign a null value to any type, including type `bool` and `char`.

Example

```
string empty = null
print null empty // prints true
```

Operations on type bool

Just as C++ has introduced a separate type `bool` (for boolean), so has DXL.

See also “Concatenation (base types),” on page 57, the `print` function, and the `null` function.

Type bool constants

The following constants are declared:

```
const bool true
const bool on
const bool false
const bool off
```

The boolean value `true` is equivalent to `on`; the value `false` is equivalent to `off`.

Note: For boolean values you cannot use 1 and 0.

Boolean operators

The operators `&&`, `||`, and `!` perform logical AND, OR, and NOT operations, as shown in the following syntax:

```
bool x && bool y
bool x || bool y
!bool x
```

These operators use lazy evaluation.

The `&&` operator returns `true` only if `x` and `y` are both `true`; otherwise, it returns `false`. If `x` is `false`, it does not evaluate `y`.

The `||` operator returns `true` if `x` or `y` is `true`; otherwise, it returns `false`. If `x` is `true`, it does not evaluate `y`.

The `!` operator returns the negation of `x`.

Type bool comparison

Type `bool` relational operators can be used as shown in the following syntax:

```
bool x == bool y
bool x != bool y
```

The `==` operator returns `true` only if `x` and `y` are equal; otherwise, it returns `false`.

The `!=` operator returns `true` only if `x` and `y` are not equal; otherwise, it returns `false`.

Operations on type char

See also “Concatenation (base types),” on page 57, the `print` function, and the `null` function.

Character comparison

Character relational operators can be used as shown in the following syntax:

```
char ch1 == char ch2
char ch1 != char ch2
char ch1 < char ch2
char ch1 > char ch2
char ch1 <= char ch2
char ch1 >= char ch2
```

These operators return `true` if *ch1* is equal, not equal, less than, greater than, less than or equal to, or greater than or equal to *ch2*.

Character extraction from string

The index notation, [], can be used to extract a single character from a string, as shown in the following syntax:

```
string text[int n]
```

This returns the *n*th character of string *text*, counting from 0.

Example

This example prints h in the DXL Interaction window's output pane:

```
string s = "hello"
char c = s[0]
print c
```

Character classes

The set of functions whose names start with `is` can be used to check whether a character belongs to a specific class.

Declaration

```
bool isalpha(char ch)
bool isupper(char ch)
bool islower(char ch)
bool isdigit(char ch)
bool isxdigit(char ch)
bool isalnum(char ch)
bool isspace(char ch)
```

```
bool ispunct(char ch)
bool isprint(char ch)
bool iscntrl(char ch)
bool isascii(char ch)
bool isgraph(char ch)
```

Operation

These functions return `true` if the character `ch` is in the named character class:

Class	Description
<code>alpha</code>	'a' - 'z' 'A' - 'Z'
<code>upper</code>	'A' - 'Z'
<code>lower</code>	'a' - 'z'
<code>digit</code>	'0' - '9'
<code>xdigit</code>	'0' - '9' 'a' - 'f' 'A' - 'F'
<code>alnum</code>	'a' - 'z' 'A' - 'Z' '0' - '9'
<code>space</code>	' ' '\t' '\n' '\m' '\j' '\k'
<code>punct</code>	any character except <space> and alpha numeric characters
<code>print</code>	a printing character
<code>cntrl</code>	any character code between 0 and 31, and code 127
<code>ascii</code>	any character code between 0 and 127
<code>graph</code>	any visible character

Example

```
print isalpha 'x' // prints true
print isalpha ' ' // prints false
```

charOf

Declaration

```
char charOf(int asciiCode)
```

Operation

Returns the character whose ASCII code is *asciiCode*.

Example

```
const char nl = charOf 10
```

intOf (char)

Declaration

```
int (char ch)
```

Operation

Returns the ASCII code of character *ch*.

Example

```
print intOf 'a' // prints 97
```

Operations on type int

A type `int` value in DXL has at least 32 bits.

See also “Concatenation (base types),” on page 57, the `print` function, and the `null` function.

Arithmetic operators (int)

Arithmetic operators can be used as shown in the following syntax:

```
int x + int y
```

```
int x - int y
```

```
int x * int y
```

```
int x / int y
```

```
int x % int y
```

```
int x | int y
```

```
int x & int y
```

```
~int x
```

```
-int x
```

These operators perform integer arithmetic operations for addition, subtraction, multiplication, division, remainder, bitwise OR, bitwise AND, bitwise NOT, and negation.

Assignment (int)

Assignment operators can be used as shown in the following syntax:

```
int x = int y
int x += int y
int x -= int y
int x *= int y
int x /= int y
int x %= int y
int x |= int y
int x &= int y
```

These operators assign integer values to variables of type `int` assignment. The last seven variations combine an arithmetic operation with the assignment.

Example

```
int y = 20
y *= 3
print y      // print 60
y /= 7
print y      // print 8
y %= 3
print y      // print 2
```

Unary operators

Unary operators can be used to increment or decrement variables before or after their values are accessed, as shown in the following syntax:

```
int x++
int x--
int ++x
int --x
```

The first two operators return the value of the variable before incrementing or decrementing a variable. The second two return the value after incrementing or decrementing a variable.

Note: You can overload these operators.

Example

```
int i = 40
print ++i      // prints 41
print i++     // prints 41
print i       // prints 42
```

Minimum and maximum operators

Two operators can be used to obtain the minimum or maximum value from a pair of integers, as shown in the following syntax:

```
int x <? int y
int x >? int y
```

These operators return the minimum or maximum of integers *x* and *y*.

Example

```
print (3 <? 2)    // prints 2
print (3 >? 2)    // prints 3
```

Integer comparison

Integer relational operators can be used as shown in the following syntax:

```
int x == int y
int x != int y
int x < int y
int x > int y
int x <= int y
int x >= int y
```

These operators return `true` if *x* is equal, not equal, less than, greater than, less than or equal to, or greater than or equal to *y*.

Example

```
print (2 != 3) // prints true
```

isValidInt

Declaration

```
bool isValidInt(string value)
```

Operation

Returns `true` if *value* is a valid integer; otherwise, returns `false`. The value passed must not be just spaces, e.g. `" "`. If a null string is passed, a DXL run-time error occurs.

random (int)

Declaration

```
int random(int max)
```

Operation

Returns a random integer value *x* such that $0 \leq x < max$

Example

```
print random 100 // prints an integer in the range 0 to 99
```

Operations on type real

A type `real` value in DXL is like a type `double` in C, with a precision of 64 bits.

See also “Concatenation (base types),” on page 57, the `print` function, and the `null` function.

Type real pi

The only constant of type `real` that is declared in DXL is `pi`:

```
const real pi
```

This supplies a constant value of 3.141593.

Arithmetic operators (real)

Arithmetic operators can be used as shown in the following syntax:

```
real x + real y
```

```
real x - real y
```

```
real x * real y
```

```
real x / real y
```

```
real x ^ real y
```

```
-real x
```

Operation

These operators perform arithmetic operations on type `real` variables for addition, subtraction, multiplication, division, exponentiation, and negation.

Example

```
print (2.2 + 3.3)      // prints 5.500000
```

Assignment (real)

Assignment operators can be used as shown in the following syntax:

```
real x = real y
real x += real y
real x -= real y
real x *= real y
real x /= real y
```

These operators perform type `real` assignment. The last four variations combine an arithmetic operation with the assignment.

Example

```
real x = 1.1
print (x += 2.0)      // prints 3.1
```

After the `print` statement, the variable `x` is assigned the value `3.1`.

Convert to real

The assignment operator `=` can be used to convert an integer to a real number, as shown in the following syntax:

```
real r = int i
```

Operation

Converts `i` into a type `real`, assigns it to the type `real` variable `r`, and returns this value.

Example

```
real r = 5
print r              // prints 5.000000
```

Type real comparison

Type `real` relational operators can be used as shown in the following syntax:

```
real x == real y
```

```

real x != real y
real x < real y
real x > real y
real x <= real y
real x >= real y

```

These operators return `true` if `x` is equal, not equal, less than, greater than, less than or equal to, or greater than or equal to `y`.

Example

```
print (2.2 < 4.0)      // prints true
```

intOf (real)

Declaration

```
int intOf(real r)
```

Operation

Rounds `r` of type `real` to the nearest integer.

Example

```
print intOf 3.2      // prints 3
```

realOf

Declaration

```
real realOf(int i)
real realOf(string s)
```

Operation

Converts type `int` `i` or type `string` `s` into a type `real` value, and returns it.

Example

```

print realOf 4          // prints 4.000000
real x = realOf "3.2"
print x                 // prints 3.200000

```

cos

Declaration

```
real cos(real angle)
```

Operation

Returns the cosine of *angle* in radians.

sin

Declaration

```
real sin(real angle)
```

Operation

Returns the sine of *angle* in radians.

tan

Declaration

```
real tan(real angle)
```

Operation

Returns the tangent of *angle* in radians.

exp

Declaration

```
real exp(real x)
```

Operation

Returns the natural exponent of type real *x*.

log

Declaration

```
real log(real x)
```

Operation

Returns the natural logarithm of type real *x*.

pow

Declaration

```
real pow(real x,  
         real y)
```

Operation

Returns type `real` `x` raised to the power `y` (same as x^y).

sqrt

Declaration

```
real sqrt(real x)
```

Operation

Returns the square root of `x`.

random (real)

Declaration

```
real random()
```

Operation

Returns a random value `x`, such that $0 \leq x < 1$.

Operations on type string

A DXL type `string` can contain any number of characters.

See also “Concatenation (base types),” on page 57, the `print` function, and the `null` function.

String comparison

String relational operators can be used as shown in the following syntax:

```
string s1 == string s2
```

```
string s1 != string s2
```

```
string s1 < string s2
```

```
string s1 > string s2
string s1 <= string s2
string s1 >= string s2
```

These operators return `true` if `s1` is equal, not equal, less than, greater than, less than or equal to, or greater than or equal to `s2`. Case is significant.

Example

```
print ("aaaa" < "a"      ) // prints "false"
print ("aaaa" > "a"      ) // prints "true"
print ("aaaa" == "a"     ) // prints "false"
print ("A" > "a"         ) // prints "false"
print ("McDonald" < "Man" ) // prints "false"
```

Substring extraction from string

The index notation, `[]`, can be used to extract a substring from a string, as shown in the following syntax:

```
string text[range]
```

Operation

Returns a substring of `text` as specified by `range`, which must be in the form `int:int`.

The `range` argument is specified as the indices of the first and last characters of the desired substring, counting from 0. If the substring continues to the end of the string, the second index can be omitted.

Example

```
string str = "I am a string constant"
print str[0:3] // prints "I am"
print str[2:3] // prints "am"
print str[5:]  // prints "a string constant"
```

cistrcmp

Declaration

```
int cistrcmp(string s1,
             string s2)
```

Operation

Compares strings `s1` and `s2` without regard to their case, and returns:

```
0      if      s1 == s2
```

```

1      if      s1 > s2
-1     if      s1 < s2

```

Example

```

print cistrncmp("aAa", "AaA") // prints 0
print cistrncmp("aAa", "aA")  // prints 1
print cistrncmp("aAa", "aAaa") // prints -1

```

length

Declaration

```
int length(string str)
```

Operation

Returns the length of the string *str*.

Example

```
print length "123" // prints 3
```

lower, upper

Declaration

```
string lower(string str)
string upper(string str)
```

Operation

Converts and returns the contents of *str* into lower or upper case.

Example

```

string mixed = "aaaBBBBcccc"
print lower mixed // prints "aaabbbbcccc"
print upper mixed // prints "AAABBBCCCC"

```

soundex

Declaration

```
string soundex(string str)
```

Operation

Returns the soundex code of the string *str*. Initial non-alphabetic characters of *str* are ignored.

Soundex codes are identical for similar-sounding English words.

Example

Both these examples print R265 in the DXL Interaction window's output pane.

```
print (soundex "requirements")
print (soundex "reekwirements")
```

backSlasher

Declaration

```
string backSlasher (string s)
```

Operation

Returns the provided string correctly backslashed and trimmed.

findPlainText

Declaration

```
bool findPlainText(string s, string sub, int &offset, int &length, bool
matchCase[, bool reverse])
```

Operation

Returns true if string *s* contains the substring *sub*.

Both *s* and *sub* are taken to be plain text string. Use *findRichText* to deal with strings containing RTF markup.

If *matchCase* is true, string *s* must contain string *sub* exactly with matching case; otherwise, any case matches.

The function returns additional information in *offset* and *length*. The value of *offset* is the number of characters in *s* to the start of the first match with string *sub*. The value of *length* contains the number of characters in the matching string.

If *reverse* is specified and is true, then the search is started at the end of the string, and the returned values of *offset* and *length* will reflect the last matching string in *s*.

Example

```
string s = "This shall be a requirement"
string sub = "shall"
```

```
int offset = null
int length = null
```

```
bool matchCase = true
bool reverse = true

if (findPlainText (s, sub, offset, length, matchCase, reverse)){
    print offset " : " length "" \\prints "5 : 5"
}
```

Chapter 6

General language facilities

This chapter describes basic functions and structures defined by DXL's run-time environment, as follows:

- Files and streams
- Configuration file access
- Dates
- Skip lists
- Regular expressions
- Text buffers
- Arrays

Files and streams

This section describes DXL's features for manipulating files. For information on creating a directory, see the `mkdir` function.

The main data type introduced is the `Stream`, which uses C++ like overloads of `>>` and `<<` to read and write files. Streams are not a fundamental type inherited from DXL's C origins, so the type name `Stream` begins with an upper case letter.

Standard streams

Declaration

```
Stream& cin
```

```
Stream& cout
```

```
Stream& cerr
```

Operation

Following C++'s naming scheme for UNIX standard streams, these variables are initialized by DOORS to standard input, output and error.

On UNIX platforms, you can use `cin` to read input that has been piped into DOORS, and `cout` to pipe data out from DOORS. Similarly, you can send user defined error messages (or any other desired output) to standard error using `cerr`.

Read from stream

The operator `>>` can be used to read strings or data from a configuration area stream, or fill a buffer, as shown in the following syntax:

```
file >> string s
```

```
file >> char c
```

```
file >> real r
```

```
file >> int i
```

```
file >> Buffer b
```

where:

file is a file of type `Stream`

The first form reads a line of text from the configuration area stream *file* into string *s*, up to but not including any newline.

The next three forms read the data from the configuration area stream *file*, and return the result as a stream, to allow chained reads. Real and integer constants are expected to be the last items on a line, while characters, including newlines, are read one at a time up to and including the end of file.

The second form reads from the configuration area stream *file* into buffer *b* until it is full at its current size, or the end of the file is reached. Returns the configuration area stream. This function can read multiple lines.

Example

```
char    c
```

```
real    r
```

```
int     i
```

```
Stream input = read "data.dat"
```

```
input >> c >> r >> i
```

Read line from stream

Two operators can be used to read a single line from a stream to a buffer, as shown in the following syntax:

```
file -> Buffer b
```

```
file >= Buffer b
```

where:

file is a file of type `Stream`

Operation

The `->` operator reads a single line from the stream *file*, and copies it to the buffer, skipping any leading white space. If the line is empty besides white space, the buffer is emptied. Returns the stream.

The `>=` operator reads a single line from the stream *file*, and copies it to the buffer in its entirety. If the line is empty, the buffer is emptied. Returns the stream.

Write to stream

The operator `<<` can be used to write strings, single characters or buffers to a stream, as shown in the following syntax:

```
file << string s
```

```
file << char c
```

```
file << Buffer b
```

where:

file is a file of type Stream

Writes the string *s*, the character *c*, or the buffer *b* to the stream file. To write other data types to a stream, first convert them to a string by concatenating the empty string or a newline.

Example

```
Stream out = write tempFileName
```

```
out << 1.4 "\n"
```

```
Stream alpha = write tempFileName
```

```
alpha << 'a' << 'b' << 'c'
```

canOpenFile

Declaration

```
bool canOpenFile(string pathname,
                 bool forWrite)
```

Operation

Returns `true` when the file *pathname* can be opened; otherwise, returns `false`. If *forWrite* is set to `true`, the file is opened for write and the current contents of the file are cleared. If *forWrite* is set to `false` the file is opened read only and the existing contents are unchanged.

read, write, append (open file)

Declaration

```
Stream read(string filename)
```

```
Stream write(string filename)
```

```
Stream append(string filename)
```

Operation

Opens a file *filename* for reading, writing or appending, and returns a stream. File I/O operations only succeed if the user has permission to create or access the files specified.

To open a binary file, you must call the `binary` function after the `read`, `write` or `append`. The syntax is therefore:

```
read [binary] filename
write [binary] filename
append [binary] filename
```

You can use the `Stat DXL` functions to check whether the I/O functions in this section can succeed (see “user, size, mode,” on page 126).

Example

```
// ASCII file
Stream output = write tempFileName
// binary file
Stream image = read binary pictureFileName
```

close (stream)

Declaration

```
void close(Stream s)
```

Operation

Closes the stream *s*.

flush

Declaration

```
void flush(Stream s)
```

Operation

Flushes the output stream *s*. Character I/O can be buffered; this command forces any such buffers to be cleared.

readFile

Declaration

```
string readFile(string filename)
```

Operation

Returns the contents of the file *filename* as a string.

goodFileName

Declaration

```
string goodFileName(string filename)
```

Operation

Returns a legitimate file name of the passed file, *filename*, with respect to any restrictions imposed by the current platform. This will only apply to the filename up to the '.' character. The string after the '.' is ignored.

Example

This example prints the file name `Test_results` in the DXL output window:

```
print goodFileName "Test results"
```

tempFileName

Declaration

```
string tempFileName()
```

Operation

Returns a string, which is a legal file name on the current platform, and is not the name of an existing file. On UNIX platforms, returns a file name like `/tmp/DOORSaaouef`; on Windows platforms, returns a file name like `C:\TEMP\DP2`. This file can be used for temporary storage by DXL programs.

currentDirectory

Declaration

```
string currentDirectory()
```

Operation

Returns the path name of the current working directory.

copyFile

Declaration

```
string copyFile(string sourceFileName,  
               string destFileName)
```

Operation

Copies file *sourceFileName* to *destFileName*. If the operation succeeds, returns `null`; otherwise, returns an error message.

Example

```
copyFile("file1", "file2")
```

deleteFile

Declaration

```
string deleteFile(string filename)
```

Operation

Deletes the file named *filename*. If the operation succeeds, returns *null*; otherwise, returns an error message.

renameFile

Declaration

```
string renameFile(string old, string new)
```

Operation

Renames the file called *old* to *new*. If the operation succeeds, returns *null*; if it fails, returns an error message.

end (stream)

Declaration

```
bool end(Stream s)
```

Operation

Returns *true* if the stream has no more characters pending. The test should be made after a *read*, but before the read data is used:

Example

```
while (true) {
    input >> str          // read a line at a time;
                        // var set up
    if (end input) break // test after read but
                        // before
    print str "\n"       // variable str is used
}
```

format

Declaration

```
void format(Stream s, string text, int width)
```

Operation

Outputs string *text* to Stream *s*, formatting each word of the text with a ragged right margin in a column of *width* characters. If a word is too long for the specified column, it is continued on the next line.

Example

```
Stream out = write tempFileName
format(out, "DXL Reference Manual", 5)
close out
```

This generates the following in the temporary file:

```
DXL
Refer
ence
Manua
l
```

for file in directory

Syntax

```
for s in directory "pathname" do {
  ...
}
```

where:

<i>pathname</i>	is the path of the directory
<i>s</i>	is a string variable

Operation

Sets the string *s* to be each successive file name found in the directory *pathname*.

Example

This example prints a list of the files in directory C:\:

```
string x = "c:\\\"
string file
```

```

for file in directory x do {
    print file "\n"
}

```

Files and streams example program

This example creates a temporary file, writes some data to it, saves it, renames it, reads from the new file, and then deletes it:

```

// file (Stream) DXL example
/*
  example file I/O program
*/
string filename = tempFileName // get a scratch
                               // file

print "Writing to " filename "\n"
Stream out = write filename
out << 'x' "" // write a char (via a string)
out << 1.001 "\n" // a real (must be last
                // thing on line)
out << 42 "\n" // an int (has to be last thing on line)
out << "hello world\na second line\n"
// a string
close out // write a file to read back in again
string oldName = filename
filename = tempFileName // get a new file name
renameFile(oldName, filename) // move the file we wrote earlier
print "Reading from " filename "\n"
Stream input = read filename
char c // declare some variable
real r
int i
input >> c
input >> r
input >> i
print c " " r " " i "\n" // check data type read/writes
string str // do rest line by line

```

```

while (true) {
    input >> str          // read a line at a
                        // time

    if (end of input) break
    print str "\n"      // str does not
                        // include the newline
}

print readFile filename // read the whole lot
                        // into a string

close input

deleteFile filename    // delete the file

```

Configuration file access

This section describes the DXL features for manipulating configuration files. The data types used are `ConfType` and `ConfStream`. Many of these functions have a parameter `ConfType area`. The arguments that can be passed as `ConfType area` are as follows:

- `confUser`
- `confSysUser`
- `confSystem`
- `confTemp`

The `confUser` argument means the file is situated in an area specific to the current DOORS user, or to the current system user if a project is not open.

The `confSysUser` argument means the file is situated in the configuration area for system users. This argument remains constant regardless of whether the user is logged into the project. For example, the DOORS Tip Wizard uses a `confSysUser` file to store whether a user has opted to show Tips on startup.

The `confSystem` argument means the file is situated in a shared area accessible by all users. For example, DOORSnet stores its setup information in a file in this area, as it is common to all users.

The `confTemp` argument is similar to `confSystem`, but is generally used for storing temporary files.

If the function does not supply an `area` argument, `confUser` is used.

Read from stream

The operator `>>` can be used to read strings or data from a configuration area stream, or fill a buffer, as shown in the following syntax:

```
file >> string s
```

```
file >> Buffer b
```

where:

file is a file of type `ConfStream`

The first form reads a line of text from the configuration area stream *file* into string *s*, up to but not including any newline.

The second form reads from the configuration area stream *file* into buffer *b* until it is full at its current size, or the end of the file is reached. Returns the configuration area stream. This function can read multiple lines.

Read line from stream

Two operators can be used to read a single line from a configuration stream to a buffer, as shown in the following syntax:

```
file -> Buffer b
```

```
file >= Buffer b
```

where:

file is a file of type `ConfStream`

Operation

The `->` operator reads a single line from the configuration area stream *file*, and copies it to the buffer, skipping any leading white space. If the line is empty besides white space, the buffer is emptied. Returns the stream.

The `>=` operator reads a single line from the configuration area stream *file*, and copies it to the buffer in its entirety. If the line is empty, the buffer is emptied. Returns the stream.

Write to stream

The operator `<<` can be used to write strings, single characters or buffers to a stream, as shown in the following syntax:

```
file << string s
```

```
file << char c
```

```
file << Buffer b
```

where:

file is a file of type `ConfStream`

Writes the string *s*, the character *c*, or the buffer *b* to the configuration area stream *file*. To write other data types to a configuration area stream, first convert them to a string by concatenating the empty string or a newline.

Example

```
ConfStream out = write tempFileName
```

```
out << 1.4 "\n"
```

```
ConfStream alpha = write tempFileName
```

```
alpha << 'a' << 'b' << 'c'
```

confMkdir

Declaration

```
void confMkdir(string dirName
               [,ConfType area])
```

Operation

Creates the directory, *dirName*, in either the default or the specified configuration area, *area*.

confDeleteDirectory

Declaration

```
string confDeleteDirectory(string pathname, ConfType conf)
```

Operation

Deletes the named directory in the specified *ConfType* area (*confSystem* or *confUser*). On success it returns null; on failure it returns an error string.

confRead

Declaration

```
ConfStream confRead(string fileName
                    [,ConfType area])
```

Operation

Opens the specified file for reading, and returns the file handle. The file can be in either the default or the specified configuration area.

Detects the encoding of conf files by checking for the presence of a UTF8 Byte Order Marker (BOM) at the start of the file. If it finds one, it assumes that the file is UTF8-encoded. Otherwise, it assumes that the file is encoded according to the legacy codepage for the database. In either case, any values subsequently read from the file using the ConfStream >> operator or others are converted to Unicode, so the encoding of the file should not affect the functionality of any DXL scripts that use this perm.

confWrite

Declaration

```
ConfStream confWrite(string fileName
                     [,ConfType area])
```

Operation

Opens the specified file for writing, and returns the file handle. The file can be in either the default or the specified configuration area.

Any conf files created by this perm are UTF8-encoded, allowing them to contain any Unicode strings.

confAppend

Declaration

```
ConfStream confAppend(string fileName
                      [,ConfType area])
```

Operation

Opens the specified file for appending, and returns the file handle. The file can be in either the default or the specified configuration area.

This perm converts any non-UTF8 files to UTF8 encoding before opening them for append. This enables any Unicode strings to be written to the file using the ConfStream << write operators.

confRenameFile

Declaration

```
string confRenameFile(string old,
                      string new
                      [,ConfType area])
```

Operation

Renames the file *old* to *new* in either the default or the specified configuration area.

Returns an error message string if the operation fails.

confCopyFile

Declaration

```
string confCopyFile(string source,
                    string dest,
                    ConfType area)
```

Operation

Copies *source* to *dest* in the specified configuration area. If the operation fails, it returns an error message.

confDeleteFile

Declaration

```
string confDeleteFile(string fileName
                      [,ConfType area])
```

Operation

Deletes the specified file in either the default or the specified configuration area. If the operation fails, it returns an error message.

confFileExists

Declaration

```
bool confFileExists(string fileName
                    [,ConfType area])
```

Operation

Returns `true` if the specified file exists in either the default or the specified configuration area; otherwise, returns `false`.

close (configuration area stream)

Declaration

```
void close(ConfStream s)
```

Operation

Closes the configuration area stream *s*.

end (configuration area stream)

Declaration

```
bool end(ConfStream s)
```

Operation

Returns `true` if the stream has no more characters pending. The test should be made after a `read`, but before the read data is used:

Example

```
while (true) {
    input >> str          // read a line at a time;
                        // var set up
    if (end input) break // test after read but
                        // before
    print str "\n"      // variable str is used
}
```

for file in configuration area

Syntax

```
for s in confDirectory("dirname"[,area]) do {
    ...
}
```

where:

<i>dirname</i>	is the name of the directory in <i>area</i> , or if <i>area</i> is omitted, in <code>confUser</code>
<i>area</i>	is a constant of type <code>ConfType</code> : <code>confUser</code> , <code>confSysUser</code> , <code>confSystem</code> , <code>confTemp</code> , or <code>confProjUser</code>
<i>s</i>	is a string variable

Operation

Sets the string *s* to be each successive file name found in the directory *pathname*.

Example

This example prints a list of the files in directory `test` in `confUser`:

```
string file
for file in confDirectory("test") do {
    print file "\n"
}
```

confUploadFile(source, dest [, conftype])

Declaration

```
string confUploadFile(string source, string dest [, conftype])
```

Operation

Uploads a file from the location on the client machine specified by *source*, to the file in the system conf area on the database server, specified by *dest*. It returns null on success. If the *dest* string contains double-periods "." or specifies an invalid directory, then the perm reports an error and returns null. Otherwise, if the upload fails, the perm returns an error message.

The optional 3rd argument specifies the config area where the file should be sent. This defaults to the current user's config area (confUser). Files to be accessible to all users should be uploaded to the system config area, by specifying this argument as "confSystem".

Example

```
string message = confUploadFile("C:\\temp\\myprog.exe", "myprog", confSystem)
if (!null message)
{
    warningBox(message)
}
```

confDownloadFile(source, dest [, conftype])

Declaration

```
string confDownloadFile(string source, string dest [, conftype])
```

Operation

Downloads a file from the location in the conf area on the database server, specified by *dest*, to the location on the client machine specified by *source*. It returns null on success. If the source string contains double-periods "." then the perm reports an error and returns null. Otherwise, if the download fails, the perm returns an error message.

The optional 3rd argument specifies the config area from which the file should be copied. This defaults to the current user's config area (confUser).

Example

```
string message = confDownloadFile("myprog", "C:\\temp\\myprog2.exe", confSystem)
if (!null message)
{
    warningBox(message)
}
```

Dates

This section describes DXL's features for manipulating dates.

Dates are not a fundamental type inherited from DXL's C origins, so the type name `Date` begins with an upper case letter.

DXL `Date` data limits are from 1 Jan 1970, to 31 Dec 2102.

Concatenation (dates)

The space character is the concatenation operator, which is shown as `<space>` in the following syntax:

```
Date d <space> string s
```

Concatenates string `s` onto date `d` and returns the result as a string. It uses the long format date, or, if any operations dealing in seconds have occurred, the short format date with time added.

Example

This example prints `<01 January 1999>`:

```
Date d = "1 Jan 99"
print "<d">
```

Assignment (date)

The assignment operator `=` can be used as shown in the following syntax:

```
Date d = string datestr
```

Converts the string `datestr` into a date, assigns it to `d`, and returns it as a result. Issues an error message if `datestr` is not in a valid date format. Ordinal numbers, for example 4th, are not recognized. Apart from that limitation, all date formats are valid, for example:

```
yyyy, dd mmm
```

```
dd/mm/yy
```

```
mm/dd/yy
```

Time can be appended to a dates using the format `hh:mm:ss.ss`, provided the date is in the format `dd/mm/yy` or `mm/dd/yy`.

Example

This example prints `04 October 1961`:

```
Date d1 = "4 Oct 1961"
print d1
```

Date comparison

Date relational operators can be used as shown in the following syntax:

```
Date d1 == Date d2
```

```
Date d1 != Date d2
```

```
Date d1 < Date d2
```

```
Date d1 > Date d2
```

```
Date d1 <= Date d2
```

```
Date d1 >= Date d2
```

These operators return `true` if *d1* is equal, not equal, less than, greater than, less than or equal to, greater than or equal to *d2*.

Example

This example prints `false` in the DXL Interaction window's output pane:

```
Date d1 = "4 Oct 1961"
```

```
Date d2 = "10 Nov 1972"
```

```
print (d1 > d2)
```

print (date)

Declaration

```
void print(Date d)
```

Operation

Prints the date *d* in the DXL output window in long format, or, if any operations dealing in seconds have occurred, the short format date with time added.

Example

This example prints `04 October 1961`:

```
Date d1 = "4 Oct 1961"
```

```
print d1
```

today

Declaration

```
Date today()
```

Operation

Returns today's date. The value includes the exact time, but it is not printed using:

```
print today
```

The function call:

```
intOf today
```

returns the integer number of seconds since 1 Jan 1970, 00:00:00 GMT.

Example

This example prints the current date and time:

```
print dateOf intOf today
```

Note: Concatenating strings to the end of this statement may give unexpected results.

session

Declaration

```
Date session()
```

Operation

Returns the date on which the current DOORS session began. The value includes the exact time in the same way as the `today` function.

Example

This example prints the date the current DOORS session started:

```
print session
```

intOf (date)

Declaration

```
int intOf(Date d)
```

Operation

Returns an integer corresponding to the number of seconds that have elapsed between the given date and 1 Jan 1970, 00:00:00 GMT.

When a `Date` data type is converted for dates on or after 1 Jan 2037, or before 1 Jan 1970, this function returns a result of -1.

Example

```
print intOf today
```

dateOf

Declaration

```
Date dateOf(int secs)
```

Operation

Returns the date and time that is calculated as *secs* seconds since 1 Jan 1970, 00:00:00 GMT.

Example

```
int minute    = 60
int hour      = 60 * minute
int day       = 24 * hour
int year      = 365 * day
int leapYear  = 366 * day
print dateOf ((year * 2) + leapYear)
```

This generates the following in the DXL Interaction window's output pane:

```
01/01/73 00:00:00
```

which is three years after 1 Jan 1970, 00:00:00 GMT, taking into account that 1972 was a leap year.

stringOf

Declaration

```
string stringOf (Date d[, Locale l][, string s] )
```

Operation

This returns the string representation of the date value using the specified locale and format. If no locale is specified, the current user locale is used. If no format string or a null format string is specified, then if the date value includes time (hours:minutes:seconds), the default short date format for the locale will be used. Otherwise, a long date format will be used. The default short date format will be either that specified by the user using `setDefaultFormat(Locale)`, or, if no default short date format has been set by the user for the locale, the system default format.

date

Declaration

```
Date date(string s[, Locale l][,string s])
```

Operation

This returns the date value represented by the supplied string, interpreted according to the specified locale and format. The default locale is the current user locale, and if no format string is supplied then the input string is parsed using first the user's default short date format (if one has been specified for the locale), and then all the supported formats for the locale.

for string in shortDateFormats

Declaration

```
for string in shortDateFormats([Locale l])
```

Operation

This iterator returns the short date formats supported for the specified locale. If no locale is specified, it returns the short date formats supported for the current user locale.

The first format returned is the default short date format for the locale.

for string in longDateFormats

Declaration

```
for string in longDateFormats([Locale l])
```

Operation

This iterator returns the long date formats supported for the specified locale. If no locale is specified, it returns the long date formats supported for the current user locale.

The first format returned is the default long date format for the locale.

includesTime

Declaration

```
bool includesTime(Date d)
```

Operation

This returns `true` if the specified date value includes time information as well as date.

dateOnly

Declaration

```
Date dateOnly(Date d)
```

Operation

Returns a copy of the supplied date value, without any included time-of-day information (i.e. it returns a date-only value).

dateAndTime

Declaration

```
Date dateAndTime(Date d)
```

Operation

Returns a copy of the supplied date value including time-of-day data.

Example

```
print today()
prints 6 June 2005
print dateAndTime(today)
prints 6/6/2005 13:42:34
```

Example

The following example uses the new locale specific date format perms.

```
// dates.dxl - dates and formats example
//*****
void testFormat(Date dateValue, Locale loc, string format)
// DESCRIPTION: Checks that the stringOf and dateOf perms are true
//              inverses for the specified format.
{
    print "    format " format ": " stringOf(dateValue, loc, format) "\n"
} // testFormat
//*****
void testDate(Date dateValue, Locale loc)
// Tests stringOf and dateOf using default formats, and all supported formats.
{
    // Test default format
    string stringForm = stringOf(dateValue, loc)
    print "Default format: " stringForm "\n"

    // Test all supported formats
    string format
    print "Short formats:\n"
```

```

    for format in shortDateFormats(loc) do
    {
        testFormat(dateValue, loc, format)
    }
print "Long formats:\n"
    for format in longDateFormats(loc) do
    {
        testFormat(dateValue, loc, format)
    }

// Test abbreviations.
print "Abbreviated names: " stringOf(dateValue, loc, "ddd, d MMM yy") "\n"
// Test all full names.
print "Full names: " stringOf(dateValue, loc, "dddd, d MMMM yyyy") "\n"

} // testDate
Locale loc = userLocale
print "\nLOCALE: " (name loc) "\n"
print "\nDATE ONLY:\n"
testDate(today,loc)
print "\nDATE AND TIME:\n"
testDate(dateAndTime(today),loc)

```

Skip lists

This section describes DXL's features for manipulating skip lists.

Skip lists are an efficient dictionary like data structure. Since DXL does not support a C like `struct` feature, many DXL programs use skip lists as the building blocks for creating complex data structures.

Because DXL provides no garbage collection, it is important to delete skip lists that are no longer required, thereby freeing allocated memory.

Skip lists are not a fundamental type inherited from DXL's C origins, so the type name `Skip` begins with an upper case letter.

create, createString (skip list)

Declaration

```
Skip create()
Skip createString()
```

Operation

Creates a new empty skip list and returns it.

It is very important, and it is the programmer's responsibility to ensure that data and keys are consistently used when storing and retrieving from a skip list. For example, you can cause program failure by inserting some data into a skip list as an integer, then retrieving the data into a string variable and attempting to print it.

The keys used with the skip list can be of any type. However, comparison of keys is based on the address of the key, not its contents. This is fine for elements that are always represented by a unique pointer, for example, objects, modules, or skip lists, but care is needed with strings. This is because a string may not have a unique address, depending on whether it is literal or a computed string stored in a variable.

There are two ways of avoiding this problem. The first is to use the `createString` form of the function for a skip list with a string key. The alternative is to ensure that all literal strings used as keys are concatenated with the empty string.

Example

```
Skip strKeys = create
put(strKeys, "literal" "", 1000)
```

delete (skip list)

Declaration

```
void delete(Skip s)
```

Operation

Deletes all of skip list *s*. Variables that have been given as keys or data are not affected.

delete (entry)

Declaration

```
bool delete(Skip s,
            type key)
```

Operation

Deletes an entry in skip list *s* according to the passed *key*, which can be of any type. Variables that have been given as keys or data are not affected. Returns *false* if the key does not exist.

Example

```
if (delete(numberCache, 1)) // delete absno 1
    ack "delete succeeded"
```

find (entry)

Declaration

```
bool find(Skip s,
          type1 key
          [,type2 &data])
```

Operation

Returns `true` if the passed `key`, of `type1`, has an entry in skip list `s`. The optional third argument sets the entry found to be `data` of `type2`. Both `type1` and `type2` can be any type.

Example

```
if (find(numberCache, 1, o)) {
    string h = o."Object Heading"
    ack h
}
```

key

The `key` function is used only within the skip list `for` loop, as shown in the following syntax:

```
(type key(Skip s))
```

Operation

Returns the key corresponding to the current element. The return value can be of any type, so a cast must precede the use of `key`.

Example

```
Object o
for o in numberCache do {
    // must cast the key command.
    int i = (int key numberCache)
    print i
}
```

put

Declaration

```
bool put(Skip s,
         type1 key,
         type2 data)
```

Operation

Returns `true` if the passed `key` and `data` are successfully inserted into the skip list `s`. Duplicate entries are not allowed, so the function returns `false` if an entry with the same `key` already exists. For this reason, an entry at an existing key must first be deleted before its data can be changed.

Example

```
Skip s = create
put(s, 1, 20)
print put(s, 1, 30)
// prints 'false'
delete(s, 1)
print put(s, 1, 30)
// prints 'true', s(1) is now 30
```

for data element in skip list

Syntax

```
for dataElement in skiplist do {
  ...
}
```

where:

<i>dataElement</i>	is a variable of any type
<i>skiplist</i>	is a variable of type <code>Skip</code>

Operation

Sets `entry` to be each successive `type` data element of `list`.

Example

```
Object o
```

```

for o in numberCache do {
    string h = o."Object Heading"
    print h "\n"
}

```

Skip lists example program

In this example a skip list is used to store a mapping from absolute numbers to the corresponding DOORS object:

```

// skip list example
/*
    simple skip list example: make a mapping
    from absolute numbers to objects, allowing
    fast lookup
*/
Skip numberCache = create // builds the skip list
Object o
int    n = 0              // count objects

for o in current Module do {
    // cycle through all objects

    int absno = o."Absolute Number"
    // get the number

    put(numberCache, absno, o)
    // number is key, object is data

    n++
}

// we now have a quick way of going from
// absolute numbers to objects:
if (n > 0) {
    int i

    for i in 1:20 do {
        int absno = 1 + random n
        // choose an absno at random

        if (find(numberCache, absno, o)) {
            // can we find it?
            string heading = o."Object Heading"

            print "#" absno " has
                heading \"\" heading "\"\n"

        }
    }
}

```



```
}// if
```

Regular expressions

This section describes DXL's features for using regular expressions.

Regular expressions are a mechanism for detecting patterns in text. They have many applications, including searching and simple parsing.

Regular expressions are not a fundamental type inherited from DXL's C origins, so the type name `Regexp` begins with an upper case letter.

The following symbols can be used in `Regexp` expressions:

	Meaning	Example	Matches
*	zero or more occurrences	a*	any number of a characters, or none
+	one or more occurrences	x+	one or more x characters
.	any single character except new line	.*	any number of any characters (any string)
\	escape (literal text char)	\.	literally a . (dot) character
^	start of the string (if at start of <code>Regexp</code>)	^The.*	any string starting with The or starting with The after any new line (see also [] below)
\$	end of the string (if at end of <code>Regexp</code>)	end\\. \$	any string ending with end .
()	Groupings	(ref) + (bind) *	at least one ref string then any number of bind strings
[]	character range (letters or digits)	[sS]hall. *\\. \$	any string containing shall or Shall and ending in a literal dot (any requirement sentence)
		[^abc]	any character except a , b , or c
		[a-zA-Z]	any alphabetic character
		[0-9]	any digit
	Alternative	(dat doc)	either the string dat or the string doc

Note: The regular expression escape character must itself be escaped in a DXL string. For example, to have the regular expression `\.`, you must have `\\.` in the DXL string.

Many of the functions for regular expressions use the data type `Regexp`.

Application of regular expressions

The space character is an operator that applies a regular expression to a string or buffer; it is shown as `<space>` in the following syntax:

```
Regexp reg <space> string text
```

```
Regexp reg <space> Buffer b
```

Operation

Returns `true` if there is a match.

Example

```
Regexp line = regexp ".*"
while (line txt1) {
    ...
}
```

match

The `match` function returns a range for a match of a regular expression within a string or buffer, as shown in the following syntax:

```
Regexp r = regexp "x(options1)y(options2)..."
```

```
{string|Buffer} str = "string"
```

```
str[match n]
```

where:

<i>r</i>	<i>str</i>	are variables
<i>x</i>	<i>y</i>	are literal characters in a regular expression
<i>options1</i>	<i>options2</i>	are regular expression matching options
<i>string</i>		is a string or buffer
<i>n</i>		is an integer

Operation

When $n=0$, returns the range of *string*. When $n=1$, returns the range of the match for *options1*; when $n=2$, returns the match for *options2*, and so on. The value for *n* is restricted to the range 0-9.

Example

This example detects and decomposes URLs:

```
Regexp URL = regexp "(HTTP|http|ftp|FTP|file|FILE)://([^\ \\\,; >\\"]*)"
string txt3 = "The ABC URL is http://www.abc.com; it may be..."
if (URL txt3) {
    print txt3[match 0] "\n"    // whole match
    print txt3[match 1] "\n"    // first section in ()
    print txt3[match 2] "\n"    // second section in ()
}
```

matches

Declaration

```
bool matches(string reg,
             string text)
```

Operation

Returns true if *text* matches *reg*. For repeated use, declaring and building a regular expression is more efficient.

Example

```
string txt = "xxxxyesuuuu"
if (matches("(yes|no)", txt)) print txt[match 0]
```

regexp

Declaration

```
Regexp regexp(string reg)
```

Operation

Returns a new regular expression, specified by string *reg*. For legacy support only, should not be used in new code. Replaced by `regexp2()`.

Example

```
// matches any line except newline
Regexp line = regexp ".*"
```

start, end (of match)

Declaration

```
int start(int n)
int end(int n)
```

Operation

Return the position of the first and last characters of the *n*th match from a call to *match*. The value for *n* is restricted to the range 0-9.

Example

```
int firstNameLen = end 1
```

delete (regexp)

Declaration

```
void delete (Regexp)
```

Operation

This perm deletes the supplied regular expression and frees the memory used by it.

regexp2

Declaration

```
Regexp regexp2(string expression)
```

Operation

Creates a regular expression. Its behavior will not be changed to match the legacy behavior of `regexp()`. Should be used in all new regular expression code.

Regular expressions example program

```
// regular expression DXL example
/*
  examples of regular expression DXL
*/
Regexp line = regexp ".*"
// matches any character except newline
string txt1 = "line 1\nline 2\nline 3\n"
// 3 line string
```

```

while (!null txt1 && line txt1) {
    print txt1[match 0] "\n"
    // match 0 is whole of match
    txt1 = txt1[end 0 + 2:] // move past newline
}

// The following regular expression detects and
// decomposes URLs
Regexp URL = regexp //"(HTTP|http|ftp|FTP|file|FILE):\/\/([^\ \\\,;>\""]*)"
string txt3 = "The ABC URL is http://www.abcinc.com, and may be..."

if (URL txt3) {
    print txt3[match 0] "\n" // whole match
    print txt3[match 1] "\n" // first bracketed
                          // section
    print txt3[match 2] "\n" // second.
    print start 1 // position 15 in
                  // txt3 (from 0)
    print end 1 // 18
    print start 2 // 22
    print end 2 // 34
}

```

Text buffers

The following functions allow the manipulation of DXL buffers. Buffers are a speed and memory efficient way of manipulating text within DXL applications. Their use is particularly encouraged in parsers and importers.

You should explicitly delete buffers with `delete` as soon as they are no longer needed in a script.

Buffers are not a fundamental type inherited from DXL's C origins, so the type name `Buffer` begins with an upper case letter.

Because DXL provides no garbage collection, it is important to delete buffers that are no longer required, thereby freeing allocated memory.

Assignment (buffer)

The assignment operator `=` can be used as shown in the following syntax:

```
Buffer b = string s
```

or

```
Buffer b = h.oldValue
```

Operation

The first form sets the contents of `buffer b` to that of the `string s`. You can use a range in the assignment.

The second form sets the contents of the `buffer` to the history property `oldValue`. The buffer should be deleted after use.

Note: If you want to assign a buffer to a buffer, you must use the form `Buffer b=stringOf(a)`, otherwise, the address of `a` is given to `b` instead of its value.

Append operator

The append operator `+=` can be used as shown in the following syntax:

```
Buffer b += string s
```

```
Buffer b += char c
```

```
Buffer b += Buffer b
```

Operation

Appends the string, character, or buffer to the buffer `b`.

Example

This example prints `one1twox` in the DXL Interaction window's output pane:

```
Buffer buf1 = create
Buffer buf2 = create
buf1 = "one"
buf2 = "two"
buf1 += "1"
buf1 += buf2
buf1 += 'x'
```

Concatenation (buffers)

The space character is the concatenation operator, which is shown as `<space>` in the following syntax:

```
Buffer b <space> string s
```

Concatenates string `s` onto the contents of buffer `b` and returns the result as a string. You can use a range in the concatenation.

Example

```
Buffer b = create
b = "aaa"
print b "zzz"           // prints "aaazzz"
```

Buffer comparison

String relational operators can be used as shown in the following syntax:

```
Buffer b1 == Buffer b2
Buffer b1 != Buffer b2
Buffer b1 < Buffer b2
Buffer b1 > Buffer b2
Buffer b1 <= Buffer b2
Buffer b1 >= Buffer b2
```

These operators return `true` if `b1` is equal, not equal, less than, greater than, less than or equal to, or greater than or equal to `b2`. Case is significant.

Example

```
Buffer b1 = create
Buffer b2 = create
b1 = "aaa"
b2 = "aza"
print (b1==b2) " " (b1!=b2) " " (b1<b2) " "
print (b1<b2) " " (b1<=b2) " " (b1>=b2) "\n"
// prints "false true true false true false"
```

Read and write operators

The `>>` operator can be used to read a stream into a buffer and return the stream (see “Read from stream,” on page 76).

The `<<` operator can be used to write a buffer to a stream and return the stream (see “Read line from stream,” on page 76).

The `->` and `>=` operators can be used to read a single line from a file to a buffer, (see “Write to stream,” on page 77).

Character extraction from buffer

The index notation, `[]`, can be used to extract a single character from a buffer, as shown in the following syntax:

```
Buffer b[int n]
```

This returns the n^{th} character of buffer `b`, counting from 0.

Example

This example prints `a` in the DXL Interaction window’s output pane:

```
Buffer b = "abc"
```

```
char c = b[0]
print c
```

Substring extraction from buffer

The index notation, [], can be used to extract a substring from a buffer, as shown in the following syntax:

```
Buffer b[range]
```

Operation

Returns a range of *b* as specified by *range*, which must be in the form `int:int`.

The *range* argument is specified as the indices of the first and last characters of the desired range, counting from 0. If the range continues to the end of the buffer, the second index can be omitted. This function returns a buffer or string depending on the type assigned.

Example

```
Buffer buf = create
buf = "abcdefg"
string s = buf[2:3]
print s           // prints cd
Buffer b = buf[4:5]
print b           // prints ef
```

combine

Declaration

```
void combine(Buffer b1,
             Buffer b2,
             int start
             [,int finish])
```

Operation

Concatenates a substring of *b2* onto the contents of *b1*. The substring is from *start* to *finish*, or if *finish* is omitted, from *start* to the end of the buffer. This function provides a performance advantage over the assignment to buffer using the range option.

Example

```
Buffer b1 = create, b2 = create
b1 = "zzz"
b2 = "abcdef"
combine(b1, b2, 3, 4)
```



```
print stringOf b1      // prints "zzzde"
```

contains

Declaration

```
int contains(Buffer b,
             char ch
             [,int offset])
```

```
int contains(Buffer b,
             string word,
             int offset)
```

Operation

The first form returns the index at which the character *ch* appears in buffer *b*, starting from 0. If present, the value of *offset* controls where the search starts. For example, if *offset* is 1, the search starts from 2. If *offset* is not present, the search starts from 0. If *ch* does not appear after *offset*, the function returns -1.

The second form returns the index at which string *word* appears in the buffer, starting from 0, provided the string is preceded by a non-alphanumeric character. The value of the mandatory *offset* argument controls where the search starts. If *word* does not appear after *offset*, the function returns -1.

getDOSstring

Declaration

```
Buffer getDOSstring(Buffer b)
```

Operation

Returns a copy of the supplied Buffer, with a carriage-return character inserted before any newline character that is not already preceded by a carriage return.

create (buffer)

Declaration

```
Buffer create([int initSize])
```

Operation

Creates a buffer. A buffer has no intrinsic limit on its size; when a buffer becomes full it extends itself, if memory permits. The argument *initSize* specifies the initial size of the buffer. If no initial size argument is passed, this function creates a buffer that uses a default initial size of 255.

delete (buffer)

Declaration

```
void delete(Buffer &b)
```

Operation

Deletes the buffer *b*, and sets the variable *b* to null.

firstNonSpace

Declaration

```
int firstNonSpace(Buffer b)
```

Operation

Returns the index of the first non-space character in buffer *b*, or -1 if there is none.

keyword (buffer)

Declaration

```
int keyword(Buffer b,  
            string word,  
            int offset)
```

Operation

Returns the index at which string *word* appears in buffer *b*, starting from character *offset*, provided that the string is neither preceded nor followed by a non-alphanumeric character. If *word* does not appear, the function returns -1.

This function is used to accelerate parsing of programming languages.

length (buffer get)

Declaration

```
int length(Buffer b)
```

Operation

Returns the length of the buffer.

length (buffer set)

Declaration

```
void length(Buffer b,  
            int len)
```

Operation

Sets the length of a buffer. This is normally used for truncating buffers, but can also be used to lengthen them.

The DXL program is responsible for the content of the buffer.

Example

```
Buffer buf = create  
buf = "abcd"  
length(buf,2)  
print "<" (stringOf buf) ">" // prints "ab"
```

set (char in buffer)

Declaration

```
void set(Buffer b,  
         int n,  
         char ch)
```

Operation

Sets the character at position *n* of buffer *b* to character *ch*.

Example

```
if (name[n] == '.') set(name, n, ';')
```

setempty

Declaration

```
void setempty(Buffer b)
```

Operation

Empties buffer *b*, but does not reclaim any space.

setupper, setlower

Declaration

```
void setupper(Buffer b)
void setlower(Buffer b)
```

Operation

These functions convert the case of buffer *b* to upper or lower case.

stringOf (buffer)

Declaration

```
string stringOf(Buffer b)
```

Operation

Returns the contents of buffer *b* as a string.

Example

```
Buffer b = create
b = "aaaa"
print stringOf b      // prints "aaaa"
```

Buffers and regular expressions

Regular expressions can be applied to buffers in the same way as strings (see “Application of regular expressions,” on page 102). The regular expression functions `start`, `end` (of `match`), and `match` can also be used with buffers.

Example

```
Buffer buf = create
buf = "aaaabbccccc"
Regexp re = regexp "a*"
re buf      // apply regular expression
print buf[match 0] // prints "aaaa"
```

search

Declaration

```
bool search(Regexp re,
            Buffer b,
            int start
            [,int finish])
```

Operation

Searches part of *b* using *re*. The search starts at *start* and continues until *finish*, or if *finish* is omitted, from *start* to the end of the buffer.

This function provides a performance advantage over the concatenation of regular expression to buffer with the range option.

Note that the `match`, `end` and `start` regular expression functions can be used to return offsets relative to *start*, not the start of the buffer.

Text buffers example program

```
// buffer DXL example
/*
  example use of DXL buffers - place a border
  around a multi-line piece of text, e.g.:
  +-----+
  | the quick brown |
  | fox jumped over |
  | the lazy dog   |
  +-----+
*/

Buffer process(Buffer source) {
    Regexp line = regexp ".*" // matches up
                          // to newline

    int from = 0
    int max = 0
    Buffer boxed = create, horiz = create
    while (search(line, source, from)) {
        // takes a line at
        // a time from source
        int offset = end 0
        // end of the match within source
        string match = source[from:from+offset]
```

```

    from += offset + 2
    // move 'from' over any newline
    if (null match)          // we are done
        break

    max = max >? length match
    // remember max line length
}
if (max==0) { // no strings matched
    boxed = "++\n++"
} else {
    horiz = "+"    // build a horizontal line
    int i
    for i in 1:max+2 do // allow two spaces
        horiz += '-'

    horiz += '+'

    horiz += '\n'

    from = 0          // reset offset
    boxed += horiz

    while (search(line, source, from)) {
        // rescan buffer
        int offset = end 0
        string match =
            source[from:from+offset]

        if (null match)
            break

        from += offset + 2

        boxed += '|' // add the vertical bars
        boxed += ' '
        boxed += match

        for i in 1 : max - length match + 1 do
            boxed += ' '
            // add space to side of box

        boxed += '|'

        boxed += '\n'
    }

    boxed += horiz

    return boxed
}
}
Buffer text = create

```

```

text = "The quick brown" // build a test string
text += '\n'
text += "fox jumped over"
text += '\n'
text += "the lazy dog"
cout = write "buffer.tmp"
cout << process text // print result

```

Arrays

This section describes a dynamically sized two-dimensional array data type. An example of its use is in the DOORS ASCII output generator in the tools library. As with skip lists, you must retrieve data into variables of the same data type as they were put into the array, or program failure may occur.

Because DXL provides no garbage collection, it is important to delete DXL's dynamic arrays that are no longer required, thereby freeing allocated memory.

Dynamic arrays are not a fundamental type inherited from DXL's C origins, so the type name `Array` begins with an upper case letter.

create (array)

Declaration

```

Array create(int x,
             int y)

```

Operation

Creates a dynamically sized array of initial bounds (x,y) . Following C conventions, the minimum co-ordinate is $(0,0)$, and the maximum co-ordinate is $(x-1,y-1)$. If an assignment is made to an array element outside these initial bounds, the array is automatically resized. When viewing arrays with the `printCharArray` function, the X axis grows left to right across the page, while the Y axis grows down the page.

Both arguments to `create` must be greater than or equal to 1.

Example

This example creates an array with 50 elements in the X direction accessed from $(0,0)$ to $(49,0)$, and only one element in the Y direction:

```

Array firstArray = create(50,1)

```

delete (array)

Declaration

```
void delete(Array a)
```

Operation

Deletes array *a*; stored contents are not affected.

get (data from array)

Declaration

```
type get(Array a,
         int x,
         int y)
```

Operation

Returns the data, of any type, stored in array *a* at position (*x*, *y*). You must retrieve the data into a variable of the same type as used when the data was put into the array. To ensure that this works unambiguously in the way intended, you should use a cast prefix to the `get` command.

Arrays are not just for fundamental types like strings and integers. You can store any DXL type in them, for example, objects, modules, skip lists, and even other arrays.

Example

This example uses a cast prefix to `get`:

```
Array a = create(10,10)
string str
int i
put(a, "a string", 3, 4)
put(a, 1000, 3, 5)
str = (string get(a,3,4)) // cast get as string
print str "\n"           // prints "a string"
i = (int get(a, 3, 5))   // cast get as int
print i                  // prints "1000"
```

This example stores an array in an array:

```
Array a = create(4,1)
Object obj = first current Module
Module mod = current
Skip skp = create
```



```

Array arr = create(1,1)
put(a, obj, 0, 0)
put(a, mod, 1, 0)
put(a, skp, 2, 0)
put(a, arr, 3, 0)
put(arr,"I was nested in a!", 0, 0)
Object objRef = (Object get(a,0,0))
Module modRef = (Module get(a,1,0))
Skip   skpRef = (Skip   get(a,2,0))
Array  arrRef = (Array  get(a,3,0))
string str    = (string get(arrRef, 0, 0))
print str     // prints "I was nested in a!"

```

get (string from array)

Declaration

```

string get(Array a,
           int x,
           int y,
           int len)

```

Operation

Retrieves *len* characters as a string from *a* starting at position (*x*,*y*). This is the matching get command for `putString`.

Example

```

Array a = create(10,10)
putString(a, "a string", 2, 2)
string some = get(a, 4, 2, 3)
print some "\n"           // prints "str"

```

put (data in array)

Declaration

```

void put(Array a,
         type data,
         int x,
         int y)

```

Operation

Puts *data*, of any type, into array *a* at position (*x*,*y*). If the new position is outside *a*'s current bounds, *a* is resized to accommodate the new element.

putString

Declaration

```
void putString(Array a,
               string s,
               int x,
               int y)
```

Operation

Puts the string *s* into the array *a* in such a way that its character contents are placed in X-direction adjacent elements starting at (*x*,*y*). The original, or any other desired string can be rebuilt by using the argument string form of `get (a, x, y, len)`. The 3-argument form of `get` can be used to retrieve individual characters. Attempting to retrieve a character as a string causes program failure.

printCharArray

Declaration

```
void printCharArray(Array a,
                   Stream s,
                   int x1,
                   int y1,
                   int x2,
                   int y2)
```

Operation

Sends the section of array *a* defined by the passed co-ordinates *x1*,*y1* and *x2*,*y2*, to the stream *s*.

Example

```
Array a = create(20,5)
int x,y
for y in 0 : 4 do // populate an array with a
  for x in 0 : 19 do // block of # characters.
    put(a, '#', x, y)
Stream out = write "array.tmp" // open a stream
printCharArray(a, out, 0, 0, 19, 4) // write original block
out << "\n"
putString(a,"abc", 3, 1) // insert a string
```

```
printCharArray(a, out, 0, 0, 19, 4)
// view change
out << "\n"
close out
```

Chapter 7

Operating system interface

This chapter describes the major packages of functions that allow DOORS to communicate with the host operating system:

- Operating system commands
- Windows registry
- Interprocess communications
- System clipboard functions

Operating system commands

This section defines functions that interact with the operating system under which DOORS is being run. For a DXL program to be portable between platforms, care is needed when using these facilities. The functions that use the `Stat` data type work on the `stat` API provided by the operating system, which enables DXL programs to determine the status of files and directories.

platform

Declaration

```
string platform()
```

Operation

Returns the name of the current DOORS platform, currently one of:

HP/UX	HP®
SunOs	Sun®
Solaris	Solaris®
WIN32	All Windows platforms

This function can be used to make programs portable between platforms.

Example

```
string fileGoodName_(string root, extpc, extunix) {
    if (platform == "WIN32")
        return currentDirectory "\\\"
            goodFileName root extpc
    else
        return (getenv "HOME") "/"
            goodFileName root extunix
}
```

The function `fileGoodName_`, defined in `$DOORSHOME/lib/dxl/utils/ fileops.dxl` uses `platform` to construct an appropriate file name for the current operating system. Using such functions enables DXL programs to be useful on all platforms. Literal file names in programs may not be portable. The path `/tmp/dxl/myfile` may work on a WIN32 platform, but `c:\temp\dxl\myfile` cannot work on a UNIX platform.

getenv

Declaration

```
string getenv(string var)
```

Operation

Returns the current value of the environment variable `var`, as set in the operating system. Both Windows and UNIX platforms support this mechanism.

Note: You should know about your operating system's environment variables before using this function. If necessary, consult the operating system documentation.

Example

```
print getenv("HOME")
print getenv("DATA")
print getenv("DOORSHOME")
print getenv("DOORSDATA")
```

The first two examples return the corresponding variable values in the registry.

The second two examples return the corresponding variable values used in a command-line shortcut to start DOORS, if set. Otherwise, returns the values set in the registry.

hostname

Declaration

```
string hostname()
```

Operation

Returns a string, which is the name of the current host system.

fullHostname

Declaration

```
string fullHostname(void)
```

Operation

Gets the fully qualified hostname of the machine on which the perm is executed.

mkdir

Declaration

```
void mkdir(string dirName  
           [,string osParm])
```

Operation

Creates directory *dirName*.

Optional argument *osParm* can contain information that is dependent on the operating system, such as the UNIX octal file access mask.

Example

The following example creates a typical UNIX path name, and sets the access rights:

```
mkdir("/usr/development/phase1", "0755")
```

The following example creates a Windows path, for which there are no access rights:

```
mkdir("C:\\DOORS\\DXLEexample\\", "")
```

setenv

Declaration

```
void setenv(string var,  
            string s)
```

Operation

Sets the registry variable *var* to *s* in the registry section

HKEY_CURRENT_USER\Software\Telelogic\DOORS*<DOORS version>*\Config, where *<DOORS version>* is the version number of the current version of DOORS installed.

Before using this function, you should be familiar with your operating system's registry variables. If necessary, consult your operating system documentation.

setServerMonitor

Declaration

```
void setServerMonitor (bool on)
```

Operation

On Windows platforms only, when `on` is `true`, activates the DOORS Server Monitor. This inserts an icon in the Windows task bar that monitors client server communications.

serverMonitorIsOn

Declaration

```
bool serverMonitorIsOn ()
```

Operation

On Windows platforms only, returns `true` if the DOORS Server Monitor is active. Otherwise, returns `false`.

username

Declaration

```
string username ()
```

Operation

Returns a string that contains the operating system defined username under which DOORS is being run. This may not be the same as the DOORS username returned by `doorsname`, depending on the current project's setup.

system

Declaration

```
void system (string command)
```

Operation

On Windows platforms only, passes the string `command` to the operating system for execution, and continues the current DXL program. Using `platform` in conjunction with this function prevents an error message on UNIX platforms.

Example

```
if (platform=="WIN32")
    system "notepad"
```

Note that if the command to be executed is a built in DOS command, such as `del`, you need, for example:

```
system "c:\\windows\\command.com /c del temp.txt"
```

Declaration

```
void system(string command,
            void childCB(int)
            [,void parentCB()])
```

Operation

On UNIX platforms only, passes the string *command* to the operating system for execution.

Unlike the Windows `system` function, these functions terminate the current execution path of the calling DXL program. One or two callback functions must be provided. In the first form, only a function *childCB* is needed. This function is called when the operating system finishes execution of *command*. In the second form, *parentCB* is also provided; this is called concurrently with the operating system's processing of *command*, thus allowing the calling DXL program to continue work while the command is being executed.

Example

```
void cb(){
    print "system command executing\n"
}

void nullCB(int status){
}

if (platform == "WIN 32"){
    system("E:\\winnt\\system32\\command.com")

    cb
} else{
    system ("xterm", nullCB, cb)
}
```

create (status handle)

Declaration

```
Stat create(Stream s)
Stat create(string filename)
```

Operation

Returns a status handle for the stream or file name, which is used in the other `Stat` functions.

delete (status handle)

Declaration

```
void delete(Stat s)
```

Operation

Deletes the handle *s*.

accessed, modified, changed (date)

Declaration

```
Date accessed(Stat s)
```

```
Date modified(Stat s)
```

```
Date changed(Stat s)
```

Operation

Returns the accessed, modified or changed date of the stream or file identified by the handle.

directory, symbolic, regular

Declaration

```
bool directory(Stat s)
```

```
bool symbolic(Stat s)
```

```
bool regular(Stat s)
```

Operation

Returns true if the stream or file identified by the handle is a directory, a symbolic link, or a regular file respectively.

Example

```
Stat s
string filename = "/etc"
s = create filename
if (!null s && directory s)
    ack filename " is a directory!"
```

user, size, mode

Declaration

```
string user(Stat s)
```

```
int size(Stat s)
```

```
int mode(Stat s)
```

Operation

Returns the username, size or mode of the stream or file identified by the handle.

The following constant integers are used with the `int mode (Stat)` function as bit-field values (using standard UNIX `stat` semantics).

Constant	Meaning
<code>S_ISUID</code>	set user id on execution
<code>S_ISGID</code>	set group id on execution
<code>S_IRWXU</code>	read, write, execute permission: owner
<code>S_IRUSR</code>	read permission: owner
<code>S_IWUSR</code>	write permission: owner
<code>S_IXUSR</code>	execute/search permission: owner
<code>S_IRWXG</code>	read, write, execute permission: group
<code>S_IRGRP</code>	read permission: group
<code>S_IWGRP</code>	write permission: group
<code>S_IXGRP</code>	execute/search permission: group
<code>S_IRWXO</code>	read, write, execute permission: other
<code>S_IROTH</code>	read permission: other
<code>S_IWOTH</code>	write permission: other
<code>S_IXOTH</code>	execute/search

Example

The following example shows how to emulate the formatting of part of the UNIX command `ls -l`.

```
string filename = "/etc"
Stat s = create filename
if (!null s) {
    int modes = mode s
    print (modes&S_ISUID!=0 ? 's' : '-')
    print (modes&S_IRUSR!=0 ? 'r' : '-')
    print (modes&S_IWUSR!=0 ? 'w' : '-')
    print (modes&S_IXUSR!=0 ? 'x' : '-')
    print (modes&S_IRGRP!=0 ? 'r' : '-')
    print (modes&S_IWGRP!=0 ? 'w' : '-')
    print (modes&S_IXGRP!=0 ? 'x' : '-')
}
```

```

print (modes&S_IROTH!=0 ? 'r' : '-')
print (modes&S_IWOTH!=0 ? 'w' : '-')
print (modes&S_IXOTH!=0 ? 'x' : '-')
print "\t" filename
}

```

Status handle functions example

This example is taken from `$DOORSHOME/lib/dxl/utils/fileops.dxl`.

```

bool fileExists_(string filename) {
    Stat s
    s = create filename
    if (null s) return false
    delete s
    return true
}

```

It is used by several of the DXL Library tools to determine whether a file exists.

Windows registry

getRegistry

Declaration

```

string getRegistry(string keyName,
                  string valueName)

```

Operation

Returns a string representation of the named value of the specified Windows registry key.

The *keyName* argument must be a fully specified registry key, beginning with any one of the following:

```

HKEY_CURRENT_USER
HKEY_LOCAL_MACHINE
HKEY_CLASSES_ROOT
HKEY_USERS

```

If *valueName* is null, returns the default value for the key. If the key does not exist, the value does not exist, or the operating system is not a Windows platform, returns *null*.

Example

```
string s = "HKEY_CURRENT_USER\\SOFTWARE\\Microsoft
Office\\9.1\\Common\\LocalTemplates"
print getRegistry(s, null) "\n"
string s = "HKEY_CURRENT_USER\\SOFTWARE\\Microsoft Office\\95\\WORD\\OPTIONS"
print getRegistry(s, "DOC-PATH") "\n"
```

setRegistry

Declaration

```
string setRegistry(string keyName,
                  string valueName,
                  {string|int} value)
```

Operation

Sets the named value of the specified registry key to have the value supplied and the appropriate registry type, as follows:

Type of value	Registry type
string value	REG_SZ
integer value	REG_DWORD

The key is created if one does not already exist. If *valueName* is null, the default key value is set.

The *keyName* argument must be a fully specified registry key, beginning with any one of the following:

HKEY_CURRENT_USER

HKEY_LOCAL_MACHINE

HKEY_CLASSES_ROOT

HKEY_USERS

This function is only usable on Windows platforms.

If the operation fails, returns an error message; otherwise returns null.

Example

```
string s = "HKEY_CURRENT_USER\\SOFTWARE\\XYZ Inc.\\The Product\\Verification"
// Set default value of key
string errMess = setRegistry(s, null, "Default string value")
// Set named string value
errMess = setRegistry(s, "Configuration Parameter", "Is enabled")
// Set named integer value
```

```
checkStringReturn setRegistry(s, "Usage count", 1234)
```

deleteKeyRegistry

Declaration

```
string deleteKeyRegistry(string keyName)
```

Operation

Deletes the named key from the registry, therefore extreme caution should be used.

The *keyName* argument must be a fully specified registry key, beginning with any one of the following:

```
HKEY_CURRENT_USER
```

```
HKEY_LOCAL_MACHINE
```

```
HKEY_CLASSES_ROOT
```

```
HKEY_USERS
```

This function is only usable on Windows platforms.

If the operation fails, returns an error message; otherwise returns null.

Example

```
// Clear up keys created
string errMsg = deleteKeyRegistry "HKEY_CURRENT_USER\\-
                               SOFTWARE\\XYZ Inc.\\The Product\\Verification"
errMsg = deleteKeyRegistry "HKEY_CURRENT_USER\\SOFTWARE\\XYZ Inc.\\The
Product"
errMsg = deleteKeyRegistry "HKEY_CURRENT_USER\\SOFTWARE\\XYZ Inc."
```

deleteValueRegistry

Declaration

```
string deleteValueRegistry(string keyName,
                           string valueName)
```

Operation

Deletes the named value from the specified registry key. If *valueName* is null, deletes the default value for the key.

Note: Use caution when calling this function.

The *keyName* argument must be a fully specified registry key, beginning with any one of the following:

```
HKEY_CURRENT_USER
```

```
HKEY_LOCAL_MACHINE
```

HKEY_CLASSES_ROOT

HKEY_USERS

This function is only usable on Windows platforms.

If the operation fails, returns an error message; otherwise returns null.

Example

```
string s = "HKEY_CURRENT_USER\\SOFTWARE\\XYZ Inc.\\-
          The Product\\Verification"
// Delete named value
string errMess = deleteValueRegistry(s, "Usage count")
// Delete default value
errMess = deleteValueRegistry(s, null)
```

Interprocess communications

There are two forms of interprocess communications (IPC):

- The first uses TCP/IP. It can be used with the UNIX and Windows operating systems on all supported platforms.
- The second uses sockets, where a file is used to pass messages. It works only on UNIX platforms.

For examples of the use DXL IPC functions, see the DOORS API Manual.

Windows programs can also use OLE Automation functions to communicate with other programs.

ipcHostname

Declaration

```
string ipcHostname(string ipAddress)
```

Operation

Resolves the IP address *ipAddress* to its host name.

Example

This example prints localhost in the DXL Interaction window's output pane.

```
print ipcHostname("127.0.0.1")
```

server

Declaration

```
IPC server(string socket)
```

```
IPC server(int port)
```

Operation

The first form establishes a server connection to the UNIX socket *socket*.

The second form establishes a server connection to the port number *port* on **all** platforms. In the case that supplied port number is 0, an ephemeral port number is allocated by the operating system. To fetch this ephemeral port number, use `getPort()` on the resulting IPC.

getPort

Declaration

```
int getPort(IPC channel)
```

Operation

Fetches the port associated with the specified IPC. Useful when the IPC is allocated an ephemeral port by the operating system (see `IPC server(int)`).

client

Declaration

```
IPC client(string socket)
```

```
IPC client(int ip,  
           string host)
```

Operation

The first form establishes a client connection to the UNIX socket *socket*.

The second form establishes a client connection to the IP address *ip* at *host* on **all** platforms.

accept

Declaration

```
bool accept(IPC)
```

Operation

Waits for a client connection at the server end of the connection.

send

Declaration

```
bool send(IPC chan,  
          string message)
```

Operation

Sends the string *message* down IPC channel *chan*.

recv

Declaration

```
bool recv(IPC chan,  
          {string|Buffer} &response  
          [,int tmt])
```

Operation

Waits for a message to arrive in channel *chan* and assigns it to string or buffer variable *response*.

The optional third argument defines a time-out, *tmt* seconds, for a message to arrive in channel *chan*. If *tmt* is zero, these functions wait forever. They only work if the caller is connected to the channel as a client or a server.

disconnect

Declaration

```
void disconnect(IPC chan)
```

Operation

Disconnects channel *chan*.

delete (IPC channel)

Declaration

```
void delete(IPC chan)
```

Operation

Deletes channel *chan* (can be a server or a client).

System clipboard functions

copyToClipboard

Declaration

```
bool copyToClipboard(string s)
```

Operation

Copies a plain text string (i.e. not RTF) to the clipboard. On success, returns `true`.

setRichClip

Declaration

```
void setRichClip(RTF_string__ s, string styleName, string fontTable)
void setRichClip(Buffer buff, string styleName, string fontTable)
void setRichClip(RTF_string__ s, string styleName, string fontTable, bool
keepBullets, bool keepIndents)
void setRichClip(Buffer buff, string styleName, string fontTable, bool
keepBullets, bool keepIndents)
```

Operation

First form sets the system clipboard with the rich text obtained by applying the style *styleName* to the string *s*, using the font table *fontTable* supplied, which should include a default font. Font numbers in the string *s* will be translated to the supplied font table *fontTable*.

Second form is same as the first but the source is a buffer *buff* rather than an `RTF_string__`.

Third form sets the system clipboard with the rich text obtained by applying the style *styleName* to the string *s*, using the font table *fontTable* supplied. If *keepBullets* is `false`, any bullet characters are removed from string *s*. If *keepIndents* is `false`, any indentation is removed from string *s*. If *keepBullets* and *keepIndents* are both `true`, the behavior is exactly the same as the first form.

Fourth form is same as the third but the source is a buffer *buff* rather than an `RTF_string__`.

Example 1

The following code:

```
string s = "hello"
string fontTable = "\\deff0{\\fonttbl {\\f1 Times New Roman;}}"
setRichClip(richText s, "Normal", fontTable)
```

puts the following rich text string onto the system clipboard:

```
{\rtf1 \deff0{\fonttbl {\f1 Times New Roman;}}{\stylesheet {\s1 Normal;}}{\s1
hello\par}}
```

Example 2

```
string bulletedString =
"{\rtf1\ansi\ansicpg1252\deff0\deflang1033{\fonttbl{\f0\fswiss\fccharse
t0 Arial;}{\f1\fnil\fccharset2 Symbol;}}
\viewkind4\uc1\pard\f0\fs20 Some text with\par
\pard{\pntext\f1\b7\tab}{\*\pn\pnlvblt\pnf1\pnindent0{\pntxtb\b7
}}\fi-720\li720 bullet 1\par
{\pntext\f1\b7\tab}bullet 2\par
\pard bullet points in it.\par
\par
}"
```

```
string fontTable = "\deff0{\fonttbl{\f0\fswiss\fccharset0
Arial;}{\f1\fnil\fccharset2 Symbol;}}"
```

```
setRichClip(richText bulletedString, "Normal", fontTable)
```

```
// the previous call puts
// "{\rtf1 \deff0{\fonttbl{\f0\fswiss\fccharset0 Arial;}{\f1\fnil\fccharset2
Symbol;}}{\stylesheet {\s1 Normal;}}{\s1 Some text with\par {\f1\b7\tab}bullet
1\par {\f1\b7\tab}bullet 2\par bullet points in it.\par \par}"
// on the clipboard
```

```
setRichClip(richText bulletedString, "Normal", fontTable, false, false)
```

```
// the previous call puts
// "{\rtf1 \deff0{\fonttbl{\f0\fswiss\fccharset0 Arial;}{\f1\fnil\fccharset2
Symbol;}}{\stylesheet {\s1 Normal;}}{\s1 Some text with\par bullet 1\par bullet
2\par bullet points in it.\par \par}"
// on the clipboard -- note no bullet symbols (\b7) in the markup
```

Chapter 8

Customizing DOORS

This chapter describes how to customize DOORS:

- Color schemes
- DOORS Explorer options
- Locales
- Codepages
- Message of the day
- Database Properties

Color schemes

This section defines constants and functions for setting the DOORS color scheme.

Display Color Schemes

The following constants are defined as database display schemes for use with the functions below:

`originalDOORSColorScheme`

`modernDOORSColorScheme`

`highContrastOneColorScheme`

`highContrastTwoColorScheme`

`highContrastBlackColorScheme`

`highContrastWhiteColorScheme`

getDefaultColorScheme

Declaration

```
int getDefaultColorScheme()
```

Operation

Returns the default color scheme used by the DOORS Explorer. The possible values for `colorScheme` are listed above.

setDefaultColorScheme

Declaration

```
void setDefaultColorScheme(int colorScheme)
```

Operation

Sets the default color scheme used by the DOORS Explorer. Schemes can be created and modified using the **Display** tab in the Options dialog box (from the **Tools > Options** menu in the DOORS Explorer). The possible values for `colorScheme` are listed above:

optionsExist

Declaration

```
bool optionsExist(string schemeName)
```

Operation

Returns `true` if a color scheme exists under `schemeName`; otherwise, returns `false`.

resetColors

Declaration

```
void resetColors([int colorScheme])
```

Operation

If no argument is supplied, resets to the default color scheme otherwise resets to `colorScheme`, which can any of the values listed above.

resetColor

Declaration

```
void resetColor(int colorIndex  
                [,int colorScheme])
```

Operation

Resets the color specified by `colorIndex` to the default, or if the second argument is supplied, to `colorScheme`, which can be any of the values listed above.

DOORS Explorer options

This section defines constants and functions for customizing the DOORS Explorer.

Font constants

Declaration

```
int HeadingsFont
int TextFont
int GraphicsFont
```

Operation

These constants define the font in the `getFontSettings` and `setFontSettings` functions.

getFontSettings

Declaration

```
void getFontSettings(int level,
                    int usedIn,
                    int &size,
                    int &family,
                    bool &bold,
                    bool &italic)
```

Operation

Passes back settings for the font *usedIn* for objects at heading level *level*. The value of *usedIn* can be `HeadingFont`, `TextFont`, or `GraphicsFont`. The last four arguments pass back the point size, font family, whether the font is bold, and whether the font is italic.

setFontSettings

Declaration

```
void setFontSettings(int level,
                    int usedIn,
                    int size,
                    int family,
                    bool bold,
                    bool italic)
```

Operation

Sets the point size, font family, whether the font is bold, and whether the font is italic for the font *usedIn* for objects at heading level *level*. The value of *usedIn* can be `HeadingFont`, `TextFont`, or `GraphicsFont`.

refreshExplorer

Declaration

```
void refreshExplorer (Module m)
```

Operation

Refreshes the DOORS Explorer window for module *m*.

synchExplorer

Declaration

```
void synchExplorer (Module m)
```

Operation

Refreshes the DOORS Module Explorer window to reflect changes to the current object selected in the module display.

refreshDBExplorer

Declaration

```
void refreshDBExplorer ()
```

Operation

Refreshes the DOORS Explorer window to reflect changes to the current folder or the display state. If the current folder/project is changed using DXL, this perm will not change the currently open item to reflect this. This is used to only refresh the contents of the currently selected item.

setShowFormalModules, setShowDescriptiveModules, setShowLinkModules

Declaration

```
void setShowFormalModules (bool expression)
void setShowDescriptiveModules (bool expression)
void setShowLinkModules (bool expression)
```

Operation

Shows formal, descriptive, or link modules in the DOORS Explorer if *expression* is `true`. Hides formal, descriptive, or link modules if *expression* is `false`.

showFormalModules, showDescriptiveModules, showLinkModules (get)

Declaration

```
bool showFormalModules()
bool showDescriptiveModules()
bool showLinkModules()
```

Operation

Returns `true` if the DOORS Explorer is set to show formal, descriptive, or link modules; otherwise returns `false`.

Locales

getDateFormat

Declaration

```
string getDateFormat([Locale l], [bool isShortFormat])
```

Operation

When called with no arguments, this returns the current default short date format. This may be selected for the current user locale, using the Windows Control Panel. If the boolean argument is supplied and is `false`, the default long date format is returned.

Locale type

Operation

This type represents any valid user locale value. It can take any of the values supported by the client system.

The perms that take a Locale argument will all return a DXL run-time error if they are supplied with a null value.

for Locale in installedLocales

Declaration

```
for Locale in installedLocales
```

Operation

This iterator returns all the Locale values installed on the client system.

Example

```
Locale loc
for loc in installedLocales do
{
    print id(loc) ": " name(loc) "\n"
}
```

for Locale in supportedLocales

Declaration

```
for Locale in supportedLocales
```

Operation

This iterator returns all the Locale values supported on the client system.

userLocale

Declaration

```
Locale userLocale()
```

Operation

This returns the current user locale on the client system.

name

Declaration

```
string name(Locale l)
```

Operation

This returns the name (in the current desktop language) of the specified Locale.

language

Declaration

```
string language(Locale l)
```

Operation

This returns the English name of the Locale language.

region

Declaration

```
string region(Locale l)
```

Operation

This returns the English name of the country/region of the Locale.

id

Declaration

```
int id(Locale l)
```

Operation

This returns the integer identifier value for the Locale. This is a constant for any given Locale.

locale

Declaration

```
Locale locale(int i)
```

Operation

This returns the Locale for the specified identifier value. It returns null if the integer value is not a valid supported locale identifier.

installed

Declaration

```
bool installed(Locale l)
```

Operation

This returns true if the Locale is installed on the client machine. Otherwise it returns false.

attributeValue

Declaration

```
bool attributeValue(AttrDef attr, string s[, bool bl])
```

Operation

Tests whether the supplied string represents a valid value for the specified attribute definition. If the third argument is supplied and set to `true`, the function will return `true` if the attribute base type is date and the string is a valid date string for the user's current Locale setting.

locale

Declaration

```
AttrDef.locale()
```

Operation

Use to access the locale of the specified `AttrDef`. It returns null if there is no locale specified by the attribute definition.

Example

```
AttrDef ad = find(current Module, "Object Text")
Locale loc = ad.locale
print "Object Text locale is " name(loc) "\n"setLocale
```

setLocale

Declaration

```
AttrDef.setLocale(Locale)
```

Example

```
Locale loc = userLocale
AttrDef ad = find(current Module, "Object Text")
ad.setLocale(loc)
```

getLegacyLocale

Declaration

```
Locale getLegacyLocale(void)
```

Operation

Returns the legacy data locale setting for the database. This determines the locale settings that are used to display legacy attribute data. If none is set, this returns null, and legacy attribute values are displayed according to the settings for the current user locale.

setLegacyLocale

Declaration

```
string setLegacyLocale(Locale l)
```

Operation

This allows users with Manage Database privilege to set the Legacy data locale for the database (as explained above). `setLegacyLocale (null)` removes the Legacy data locale setting for the database. Returns null on success, and an error string on failure, including when it is called by a user without Manage Database privilege.

Single line spacing constant

Declaration

```
int single
```

Operation

This constant is used to specify single line spacing.

Line spacing constant for 1.5 lines

Declaration

```
int onePointFive
```

Operation

This constant is used to specify 1.5 lines line spacing.

setLineSpacing

Declaration

```
void setLineSpacing(int lineSpacing)
```

Operation

Sets line spacing for the current locale.

Example

```
setLineSpacing(single)
```

getLineSpacing

Declaration

```
int getLineSpacing()
```

Operation

Retrieves the line spacing for the current locale.

Example

```
if (getLineSpacing() == onePointFive)
{
    print "Line spacing is set to One and a half lines.\n"
}
```

setLineSpacing

Declaration

```
void setLineSpacing(Locale locale, int lineSpacing)
```

Operation

Sets line spacing for the desired locale.

getLineSpacing

Declaration

```
int getLineSpacing(Locale locale)
```

Operation

Retrieves the line spacing for the desired locale.

getDefaultLineSpacing

Declaration

```
int getDefaultLineSpacing( void)
```

Operation

Returns the default line spacing for the user's current locale. For example, it will return `single` when the line spacing is European, `onePointFive` when the line spacing is Japanese, Chinese, or Korean, and so on.

getFontSettings

Declaration

```
void getFontSettings(int level, int usedIn, int &size, string &family, bool
&bold, bool &italic, Locale locale)
```

Operation

Gets the current user's font-related display options for the locale provided. The *usedIn* parameter can be one of the following constants: `HeadingsFont`, `TextFont` or `GraphicsFont`.

Example

```
int pointSize
string fontFamily
bool bold, italic
getFontSettings(2, TextFont, pointSize, fontFamily, bold, italic, userLocale)
print fontFamily ", " pointSize ", " bold ", " italic "\n"
```

setFontSettings

Declaration

```
void setFontSettings(int level, int usedIn, int size, string family, bool bold,
bool italics, Locale locale)
```

Operation

Sets the current user's font-related display options for the locale provided.

for string in availableFonts do

Declaration

```
for string in availableFonts do {}
```

Operation

Iterator over the specified `availableFonts`.

Example

```
string fontName
for fontName in availableFonts do {
...
}
```

Provides access to the names of each of the available fonts.

Codepages

Constants

Constants for codepages

The following constants denote codepages:

- `const int CP_LATIN1 // ANSI Latin-1`
- `const int CP_UTF8 // Unicode UTF-8 encoding`
- `const int CP_UNICODE // UTF-16 little-endian encoding (= CP_UTF16_LE)`
- `const int CP_UTF16_LE // UTF-16 little-endian encoding`
- `const int CP_UTF16_BE // UTF-16 big-endian encoding`
- `const int CP_JAP // Japanese (Shift-JIS)`
- `const int CP_CHS // Simplified Chinese (GB2312)`
- `const int CP_KOR // Korean (KSC 5601)`
- `const int CP_CHT // Traditional Chinese (Big 5)`

for int in installedCodepages

Declaration

```
for int in installedCodepages do
```

Operation

This iterator returns the values of all the codepages installed in the client system.

for int in supportedCodepages

Declaration

```
for int in supportedCodepages do
```

Operation

This iterator returns the values of all codepages supported by the client system. Some of these may not be currently installed.

currentANSIcodepage

Declaration

```
int currentANSIcodepage()
```

Operation

Returns the current default ANSI codepage for the client system. For example, in Western Europe and North America this will typically return 1252, equivalent to ANSI Latin-1.

codepageName

Declaration

```
string codepageName(int codepage)
```

Operation

This returns the name of the specified codepage. Note that this returns an empty string for any codepage which is not installed on the system.

read

Declaration

```
Stream read(string filename, int codepage)
```

Operation

Opens a stream onto the specified filename; content of file decoded from the specified codepage.

write

Declaration

```
Stream write(string filename, int codepage)
```

Operation

Opens a stream onto the specified filename; content of file encoded to the specified codepage.

append

Declaration

```
Stream append(string filename, int codepage)
```

Operation

Opens a stream for append onto the specified filename; content of file encoded to the specified codepage.

readFile

Declaration

```
string readFile(string filename, int codepage)
```

Operation

Reads string from specified file; content is decoded from the specified codepage.

isValidChar

Declaration

```
bool isValidChar(char c, int codepage)
```

Operation

Returns `true` only if the supplied character can be represented in the specified codepage.

convertToCodepage

Declaration

```
{string|Buffer} convertToCodepage(int codepage, {string|Buffer&} utf8string)
```

Operation

Returns a version of the supplied string or buffer, encoded according to the specified codepage. The supplied string is assumed to be UTF8-encoded (the default encoding for all DOORS strings).

Note: Only UTF8 strings will print and display correctly in DOORS V8.0 and upwards. This perm is intended for use in exporting string data for use in other applications.

Example

```
string latin1str = convertToCodepage(CP_LATIN1, "für Elise")
```

convertFromCodepage

Declaration

```
{string|Buffer} convertFromCodepage(int codepage, {string|Buffer&} cpString)
```

Operation

Converts a string or buffer from the specified codepage to the DOORS default UTF8 encoding. Once a non-UTF8 string is converted to UTF8, it can be displayed and printed by DOORS, including 8-bit (non-ASCII) characters.

Example

```
int port=5093
int iTimeOut=10
IPC ipcServerConn=server(port)
string inputStr

if (!accept(ipcServerConn))
{
    print "No connection\n";
}
else while (recv (ipcServerConn, inputStr, iTimeOut))
{
    inputStr = convertFromCodepage(currentANSIcodepage(), inputStr)
    print inputStr "\n";
}
```

Message of the day

setMessageOfTheDay

Declaration

```
string setMessageOfTheDay(string message)
```

Operation

This is used to set the message of the text in the database. Returns null if successful, returns an error if the user doesn't have the manage database privilege.

setMessageOfTheDayOption

Declaration

```
string setMessageOfTheDayOption(bool setting)
```

Operation

Used to turn the message of the day on or off . Returns an error if the user doesn't have the manage database privilege, otherwise returns null.

getMessageOfTheDay

Declaration

```
string getMessageOfTheDay()
```

Operation

Returns the message of the day if one is set, otherwise returns null.

getMessageOfTheDayOption

Declaration

```
bool getMessageOfTheDayOption()
```

Operation

Used to determine whether or not the message of the day is enabled. Returns true if it is enabled, otherwise returns false.

Example

```
string s1, s2, message
message = "Hello and welcome to DOORS!"

if (getMessageOfTheDayOption()){
    print "Current message of the day is : " (getMessageOfTheDay())
} else {
    print "No message of the day is set, setting message and turning on."
    s1 = setMessageOfTheDay(message)
    if (!null s1){
        print "There was an error setting the message of the day : " s1
    } else {
        s2 = setMessageOfTheDayOption(true)
        if (!null s2){
            print "There was an error turning on the message of the day : " s2
        }
    }
}
```

```
}
```

Database Properties

setLoginFailureText

Declaration

```
string setLoginFailureText(string msg)
```

Operation

Sets the string as the pretext for login failure Emails sent through DOORS. Returns null on success or failure error message.

getLoginFailureText

Declaration

```
string getLoginFailureText(void)
```

Operation

Gets the string used for login failure Emails sent through DOORS.

setDatabaseMailPrefixText

Declaration

```
string setDatabaseMailPrefixText(string msg)
```

Operation

Sets the string as the pretext for Emails sent through DOORS. Returns null on success or failure error message.

getDatabaseMailPrefixText

Declaration

```
string getDatabaseMailPrefixText(void)
```

Operation

Gets the string used in Emails sent through DOORS.

Chapter 9

DOORS database access

This chapter describes:

- Database properties
- Group and user manipulation
- Group and user management
- LDAP
- LDAP Configuration
- LDAP server information
- LDAP data configuration
- Telelogic Directory Server

Database properties

This section defines functions for DOORS database properties. DXL defines the data type `LoginPolicy`, which can take either of the following values:

`viaDOORSLogin`

`viaSystemLogin`

These values control how users log in to DOORS: with the user's DOORS user name or the user's system login name.

getDatabaseName

Declaration

```
string getDatabaseName()
```

Operation

Returns the name of the DOORS database.

setDatabaseName

Declaration

```
bool setDatabaseName(string newName)
```

Operation

Sets the name of the DOORS database to *newName*. If the operation succeeds, it returns `true`; otherwise, it returns `false`. The operation fails if the name contains any prohibited characters.

getAccountsDisabled

Declaration

```
bool getAccountsDisabled()
```

Operation

If standard and custom user accounts for the current database are disabled, returns `true`; otherwise, returns `false`.

Example

```
if (getAccountsDisabled()) {  
    print "Only those with May Manage Power can  
        log in"  
}
```

setAccountsDisabled

Declaration

```
void setAccountsDisabled(bool disabled)
```

Operation

Disables or enables standard and custom user accounts for the current database, depending on the value of *disabled*.

Note: A `saveDirectory()` command must be used for this to take effect.

Example

This example disables all standard and custom user accounts:

```
setAccountsDisabled(false)  
saveDirectory()
```

getDatabaseIdentifier

Declaration

```
bool getDatabaseIdentifier()
```

Operation

Returns the unique database identifier generated by DOORS during database creation.

getDatabasePasswordRequired

Declaration

```
bool getDatabasePasswordRequired()
```

Operation

Returns *true* if passwords are required for the current DOORS database; otherwise, returns *false*.

setDatabasePasswordRequired

Declaration

```
void setDatabasePasswordRequired(bool required)
```

Operation

Sets passwords required or not required for the current database, depending on the value of *required*.

getDatabaseMinimumPasswordLength

Declaration

```
int getDatabaseMinimumPasswordLength()
```

Operation

Returns the minimum number of characters required for a password on the current database.

setDatabaseMinimumPasswordLength

Declaration

```
void setDatabaseMinimumPasswordLength(int length)
```

Operation

Sets the length of password required for the current database to *length* characters. The value can be any non-negative integer.

getDatabaseMailServer

Declaration

```
string getDatabaseMailServer(void)
```

Operation

Returns as a string the name of the SMTP mail server for DOORS.

setDatabaseMailServer

Declaration

```
void setDatabaseMailServer (string serverName)
```

Operation

Sets the mail server for the current database to *serverName*.

getDatabaseMailServerAccount

Declaration

```
string getDatabaseMailServerAccount (void)
```

Operation

Returns as a string the name of the mail account that appears to originate messages from DOORS.

setDatabaseMailServerAccount

Declaration

```
void setDatabaseMailServerAccount (string accountName)
```

Operation

Sets to *accountName* the mail account that appears to originate messages from DOORS.

getLoginPolicy

Declaration

```
LoginPolicy getLoginPolicy ()
```

Operation

Returns the login policy (either `viaDOORSLogin` or `viaSystemLogin`) for the current database. These values control how users log in to DOORS: with the user's DOORS name or the user's system login name.

setLoginPolicy

Declaration

```
void setLoginPolicy(LoginPolicy policy)
```

Operation

Sets the login policy for the current database to *policy*, which can be either `viaDOORSLogin` or `viaSystemLogin`.

getDisableLoginThreshold

Declaration

```
int getDisableLoginThreshold()
```

Operation

Returns the number of times a user account tolerates a failed login. If the number of login failures to any single account exceeds this value, DOORS disables that account. No-one can use a disabled account.

If the return value is zero, there is no limit. See also the `getFailedLoginThreshold` function.

setDisableLoginThreshold

Declaration

```
void setDisableLoginThreshold(int attempts)
```

Operation

Sets the number of times a user account tolerates a failed login. If the number of login failures to any single account exceeds this value, DOORS disables that account. No-one can use a disabled account.

If *attempts* is zero, there is no limit. See also the `setFailedLoginThreshold` function.

getFailedLoginThreshold

Declaration

```
int getFailedLoginThreshold()
```

Operation

Returns the number of times DOORS tolerates a login failure. If this threshold is exceeded, DOORS closes.

If the return value is zero, there is no limit. See also the `setDisableLoginThreshold` function.

setFailedLoginThreshold

Declaration

```
void setFailedLoginThreshold(int attempts)
```

Operation

Sets the number of times DOORS tolerates a login failure. If this threshold is exceeded, DOORS closes.

If *attempts* is zero, there is no limit. See also the `setDisableLoginThreshold` function.

getLoginLoggingPolicy

Declaration

```
bool getLoginLoggingPolicy(bool type)
```

Operation

If DOORS is logging logins of the specified type, returns `true`; otherwise, returns `false`. If *type* is `true`, returns the policy for successful logins; otherwise, returns the policy for login failures.

To set the logging policy, use the `setLoginLoggingPolicy` function.

Example

This example indicates whether DOORS is logging login failures.

```
getLoginLoggingPolicy(false)
```

setLoginLoggingPolicy

Declaration

```
void setLoginLoggingPolicy(bool type,  
                           bool status)
```

Operation

Sets the logging policy for login events of the specified type. If *status* is `true`, logging of the specified type is enabled; otherwise, it is disabled. If *type* is `true`, sets the policy for successful logins; otherwise, sets the policy for login failures.

To find out the current logging policy, use the `getLoginLoggingPolicy` function.

Example

This example causes DOORS not to log successful logins.

```
setLoginLoggingPolicy(true, false)
```

setMinClientVersion

Declaration

```
string setMinClientVersion(string s)
```

Operation

Sets the minimum client version that can connect to the current database. The string argument must be of the format *n.n*, *n.n.n* or *n.n.n.n*, where each *n* is a decimal integer. The integer values represent Major version, Minor version, Service Release and Patch number respectively. The Service Release and Patch numbers are optional, and default to zero.

This perm only operates if the current user has the Manage Database privilege, otherwise it returns an appropriate error string. It also returns an error string if the string argument is not of the correct format, or represents a client version higher than the current client.

getMinClientVersion

Declaration

```
string getMinClientVersion(void)
```

Operation

Returns a string representing the minimum client version that can connect to the current database, in the format *n.n*, *n.n.n* or *n.n.n.n*. The format is explained in `setMinClientVersion`. If no minimum client version has been set for the database, this perm returns a NULL string.

setMaxClientVersion

Declaration

```
string setMaxClientVersion(string s)
```

Operation

Sets the maximum client version that can connect to the current database. The string argument must be of the format *n.n*, *n.n.n* or *n.n.n.n*, where each *n* is a decimal integer. The integer values represent Major version, Minor version, Service Release and Patch number respectively. The Service Release and Patch numbers are optional.

This perm only operates if the current user has the Manage Database privilege, otherwise it returns an appropriate error string. It also returns an error string if the string argument is not of the correct format, or represents a client version lower than the current client.

getMaxClientVersion

Declaration

```
string getMaxClientVersion(void)
```

Operation

Returns a string representing the maximum client version that can connect to the current database, in the format *n.n*, *n.n.n* or *n.n.n.n*. The format is explained in `setMinClientVersion`. If no minimum client version has been set for the database, this perm returns a null string.

doorsInfo

Declaration

```
string doorsInfo(int i)
```

Operation

A new valid value for the integer argument is defined (`infoServerVersion`).

This returns the version of the database server to which the client is currently connected.

Example

```
string serverVersion = doorsInfo(infoServerVersion)
print "database server version is " serverVersion "\n"
```

addNotifyUser

Declaration

```
void addNotifyUser(User user)
```

Operation

Adds *user* to the list of users to be notified by e-mail of attempts to log in. If *user* does not have an e-mail address, no notification takes place.

deleteNotifyUser

Declaration

```
void deleteNotifyUser(User user)
```

Operation

Deletes *user* from the list of users to be notified by e-mail of attempts to log in.

createPasswordDialog

Declaration

```
string createPasswordDialog(DB parent,
                           bool &completed)
```

Operation

Displays a dialog box containing password and password confirmation fields as well as **OK** and **Cancel** buttons. The parent argument is needed for the Z-order of the elements.

If confirmation is successful, returns a null string; otherwise, returns an error message.

If the user clicks **OK**, sets *completed* to *true*. If the user clicks **Cancel**, sets *completed* to *false*. DOORS stores the entered password temporarily for the next user account created with the `addUser` function. It is not stored as plain text, and is lost if DOORS shuts down before a new account is created.

Example

See the section “Creating a user account example,” on page 165.

changePasswordDialog

Declaration

```
string changePasswordDialog(DB parent,
                           User user,
                           bool masquerade,
                           bool &completed)
```

Operation

Displays a dialog box containing password and password confirmation fields as well as **OK** and **Cancel** buttons. The *parent* argument is needed for the Z-order of the elements.

If confirmation is successful, returns a null string; otherwise, returns an error message.

If the user clicks **OK**, sets *completed* to *true*. If the user clicks **Cancel**, sets *completed* to *false*. DOORS stores the entered password temporarily. It is not stored as plain text, and is lost if DOORS shuts down before the password is copied using the `copyPassword` function.

A user without the `mayEditUserList` power must confirm his existing password, otherwise the function returns an error message. A user with this power is not prompted for an existing password, unless *masquerade* is *true*.

Example

This example copies a new password to the user account for which it was created.

```
User u = find("John Smith")
bool completed
string s = changePasswordDialog(confirm, u,
                                false, completed)
if (completed && (null s)){
    copyPassword()
}
saveUserRecord(u)
saveDirectory()
```

confirmPasswordDialog

Declaration

```
bool confirmPasswordDialog(DB parent,
                          bool &completed)
```

Operation

Displays a dialog box containing a password confirmation field as well as **OK** and **Cancel** buttons. The title of the dialog box is always **Confirm password - DOORS**. The *parent* argument is needed for the Z-order of the elements.

If confirmation is successful, returns `true`; otherwise, returns `false`.

If the user clicks **OK**, sets `completed` to `true`. If the user clicks **Cancel**, sets `completed` to `false`.

Example

```
bool bPasswordOK = false, bCompleted = false
// query user
bPasswordOK = confirmPasswordDialog(dbExplorer, bCompleted)
// check status
if (bCompleted == true)
{
    print "Confirmed"
}
```

copyPassword

Declaration

```
bool copyPassword()
```

Operation

Copies the password created using the function to the account for which the password was created. Returns null on success and an error message on failure.

Example

This example copies a new password to the user account for which it was created.

```
User u = find("John Smith")
bool completed
string s = changePasswordDialog(dbExplorer, u, false, completed)
if (completed && (null s)){
    copyPassword()
}
```

getAdministratorName

Declaration

```
string getAdministratorName()
```

Operation

Returns the name of the administrator for the DOORS database.

sendEMailNotification

Declaration

```
bool sendEMailNotification(
    string fromDescription,
    string targetAddress,
    string subject,
    string message)
```

Operation

Issues a notification e-mail to a specific address. The communication takes place using SMTP, and depends on the appropriate Database Properties fields being correctly set up prior to its use (SMTP Mail Server and Mail Account).

The user can set the description of the sender, the subject matter, and message contents using *fromDescription*, *subject* and *message*. If *fromDescription* is a null string, DOORS defaults to a standard text:

```
DOORS Mail Server
```

The following standard text is sent in front of the specified message:

```
The following is a notification message from DOORS - please do not reply as it
was sent from an unattended mailbox.
```

Returns true if the SMTP communication was successful; otherwise, returns false.

Creating a user account example

This example creates a new user account named John Smith, having johns as its login name, with whatever password is entered in the dialog box.

```
// prevent dxl timeout dialog
pragma runLim, 0
// globals
bool g_bPasswordOK = true
// user details
const string sUserName = "John Smith"
```

```

const string sUserLogin = "johns"
// only relevant if password is required
if (getDatabasePasswordRequired() == true) {
    bool bConfirmCompleted = false
    // query user
    g_bPasswordOK =
        confirmPasswordDialog(dbExplorer,
            bConfirmCompleted)

    // check status
    if (bConfirmCompleted == false) {
        // adjust accordingly
        g_bPasswordOK = false
    }
}
// check status
if (g_bPasswordOK == true) {
    // only relevant if name doesn't exist
    // as group or user
    if (existsUser(sUserName) == false &&
        existsGroup(sUserName) == false) {
        bool bCreateCompleted = false
        // query user
        string sErrorMsg =
            createPasswordDialog(dbExplorer,
                bCreateCompleted)

        // check status
        if (sErrorMsg == null &&
            bCreateCompleted == true) {
            // add new user
            if (addUser(sUserName, sUserLogin) ==
                null) {
                // save new user list
                if (saveDirectory() == null) {
                    // refresh
                    if (loadDirectory() == null) {
                        // inform user
                        infoBox("User '"sUserName"'
                            was added successfully.\n")
                    } else {
                        // warn user
                        warningBox("Failed to load
                            user list.\n")
                    }
                }
            }
        }
    }
}

```

```

        }
    } else {
        // warn user
        warningBox("Failed to save
                    user list.\n")
    }
} else {
    // warn user
    warningBox("Failed to add user
                '"sUserName"'.\n")
}
} else {
    // warn user
    warningBox(sErrorMsg)
}
} else {
    // warn user
    warningBox("The name '"sUserName"'
                already exists as either a DOORS User or
                Group.\n")
}
}
}

```

Group and user manipulation

Group and user manipulation functions and for loops use the following DXL data types: Group, User, GroupList, UserList, and UserNotifyList. These types have the following permitted values:

Type	Constant	Meaning
GroupList	groupList	Provides access to all groups defined in the database. This is the only constant of type GroupList.
UserList	userList	Provides access to all users (with the exception of the Administrator account) who have an account in the database. This is the only constant of type UserList.
UserNotifyList	userNotifyList	Provides access to all users who must be notified by e-mail of attempts to log in. This is the only constant of type UserNotifyList.

find

Declaration

```
User find()  
{Group|User} find(string name)
```

Operation

The first form returns a handle of type `User` to the currently logged in user.

The second form returns a handle of type `Group` or type `User` for the group or user name. A call to this function where `name` does not exist causes a DXL run-time error. To check that a user or group exists, use the `existsGroup`, `existsUser` functions.

findByID

Declaration

```
User findByID(string identifier)
```

Operation

Returns a handle of type `User` for the specified `identifier`, or null if the user does not exist but the identifier is valid. If the specified identifier is badly formed, a DXL run-time error occurs.

You can extract the identifier for a user from a variable of type `User` with the `identifier` property (see “Group and user properties,” on page 175).

existsGroup, existsUser

Declaration

```
bool existsGroup(string name)  
bool existsUser(string name)
```

Operation

If the named group or user exists, returns `true`; otherwise, returns `false`.

loadUserRecord

Declaration

```
string loadUserRecord(User user)
```

Operation

Loads the details of user `user` from the database.

Example

```
User u = find("boss")
loadUserRecord(u)
string e = u.email
print e
```

ensureUserRecordLoaded

Declaration

```
string ensureUserRecordLoaded(User user)
```

Operation

If the user's record for user has not already been loaded, calls the `loadUserRecord` function.

saveUserRecord

Declaration

```
string saveUserRecord(User user)
```

Operation

Saves the details of user `user` to the database.

Note: A `saveDirectory()` command should be used to commit the changes to the database

Example

```
User u = find("boss")
loadUserRecord(u)
string e = u.email
if (null e) {
    u.email = "boss@work"
}
saveUserRecord (u)
saveDirectory()
```

loadDirectory

Declaration

```
string loadDirectory()
```

Operation

Loads the group and user list from the database. All changes made since the last load or save are lost. If the operation succeeds, returns null; otherwise, returns an error message.

saveDirectory

Declaration

```
string saveDirectory()
```

Operation

Saves all changes to groups, users, and login policies in the database. If the call fails, returns an error message.

Note: This perm places a temporary lock on the users directory. If used in a continuous manner, for example, repeatedly in a `for` loop, this could cause conflicts for another user trying to login.

for user in database

Syntax

```
for user in userList do {
  ...
}
```

where:

user is a variable of type `User`

Operation

Assigns the variable *user* to be each successive non-administrator user in the database.

Example

This example prints a list of users in the database:

```
User user
for user in userList do {
  string uName = user.name
  print uName "\n"
}
```

for group in database

Syntax

```
for group in groupList do {
  ...
}
```

where:

group is a variable of type `Group`

Operation

Assigns the variable *group* to be each successive group in the database.

Example

This example prints a list of groups in the database:

```
Group group
for group in groupList do {
    string gName = group.name
    print gName "\n"
}
```

for user in group

Syntax

```
for user in group do {
    ...
}
```

where:

<i>user</i>	is a variable of type <code>User</code>
<i>group</i>	is a variable of type <code>Group</code>

Operation

Assigns the variable *user* to be each successive non-administrator user in the specified group.

Example

This example prints a list of users in group development:

```
User user
Group development = find("development")
for user in development do {
    string uName = user.name
    print uName "\n"
}
```

for group in ldapGroupsForUser

Declaration

```
for g in ldapGroupsForUser(u) do {
  ...
}
```

where:

g is a variable of type `Group`

u is a variable of type `User`

Operation

Iterate over all groups of which the user passed to the `ldapGroupsForUser` function is a member. Note that this iterator is only effective when DOORS is configured for LDAP, not for the Telelogic Directory Server.

Example

```
User u = find("fred")
Group g
for g in ldapGroupsforUser(u) do {
  ...
}
```

for user in notify list

Syntax

```
for user in userNotifyList do {
  ...
}
```

where:

user is a variable of type `User`

Operation

Assigns the variable *user* to be each successive user in the list of users to be notified by e-mail of login activity.

copyPassword

Declaration

```
string copyPassword()
```

Operation

This is the same as the existing `copyPassword()` perm. It performs an identical operation, transferring the shadow password to the real password but instead of returning a boolean indicating success or failure, it returns NULL on success and a message on failure. The existing perm can fail resulting in a reported error in the DXL output display if an exception is thrown. The new perm will catch exceptions and pass the message back to the DXL code for it to display as a pop-up dialog.

fullName

Declaration

```
UserElement_ fullName()
```

Operation

This can be used to get the full name of the user.

Example

```
User u = find()
string name = u.fullName
```

mayEditDXL

Declaration

```
UserElement_ mayEditDXL()
```

Operation

Indicates whether the specified user is able to edit and run DXL programs.

Example

```
User u = find
bool useDXL = u.mayEditDXL
```

synergyUsername

Declaration

```
UserElement_ synergyUsername()
```

Operation

This can be used to retrieve the user's SYNERGY/Change username.

This attribute value is only available when DOORS is configured to use the Telelogic Directory Server.

This value is not writable; its value is set when the `systemLoginName` is set.

Example:

```
User u = find("Test")
string s = u.synergyUsername
User u = find("Test")
u.synergyUsername = "testuser"
//this generates an error
```

forename**Declaration**

```
UserElement_ forename()
```

Operation

This can be used to get or set the user's forename.

This attribute value is only available when DOORS is configured to use the Telelogic Directory Server.

Setting this value has the side effect of setting the user's fullName to the concatenation of forename and surname. This is only relevant when configured to use the Telelogic Directory Server.

Example

```
User u = find("Test")
string s = u.forename

User u = find("Test")
u.forename = "Tom"
```

surname**Declaration**

```
UserElement_ surname()
```

Operation

This can be used to get or set the user's surname.

This attribute value is only available when DOORS is configured to use the Telelogic Directory Server.

Setting this value has the side effect of setting the user's fullName to the concatenation of forename and surname. This is only relevant when configured to use the Telelogic Directory Server.

Example

```
User u = find("Test")
```

```
string s = u.surname

User u = find("Test")
u.surname = "Thumb"
```

Group and user management

Group and user management functions use the DXL data types `Group`, `User`, and `UserClass`.

User class constants

Type `UserClass` can have one of the following values:

Constant	Meaning
<code>administrator</code>	User type administrator
<code>standard</code>	User type standard
<code>databaseManager</code>	User type database manager
<code>projectManager</code>	User type project manager
<code>custom</code>	User type custom

Group and user properties

Properties are defined for use with the `.` (dot) operator and a group or user handle to extract information from, or specify information in a group or user record, as shown in the following syntax:

variable.property

where:

variable is a variable of type `Group` or `User`

property is one of the user or group properties

The following tables list the group properties and the information they extract or specify (for further details on specifying information see the `setGroup` function):

String property	Extracts
<code>name</code>	<code>name</code>

Boolean property	Extracts
disabled	whether the group is disabled

The following tables list the user properties and the information they extract or specify (for further details on specifying information see the setUser function):

String property	Extracts
address	postal address
email	e-mail address
identifier	identifier: a string containing a hexadecimal number, which is created by DOORS
description	description
name	name
password	password (write-only)
systemLoginName	system login name (not DOORS username)
telephone	telephone number
fullName	full name

Boolean property	Extracts
disabled	whether the account is disabled
emailCPUpdates	whether the user of the CP system can be notified by e-mail when the status of a proposal changes, for example, when it is accepted or rejected
mayArchive	whether the user can archive and restore modules and projects
mayCreateTopLevelFolders	whether the user can create folders at the root of the database
mayEditGroupList	whether the user can edit, create and delete groups
mayEditUserList	whether the user can edit, create, and delete user accounts and groups
mayManage	whether the user can manage the DOORS database

Boolean property	Extracts
<code>mayPartition</code>	whether the user can transfer the editing rights for a module to a satellite database (see the chapters on partitions in Using DOORS and Managing DOORS)
<code>passwordChanged</code>	whether the password has been changed since the account was created
<code>passwordMayChange</code>	whether the user is permitted to change the password

Integer property	Extracts
<code>passwordLifetime</code>	lifetime of password (0 means unlimited lifetime)
<code>passwordMinimumLength</code>	minimum number of characters in password for this user (non-negative integer)

Type <code>UserClass</code> property	Extracts
<code>class</code>	class of user; this can be one of the values in “User class constants,” on page 175

for property in user account

Syntax

```
for property in user do {
  ...
}
```

where:

- property* is a string variable
- user* is a variable of type `User`

Operation

Assigns *property* to be each successive *user* defined string property for user (for which the current user has read access).

isAttribute (user)

Declaration

```
bool isAttribute(User user,  
                string property)
```

Operation

Returns `true` if the specified user contains the specified string property; otherwise, returns `false`.

delete (user property)

Declaration

```
void delete(User user,  
            string property)
```

Operation

Deletes the specified user defined string property within `user`. You cannot delete properties of other types.

This action takes effect after `saveUserRecord` has been called. It is then permanent and cannot be reversed.

get (user property)

Declaration

```
string get(User user,  
           string property)
```

Operation

Returns the value of the specified user defined string property within `user`. If the property does not exist, a DXL run-time error occurs.

If successful, returns a null string; otherwise, returns an error message.

set (user property)

Declaration

```
void set(User user,  
         string property,  
         string value)
```

Operation

Updates the value of the specified string property within `user`. If the property does not exist it is created.

setGroup

Declaration

```
string setGroup(Group id,  
                property,  
                {string|bool} value)
```

Operation

Updates the value of the specified standard property within the group *id*.

If successful, returns a null string; otherwise, returns an error message.

setUser

Declaration

```
string setUser(User user,  
               property,  
               {string|int|bool} value)
```

Operation

Updates the value of the specified standard property within *user*.

If successful, returns a null string; otherwise, returns an error message.

addGroup

Declaration

```
string addGroup(string name)
```

Operation

Creates group *name*. If the operation is successful, returns a null string; otherwise, returns an error message.

deleteGroup

Declaration

```
string deleteGroup(Group group)
```

Operation

Deletes group *group* from the DOORS database. It does not affect underlying users.

This action takes effect after the user directory has been refreshed using the `saveDirectory` function. It is then permanent and cannot be reversed.

If the operation is successful, returns a null string; otherwise, returns an error message.

addUser

Declaration

```
string addUser(string name,  
              string uid)  
  
string addUser(string name,  
              string password  
              string uid)
```

Operation

The first form creates a user account with the specified *name*, and system login, *uid*. If the operation succeeds returns a null string; otherwise, returns an error message. This function must be used after a call to the `createPasswordDialog` function, so that the password is set to an initial value. The user must change the password on first use. If there has been no previous call to the `createPasswordDialog` function, the password is set to a null string.

The second form is only supported for compatibility with earlier releases. It is deprecated because passwords are passed as plain text.

This action takes effect after the user directory has been refreshed using the `saveDirectory` function.

Example

See the section “Creating a user account example,” on page 165.

deleteUser

Declaration

```
string deleteUser(User user)
```

Operation

Deletes the *user* account for user from the DOORS database. Appropriate e-mails are also issued to the same people who are notified of unsuccessful logins.

This action takes effect after the user directory has been refreshed using the `saveDirectory` function. It is then permanent and cannot be reversed.

If the operation is successful, returns a null string; otherwise, returns an error message.

addMember

Declaration

```
void addMember(Group group,  
              User user)
```

Operation

Adds user *user* to group *group*.

This action takes effect after the user directory has been refreshed using the `saveDirectory` function.

deleteMember

Declaration

```
bool deleteMember (Group group,
                  User user)
```

Operation

Deletes user *user* from group *group*. If the operation succeeds, returns `true`; otherwise, returns `false`.

This action takes effect after the user directory has been refreshed using the `saveDirectory` function.

deleteAllMembers

Declaration

```
bool deleteAllMembers (Group group)
```

Operation

Deletes all users from group *group*.

This action takes effect after the user directory has been refreshed using the `saveDirectory` function.

member

Declaration

```
bool member (Group group,
            User user)
```

Operation

If user *user* is a member of group *group*, returns `true`; otherwise returns `false`.

stringOf (user class)

Declaration

```
string stringOf (UserClass userClass)
```

Operation

Returns a string representation of the specified user class. This can be one of the following values:

```
"Administrator"  
"Standard"  
"Database Manager"  
"Project Manager"  
"Custom"
```

LDAP

saveLdapConfig()

Declaration

```
string saveLdapConfig()
```

Operation

Save the LDAP configuration to the database. Returns empty string on success, error message on failure.

loadLdapConfig()

Declaration

```
string loadLdapConfig()
```

Operation

Load the LDAP configuration from the database. Returns empty string on success, error message on failure.

getUseLdap()

Declaration

```
bool getUseLdap()
```

Operation

Gets the value of the flag which determines if we are using LDAP for storage of user and group information.

setUseLdap()

Declaration

```
string setUseLdap(bool usingLdap)
```

Operation

Sets the value of the flag which determines if we are using LDAP for storage of user and group information. Only the Administrator can set this value. Returns empty string on success, error message on failure.

updateUserList()

Declaration

```
string updateUserList()
```

Operation

Update the DOORS user list from the LDAP user list. Creates standard users for all the users permitted by LDAP if they do not already exist in the DOORS database, and updates user name and system login name for existing users.

Note: This operation can take a long time, particularly if no group of DOORS users has been specified (see `setDoorsUserGroupDN`).

updateGroupList()

Declaration

```
string updateGroupList()
```

Operation

Update the DOORS group list from the LDAP group list. Creates DOORS groups for all the groups permitted by LDAP if they do not already exist in the DOORS database, and updates group name for existing groups.

Note: This operation can take a long time, particularly if no group of DOORS groups has been specified (see `setDoorsGroupGroupDN`).

LDAP Configuration

findUserRDNFromName

Declaration

```
string findUserRDNFromName(string name, bool &unique, string &uid)
```

Operation

Search for *name* in the LDAP directory, in the attribute specified by name for DOORS user names, in the DOORS user subtree.

If found, return the distinguished name of the entry, relative to the DOORS user root. Also sets the unique flag `true` if only one matching entry was found, and fills in the `uid` string with the system login name obtained from the matching entry. If not found, returns `NULL`. Only the Administrator can run this function.

findUserRDNFromLoginName

Declaration

```
string findUserRDNFromLoginName(string uid, bool &unique, string &name)
```

Operation

Search for `uid` in the LDAP directory, in the attribute specified for system login names, in the DOORS user subtree.

If found, return the distinguished name of the entry, relative to the DOORS user root. Also sets the unique flag `true` if only one matching entry was found, and fills in the `name` string with the DOORS user name obtained from the matching entry. If not found, returns `NULL`. Only the Administrator can run this function.

findGroupRDNFromName

Declaration

```
string findGroupRDNFromName(string name, bool &unique)
```

Operation

Search for `name` in the LDAP directory, in the attribute specified for DOORS group names, in the DOORS group subtree.

If found, return the distinguished name of the entry, relative to the DOORS group root. Also sets the unique flag `true` if only one matching entry was found. If not found, returns `NULL`. Only the Administrator can run this function.

findUserInfoFromDN

Declaration

```
string findUserInfoFromDN(string dn, string &name, string &uid)
```

Operation

Search for an entry with distinguished name `dn` in the LDAP directory.

If found, fills in the `name` and `uid` with the DOORS username and system login name obtained from the matching entry. Returns `NULL`. Only the Administrator can run this function.

checkConnect

Declaration

```
string checkConnect()
```

Operation

Check the current LDAP configuration by attempting to connect to the specified server/port as the user specified by DOORS bind dn with the DOORS bind password. Returns NULL on success, error message on failure.

checkDN

Declaration

```
string checkDN(string dn)
```

Operation

Check that the given *dn* is a valid entry in the directory specified by the current LDAP configuration. This can be run to check that the user root, group root, user group dn, and group group dn have been set to existing values. Only the Administrator can run this function.

Example

```
LdapItem item
for item in ldapGroupList do
{
    print item.name "\n"
    print item.dn "\n"
    print item.uid "\n"
}

for item in ldapUserList do
{
    print item.name "\n"
    print item.dn "\n"
    print item.uid "\n"
}
```

LDAP server information

getLdapServerName

Declaration

```
string getLdapServerName()
```

Operation

Gets the name of the LDAP server.

setLdapServerName(string)

Declaration

```
string setLdapServerName(string name)
```

Operation

Sets the name of the LDAP server. Only the Administrator can set this value. Returns empty string on success, error message on failure.

getPortNo

Declaration

```
int getPortNo()
```

Operation

Gets the port number of the server used for storage of user and group information.

setPortNo

Declaration

```
string setPortNo(int portNo)
```

Operation

Sets the port number of the server used for storage of user and group information. Only the Administrator can set this value. Returns empty string on success, error message on failure.

getDoorsBindNameDN

Declaration

```
string getDoorsBindNameDN()
```

Operation

Gets the dn of the user we use to bind to the LDAP server.

setDoorsBindNameDN

Declaration

```
string setDoorsBindNameDN(string name)
```

Operation

Sets the dn of the user we use to bind to the LDAP server. Only the Administrator can set this value.

Returns empty string on success, error message on failure.

setDoorsBindPassword

Declaration

```
string setDoorsBindPassword(string pass)
```

Operation

Sets the password we use to bind to the LDAP server. Only the Administrator can set this value.

Returns empty string on success, error message on failure.

Note: There is no `getDoorsBindPassword` as DXL doesn't need to know this.

setDoorsBindPasswordDB

Declaration

```
string setDoorsBindPasswordDB(DB parentWindow)
```

Operation

This presents the user with a password dialog box. If the user enters the same valid password in both fields of the dialog box, the `setDoorsBindPassword()` functionality is executed.

This returns null on success, and an error string on failure (either if the user does not enter the same valid password in both fields of the dialog box, or if the setting of the password option failed).

getDoorsUserRoot

Declaration

```
string getDoorsUserRoot()
```

Operation

Gets the identifier of the directory subtree used for storage of user information.

setDoorsUserRoot

Declaration

```
string setDoorsUserRoot(string ident)
```

Operation

Sets the identifier of the directory subtree used to search the LDAP server for users. Only the Administrator can set this value. Returns empty string on success, error message on failure.

getDoorsGroupRoot

Declaration

```
string getDoorsGroupRoot()
```

Operation

Gets the identifier of the directory subtree used for storage of group information.

setDoorsGroupRoot

Declaration

```
string setDoorsGroupRoot(string ident)
```

Operation

Sets the identifier of the directory subtree used to search the LDAP server for groups. Only the Administrator can set this value. Returns empty string on success, error message on failure.

getDoorsUserGroupDN

Declaration

```
string getDoorsUserGroupDN()
```

Operation

Gets the dn of the LDAP group used to specify permitted DOORS users.

setDoorsUserGroupDN

Declaration

```
string setDoorsUserGroupDN(string dn)
```

Operation

Sets the dn of the LDAP group used to specify permitted DOORS users. Only the Administrator can set this value. Returns empty string on success, error message on failure.

getDoorsGroupGroupDN

Declaration

```
string getDoorsGroupGroupDN()
```

Operation

Gets the dn of the LDAP group used to specify permitted DOORS groups.

setDoorsGroupGroupDN

Declaration

```
string setDoorsGroupGroupDN()
```

Operation

Sets the dn of the LDAP group used to specify permitted DOORS groups. Only the Administrator can set this value. Returns empty string on success, error message on failure.

LDAP data configuration

getDoorsUsernameAttribute

Declaration

```
string getDoorsUsernameAttribute()
```

Operation

Gets the name of the LDAP attribute to be used for a DOORS username.

setDoorsUsernameAttribute

Declaration

```
string setDoorsUsernameAttribute(string name)
```

Operation

Sets the name of the LDAP attribute to be used for a DOORS username. Only the Administrator can set this value. Returns empty string on success, error message on failure.

getLoginNameAttribute

Declaration

```
string getLoginNameAttribute()
```

Operation

Gets the name of the LDAP attribute to be used for the system login name.

setLoginNameAttribute

Declaration

```
string setLoginNameAttribute(string name)
```

Operation

Sets the name of the LDAP attribute to be used for the system login name. Only the Administrator can set this value. Returns empty string on success, error message on failure.

getEmailAttribute

Declaration

```
string getEmailAttribute()
```

Operation

Gets the name of the LDAP attribute to be used for the user's email address.

setEmailAttribute

Declaration

```
string setEmailAttribute(string email)
```

Operation

Sets the name of the LDAP attribute to be used for the user's email address. Only the Administrator can set this value. Returns empty string on success, error message on failure.

getDescriptionAttribute

Declaration

```
string getDescriptionAttribute()
```

Operation

Gets the name of the LDAP attribute to be used for the user's description.

setDescriptionAttribute

Declaration

```
string setDescriptionAttribute(string name)
```

Operation

Sets the name of the LDAP attribute to be used for the user's description. Only the Administrator can set this value. Returns empty string on success, error message on failure.

getTelephoneAttribute

Declaration

```
string getTelephoneAttribute()
```

Operation

Gets the name of the LDAP attribute to be used for the users's telephone number.

setTelephoneAttribute

Declaration

```
string setTelephoneAttribute(string phone)
```

Operation

Sets the name of the LDAP attribute to be used for the users's telephone number. Only the Administrator can set this value. Returns empty string on success, error message on failure.

getAddressAttribute

Declaration

```
string getAddressAttribute()
```

Operation

Gets the name of the LDAP attribute to be used for the users's address.

setAddressAttribute

Declaration

```
string setAddressAttribute(string address)
```

Operation

Sets the name of the LDAP attribute to be used for the users's address. Only the Administrator can set this value. Returns empty string on success, error message on failure.

getGroupObjectClass

Declaration

```
string getGroupObjectClass()
```

Operation

Gets the name of the LDAP object class to be used to identify groups. Typically this value will be `groupOfUniqueNames`.

setGroupObjectClass

Declaration

```
string setGroupObjectClass(string class)
```

Operation

Sets the name of the LDAP object class to be used to identify groups. Only the Administrator can set this value. Returns empty string on success, error message on failure.

getGroupMemberAttribute

Declaration

```
string getGroupMemberAttribute()
```

Operation

Gets the name of the LDAP attribute to be used to identify group members. Typically this value will be `uniqueMember`.

setGroupMemberAttribute

Declaration

```
string setGroupMemberAttribute(string name)
```

Operation

Sets the name of the LDAP attribute to be used to identify group members. Only the Administrator can set this value. Returns empty string on success, error message on failure.

getGroupNameAttribute

Declaration

```
string getGroupNameAttribute()
```

Operation

Gets the name of the LDAP attribute to be used for a group's name. Typically this value will be cn.

setGroupNameAttribute

Declaration

```
string setGroupNameAttribute(string group)
```

Operation

Sets the name of the LDAP attribute to be used for a group's name. Only the Administrator can set this value. Returns empty string on success, error message on failure.

Group and user properties

Declaration

```
string ldapRDN
```

If we have a user `u`, `print u.ldapRDN` prints the user's LDAP relative distinguished name, which may be empty if LDAP is not being used.

The Administrator can set a user's LDAP rdn with

```
u.ldapRDN = new value.
```

string utf8(ansiString)

Declaration

```
string utf8(string ansiString)
```

Operation

This returns the UTF-8 format conversion of an ANSI string argument *ansiString*. LDAP servers use UTF-8 encoding, whereas DOORS data is stored in ANSI format. This affects the encoding of extended characters, such as accented letters, which are encoded in UTF-8 as 2-byte sequences.

string ansi(utf8String)

Declaration

```
string ansi(string utf8String)
```

Operation

This returns the ANSI format conversion of a UTF-8 string argument *utf8String*. LDAP servers use UTF-8 encoding, whereas DOORS data is stored in ANSI format. This affects the encoding of extended characters, such as accented letters, which are encoded in UTF-8 as 2-byte sequences.

Telelogic Directory Server

getUseTelelogicDirectory

Declaration

```
bool getUseTelelogicDirectory()
```

Operation

Returns a flag indicating whether Telelogic Directory Server support is enabled.

setUseTelelogicDirectory

Declaration

```
string setUseTelelogicDirectory(bool b)
```

Operation

Enables or disables Telelogic Directory Server support.

Returns an error string if the current user is not the administrator.

Returns an error message if the argument is `true` and ordinary LDAP is already enabled.

getTDSerName

Declaration

```
string getTDSerName()
```

Operation

Returns the Telelogic Directory Server name.

setTDSerName

Declaration

```
string setTDSerName(string s)
```

Operation

Sets the Telelogic Directory Server name.

Returns an error string if the current user is not the administrator.

getTDPortNumber

Declaration

```
int getTDPortNumber()
```

Operation

Returns the Telelogic Directory Server port number.

setTDPortNumber

Declaration

```
string setTDPortNumber(int i)
```

Operation

Sets the Telelogic Directory Server port number.

Returns an error string if the current user is not the Administrator.

getTDBindName

Declaration

```
string getTDBindName()
```

Operation

Returns the Telelogic Directory Server Administrator bind (login) name.

setTDBindName

Declaration

```
string setTDBindName(string s)
```

Operation

Sets the Telelogic Directory Server administrator bind (login) name.

Returns an error string if the current user is not the administrator.

setTDBindPassword

Declaration

```
string setTDBindPassword(string s)
```

Operation

Sets the Telelogic Directory Server administrator bind (login) password.

Returns an error string if the current user is not the administrator.

setTDBindPassword

Declaration

```
string setTDBindPassword(DB bind_pass)
```

Operation

Sets the Telelogic Directory Server administrator bind (login) password from the specified database.

getTDUseDirectoryPasswordPolicy

Declaration

```
bool getTDUseDirectoryPasswordPolicy()
```

Operation

Returns a flag indicating whether the directory should handle all password policy issues.

setTDUseDirectoryPasswordPolicy

Declaration

```
string setTDUseDirectoryPasswordPolicy(bool TD_dir)
```

Operation

Enables or disables support for the directory password policy.

Returns an error string if the current user is not the administrator.

Chapter 10

DOORS hierarchy

This chapter describes features that are relevant to items, folders, and projects within the DOORS hierarchy. Features specific to modules and objects are described in the following chapters:

- About the DOORS hierarchy
- Item access controls
- Hierarchy clipboard
- Hierarchy information
- Hierarchy manipulation
- Items
- Folders
- Projects
- Looping within projects

About the DOORS hierarchy

Within a DOORS database there are items, which can be **folders**, **projects**, and **modules**. A project is a special type of folder. The database root is also a folder.

In DXL, the DOORS hierarchy is represented by the data types `Item`, `Folder`, `Project`, and a call to the `module` function. Open modules are also represented by the `Module` data type.

Functions that operate on items have equivalents for folders, projects and modules.

Modules and folders are in general referenced by their unqualified names (without paths). However, DXL scripts can specify fully qualified names, which are distinguished by the inclusion of one or more slash (`/`) characters. These names can be either relative to the current folder, for example:

```
../folder/module
```

or absolute (with a leading slash), for example:

```
/folder/module
```

Create functions fail if an invalid (non-existent) path is specified.

Functions common to all hierarchy items are described in “Hierarchy clipboard,” on page 201, “Hierarchy information,” on page 204, and “Hierarchy manipulation,” on page 208.

Functions specific to items of type `Item` are described in “Items,” on page 210.

Functions specific to folders are described in “Folders,” on page 213.

Functions specific to projects are described in “Projects,” on page 216.

Functions specific to modules are described in “Modules,” on page 223.

Item access controls

This section describes functions that report on access rights for items.

canCreate (item)

Declaration

```
bool canCreate({Item i|Folder f})
```

Operation

Returns `true` if the current DOORS user has create access to the item or folder specified by the argument. Otherwise, returns `false`.

canControl (item)

Declaration

```
bool canControl({Item i|Folder f})
```

Operation

Returns `true` if the current DOORS user can change the access controls on the item or folder specified by the argument. Otherwise, returns `false`.

canRead (item)

Declaration

```
bool canRead({Item i|Folder f})
```

Operation

Returns `true` if the current DOORS user can read the item or folder specified by the argument. Otherwise, returns `false`.

canModify (item)

Declaration

```
bool canModify({Item i|Folder f})
```

Operation

Returns `true` if the current DOORS user can modify the item or folder specified by the argument. Otherwise, returns `false`.

canDelete (item)

Declaration

```
bool canDelete({Item i|Folder f})
```

Operation

Returns `true` if the current DOORS user can delete the item or folder specified by the argument. Otherwise, returns `false`.

Hierarchy clipboard

This section defines functions for the hierarchy clipboard. Passing a `null` argument of type `Item`, `Folder`, or `Project` to any function, or a `null` string to a call to the module function results in a run-time DXL error. The term `item` means a variable of type `Item`, type `Folder`, or type `Project`, or a call to the module function.

clipCut

Declaration

```
string clipCut(Item i)
```

Operation

Places a write lock on the item specified by the argument, and adds it to the clipboard as part of a set of cut items. If the write lock fails, or if the user does not have delete access to the item and its descendants (if any), the call to `clipCut` fails.

If the previous operation was not a cut, this function first clears the clipboard. If the item is deleted, returns an error message.

No other user can open the cut item until it has been pasted or the cut has been undone.

clipCopy

Declaration

```
string clipCopy(Item i)
```

Operation

Places a share lock on the item specified by the argument, and adds it to the clipboard as part of a set of copied items. If the share lock fails, or if the user does not have read access to the item, the call to `clipCopy` fails. Any descendants of the item to which the user does not have read access are not included as part of the set of items placed on the clipboard.

If the previous operation was a paste, this function first clears the clipboard. If the previous operation was a cut, this function first performs an undo. If the item is deleted, returns an error message.

No other user can move, delete or rename the item until it has been pasted or the copy has been undone.

clipClear

Declaration

```
string clipClear([bool force])
```

Operation

If the last operation was not a cut, unlocks and clears the clipboard contents. If the last operation was a cut, the result depends on the value of *force* as follows:

<code>false</code>	the call fails
<code>true</code>	purges the contents of the clipboard from the database.

If you omit *force*, its value is assumed to be `false`.

clipPaste

Declaration

```
string clipPaste(Folder folderRef)
```

Operation

Pastes the contents of the clipboard to *folderRef*. If the user does not have create access to the destination, the call to `clipPaste` fails. If *folderRef* is deleted, returns an error message.

If the previous operation was a cut, moves the contents of the clipboard from their original location, and places a share lock on them. Otherwise, unlocks the originals, and makes copies of them in *folderRef*. In this case, any projects have `Copy n of` in front of their names, because duplicate project names are not allowed. If this still results in duplicate names, `Copy n of` is used, where *n* is the lowest number ≥ 2 that prevents duplication. This function uses the same naming convention to avoid duplication when copying items into their original folder.

The items pasted from the clipboard remain share locked until the clipboard is cleared. This is done automatically when the client closes down, or when the user opens any module in the clipboard for exclusive edit, or deletes, renames, or moves any item in the clipboard.

clipUndo

Declaration

```
string clipUndo({Item i})
```

Operation

If the last operation was a cut or copy, unlocks and clears the clipboard contents.

clipLastOp

Declaration

```
int clipLastOp()
```

Operation

Returns an integer indicating the last operation performed on the hierarchy clipboard. The returned value can be of: Cut, Copy, Clear, Paste, Undo.

itemClipboardIsEmpty

Declaration

```
bool itemClipboardIsEmpty()
```

Operation

If there are no items in the hierarchy clipboard, returns `true`; otherwise, returns `false`.

inClipboard

Declaration

```
bool inClipboard({Item i|Folder f|Project p|Module m|ModName_ modRef})
```

Operation

If the item specified by the argument is in the hierarchy clipboard, returns `true`; otherwise, returns `false`.

Hierarchy information

This section defines functions that provide information about items, folders, projects, or modules. The term *item* means a variable of type `Item`, type `Folder`, type `Project` or type `ModName_`. You can also reference an open module using the data type `Module`. Passing a null argument of type `Item`, `Folder`, `Project`, `Module` or `ModName_` to any function results in a run-time DXL error.

folder, project, module (state)

Declaration

```
bool folder(string folderName)
bool project(string projectName)
bool module(string moduleName)
```

Operation

Returns `true` if the argument is the name of a folder, project, or module to which the current user has read access; otherwise, returns `false`.

Because a project is a special class of folder, the `folder` function returns `true` for projects as well as other folders.

description

Declaration

```
string description({Item i|Folder f|Project p|Module m|ModName_ modRef})
```

Operation

Returns the description of the item specified by the argument.

Example

```
print description current Module
```

name (item)

Declaration

```
string name({Item i|Folder f|Project p|Module m|ModName_ modRef})
```

Operation

Returns the unqualified name of the item specified by the argument.

Example

```
print name current Module
```

fullName (item)

Declaration

```
string fullName({Item i|Folder f|Project p|Module m|ModName_ modRef})
```

Operation

Returns the full name of the item specified by the argument, including the path from the nearest ancestor project, or if not inside a project, from the root folder.

path (item)

Declaration

```
string path({Item i|Folder f|Project p|Module m|ModName_ modRef})
```

Operation

Returns the full name of the parent of the item specified by the argument from the nearest ancestor project, or if not inside a project, from the root folder.

getParentFolder (item)

Declaration

```
Folder getParentFolder({Item i|Folder f|Project p|Module m|ModName_ modRef})
```

Operation

Returns the folder containing the item specified by the argument. If the argument is the root folder, returns null.

getParentProject (item)

Declaration

```
Project getParentProject({Item i|Folder f|Project p|Module m|ModName_ modRef})
```

Operation

Returns the nearest ancestor project for the item specified by the argument, or null if there is none. If the item is a project, this function does not return the project itself, but the nearest one above (or null if there is none).

isDeleted (item)

Declaration

```
bool isDeleted({Item i|Folder f|Project p|ModName_ modRef})
```

Operation

If the item specified by the argument is marked as deleted or soft deleted, or if it does not exist, or if the user does not have read access to it, returns `true`; otherwise, returns `false`.

setShowDeletedItems(bool)

Declaration

```
void setShowDeletedItems (bool show)
```

Operation

If bool `show` is set to `true`, deleted items will be visible in the Database Explorer. Setting `show` to `false` hides all deleted items.

type

Declaration

```
string type ({Item i|Folder f|Module m|ModName_ modRef})
```

Operation

Returns the type of the item specified by the argument as a string. Possible values are shown in the following table.

Return value	Item	Folder	Module
"Folder"	y	y	n
"Project"	y	y	n
"Formal"	y	n	y
"Link"	y	n	y
"Descriptive"	y	n	y

Example

```
print type(item "/")
```

uniqueID

Declaration

```
string uniqueID ({Item i|Folder f|Project p|ModName_ modRef|Module m})
```

Operation

Returns a unique identifier for the specified item, which lasts for the lifetime of the item, and is never reused. The unique identifier does not change when the item is moved or renamed. If the item is copied, the copy has a different identifier.

A call to this function where *i* does not exist causes a DXL run-time error.

qualifiedUniqueID

Declaration

```
string qualifiedUniqueID ({Item i|Folder f|Project p|ModName_ name|Module m})
```

Operation

Returns a representation of a reference to the specified `Item`, `Folder`, `Project`, `Module` or `ModName_`, which uniquely identifies that object amongst databases.

Provided that supported mechanisms for the creation of DOORS databases are used, these unique identifiers can be treated as globally unique; no two objects in any two databases will have the same `qualifiedUniqueID`.

See also `uniqueID`, which returns an unqualified representation of a reference.

getReference

Declaration

```
string getReference(Item referrer, Item referee)
```

Operation

Returns an opaque reference to the referee from the referrer. This reference is invariant under archive/restore (both inter-database and intra-database) and copy/paste. Such a reference is to be used in preference to the referee's index, unless the reference is intended to be variant under such operations.

itemFromReference

Declaration

```
Item itemFromReference(Item referrer, string ref)
```

Operation

Returns the item to which *ref* refers from the specified referrer. *ref* must be a string that was obtained using the `getReference()` perm. If the reference cannot be resolved, the returned item will satisfy null.

Example

Make a reference from the current module to an item named "a"

```
Item i = item fullName current Module
```

```
Item j = item "a"
```

```

// ri is a reference to i from i
string ri = getReference(i, i)

// rj is a reference to j from i
string rj = getReference(i, j)

print ri "\n"
print rj "\n"

```

These two references will never change when *i* and *j* are moved, copied (together), archived and restored (together).

```

Item ii = itemFromReference(i, ri) // get item that ri refers to *should be i*
Item jj = itemFromReference(i, rj) // get item that ri refers to *should be j*

```

Hierarchy manipulation

This section defines functions for item manipulation. All creation functions are specific to the type of item being created, but you can delete, undelete, purge, move, and rename items of all types using the Item handle. The term **item** means a variable of type `Item`, type `Folder`, type `Project` or type `ModName_`. You can also reference an open module using the data type `Module`. Passing a null argument of type `Item`, `Folder`, `Project`, `Module` or `ModName_` to any function results in a run-time DXL error.

delete (item)

Declaration

```

string delete({Item i|Folder f|Project p})

string delete(ModName_ &modRef
              [,bool hardDelete])

bool delete(ModName_ &modRef)

```

Operation

Marks the item specified by the argument as deleted. If the item is already marked as deleted, or if the user does not have delete access to it, the call fails.

The first and second forms return a null string on success; otherwise, an error message.

In the second form, the module is not purged if `hardDelete` is set to `false`. If `hardDelete` is `true` or missing, the module is purged. If the operation succeeds and the module is purged, also sets the `ModName_` argument to null.

The third form is retained for compatibility with earlier releases. It returns `true` on success; otherwise, `false`. This is equivalent to `hardDelete (module)` (the module need not be soft deleted). If the operation succeeds, also sets the `ModName_` argument to `null`.

For a folder or project, the user must also have delete access to all the undeleted folders, projects, and modules in it.

undelete (item)

Declaration

```
string undelete({Item i|Folder f|Project p|ModName_ modRef})
bool undelete (ModName_ modRef)
```

Operation

Marks the item specified by the argument as undeleted. If the item is not marked as deleted, or if the user does not have delete access to the item, the call fails.

The first form returns a null string on success; otherwise, an error message.

The second form is retained for compatibility with earlier releases. It returns `true` on success; otherwise, `false`.

For a folder or project, this function also marks as undeleted all folders, projects, and modules in it, to which the user has delete access.

Example

```
undelete item "my folder"
```

purge (item)

Declaration

```
string purge({Item &i|Folder &f|Project &p|ModName_ &modRef})
bool purge (ModName_ &modRef)
```

Operation

Purges the item specified by the argument from the database. If the operation succeeds, sets the argument to `null`. If the item is not marked as deleted, or if the user does not have delete access to the item, the call fails.

The first form returns a null string on success; otherwise, an error message.

The second form is retained for compatibility with earlier releases. It returns `true` on success; otherwise, `false`.

For a folder or project, the user must also have delete access to all the undeleted folders, projects, and modules in it.

For a `ModName_` argument, the function deletes all incoming and outgoing links before purging the module.

Example

```
purge item "my folder"
or
```

```
Item i = item "my folder"
purge i
```

move (item)

Declaration

```
string move({Item i|Folder f|Project p|ModName_ modRef}, Folder destination)
```

Operation

Moves the item specified by the first argument to folder *destination*. The folder can be any folder except the database root.

If the user does not have delete access to the item, or create access to the destination folder, the call fails.

If the operation succeeds, returns a null string; otherwise, returns a string describing the error.

Example

```
move(item "My Module", folder "/new projects")
```

rename (item)

Declaration

```
string rename({Item i|Folder f|Project
              p|ModName_ modRef},
              string name,
              string description)
```

```
bool rename (ModName_ modRef)
```

Operation

Renames the item specified by the first argument to *name* and associates it with *description*. The name argument must be an unqualified name. If the user does not have modify access to the item, the call fails.

The first form returns a null string on success; otherwise, an error message.

The second form is retained for compatibility with earlier releases. It returns `true` on success; otherwise, `false`.

Example

```
rename(folder "my folder", "public", "for review")
```

Items

This section defines functions and for loops for items, which make use of the `Item` data type. Passing a null argument of type `Item` to any function results in a run-time DXL error.

See also the functions in “Hierarchy clipboard,” on page 201, “Hierarchy information,” on page 204, and “Hierarchy manipulation,” on page 208.

item (handle)

Declaration

```
Item item(string itemName)
```

Operation

If *itemName* is the name of an item to which the current user has read access, returns a handle of type *Item*; otherwise, returns *null*.

itemFromID (handle)

Declaration

```
Item itemFromID(string uniqueID)
```

Operation

If *uniqueID* is the ID of an item to which the current user has read access, returns a handle of type *Item*; otherwise, returns *null*.

for item in folder

Syntax

```
for itemRef in folder do {
  ...
}
```

where:

<i>itemRef</i>	is a variable of type <i>Item</i>
<i>folder</i>	is a variable of type <i>Folder</i>

Operation

Assigns *itemRef* to be each successive undeleted item (for which the user has read access) in *folder*. Items in sub-folders are not included.

Example

```
Item i
for i in current Folder do {
  print (name i) "\n"
}
```

for all items in folder

Syntax

```
for itemRef in all folder do {
  ...
}
```

where:

itemRef is a variable of type Item
folder is a variable of type Folder

Operation

Assigns *itemRef* to be each successive item (for which the user has read access) in *folder*, including deleted items. Items in sub-folders are not included.

Example

```
Folder f = current
Item itemRef

for itemRef in f do {
    print fullName(itemRef) "\n"
}
```

for all items in project

Syntax

```
for itemRef in project do {
  ...
}
```

where:

itemRef is a variable of type Item
project is a variable of type Project

Operation

Assigns *itemRef* to be each successive undeleted item (for which the user has read access) in *project*, looping recursively through contained folders and projects.

Example

```
Item itemRef
for itemRef in current Project do
    print name(itemRef) "\n"
```

Folders

This section defines functions for folders.

See also the functions in “Hierarchy clipboard,” on page 201, “Hierarchy information,” on page 204, and “Hierarchy manipulation,” on page 208.

Setting current folder

The assignment operator = can be used as shown in the following syntax:

```
current = Folder folder
```

Makes *folder* the current folder, provided the user has read access to the folder. See also, the `current (folder)` function.

To set the current folder to the database root, use:

```
current = folder "/"
```

For large DXL programs, when you set the current folder, cast the current on the left hand side of the assignment to the correct type. This speeds up the parsing of the DXL program, so when your program is first run, it is loaded into memory quicker. It does not affect the subsequent execution of your program. So:

```
current = newCurrentFolder
```

becomes

```
(current FolderRef__) = newCurrentFolder
```

Note that this cast only works for assignments to current. It is not useful for comparisons or getting the value of the current folder.

current (folder)

Declaration

```
Folder current ()
```

Operation

Returns a handle on the current folder.

The current folder can be a project.

The current folder has two important implications:

- When you specify an item name, it is interpreted relative to the current folder.
- When you set the current folder using the assignment operator, you lock that folder and its ancestors, so that it cannot be renamed, deleted or moved.

The project or folder opened in the DOORS Explorer is similarly locked. If you open a DXL window or run another DXL script, that has its own current folder. The current folder for the DXL window is initially the current folder of its parent.

If all folders are closed, the database root becomes the current folder.

Example

```
Folder f = current
```

folder (handle)

Declaration

```
Folder folder(string folderName)
Folder folder(Item itemRef)
```

Operation

If the argument specifies a folder to which the current user has read access, returns a handle of type `Folder`; otherwise, returns `null`.

The string `"/` identifies the database root.

Example

This example sets the current folder to the database root:

```
current = folder "/"
```

convertProjectToFolder

Declaration

```
string convertProjectToFolder(Project projectRef, Folder &folderRef)
```

Operation

Converts the project *projectRef* to a folder *folderRef*. If the operation succeeds, sets *projectRef* to `null`, makes the folder argument valid, and returns a null string; otherwise, returns an error message. If the user does not have control access to the project or the create projects power (through `mayCreateTopLevelFolders`), the call fails.

Example

```
Project p = project "/Construction Project"
Folder f
string s = convertProjectToFolder ( p, f )
```

```

if (null s)
    print "Converted project " name(f) "to folder."
else
    print "Error: " s

```

convertFolderToProject

Declaration

```

string
convertFolderToProject(Folder folderRef,
                      Project &projectRef)

```

Operation

Converts the folder *folderRef* to a project *projectRef*. If the operation succeeds, sets *folderRef* to null, makes the project argument valid, and returns a null string; otherwise, returns an error message. If the user does not have control access to the folder or the create projects power (through `mayCreateTopLevelFolders`), the call fails.

Example

```

Folder f = folder "/Construction Project/test records"
Project p
string s = convertFolderToProject ( f, p )
if (null s)
    print "Converted folder " name(p) "to project."
else
    print "Error: " s

```

create (folder)

Declaration

```

Folder create(string name,
             string description)
string create(string name, description desc, Folder& f)

```

Operation

Creates a folder with the given *name* and *description*. The *name* argument can be an absolute or relative name, and may include the path. If the user does not have create access to the parent folder, the call fails.

The second form of the perm performs the same function as the first, but returns any error message, and passes the created folder back via the last argument.

closeFolder

Declaration

```
string closeFolder()
```

Operation

Changes the current folder to refer to the parent of the current folder. If the operation succeeds returns a null string; otherwise, returns a string describing the error.

Example

```
closeFolder()
```

Projects

This section defines operators, functions and for loops for projects, which make use of the `Project` data type. Passing a null argument of type `Project` to any function results in a run-time DXL error.

See also the functions in “Hierarchy clipboard,” on page 201, “Hierarchy information,” on page 204, and “Hierarchy manipulation,” on page 208.

Setting current project

The assignment operator `=` can be used as shown in the following syntax:

```
current = Project project
```

Makes *project* the current folder, and the current project, provided the user has read access to the folder. See also, the `current (project)` function.

If the current folder is a project, it is also the current project. If the current folder is not a project, the current project is the nearest project containing the current folder. If the current folder is not contained in a project, the current project is null.

For large DXL programs, when you set the current project, cast the current on the left hand side of the assignment to the correct type. This speeds up the parsing of the DXL program, so when your program is first run, it is loaded into memory quicker. It does not affect the subsequent execution of your program. So:

```
current = newCurrentProject
```

becomes

```
(current FolderRef__) = newCurrentProject
```

Note: This cast only works for assignments to `current`. It is not useful for comparisons or getting the value of the current project.

Example

```
current = project "/My Project"
```

current (project)

Declaration

```
Project current()
```

Operation

Returns a handle on the nearest ancestor project of the current folder, or null if the current folder is not in any project.

Example

```
Module m
// check project is open
if (null current Project) {
    ack "No project is open"
    halt
}
for m in current Project do {
    print "Module " m."Name" " is open"
}
```

project (handle)

Declaration

```
Project project(string projectName)
```

Operation

If *projectName* is the absolute or relative name of a project to which the current user has read access, returns a handle of type *Project* to the project; otherwise, returns null.

for project in database

Syntax

```
for project in database do {
    ...
}
```

where:

project is a variable of type *Project*

Operation

Assigns *project* to be each successive project (for which the user has read access) in the database, excluding deleted projects. Compare with `for all projects in database`.

Example

This example prints a list of projects in the database:

```
Project p
for p in database do {
    print(name p) "\n"
}
```

for all projects in database

Syntax

```
for name in database do {
    ...
}
```

where:

name is a string variable

Operation

Assigns the string *name* to be each successive project name (for which the user has read access) in the database, including deleted projects. Compare with `for project in database`.

Example

This example prints a list of projects in the database:

```
string s
for s in database do {
    print s "\n"
}
```

getInvalidCharInProjectName

Declaration

```
char getInvalidCharInProjectName(string s)
```

Operation

Returns any character in string *s* that would be invalid in a project name.

isDeleted (project name)

Declaration

```
bool isDeleted(string projectName)
```

Operation

If *projectName* is a project that has been deleted but not purged, or if it does not exist, or if the user does not have read access to it, returns `true`; otherwise, returns `false`.

This function is retained only for compatibility with earlier releases. New programs should use the `isDeleted (item)` function.

Example

```
Project p = project "Test Project"
if (!null p && !isDeleted p)
    current = p
```

isValidName

See “`isValidName`,” on page 230.

create(Project)

Declaration

```
Project create(string projName,
               string description
               [,string adminUser
               [,string password,
               string loginsystem,
               int passwordPolicy,
               int adminPolicy,
               string &message]])

string create(string name, description desc, Project& p)
```

Operation

Creates a project, *projName*, having *description*. The *adminUser* and following arguments are retained for compatibility with earlier releases; in DOORS 6.0, their values are ignored. However, a call to `create` that uses any of the legacy arguments sets the current folder to the new project (for compatibility with legacy DXL scripts, which expect the new project to be opened).

You must assign this function to a variable of type `Project`, otherwise, it tries to create a linkset between modules *projName* and *description*.

Administrator power is required for this function.

The second form of the perm performs the same function as the original perm, but returns any error message, and passes the created project back via the last argument.

Example

```
Project p = create("Test Project", "Play area for
DOORS")
```

closeProject

Declaration

```
void closeProject()
```

Operation

Sets the parent of the current project to be the new current folder. In DOORS 6.0, closing a project means changing the current folder.

Example

```
closeProject()
```

openProject

Declaration

```
string openProject(string projName  
                  [,string user,  
                   string pass])
```

Operation

Sets the named project as the current folder. The *user* and *password* arguments are retained for compatibility with earlier releases. In DOORS 6.0 they are ignored.

If the project opens successfully, returns null; otherwise returns an error message. If the project does not exist, or the user does not have read access to it, the call fails.

Example

```
string mess = openProject("Demo", "Catrina Magali", "aneblr")
```

doorsVersion

Declaration

```
string doorsVersion()
```

Operation

Returns the version of the current DOORS executable as a string.

Example

```
print doorsVersion
```

Looping within projects

The following sections describe the **for** loops available for looping within projects:

- for all items in project
- for open module in project
- for all modules in project
- for in-partition in project
- for out-partition in project
- for partition definition in project
- for trigger in project

Chapter 11

Modules

This chapter describes features that operate on DOORS modules:

- Module access controls
- Module references
- Module information
- Module manipulation
- Module display state
- Baselines
- Baseline Set Definition
- Baseline Sets
- History
- Descriptive modules
- Recently opened modules
- Module Properties

Module access controls

This section describes functions that report on access rights for a module. The module has to be open in exclusive edit mode.

canCreate (module)

Declaration

```
bool canCreate(Module m)
```

Operation

Returns `true` if the current DOORS user has create access to module *m*; otherwise, returns `false`.

canControl (module)

Declaration

```
bool canControl(Module m)
```

Operation

Returns `true` if the current DOORS user can change the access controls on module *m*; otherwise, returns `false`.

canModify (module)

Declaration

```
bool canModify (Module m)
```

Operation

Returns `true` if the current DOORS user can modify module *m*; otherwise, returns `false`.

canDelete (module)

Declaration

```
bool canDelete (Module m)
```

Operation

Returns `true` if the current DOORS user can delete module *m*; otherwise, returns `false`.

Module references

This section defines functions and for loops that make use of the `Module` data type.

See also the functions in “Hierarchy clipboard,” on page 201.

Setting current module

The assignment operator `=` can be used as shown in the following syntax:

```
current = Module module
```

Makes *module* the current module. See also, the `current (module)` function.

For large DXL programs, when you set the current module, cast the current on the left hand side of the assignment to the correct type. This speeds up the parsing of the DXL program, so when your program is first run, it is loaded into memory quicker. It does not affect the subsequent execution of your program. So:

```
current = newCurrentModule
```

becomes

```
(current ModuleRef__) = newCurrentModule
```

Note: This cast only works for assignments to `current`. It is not useful for comparisons or getting the value of the current module.

current (module)

Declaration

```
Module current()
```

Operation

Returns a reference to the current module. In some contexts `current` could be ambiguous, in which case it should be followed by `Module` in a cast.

Example

```
print (current Module)."Description" "\n"
```

module (handle)

Declaration

```
Module module(Item itemRef)
```

```
ModName_ module(string modRef)
```

Operation

The first form returns a handle of type `Module` for `itemRef` if `itemRef` is an open module. Otherwise, it returns `null`.

The second form returns a handle of type `ModName_` for the named module, whether it is open or closed.

for module in database

Syntax

```
for m in database do {
  ...
}
```

where:

m is a variable of type `Module`

Operation

Assigns the variable *m* to be each successive open module (for which the user has read access) in the database.

for open module in project

Syntax

```
for m in project do {
  ...
}
```

where:

m is a variable of type Module
project is a variable of type Project

Operation

Assigns the variable *m* to be each successive open module (for which the user has read access) in *project*. This loop includes modules in sub folders as well as those in the top level of the project. It does not include modules in projects that are contained in the project. This only works on the user's computer.

Example

```
Module m
int count = 0
for m in current Project do {
  print m."Name" "\n"
  count++
}
if (count==0)
  print "no modules in current project\n"
```

for all modules in project

Syntax

```
for moduleName in project do {
  ...
}
```

where:

moduleName is a string variable
project is a variable of type Project

Operation

Assigns the variable *moduleName* to be each successive module name (for which the user has read access) in *project*. This loop includes open or closed modules but only at the top level of the project. This is no longer everything contained in the project. This only works on the user's computer.

Example

```
string modName
for modName in current Project do
    print modName "\n"
```

for Module in Folder do

Syntax

```
for m in folder do {
    ...
}
```

where:

m is a variable of type Module

folder is a variable of type Folder

Operation

This provides access to all open modules that have the specified folder as their parent.

Example

```
Module m
Folder f = current
for m in f do {
    print "Module " (name m) " is open "\n"
}
```

Module information

This section defines functions that return information about DOORS modules.

See also the functions in “Hierarchy information,” on page 204.

Module state

Declaration

```
bool baseline (Module m)
bool exists (ModName_ modRef)
bool open (ModName_ modRef)
bool unsaved (Module m)
```

Operation

Each function returns true for a condition defined by the function name as follows:

Function	Returns true if
baseline	module <i>m</i> is a baseline; otherwise, returns false
exists	module <i>modRef</i> exists in the current project; otherwise, returns false
open	module <i>modRef</i> is open in any mode; otherwise, returns false
unsaved	module <i>m</i> has not been saved since changes were made; otherwise returns false

Example

```
string s = "/proj1/SRD"
Item i = item s
if (exists module s) print "and the system requirements ... \n"
if (open module s) print "SRD is open\n"
```

version

Declaration

```
string version (Module m)
```

Operation

Returns the version of open module *m* as a string.

Example

```
print (version current Module)
```

canRead, canWrite (module)

Declaration

```
bool canRead(Module m)
bool canWrite(Module m)
```

Operation

Returns whether the current DOORS user has read or write access to the top of open module *m*.

getSelectedCol

Declaration

```
bool getSelectedCol(Module m)
```

Operation

Returns the integer identifier for the currently selected column in *m*. If the specified module is not displayed, or no column is selected, returns -1.

isRead, isEdit, isShare

Declaration

```
bool isRead(Module m)
bool isEdit(Module m)
bool isShare(Module m)
```

Operation

Returns whether module *m* is open for reading, for editing or in shared mode. Otherwise, returns `false`.

These functions only return values for modules opened by the current user in the current session.

Example

```
Module m
for m in current Project do {
    if (isEdit m)
        print m."Name" " is open edit\n"
}
```

getInvalidCharInModuleName

Declaration

```
char getInvalidCharInModuleName(string s)
```

Operation

Returns any character in string *s* that would be invalid in a module name.

isValidDescription

Declaration

```
bool isValidDescription(string descString)
```

Operation

Returns *true* if *descString* is a legal description for a project, module, view or page layout; otherwise, returns *false*.

Example

This example returns *true*.

```
bool b = isValidDescription("Test Description")
```

isValidName

Declaration

```
{char|bool} isValidName(string nameString)
```

Operation

By default, returns the first illegal character of *nameString*. If you force a type *bool*, returns *true* if *nameString* is a legal name for a project, module, view or page layout; otherwise, returns *false*.

Example

This example returns *&*, the first illegal character in the name:

```
char c = isValidName("illegal&Name")
```

This example returns *true*:

```
char c = isValidName("legalName")
```

isValidPrefix

Declaration

```
bool isValidPrefix(string prefixString)
```

Operation

Returns `true` if *prefixString* is a legal prefix for an object; otherwise returns `false`.

Example

This example returns `true`:

```
bool b = isValidPrefix("PREFIX-1")
```

isVisible

Declaration

```
bool isVisible(Module m)
```

Operation

Returns `true` if module *m* is open for display on the screen. Otherwise, returns `false`.

Module manipulation

This section defines the functions for creating modules and performing database administration tasks on modules other than descriptive modules, which are covered in “Descriptive modules,” on page 274.

See also the functions in “Hierarchy manipulation,” on page 208.

create(formal module)

Declaration

```
Module create(string name,
              string desc,
              string prefix,
              int absno
              [,bool display])
```

```
string create(string name, description desc, prefix pref, int absnum, Module& m)
```

Operation

Creates a formal module with name *name*, description *desc*, object prefix *prefix* and starting absolute number *absno*. The *name* argument can be an absolute or relative path. The optional last argument controls whether the module is displayed in the GUI after it has been created.

The second form creates a formal module. However, in the case of an error which causes no module to be created, the error message is returned instead of generating a run-time DXL error.

create(descriptive module)

Declaration

```
string create(string name, description desc, prefix pref, int absnum, string
filename, Module& m)
```

Operation

Creates a Descriptive module. When an error occurs, which causes no module to be created, the error message is returned instead of generating a run-time DXL error.

create (link module)

Declaration

```
Module create(string name,
              string desc,
              int mapping
              [,bool display])

string create(string name, description desc, int mapping, Module& m)

const int manyToMany
const int manyToOne
const int oneToMany
const int oneToOne
```

Operation

Creates a link module with name *name*, description *desc*, and a mapping. The *name* argument can be an absolute or relative path. The *mapping* argument can take one of the following values: `manyToMany`, `manyToOne`, `oneToMany` or `oneToOne`. As with the creation of a formal module, the optional last argument controls whether the module is displayed in the GUI after it has been created.

The second form of the perm creates a Link module, similar to the perm `Module create(name, description, mapping)`, but returns error messages instead of generating a run-time DXL error.

close (module)

Declaration

```
bool close(Module m
           [,bool save])
```

Operation

Closes the open module *m*, with the option of saving changes. If *save* is `true`, the user is prompted to save before closing. If *save* is `false`, closes the module without saving. If the module is closed, the call fails.

If the operation fails, returns `false`. If `m` is a link module, `close` only succeeds if there are no loaded linksets and no other module is currently referring to the link module.

The DOORS object clipboard is cleared when a module is closed.

downgrade

Declaration

```
bool downgrade (Module m)
```

Operation

Sets the user's open mode for module `m` to read only, if it is open in edit or shareable mode. This allows other users to open it in shared mode, or one at a time in exclusive edit mode. If the operation succeeds, returns `true`; otherwise, returns `false`. If the module is closed, the call fails. When using this perm, the `save` perm should be used prior to `downgrade`, so that any changes to the module are preserved.

This function is not equivalent to checking whether the current user can modify the given object.

downgradeShare

Declaration

```
bool downgradeShare (Module m)
```

Operation

Sets the user's open mode for module `m` to shareable, if it is open in edit mode. This allows other users to open it in shared mode or read mode. If the operation succeeds, returns `true`; otherwise, returns `false`. If the module is closed, the call fails.

This function is not equivalent to checking whether the current user can modify the given object.

printModule

Declaration

```
void printModule (Module m)
```

Operation

Opens the print dialog box for the open module `m`.

Example

```
printModule current Module
```

read, edit, share (open module)

Declaration

```
Module read(string name
             [,bool disp[, bool loadStandardView]])
Module edit(string name
            [,bool disp[, bool silent[, bool loadStandardView]])
Module share(string name
             [,bool disp[, bool silent[, bool loadStandardView]])
```

Operation

These functions return a module handle for the module named *name*. The name argument can be an absolute or relative path. The `read` function opens the module for reading, `edit` for unshared editing, and `share` for shared editing. The optional *disp* flag allows the visibility of the opened module to be specified; the module is displayed in a window if *disp* is `true` or omitted.

The optional parameter *silent* specifies whether or not the user should be prompted when the module cannot be opened in the desired mode because of locks. If not supplied it is assumed to be `false`.

Using the optional parameter *loadStandardView* means you can force the standard view to be loaded as the default. If not supplied it is assumed to be `false`.

Note: If a module is open in a particular mode, that same module must not be opened in another mode, if the statement doing this is within a `for` loop.

Example

```
Module m = edit("/Car/Car user reqts", false)
```

save (module)

Declaration

```
void save(Module m)
```

Operation

Saves open module *m*.

copy (module)

Declaration

```
bool copy (ModName_ modRef,
           string newName,
           string newDesc)
```

Operation

Copies module *modRef* to new name *newName*, with description *newDesc*, within the same folder or project. All outgoing links are copied, but incoming links are not copied, and linksets are not updated.

hardDelete (module)

Declaration

```
bool hardDelete (ModName_ &modRef)
```

Operation

Removes module *modRef* from the database (compare with the `softDelete (module)` function); the module cannot be recovered with `undelete (item)` following this operation.

If the operation succeeds, sets the argument to null, and returns `true`; otherwise, returns `false`. If the user does not have delete access to the item, or if the module is open, the call fails.

The function `hardDelete` should be used instead of the `delete (item)` function, for all new programs.

Note: `softDelete` must be used on a module before using `hardDelete`.

softDelete (module)

Declaration

```
bool softDelete (ModName_ modRef)
```

Operation

Marks module *modRef* as deleted. The module is not actually deleted until it is purged. Modules marked for deletion can be recovered using the `undelete (item)` function.

When used interactively, a user who tries to use this function on a module with links has to confirm or cancel the operation. In batch mode no confirmation is required.

formalStatus

Declaration

```
void formalStatus (Module, String status)
```

Operation

Displays the supplied string in the third area of the status bar in the specified module, which must be a formal module. If the module is not a formal module a DXL run-time error is generated.

autoIndent

Declaration

```
bool autoIndent (Module)
```

```
void autoIndent (bool)
```

Operation

The first form returns true if auto-indentation for the main column in the specified module is currently turned on, otherwise it returns false.

The second form sets the auto-indentation status of the current module. The current module should be a formal module, otherwise a run-time DXL error will occur.

Example

```
print autoIndent current
```

Module display state

This section defines functions for getting and setting the display attributes of DOORS modules.

level (module get)

Declaration

```
int level (Module m)
```

Operation

Returns the display level of module *m*, which is between 0 (all levels) and 10.

level (module set)

Declaration

```
void level (int i)
```

Operation

Sets the display level of the current module. Argument *i* must be between 0 (all levels) and 10.

Get display state

Declaration

```
bool filtering (Module m)
bool graphics (Module m)
bool outlining (Module m)
bool showPictures (Module m)
bool showTables (Module m)
bool sorting (Module m)
```

Operation

Returns the current display state of attributes in open module *m*: graphics, filtering, outlining, visibility of pictures, visibility of tables, or sorting.

Example

```
Module m = current
int  storeLevel      = level m
bool storeGraphics   = graphics m
bool storeFiltering  = filtering m
bool storeOutlining  = outlining m
bool storeSorting    = sorting m
functionThatChangesDisplay
// now restore old settings
level storeLevel
graphics storeGraphics
filtering storeFiltering
outlining storeOutlining
sorting storeSorting
if (showTables current) {
    print "table contents are visible"
}
if (!showPictures current) {
    ack "Pictures are not visible"
}
```

Set display state

Declaration

```
void filtering(bool onOff)
void graphics(bool onOff)
void linksVisible(bool onOff)
void outlin{e|ing}(bool onOff)
void showPictures(bool onOff)
void showTables(bool onOff)
void sorting(bool onOff)
```

Operation

Turns on or off in the current module the attributes: filtering, graphics, visibility of links, outlining, visibility of pictures, visibility of tables and sorting.

Example

```
graphics on
graphics true
graphics off
showPictures true
showTables false
```

refresh

Declaration

```
void refresh(Module m)
```

Operation

Refreshes the display for open module *m*. DOORS refreshes the current module after the termination of a DXL script, however, scripts that change the displays of other modules, or that create dialog boxes, need to manage display updates explicitly with this function.

bringToFront

Declaration

```
string bringToFront([Module])
```

Operation

If a module is supplied it will bring that module window to the top, making it appear in front of other windows. If a module is not supplied it will bring the database explorer window to the front. Note that this will not bring windows to the front of modal dialogs.

Baselines

This section defines functions that operate on DOORS formal module baselines. The file:

```
$DOORSHOME/lib/dxl/Example/baseline.dxl
```

contains a baseline comparison program, which uses the functions described in this section.

Many of the functions use the data type `Baseline`.

Note: When retrieving information, e.g. annotation, from a baseline you must use them within a `for baseline in module loop`.

baseline

Declaration

```
Baseline baseline(int major,
                  int minor,
                  string suffix)
```

Operation

Returns a baseline handle for the combination of the specified *major* and *minor* version numbers and *suffix* string. If the baseline does not have a suffix, use `null`. This is only used to get a baseline handle for use in the baseline load perm. It cannot be used to retrieve information about that baseline, for example annotation information.

Example

```
Baseline b = baseline(1,0,"alpha")
```

baselineExists

Declaration

```
bool baselineExists(Module m,
                    Baseline b)
```

Operation

Returns `true` when baseline *b* exists in module *m*; otherwise returns `false`.

Example

```
print baselineExists(current Module, b)
```

create (baseline)

Declaration

```
void create([Module m,]
            Baseline b,
            string annot)
```

Operation

Creates a baseline for module *m* as specified by baseline handle *b* and annotation string *annot*. If the first argument is omitted, it uses the current module.

When this function is used to create a baseline, the module where the baseline is being created will be closed.

Use the `nextMajor`, `nextMinor` functions to instantiate the baseline handle.

delete (baseline)

Declaration

```
void delete([Module m,]
            Baseline b)
```

Operation

Allows deletion of baselines in formal modules. The first argument defaults to the current module.

Example

```
Baseline b = baseline(0, 1, "")
if (baselineExists(current Module, b)) delete(b)
```

Get baseline data

Declaration

```
int major(Baseline b)
int minor(Baseline b)
string suffix(Baseline b)
string annotation(Baseline b)
string user(Baseline b)
Date dateOf(Baseline b)
```

Operation

These functions return the various data fields associated with baseline *b*. All these functions are included in the “Baselines example program,” on page 243. They must be used within a `for baseline in module` loop.

getMostRecentBaseline

Declaration

```
Baseline
getMostRecentBaseline (Module m
                        [,bool lastbaseline])
```

Operation

Returns the last baseline. If *lastbaseline* is set to `true`, it returns the version number of the last baseline even if it has been deleted. Otherwise, it returns the last baseline that still exists.

Example

```
Module m = current
Baseline b = getMostRecentBaseline (m)
print (major b) "." (minor b) (suffix b) "
      " (annotation b) "\n"
```

getInvalidCharInSuffix

Declaration

```
char getInvalidCharInSuffix (string s)
```

Operation

Returns any character in string *s* that would be invalid in a baseline suffix.

load

Declaration

```
Module load ([Module m,]
            Baseline b,
            bool display)
```

Operation

Loads baseline *b* of module *m*; and if the last argument is `on` or `true`, displays it. If the first argument is omitted, it uses the current module.

Example

This example loads baseline 1.0 (without a suffix) of the current module, without displaying it.

```
load(baseline(1,0,null), false)
```

nextMajor, nextMinor

Declaration

```
Baseline nextMajor([string suffix])
```

```
Baseline nextMinor([string suffix])
```

Operation

Returns the next major or minor baseline, with or without a suffix.

Example

```
create(nextMajor, "alpha review")
create(nextMajor "A", "alpha review")
```

suffix

Declaration

```
Baseline suffix(string suffix)
```

Operation

Returns a new suffix version of the last baseline.

Example

```
create(suffix "AA", "no annotation")
```

for baseline in module

Syntax

```
for b in module do {
  ...
}
```

where:

b is a variable of type `Baseline`

module is a variable of type `Module`

Operation

Assigns the baseline *b* to be each successive baseline found for module *module*.

Example

```
Baseline b
for b in current Module do {
    print (major b) "." (minor b) (suffix b) "
        \t"
    print (user b) "\t " (dateOf b) "\n"
        (annotation b) "\n"
}
```

Baselines example program

```
// baseline DXL Example
/*
   Example of baseline DXL
*/
Baseline b
Module old = current
for b in current Module do {
    print(major b) "." (minor b) (suffix b) "
        "(annotation b) "\n"
    load(b, true)
    break          // just load first one
}
current = old     // reset
if (confirm "create example baseline?") {
    create(nextMajor, "annotation helps explain
                project history")
    // current Module is closed by create.
}
```

module(handle)

Declaration

```
ModName_ module(ModuleVersion modver)
```

Operation

This returns a handle of type `ModName_` for the given `ModuleVersion modver`. This gives access to information like name, description, etc. It returns null if the `ModuleVersion` does not reference an existing module to which the user has read access.

data(for ModuleVersion)

Declaration

```
Module data(ModuleVersion modver)
```

Operation

This returns the data for the given `ModuleVersion` if the user has it open, loaded into memory. Otherwise, it returns null.

load(ModuleVersion)

Declaration

```
Module load(ModuleVersion modver, bool display)
```

Operation

This loads the data (read-only mode) for the given `ModuleVersion`, if it references a current version or baseline to which the user has read access. If the `display` argument is `true`, then the baseline will be displayed. The perm returns the data on success, and null on failure. If the `ModuleVersion` argument is null, the perm will return null.

moduleVersion(handle)

Declaration

```
ModuleVersion moduleVersion(Module m)
```

```
ModuleVersion moduleVersion(ModName_ modRef[,Baseline b])
```

```
ModuleVersion moduleVersion(string index [,Baseline b])
```

Operation

The first form returns the `ModuleVersion` reference for the given module version. The module version must be open.

The second form returns the `ModuleVersion` reference for the given `ModName_`/`Baseline` combination. The reference is to the current version of the module if the `Baseline` argument is omitted.

The third form returns the `ModuleVersion` reference for the given `index`/`Baseline` combination. The reference is to the current version if the `Baseline` argument is omitted.

isBaseline(ModuleVersion|Module)

Declaration

```
bool isBaseline(ModuleVersion modver| Module m)
```

Operation

This returns `true` if, and only if, the given `ModuleVersion` or `module` represents a baseline of a module.

baselineInfo(current Module)

Declaration

```
Baseline baselineInfo(Module m)
```

Operation

This returns the baseline designation information of the specified open module *m*. Returns null if *m* is a current version.

baseline(ModuleVersion)

Declaration

```
Baseline baseline(ModuleVersion modver)
```

Operation

This returns a baseline handle with the major, minor and suffix settings extracted from the `ModuleVersion` *modver* supplied as an argument. The user, date and annotation will not be initialized. Returns null if *modver* corresponds to a current version.

baselineExists(ModuleVersion)

Declaration

```
bool baselineExists(ModuleVersion modver)
```

Operation

This returns `true` if, and only if, the baseline referenced by the `ModuleVersion` *modver* argument exists in the database and can be read by the user.

name(ModuleVersion)

Declaration

```
string name(ModuleVersion modver)
```

Operation

Returns the name of the module referenced by `ModuleVersion` *modver*. Returns null if *modver* does not refer to a module to which the user has read access.

fullName(ModuleVersion)

Declaration

```
string fullName(ModuleVersion modver)
```

Operation

Returns the full name, including path, of the module referenced by `ModuleVersion modver`. Returns null if `modver` does not refer to a module to which the user has read access.

versionString(ModuleVersion)

Declaration

```
string versionString(ModuleVersion modver)
```

Operation

Returns the version ID specified in the `ModuleVersion modver`, in the format `<major>.<minor>` where there is no suffix, or `<major>.<minor>(<suffix>)`. If `modver` specifies a current version, this perm returns null.

delete(Baseline)

Declaration

```
void delete([Module m,] Baseline b)
```

Operation

Deletes the specified baseline in a formal module. First argument defaults to the current module.

getMostRecentBaseline(Module)

Declaration

```
Baseline getMostRecentBaseline(Module m[, bool deleted])
```

Operation

Updated the `getMostRecentBaseline` perm to take an optional 2nd argument which if `true` directs the perm to return the version number of the last baseline even if it has been deleted. Otherwise, it returns the last baseline which still exists.

Baseline Set Definition

for BaselineSetDefinition in Folder

Declaration

for *baseSetDef* in *f*

where:

baseSetDef is a variable of type
BaselineSetDefinition

f is a variable of type Folder

Operation

This will return all Baseline Set Definitions *baseSetDef* whose descriptions are held in the given Folder *f*, which may also be a Project, to which the user has Read access. The Folder's Baseline Set Definition list is read from the database at the start of this iterator.

for BaselineSetDefinition in ModName_

Declaration

for *baseSetDef* in *modRef*

where:

baseSetDef is a variable of type BaselineSetDefinition

modRef is a variable of type ModName_

Operation

This returns all of the Baseline Set Definitions to which the user has Read access, which include the specified module in their lists.

create(BaselineSetDefinition)

Declaration

string create(Folder *f*, string *name*, string *desc*, BaselineSetDefinition &*bsd*)

Operation

This allows a user with Create access in the Folder to create a new Baseline Set Definition *bsd* with the given name and description. The new Baseline Set Definition will initially inherit its access controls from the folder. The name must conform to the constraints which apply to folder names, and must be unique across the other Baseline Set Definitions in that same folder. The description *desc* may be an empty string.

The newly created Baseline Set Definition is returned in the supplied *bsd* parameter.

The returned string will be non-null in the case that the Baseline Set Definition could not be created :

- If the name clashes with the name of some other Baseline Set Definition on that Folder
- Some i/o or lock error
- Insufficient access

In this case, no Baseline Set Definition will be created (the *bsd* reference will be set to null)

rename(BaselineSetDefinition)

Declaration

```
string rename(BaselineSetDefinition bsd, string newName)
```

Operation

This allows a user with Modify access to change the name of the Baseline Set Definition *bsd*. It returns null on success, and an error message on failure, including insufficient access, or the Baseline Set Definition not being locked for edit, or the name not being unique in that Folder.

name(BaselineSetDefinition)

Declaration

```
string name(BaselineSetDefinition bsd)
```

Operation

This returns the name of the given Baseline Set Definition *bsd*.

setDescription(BaselineSetDefinition)

Declaration

```
string setDescription(BaselineSetDefinition bsd, string desc)
```

Operation

This allows a user with Modify access to change the description of the Baseline Set Definition. It returns null on success, and an error message on failure, including insufficient access.

A lock on the Baseline Set Definition is required to change the description of that Baseline Set Definition. This lock must be acquired using the lock() perm.

description(BaselineSetDefinition)

Declaration

```
string description(BaselineSetDefinition bsd)
```

Operation

This returns the description text for the given Baseline Set Definition *bsd*. If the Baseline Set Definition's information has not been read, this will cause the information to be read from the database.

for module in BaselineSetDefinition

Declaration

```
for modRef in bsd do {
    ...
}
```

where:

<i>modRef</i>	is a variable of type <code>ModName_</code>
<i>bsd</i>	is a variable of type <code>BaselineSetDefinition</code>

Operation

This returns references to all modules (to which the user has Read access) which are included in the Baseline Set Definition *bsd*. If the Baseline Set Definition information has not been read, this will cause the information to be read from the database. Modules that have been deleted (but not purged) are included in the list of modules returned by this iterator.

addModule(BaselineSetDefinition)

Declaration

```
string addModule(ModName_ modRef, BaselineSetDefinition bsd)
```

Operation

This allows a user with Modify access to add a module to the Baseline Set Definition's list, if the Baseline Set Definition *bsd* is locked by the user. It will return a string on error, for example if the user does not have Modify access to the Baseline Set Definition or a lock on the Baseline Set Definition.

removeModule(BaseLineSetDefinition)

Declaration

```
string removeModule (ModName_ modRef, BaselineSetDefinition bsd)
```

Operation

This allows a user with Modify access to remove a module from the Baseline Set Definition's list, if the Baseline Set Definition *bsd* is locked by the user.

delete(BaselineSetDefinition)

Declaration

```
string delete (BaselineSetDefinition &bsd)
```

Operation

This allows a user with Delete access to delete a Baseline Set Definition from its parent folder. Once a Baseline Set Definition has been deleted, it cannot be undeleted. On success, the argument Baseline Set Definition will be set to null. A Baseline Set Definition cannot be deleted if another user has it locked for editing.

lock(BaselineSetDefinition)

Declaration

```
string lock (BaselineSetDefinition bsd)
```

Operation

If the user has Modify access to the Baseline Set Definition *bsd*, this places an exclusive editing lock on it, and reads the information on the Baseline Set Definition from the database. It also ensures that there is a share-lock on its parent folder. Only one session can have a lock at any one time on a Baseline Set Definition, and only a session with a lock can save or modify the Baseline Set Definition, or create a Baseline Set from it. A Baseline Set Definition cannot be modified without it being locked.

Moreover, changes will not be saved to the database until and unless the user performs a save (`BaselineSetDefinition`).

Notice that it is the responsibility of the programmer to call `unlock (BaselineSetDefinition)` in order to release a Baseline Set Definition lock acquired by `lock (BaselineSetDefinition)`.

unlock(BaselineSetDefinition)

Declaration

```
string unlock (BaselineSetDefinition bsd)
```

Operation

This unlocks a locked Baseline Set Definition *bsd*, and unlocks its parent Folder if that isn't held locked for some other reason. If changes have been made and not saved since the Baseline Set Definition was locked, the Baseline Set Definition information will be read again from the database.

save(BaselineSetDefinition)

Declaration

```
string save(BaselineSetDefinition bsd)
```

Operation

This saves the user's Baseline Set Definition information to the database, as long as the user has an editing lock on the Baseline Set Definition. It returns null on success, and an error message on failure.

read(BaselineSetDefinition)

Declaration

```
string read(BaselineSetDefinition bsd)
```

Operation

This reads the current Baseline Set Definition *bsd* information from the database, and does not require a lock.

If the Baseline Set Definition is locked, and unsaved changes have been made to it, those changes will be lost when `read()` is called.

isAnyBaselineSetOpen(BaselineSetDefinition)

Declaration

```
bool isAnyBaselineSetOpen(BaselineSetDefinition bsd)
```

Operation

Returns `true` if the `BaselineSetDefinition` has an open baseline set associated with it, and `false` if it does not. A null argument results in a run-time error.

get(BaselineSetDefinition)

Declaration

```
AccessRec get(BaselineSetDefinition bsd, string user, string &message)
```

Operation

On success, this returns the access record for the Baseline Set Definition *bsd* for the specified user. If *user* is null, the default access will be returned. The *&message* string is null on success, and set to an error message on failure.

inherited(BaselineSetDefinition)

Declaration

```
string inherited(BaselineSetDefinition bsd)
```

Operation

Allows the user to set the Baseline Set Definition *bsd* to inherit its access controls from its parent Folder.

specific(BaselineSetDefinition)

Declaration

```
string specific(BaselineSetDefinition bsd)
```

Operation

If the Baseline Set Definition *bsd* has inherited access rights, this gives it specific access rights, with their initial values inherited from its parent Folder.

isAccessInherited(BaselineSetDefinition)

Declaration

```
string isAccessInherited(BaselineSetDefinition bsd, bool &inherited)
```

Operation

This sets the inherited argument *true* or *false* depending on whether the Baseline Set Definition's access rights are inherited. It returns null on success, and an error message on failure.

set(BaselineSetDefinition)

Declaration

```
string set(BaselineSetDefinition bsd, Permission ps, string user)
```

Operation

This sets a specific access permission for a given *user*. If *user* is null, then it sets a default access permission. It returns null on success, and an error string on failure.

unset(BaselineSetDefinition)

Declaration

```
string unset(BaselineSetDefinition bsd, string user)
```

Operation

This removes specific access rights for the given *user* on BaselineSetDefinition *bsd*. If *user* is null, then it sets a default access permission. It returns null on success, and an error string on failure.

unsetAll(BaselineSetDefinition)

Declaration

```
string unsetAll(BaselineSetDefinition bsd)
```

Operation

This removes all specific access rights from the Baseline Set Definition *bsd*. It returns null on success, and an error message on failure.

for access record in Baseline Set Definition

Declaration

```
for ar in bsd do {
    ...
}
```

where:

ar is a variable of type AccessRec

bsd is a variable of type
BaselineSetDefinition

Operation

This returns all the specific access right records for the specified Baseline Set Definition.

for access record in all Baseline Set Definition

Declaration

```
for ar in all bsd do {
    ...
}
```

```
}

```

where:

ar is a variable of type `AccessRec`

bsd is a variable of type `BaselineSetDefinition`

Operation

Iterates over the access records of the applicable ACL for the specified Baseline Set Definition.

Example 1

```
void createBSD()
// creates a BSD containing all the Formal modules in the current Folder
{
    BaselineSetDefinition newBSD = null
    string bsdName = (name current Folder) " modules"
    string bsdDesc = "All modules in this folder"
    string errmess
    errmess = create(current Folder, bsdName, bsdDesc, newBSD)
    if (!null errmess)
    {
        errorBox "Unable to create a new Baseline Set Definition: " errmess
        return
    }
    errmess = lock(newBSD)
    if (!null errmess)
    {
        errorBox "Cannot lock new Baseline Set Definition: " errmess
        return
    }

    // Add modules
    Item i
    ModName_ mod
    for i in current Folder do
    {
        if (type(i) == "Formal")

```

```

    {
        mod = module(fullName i)
        {
            if (!null mod)
            {
                errmess = addModule(mod, newBSD)
                if (!null errmess)
                {
                    errorBox "Could not add module " name(mod) ": " errmess
                }
            }
        }
    }
}

errmess = save(newBSD)
if (!null errmess)
{
    errorBox "Failed to save Definition: " errmess
}

unlock(newBSD)
}

```

createBSD

Example 2

```

void printBSDs()
// prints a list of Baseline Set Definitions in the current Folder
// and a list of modules in each Baseline Set Definition
{
    BaselineSetDefinition bsd

    for bsd in current Folder do
    {
        print name(bsd) ": " description(bsd) "
    }
}

```

```

    string errmess = read(bsd)
    if (!null errmess)
    {
        print "    [Could not read Definition: " errmess "]"
    }
    else if (isEmpty(bsd))
    {
        print "    [Empty Baseline Set Definition]"
    }
    else
    {
        ModName_ mod
        for mod in bsd do
        {
            print "    " (fullName mod) "
        }
    }
    print ""
}

printBSDs

```

Baseline Sets

for BaselineSet in BaselineSetDefinition

Declaration

```

for bs in bsd do {
    ...
}

```

```
}

```

where:

```
bs           is a variable of type BaselineSet
bsd         is a variable of type BaselineSetDefinition

```

Operation

This returns the Baseline Sets, in order of creation, which have been created from a given Baseline Set Definition.

isBaselinePresent(BaselineSet)

Declaration

```
bool isBaselinePresent(BaselineSet bs, ModName_ modRef)
```

Operation

This returns `true` if, and only if, a baseline of the module referenced by `modRef` is in the `BaselineSet bs`.

create(Baseline Set)

Declaration

```
string create(BaselineSetDefinition bsd, bool major, string suffix, string
annotation, BaselineSet &bs)
```

Operation

This allows a user with `Create` access to create a new (Open) Baseline Set `&bs` from the Baseline Set Definition `bsd`. If `major` is `true`, the version of the Baseline Set will be a new major version number; else it will be a new minor version number. This fails if the Baseline Set Definition is not locked by the user, or if there is already an Open baseline set for it.

The returned string will be null on success, with `&bs` assigned to the baseline set so created. Otherwise, the returned string will be non-null and will contain some description of the failure, in this case `&bs` will be set to null.

major(BaselineSet)

Declaration

```
int major(BaselineSet bs)
```

Operation

This returns the major version number of a Baseline Set `bs`.

minor(BaselineSet)

Declaration

```
int minor(BaselineSet bs)
```

Operation

This returns the minor version number of a Baseline Set *bs*.

suffix(BaselineSet)

Declaration

```
string suffix(BaselineSet bs)
```

Operation

This returns the suffix (may be null) in the version identifier of the Baseline Set *bs*.

versionID(BaselineSet)

Declaration

```
string versionID(BaselineSet bs)
```

Operation

This returns the whole version identifier of the Baseline Set *bs* in the form `major.minor[(suffix)]`.

annotation(BaselineSet)

Declaration

```
string annotation(BaselineSet bs)
```

Operation

This returns the comment annotation which has been stored with a Baseline Set *bs*.

user(BaselineSet)

Declaration

```
string user(BaselineSet bs)
```

Operation

This returns the name of the user who created the Baseline Set *bs*.

dateOf(BaselineSet)

Declaration

```
Date dateOf(BaselineSet bs)
```

Operation

This returns the date/time when the Baseline Set *bs* was created.

isOpen(BaselineSet)

Declaration

```
bool isOpen(BaselineSet bs)
```

Operation

This returns `true` for an Open Baseline Set *bs*, and `false` for a Closed one.

close(baselineSet)

Declaration

```
string close(BaselineSet bs)
```

Operation

This closes an Open Baseline Set *bs*. It requires the user to have a lock on the Baseline Set Definition, and returns null on success, and an error message on failure (e.g. if the Baseline Set is not Open, or the user does not hold a lock on the Baseline Set Definition).

setAnnotation(BaselineSet)

Declaration

```
string setAnnotation(BaselineSet bs)
```

Operation

This allows a user with Modify access to the Baseline Set Definition to change the annotation text on an Open Baseline Set *bs*. It returns null on success, and an error string on failure (e.g. if `BaselineSet` is Closed). This should fail if the user does not have a lock on the Baseline Set Definition.

addBaselines(BaselineSet)

Declaration

```
string addBaselines(Skip modList, BaselineSet bs)
```

Operation

This allows a user with Modify access to the Baseline Set Definition to baseline a set of modules and add the baselines to an Open Baseline Set. The variable *modList* is a skip list containing values of type *modName_*. These modules must be included in the Baseline Set Definition which defines the Baseline Set, and must not already be contained in the Baseline Set. It returns null on success, and an error message on failure (e.g. if the BaselineSet is Closed). It fails without creating or adding any baselines if the user cannot add all of them. It fails if the user does not hold a lock on the Baseline Set Definition.

for ModuleVersion in BaselineSet

Declaration

```
for modver in bs do {
    ...
}
```

where:

<i>modver</i>	is a variable of type <code>ModuleVersion</code>
<i>bs</i>	is a variable of type <code>BaselineSet</code>

Operation

This returns references to all of the baselines, to which the user has Read access, in the Baseline Set.

for ModuleVersion in all BaselineSet

Declaration

```
for modver in all bs do {
    ...
}
```

where:

<i>modver</i>	is a variable of type <code>ModuleVersion</code>
<i>bs</i>	is a variable of type <code>BaselineSet</code>

Operation

This returns references to all baselines in the Baseline Set and all modules which could have been included in the Baseline Set, to which the user has Read access, and which have not been purged.

for BaselineSet in ModName_

Declaration

```
for bs in modRef do {
    ...
}
```

where:

bs is a variable of type `BaselineSet`

modRef is a variable of type `ModName_`

Operation

This returns any open Baseline Sets to which the current version of the specified module can currently be baselined.

baselineSet(ModuleVersion)

Declaration

```
BaselineSet baselineSet (ModuleVersion modver)
```

Operation

This returns the Baseline Set, if there is one and the user has Read access to it, which contains the given `ModuleVersion` *modver*.

Example 1

```
void printModuleBSDs ()
// prints a list of Baseline Set Definitions which include the current Module
// and a list of Baseline Sets created for each Definition
{
    if (null current Module)
    {
        errorBox "This DXL must be run from a current Module."
        return
    }
}
```

```

BaselineSetDefinition bsd
ModName_ mod = module(current Module)
for bsd in mod do
{
    print name(bsd) ": " description(bsd) "\n"

    string errmess = read(bsd)
    if (!null errmess)
    {
        print "    [Could not read Definition: " errmess "]"
    }
    else if (isEmpty(bsd))
    {
        print "    [Empty Baseline Set Definition]"
    }
    else
    {
        BaselineSet bs
        for bs in bsd do
        {
            print versionID(bs) ": " annotation(bs) ""

            print "Created by " user(bs) " on " dateOf(bs) ""

            ModuleVersion mv
            for mv in bs do
            {
                print "    " (fullName mv) " [" (versionString mv) "]"

            }
        }
    }
    print "\n"
}

```

```

}
printModuleBSDs

```

Example 2

```

void baselineModuleToSets()
// Adds a new baseline of the current module to any open
// Baseline Set that can include it. Creates a new Baseline Set
// for definitions that include the module but do not have an
// open Baseline Set.
{
    if (null current Module)
    {
        errorBox "This DXL must be run from a current Module."
        return
    }

    string errmess
    BaselineSetDefinition bsd
    BaselineSet bs
    ModName_ mod = module(current Module)
    int skipIndex = 0
    Skip moduleSkip = create
    put (moduleSkip, skipIndex++, mod)

    for bsd in mod do
    {
        print ""

        if (!isAnyBaselineSetOpen(bsd))
        {
            print "Creating new Baseline Set: "

            errmess = lock(bsd)
            if (null errmess)
            {

```

```

        errmess = create(bsd, true, "new", "Created by
baselineModuleToSets()", bs)
    }

    if (!null errmess)
    {
        print "Failed to create Baseline Set: " errmess "

        continue
    }
    unlock(bsd)
}
else
{
    for bs in bsd do
    {
        if (isOpen bs)
        {
            break
        }
    }
}

if (isBaselinePresent(bs, mod))
{
    print "Module is already in the Open Baseline Set."
}
else
{
    errmess = addBaselines(moduleSkip, bs)
    if (null errmess)
    {
        print "Added baseline to Baseline Set " versionID(bs)
    }
}

```

```

        }
        else
        {
            print "Failed to add baseline to Baseline Set: " errmsg
        }
    }
}
}
}
baselineModuleToSets

```

History

This section defines DXL functions for manipulating history records. Three main data types are introduced:

<code>History</code>	a history record
<code>HistoryType</code>	a type of history
<code>HistorySession</code>	a summary of a module's session history. Every time a DOORS module is opened in either edit or shareable mode, a session summary is saved. You can access this information using the functions that act on an object of type <code>HistorySession</code> .

You can only access objects of type `History` and `HistoryType` using the `for history record in type loop`.

You can only access an object of type `HistorySession` using the `for history session in module loop`.

Constants (history type)

Declaration

```

const HistoryType unknown
const HistoryType createType
const HistoryType modifyType
const HistoryType deleteType
const HistoryType createAttr
const HistoryType modifyAttr
const HistoryType deleteAttr

```

```

const HistoryType createObject
const HistoryType copyObject
const HistoryType modifyObject
const HistoryType deleteObject
const HistoryType undeleteObject
const HistoryType purgeObject
const HistoryType clipCutObject
const HistoryType clipMoveObject
const HistoryType clipCopyObject
const HistoryType createModule
const HistoryType baselineModule
const HistoryType partitionModule
const HistoryType acceptModule
const HistoryType returnModule
const HistoryType rejoinModule
const HistoryType createLink
const HistoryType modifyLink
const HistoryType deleteLink
const HistoryType insertOLE
const HistoryType removeOLE
const HistoryType changeOLE
const HistoryType pasteOLE
const HistoryType cutOLE
const HistoryType readLocked

```

Operation

These constants represent the different types of history record.

Concatenation (history type)

The space character is the concatenation operator, which is shown as `<space>` in the following syntax:

```
HistoryType ht <space> string s
```

Concatenates the string *s* onto the history type *ht*, and returns the result as a string.

History properties

Properties are available for use in combination with the `.` (dot) operator to extract information from a history record. The syntax for using the properties is:

hr.property

where:

hr is a variable of type `History`

property is one of the history properties

The value of *property* can be one of the following:

String property	Extracts
<code>attrName</code>	attribute name of history record
<code>author</code>	author of history record
<code>newPosition</code>	new position of history record
<code>position</code>	current position of history record
<code>type</code>	type of history record; this can be one of the values listed in “Constants (history type),” on page 265
<code>typeName</code>	type name of history record

Date property	Extracts
<code>date</code>	date of history record

Integer property	Extracts
<code>absNo</code>	absolute number of history record
<code>numberOfObjects</code>	number of objects in history record
<code>oldAbsNo</code>	old absolute number of history record
<code>sessionNo</code>	tracks the manipulation of history information

Any appropriate type property	Extracts
<code>newValue</code>	new value of user defined attribute
<code>oldValue</code>	old value of user defined attribute

Example

```

print hr.type
print hr.date
print hr.author
print hr.attrName
print hr.typeName
print hr.position
print hr.newPosition
print hr.numberOfObjects
print hr.absNo
print hr.oldAbsNo
print hr.sessionNo
Date histDatOld = hr.oldValue
Date histDateNew = hr.newValue

```

goodStringOf

Declaration

```
string goodStringOf(HistoryType ht)
```

Operation

Returns a string to represent the history type *ht* in the GUI, for example, "Create Object" for the `createObject` history type.

stringOf (history type)

Declaration

```
string stringOf(HistoryType ht)
```

Operation

Returns the history type *ht* as a string.

print (history type)

Declaration

```
void print(HistoryType ht)
```

Operation

Prints the history type *ht* in the DXL Interaction window's output pane.

for history record in type

Syntax

```
for hr in type do {
  ...
}
```

where:

<i>hr</i>	is a variable of type <code>History</code>
<i>type</i>	is a variable of type <code>Module</code> , object of type <code>Object</code> , or a call to the function <code>top</code>

Operation

Assigns the variable *hr* to be the history records for modules, objects, or top-level items. Top-level items are those module history records that apply to the whole module, not individual objects. The syntax for looping through top-level items is as follows:

```
for hr in top(module) do { ... }
```

where *module* is of type `Module`.

Example

This example prints out the type of each top level history record of the current module:

```
History h
for h in top current Module do print h.type
```

number (history session)

Declaration

```
int number(HistorySession hs)
```

Operation

Returns an identifier that is unique within the parent module for a particular session, starting from 0.

when

Declaration

```
Date when(HistorySession hs)
```

Operation

Returns the timestamp for a particular session.

who

Declaration

```
string who(HistorySession hs)
```

Operation

Returns the name of the DOORS user responsible for a particular session (who opened the module).

baseline (history session)

Declaration

```
string baseline(HistorySession hs)
```

Operation

If a baseline was created during a particular session, returns the details in the format `version (suffix)`.

diff(buffer)

Declaration

```
string diff(Buffer result, Buffer source, Buffer target, string removeMarkup,  
insertMarkup)
```

```
string diff(Buffer result, Buffer source, Buffer target)
```

```
string diff(Buffer result, Buffer source, Buffer target, bool fullRTF)
```

Operation

Computes the annotated difference, or "redlined difference" between source and target.

The result is valid only when a non-null string is returned.

Removals and insertions are annotated by `removeMarkup` and `insertMarkup` -- this must be well-formed RTF strings onto which subsequent text may be concatenated. The standard values for these are `"\cf1\strike "` and `"\cf2\u1 "` (notice the spaces). See `diff/3` for a perm which uses these defaults.

Three colors are defined and may be used within these commands: RED, GREEN and BLUE:

```
\cf1 - RED
\cf2 - GREEN
\cf3 - BLUE
```

For the third form of the perm, When `true`, the RTF returned as a result is full RTF (containing the correct RTF header, font table and color table). When `false`, the returned result is an RTF fragment, suitable for adding or inserting into a full RTF stream.

Example

```
DB db = create "Show diff"
DBE textbox = richText(db, "stuff", "", 200, 200, true)
Buffer buff1 = create()
Buffer buff2 = create()
Buffer resBuf = create()

buff1 = "Old Text"
buff2 = "New Text"
diff(resBuf, buff1, buff2, "\\cf1\\strike ", "\\cf3\\ul ")
realize db
useRTFColour(textbox, true)
set(textbox, tempStringOf resBuf)
show db

delete resBuf
delete buff1
delete buff2
```

Example

```
Buffer one = create
one = "one"
Buffer two = create
two = "two"
Buffer result = create

diff(result, one, two, false)
print stringOf(result) "\n\n"
diff(result, one, two, true)
```

```
print stringOf(result)
```

Output:

```
{\cf1\strike one}{\cf3\ul two}
```

```
{\rtf1\deff1000{\fonttbl{\f1012\fswiss\fcharset177 Arial;}{\f1011\fswiss\fcharset162
Arial;}{\f1010\fswiss\fcharset238 Arial;}{\f1009\fswiss\fcharset204 Arial;}{\f1008\fswiss\fcharset161
Arial;}{\f1007\fswiss\fcharset0 Arial;}{\f1006\froman\fcharset177 Times New
Roman;}{\f1005\froman\fcharset162 Times New Roman;}{\f1004\froman\fcharset238 Times New
Roman;}{\f1003\froman\fcharset204 Times New Roman;}{\f1002\froman\fcharset161 Times New
Roman;}{\f1001\fttech\fcharset2 Symbol;}{\f1000\froman\fcharset0 Times New Roman;}}{\colortbl
;\red255\green0\blue0;\red0\green255\blue0;\red0\green0\blue255;}{\cf1\strike one}{\cf3\ul two}}}
```

for history session in module

Syntax

```
for hs in module do {
  ...
}
```

where:

hs is a variable of type `HistorySession`

module is a variable of type `Module`

Operation

Assigns the variable *hs* to be each successive history session record for the specified module.

Example

```
HistorySession hs
// process module
for hs in current Module do
{
  // identifier, date and user
  print number(hs) ", " when(hs) ", " who(hs)
  string sBaseline = baseline(hs)
  // only relevant if baseline info exists
```

```

    if (sBaseline != null)
    {
        // baseline name
        print " - '" sBaseline "' : "
    }
    print "\n"
}

```

History example program

```

// history DXL Example
/*
  Example history DXL program.
  Generate a report of the current Module's
  history.
*/
// print a brief report of the history record
void print(History h) {
    HistoryType ht = h.type
    print h.author "\t" h.date "\t" ht "\t"
    if (ht == createType ||
        ht == modifyType ||
        ht == deleteType) { // attribute type
        print h.typeName
    } else if (ht == createAttr ||
               ht == modifyAttr ||
               ht == deleteAttr) {
        // attribute definition
        print h.attrName
    } else if (ht == createObject ||
               ht == clipCopyObject ||
               ht == modifyObject) { // object
        print h.absNo
        if (ht==modifyObject) {
            // means an attribute has changed
            string oldV = h.oldValue
            string newV = h.newValue
            print " (" h.attrName ":" oldV " -> "
                newV ")"
        }
    }
    print "\n"
}

```

```
// Main program
History h
print "All history\n\n"
for h in current Module do print h
print "\nHistory for current Object\n\n"
for h in current Object do print h
print "\nNon object history\n\n"
for h in top current Module do print h
```

Descriptive modules

This section defines DXL functions for DOORS descriptive modules.

create (descriptive module)

Declaration

```
Module create(string name,
              string description,
              string prefix,
              int absno,
              string filename)
```

Operation

Creates a new descriptive module based on a valid module name and an accessible text file.

If the operation succeeds, returns a reference to the new module; otherwise, returns null.

Example

```
Module m = create("Source", "source documentation", "S", 1, "c:\\docs\\source.txt")
```

markUp

Declaration

```
Object markUp(Object o,
              int firstchar,
              int lastchar)
```

Operation

Marks up a range of object text in a descriptive module, as defined by *firstchar* and *lastchar*.

If the operation succeeds, returns a reference to the newly marked up object; otherwise, returns a reference to the unmarked up object.

If *firstchar* is 1 or less, the range begins at the first character.

If *lastchar* is greater than the number of characters in the specified object, the range ends with the last character in the object.

If *firstchar* is greater than the number of characters in the object, or if *lastchar* is less than 1, or less than *firstchar*, the extracted object contains no text.

Example

This example marks up the 2nd, 3rd and 4th characters in the current object:

```
markUp (current Object, 2, 4)
```

undoMarkUp

Declaration

```
void undoMarkUp(Object o)
```

Operation

Changes a descriptive module object *o* from being a marked up object to being an unmarked up object. If *o* does not refer to a marked-up object, the function has no effect.

Example

```
undoMarkUp(current object)
```

setUpExtraction

Declaration

```
bool setUpExtraction(Module m,
                     string formal,
                     string link)
```

Operation

Sets up the descriptive module *m* for the extraction of marked up objects to the formal module *formal*, with links between the source objects and the extractions stored in the link module *link*.

For a successful operation *formal* must be open in edit mode, and *link* must be available for editing.

If the operation is successful, it returns `true`; otherwise, it returns `false`.

Example

```
print setUpExtraction(current Module, "Formal mod", "DOORS Links")
```

extractAfter

Declaration

```
void extractAfter(Object source)
```

Operation

Extracts the marked-up object *source* to a new object after the current object in the formal module as specified by *setUpExtraction*.

If the extraction has been incorrectly set up, the function displays a run-time error message is displayed and performs no extraction.

If the extraction is successful, the new object in the formal module becomes the current object.

Example

```
Module desc = create("Desc mod", "descriptive module", "D", 1, "c:\\info.txt")
Object obj=markUp(current Object 2,22)
edit "Formal module"
setUpExtraction(desc, "Formal module", "Link module")
extractAfter(obj)
```

extractBelow

Declaration

```
void extractBelow(Object source)
```

Operation

Performs the same operation as *extractAfter*, but inserts the new object below the current object in a formal module.

Example

```
Module desc = create ("Desc mod", "descriptive module", "D", 1, "c:\\info.txt")
Object obj=markUp(current Object 2,22)
edit "Formal module"
setUpExtraction(desc, "Formal module", "Link module")
extractBelow(obj)
```

Recently opened modules

This section defines DXL functions to access and manipulate the list of recently opened modules.

recentModules

`recentModules` is a new data type representing the list of recently opened modules.

addRecentlyOpenModule(ModuleVersion)

Declaration

```
void addRecentlyOpenModule (ModuleVersion ModVer)
```

Operation

Adds an entry into the recently opened modules list for the supplied module version.

addRecentlyOpenModule(string)

Declaration

```
void addRecentlyOpenModule (string)
```

Operation

Constructs a module version from the supplied string, then adds an entry in the recently opened modules list for that module version.

removeRecentlyOpenModule(ModuleVersion)

Declaration

```
void removeRecentlyOpenModule (ModuleVersion ModVer)
```

Operation

Removes the entry for the supplied module version from the recently opened modules list.

for {string|ModuleVersion} in recentModules

Operation

Loops through the list of recently opened modules and returns the string representing uniqueID, including baseline version string, or `ModuleVersion`, for each module.

Syntax

```
for {str|mv} in recentModules do {
    ...
}
```

where:

str is a variable of type `string`
mv is a variable of type `ModuleVersion`
recentModules is the list of recently opened modules

Example

```
// This example loops through the list of recently opened modules. It checks for
// the presence of two modules, if the first is found it is removed, if the
//second is found it is added.
```

```
ModuleVersion mod1 = moduleVersion("00000023")
ModuleVersion mod2 = moduleVersion("00000021")
ModuleVersion mod
```

```
bool found1 = false
bool found2 = false
```

```
for mod in recentModules do {

    if (mod == mod1){
        found1 = true
    } else if (mod == mod2){
        found2 = true
    }
}

if (found1){
    removeRecentlyOpenModule mod1
}

if (!found2){
    addRecentlyOpenModule mod2
}
```

Module Properties

ModuleProperties

`ModuleProperties` is a new data type representing the properties of a module. It consists of type definitions, attribute definitions, and module attribute values. As with object and module types the `.` (dot) operator can be used to extract attribute value

getProperties

Declaration

```
string getProperties(ModuleVersion mv, ModuleProperties &mp)
```

Operation

Loads type definitions, attribute definitions and module attribute values from the specified `ModuleVersion` into the specified `ModuleProperties`.

find (attribute definition in ModuleProperties)

Declaration

```
AttrDef find(ModuleProperties mp, string AttrName)
```

Operation

Returns the attribute definition from the specified `ModuleProperties` whose name matches the supplied string.

for string in ModuleProperties

Syntax

```
for str in modprops do {
...
}
```

where:

<i>str</i>	is a variable of type <code>String</code>
<i>modprops</i>	is a variable of type <code>ModuleProperties</code>

Operation

Assigns *str* to be the name of each successive module attribute in *modprops*.

for AttrType in ModuleProperties

Syntax

```
for at in modprops do {
...
}
where:
```

<i>at</i>	is a variable of type AttrType
<i>modprops</i>	is a variable of type ModuleProperties

Operation

Assigns *at* to be each successive module attribute type definition in *modprops*.

Example

```
ModuleProperties mp
ModuleVersion mv
string mname = "/My Project/Module1"
string s

mv = moduleVersion(module mname)

string err1 = getProperties (mv, mp)

if (!null err1){
    print err1 "\n"
}

AttrType at
print "Module Types: \n"
```

```
for at in mp do {
    print "\t - " (at.name) "\n"
}

print "\nModule Attributes: \n"
for s in mp do {
    print "\t - " s " : "
    val = mp.s""
    print val "\n"
}
```

Chapter 12

Electronic Signatures

This chapter describes:

- Signature types
- Controlling Electronic Signature ACL
- Electronic Signature Data Manipulation
- Examples

Signature types

`struct SignatureInfo {}`

A new type representing signature information.

`struct SignatureEntry {}`

A new type representing individual signatures. A `SignatureEntry` is aggregated into exactly one `SignatureInfo` object.

Controlling Electronic Signature ACL

All access control operations operate on the Electronic Signature information that has been read from the database. Therefore, read operations return results reflecting what was in effect when the data was last refreshed from the database. The data is refreshed by calling `getSignatureInfo`.

Write operations may result in changes to the access controls, but the access control perms do not commit those changes to the database. Instead, the DXL programmer must explicitly save any changes in order for them to be committed.

`SignatureInfoSpecifier__ specifier(SignatureInfo)`

Declaration

```
SignatureInfoSpecifier__ specifier(SignatureInfo si)
```

Operation

This converter has a `Ref` implementation. It is an interface selector. It is used for getting and setting permissions for users to change the signature label specifier type for a baseline. It uses the same perms that are used for setting permissions to change the `SignatureInfo` itself (the rest of the signature configuration). The label specifier is an enumerated type defined in the module, which can have values like **signed off**, **rejected**, etc.

For example, if you have a `SignatureInfo` variable, say `sigInfo`, which has been initialized using `getSignatureInfo`, to give you a handle on the signature configuration for a particular baseline, then you get access controls on the signature list using:

- `string username`
- `string access`
- `AccessRec ac = get(sigInfo, username, access)`

Access controls on the label specifier can be retrieved using:

- `AccessRec ac2 = get(specifier sigInfo, username, access)`

hasPermission(SignatureInfo, Permission)

Declaration

```
bool hasPermission(SignatureInfo si, Permission& p)
```

Operation

Returns `true` if the current user has permission `p` to the Signatory ACL of the `SignatureInfo` object `si`.

hasPermission(SignatureInfoSpecifier__, Permission)

Declaration

```
bool hasPermission(SignatureInfoSpecifier__ sis, Permission& p)
```

Operation

Returns `true` if the current user has permission `p` to the Specifier ACL of the `SignatureInfo` object `si`. The `specifier()` perm is used to cast a `SignatureInfo` object into a `SignatureInfoSpecifier__` object.

hasPermission(string, SignatureInfo, Permission)

Declaration

```
bool hasPermission(string name, SignatureInfo si, Permission& p)
```

Operation

Returns `true` if the string `name` has permission `p` to the Signatory ACL of the `SignatureInfo` object `si`.

hasPermission(string, SignatureInfoSpecifier__, Permission)

Declaration

```
bool hasPermission(string name, SignatureInfoSpecifier__ sis, Permission& p)
```

Operation

Returns true if the string *name* has permission *p* to the Specifier ACL of the SignatureInfo object *si*. The specifier () perm is used to cast a SignatureInfo object into a SignatureInfoSpecifier__ object.

::do(AccessRec&, SignatureInfo, void)

Declaration

```
void ::do(AccessRec& ar, SignatureInfo si, void)
```

Operation

Iterator over Signatory ACL of the SignatureInfo object *si*.

::do(AccessRec&, SignatureInfoSpecifier__, void)

Declaration

```
void ::do(AccessRec& ar, SignatureInfoSpecifier__ sis, void)
```

Operation

Iterator over Specifier ACL of the SignatureInfo object *si*.

set(SignatureInfo, Permission, string name)

Declaration

```
string set(SignatureInfo si, Permission& p, string name)
```

Operation

Sets the Signatory ACL so that string *name* has Permission *p*.

set(SignatureInfoSpecifier__, Permission, string name)

Declaration

```
string set(SignatureInfoSpecifier__ sis, Permission& p, string name)
```

Operation

Sets the Specifier ACL so that string *name* has Permission *p*.

unset(SignatureInfo, string name)

Declaration

```
string unset(SignatureInfo si, string name)
```

Operation

Sets the Signatory ACL so that string *name* has the default access.

unset(SignatureInfoSpecifier__, string name)

Declaration

```
string unset(SignatureInfoSpecifier__ sis, string name)
```

Operation

Sets the Specifier ACL so that string *name* has the default access.

unsetAll(SignatureInfo)

Declaration

```
string unsetAll(SignatureInfo si)
```

Operation

Sets Signatory ACL so that all agents have the default access

unsetAll(SignatureInfoSpecifer__)

Declaration

```
string unsetAll(SignatureInfoSpecifer__ sis)
```

Operation

Sets the Specifier ACL so that all agents have the default access

AccessRec get(SignatureInfo, string name, string& error)

Declaration

```
AccessRec get(SignatureInfo si, string name, string& error)
```

Operation

Returns the access record from the Signatory ACL for string *name*. Returns a non-null string if there is an error.

Electronic Signature Data Manipulation

getSignatureInfo(SignatureInfo si&, ModName_ document, int major, int minor, string suffix)

Declaration

```
string getSignatureInfo(SignatureInfo si&, ModName_ document, int major, int
minor, string suffix)
```

Operation

Returns in *si* (destructively modifying its contents) a signature information object on the specified baseline *document* (module, with version information). In case of error, a non-null string will be returned, otherwise the null string will be returned.

If the baseline does not exist, this generates an error.

If the baseline does exist, a valid `SignatureInfo` object will be assigned to *si* and populated with data read from the database. The `isConfigured()` method will return `true`. If the baseline does not have a `SignatureInfo` object associated with it, a new one is created. The `isConfigured()` method returns `false`, and the `SignatureInfo` will contain some default values which are dependant on the last configuration specified for that module.

If there is signature information contained in the database for this baseline, that data will be read from the database and *si* will then reflect that data, at the time of the call to `getSignatureInfo`. Changes subsequently made to the database by other sessions will not be reflected in *si* until a further call to `getSignatureInfo` is made.

Since this perm destructively modifies the contents of *si*, any changes that have been made to *si* (for example, a call to `setLabelSpecifier`), are lost. Changes to a `SignatureInfo` object may be committed to the database by the `save` perm.

isBaselineSignatureConfigured(SignatureInfo)

Declaration

```
bool isBaselineSignatureConfigured(SignatureInfo si)
```

Operation

Returns whether the `SignatureInfo` has been configured, i.e. if signature Access Controls or signatures have been saved for the associated baseline. See `getSignatureInfo()` for more details.

Note: This perm does not refresh the `SignatureInfo` object from the database.

getLabelSpecifier(SignatureInfo)

Declaration

```
string getLabelSpecifier(SignatureInfo si)
```

Operation

Returns the signature label specifier. Does not refresh the signature information from the database.

setLabelSpecifier(SignatureInfo si, string newLabel)

Declaration

```
string setLabelSpecifier(SignatureInfo si, string newLabel)
```

Operation

Sets the signature label specifier of the supplied *si* to be the supplied *newLabel*. May fail and return a non-null error message if the current user does not have modify access conferred by the Specifier ACL.

This change to the label specifier is not committed to the database until the `save(SignatureInfo&)` method is called.

appendSignatureEntry(SignatureInfo si, string label, string comment)

Declaration

```
string appendSignatureEntry(SignatureInfo si, string label, string comment)
```

Operation

Appends the signature of the current user to the database signature information of the baseline associated with *si*. This perm is only available when there is a GUI. It will return an error string otherwise. It prompts the user to reconfirm their username and password, and if this reconfirmation is successful, appends and commits this new signature entry to any existing signatures that may be present in the database.

The `label` argument will be stored with the signature, and may be used to classify the signature. The baseline signature DXL constrains the user to select the label from the enumeration values of the module's label specifier type.

The `labelOptions` argument is intended to contain a newline-separated list of labels available to the user at the time of sign off, as enforced by the calling DXL code.

The `comment` argument is intended to store any comments that the signatory wishes to record with the signature.

This perm returns an error when executed from a DOORSnet client session, or when DOORS is running in batch mode.

A side-effect of this perm is to refresh *si* (as would `getSignatureInfo`) so that it reflects the data that has been committed to the database. As a consequence, any `SignatureEntry` objects derived from *si* will be invalidated. Also, any non-committed changes to *si* will be lost (use the `save` perm to commit changes before appending a signature).

Since this operation refreshes *si*, it is possible that the right to sign a baseline will be lost due to a change to the Signatory ACL. In this case an error message will be returned.

save(SignatureInfo si, int &code)

Declaration

```
string save(SignatureInfo si, int &code)
```

Operation

Save signature information *si* to the database. Returns a non-null string if it fails, in which case the value of code will be set to indicate the reason for failure.

On success, this perm writes the specified signature information to the database. Any changes that were made to this signature information since it was refreshed (via `getSignatureInfo`) will be committed to the database.

It is not necessary to call `save` in order to commit changes made by calls to `appendSignatureEntry`. This perm commits those changes before it returns.

Changes made to signature information that do require an explicit call to `save()` are:

- `setLabelSpecifier()`
Any change to access controls

Returned error codes:

- out of sequence commit
- other error

An out-of-sequence commit code arises when an attempt is made to commit changes based on an out-of-date read of the signature information. The code will be set to "2" in all other failure cases.

A side-effect of this perm is to refresh *si* (as would `getSignatureInfo`) so that it reflects the data that has been committed to the database. As a consequence, any `SignatureEntry` objects derived from *si* will be invalidated.

::do(SignatureEntry&, SignatureInfo, void)

Declaration

```
void ::do(SignatureEntry& sigentry, SignatureInfo si, void)
```

Operation

Iterator over each signature entry in the `SignatureInfo` object *si*. The signature entries so obtained are read-only.

The entities will be enumerated in the order in which they were appended to the `SignatureInfo`.

Note: This order is independent from the stored dates of the entries.

The signature entries so obtained will be invalidated by execution of any of the following perms on the same `SignatureInfo` object

- `getSignatureInfo`
- `save`
- `appendSignatureEntry`

As a result, these should not be called when `SignatureEntry` objects remain in scope.

`getUserName(SignatureEntry)`

Declaration

```
string getUserName(SignatureEntry sigentry)
```

Operation

Returns the signatory's user name for the given signature entry.

`getUserFullName`

Declaration

```
string getUserFullName (SignatureEntry sigentry)
```

Operation

Returns the signatory's full user name for the given signature entry.

`getEmail(SignatureEntry)`

Declaration

```
string getEmail(SignatureEntry sigentry)
```

Operation

Returns the e-mail address of the signatory for the given signature entry.

`Date getDate(SignatureEntry)`

Declaration

```
Date getDate(SignatureEntry sigentry)
```

Operation

Returns the signing date for the given signature entry.

Note: This function returns the GMT date/time of the signature and, when formatted to a string, will show the signature time in the time zone of the viewer, not of the signatory.

Date getLocalDate(SignatureEntry)

Declaration

```
Date getLocalDate(SignatureEntry sigentry)
```

Operation

Returns the signing date of the given signature entry, offset to compensate for the time zones of the signatory and viewer.

getFormattedLocalDate(SignatureEntry)

Declaration

```
string getFormattedLocalDate(SignatureEntry sigentry)
```

Operation

Returns a string representing the date and time of the specified signature in the time zone of the signatory, not the current viewer.

getLabel(SignatureEntry)

Declaration

```
string getLabel(SignatureEntry sigentry)
```

Operation

Returns the label, if any, for the given signature entry.

getLabelOptions(SignatureEntry)

Declaration

```
string getLabelOptions(SignatureEntry sigentry)
```

Operation

Returns a formatted string representing the choices of label entry available to the signatory at the time of signing.

getComment(SignatureEntry)

Declaration

```
string getComment(SignatureEntry sigentry)
```

Operation

Returns the comment contained in a signature entry. This may be the empty string.

allAttributesReadable(SignatureEntry)

Declaration

```
bool allAttributesReadable(SignatureEntry sigentry)
```

Operation

Returns a boolean indicating if the signatory had read access to all attributes on the signed baseline.

getIsValid(SignatureEntry)

Declaration

```
bool getIsValid(SignatureEntry sigentry)
```

Operation

Returns a boolean value indicating whether the signature hash is still valid for the stored signature entry. This may be used to verify the integrity of signature data.

Examples

Add a signature to the latest baseline of the current module

```
// Example signatures code - add a signature to the latest baseline of the
current module.
```

```
Baseline thisBaseline = getMostRecentBaseline(current Module)
if (null thisBaseline || (null load(thisBaseline,true)))
{
    warningBox "No baseline available"
    halt
}
```

```
DB signatureDB
DBE addTypeChoice, addAddBtn, addCommentsText
```



```

SignatureInfo sigInfo
int enumCount = 0
int majorVersion = major(thisBaseline)
int minorVersion = minor(thisBaseline)
string suffix = suffix(thisBaseline)

//*****
void addAddCB(DBE x)
// DESCRIPTION : Callback for "OK" button on add signature
// dialog. Calls appendSignatureEntry perm to prompt the user
// to re-authenticate.
// On error, presents a warning box to the user.
// RETURNS : void
{
    string labelString = get(addTypeChoice)
    string commentString = get(addCommentsText)
    string optionsString = ""
    int i
    for (i = 0; i < enumCount; i++)
    {
        if (i > 0)
        {
            optionsString = optionsString "\n"
        }
        optionsString = optionsString get(addTypeChoice,i)
    }

    string message =
appendSignatureEntry(sigInfo,labelString,optionsString,commentString)
    if (!null message)
    {
        warningBox(signatureDB,"Signature not added: " message "")
    }
} // addAddCB

```

```

// First, read the SignatureInfo for the baseline..
string message = getSignatureInfo(sigInfo,module(fullName current
Module),majorVersion,minorVersion,suffix)
if (!null message)
{
    warningBox("getSignatureInfo failed: " message "")
    halt
}

// Create the dialog to allow the user to select a label and add a comment.
signatureDB = create("Add Signature",styleFixed)
string labelType = getLabelSpecifier(sigInfo)
AttrType at = null
enumCount = 0

// Get current list of labels from the current version of the module
if (!null labelType)
{
    Module currentVersion = read(fullName current Module,false)

    if (!null currentVersion)
    {
        at = find(current Module, labelType)
    }
    if (null at)
    {
        warningBox("Cannot find label specifier type \"" labelType "\".")
        halt
    }
    else if (at.type "" != "Enumeration")
    {
        warningBox("Label specifier is not an enumerated type.")
        halt
    }
}

```

```

        else
        {
            enumCount = at.size
        }
    }

string labelChoices[enumCount]

if (enumCount > 0)
{
    // Get alternative labels from the enumerated type.
    int index
    for (index = 0; index < enumCount; index++)
    {
        labelChoices[index] = at.strings[index]
    }
}

// Create the choice element for the user to select a label.
addTypeChoice = choice(signatureDB,"Signature Label: ",labelChoices,0,20,false)
if (enumCount == 0)
{
    inactive addTypeChoice
}

addCommentsText = text(signatureDB,"Comments:", "",400,150,false)
addAddBtn = button(signatureDB,"OK",addAddCB,styleStandardSize)

show signatureDB

```

list signatures in the latest baseline

```

// Signatures example code : list signatures in the latest baseline
// of the current module

```

```

if (null current Module)
{
    warningBox "Must run from an open module."
    halt
}

Baseline b = getMostRecentBaseline(current Module)
if (null b || (null load(b,true)))
{
    warningBox "No baseline available"
    halt
}
string dummy[] = {}

DB signaturesDB = create("Baseline Signatures Example",styleFixed)
SignatureInfo signatureInfo = null

DBE timeCombo, sigListView, commentText
DBE labelLabel, labelList, closeBtn
string timeChoices[] = {"signatory's","current"}
DBE timeLabel

static int SIGNATORY_COL = 0
static int DATE_COL = 1
static int LABEL_COL = 2

//*****
void listSignature(SignatureEntry sigEntry, int i, bool localTimes)
// DESCRIPTION : adds an entry in the listView for a given signatureEntry
// RETURNS : void
{
    insert(sigListView,i,getUsername(sigEntry),null,iconUser)
    if (localTimes)

```

```

    {
        set(sigListView,i,DATE_COL,(dateOf intOf getLocalDate(sigEntry)) "")
    }
else
{
    set(sigListView,i,DATE_COL,(dateOf intOf getDate(sigEntry)) "")
}
set(sigListView,i,LABEL_COL,getLabel(sigEntry))
}

//*****
void refreshListView(void)
// DESCRIPTION : Populates sigListView with the info in signatureInfo
// RETURNS : void
// ERROR CONDITIONS : null signatureInfo - returns without any action
{
    if (null signatureInfo)
    {
        return
    }

    int i = get(timeCombo)
    bool localTimes = (i == 0)

    int entryNumber
    empty sigListView
    entryNumber = 0
    SignatureEntry sigEntry
    for sigEntry in signatureInfo do
    {
        listSignature(sigEntry,entryNumber,localTimes)
        entryNumber++
    }
} // void refreshListView(void)

```

```

//*****
void closeDB(DB x)
// DESCRIPTION : close function for the signature dialog. Hides it.
// RETURNS : void
{
    hide signaturesDB
    halt
}

//*****
void closeDB(DBE x)
// DESCRIPTION : close function for the signature dialog. Hides it.
// RETURNS : void
{
    closeDB(signaturesDB)
}

//*****
void refreshSigsDB()
// DESCRIPTION : refreshes the signatures list with the signature info from
//               the database, in the specified baseline.
// RETURNS : void
{
    ModName_ thisModule = module (fullName current Module)

    string message = getSignatureInfo(signatureInfo, thisModule, major(b),
minor(b), suffix(b))
    set(commentText, "")
    set(labelList, "")
    if (!null message)
    {
        warningBox(signaturesDB, "Cannot display signatures for this baseline:
" message "\nThe baseline signature dialogue will be closed.")
    }
}

```

```

        closeDB(signaturesDB)
    }
    else
    {
        refreshListView()
    }
} // refreshSigsDB

//*****
void timeComboCB(DBE x)
// DESCRIPTION : Callback for the time-zone selection combo
// RETURNS : void
{
    refreshListView()
}

//*****
void sigDeselectCB(DBE x, int selectedEntry)
// DESCRIPTION : Deselect callback for listView - null-op.
// RETURNS : void
{
}

//*****
void sigSelectCB(DBE x, int selectedEntry)
// DESCRIPTION : Selection callback for signatures list
// RETURNS : void
{
    int indexScan = 0
    SignatureEntry sigEntry
    for sigEntry in signatureInfo do
    {

```

```

        if (indexScan == selectedEntry)
        {
            set (commentText, getComment (sigEntry))
            set (labelList, getLabelOptions (sigEntry))
            break
        }
        indexScan++
    }
} // sigSelectCB

// DEFINE MAIN DIALOG
sigListView = listView(signaturesDB, 0, 405, 8, dummy)
set (sigListView, sigSelectCB, sigDeselectCB, sigSelectCB)
timeCombo=choice(signaturesDB, "Display time at", timeChoices, 0, 9, false)
set (timeCombo, timeComboCB)
beside signaturesDB
timeLabel = label(signaturesDB, "location.")
below signaturesDB
commentText = text(signaturesDB, "Comments:", "", 100, 100, true)
labelList = text(signaturesDB, "Available labels:", "", 160, 100, true)

// BUTTONS
close (signaturesDB, true, closeDB)

realize signaturesDB
insertColumn (sigListView, SIGNATORY_COL, "Signatory", 150, iconNone)
insertColumn (sigListView, DATE_COL, "Date / Time", 150, iconNone)
insertColumn (sigListView, LABEL_COL, "Label", 100, iconNone)

refreshSigsDB ()
show signaturesDB

```

Chapter 13

Objects

This chapter describes features that operate on DOORS objects:

- About objects
- Object access controls
- Finding objects
- Current object
- Navigation from an object
- Object management
- Information about objects
- Selecting objects
- Object searching
- Miscellaneous object functions

About objects

Functions manipulate DOORS objects via the `Object` data type. An important property of a DOORS formal module is that the objects within the module are structured as a tree; the functions for creating and navigating objects therefore use the following tree terminology:

parent	the object immediately above an object
child	any object immediately below an object
sibling	any object that shares a parent with another object

Object DXL can be found in nearly every example DXL program given in this manual or in the DXL library.

Object access controls

This section describes functions that report on access rights for an object. For all except the `canRead (object)` function, the module must be open for exclusive edit.

canCreate (object)

Declaration

```
bool canCreate(Object o)
```

Operation

Returns `true` if the current DOORS user has create access to object `o`; otherwise, returns `false`.

canControl (object)

Declaration

```
bool canControl(Object o)
```

Operation

Returns `true` if the current DOORS user can change the access controls on object `o`; otherwise, returns `false`.

canRead (object)

Declaration

```
bool canRead(Object o)
```

Operation

Returns `true` if the current DOORS user can read object `o`; otherwise, returns `false`.

canModify (object)

Declaration

```
bool canModify(Object o)
```

Operation

Returns `true` if the current DOORS user can modify object `o`; otherwise, returns `false`.

canDelete (object)

Declaration

```
bool canDelete(Object o)
```

Operation

Returns `true` if the current DOORS user can delete object `o`; otherwise, returns `false`.

canLock (object)

Declaration

```
bool canLock(Object o)
```

Operation

Returns `true` if the current DOORS user can lock object `o`, which must be in a lockable section. It returns `false` for the following conditions:

- `o` is null
- `o` is contained within a module that is currently open read-only
- `o` is contained within a module that is currently open for exclusive edit
- `o` is not contained within a formal module
- the user does not have create or modify access to the object at the start of `o`'s editable section

canUnlock (object)

Declaration

```
bool canUnlock(Object o)
```

Operation

Returns `true` if the current DOORS user can unlock object `o`, which must be in a lockable section. It returns `false` for the following conditions:

- `o` is null
- `o` is contained within a module that is currently open read-only
- `o` is contained within a module that is currently open for exclusive edit
- `o` is not contained within a formal module
- the user does not currently have `o` locked

Finding objects

This section defines functions that allow DXL programs to navigate through the objects in a module.

object (absno)

Declaration

```
Object object(int absno[,Module m])
```

Operation

Returns the object with the specified absolute number. If no module argument is supplied, the current module is searched.

all

This function is used in a `for` loop operating on modules, as shown in the following syntax:

```
all (Module module)
```

Returns a handle for *module* (see the `for object in all` loop).

document

This function is used in a `for` loop operating on modules, as shown in the following syntax:

```
document (Module module)
```

Returns a handle for *module* (see the `for object in document` loop).

entire

This function is used in a `for` loop operating on modules, as shown in the following syntax:

```
entire (Module module)
```

Returns a handle for *module* (see the `for object in entire` loop).

module (containing object)

Declaration

```
Module module (Object o)
```

Operation

Returns the module that contains object *o*.

top

This function is used in `for` loops operating on projects and modules, as shown in the following syntax:

```
top (Module module)
```

Returns a handle for *module* (see the loops `for history record in type` and `for object in top`).

for object in all

Syntax

```
for o in all(module) do {
  ...
}
```

where:

o is a variable of type Object
module is a variable of type Module

Operation

Assigns the variable *o* to be each successive object in *module*. It includes table and row header objects and the cells.

This loop respects the current display set; an object is only returned if it is displayed under the current filter, level setting, and so on. Deleted objects are included when they are visible and excluded when they are not visible. This is the case for all deleted objects except deleted table header objects, which are always displayed. Object numbering depends on whether deleted objects are displayed. If they are displayed, they are numbered. If they are not displayed, they are not numbered.

Example

```
Object o
for o in all current Module do {
  print identifier o "\n"
}
```

for object in entire

Syntax

```
for o in entire(module) do {
  ...
}
```

where:

o is a variable of type Object
module is a variable of type Module

Operation

Assigns the variable *o* to be each successive object in *module* regardless of its deleted state or the current display set. It includes table and row header objects and the cells.

for object in document

Syntax

```
for o in document(module) do {
  ...
}
```

where:

o is a variable of type Object
module is a variable of type Module

Operation

Assigns the variable *o* to be each successive object in *module*. It is equivalent to the `for object in module` loop, except that it includes table header objects, but not the row header objects nor cells.

Example

```
Object o
for o in document current Module do {
  print identifier o "\n"
}
```

for object in module

Syntax

```
for o in module do {
  ...
}
```

where:

o is a variable of type Object
module is a variable of type Module

Operation

Assigns the variable *o* to be each successive object in *module* in depth first order, including the cells only of any DOORS native tables. Depth first order is the order in which objects are displayed down the page in a formal module.

This loop respects the current display set; an object is only returned if it is displayed under the current filter, level setting, and so on. Deleted objects are included when they are displayed and excluded when they are not displayed. Object numbering depends on whether deleted objects are displayed. If they are displayed, they are numbered. If they are not displayed, they are not numbered.

Example

```
Object o
for o in (current Module) do
    print (o."Object Heading") "\n"
```

for object in object

Syntax

```
for o in parent do {
    ...
}
```

where:

o is a variable of type Object
parent is an object of type Object

Assigns *o* to each successive child of object *parent*.

This loop ignores filters, such that even if objects are filtered, they are still returned by this function. Deleted objects are included when they are displayed and excluded when they are not displayed.

Example

```
Object o
Object po = current
for o in po do {
    print (o."Object Heading") " is a child of "
    print (po."Object Heading") "\n"
}
```

for object in top

Syntax

```
for o in top(module) do {
    ...
}
```

where:

o is a variable of type Object
module is a variable of type Module

Assigns *o* to each successive top-level object in *module*, including table headers. Top-level objects are those at level 1.

This function accesses all top level objects regardless of the current display set, which is different from the `for object in module` loop. Deleted objects are included, if they are displayed. Object numbering depends on whether deleted objects are displayed. If they are displayed, they are numbered. If they are not displayed, they are not numbered.

Example

```
Object o
Module m = current
for o in top m do {
    print o."Created On" "\n"
}
```

Current object

This section defines functions that are concerned with getting or setting the current object in a DOORS module.

Setting current object

The assignment operator `=` can be used as shown in the following syntax:

```
current = Object object
```

Makes *object* the current object. See also, the `current (object)` function.

For large DXL programs, when you set the current object, cast the current on the left hand side of the assignment to the correct type. This speeds up the parsing of the DXL program, so when your program is first run, it is loaded into memory quicker. It does not affect the subsequent execution of your program. So:

```
current = newCurrentObject
```

becomes

```
(current ObjectRef__) = newCurrentObject
```

Note: This cast only works for assignments to `current`. It is not useful for comparisons or getting the value of the current object.

Example

```
current = first current Module
current = below current
current = create last below current
```

current (object)

Declaration

```
Object current([Module m])
```

Operation

Returns a reference to the current object of module *m*, or the current module if *m* is omitted.

Example

```
Object o = current
Module m = edit "Car user reqts"
Object o = current m
```

Navigation from an object

This section defines functions that allow navigation across a DOORS module relative to a given object.

Specific object

The index notation, [], can be used to find a specific object, as shown in the following syntax:

```
Object o[int n]
Module m[int n]
```

This returns the *n*th child of object *o* counting from 1, or the *n*th top-level child of module *m*, counting from 1.

gotoObject

Declaration

```
Object gotoObject(int absno, Module m)
```

Operation

Changes the display of the specified module so that the object with the specified absolute number is brought into the display, and made current. This perm will change the current view in order to ensure that this object can be displayed.

Returns the Object with that absolute number.

Vertical navigation

Declaration

```
Object first(Object o)
Object last(Object o)
Object next(Object o)
Object parent(Object o)
```

```
Object previous(Object o)
```

```
Object first(Module m)
```

```
Object last(Module m)
```

Operation

The first five functions take an object argument *o*, and return an object, which is the object in the position relative to *o* as stated by the function:

<code>first</code>	returns the first child of object <i>o</i>
<code>last</code>	returns the last child of object <i>o</i>
<code>parent</code>	returns the parent of object <i>o</i>
<code>previous</code>	returns the previous object from object <i>o</i> in a depth first tree search (the same order as <code>for o in module do</code>)
<code>next</code>	returns the next object from object <i>o</i> in a depth first tree search (the same order as <code>for o in module do</code>)

If navigation is attempted to somewhere where no object exists, returns `null`.

These functions are used for vertical navigation of a DOORS module.

The last two functions return the first and last objects of module *m* in a depth first tree search, that is the first and last objects as they appear in a displayed module.

Example

This example finds objects relative to the passed object argument:

```
Object o = current
Object co = first o
if (null co) {
    print "Current object has no children.\n"
} else {
    if ((last o) == co) {
        print "current has one child: " (o."Object
            Heading") "\n"
        print (identifier o) " == " (identifier
            parent co) "\n"
    }
}
if (null o[3])
    print "current object does not have 3rd
        child\n"
if (null previous o)
    print "Current object is first in module.\n"
```

```

if (null next o)
  print "Current object is last in module.\n"
if (!null next o) {
  Object here = previous next o
  print (identifier o) " and " (identifier
    here) " are the same\n"
}

```

This example finds objects in the current module:

```

Object o1 = first current Module
Object o2 = last current Module
int count=1
while (o1 != o2) {
  count++
  o1 = next o1
}
print count " objects displayed in module\n"
o1 = (current Module)[3]
// get 3rd top level object
print identifier o1

```

Horizontal navigation

These functions are similar to the vertical navigation functions, but take as an argument a call to the function `sibling`, which returns a handle to allow navigation between sibling objects (children of the same parent).

Declaration

```

Object first(sibling(Object o))
Object last(sibling(Object o))
Object next(sibling(Object o))
Object previous(sibling(Object o))

```

Operation

These functions return an object at the current level of hierarchy: `first sibling` and `last sibling` return the first and last objects. Function `first sibling` works with the current display set, so hierarchies may disappear as the display set changes during navigation.

The functions are used for horizontal navigation of a DOORS module.

Example

```

Object o = current
Object po = parent o

```

```

if ((null previous sibling o) &&
    (null next sibling o)) {
    print (o."Object Heading") " is the only
        child of " // -(po."Object Heading") "\n"
    print "and " (identifier first sibling o) "
        == " //- (identifier first sibling o) " ==
        " (identifier o) "\n"
}

```

Object management

This section defines the functions for creating, moving and deleting objects.

Note: The creation of tables, table rows, columns and cells is handled by special-purpose functions, which are described in “Tables,” on page 707.

create (object)

Declaration

```

Object create (Module m)
Object create (Object o)
Object create (after (Object o))
Object create (before (Object o))
Object create (below (Object o))
object create (first (below (Object o)))
Object create (last (below (Object o)))

```

Operation

These functions create an object, whose position is controlled by the argument passed to the function, as follows:

Argument syntax	New object is
Module <i>m</i>	The first object in module <i>m</i> ; any existing objects at level 1 are moved after the new object
Object <i>o</i>	At the same level and immediately after the object <i>o</i>
after (Object <i>o</i>)	At the same level and immediately after the object <i>o</i> (same as without <i>after</i>)
below (Object <i>o</i>)	The first child of object <i>o</i>

Argument syntax	New object is
<code>first (below (Object o))</code>	The first child of object <code>o</code> (same as without <code>first</code>)
<code>last (below (Object o))</code>	The last child of object <code>o</code>

In each case, the function returns the created object.

Example

This example creates `newo` at the same level and immediately after `o`.

```
Object o = current
```

```
Object newo = create o
```

which is equivalent to:

```
Object o = current
```

```
Object newo = create after o
```

This example creates `newo` at the same level and immediately before `o`.

```
Object o = current
```

```
Object newo = create before o
```

This example creates `newo` as the first child of `o`.

```
Object o = current
```

```
Object newo = create below o
```

which is equivalent to:

```
Object o = current
```

```
Object newo = create first below o
```

This example creates `newo` as the last child of `o`.

```
Object o = current
```

```
o = create last below o
```

move (object)

Declaration

```
void move(Object o1,  
          Object o2)
```

```
void move(Object o1,  
          below(Object o2))
```

```
void move(Object o1,  
          last(below(Object o2)))
```

Operation

These functions move an object to a position, which is controlled by the second argument passed to the function, as follows:

Argument syntax	Moves
<code>Object o2</code>	object <i>o1</i> and its descendants to be immediately after object <i>o2</i>
<code>below(Object o2)</code>	object <i>o1</i> and its descendants to be the first child below <i>o2</i>
<code>last(below(Object o2))</code>	object <i>o1</i> and its descendants to be the last child below <i>o2</i>

Example

This example moves the last object in the module to be the first child of the first object:

```
Object p = first current Module
Object o = last current Module
move (o, below p)
```

This example moves the last object in the module to be the last child of the first object:

```
Object p = first current Module
Object o = last current Module
move(o, last below p)
```

canDelete

Declaration

```
string canDelete(Object o)
```

Operation

Returns null if object *o* can be deleted; otherwise returns a string "object has descendants". The `softDelete (object)` function works on an object that has descendants.

flushDeletions

Declaration

```
void flushDeletions()
```

Operation

Flushes any deletions performed by a DXL program. Normally DOORS structures are only marked for deletion when the DXL program exits; this command makes any pending deletions happen immediately. Take care not to flush deletions inside a `for` loop, because the loop may depend on the presence of an object.

hardDelete (object)

Declaration

```
void hardDelete(Object o)
void delete(Object o)
```

Operation

Removes object *o*; the object cannot be recovered with `undelete` following this operation. If the operation fails, returns an error message (see also the `canDelete` function).

The form `delete` is provided for backwards compatibility only. The function `hardDelete` should be used for all new programs.

sectionNeedsSaved

Declaration

```
bool sectionNeedsSaved(Object o)
```

Operation

Returns `true` if *o* is contained within an object hierarchy that has been modified but not saved. Otherwise, returns `false`.

softDelete (object)

Declaration

```
void softDelete(Object o[, bool checkLinks])
```

Operation

Marks object as deleted. The object is not actually deleted until it is purged. Objects marked for deletion can be recovered using the `undelete (object)` function. If the optional argument `checkLinks` is set to `true`, then an error will be given if any of the objects children have incoming links.

undelete (object)

Declaration

```
string undelete(Object o)
```

Operation

Restores object *o*. On success returns `null`. On error, the error condition is returned to the user.

purgeObjects_

Declaration

```
string purgeObjects_(Module mod)
```

Operation

Removes all soft deleted objects from module *mod*. Once executed, these objects cannot be recovered. The name ends in `'_'` to discourage casual use.

Information about objects

This section defines functions that return information about objects.

Object status

Declaration

```
bool canRead(Object o)
bool canWrite(Object o)
bool leaf(Object o)
bool isDeleted(Object o)
bool isFiltered(Object o)
bool isOutline(Object o)
bool isSelected(Object o)
bool isVisible(Object o)
bool modified(Object o)
```

Operation

Each function returns `true` for a condition defined by the function name as follows:

Function	Returns true if
<code>canRead</code>	the user has read access to object <i>o</i>
<code>canWrite</code>	the user has write access to object <i>o</i>
<code>leaf</code>	object <i>o</i> has no children, or has children objects that are deleted, but not displayed
<code>isDeleted</code>	object <i>o</i> has been soft deleted

Function	Returns true if
<code>isFiltered</code>	object <code>o</code> is accepted in the current filter
<code>isOutline</code>	object <code>o</code> would appear in outline mode
<code>isSelected</code>	object <code>o</code> is selected
<code>isVisible</code>	object <code>o</code> is part of the current display set
<code>modified</code>	object <code>o</code> has been modified since the last baseline of the module

getColumnBottom

Declaration

```
Object getColumnBottom(Object o)
```

Operation

Returns the bottom cell of the table column that contains `o`; otherwise, returns `null`.

getColumnTop

Declaration

```
Object getColumnTop(Object o)
```

Operation

Returns the top cell of the table column that contains `o`; otherwise, returns `null`.

level (object get)

Declaration

```
int level(Object o)
```

Operation

Returns the object level of object `o`. Level 1 is the top level of the module.

identifier

Declaration

```
string identifier(Object o)
```

Operation

Returns the identifier, which is a combination of absolute number and module prefix, of object *o* as a string.

number

Declaration

```
string number(Object o)
```

Operation

Returns the hierarchical object number (for example 2.1.1-0.1) of object *o* as a string.

Selecting objects

This section defines functions concerned with selecting objects.

getSelection

Declaration

```
Object getSelection(Module m)
void getSelection(Module m,
                  Object &start,
                  Object &finish)
```

Operation

The first form gets the first object of a selection in module *m*.

The second form gets the current selection in module *m*, and sets object variables *start* and *finish* to the beginning and end of it.

setSelection

Declaration

```
void setSelection(Object o)
void setSelection(Object start,
                  Object finish)
```

Operation

The first form makes object *o* the start and finish of the current selection.

The second form sets the selection in the current module to begin at object *start* and end at object *finish*. The start and end objects must be siblings.

deselect

Declaration

```
void deselect(Object o)
```

```
void deselect(Module m)
```

Operation

Deselects object *o* or the current selection in module *m*.

Object searching

This section defines functions that are used by Find/Replace when highlighting an object, or an object's attribute.

setSearchObject

Declaration

```
void setSearchObject(Object, int columnIndex)
```

Operation

Used by Find/Replace to mark either a specific attribute of the object in a column by surrounding it in a colored box (the same color as an outgoing link). This indicates which specific part of the object has been matched by the find operation. If no valid/visible column is supplied, the object is marked by lines above and below the entire object.

Example

```
Object o = object(4)
```

```
int mainColumn = 1
```

```
setSearchObject(o, mainColumn)
```

getSearchObject

Declaration

```
Object getSearchObject(Module, int &columnIndex)
```

Operation

Returns the object and column number of the highlighted attribute in the given module.

Example

```
Module m = current
int col
Object o = getSearchObject(m, col)
```

clearSearchObject

Declaration

```
void clearSearchObject(Object)
void clearSearchObject(Module)
```

Operation

Clears the highlighting put in place by `setSearchObject`. Currently, if an object is provided, that object need not be the highlighted object, but this could change.

Example

```
Object o = current
clearSearchObject(o)
```

highlightText

Declaration

```
bool highlightText(Object, int start, int stop, int colIndex, bool isHeading)
```

Operation

Highlights text in the given module, in the given column from cursor position *start* to cursor position *stop*.

Example

```
//Highlights the first 10 characters of the current objects heading
highlightText(current Object, 10, 20, 1, true)
```

Miscellaneous object functions

This section defines functions that affect the display of an object or use the clipboard.

inplaceEditing

Declaration

```
bool inplaceEditing(Module m)
```

Operation

This returns `true` if the module `m` is a formal module which is currently displayed and in-place edit mode is activated for a displayed attribute.

object

Declaration

```
Object object(int i[,Module m])
```

Operation

Returns the object with the specified absolute number. If no `Module` argument is supplied, the current module is searched.

Example

```
Object o = object(4)
print identifier o
```

Clipboard general functions

Declaration

```
bool cut()
bool copyFlat()
bool copyHier()
bool pasteSame()
bool pasteDown()
bool clearClipboard()
bool clipboardIsEmpty()
bool clipboardIsTransient()
```

Operation

Each function performs an action or status check defined by the function name as follows:

Function	Action
<code>cut</code>	Cuts the current object and all of its children, and stores them on the clipboard. If the operation succeeds, returns <code>true</code> ; otherwise, returns <code>false</code> .
<code>copyFlat</code>	Copies the current object to the clipboard. If the operation succeeds, returns <code>true</code> ; otherwise, returns <code>false</code> .
<code>copyHier</code>	Copies the current object and all of its children to the clipboard. If the operation succeeds, returns <code>true</code> ; otherwise, returns <code>false</code> .
<code>pasteSame</code>	Pastes the clipboard contents after the current object, at the same level as the current object. If the operation succeeds, returns <code>true</code> ; otherwise, returns <code>false</code> .
<code>pasteDown</code>	Pastes the clipboard contents one level down from the current object. If the operation succeeds, returns <code>true</code> ; otherwise, returns <code>false</code> .
<code>clearClipboard</code>	Clears the clipboard. If the operation succeeds, returns <code>true</code> ; otherwise, returns <code>false</code> . The DOORS object clipboard is also cleared when a module is closed.
<code>clipboardIsEmpty</code>	Returns <code>true</code> if the clipboard is empty. Returns <code>false</code> if the clipboard is not empty.
<code>clipboardIsTransient</code>	Returns <code>true</code> if the clipboard contains transient data (the result of a cut or copy operation). Returns <code>false</code> if the clipboard does not contain transient data.

splitHeadingAndText

Declaration

```
string splitHeadingAndText (Object)
```

Operation

Splits the Object Heading and Object Text of the given object. The heading will be moved to a new object, and the heading of the given object will be emptied. The given object will be demoted to become the first child of the new object. Returns a null string on success or an error message on failure.

Example

```
Object o = current
string s = splitHeadingAndText(o)
```

```
if (null s){
    print "Object split successfully."
} else {
    print "Error splitting object : " s
}
```

getCursorPosition

Declaration

```
int getCursorPosition(Module, bool &isHeading)
```

Operation

If no attributes in the given module are activated for in-place editing then -1 is returned. Otherwise it returns the position of the cursor in the attribute currently being edited, if that attribute is the Object Heading then `isHeading` will be set to true, otherwise it will be set to false.

Example

```
bool isHeading
print getCursorPosition(current Module, isHeading) ""
```

Chapter 14

Links

This chapter describes features that operate on DOORS links:

- About links and link module descriptors
- Link creation
- Link access control
- Finding links
- Versioned links
- Link management
- Default link module
- Linksets
- External Links
- DOORS URLs

About links and link module descriptors

The underlying database architecture of DOORS links affects the way in which link DXL must be written. Link modules store linksets, not actual links. Link modules can be placed in any folder in the hierarchy except the database root folder, but they are normally placed in the folder containing the source module.

Links are stored in the module corresponding to the source of the link. This means that the user must have write permission in the source module to create or modify a link.

This causes an asymmetry in DXL programs handling links. Any code trying to access an incoming link must have the source module loaded. Outgoing links are always immediately available in a formal module, however, the target module may not be open, in which case the target function returns `null`.

DOORS links are represented in DXL in by the `Link` data type.

A folder or project can specify the link modules to be used when a link is created between a pair of modules, the source of which is in the folder. This source/target module pairing is called a link module descriptor, which is represented by the `LinkModuleDescriptor` data type.

Note: To obtain a type `LinkModuleDescriptor` handle, you must use the `for link module descriptor in folder` loop.

Each pairing contains the name of the link module, a description, and a boolean flag *overridable*. The *overridable* flag specifies whether or not that link module must be used for links between the specified source and target module. If *overridable* is *false*, newly created links must be in that link module; specifying a different link module at the time a link is created causes a run-time error. If *overridable* is *true*, you can specify a different link module. The modules referenced in the link module descriptor may but need not already exist at the time the link module is specified.

Link creation

This section defines the operators used to create links.

Link operators

Two operators create links, as shown in the following syntax:

```
Object source -> [string linkModuleName ->] Object target
Object target <- [string linkModuleName <-] Object source
```

The `->` operator creates an outgoing link from object *source* to object *target* via link module *linkModuleName*. If *linkModuleName* is omitted the link goes via the default link module (see “Default link module,” on page 339).

The `<-` operator creates an incoming link from object *source* to object *target* via link module *linkModuleName*. If *linkModuleName* is omitted the link goes via the default link module.

These operators are also used in the for loops defined in “Finding links,” on page 327.

Example

This example creates a link from the current object of the current module to the first object of module *target* via the link module *tested by*.

```
(current Object) -> "tested by" -> (first read "target")
```

This example creates a link to the current object of the current module from the first object of module *source* via the link module *tested by*. Because links are stored in the source module, you must open *source* for editing to allow the link to be created.

```
(current Object) <- "tested by" <- (first edit "source")
```

Link access control

This section describes a function that reports on access rights for links.

canDelete (link)

Declaration

```
bool canDelete(Link l)
string canDelete(Link l)
```

Operation

The first form returns `true` if the current DOORS user can delete link `l`. Otherwise, returns `false`.

The second form returns a null string if the current DOORS user can delete link `l`. Otherwise, it returns an error message.

Finding links

This section defines `for` loops that allow DXL programs to navigate through the links in a module. Links are referred to by the `Link` or `LinkRef` data type.

for all outgoing links

Syntax

```
for outLink in (Object srcObject) -> (string
    linkModuleName) do {
    ...
}
```

where:

<code>outLink</code>	is a variable of type <code>Link</code>
<code>srcObject</code>	is a variable of type <code>Object</code>
<code>linkModuleName</code>	is a string variable

Operation

Assigns the variable `outLink` to be each successive outgoing link from object `srcObject` via link module named `linkModuleName`. The string `linkModuleName` can be a specific link module name, or the string "*" meaning any link module.

Example

```
Link l
```

```

for l in (current Object) -> "*" do {
  string user = l."Created By"
  print user "\n"
}

```

for all incoming links

Syntax

```

for inLink in (Object tgtObject) <- (string
  linkModuleName) do {
  ...
}

```

where:

<i>inLink</i>	is a variable of type Link or LinkRef
<i>tgtObject</i>	is a variable of type Object
<i>linkModuleName</i>	is a string variable

Operation

Assigns the variable *inLink* to be each successive incoming link arriving at object *tgtObject* via link module named *linkModuleName*. The string *linkModuleName* can be a specific link module name, or the string "*" meaning any link module.

Note: This loop only assigns to *inLink* incoming link values for which the source object is loaded; unloaded links are not detected.

Example

Link l

```

for l in (current Object) <- "*" do {
  string user = l."Created By"
  print user "\n"
}

```

for all sources

Syntax

```

for srcModName in (Object tgtObject) <- (string
  linkModName) do {
  ...
}

```

where:

<i>srcModName</i>	is a string variable
<i>tgtObject</i>	is a variable of type <code>Object</code>
<i>linkModName</i>	is a string variable

Operation

Assigns the variable *srcModName* to be the unqualified name of the source module of each successive incoming link arriving at object *tgtObject* via link module named *linkModuleName*. The string *linkModuleName* can be a specific link module name, or the string "*" meaning any link module.

Note: This loop assigns to *modName* values for all incoming links, whether the source is loaded or not. This can be used to pre-load all incoming link sources before using the `for all incoming links` loop.

Example

This example prints the unqualified name of all the source modules for incoming links to the current object:

```
Object o = current
string srcModName
for srcModName in o<-"*" do print srcModName "\n"
```

for all source references

Syntax

```
for srcModRef in (Object tgtObject) <- (string
    linkModName) do {
    ...
}
```

where:

<i>srcModRef</i>	is a variable of type <code>ModName_</code>
<i>tgtObject</i>	is a variable of type <code>Object</code>
<i>linkModName</i>	is a string variable

Operation

Assigns the variable *srcModRef* to be the reference of the source module of each successive incoming link arriving at object *tgtObject* via link module named *linkModuleName*. The string *linkModuleName* can be a specific link module name, or the string "*" meaning any link module.

Note: This loop assigns to *modName* values for all incoming links, whether the source is loaded or not. This can be used to pre-load all incoming link sources before using the `for all incoming links` loop.

Example

```
ModName_ srcModRef
for srcModRef in o<-"*" do
    read(fullName(srcModRef), false)
```

for all link references

Syntax

```
for linkRef in (Object tgtObject) <- (string
    linkModuleName) do {
    ...
}
```

where:

<i>linkRef</i>	is a variable of type LinkRef
<i>tgtObject</i>	is a variable of type Object
<i>linkModuleName</i>	is a string variable

Operation

Assigns the variable *linkRef* to be the link reference of each successive incoming link arriving at object *tgtObject* via link module named *linkModuleName*. The string *linkModuleName* can be a specific link module name, or the string "*" meaning any link module.

for link module descriptor in folder

Syntax

```
for linkModDesc in f do {
    ...
}
```

where:

<i>linkModDesc</i>	is a variable of type LinkModuleDescriptor
<i>f</i>	is a variable of type Folder

Operation

Assigns the variable *linkModDesc* to be each successive link module descriptor in folder *f*.

Versioned links

for all outgoing links

Declaration

```
for outLink in all (Object srcObject) -> (string linkModName) do {
    ...
}
```

where:

```
outLink          is a variable of type Link
srcObject       is a variable of type Object
linkModName    is a variable of type string
```

Operation

This will iterate through all outgoing links, including links to baselines.

for all incoming links

Declaration

```
for inLink in all ((Object tgtObject) <- (string linkModuleName)) do {
    ...
}
```

where:

```
inLink           is a variable of type Link or LinkRef
tgtObject       is a variable of type Object
linkModuleName is a string variable
```

Operation

These will iterate through all incoming links, including links from baselines.

for all source links

Declaration

```
for srcModName in (Object tgtObject) <- (string linkModName) do {
  ...
}
```

where:

```
srcModName    is a string variable
tgtObject     is a variable of type Object
linkModName   is a string variable
```

This would include links from baselines, returning the name of the source module, without baseline version numbers.

for all source link references

Declaration

```
for srcModRef in (Object tgtObject) <- (string linkModName) do {
  ...
}
```

where:

```
srcModRef     is a variable of type ModName_
tgtObject     is a variable of type Object
linkModName   is a string variable
```

Operation

This would include links from baselines.

sourceVersion

Declaration

```
ModuleVersion sourceVersion(Link|LinkRef l)
```

Operation

This will return document version information for the source module of the specified `Link` or `LinkRef`. The new `ModuleVersion` type gives access to `ModName_` and `Baseline` information, via new perms detailed in the rest of this section.

targetVersion

Declaration

```
ModuleVersion targetVersion(Link l)
```

Operation

This will return document version information for the target module of the specified `Link`.

echoed outlinks

Declaration

```
bool echo(Link l)
```

Operation

This returns `true` for an echoed outlink. An echoed outlink is any outgoing link in a module baseline which does not have a corresponding inlink in the target module leading back to this baseline. Any outgoing link in a baseline will be an echoed link unless it is a link to the same module or a link to another module in the same Baseline Set.

echoed inlinks

Declaration

```
bool echo(LinkRef l)
```

Operation

This returns `true` for an echoed inlink. An echoed inlink is any incoming link in a module baseline which does not have a corresponding outlink in the source module leading back to this baseline. Any incoming link in a baseline will be an echoed link unless it is a link from the same module or a link from another module in the same Baseline Set.

getSourceVersion(Linkset)

Declaration

```
ModuleVersion getSourceVersion(Linkset ls)
```

Operation

Returns some description of the version of the document in the source of a linkset `ls`.

Link management

This section defines functions for managing links. Links are referred to by the `Link` or `LinkRef` data type.

addLinkModuleDescriptor

Declaration

```
string addLinkModuleDescriptor(Folder f,
                               string s,
                               string t,
                               bool o,
                               string name,
                               string desc)
```

Operation

Creates a new link module descriptor for the link between source *s* and target *t*, via link module *name*, in folder *f*. If the link module does not exist when this function is called, *desc* is the description of the link module created. Folder *f* must be the folder that contains the source module *s*.

If the operation succeeds, returns a null string; otherwise, returns an error message.

This function checks for duplicate *s/t* pairings. If the new link module descriptor would create a duplicate, it returns a message.

For further information on link module descriptors, see “About links and link module descriptors,” on page 325.

removeLinkModuleDescriptor

Declaration

```
string removeLinkModuleDescriptor(Folder f,
                                   string s,
                                   string t)
```

Operation

Deletes one link module descriptor defined for source *s* and target *t*, in folder *f*. If there is more than one *s/t* pair, the duplicates remain.

If the operation succeeds, returns a null string; otherwise, returns an error message.

For further information on link module descriptors, see “About links and link module descriptors,” on page 325.

setLinkModuleDescriptorsExclusive

Declaration

```
void setLinkModuleDescriptorsExclusive(Folder f, ModName_ m, bool flag)
```

Operation

Setting the boolean variable *flag* to `true` has the same effect as selecting the **only allow outgoing links as specified in the above list** option in the GUI.

Example

```
Folder f = current
ModName_ m = module("/A Project/A Module")
setLinkModuleDescriptorsExclusive(f, m, true)
```

getDescription

Declaration

```
string getDescription(LinkModuleDescriptor linkModDesc)
```

Operation

Returns the description of the link module in the specified link module descriptor.

If the operation succeeds, returns a string; otherwise, returns null.

For further information on link module descriptors, see “About links and link module descriptors,” on page 325.

getName

Declaration

```
string getName(LinkModuleDescriptor linkModDesc)
```

Operation

Returns the name of the specified link module descriptor.

If the operation succeeds, returns a string; otherwise, returns null.

For further information on link module descriptors, see “About links and link module descriptors,” on page 325.

getSourceName

Declaration

```
string getSourceName(LinkModuleDescriptor linkModDesc)
```

Operation

Returns the name of the source in the specified link module descriptor.

If the operation succeeds, returns a string; otherwise, returns null.

For further information on link module descriptors, see “About links and link module descriptors,” on page 325.

getTargetName

Declaration

```
string getTargetName(LinkModuleDescriptor linkModDesc)
```

Operation

Returns the name of the target in the specified link module descriptor.

If the operation succeeds, returns a string; otherwise, returns null.

For further information on link module descriptors, see “About links and link module descriptors,” on page 325.

getOverridable

Declaration

```
bool getOverridable(LinkModuleDescriptor linkModDesc)
```

Operation

Returns whether the specified link module descriptor is overridable.

If the operation fails, returns null.

For further information on link module descriptors, see “About links and link module descriptors,” on page 325.

setOverridable

Declaration

```
void setOverridable(LinkModuleDescriptor linkModDesc, bool overridable)
```

Operation

If *overridable* is true, sets *linkModDesc* to overridable; otherwise sets *linkModDesc* to not overridable.

If *linkModDesc* is already overridable, the call fails. You can obtain the value of the override setting using the *getOverridable* function.

For further information on link module descriptors, see “About links and link module descriptors,” on page 325.

getMandatory

Declaration

```
bool getMandatory(LinkModuleDescriptor linkModDesc)
```

Operation

Returns whether the specified link module descriptor is mandatory.

If the operation fails, returns null..

setMandatory

Declaration

```
void setMandatory(LinkModuleDescriptor linkModDesc, bool mandatory)
```

Operation

If *mandatory* is true it sets *linkModDesc* to mandatory; otherwise sets *linkModDesc* to not mandatory.

If *linkModDesc* is already mandatoy, the call fails.

delete (link)

Declaration

```
void delete(Link l)
```

Operation

Marks link *l* for deletion. The delete only takes effect when the DXL script ends, or when the *flushDeletions* function is called.

module (link)

Declaration

```
Module module(Link l)
```

Operation

Returns the link module handle of link *l*, where linksets are stored as objects.

source

Declaration

```
string source({Link|LinkRef} l)
```

```
ModName_ source({Link|LinkRef} l)
```

```
Object source(Link l)
```

Operation

The first form returns the unqualified name of the module that is the source of *l*, which can be of type *Link* or *LinkRef*.

The second form returns a reference to the module that is the source of *l*, which can be of type *Link* or *LinkRef*.

The third form returns the source object of link *l*.

Example

```
Object o = current
LinkRef lref
ModName_ srcModRef
for lref in o<-"*" do {
    srcModRef = source lref
    read(fullName(srcModRef), true)
}
```

sourceAbsNo

Declaration

```
int sourceAbsNo({Link|LinkRef} l)
```

Operation

Returns the absolute number of the object that is the source of *l*, which can be of type *Link* or *LinkRef*.

target

Declaration

```
string target(Link l)
ModName_ target(Link l)
Object target(Link l)
```

Operation

The first form returns the unqualified name of the module that is the target of link *l*.

The second form returns a reference to the module that is the target of link *l*.

The third form returns the target object of link *l*. Returns `null` if the target module is not loaded, in which case your program can load the module and re-run `target`.

Example

```
Object o = current
Link lnk
ModName_ targetMod
for lnk in o->"*" do {
    targetMod = target lnk
    read(fullName(targetMod), true)
}
```

targetAbsNo

Declaration

```
int targetAbsNo(Link l)
```

Operation

Returns the absolute number of the object that is the target of *l*.

Default link module

This section defines functions that operate on the default link module, which is used by drag-and-drop operations from the DOORS user interface.

getDefaultLinkModule

Declaration

```
string getDefaultLinkModule([ModName_ srcRef,  
                             ModName_ trgRef])
```

Operation

Returns the name of the default link module.

Example

```
print getDefaultLinkModule(module("Functional  
    Requirements"),module("User Requirements"))
```

setDefaultLinkModule

Declaration

```
void setDefaultLinkModule(string linkModName)
```

Operation

Sets the name of the default link module.

Linksets

This section defines functions that apply to linksets. Linksets are referred to by the `Linkset` data type.

create (linkset)

Declaration

```
Linkset create([Module linkMod,]
               string source,
               string target)
```

Operation

Creates a linkset between modules specified by the strings *source* and *target*, in the link module *linkMod*. If *linkMod* is omitted, creates a linkset in the current module. If the link module is open for display, the display updates to show this linkset.

delete (linkset)

Declaration

```
void delete(Linkset ls)
```

Operation

Deletes the linkset *ls*. If the linkset is currently being displayed, the link module resets to displaying no linkset.

getSource getTarget

Declaration

```
string getSource(Linkset ls,
                 Object &o)
string getTarget(Linkset ls,
                 Object &o)
```

Operation

The first function gets the current source object in linkset *ls*, and sets object variable *o* to it.

The second function gets the current target object in linkset *ls*, and sets object variable *o* to it.

Either function returns null if it succeeds; otherwise, returns an error message.

linkset

Declaration

```
Linkset linkset(Object ls)
```

Operation

Converts a link module's object *ls* into a linkset handle, which can be used with the operations `load` and `delete`.

Example

In this example, `m` must be a link module, which means that the objects it contains are linksets. To make this explicit the function `linkset` is called.

```
Module m = current
Object o
Linkset ls = linkset o
delete ls
```

load

Declaration

```
string load(Linkset ls)
```

Operation

Load the linkset `ls`. If the associated link module is open for display, the display updates to show this linkset.

setSource, setTarget

Declaration

```
string setSource(Linkset ls,
                Object o)
string setTarget(Linkset ls,
                Object o)
```

Operation

Sets either the source or the target object in the linkset `ls`, as displayed in the link module window matrix view, to be object `o`.

If the operation succeeds, returns `null`; otherwise, returns an error message.

side1

Declaration

```
Object side1(Module linkMod)
```

Operation

Returns the object that is currently selected on `side1` (the source side) of the linkset.

Note: When using this perm just after opening the module `linkMod`, the `refresh` perm should be used beforehand

side2

Declaration

```
Object side2 (Module linkMod)
```

Operation

Returns the object that is currently selected on `side2` (the target side) of the linkset.

Note: When using this perm just after opening the module `linkMod`, the `refresh` perm should be used beforehand

unload

Declaration

```
void unload(Linkset ls)
```

```
void unload(Module linkMod)
```

Operation

Unloads a loaded linkset specified by either the linkset handle `ls`, if it is current, or the current linkset of the link module `linkMod`.

getTargetModule

Declaration

```
ModName_ getTarget (Linkset ls)
```

Operation

Returns the target module reference for the specified linkset.

External Links

ExternalLink

`ExternalLink` is a new data type representing the end of an external link. An external link is a one way link to the resource it references. No corresponding link is created in the linked resource.

ExternalLinkDirection

Declaration

```
ExternalLinkDirection extLinkDir
```

Operation

Used to describe the direction of an external link. Valid values are inward and outward.

ExternalLinkBehaviour

Declaration

```
ExternalLinkBehaviour extLinkBeh
```

Operation

Used to describe the behavior of an external link. Valid values are none and openAsURL.

ExternalLink current

Operation

Fetches the current external link. This perm will return non-null only when called from within attribute DXL executing against an external link. In all other cases it will be null.

Example

```
External extLink = current
```

create(external link)

Declaration

```
string create(Object o, string name, string description, ExternalLinkDirection extLinkDir, ExternalLinkBehaviour extLinkBeh, string body, ExternalLink& extLink)
```

Operation

Creates an external link on the specified object. The object must be locked and be modifiable by the current session. On success, null is returned and the new link is returned in the *ExternalLink&* variable.

canDelete(external link)

Declaration

```
bool canDelete(ExternalLink extLink)
string canDelete(ExternalLink extLink)
```

Operation

This perm should always return `false`. If applied to a link from a baseline, an error string will be returned.

source

Declaration

```
Object source(ExternalLink extLink)
```

Operation

Returns information concerning the object having this external link for external links marked as `out`. For external links marked as `in`, the perm returns null.

for all outgoing external links

Declaration

```
for extLink in (Object o) -> string ""
where:
extLink is a variable of type ExternalLink
```

Operation

Iterates over all external outgoing links on the object `o`. The supplied string parameter must be the empty string.

for all incoming external links

Declaration

```
for extLink in (Object o) <- string ""
where:
extLink is a variable of type ExternalLink
```

Operation

Iterates over all external incoming links on the object `o`. The supplied string parameter must be the empty string.

Example

The following example demonstrates the external link behavior. It must be executed from within a module that has at least one object.

```

ExternalLink el,e11,e12,e13
//Create 3 external links
print create(current Object, "Description1", "Name1", outward, none,
"https://www.telelogic.com", e11)
print create(current Object, "Description2", "Name2", outward, openAsURL,
"https://support.telelogic.com/", e12)
print create(current Object, "Description3", "Name3", inward, openAsURL,
"https://support.telelogic.com", e13)

follow(e11) //This will fail - follow behaviour is 'none'.
update("Telelogic Web Site",name(e11),direction(e11), openAsURL, body(e11),
e11)
follow(e11)

Object o = current
//Iterate over outward links
for el in o->" do
{
    print "Created on " el."Created On" " Last modified on " el."Last Modified
On" "\n"
}

//Iterate over inward links - changing External Link data
for el in o<-" do
{
    string elName = name(el)
    string elDesc = description(el)
ExternalLinkDirection elDir = direction(el)
        ExternalLinkBehaviour elBehaviour= behaviour(el)
    string elBody = body(el)
    if (elBehaviour == none)
    {
        elName = "New name"
    }
}

```

```

        update(elDesc, elName, elDir, elBehaviour, elBody, el)
    }

    for el in o<-" do
    {
        string elName = name(el)
        print "" elName "" created on " el."Created On" " Last modified on "
        el."Last Modified On" "\n"
        if (behaviour(el) == openAsURL)
        {
            print "Opening up '" body(el) "' \n"
            print follow(el) "\n"
            update("Telelogic Support Web Site",name(el),direction(el),
            behaviour(el), body(el), el)
            break
        }
    }
}

```

DOORS URLs

getURL

Declaration

```

string getURL(Database__ d[, bool incSSOToken])
string getURL(Module m[, bool incSSOToken])
string getURL(ModName_ modNam[, bool incSSOToken])
string getURL(ModuleVersion modVer[, bool incSSOToken])
string getURL(Object o[, bool incSSOToken])
string getURL(Folder f[, bool incSSOToken])
string getURL(Project p[, bool incSSOToken])
string getURL(Item i[, bool incSSOToken])

```

Operation

Returns the DOORS URL of the given parameter.

If the optional boolean parameter is true, the returned URL will include the current session user single sign-on token.

getTDSSSToken

Declaration

```
string getTDSSSToken (string& ssoToken)
```

Operation

Fetches a TDS single sign-on token for the current session user.

Returns null on success, or an error on failure.

decodeURL

Declaration

```
string decodeURL(string url, string& dbHost, int& dbPort, string& dbName,
string& dbId, Item& i, ModuleVersion& modVer, int& objectAbsno)
```

Operation

This perm decodes the given DOORS URL and returns in its output parameters enough details to validate the URL *url* against the current database and navigate to the item or module specified by that URL.

The output Item *i* and ModuleVersion *modVer* will be null if the URL refers to the database root node.

The output ModuleVersion will be null if the URL refers to a project or folder.

The *objectAbsno* variable will be -1 unless the URL specifies navigation to a particular object.

The function returns null if the URL is successfully decoded, or an error string if the referenced Item cannot be found or the user doesn't have read access to the referenced Item.

Example

The following example demonstrates the DOORS URL behavior. The current example returns the details for the current Object selected in a module. The second last line of the example can be changed to return details for the corresponding item.

```
string urlInfo(string url)

// DESCRIPTION: Returns a string describing the target of the specified URL
string.
{
    string result = null
    ModuleVersion mv
    int objectAbsno
    Item i
```

```

string dbHost = null
int dbPort
string dbName
string dbID = null

result = decodeURL(url, dbHost, dbPort, dbName, dbID, i, mv, objectAbsno)

if (null result)
{
    if (dbID != getDatabaseIdentifier)
    {
        result = "The dbID does not match the current database."
    }
    else if (null i)
    {
        result = "Database: " dbName ""
    }
    else if (null mv)
    {
        // we're going to the top level node
        result = (type i) ": " (fullName i) ": " (description i)
    }
    else
    {
        // it's a module or baseline
        Module m = null

        if (isBaseline(mv))
        {
            result = "Baseline: " (fullName mv) " [" (versionString mv) "]:
" (description module mv)
        }
        else

```



```

{
    result = "Module: " (fullName mv) ": " (description module mv)
}

if (objectAbsno >= 0)
{
    if (isBaseline(mv))
    {
        m = load(mv, true)
    }
    else
    {
        string mode = getenv("DOORSDEFOPENMODE")
        if (mode == "READ_ONLY" || mode == "r")
        {
            m = read(fullName(mv))
        }
        else if (mode == "READ_WRITE_SHARED" || mode == "s")
        {
            m = share(fullName(mv))
        }
        else
        {
            // Check the rights for the user and open the module as
per the rights

            if (canModify(i))
            {
                m = edit(fullName(mv))
            }
            else
            {
                m = read(fullName(mv))
            }
        }
    }
}

```

```

    }
    if (null m)
    {
        // Something went wrong
        result = result "\nCould not open module " (fullName mv) "."
    }
    else
    {
        current = m
        Object o = gotoObject(objectAbsno, m, true)
        if (null o)
        {
            result = result "\nCould not locate object " objectAbsno
            "."
        }
        else
        {
            result = result "\nObject " objectAbsno ""
        }
        if (!null o."Object Heading" && length(o."Object Heading" "")
        > 0)
        {
            result = result "\nObject Heading: " o."Object Heading" ""
        }
        if (!null o."Object Text" && length(o."Object Text" "") > 0)
        {
            result = result "\nObject Text: " o."Object Text" ""
        }
    }
}
}
}
return result
}

```

```
string obj_url = getURL(current Object)
print urlInfo(obj_url)
```

validateDOORSURL

Declaration

```
string validateDOORSURL(string url)
```

Operation

This perm takes a DOORS URL and performs a basic check that the URL structure is correct and required elements are present.

The function returns NULL if the URL is successfully validated, or an error string if there is a problem.

Example

```
Object o = current
string url = getURL o
string s = validateDOORSURL(url)

if (null s){
    print "URL is valid"
} else {
    print "Error in URL : " s
}
```

isDefaultURL

Declaration

```
bool isDefaultURL(string URL)
```

Operation

Returns true if the supplied URL does not have an explicitly specified protocol.

Example

```
string url = "www.google.com"
string fullURL

if (isDefaultURL(url)){
    fullURL = "http://" url
}
```

```
}  
print fullURL
```

Chapter 15

Attributes

This chapter describes the use of DOORS attributes from DXL:

- Attribute values
- Attribute value access controls
- Multi-value enumerated attributes
- Attribute definitions
- Attribute definition access controls
- Attribute types
- Attribute type access controls
- Attribute type manipulation
- DXL attribute

Attribute values

This section defines constants, operators and functions for working with attribute values. Attribute values are one of the most important aspects of DOORS.

Many example DXL programs in this manual or in the DXL library use attribute values.

maximumAttributeLength

Declaration

```
int maximumAttributeLength
```

Operation

Defines a constant, which equates to the maximum number of characters in a string attribute.

Attribute value extraction

Attribute names are available for use in combination with the `.` (dot) operator to extract the value of attributes. The syntax for using the attribute names is:

```
(Object o).(string attrName)
```

```
(Module m).(string attrName)
```

```
(Link l).(string attrName)
(ModuleProperties mp).(string attrName)
```

where:

o is an object of type Object
m is a variable of type Module
l is a variable of type Link
mp is a variable of type ModuleProperties
attrName is a string identifying the attribute

This means that you can write:

```
o."Object Heading"
m."Description"
l."Created By"
```

when you want to refer to the values of a named attribute of object *o*, module *m* or link *l*.

A selected attribute can be assigned the value of a DXL variable (see “Assignment (to attribute),” on page 355). Conversely, a DXL variable can be assigned the value of an attribute (see “Assignment (from attribute),” on page 354).

Concatenation (attribute)

The space character is the concatenation operator, which is shown as `<space>` in the following syntax:

```
attrRef <space> string s
```

Concatenates string *s* onto *attrRef* and returns the result as a string.

Unlike assignment, the attribute can be of any type, because DOORS automatically converts the value to a string.

Example

```
string s = "Created On " (current
    Object)."Created On" "\n"
```

Assignment (from attribute)

The assignment operator `=` can be used as shown in the following syntax:

```
bool b = attrRef
int i = attrRef
real r = attrRef
string s = attrRef
Date d = attrRef
```

where *attrRef* is in one of the following formats:

```
(Object o).(string attrName)
```

```
(Module m).(string attrName)
```

```
(Link l).(string attrName)
```

Operation

These assign the value of the referenced attribute *attrRef* to bool *b*, int *i*, real *r*, string *s*, or Date *d*.

Boolean assignment is slightly unusual in that it allows the retrieval of the value of an enumeration attribute with two elements, such as an attribute of type `Boolean`. The first element in the enumeration maps to `false`; the second element maps to `true`.

All assignments return the result of the assignment.

Example

```
Object o = current
Module m = current
Link l
int i    = o."Absolute Number"
real r
if (exists attribute "Cost")
    r = o."Cost"
else
    r = 0.0
string s = o."Created By"
Date    d = o."Created On"
bool    b = o."OLE"
print i " " r " " s " " d " " b "\n"
for l in o->"*" do {
    string s1 = l."Last Modified By"
    print s1 "\n"
}
string desc = m."Description"
print desc "\n"
int i2, i3
i3 = i2 = o."Absolute Number"
```

Assignment (to attribute)

The assignment operator `=` can be used as shown in the following syntax:

```
attrRef = bool b
```

```

attrRef = int i
attrRef = real r
attrRef = string s
attrRef = Buffer b
attrRef = Date d

```

where *attrRef* is in one of the following formats:

```

(Object o).(string attrName)
(Module m).(string attrName)
(Link l).(string attrName)

```

Operation

Assigns bool *b*, int *i*, real *r*, string *s*, Buffer *b*, or Date *d* to the attribute reference *attrRef*.

Again, boolean assignment allows the setting of an enumeration attribute that has two elements in its definition, such as an attribute of type Boolean.

Example

```

Object o = current
o."Object Heading" = "Front Matter"
o."Integer Attribute" = 2
o."Accepted" = false

```

canRead, canWrite (attribute)

Declaration

```

bool canRead(Module m,
              string attrName)
bool canWrite(Module m,
              string attrName)
bool canRead(attrRef)
bool canWrite(attrRef)

```

where *attrRef* is in one of the following formats:

```

(Object o).(string attrName)
(Module m).(string attrName)
(Link l).(string attrName)

```

Operation

The first two forms return whether the current DOORS user can read or write values of the attribute name *attrName* in module *m*.

The third and fourth forms allow you to use the dot notation directly.

Example

```
// Test current user permission
Module m
const string ACreatedBy = "Created By"
if (!canWrite(m, ACreatedBy) &&
    canRead(m, ACreatedBy)) {
    print "I can only read.\n"
}
// Use dot notation
Object o = current
const string ACreatedBy = "Created By"
if (!canWrite o.ACreatedBy && canRead o.ACreatedBy) {
    print "I can read the attribute but I cannot
        write to it.\n"
}
```

type (attribute)

Declaration

```
string type(Module m,
            string attrName)
```

```
string type(attrRef)
```

where *attrRef* is in one of the following formats:

```
(Object o).(string attrName)
```

```
(Module m).(string attrName)
```

```
(Link l).(string attrName)
```

Operation

The first form returns the name of the type of the attribute named *attrName* in module *m*.

The second form allows you to use the dot notation directly.

Example

```
// Use dot notation
print (type (current Object)."Object Heading") "\n"
// Use module
print (type (current Module,"Object Heading")) "\n"
```

for module attributes in module

Syntax

```
for attribute in attributes(module) do {
  ...
}
```

where:

attribute is a string variable
module is a variable of type Module

Operation

Assigns the string *attribute* to be each successive attribute that is defined for *module*.

Example

```
string modAttrName
for modAttrName in attributes (current Module) do
  print modAttrName "\n"
```

for object attributes in module

Syntax

```
for objAttrName in module do {
  ...
}
```

where:

objAttrName is a string variable
module is a variable of type Module

Operation

Assigns the string *objAttrName* to be each successive attribute that is defined for objects in *module*.

Example

```
string objAttrName
for objAttrName in (current Module) do print objAttrName "\n"
```

unicodeString

Declaration

```
string unicodeString(Attr__)
```

Operation

Returns the value of the specified attribute as plain text. If the attribute contains rich text including characters in Symbol font, then these characters are converted to the Unicode equivalents.

Example

```
Object o = current
string s = unicodeString (o."Object Text")
print s "\n"
```

getBoundedUnicode

Declaration

```
string getBoundedUnicode(Attr__, int maxSize)
```

Operation

Returns a plain text value derived as in `unicodeString(Attr__)`, but limited to a maximum number of characters as specified by the `maxSize` argument.

Example

```
Object o = current
string s = getBoundedUnicode(o."Object Text", 11)
print s "\n"
```

Attribute value access controls

This section describes functions that report on access rights for an attribute value.

canCreate (attribute)

Declaration

```
bool canCreate(Module m,
                string attrName)
bool canCreate(attrRef)
```

where *attrRef* is in one of the following formats:

```
(Object o).(string attrName)
```

```
(Module m).(string attrName)
```

```
(Link l).(string attrName)
```

Operation

The first form returns `true` if the current DOORS user can create values of the attribute name *attrName* in module *m*. Otherwise, returns `false`.

The second form allows you to use the dot notation directly.

canControl (attribute)

Declaration

```
bool canControl(Module m,
                string attrName)
```

```
bool canControl(attrRef)
```

where *attrRef* is in one of the following formats:

```
(Object o).(string attrName)
```

```
(Module m).(string attrName)
```

```
(Link l).(string attrName)
```

Operation

The first form returns `true` if the current DOORS user can change the access controls on the attribute name *attrName* in module *m*. Otherwise, returns `false`.

The second form allows you to use the dot notation directly.

canModify (attribute)

Declaration

```
bool canModify(Module m,
                string attrName)
```

```
bool canModify(attrRef)
```

where *attrRef* is in one of the following formats:

```
(Object o).(string attrName)
```

```
(Module m).(string attrName)
```

```
(Link l).(string attrName)
```

Operation

The first form returns `true` if the current DOORS user can modify values of the attribute name `attrName` in module `m`. Otherwise, returns `false`.

The second form allows you to use the dot notation directly.

canDelete (attribute)

Declaration

```
bool canDelete (Module m,
               string attrName)
```

```
bool canDelete (attrRef)
```

where `attrRef` is in one of the following formats:

```
(Object o).(string attrName)
```

```
(Module m).(string attrName)
```

```
(Link l).(string attrName)
```

Operation

The first form returns `true` if the current DOORS user can delete values of the attribute name `attrName` in module `m`. Otherwise, returns `false`.

The second form allows you to use the dot notation directly.

Multi-value enumerated attributes

This section defines functions that apply to multi-value enumerated attributes.

Assignment (enumerated option)

The assignment operators `+=` and `-=` can be used as shown in the following syntax:

```
attrRef += string s
```

```
attrRef -= string s
```

where `attrRef` is in one of the following formats:

```
(Object o).(string attrName)
```

```
(Module m).(string attrName)
```

```
(Link l).(string attrName)
```

Operation

Adds or removes an enumerated option from the value of the attribute.

Example

This example adds "Australia" to the list of values of the attribute "Country" of the current object, and removes "Borneo".

```
Object o = current
o."Country" += "Australia"
o."Country" -= "Borneo"
```

isMember

Declaration

```
bool isMember(attrRef,
              string s)
```

where *attrRef* is in one of the following formats:

```
(Object o).(string attrName)
```

```
(Module m).(string attrName)
```

```
(Link l).(string attrName)
```

Operation

Returns true if the option specified as *s* is present in the multi-value attribute.

Example

```
if (isMember((current Object)."Country", "Australia")) {
    addRequirement("Right-hand drive model
                  needed")
}
```

Attribute definitions

This section defines functions and a for loop that manipulate DOORS attribute definitions. The fundamental type used is `AttrDef`, which is a handle on an attribute definition.

Note: Reloading a module (for example, changing edit modes) in a DXL script destroys any attribute definition values currently assigned to variables in that script. If a module is reloaded, reassign the attribute definitions.

Attribute definition properties

Properties are defined for use with the `.` (dot) operator and an attribute definition handle to extract information from an attribute definition, as shown in the following syntax:

```
(AttrDef ad).property
```

The following tables list the properties and the information they extract:

String property	Extracts
<code>dxl</code>	DXL text of an attribute that uses DXL attribute.
<code>name</code>	The name of an attribute definition.
<code>typeName</code>	The name of the type of an attribute definition.
<code>description</code>	The description of the attribute definition.

Boolean property	Extracts
<code>canWrite</code>	Whether the user can delete the attribute definition.
<code>defval</code>	Whether the attribute definition is for an attribute that has a default value.
<code>dxl</code>	Whether the attribute definition is for an attribute that has its value generated by DXL.
<code>hidden</code>	Whether the attribute definition is for an attribute that is hidden. This function is provided only for forward compatibility with future releases of DOORS.
<code>inherit</code>	Whether the attribute definition is for an attribute that is inherited.
<code>module</code>	Whether the attribute definition is defined for the module.
<code>multi</code>	Whether the attribute definition is of the multi-value enumeration type.
<code>nobars</code>	Whether the attribute definition is for an attribute that does not alter change bars.
<code>nochanges</code>	Whether the attribute definition is for an attribute that does not change modification status attributes.
<code>nohistory</code>	Whether the attribute definition is for an attribute that does not generate history.
<code>object</code>	Whether the attribute definition is defined for objects.
<code>system</code>	Whether the attribute is system defined.

Boolean property	Extracts
<code>useraccess</code>	Whether users can update the value of the attribute. For example, for a system attribute such as "Last Modified On" it returns <code>false</code> , because users can never update it, regardless of access controls. For an attribute such as "Object Heading" it returns <code>true</code> , because users can update its value provided they have appropriate access controls.

Any type property	Extracts
<code>type</code>	An <code>AttrType</code> for the attribute type of the attribute definition.

Default property	Extracts
<code>defval</code>	The default value for the attribute definition; for correct operation, always assign the result to a variable of the correct type for the attribute.

Example

This example uses string properties:

```
// name
AttrDef ad = find(current Module, "Object Text")
print ad.name           // prints Object Text
// typeName
AttrDef ad = find(current Module, "Created On")
print ad.typeName      // prints Date
// dxl
AttrDef ad = find(current Module, "DXL initialized attribute")
if (ad.dxl) {
    string dxlVal = ad.dxl
    print dxlVal "\n"
}
// useraccess
AttrDef ad
Module m = current
```



```

for ad in m do {
    print ad.name "-" ad.useraccess "\n"
}
This example uses boolean properties:
// object
AttrDef ad = find(current Module, "Description")
print ad.object          // prints false
// module
AttrDef ad = find(current Module, "Description")
print ad.module         // prints true
// system
if (thisAttr.system) {
    ack "System attribute: cannot delete"
}
// canWrite
AttrDef ad
Module m = current
for ad in m do{
    print ad.name "-" ad.canWrite "\n"
}

```

This example uses the property type:

```

AttrDef ad = find(current Module, "Description")
AttrType at = ad.type
print at.name          // prints String

```

This example uses the property defval for a default value of type string:

```

AttrDef ad = find(current Module, "Created Thru")
string def = ad.defval
print def              // prints Manual Input

```

Concatenation (attribute definition)

The space character is the concatenation operator. All the individual elements of an attribute definition can be concatenated.

create (attribute definition)

Syntax

```
AttrDef create([module|object]
               [property value]...
               [(default defVal)]
               attribute(string attrName))
```

Operation

Creates a new attribute definition called *attrName* from the call to *attribute*, which is the only argument that must be passed to *create*. The optional arguments modify *create*, by specifying the value of attribute properties. The arguments can be concatenated together to form valid attribute creation statements.

The keywords *module* and *object* specify that the attribute definition being created applies to modules or objects, respectively.

The default property specifies the default value for the attribute definition being created as *defVal*. This property should always be specified within parenthesis to avoid parsing problems. The value must be given as a string, even if the underlying type is different. DOORS converts the value automatically.

As many other properties as required can be specified (defaults are the same as the DOORS GUI).

String property	Specifies
<i>dxl</i>	The code associated with an attribute in <i>dxlcode</i> .
<i>type</i>	The type of the attribute definition as <i>typeName</i> .
<i>description</i>	The description of the attribute definition.

Boolean property	Specifies
<i>changeBars</i>	Whether the attribute definition being created alters change bars.
<i>date</i>	Whether the attribute definition being created alters dates.
<i>hidden</i>	Whether the attribute definition being created is hidden. Note that this function is only provided for forward compatibility with future releases of DOORS.
<i>history</i>	Whether the attribute definition being created generates history.
<i>inherit</i>	Whether the attribute definition being created is to be inherited.
<i>multi</i>	A multi-valued attribute definition, if expression evaluates to <i>true</i> ; otherwise a single-valued attribute definition.

Example

- This example builds an attribute named "Count" which has a default value of 0:

```
create (default "0") attribute "Count"
```
- This example builds an integer attribute named "Cost" which applies to the module:

```
create module type "Integer" attribute "Total Cost"
```
- This example builds an integer attribute named "Cost" which applies to the objects in the module, but not the module itself:

```
create object type "Integer" attribute "Cost"
```
- This example uses some of the other attribute definition functions:

```
create module type "String" (default "Help") history true //-
      changeBars false date false inherit true          //-
      hidden false attribute "Usage"
```
- This example creates an "Integer" attribute definition called "Cost2", which applies only to objects:

```
create attribute "Cost2"
```
- This example creates a multi-valued attribute definition "attribute name", which uses the enumeration type "enumeration name" and sets its default to two values: value1 and value2.

```
create type "enumeration name" (default "value1\nvalue2") //-
      multi true attribute "attribute name"
```

A newline character must be used to separate the different values.
- This example defines code associated with attribute called "cost":

```
AttrDef ad = create object type "Integer" attribute "cost" //-
      dxl "int i = 10 \n obj.attrDXLName = i "
```

delete (attribute definition)

Declaration

```
string delete([Module m,]
              AttrDef ad)
```

Operation

Deletes the attribute definition *ad* from module *m*. If *m* is omitted, deletes *ad* from the current module.

Example

```
void deleteAttrDef(string s)
{
    string err
    AttrDef ad = find(current Module, s)
    err = delete(ad)
}
```

```

    if (err != "") ack err
}
deleteAttrDef "attribute_name"

```

exists

Declaration

```
bool exists(attribute(string attributeName))
```

Operation

Returns `true` if the attribute named `attributeName` exists in the current module.

Example

```

if (exists attribute "Cost")
    print "Cost is already there.\n"

```

find (attribute definition)

Declaration

```
AttrDef find(Module m,
              string attributeName)
```

Operation

Returns the attribute definition for the attribute named `attributeName` in module `m`.

Example

```
AttrDef ad = find(current Module, "Object Heading")
```

attributeValue

Declaration

```
bool attributeValue(AttrDef attrDef,
                   string s)
```

Operation

Returns `true` if the specified string contains valid data for the specified attribute definition. Returns `false` if the specified string contains invalid data for the specified attribute.

getBoundedAttr

Declaration

```
string getBoundedAttr(Attr__ attrdef,
                     int number)
```

Operation

Returns the first *number* of characters of the value of attribute definition *attrDef*.

This is particularly useful when working with attribute values that could potentially be extremely large (for example, encoded picture data) but the entire value is not required.

Example

```
Object o = current
print getBoundedAttr(o."Object Text", 3)
```

hasSpecificValue

Declaration

```
bool hasSpecificValue({Link l|Module m|Object o},
                    AttrDef attrDef)
```

Operation

Returns `true` if the attribute definition *attrDef* has a specific value for link *l*, open module *m*, or object *o*. Otherwise, returns `false`.

isVisibleAttribute

Declaration

```
bool isVisibleAttribute(AttrDef attrDef)
```

Operation

Returns `true` if the specified attribute is not a hidden attribute. Returns `false` if the specified attribute is a hidden attribute.

Note: This only applies to object attributes. It return `false` when used with module attributes.

modify (attribute definition)

Declaration

```
AttrDef modify(AttrDef old,
               [setproperty value,]
               AttrDef new)
```

Operation

Modifies an existing attribute definition by passing it a new attribute definition. The optional second argument allows you to set a single property, as follows:

String property	Sets
<code>setDefault</code>	The default string.
<code>setDXL</code>	The attribute to DXL code contained in the string argument.
<code>setName</code>	The attribute's name in a string.
<code>setDescription</code>	The attribute description.

Boolean property	Sets
<code>setBars</code>	Whether the attribute alters change bars.
<code>setDates</code>	Whether the attribute alters dates.
<code>setHidden</code>	Whether the attribute is hidden.
<code>setHistory</code>	Whether the attribute generates history.
<code>setInherit</code>	Whether the attribute is inherited.
<code>setModule</code>	Whether the attribute definition is for modules.
<code>setMulti</code>	Whether the attribute definition is a multi-valued enumeration type.
<code>setObject</code>	Whether the attribute definition is for objects.

Example

```
AttrDef ad = create object type "Integer" attribute "cost"
ad = modify(ad, object type "Integer" attribute "Costing")
ad = modify(ad, setHistory, true)
ad = modify(ad, setDefault, "123")
```

for attribute definition in module

Syntax

```
for ad in {module|modProps} do {
  ...
}
```

where:

<i>ad</i>	is a variable of type <code>AttrDef</code>
<i>module</i>	is a variable of type <code>Module</code>
<i>modProps</i>	is a variable of type <code>ModuleProperties</code>

Operation

Assigns the attribute definition *ad* to be each successive definition present in the module *module*, or *modProps*, provided the definition applies to either modules or objects.

Example

```
AttrDef ad
for ad in current Module do {
  print "Attribute: " ad.name "\n"
}
```

for module level attribute definition in {Module|ModuleProperties}

Syntax

```
for ad in attributes {mod|modprops} do {
  ...
}
```

where:

<i>ad</i>	is a variable of type <code>AttrDef</code>
<i>mod</i>	is a variable of type <code>Module</code>
<i>modprops</i>	is a variable of type <code>ModuleProperties</code>

Operation

Assigns *ad* to be the name of each successive module level attribute definition in the supplied *Module*, or *ModuleProperties*.

Attribute definition example program

```
// attribute definition DXL example
/*
  Example of Attribute Definition DXL
*/
void print(AttrDef ad) { // print out some information on ad
    print ad.name ": "
    print "type \"" ad.typeName "\""
    // does ad apply to objects?
    print (ad.object ? " object " : "")
    // does ad apply to modules?
    print (ad.module ? " module" : "")
    print (ad.inherit ? " inherit" : "")
    // are values inherited?
    AttrType typ = ad.type
    if (typ.name == "Integer" && ad.defval) {
        // print any default int value
        int d = ad.defval
        print " default " d ""
    }
    if (ad.dxl) {
        string dxlVal = ad.dxl
        print " isDxl \"" dxlVal "\""
        // does ad use DXL attribute?
    }
    print "\n"
} // print
// main program
// create two new attributes
create object type "Integer" attribute "Cost"
create module type "Integer" attribute "Total Cost"
AttrDef ad
// print module attribute definitions
```



```

print "Module attribute definitions:\n\n"
for ad in current Module do
  if (ad.module)
    print ad
// print object attribute definitions
print "Object attribute definitions:\n\n"
for ad in current Module do
  if (ad.object)
    print ad

```

For a larger example of the use of `AttrType`, `AttrDef` and `DOORS` attributes, see `$DOORSHOME/lib/dxl/utils/copyops.inc`, which allows the copying of an attribute of an object in one module to an object in another module. If the target module does not have the necessary attribute types and definitions, they are automatically constructed.

Attribute definition access controls

This section describes functions that report on access rights for an attribute definition.

canCreateDef

Declaration

```
bool canCreateDef(AttrDef attrDef)
```

Operation

Returns `true` if the current `DOORS` user has create access to the attribute definition `attrDef`.

canCreateVal

Declaration

```
bool canCreateVal(AttrDef attrDef)
```

Operation

Returns `true` if the current `DOORS` user has create access to the value of the attribute definition `attrDef`.

canControlDef

Declaration

```
bool canControlDef(AttrDef attrDef)
```

Operation

Returns `true` if the current DOORS user can change the access controls on the attribute definition *attrDef*.

canControlVal

Declaration

```
bool canControlVal (AttrDef attrDef)
```

Operation

Returns `true` if the current DOORS user can change the access controls on the value of the attribute definition *attrDef*.

canDeleteDef

Declaration

```
bool canDeleteDef (AttrDef attrDef)
```

Operation

Returns `true` if the current DOORS user can delete the attribute definition *attrDef*. Otherwise, returns `false`.

canDeleteVal

Declaration

```
bool canDeleteVal (AttrDef attrDef)
```

Operation

Returns `true` if the current DOORS user can delete the value of the attribute definition *attrDef*. Otherwise, returns `false`.

Attribute types

This section defines the functions that manipulate the types of DOORS attributes. The fundamental types used are: `AttrType`, which is a handle on an attribute type; and `AttrBaseType`, which is a handle on an attribute type's base type.

`AttrBaseType` can have the following values:

Scalar	Ranged	<code>attrDate</code>
	Ranged	<code>attrInteger</code>

	Ranged	<code>attrReal</code>
	Simple	<code>attrText</code>
	Simple	<code>attrString</code>
	Simple	<code>attrUsername</code>
Aggregate	Enumeration	<code>attrEnumeration</code>

They are used for determining the base type of an attribute type, for example, you might have an attribute type called "1 to 10" whose base type is an integer but has limits of 1 and 10.

Ranged types can have a maximum and minimum value.

Attribute type properties

Properties are defined for use with the `.` (dot) operator and an attribute type handle to extract information from an attribute type, as shown in the following syntax:

```
(AttrType at).property
```

The following tables list the properties and the information they extract:

String property	Extracts
<code>name</code>	The name of an attribute type.
<code>strings[n]</code>	provides access to the names of an enumerated attribute type; the <i>n</i> th element (counting from 0). In the DOORS user interface, this is the 'value' of the enumerated type.
<code>description</code>	The description of the attribute type
<code>description[s]</code>	The descriptions of the values in an enumerated type.

Boolean property	Extracts
<code>canWrite</code>	Whether the user can delete the attribute type.
<code>system</code>	Whether the attribute type is system defined.

Integer property	Extracts
<code>colors[n]</code> <code>colours[n]</code>	The <i>n</i> th element (counting from 0) of the array of colors used in an enumeration attribute type.

Integer property	Extracts
maxValue	The maximum value for an attribute type or tests for the presence of a maximum value. Can also be of type Real or Date.
minValue	The minimum value for an attribute type or tests for the presence of a minimum value. Can also be of type Real or Date.
size	The number of elements of an enumerated type.
values [n]	The <i>n</i> th element (counting from 0) of the array of values used in an enumeration attribute type. In the DOORS user interface, this is the 'related number' of the enumerated type.

Any type property	Extracts
type	The base type of an attribute type.

Example

```
// name
AttrType at = find(current Module, "Created Thru")
print at.name           // prints "Created Thru"
// type
AttrType at = find(current Module, "Integer")
print stringOf at.type
print at.type "\n"
// test for a minimum value
AttrType at = find(current Module, "Type with Min Int value")
if (at.minValue) {
    // Enter here if type has a minimum value.
    // The following is valid only if base type
    // is integer.
    // The operator is also defined for real and
    // date
    int i = at.minValue
}
// strings
AttrType t
t=find(current Module, "TableType")
print t.strings[1]
```

```

// size
AttrType at = find(current Module, "Boolean")
print at.size           // prints "2"
// names
AttrType at = find(current Module, "Boolean")
print at.strings[0]
print at.strings[1]
// values
AttrType at = find(current, "Boolean")
print at.values[0]
print at.values[1]
// colors
AttrType at = find(current, "Boolean")
print at.colours[0]
print at.colors[1]
// canWrite and system
AttrType at
Module m = current
for at in m do{
    print at.name "- system: " at.system"; can
        write: " at.canWrite "\n"
}

```

Concatenation (attribute base type)

The space character is the concatenation operator, which is shown as `<space>` in the following syntax:

```
AttrBaseType abt <space> string s
```

Concatenates the string *s* onto the attribute base type *abt* and returns the result as a string.

find (attribute type)

Declaration

```
AttrType find(Module m,
              string typeName)
```

Operation

Returns an attribute type handle for the attribute type named *typeName* in the module *m*, or null if the type does not exist.

Example

```
AttrType at = find (current Module, "Boolean")
if (null at)
    print "Failed\n"
```

isRanged

Declaration

```
bool isRanged(AttrType attrType)
```

Operation

Returns `true` if *attrType* is a range (can take minimum and maximum values). Otherwise, returns `false`.

isUsed

Declaration

```
bool isUsed(AttrType attrType)
```

Operation

Returns `true` if *attrType* is in use, in which case, its base type cannot be changed. Otherwise, returns `false`. For information on changing an attribute type's base type, see the `modify (attribute type)` function.

print (attribute base type)

Declaration

```
void print(AttrBaseType abt)
```

Operation

Prints the attribute base type *abt* in the DXL Interaction window's output pane.

stringOf (attribute base type)

Declaration

```
string stringOf(AttrBaseType abt)
```

Operation

Returns attribute base type *abt* as a string.

getRealColorOptionForTypes

Declaration

```
bool getRealColorOptionForTypes ()
```

Operation

Returns `true` if the values contained within the color array of an `AttrType` are real color identifiers. Returns `false` if the values are logical color identifiers (the default).

setRealColorOptionForTypes

Declaration

```
void setRealColorOptionForTypes (bool
    realColors)
```

Operation

If `realColors` is `true`, sets the values contained within the color array of an `AttrType` to real color identifiers. If `realColors` is `false`, sets the values to logical color identifiers (the default).

Note: The functions that create and modify an `AttrType` expect arrays of real colors as arguments. Therefore, prior to any calls being made to either `create (attribute type)` or `modify (attribute type)`, this function must be called setting `realColors` to `true`.

setDescription

Declaration

```
AttrType setDescription (AttrType at, string desc, string &errMsg)
```

Operation

Sets the description for the specified attribute type. Returns null if the description is not successfully updated.

for attribute type in module

Syntax

```
for at in Module m do {
    ...
}
```

where:

`at` is a variable of type `AttrType`

m is a variable of type `Module`

Operation

Assigns the variable *at* to be each successive attribute type definition found in module *m*.

Example

```
AttrType at
for at in current Module do {
    print at.name "\n"
}
```

Attribute type access controls

This section describes functions that report on access rights for an attribute type.

canCreate (attribute type)

Declaration

```
bool canCreate(AttrType attrType)
```

Operation

Returns `true` if the current DOORS user has create access to the attribute type *attrType*.

canControl (attribute type)

Declaration

```
bool canControl(AttrType attrType)
```

Operation

Returns `true` if the current DOORS user can change the access controls on the attribute type *attrType*.

canModify (attribute type)

Declaration

```
bool canModify(AttrType attrType)
```

Operation

Returns `true` if the current DOORS user can modify the attribute type *attrType*.

canRead (attribute type)

Declaration

```
bool canRead(AttrType attrType)
```

Operation

Returns `true` if the current DOORS user can read the attribute type *attrType*.

canDelete (attribute type)

Declaration

```
bool canDelete(AttrType attrType)
```

Operation

Returns `true` if the current DOORS user can delete the attribute type *attrType*. Otherwise, returns `false`.

Attribute type manipulation

This section defines functions for creating new attribute types, modifying, and deleting them.

To modify an attribute type, the user must have modify access to it (the `canWrite` property returns `true`). No changes can be made in edit shareable mode or read-only mode. System types cannot be edited (the `system` property returns `true`). For information on properties, see “Attribute type properties,” on page 375.

create (attribute type)

Declaration

```
AttrType create(string name,
                AttrBaseType abt,
                string &errmsg)
```

```
AttrType create(string name,
                {int|real|Date} min,
                {int|real|Date} max,
                string &errmsg)
```

```
AttrType create(string name,
                string codes[ ],
                [int values[ ],
                [int colors[ ],]
                [string desc[ ],]
                string &errmsg)
```

Operation

If the operation fails, all forms of `create` return an error message in `errmsg`.

The first form creates a new attribute type, of name `name` and base type `abt`.

The next form creates a new attribute type named `name`, of base type `int`, `real` or `Date`, for a range of `min` to `max`.

The last form creates enumeration types named `name`, using enumeration names `codes`, with optional values `values`, colors `colors` and descriptions `descs`.

Note: This function expects arrays of real colors as arguments. Therefore, prior to any calls being made to `create`, the `setRealColorOptionForTypes` function must be called setting `realColors` to true.

Example

```
// basic create
string errmsg = ""
AttrType at = create("Cost", attrInteger, errmsg)
if (!null errmsg)
    print "Attribute type creation failed\n"
// create enumeration type
string names[] = {"Tested", "Under Test", "Not Tested"}
int values[] = {1,2,3}
int colors[] = {-1, 20, 14}
string mess = ""
AttrType at = create("Test Status", names, values, colors, mess)
if (!null mess)
    print "Type creation failed\n"
```

delete (attribute type)

Declaration

```
bool delete(AttrType at,
            string &errmsg)
```

Operation

Deletes the `AttrType` whose handle is `at`. If the operation fails, returns an error message in `errmsg`.

modify (attribute type)

Declaration

```
AttrType modify(AttrType type, string newName, string &errmsg)
```

```
AttrType modify(AttrType type, AttrBaseType new, string &errmsg)
AttrType modify(AttrType type, string newName, string codes[ ], int values[ ],
               int colors[ ], string descsc[ ], string &errmsg)
AttrType modify(AttrType type, string newName, string codes[ ], int values[ ],
               int colors[ ], string descsc[ ], int arrMaps[ ], string &errmsg)
```

Operation

The first form changes the name of the specified attribute type to *newName*.

The second form changes the base type of the specified attribute type. If *type* is in use, the call fails.

The third form changes the name, codes, values and colors of an existing enumerated type, provided it is not in use. If *type* is in use, the following restriction applies so that the new version is not incompatible with the old:

- Colors cannot be added if type does not already have colors assigned.

The fourth form must be used when the type is currently in use by an attribute.

Note: In the user interface for DOORS 6.0, the term **values** maps to *codes*, and the term **related numbers** maps to *values*.

Note: Color numbers now refer to real colors rather than logical colors. Enumerated attribute types in DOORS 4 have their colors translated during migration.

For all forms, the *errmsg* argument is currently not used, but is reserved for future enhancements. You can trap errors using `lastError` and `noError`.

Note: This function expects arrays of real colors as arguments. Therefore, prior to any calls being made to `modify`, the `setRealColorOptionForTypes` function must be called setting *realColors* to true.

Example

//This example adds "Highest" to the end of the list of possible enumeration values, leaving the remaining value intact.

```
AttrType modifyAndAdd(AttrType atTypeToEdit, string sTypeName, string
arrValues[], int arrOrdinals[], int arrColours[], string& sErrMsg)
{
    int arrMaps[atTypeToEdit.size + 1]
    int i

    for (i = 0; i < atTypeToEdit.size + 1; i++) {
        arrMaps[i] = i;
    }

    return modify(atTypeToEdit, sTypeName, arrValues, arrOrdinals, arrColours,
arrMaps, sErrMsg)
}
```

```

setRealColorOptionForTypes(true)
string new_strings[at.size+1]
int new_values[at.size+1]
int new_colors[at.size+1]
for(i=0;i < at.size; i++)
{
    new_strings[i] = at.strings[i]
    new_values[i] = at.values[i]
    new_colors[i] = at.colors[i]
}

string errmsg
new_strings[at.size] = "highest" // This is name of new value for type
new_values[at.size] = at.size
new_colors[at.size] = -1

string at_name = at.name

AttrType at_new = modifyAndAdd(at, at_name, new_strings, new_values, new_colors,
errmsg)

```

setMaxValue

Declaration

```

bool setMaxValue(AttrType type,
                {int|real|Date} maxValue,
                bool maxApplies)

```

Operation

Specifies a maximum value for the ranged attribute type *type*, provided *maxApplies* is true.

If the call succeeds, returns true; otherwise, returns false. If *maxApplies* is false, the maximum value is ignored, and the function returns true.

If the specified maximum value is less than the minimum value, the call fails.

If the specified type is not a ranged type, or is not of the same type as *maxValue*, a run-time error occurs, which can be trapped using `lastError` and `noError`.

Example

```
Module m = current
AttrType atype = find(m, "MyType")
string sBaseType = stringOf(atype.type)
if (sBaseType == "Integer")
{
    // set a maximum of 100, and enable the
    // maximum
    setMaxValue (atype, 100, true)
}
```

setMinValue

Declaration

```
bool setMinValue (AttrType type,
                 {int|real|Date} minValue,
                 bool minApplies)
```

Operation

Specifies a minimum value for the ranged attribute type *type*, provided *minApplies* is *true*.

If the call succeeds, returns *true*; otherwise, returns *false*. If *minApplies* is *false*, the maximum value is ignored, and the function returns *true*.

If the specified maximum value is less than the minimum value, the call fails.

If the specified type is not a ranged type, or is not of the same type as *minValue*, a run-time error occurs, which can be trapped using *lastError* and *noError*.

Example

```
Module m = current
AttrType atype = find(m, "MyType")
string sBaseType = stringOf(atype.type)
if (sBaseType == "Integer")
{
    //set a minimum of 10, and enable the minimum
    setMinValue (atype, 10, true)
}
```

DXL attribute

This section defines DXL attribute and describes how to use it.

DXL attribute is an option on the Define Attribute window, which allows you to write a DXL program that calculates the value of the attribute being defined. The calculation only takes place the first time the attribute is accessed, or if it is later cleared to null and is subsequently accessed again. This means the DXL code is not executed when the containing module is opened, but when some event occurs that causes the attribute to be accessed. For example, the event could be because the attribute is being displayed in a column, or because the user opens the Formal Object Editor window on an object with a DXL attribute value.

DXL attribute provides a means of initializing an attribute using DXL, and then caching that value so that subsequent accesses of the attribute do not involve recalculation. If the code resets the attribute to the null string, recalculation occurs on the next access. Just setting the value to the null string is not sufficient to invoke recalculation. The attribute value must be accessed after the reset to null, for a recalculation to take place.

For example, if attribute "Outgoing" is displayed in a DOORS column, the initial value is calculated for each "Outgoing" attribute as the user views it. If more outgoing links are created, the attribute values do not change; to do this, the recalculation must be forced, possibly from another DXL application that contains the following:

```
Object o
for o in current Module do
    o."Outgoing" = (string null)
```

The `(string null)` ensures a null value, as compared to the integer 0, or the empty string "".

Note: The perm `void refresh (Module m)` should not be used in DXL attributes.

attrDXLName

Declaration

```
Object obj
const string attrDXLName
```

Operation

DXL attribute programs run in a context where the variable *obj* is already declared to refer to the object whose attribute is being calculated.

The constant *attrDXLName* can be used instead of a literal attribute name to refer to the attribute value that is being calculated. This allows one piece of DXL attribute to be used for several attributes without being modified.

Example

```
obj.attrDXLName = today
```

DXL attribute example program

```
This example in $DOORSHOME/lib/dxl/attrib/impact.dxl:
// impact.dxl -- example of DXL attribute
/*
```

DXL attribute provides a means of initializing an attribute using DXL, so that subsequent accesses of the attribute do not involve re-calculation.

This example of DXL attribute requires that an integer attribute named "Outgoing" exists and has been defined with the DOORS GUI to use this file as its DXL value.

"Outgoing" is set to the number of links leaving its object.

```
*/
```

```
Link 1
```

```
int count = 0
```

```
// obj is the predeclared object whose attribute  
// we are calculating
```

```
for l in obj->"*" do count++
```

```
// count outgoing links
```

```
obj."Outgoing" = count
```

```
// initialize the cached value
```

```
// resetting to (string null)
```

```
// in a DXL program
```

```
// will force re-calculation
```

```
// end of impact.dxl
```

Chapter 16

Access controls

This chapter describes access controls:

- Controlling access
- Locking
- Example programs

Controlling access

This section defines properties, operators, functions and `for` loops that work with access controls. Many of these elements use the data types `Permission` and `AccessRec`.

Properties

The following properties of type `Permission` are used for setting access controls, using the assignment operator.

<code>none</code>	
<code>read</code>	This is automatically given for <code>modify</code> , <code>create</code> , <code>delete</code> , or <code>control</code> .
<code>create</code>	Automatically confers <code>read</code> access. Automatically given for <code>control</code> .
<code>modify</code>	Automatically confers <code>read</code> access. Automatically given for <code>control</code> .
<code>delete</code>	Automatically confers <code>read</code> and <code>modify</code> access.
<code>control</code>	Automatically confers <code>read</code> , <code>modify</code> and <code>create</code> access.
<code>write</code>	This is a bitwise OR of <code>modify</code> , <code>create</code> and <code>delete</code> ; it is only supported for compatibility with earlier releases.
<code>change</code>	Identical to <code>control</code> , this is only supported for compatibility with earlier releases.

Operators

As with other data types, the assignment operator `=` is used to set a permission, as shown in the following syntax:

```
Permission p = permission
```

where:

p is a variable of type `Permission`

permission is a variable of type `Permission`

The `|` (pipe) operator performs bitwise OR operations on permissions as shown in the following syntax:

```
Permission x | Permission y
```

The `&` operator performs bitwise AND operations on permissions as shown in the following syntax:

```
Permission x & Permission y
```

The `==` relational operator performs comparison on permissions as shown in the following syntax:

```
Permission x == Permission y
```

Example

```
Permission all = read|create|modify|delete|control
```

Access status

Declaration

```
bool read(AccessRec ar)
```

```
bool create(AccessRec ar)
```

```
bool modify(AccessRec ar)
```

```
bool delete(AccessRec ar)
```

```
bool control(AccessRec ar)
```

```
bool write(AccessRec ar)
```

```
bool change(AccessRec ar)
```

Operation

Each of the first five functions returns `true` if the access record confers modify, create, delete, control, or read permission. Both `write` and `change` are supported for compatibility with earlier releases; `write` returns `true` if the access record confers modify permission, and `change` returns `true` if the access record confers control permission. If the specified permission is not present, each function returns `false`.

Note: When using these functions with groups, any information returned for create permission is redundant as there is no create permission on groups.

partition

Declaration

```
bool partition(AccessRec ar)
```

Operation

Returns `true` if the data associated with the access record has been partitioned out.

get, getDef, getVal

Declaration

```
AccessRec get({Object o|Module m|Project p|
              Folder f|Item i|View v|Group g},
              [AttrType at,]
              {string user|string group,
               string &message})
```

```
AccessRec get{Def|Val} (Module m,
                       AttrDef ad,
                       {string user|string group},
                       string &message)
```

Operation

The first form returns the access record for object *o*, module *m*, project *p*, folder *f*, item *i*, view *v*, or group *g* for DOORS user with name *user*, or group with name *group*. Optionally, for a module, the access record can be for a specific attribute type *at*.

The function `getDef` returns the access record for the attribute definition *ad* in module *m*.

The function `getVal` returns the access record for the attribute value of the attribute definition *ad* in module *m*.

For all these functions, the strings *user* or *group*, are the DOORS user or group, to whom the access record applies. If they are null, the function returns the default access record. If the operation succeeds, returns a null string in *message*; otherwise, returns an error message.

If no specific access control setting has been made, these functions return null, however, a parent object or module setting may be being inherited.

getImplied

Declaration

```
string getImplied({Object o|Module m|Project p
                  |Folder f|Item i},
                  Permission &ps)
```

Operation

Returns the permissions that are inherited by children of the resource when the user has create permission to the resource (extra access propagated by create).

Returns the permissions inherited by children of object *o*, module *m*, folder *f*, item *i*, or view *v*. Optionally, when specifying a module, the permissions can be for a specific attribute type *at*.

If the operation succeeds, returns a null string; otherwise, returns an error message.

If no specific extra access setting has been made, these functions return null, however, a parent object or module setting may be being inherited.

inherited, inheritedDef, inheritedVal

Declaration

```
string inherited({Object o|Module m|Project p
                 |Folder f|Item i|View v}
                [,AttrType at])

string inherited{Def|Val}(Module m, AttrDef ad)
```

Operation

These functions set access control to be inherited rather than specific.

The first form does this for object *o*, module *m*, project *p*, folder *f*, item *i*, or view *v*. Optionally, for a module, the access record can be for a specific attribute type *at*.

The `inheritedDef` function does this for the attribute definition *ad* in module *m*. The `inheritedVal` function does it for the attribute value of the attribute definition *ad* in module *m*.

If the operation succeeds, returns null; otherwise, returns an error message.

isAccessInherited

Declaration

```
string
isAccessInherited({Object o|Project p|
                  Folder f|Item i|View v},
                  bool &inherited)

string isAccessInherited(Module m,,
                          [AttrType at,]
                          bool &inherited)

string isAccessInherited{Def|Val}(Module m,
                                   AttrDef ad,
                                   bool &inherited)
```

Operation

Returns whether the access rights are inherited.

The first form does this for object *o*, project *p*, folder *f*, item *i*, or view *v*.

The second form does this for module *m*. Optionally, the access record can be for a specific attribute type *at*.

The `isAccessInheritedDef` function does this for the attribute definition *ad* in module *m*. The `isAccessInheritedVal` function does it for the attribute value of the attribute definition *ad* in module *m*.

If the operation succeeds, returns null; otherwise, returns an error message.

isDefault

Declaration

```
bool isDefault(AccessRec ar)
```

Operation

Returns `true` if `ar` is the default access record for a particular item; otherwise, returns `false`.

Example

```
AccessRec ar
// process module (exclude inherited rights)
for ar in current Module do
{
    // only relevant if default
    if (isDefault(ar) == true)
    {
        // .. do stuff
    }
}
```

set, setDef, setVal

Declaration

```
string set({Object o|Module m|Project p|
           Folder f|Item i|View v|Group g},
           [AttrType at,]
           Permission ps,
           {string user|string group})
string set{Def|Val}(Module m,
                   AttrDef ad,
                   Permission ps,
                   {string user|string group})
```

Operation

The first form sets permission `ps` on object `o`, module `m`, project `p`, folder `f`, item `i`, view `v` or Group `g`, for DOORS user with name `user`, or group with name `group`. Optionally, for a module, the permission can be for a specific attribute type `at`.

The function `setDef` sets the permissions for the access list of the attribute definition `ad` in module `m`.

The function `setVal` sets the permission of all values of the attribute definition `ad` in module `m`.

For all these functions, if `user/group` is null, the function modifies the default access control. If the operation succeeds, it returns a null string; otherwise, it returns an error message. When retrieving access for an item and the user/group name retrieved is being assigned to a string, ensure that an empty string is appended to the end of the assigned string.

Example

```
set(current Object, read|modify|delete|control,
     doorsname)
```

setImplied

Declaration

```
string setImplied({Object o|Module m|Project p
                  |Folder f|Item i},
                  Permission ps)
```

Operation

Sets the extra access control propagated by create for children of the resource.

Sets permission *ps* on object *o*, module *m*, project *p*, folder *f*, item *i*, or view *v*.

If the operation succeeds, returns a null string; otherwise, returns an error message.

specific, specificDef, specificVal

Declaration

```
string specific({Object o|Module m|Project p
                |Folder f|Item i|View v},
                [AttrType at])
string specific{Def|Val}(Module m,
                        AttrDef ad)
```

Operation

These functions set access control to be specific rather than inherited. The item is left with specific access rights, which are identical to the inherited rights at the time the function is called. These functions have no effect if the access rights are already specific.

The first form does this for object *o*, module *m*, project *p*, folder *f*, item *i*, or view *v*. Optionally, for a module, the access rights can be for a specific attribute type *at*.

The `specificDef` function does this for the attribute definition *ad* in module *m*. The `specificVal` function does it for the attribute value of the attribute definition *ad* in module *m*.

If the operation succeeds, returns null; otherwise, returns an error message. If the user does not have control access, the call fails.

unset, unsetDef, unsetVal, unsetAll

Declaration

```
string unset({Object o|Project p|Module m|
             Folder f|Item i|View v|Group g},
             [AttrType at,]
             {string user|string group})

string unset{Def|Val}(Module m,
                    AttrDef ad,
                    {string user|string group})

string unsetAll({Object o|Project p|Module m|
                Folder f|Item i|View v|Group g},
                [AttrType at,])

string unsetAll{Def|Val}(Module m,
                        AttrDef ad)
```

Operation

The first form clears the permission set on object *o*, project *p*, folder *f*, item *i*, View *v*, or Group *g* for DOORS user with name *user*, or group with name *group*.

The second form clears the permission set on module *m*. Optionally, clears the permission for a specific attribute type *at*.

The function `unsetDef` clears the permissions set for the access list of the attribute definition *ad* in module *m*.

The function `unsetVal` clears the permissions set for all values of the attribute definition *ad* in module *m*.

The function `unsetAll` clears all user permissions set for the specified argument.

The function `unsetAllDef` clears user permissions set for the access list of the attribute definition *ad* in module *m*.

The function `unsetAllVal` clears user permissions set for all values of the attribute definition *ad*.

If *user* (or *group*) is null, the call fails. If the operation succeeds, returns the null string; otherwise, returns an error message.

Note: Care should be taken when using these perms. The unsetting of the access controls is immediate, so if the user is removing specific access controls for an item, they must ensure that the default user has control access before use. Furthermore, care should be taken when using these perms in loops.

Example

```
Module m = current
string err = unset(m, "joe")
if (!null err){
    infoBox(err)
}
```

username

Declaration

```
string username (AccessRec a)
```

Operation

Returns the username associated with the access record *a*. A null result means that access record *a* is the default record.

Example

```
string mess
AccessRec a = get(current Object, null, mess)
if (null mess) {
    if (null a) {
        print "default record"
    } else {
        print (username a) "\n"
    }
} else {
    print "error getting access record: " mess
}
```

for access record in type

Syntax

```
for ar in type do {
    ...
}
```

where:

<i>ar</i>	is a variable of type AccessRec
<i>type</i>	is a variable of type Module, Object, Folder, Item, View, AttrDef, Group or AttrType

Operation

Assigns the variable *ar* to be each successive access record in *type*, excluding inherited access rights.

Example

```
AccessRec ar
for ar in current Object do {
    string user = username ar
}
```



```

    if (null user) {
        print "default"
    } else {
        print user
    }
    print " can read? " (read ar) "\n"
}

```

for access record in all type

Syntax

```

for ar in all type do {
    ...
}

```

where:

ar is a variable of type `AccessRec`

type is a variable of type `Module`, `Object`, `Folder`, `Item`, `View`, `AttrDef`, or `AttrType`

Operation

Assigns the variable *ar* to be each successive access record in *type*, including inherited access rights.

for access record in values

Syntax

```

for ar in values(AttrDef ad) do {
    ...
}

```

where:

ar is a variable of type `AccessRec`

ad is a variable of type `AttrDef`

Operation

Assigns the variable *ar* to be each successive record found for the list of attribute values obtained by passing the attribute definition *ad* to the function `values`.

Example

```

AccessRec ar
AttrDef ad = find(current, "Object Heading")

```

```

for ar in values ad do {
    print (username ar) " can read " (read ar)
        "\n"
}

```

Locking

This topic defines functions that are used in conjunction with access controls to implement shared access to modules.

In the context of access control, a section is defined as anything with a specific access control, along with everything that inherits that access control.

The lock manager functions are described in “Locking,” on page 812.

isLockedByUser

Declaration

```
bool isLockedByUser(Object o)
```

Operation

Returns `true` if the specified object is locked by the current user when in edit shareable mode. Otherwise, returns `false`.

This function is not equivalent to checking whether the current user can modify the given object.

lock (object)

Declaration

```
string lock(Object o)
```

Operation

Locks object `o`. If the operation succeeds, returns `null`; otherwise, returns an error message.

This function only makes sense when `o` is in a module that has been opened shareable.

Example

```

if (isShare current) {
    string mess = lock current Object
    if (!null mess)
        print "lock failed: " mess "\n"
}

```

Unlock object functions

Declaration

```
bool unlockDiscard{All|Section}(Object o)
```

```
bool unlockSave{All|Section}(Object o)
```

Operation

These functions unlock sections. The functions `unlockDiscardAll` and `unlockSaveAll` unlock all sections in the module containing `o`. The functions `unlockDiscardSection` and `unlockSaveSection` unlock the section containing `o`.

The functions either discard changes or save changes before unlocking according to the function name.

If the operation is successful, returns `true`; otherwise, returns `false`.

Example programs

This section contains two example programs.

Setting access control example

This example shows how to set the default specific access rights, assuming the calling user has permission so to do.

```
// access control setting example
/*
  Example Access control setting program.
  Sets all objects in the current display set
  (i.e. respecting filtering, outlining, level,
  etc.) to have a specific access control, thus
  enabling them to be locked in shareable mode.
  Current module must be editable, and is then
  reopened shareable.
*/
if (null current Module) {
    ack "Please run this program from a module"
    halt
} else if (!isEdit current) {
    ack "current module must be editable to set
    permissions"
    halt
} else if ((level current Module)==0) {
    ack "Please set a specific level display\n" //-
    "all objects at this level will be made\n"
```

```

//-
    "lockable by giving them a specific
    default\n" //-
    "access control"
    halt
}
Object o
string modName = (current Module)."Name" ""
for o in current Module do {
    string err
    if (level o != level current Module)
        // just make selected level lockable
        continue
// alter the default ACL record
    err = set(o,read|modify|delete|control,null)
    if (!null err) {
        ack "problem setting default ACL: " err
        halt
    }
}
save current          // save our work
if (close current)
    share modName
// open with new lockable sections

```

Reporting access control example

The following program illustrates some more access control features:

```

// access control example
/*
    Example Access Control DXL
*/
if (null current Module) {
    ack "Please run this program from a module"
    halt
}
// function to display an ACL record:
bool showAcl(string user, AccessRec acl, string type) {
    string thisuser = (username acl)

```

```

    if (thisuser != user) return false
    print "User: " user " has "
    bool something = false
    if (read acl) {
        something = true
        print "read "
    }
    if (modify acl) {
        something = true
        print "modify "
    }
    if (delete acl) {
        something = true
        print "delete "
    }
    if (control acl) {
        something = true
        print "control "
    }
    if (!something) print "no "
    print "powers on " type "\n"
    return true
}

string user = doorsname
AccessRec acl
bool found = false
for acl in current Module do {
    if (showAcl(user, acl, "current module")) {
        found = true
        break
    }
}
if (!found)
    print "default permission in current module\n"
found = false
for acl in current Object do {
    if (showAcl(user, acl, "current object")) {
        found = true
        break
    }
}
}

```

```
if (!found)
    print "default power on current object\n"
string fail
fail = set(current Module, change, user)
if (!null fail)
    print "Setting change failed for current
        module: " fail "\n"
```

Chapter 17

Templates

This chapter describes template functions and expressions:

- Template functions
- Template expressions

Template functions

This section defines functions that allow you to construct a simple, formal module template: essentially a table of contents. The functions use the `Template` data type. The templates section of the DXL Library contains many examples.

Note: If you are creating new DXL files that are to be included in the templates list available in the DOORS client, and the template name, which appears at the top of the DXL file, uses unicode multibyte characters, you must save the DXL file as UTF-8 encoding.

template

Declaration

```
Template template(string h)
```

Operation

Returns a template that builds a single object with string *h* as its heading.

Example

```
Template t = template "trivial"
```

instance

Declaration

```
void instance(Template t)
void instance(below(Template t))
```

Operation

The first form creates an instance of template *t* immediately after the current object and at the same level, or at the first object position in an empty module.

The second form creates an instance of the template below the current object.

Example

```
// same level
Template t = template "trivial"
instance t
// below
Template t = template "trivial"
instance below t
```

Template expressions

This section defines the operators used to assemble templates in expressions.

Operators

Template expression operators can be used as shown in the following syntax:

```
Template t <> string h
Template t << string h
Template t >> string h
```

Each operator adds an object with heading *h* at a specific level of template *t*, and returns the new template. The levels are:

<>	current level
<<	next level down
>>	next level up

The following syntax can be used to specify a number of levels up:

```
Template t >> int n <> string h
```

In this form, the second operator can be replaced by << or >>.

Example

This example adds an object at the same level, then another at the level below:

```
Template t = template "A" <> "B" << "B.A"
instance t
```

This example adds an object at the same level, then a series of objects each one level lower. B.A.A.A.A is four levels below A and B; the instance of the new template needs to be at the same level as B, so C is added four levels above B.A.A.A.A:

```
Template t = template "A" <>  
    "B" <<  
    "B.A" <<  
    "B.A.A" <<  
    "B.A.A.A" <<  
    "B.A.A.A.A" >> 4 <>  
    "C"
```

instance t

This example is equivalent to:

```
Template t = template "A" <>  
    "B" <<  
    "B.A" <<  
    "B.A.A" <<  
    "B.A.A.A" <<  
    "B.A.A.A.A" >> 3 >>  
    "C"
```

instance t

Chapter 18

Dialog boxes

This chapter describes DXL facilities for creating DOORS dialog boxes, which are any windows constructed by DXL. Throughout this manual, the term **dialog box** is used to mean DOORS dialog box. This chapter covers:

- Icons
- Message boxes
- Dialog box functions
- Dialog box elements
- Common element operations
- Simple elements for dialog boxes
- Choice dialog box elements
- View elements
- Text editor elements
- Buttons
- Canvases
- Complex canvases
- Toolbars
- Colors
- Simple placement
- Constrained placement
- Progress bar
- DBE resizing
- HTML Control
- HTML Edit Control

An extensive example of all dialog box functions can be found in `ddbintro.dxl` in the DXL example directory.

Icons

This section defines constants and functions for using icons within dialog boxes. The functions use the `Icon` data type.

Constants

Declaration

Icon iconDatabase

Icon iconProject

Icon iconProjectCut

Icon iconProjectDeleted

Icon iconProjectOpen

Icon iconProjectOpenDeleted

Icon iconFormal

Icon iconFormalCut

Icon iconFormalDeleted

Icon iconLink

Icon iconLinkCut

Icon iconLinkDeleted

Icon iconDescriptive

Icon iconDescriptiveCut

Icon iconDescriptiveDeleted

Icon iconFolder

Icon iconFolderCut

Icon iconFolderDeleted

Icon iconFolderOpen

Icon iconFolderOpenDeleted

Icon iconDatabase

Icon iconGroup

Icon iconGroupDisabled

Icon iconUser

Icon iconUserDisabled

Icon iconReadOnly

Icon iconNone

Operation

These standard icon values can be used in functions where a value of type `Icon` is required. Icon constants starting `folder` are for tool bars; those starting `icon` are for list and tree views. Use the `set (icon)` function to specify an icon. Use the same function with `iconNone` to remove an icon. You can also load icons from disk. For further information, see the `load` function.

Example

```
set(theTab, 0, iconDatabase)
```

load

Declaration

```
Icon load(string fileName)
```

Operation

Loads an icon from disk. The *fileName* argument must be a full path.

For Windows platforms, if the file has an extension `.ico`, DOORS assumes it is a Windows icon file; otherwise, DOORS assumes it is a Windows bitmap.

Masks only work with icon files, not with bitmaps. An icon file should represent an image of either 16x16 or 32x32 pixels. The file should have no more than 8 bits per pixel (256 colors).

On UNIX platforms, icon files are `.xpm` (X PixMap) files; icons are Motif Pixmaps. For further information, see the XPM documentation.

Example

```
Icon i = load("c:\\test.ico")
set(theTab, 0, i)
```

destroy (icon)

Declaration

```
void destroy(Icon iconName)
```

Operation

Frees up resources used by *iconName*. Use this when you destroy a dialog box; for further information, see the `destroy (dialog box)` function.

Example

```
Icon ic = load("c:\\test.ico")
set(theTab, 0, ic)
// .. then on program close
destroy ic
```

Message boxes

This section defines functions that create message boxes. Message boxes provide a convenient way of informing users of events, such as confirmations or errors. The functions use the DB data type.

acknowledge

Declaration

```
void ack[nowledge] ([DB box,]  
                  string message)
```

Operation

Pops up a message box containing the message and an **Acknowledge** or **OK** button, depending on platform, in a manner compatible with the rest of DOORS. Execution of the DXL program is suspended until the user clicks **Acknowledge** or **OK**.

The optional DB *box* argument positions the message box over a specific dialog box.

Example

```
ack "Invalid weight supplied for grommet"
```

errorBox

Declaration

```
void errorBox ([DB box,]  
              string message)
```

Operation

Pops up a message box containing the error and an **Acknowledge** or **OK** button, depending on platform, in a manner compatible with the rest of DOORS. Execution of the DXL program is suspended until the user clicks **Acknowledge** or **OK**.

The optional DB *box* argument positions the message box over a specific dialog box.

Example

```
errorBox "Path does not exist"
```

infoBox

Declaration

```
void infoBox ([DB box,]  
             string message)
```

Operation

Pops up a message box containing information and an **Acknowledge** or **OK** button, depending on platform, in a manner compatible with the rest of DOORS. Execution of the DXL program is suspended until the user clicks **Acknowledge** or **OK**.

The optional `DB box` argument positions the message box over a specific dialog box.

Example

```
infoBox "Insufficient space on specified drive"
```

warningBox

Declaration

```
void warningBox([DB box,]
                string message)
```

Operation

Pops up a message box containing the warning and an **Acknowledge** or **OK** button, depending on platform, in a manner compatible with the rest of DOORS. Execution of the DXL program is suspended until the user clicks **Acknowledge** or **OK**.

The optional `DB box` argument positions the message box over a specific dialog box.

Example

```
warningBox "This deletes all files - continue?"
```

confirm

Declaration

```
bool confirm([DB box,]
             string message,
             int severity)
```

Operation

Pops up a confirmation box containing the message and buttons labeled **Confirm** and **Cancel**. The *severity* argument controls the icon displayed in the message box; the value can be one of `msgInfo` (blue **i**), `msgWarning` (red **X**), `msgError` (yellow **!**), or `msgQuery` (black **?**). The DXL program is suspended until the user clicks one of the buttons, when the function returns `true` for **Confirm** and `false` for **Cancel**.

Note: The use of `\t` within the *message* string is not supported.

The optional *box* argument positions the message box over a specific dialog box.

Example

```
if (confirm "Delete all records?")
    deleteRecords
```

query

Declaration

```
int query([DB box,]
          string message,
          string[] buttons)
```

Operation

Displays a message box with the message and buttons with the labels provided in the string array. The DXL program is halted until the user clicks one of the buttons, when the function returns with the index for that button.

The optional `DB box` argument positions the message box over a specific dialog box.

Example

```
string analyopts[] = {"Linear", "Quadratic",
                    "Spline"}

int mode = query("Select analysis model",
                analyopts)

if (mode == 0) {
    doLinearAnalysis
} else if (mode == 1) {
    doQuadraticAnalysis
} else {
    doSplineAnalysis
}
```

messageBox

Declaration

```
int messageBox([DB box,]
               string message,
               string buttons[],
               int severity)
```

Operation

Displays a message box with the message, and buttons with the labels provided in the string array. The *severity* argument controls the title of the message box; the value can be one of `msgInfo` (blue **i**), `msgWarning` (red **X**), `msgError` (yellow **!**), or `msgQuery` (black **?**). The DXL program is halted until the user clicks one of the buttons, when the function returns with the index for that button.

The optional `DB box` argument positions the message box over a specific dialog box.

Example

```
string buttons[] = {"Yes", "No", "Cancel"}
```



```
int answer = messageBox("Do you want save?",
                        buttons, msgQuery)

print answer

confirm("Really?", msgWarning)
```

Dialog box functions

This section defines functions for dialog boxes, which are built around the data type DB. Dialog boxes contain elements, such as buttons, fields or labels, which are represented by the data type DBE.

baseWin

Declaration

```
void baseWin(DB box)
```

Operation

This function is only for use in batch mode.

Displays the dialog box and suspends execution of the DXL program. Execution continues in callbacks from the buttons on the dialog box. No code should be placed after a call to `baseWin`, because it would never be executed.

block

Declaration

```
void block(DB modalBox)
```

Operation

Displays a modal dialog box. When a modal dialog box is displayed, the rest of the DOORS interface is insensitive, leaving only the given dialog box able to receive input. The interface remains in this state until either the dialog box is closed or the `release` function is called.

Unlike `show`, DXL program execution is resumed after the call to `block` when the modal dialog box is released.

Example

```
block importantQuesBox
processResult
```

busy

Declaration

```
void busy(DB box)
```

Operation

Sets the window busy, displaying the waiting cursor and making it insensitive to input. Use the `ready` function to reset the dialog box to normal.

Example

```
busy stressResultsBox
```

centered

Declaration

```
DB cent[er]red(string title)
```

Operation

Creates a dialog box that is centered on the screen. Nothing appears on the screen until it is passed to either the `block` or `show` (dialog box) function, when the dialog box window title bar contains *title*.

Example

```
DB splashBox = centered "Welcome to Example"
```

create (dialog box)

Declaration

```
DB create([ {Module|DB} parent, ]
          string title
          [,int options])
```

Operation

Creates a new, empty dialog box structure. Nothing appears on the screen until it is passed as an argument to `show`, when the dialog box window title bar contains *title*.

The optional first argument creates a child window of the module or dialog box specified by *parent*. When a child window is hidden, its parent is put in front of any other windows. The optional third argument defines the style of the dialog box; it can have bitwise OR combinations of the following values:

Constant	Meaning
<code>styleStandard</code>	Appears like other DOORS windows.
<code>styleFixed</code>	Has no resizing capability.

Constant	Meaning
<code>styleCentered</code>	Appears in the center of the screen.
<code>styleCentred</code>	Appears in the center of the screen.
<code>styleFloating</code>	Appears above all other DOORS windows.
<code>styleNoBorder</code>	Has no title bar or resizing capability.
<code>styleThemed</code>	Inherits themed styles into tabs
<code>styleAutoParent</code>	Automatically set the parenting of controls based on layout information

Example

```
DB parseBox = create("Sim File Parser", styleCentered|styleFixed)
label(parseBox, "Nothing in here yet")
show parseBox
```

createButtonBar

See “createButtonBar,” on page 553.

createItem

See “createItem,” on page 553.

createCombo

See “createCombo,” on page 557.

destroy (dialog box)

Declaration

```
void destroy(DB box)
```

Operation

Frees up resources used by *box*. The specified *box* should not be used after it has been destroyed without being re-initialized. After using `destroy`, you should set *box* to `null`.

If the dialog box used icons, you should also destroy them using the `load` function.

Note: Destroy should not be used within a callback function for a DBE.

Example

```
void okCB(DB box){
    hide(box)
    destroy(box)
    box = null
}
DB test = create("test")
ok(test, "OK", okCB)
show test
```

getPos

Declaration

```
void getPos(DB myWindow,
            int& x,
            int& y)
```

Operation

Returns in *x* and *y* the screen co-ordinates of the origin of the specified window.

getSize

Declaration

```
void getSize(DB myWindow,
             int& w,
             int& h)
```

Operation

Returns in *h* and *w* the height and width of the specified window. Dimensions are returned in pixels.

getTitle

Declaration

```
string getTitle(DB myWindow)
```

Operation

Returns the title of the specified window.

getBorderSize

Declaration

```
int getBorderSize(DB myWindow)
```

Operation

Returns the width in pixels of the border for the specified dialog box.

Example

```
DB DBox = create("Dialog Box", styleCentered|styleFixed)
int i = getBorderSize(DBox)
label(DBox, "Border size is " i "")

show DBox
```

getCaptionHeight

Declaration

```
int getCaptionHeight(DB myWindow)
```

Operation

Returns the height in pixels of the caption area for the specified dialog box.

Example

```
DB DBox = create("Dialog Box", styleCentered|styleFixed)
int i = getCaptionHeight(DBox)
label(DBox, "Caption height is " i "")

show DBox
```

help, gluedHelp

Declaration

```
void {gluedH|h}elp(DB box,
                  int index)
```

Operation

Adds a **Help** button to a dialog box *box*. When the user clicks the button, help is activated displaying the entry identified by the *index* number.

The optional second argument associates the **Help** button with the named *helpFile* and an entry *index* in it. The help file must be in the appropriate format for the platform and must be referenced by a full path name; a relative path does not work in this case. This can be used to add user-defined help information to DOORS.

When a dialog box has a large number of buttons, the `gluedHelp` function is used to link the help button to the last button, to prevent them from overlapping.

These functions can only refer to help entries in the standard DOORS help file, `DOORS.HLP`. In addition the following standard values can be used to obtain help system functions:

- | | |
|---|---------------|
| 1 | Contents page |
| 2 | Help on help |
| 3 | Search help |

Example

```
help(simParse, 301)
help(simParse, "SIMPARSE.HLP", 1)
```

helpOn

Declaration

```
void helpOn(DB box,
            [string helpFile,]
            int index)
```

Operation

These functions are used in callbacks to activate the help system on a given topic. If the optional second argument is used, the help file must be in the appropriate format for the platform and must be referenced by a full path name; a relative path does not work in this case.

Example

```
void explainData(DB key) {
    helpOn(getParent key, "DATA.HLP", 1)
} // explainData

button(dataBox, "Explain", explainData)
```

hide (dialog box)

Declaration

```
void hide(DB box)
```

Operation

Removes dialog box *box* from the screen.

Example

```
hide thisBox
```

raise

Declaration

```
void raise(DB box)
```

Operation

Brings dialog box *box* to the top, over all other windows.

Example

```
raise tempBox
```

setFocus

Declaration

```
void setFocus(Module m)
```

Operation

Sets the windows focus on the module *m*.

ready

Declaration

```
void ready(DB box)
```

Operation

Used after a call to *busy*, this function makes dialog box *box* sensitive to input again, and removes the waiting cursor.

Example

```
ready graphBox
```

realize (pending)

Declaration

```
void realize(DB box)
```

Operation

Creates and displays the dialog box without suspending execution of the DXL program. The dialog box only becomes active when a `show` function is called, either for this dialog box or another.

This function is used where you wish to do something that can only be done once the dialog box internal structure has been created, for example, add columns to a list view. Creating the internal structure is called *realization*.

Example

```
realize infoBox
```

realize (show)

Declaration

```
void realize(DB myWindow,
            int x,
            int y)
```

Operation

Creates the specified window and initializes its origin to the co-ordinates (x, y) .

release

Declaration

```
void release(DB modalBox)
```

Operation

Hides the modal dialog box *modalBox*, and resumes execution of the DXL program after the call to `block`. The DOORS interface then becomes operative.

Example

```
release importantQuesBox
```

show (dialog box)

Declaration

```
void show(DB box)
```

Operation

Displays the dialog box and suspends execution of the DXL program. Execution only continues in callbacks from the buttons on the dialog box. No code should appear after a `show` as it would never be executed.

Example

```
show splashBox
```

showing

Declaration

```
bool showing(DB box)
```

Operation

Returns `true` if *box* is displayed as a result of a call to `show` or `realize`.

Example

```
if (showing infoBox) { ... }
```

getParent

Declaration

```
{DB|DBE} getParent(DBE element)
```

Operation

Returns the parent dialog box or dialog box element of the specified dialog box element. This is useful in callback functions.

If the function that returns an object of type `DBE` is called, and the parent is not an object of type `DBE`, the function returns `null`.

Example

```
void takeAction(DBE button) {  
    DB enclosedby = getParent button  
    // user code here  
} // takeAction
```

setParent

Declaration

```
void setParent(DB box|DBE child,  
              {DB|DBE|Module} parent)
```

Operation

Sets the parent of *child* to be *parent*.

setPos

Declaration

```
void setPos(DB myWindow,  
            int x,  
            int y)
```

Operation

Sets the screen co-ordinates of the origin of the specified window to the co-ordinates (x, y).

setCenteredSize

Declaration

```
void setCenteredSize(DB box,  
                    int width,  
                    int height)
```

Operation

Sets the width and height of *box* to *width* and *height* pixels, independently of any styles used, such as *styleCentered* or *styleFixed*.

This function must be placed after a call to the *realize* (pending) function, and before any further call to either the *show* (dialog *box*) or *block* functions.

Example

```
DB dlg = create("Test Window", styleCentered |  
               styleFixed)  
  
realize dlg  
// both width and height are specified in pixels  
setCenteredSize(dlg, 300, 100)  
show dlg
```

setSize

Declaration

```
void setSize(DB myWindow,  
             int w,  
             int h)
```

Operation

Sets the width and height of the specified window to the values in *w* and *h*. Dimensions are specified in pixels.

setTitle

Declaration

```
void setTitle(DB myWindow,  
             string newTitle)
```

Operation

Sets the title of the specified window to *newTitle*. This function is used after the window is created.

startConfiguringMenus

Declaration

```
void startConfiguringMenus({DB box|DBE element})
```

Operation

Starts menu creation and configuration in *box* or *element*. To stop menu creation and configuration for a dialog box element, use the `stopConfiguringMenus` function. For a dialog box, the menu configuration stops when the dialog box is shown.

stopConfiguringMenus

Declaration

```
string stopConfiguringMenus(DBE element)
```

Operation

Disables menu creation and configuration functions for the specified dialog box element. To start menu creation and configuration, use the `startConfiguringMenus` function.

topMost

Declaration

```
DB topMost(string title)
```

Operation

Creates a dialog box that always stays on top of all other windows. This can be used instead of the `create (dialog box)` function.

Example

```
DB top = topMost "TOPMOST"  
label(top, "I am on top!")
```

show top

Dialog box elements

Dialog box elements define the components of a dialog box. These are called *controls* on Windows, and *Widgets* on Motif, the most common GUI tool kit on UNIX.

Dialog box elements provide a wide range of capability, although all have the DBE data type. This manual groups the functions for DXL dialog box elements into the following categories:

- Common element operations
- Simple elements for dialog boxes
- Choice dialog box elements
- View elements
- Text editor elements
- Buttons
- Canvases
- Complex canvases

Common element operations

This section defines element operations. Unless otherwise specified, these functions can be used with *all* dialog box elements.

For dialog box elements, the `set` function has many different variants, all of which are defined in this section. There are pointers to the appropriate `set` function from other sections within this chapter.

addMenu

Declaration

```
void addMenu(DBE element,
             string title,
             char mnemonic,
             string entries[ ],
             char mnemonics[ ],
             char hots[ ],
             string help[ ],
             string inactiveHelp[ ],
```

```
[int noOfEntries,]
Sensitivity
    sensitive(int entryIndex),
    void callback(int entryIndex)
```

Operation

Adds a menu to a menu bar, canvas, list view, or tree view. If *element* is a menu bar, the new menu appears after any other menus. If *element* is a canvas, list view, or tree view, the new menu is activated by a right click. For further information on creating the dialog box elements that can take menus, see the `menuBar`, `canvas`, `listView`, and `treeView` functions.

The arguments passed are divided into two sets: those that define the menu, and those that define the menu entries, which are specified as arrays. To use fixed-size arrays all containing the same number of elements, omit *noOfEntries*. To use freely-defined arrays, specify the minimum number of elements in *noOfEntries*.

The arguments passed to the function are defined as follows:

<i>element</i>	The menu bar or canvas in which the menu is to appear; this is returned by a call to the <code>menuBar</code> or <code>canvas</code> function.
<i>title</i>	The title of the menu, as it appears in the menu bar.
<i>mnemonic</i>	The keyboard access character, normally shown underlined, which activates the menu when pressed with ALT; the value <code>ddbNone</code> means that there is no mnemonic.
<i>entries</i>	The strings that appear in the menu.
<i>mnemonics</i>	The keyboard access character for this option, normally shown underlined, which activates the option when pressed with ALT; the value <code>ddbNone</code> indicates that there is no mnemonic.
<i>hots</i>	A hot key that directly activates the option when pressed with CTRL; for example, if the value of <code>hots [3]</code> is S, CTRL+S activates the third option of the menu; the value <code>ddbNone</code> indicates that there is no hot key.
<i>help</i>	String that is displayed in the status bar of the window, if one exists, when the user passes the mouse over an active menu item.
<i>inactiveHelp</i>	String that is displayed in the status bar of the dialog box, if one exists, when the user passes the mouse over an inactive menu item.

You can construct one level of cascading menus by placing a right angle bracket (>) character at the start of an option name, indicating that it is a member of a sub-menu:

```
const string formatMenu[] = {"Size",
                            ">Small",
                            ">Normal",
                            ">Large",
                            "Style",
                            ">Bold",
                            ">Italic"}
```

This constructs a cascading menu. The first cascading menu, `Size`, opens out as follows:

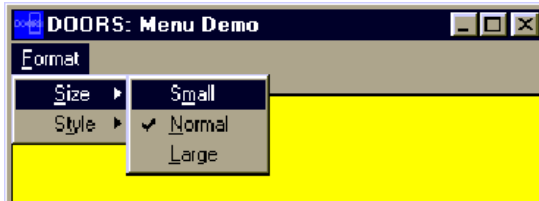

The second cascading menu, `Style`, opens out as follows:



Finally, two callback functions are required: one to determine whether menu items are sensitive, and one that is called when a menu option is activated.

The function `sensitive(int entryIndex)` is called for each option, each time the menu is displayed. The function must return one of the following values:

Availability	Meaning
<code>ddbUnavailable</code>	The menu option is grayed out.
<code>ddbAvailable</code>	The menu option is active.
<code>ddbChecked</code>	The menu entry is active and has a check beside it.

When the user selects an option, `callback(int entryIndex)` is called with the index of the option, and your program must perform the appropriate operation. For both `sensitive` and `callback` functions, `entryIndex` starts at 0, and counts up, including cascading menu entries, so there is a direct correspondence between the array elements and the index returned by the menu.

active

Declaration

```
void active(DBE element)
```

Operation

Sets an item active, restoring it from being grayed out and allowing users to interact with it. This is the opposite of the `inactive` function. The `active` function can be used with any kind of dialog box element.

Example

```
if (gotFileName) active startLoader
```

inactive

Declaration

```
void inactive(DBE)
```

Operation

Sets an item inactive, displaying it in gray and preventing users from interacting with it. This is the opposite of the `active` function. The `inactive` function can be used with any kind of dialog box element.

Example

```
if (dataNotComplete) inactive verify
```

hide

Declaration

```
void hide(DBE element)
```

Operation

Hides a single dialog box element.

Example

```
hide showAdminButtons
```

setGotFocus

Declaration

```
void setGotFocus(DBE element,  
                void callback(DBE element))
```

Operation

Sets the callback function to call when *element* gets input focus. Currently, *element* must be a list view or tree view on a Windows platform.

setLostFocus

Declaration

```
void setLostFocus(DBE element,
                 void callback(DBE element))
```

Operation

Sets the callback function to call when *element* loses input focus. Currently, *element* must be a list view or tree view on a Windows platform.

show (element)

Declaration

```
void show(DBE element)
```

Operation

Makes a single dialog box element visible again.

Example

```
show showAdminButtons
```

delete (option or item)

Declaration

```
void delete(DBE element,
            int index)
```

Operation

Deletes the option in *element* at the given *index*. The argument *element* can be a choice, tab strip, list, multi-list, combo box, or list view. Positions start at *zero*; when an element is deleted, all the others are moved down. The last element cannot be deleted in a tab strip. To delete all items in a list or list view, use the `empty` function.

Example

```
delete(components, obsoleteEntry)
```

delete (item in tree view)

Declaration

```
void delete(DBE treeView,  
           string path)
```

Operation

Deletes the item pointed to by *path*, which must be an absolute path.

Example

```
delete(treeView, "Project/Module1")
```

empty

Declaration

```
void empty(DBE element)
```

Operation

Deletes all items in a list, multi-list, choice, combo box, list view or tree view.

Example

```
empty listView1
```

insert (option or item)

Declaration

```
void insert(DBE element,  
           int index,  
           string value)
```

Operation

Inserts a new *value* into *element* at position *index*. The argument *element* can be a choice, tab strip, list, multi-list, combo box, or list view. Positions start at zero; when a new element is inserted all the other values are moved up. This function inserts duplicate values if they are specified.

Example

```
insert(months, 4, "May")
```

insert (item in list view)

Declaration

```
void insert(DBE listView,
           int row,
           string value,
           Icon icon)
```

Operation

Inserts a new item with the specified string *value* into the list view, at the zero based row number. The icon is the icon that appears to the left of the string *value* on the specified row.

insert (item in tree view)

Declaration

```
void insert(DBE treeView,
           string path,
           Icon normal,
           Icon selected)
```

Operation

Inserts the item pointed to by *path* into *treeView*. The third and fourth arguments define icons for the item when it is not selected and selected, respectively. To make the selected icon the same as the normal icon, use `iconNone` as the value for *selected*. For valid icon values, see “Icons,” on page 407.

Example

```
insert(treeView, newFolder, iconFolder,
       iconFolderOpen)
```

noElems

Declaration

```
int noElems(DBE element)
```

Operation

Returns the number of options or items in *element*. The argument *element* can be a choice, tab strip, list, multi-list, combo box, or list view.

Example

```
int noOfResources = noElems resourceList
string listContents[noOfResources]
int i
```

```
for (i = 0; i < noOfResources; i++)
    listContents = get(resourceList, i)
```

select (element)

Declaration

```
void select(DBE textElement,
           int start,
           int end)
```

Operation

Selects text only in a rich text or rich field dialog box element.

selected (element)

Declaration

```
bool selected(DBE element,
             int index)
```

Operation

Returns `true` if the option or item identified by `index` is selected; otherwise returns `false`. The argument `element` can be a list, multi-list, or list view.

Example

```
if (selected(products, ownBrand))
    print "Using own brand\n"
```

selected (item)

Declaration

```
bool selected(DBE treeView,
             string path)
```

Operation

Returns `true` if the item pointed to by `path` is selected; otherwise returns `false`. The argument `path` must be an absolute path.

get (element or option)

Declaration

```
{string|int|bool} get(DBE element
                    [,int index])
```

Operation

With one argument, returns a value for the first or only selected element of the appropriate type. The optional second argument is available only for a string return type and list views or choice dialog box elements. Use it to specify a given item in a list view or a given position in a choice element. The return types and values for all dialog box elements are as follows:

Element	Return type	Return value if selection	Return value if no selection
canvas	not supported		
check box	int	integer defining which element or elements are checked; when converted to binary, the value is a bitmap for the selection of check boxes, for example, 5 (101) means first and third boxes checked	0
choice	string	contents of selection (chosen or typed) or contents of specified choice	null string
	int	index (position) of selected option except for typed entries, which return -1 even if the typed entry matches a selection. This is the preferred method when the value being retrieved is to be used elsewhere. The number should be used as the index to retrieve the value from the original string array.	-1
field	string	contents of field	null string
	bool	if the DBE is read only, returns true; otherwise, returns false	
file name	string	path in file selector	null string
frame	not supported		
list	string	contents of selected option or specified option	null string
	int	index (position) of selected option	-1
list view	string	value of selected item or specified item	null string

Element	Return type	Return value if selection	Return value if no selection
	int	index of selected item	
multi-list	string	contents of first selected option or specified option	null string
	int	index (position) of first selected option	
radio box	int	index of the selected option in the array	not applicable
rich field	string	contents of rich field	null string
	bool	if the DBE is read only, returns true; otherwise, returns false	
rich text	string	contents of rich text box	null string
	bool	if the DBE is read only, returns true; otherwise, returns false	
slider	int	integer in range specified	-1
tab strip	string	name	not applicable
	int	index (position) of currently selected tab	not applicable
text	string	contents of text box	null string
	bool	if the DBE is read only, returns true; otherwise, returns false	
toggle	bool	true	false
tree view	string	full path of selected item	null string

You can find out the read-only status of a text or string DBE using `get` in a boolean expression.

Example

```
DB exBox = create "Use of Get"
DBE intIn = slider(exBox, "Integer:", 50, 0, 100)
DBE stringIn = field(exBox, "String:", "Example",
                    20)
void doGet(DB exBox) {
    int i = get intIn
    string s = get stringIn
}
```

```

    print i ", " s "\n"
} // doGet
apply(exBox, "Get", doGet)
show exBox

```

get (selected text)

Declaration

```

bool get(DBE textElement,
         int &first,
         int &last)

```

Applies only to text dialog box elements. It returns *true* if there is a selected area of text; otherwise, returns *false*. If it returns *true*, the integers return the start and finish indices of the selected text, starting from 0. For example, if the first ten characters are selected, *first* and *last* contain 0 and 9.

set (value or selection)

Declaration

```

void set(DBE element,
         {string|int|bool} value)
void set(DBE currDBE, Buffer b)

```

Operation

The first form sets either the value of an element or the status of the selected element as follows

The second form sets the content of the specified DBE to be the content of the Buffer.:

Element	Type	Action
canvas	not supported	
choice	int	Sets the selected option.
check box	int	Sets the selected option.
field	string	Sets the contents.
	bool	When <i>true</i> , sets field read only; otherwise, sets field read/write.
file name	string	Sets the contents.
frame	string	Sets the contents.
label	string	Sets the contents.
list	int	Sets the selected option.

Element	Type	Action
list view	int	Sets the selected item.
multi-list	int	Sets the selected option.
text	string	Sets the contents.
	bool	When true, sets text read only; otherwise, sets text read/write.
radio box	int	Sets the selected item.
rich field	string	Sets the contents.
	bool	When true, sets field read only; otherwise, sets field read/write.
rich text	string	Sets the contents.
	bool	When true, sets text read only; otherwise, sets text read/write.
slider	int	Sets the selected item.
status bar	string	Sets the contents.
tab strip	string	Sets the selected tab.
	int	Sets the selected tab.
toggle	bool	When true, sets toggle on; otherwise, sets toggle off.
tree view	string	Sets the selected item.

Using set with -1 deselects any selection in a list, choice or radio button dialog box element.

If these functions are used with an incorrect type DBE, a DXL run-time error occurs.

Example

```
DB exBox = create "Use of Put"
DBE intOut = slider(exBox, "Integer:", 50, 0,
                  100)
DBE stringOut = field(exBox, "String:",
                    "Example", 20)
void doHigh(DB exBox) {
    set(intOut, 100)
    set(stringOut, "Max out")
} // doHigh
void doLow(DB exBox) {
    set(intOut, 0)
    set(stringOut, "")
}
```

```

} // doLow
apply(exBox, "Low", doLow)
apply(exBox, "High", doHigh)
show exBox

```

set (selected status)

Declaration

```

void set(DBE list,
        int index,
        bool selected)

```

Operation

Sets the status of a selected item within a list or list view. identified by *index* in a list or list view. Valid items are ranged between position 0 and a number that can be obtained from:

```
noElems (DBE) -1
```

If this function is used with an incorrect type DBE, a DXL run-time error occurs.

set (choice element values)

Declaration

```

void set(DBE choice,
        string choices[ ]
        [,int noOfChoices])

```

Operation

Sets a new range of values into a choice element. You can supply a complete array of strings or a partially filled array with the number of items supplied in the *noOfChoices* argument.

This works only with choice dialog box elements created with the *choice* function. If this function is used with an incorrect type DBE, a DXL run-time error occurs.

Example

```

string attrNames[100]
int noOfAttrs = 0
string an
for an in current Module do
    attrNames[noOfAttrs++] = an
set(attrChoice, attrNames, noOfAttrs)

```

set (item value)

Declaration

```
void set(DBE listView,  
        int item,  
        int column,  
        string value)
```

Operation

Sets the value of a specific column item within a list view.

If this function is used with an incorrect type DBE, a DXL run-time error occurs.

set (status bar message)

Declaration

```
void set(DBE statusBar,  
        int section,  
        string message)
```

Operation

Sets the value of a particular section within a status bar.

If you use `ddbFullStatus` as *section*, the string is displayed in the full width of the status bar, as with menu help. To return to normal display, specify `ddbFullStatus` with a null string for *message*.

If this function is used with an incorrect type DBE, a DXL run-time error occurs.

set (file selector)

Declaration

```
void set(DBE fileSelector,  
        string desc,  
        string spec)
```

Operation

Sets the file selector description and extension for a dialog box file selector.

If this function is used with an incorrect type DBE, a DXL run-time error occurs.

Example

```
DB b = create "File Selector DB"  
DBE fs = fileName b  
set(fs, "Comma separated files", "*.CSV")
```

show b

set (icon)

Declaration

```
void set(DBE element,
         int index,
         [int column,]
         Icon icon)
```

Operation

Sets the displayed icon for either a tab in a tab strip or item in a list view that is identified by *index* to have the specified *icon*. The *column* argument must be passed for list views, but not for tab strips. For possible values of *icon*, see “Icons,” on page 407. Use this function with `iconNone` as the value for *icon* to remove an icon.

If this function is used with an incorrect type DBE, a DXL run-time error occurs.

Example

```
set(linkList, 2, iconLink)
```

set (select)

Declaration

```
void set(DBE element,
         void select(DBE))
```

Operation

Attaches a callback to any dialog box element other than a list view. The callback must be of the form:

```
void select(DBE option){
}
```

which fires when *option* changes.

The exact semantics vary depending on the type of element, but in principle it means a single click. For field elements, the callback only fires when the user clicks **Return** or **Enter** with the cursor in the field.

If this function is used with a list view, a DXL run-time error occurs.

Example

This example adds a callback to a radio box.

```
DB boatBox = create "Craft"

string boats[] = {"Dinghy", "Destroyer",
                 "Carrier", "Mine sweeper"}

DBE boatCheck = radioButton(boatBox, "Select
                             class:", boats, 3)
```

```

void toBuild(DBE option) {
    int favorite = get option

    ack(boatBox, "You are planning a new "
        boats[favorite] "?")
} // toBuild

set(boatCheck, toBuild)

show boatBox

```

set (key or mouse callback)

Declaration

```

void set(DBE canvas,
        void callback(DBE canv,
                      {char key|int button}
                      bool controlDown,
                      int x,
                      int y))

```

Operation

Attaches a callback to the specified canvas. The callback can be fired from character input or a mouse click, depending on the second argument passed to the callback function.

For a character input callback you must supply the code for the key, whether the control key was down, and the mouse position when the key was pressed. The key code is normally the ASCII character value, but may be one of a set of predefined constants (see “Keyboard event constants,” on page 480).

For a mouse click callback you must supply the canvas identifier, the mouse button number, starting from 1 for the left button, whether the control key was down, and the co-ordinates of the mouse at the time.

If this function is used with an incorrect type DBE, a DXL run-time error occurs.

Example

This example adds a callback to a canvas.

```

// character input callback
DB typeBox = create "Type Something"
int col = 0

void redraw(DBE x) {
    draw(x, 20, 20, "Type something!")
} // redraw

DBE can = canvas(typeBox, 300, 300, redraw)

void key(DBE can, char k, bool ctrl, int x,
        int y) {
    color(can, col)
}

```

```

    if (k == keyF2) {
        col++
    } else if (k == keyF3) {
        background(can, col++)
    } else {
        draw(can, x, y, k "")
    }
    if (col > 29) col = 0
} // key
set(can, key)
show typeBox
// mouse button callback
DB drawBox = create "Test"
void redraw(DBE x) {
    draw(x, 20, 20, "Hello!")
} // redraw
DBE can = canvas(drawBox, 300, 300, redraw)
int lastX = -1
int lastY = -1
int firstX
int firstY
int col = 0
void btn(DBE can, int bt, bool ctrl, int x,
        int y) {
    if (bt == 1) {
        if (lastX > 0) {
            line(can, lastX, lastY, x, y)
        } else {
            rectangle(can, x, y, 1, 1)
            firstX = x
            firstY = y
        }
        lastX = x
        lastY = y
    } else if (bt == 2) {
        lastX = -1
    } else if (bt == 3) {
        col++
        if (col > 29) col = 0
        color(can, col)
    }
}

```

```

} // btn
set(can, btn)
show drawBox

```

set (select and activate)

Declaration

```

void set(DBE element,
        void select(DBE),
        void activate(DBE))

```

Operation

Attaches two callback functions to a list or tree view.

The first callback fires when an item is selected (a single click); the second fires when an item is activated (a double click).

Both callbacks must be of the form:

```

void callback(DBE item) {
}

```

If this function is used with an incorrect type DBE, a DXL run-time error occurs.

Example

```

DB listBox = create "The Good Numbers"
string states[]={ "New Jersey", "Virginia", "Texas", "California", "Europe" }
string phones[]={ "201 442-4600", "703 904-4360", "817 588-3008", "408 879-2344",
"+44 1865 784285" }
DBE abcList = list(listBox, "ABC Offices:", 200, 4, states)
full listBox
DBE telNo = field(listBox, "Telephone:", "", 30, true)
void onSelection(DBE l) {
    int sel = get abcList
    if (sel >= 0) {
        set(telNo, phones[sel])
    } else {
        set(telNo, "")
    }
} // onSelection
void onActivate(DBE l) {
    int sel = get abcList
    if (sel >= 0) {
        ack(listBox,

```

```

        "Calling ABC in " states[sel] " on "
        phones[sel])
    }
} // onActivate
set(abcList, onSelection, onActivate)
show listBox

```

set (list view callback)

Declaration

```

void set(DBE listView,
        void callback(DBE, int))

```

Operation

Attaches a callback to a check box within a list view, provided the list view was created with check boxes (using the `listViewOptionCheckboxes` style). The callback must be of the form:

```

void select(DBE listView,
           int selected){
}

```

which fires when the state of any check box changes. The *selected* argument identifies the item that changed.

If this function is used with an incorrect type DBE, a DXL run-time error occurs.

set (select, deselect, and activate)

Declaration

```

void set(DBE listView,
        void select(DBE, int),
        void deselect(DBE, int),
        void activate(DBE, int))

```

Operation

Attaches three callback functions to a list view.

The first callback fires when an option is selected (a single click); the second fires when an option is deselected (a side effect of a single click on another item); the third fires when an item is activated (a double click).

All callbacks must be of the form:

```

void select(DBE listView, int selected){
}

```

If this function is used with an incorrect type DBE, a DXL run-time error occurs.

set (sort function)

Declaration

```
void set(DBE listView,
        int columnIndex,
        int dxlSortFn(string, string))
```

Operation

Attaches a sort function to a specific column within a list view. The callback must be of the form:

```
void dxlSortFn(string s1,
               string s2){
}
```

The sort function must return the following values:

Expression	Returns
<code>s1==s2</code>	0
<code>s1>s2</code>	1
<code>s1<s2</code>	-1

If this function is used with an incorrect type DBE, a DXL run-time error occurs.

set (tree view expand)

Declaration

```
void set(DBE treeView,
        bool expand(DBE, string))
```

Operation

Attaches a callback to a tree view. The callback fires when an attempt is made to expand a specific branch. The callback must be of the form:

```
void expand(DBE treeView,
            string branch){
}
```

The callback function must return the following values:

Meaning	Returns
Allow expansion	true
Refuse expansion	false

If this function is used with an incorrect type DBE, a DXL run-time error occurs.

setFocus

Declaration

```
void setFocus(DBE element)
```

Operation

Sets keyboard focus to the specified element.

getBuffer(DBE)

Declaration

```
Buffer getBuffer(DBE element)
```

Operation

Creates a new buffer object and returns it. The returned buffer contains the value of the specified DBE element.

Example

```
DB exBox = create "DBE example"
DBE stringIn = field(exBox, "String:", "Example", 20)
void doGet(DB exBox) {
    Buffer b = create
    b = getBuffer(stringIn)
    print b "\n"
} // doGet
apply(exBox, "Get", doGet)
show exBox
```

setFromBuffer(DBE, Buffer)

Declaration

```
void setFromBuffer(DBE element, Buffer b)
```

Operation

Sets the contents of the specified DBE element from the contents of the specified buffer b.

Example

```
DB exBox = create "DBE example"
```



```

DBE stringIn = field(exBox, "String:", "Example", 20)
Buffer b = create
b = "test setting DBE from buffer"
setFromBuffer(stringIn, b)
show exBox

```

useRTFColour

Declaration

```
void useRTFColour(DBE dbe, bool useRTF)
```

Operation

If dbe *dbe* is a rich text box or a rich text field, then:

- If *useRTF* is true, the underlying editbox will use the rtf color markup instead of the default color for text in dialog boxes
- If *useRTF* is false, the underlying editbox will use the default system color for text in dialog boxes
- If the dbe *dbe* is not rich text or a rich text field, nothing happens
- If the dbe *dbe* has not been realized, nothing happens

Example

```

DB test = create("Test text db")
DBE textdbe = richText(test, "test", "initial", 200, 200, false)

string colourstring =
"{\\rtf1\\ansi\\ansicpg1252\\deff0\\deflang1033{\\fonttbl{\\f0\\fswiss\\fcharse
t0 Arial;}}
{\\colortbl
;\\red255\\green0\\blue0;\\red255\\green0\\blue255;\\red0\\green0\\blue128;}
\\viewkind4\\uc1\\pard\\f0\\fs20 Some\\cf1 text \\cf0 with \\cf2 different\\cf0
\\cf3 colors\\cf0 in it.\\par
\\par
}"

realize test
useRTFColour(textdbe, true)
set(textdbe, colourstring)
show test

```

Simple elements for dialog boxes

This section defines functions for simple elements such as two-state options, with the exception of buttons, which are defined in “Buttons,” on page 476. More complex elements that allow the user to choose from various options are defined in “Choice dialog box elements,” on page 460.

label

Declaration

```
DBE label(DB box,
          string label)
```

Operation

Creates a label element in dialog box *box*.

Example

```
DB infoBox = create "About SimParse"
label(infoBox, "SimParse V2.1")
show infoBox
```

separator (dialog box)

Declaration

```
DBE separator(DB box)
```

Operation

Places a full width separating line across dialog box *box*.

Example

This example creates a separator between the input slider and the output field. Dialog boxes normally include a separator, which is automatically created, between the user-defined elements and the standard buttons.

```
DB exBox = create "Use of Separator"
DBE input = slider(exBox, "Input:", 50, 0, 100)
separator exBox
DBE output = field(exBox, "Output:", "", 30)
void calc(DB exBox) {
    int i = get input
    set(output, "Input was " i "")
} // calc
apply(exBox, calc)
```

```
show exBox
```

splitter

Declaration

```
DBE splitter(DB box,
             DBE left,
             DBE right,
             int width)
```

Operation

Places a movable vertical separating line across dialog box *box*. The arguments define the left part of the dialog box, the right part of the dialog box, and the width of the splitter in pixels. This is only supported for DBEs of type `listView` or `treeView`.

Example

```
// constants
const string SARR_DUMMY[] = {}
// constants
const int TREE_WIDTH = 150
const int TREE_HEIGHT = 10
const int LIST_WIDTH = 300
const int LIST_HEIGHT = 10
// dxl dialogs
DB dlg = null
// dxl elements
DBE dbeTree, dbeList, dbeSplitter
// create dialog
dlg = create("Test", styleCentered)
// tree
dbeTree = treeView(dlg, 0, TREE_WIDTH,
                  TREE_HEIGHT)
dbeTree->"top"->"form"
dbeTree->"left"->"form"
dbeTree->"bottom"->"form"
dbeTree->"right"->"unattached"
// list
```

```

dbeList = listView(dlg, 0, LIST_WIDTH,
                  LIST_HEIGHT, SARR_DUMMY)
dbeList->"top"->"aligned"->dbeTree
dbeList->"left"->"unattached"
dbeList->"bottom"->"form"
dbeList->"right"->"form"
// splitter
dbeSplitter = splitter(dlg, dbeTree, dbeList, 4)
dbeSplitter->"top"->"form"
dbeSplitter->"left"->"unattached"
dbeSplitter->"bottom"->"form"
dbeSplitter->"right"->"unattached"
realize dlg
{
    // information is displayed over a single
    // column
    insertColumn(dbeList, 0, "Name", LIST_WIDTH -
                20, null)
}
show dlg

```

frame

Declaration

```

DBE frame(DB box,
          string label
          [,int width,
           int height])

```

Operation

Creates a frame element in *box*, which can contain other elements. The *label* is the title of the frame; width and height specify the size of the frame in pixels. If *width* and *height* are omitted, the frame expands to fit the elements within it.

Example

This example creates a tab strip and frame, and places the frame inside a tab.

```

const string tabStrings[] = {"A", "B", "C"}
DB box = centered "Example"
DBE theTab
DBE theFrame

```

```

void tabCb(DBE xx) {
    int i = get xx
    if (i == 0) {
        show theFrame
    } else {
        hide theFrame
    }
}

theTab = tab(box, tabStrings, 300, 300, tabCb)
// attach all the edges of the tabstrip to the
// form
theTab->"left"->"form"
theTab->"right"->"form"
theTab->"top"->"form"
theTab->"bottom"->"form"
theFrame = frame(box, "A frame", 100, 100)
// place the frame inside the tabstrip
theFrame->"left"->"inside"->theTab
theFrame->"right"->"inside"->theTab
theFrame->"top"->"inside"->theTab
theFrame->"bottom"->"inside"->theTab
realize box
// ensure widgets are showing for correct tab
tabCb theTab
show box

```

fileName

Declaration

```

DBE fileName(DB box,
             [string label,]
             [,string initFileName
             [,string extension,
             string description
             [,bool readOnly]]])

```

Operation

Creates a window-wide element inside the specified dialog box for capturing a file name. As in other DOORS windows, there is a field for the file name and a button, **Browse**, to invoke a file selector window. Optionally, the element is called *label*.

When present, the *initFileName* argument provides an initial value, which can be an absolute or relative path.

The fourth and fifth optional arguments allow you to specify a file extension and description, which fill the **File of type** box. Note that not all platforms make use of this additional information.

When the *readOnly* argument is `true`, it checks the **Open as read-only** box. Note that not all platforms make use of this additional information.

Example

```
// basic file name
DBE fn = fileName(loader, "input.dat")
// file spec and description added
DBE fn = fileName(load, "input.dat", "*.dat",
                  "Data files")
```

field

Declaration

```
DBE field(DB box,
          string label,
          string initial,
          int width
          [,bool readOnly])
```

Operation

Creates a single-line text-field element. The parameters define a label, an initial value, the number of characters that are visible in the field, and whether the field is read only (`true` means read only). If the last argument is omitted, the function creates a read-write field.

The width of the resulting element is independent of the default GUI font on the current platform.

Example

```
DB fieldBox = create "Get Zip"
DBE zip = field(fieldBox, " Zipcode: ", "", 12)
void unzip(DB fieldBox) {
    string zipcode = get zip
    print zipcode
} // unzip
apply(fieldBox, "Lookup", unzip)
show fieldBox
```

richField

Declaration

```
DBE richField(DB box,
              string label,
              string initial,
              int width
              [,bool readOnly])

DBE richField(DB box,
              string label,
              richText(string initial),
              int width)

DBE richField(DB box,
              string label,
              richText(string initial),
              int width,
              bool readOnly)
```

Operation

Creates a single-line rich text field element.

In the first form, arguments define a label, an initial value, the number of characters in the field, and whether the field is read only (`true` means read only). If the last argument is omitted, the function creates a read-write field.

The second form takes a rich text string for the initial value; it cannot create a read only field.

The third form takes a rich text string for the initial value. If `readOnly` is `true`, the function creates a read only field. If `readOnly` is `false`, the function creates a read-write field.

The width of the resulting element is independent of the default GUI font on the current platform.

slider

Declaration

```
DBE slider(DB box,
           string label,
           int initial,
           int min,
           int max)
```

Operation

Creates a slider element for capturing integers. The arguments passed specify a label, the initial value and the minimum and maximum values on the slider.

Sliders are best used for small ranges such as percentages. For larger numbers, or those without limits, it is better to use a text field and the `intOf` function to convert the string value to an integer.

Example

```

DB percentBox = create "Your Feedback"
label(percentBox, "How strongly do you agree?")
DBE feelings = slider(percentBox, "Adjust
                      slider:", 50, 0, 100)
DBE output = field(percentBox, "Output:", "", 30,
                  true)
void calc(DB percentBox) {
    int results = get feelings
    print results
    set(output, results "" )
} // calc
apply(percentBox, "Commit", calc)
show percentBox

```

checkBox

Declaration

```

DBE {vertical|c}checkBox(DB box,
                       string label,
                       string choices[ ],
                       int initial)

```

Operation

Creates a set of check boxes.

Check boxes offers users choices, each of which can independently be either on or off.

The `checkBox` function arranges the check boxes horizontally; the `verticalCheckBox` function arranges them vertically. The options are passed in string array *choices*. The *initial* and returned values are bit maps indicating whether each option is checked. If the first option is checked, bit 0 is 1, if the second is checked bit 1 is 1, and so on.

Example

```

DB pizzaBox = create "Pizzas"
string toppings[] = {"salami", "funghi",
                    "olives", "anchovies",
                    "frutti di mare",
                    "artichoke"}

int maxToppings = 5
DBE pizzaCheck = checkBox(pizzaBox, "Toppings:",
                          toppings, 5)

bool pizzasOrdered[] = {false, false, false,
                        false, false, false}

```



```

void processOrders(DB pizzaBox) {
    int bitmap = get pizzaCheck
    // bit-map of values

    int remain

    int i

    for i in 0:maxToppings do {
        remain = bitmap % 2          // remainder

        if (remain != 0) {
            pizzasOrdered[i] = true
            print toppings[i] ":"
                pizzasOrdered[i] "\n"
        } else {
            pizzasOrdered[i] = false
        }

        bitmap = bitmap / 2    // integer division
    }
} // processOrders

apply(pizzaBox, "Order Pizzas", processOrders)

show pizzaBox

```

radioBox

Declaration

```

DBE {verticalR|r}radioBox(DB box,
                        string label,
                        string choices[ ],
                        int initial)

```

Operation

Creates a set of radio boxes.

Radio boxes offers users choices that are mutually exclusive.

The `radioBox` function arranges the check boxes horizontally; the `verticalRadioBox` function arranges them vertically. The options are passed in string array *choices*. The *initial* and returned values are indexes into that array.

Example

```

DB dinnerBox = create("Dinner")

string meals[] = {"Pizza", "Pasta", "Quiche",
                 "Burger", "Tachos"}

DBE dinnerRadio = radioBox(dinnerBox, "Main
                          Course: ", meals, 2)

```

```

void placeOrder(DB dinnerBox) {
    int i = get dinnerRadio
    string mealStr = meals[i]
    ack "Ordering " mealStr " now!"
} // placeOrder

apply(dinnerBox, "Order", placeOrder)

show dinnerBox

```

toggle

Declaration

```

DBE toggle(DB box,
           string label,
           bool initial)

```

Operation

Creates a toggle button in *box* with the given label and initial value.

Example

```

DB parseBox = create "Simulator File Parser"
DBE binOpt = toggle(parseBox, "Use binary data",
                   false)

show parseBox

```

date

Declaration

```

DBE date(DB date_db, int width, Date init, bool calendar)

```

Operation

Creates a date/time picker control. *Width* specifies the width in characters of the displayed field. The variable *init* specifies the initial date value displayed by the control. If a null date value is supplied, the current date and time is displayed. If *calendar* is *true*, a drop-down calendar is made available in the control for selecting dates. Otherwise, up and down buttons in the control allow the user to increment and decrement values in the selected field of the control.

You can type values into the various fields of the control, and use the cursor arrow keys to select fields and increment or decrement values.

The date values are displayed according to DOORS conventions: date/time values are displayed using the user's default short date format for the current user locale, and a 24-hour clock format. Date-only values are displayed using the user's default long date format for the current user locale.

setLimits

Declaration

```
void setLimits(DBE date_dbe, Date min, Date max)
```

```
void setLimits(DBE date_dbe, AttrType type)
```

Operation

Sets the minimum and maximum limit values for a date/time picker control. If the current value displayed in the picker lies outside either of the new limits, it is updated to equal that limit. If either one of the supplied values is null, then the relevant *min/max* limit is not changed.

The second form sets the minimum and maximum limit values for a date/time picker control to match the limits defined for the specified attribute type. The current displayed value is updated if necessary to lie within the limit or limits.

getDate

Declaration

```
Date getDate(DBE date_dbe)
```

Operation

Returns the date value displayed in the specified DBE.

set

Declaration

```
void set(DBE date_dbe, Date value)
```

```
void set(DBE date_dbe, string value)
```

Operation

Updates the DBE to display the specified date value.

The second form of the perm is updated to put the string (interpreted according to the current user locale) into the date DBE. No update occurs if the supplied string is not a valid date string.

get

Declaration

```
string get(DBE date_dbe)
```

Operation

Returns the displayed string in a date DBE.

getBuffer

Declaration

```
Buffer getBuffer(DBE date_dbe)
```

Operation

Returns the displayed string from a date DBE as a buffer.

setFromBuffer

Declaration

```
void setFromBuffer(DBE date_dbe, Buffer b) / set(DBE,Buffer)
```

Operation

Updates the DBE to display the date represented by the string in the supplied buffer, interpreted according to the current user locale. The DBE is not updated if the supplied string is not a valid date string.

Example

The following example uses the perms for the new data DBE element:

```
// DateTime Picker Test: gets and sets date values.
DB db = create "date/time picker test" // The Dialog
Date init = dateAndTime(today) // Initial value in control
label(db, "picker:")
beside db
DBE picker = date(db, 20, init, true) // Define the control

// Callback for toggle...
void showTimeCB(DBE x)
{
    if (get(x))
    {
        set(picker, dateAndTime(getDate picker))
    }
    else
    {
        set(picker, dateOnly(getDate picker))
    }
}
```

```

}

// Toggle the showing of date+time or date-only
DBE showTime = toggle(db, "show time", includesTime(init))
set(showTime, showTimeCB)

// Text field to display values got from the control, and for
// sending to the control.
left db
DBE stringVal = field(db,"string field:", "",20)

// Get the current value from the control, as a Date value.
void getDate(DBE x)
{
    Date d = getDate(picker)
    set(stringVal, stringOf(d))
}
button(db, "Get Date", getDate)
beside db

// Get the current value from the control, as a string.
void getString(DBE x)
{
    string s = get(picker)
    set(stringVal, s)
}
button(db, "Get string", getString)

// Get the current value from the control, as a Buffer.
void getDateBuffer(DBE x)
{
    Buffer b = getBuffer(picker)
    set(stringVal, b)
    delete b
}

```

```

}
button(db, "Get Buffer", getDateBuffer)
left db

// Update the control using a Date value
void setDate(DBE x)
{
    string s = get(stringVal)
    Date d = date(s)
    if (null d) warningBox "Not a valid date string!"
    else set(picker, d)
    set(showTime, includesTime(getDate picker))
}
button(db, "Set Date", setDate)
beside db

// Update the control using a string value
void setString(DBE x)
{
    string s = get(stringVal)
    set(picker, s)
    set(showTime, includesTime(getDate picker))
}
button(db, "Set string", setString)

// Update the control using a Buffer value
void setDateBuffer(DBE x)
{
    Buffer b = getBuffer(stringVal)
    setFromBuffer(picker, b)
    set(showTime, includesTime(getDate picker))
    delete b
}
button(db, "Set Buffer", setDateBuffer)

```

```

left db
Date minDate = null
Date maxDate = null

// Set the minimum value accepted by the date/time picker
void setMinVal(DBE x)
{
    string s = get(stringVal)
    minDate = date(s)
    if (null minDate)
    {
        warningBox "Not a valid date string!"
    }
    else if (!null maxDate && minDate > maxDate)
    {
        warningBox "Minimum date cannot be greater than maximum date."
    }
    else
    {
        setLimits(picker,minDate,maxDate)
    }
}
button(db, "Set Min from field", setMinVal)
beside db

// Set the maximum value accepted by the date/time picker
void setMaxVal(DBE x)
{
    string s = get(stringVal)
    maxDate = date(s)
    if (null maxDate)
    {
        warningBox "Not a valid date string!"
    }
}

```

```

else if (!null minDate && minDate > maxDate)
{
    warningBox "Maximum date cannot be less than minimum date."
}
else
{
    setLimits(picker,minDate,maxDate)
}
}
button(db, "Set Max from field", setMaxVal)
show db

```

Choice dialog box elements

This section defines functions and `for` loops that allow you to create elements that give the user a choice:

- A drop-down selector provides a simple choice.
- A combo box is an editable drop-down selector.
- A tab strip provides a simple choice where other options must be selected after the initial selection.
- Scrollable lists are a powerful mechanism for providing users with a large number of options.

These dialog box elements are all of type DBE.

choice

Declaration

```

DBE choice(DB box,
           string label,
           string choices[ ],
           [int noOfChoices,]
           int initial
           [,int width,
           bool canEdit])

```

Operation

Creates a drop-down selector. This shows only the current value until the user clicks in it, when the whole range is displayed. The *initial* argument specifies which value is selected by default, counting from 0.

The string array *choices* must have been declared at a fixed size, with each element containing a string. The optional *noOfChoices* argument specifies the number of elements of the *choices* array that contain real choices.

The optional *width* argument specifies the number of characters in the choice box. When used, this argument must be followed by a boolean value to indicate whether the choice can be edited by the user. If *canEdit* is *true*, the choice box is editable (a combo box). If *width* is 0, -1, or omitted, the standard width is used.

The width of the resulting element is independent of the default GUI font on the current platform. The width will be consistent with the legacy behavior on Western platforms with regard to the resultant width calculated from the specified number of characters.

Example

```
DB reqBox = create "Edit Requirement"
string importance[] = {"Vital", "Useful",
                     "Convenient", "Useless"}
DBE reqImport = choice(reqBox, "Importance: ",
                      importance, 2)
void accept(DB reqBox) {
    int i = get reqImport
    print importance[i]
} // accept
ok(reqBox, "Accept", accept)
show reqBox
```

tab

Declaration

```
DBE tab(DB box,
        string choices[ ]
        [,int noOfChoices]
        [,int width,
         int height],
        void (DBE theTab))
```

Operation

Creates a tab strip. This function behaves much like the list function.

The string array *choices* must have been declared at a fixed size, with each element containing a string. The optional *noOfChoices* argument specifies the number of elements of the *choices* array that contain real choices.

The optional *width* and *height* arguments specify the initial size of the tab strip in pixels. If *width* and *height* are not specified, the size is controlled by the elements the tab strip contains, or from the form if the tab strip is connected to it. If the right edge of a tab strip is to remain unattached, you must specify a size. A tab strip with an initial size can stretch if placement constraints are incompatible with the size specified.

You can place other dialog box elements inside a tab strip using the placement keyword *inside*, but you should not put an element with no innate size (like a list box) inside a tab with no innate size. For further information on tab strip placement, see “Attachment placement,” on page 521.

The callback function must identify which tab has been selected.

Example

```
DB box = create "Test"

void tabSelected(DBE theTab){
    int i = get theTab
}

string items[] = {"A", "B", "C"}

DBE theTab = tab(box, items, 300, 400,
    tabSelected)

theTab->"top"->"form"
theTab->"left"->"form"
theTab->"bottom"->"form"
theTab->"right"->"unattached"
```

list

Declaration

```
DBE list(DB box,
    string label,
    [int width,]
    int visible,
    string values[ ]
    [,int noOfValues])
```

Operation

Creates a list element containing the given values, from which the user can choose at most one item. If there are many or a variable number of options, a list is better than a choice as it does not attempt to display more than the number of items passed in the *visible* argument. If the *width* argument is present, the element is created at the specified size in pixels. Otherwise, the list is created to use the full width of the dialog box.

You can supply either a complete array of strings, such as a constant array, or a partially filled array, with the number of items supplied in the *noOfValues* argument. You can create a list with initially no entries by setting *noOfValues* to 0, although you must still supply a valid string array.

Note that there is no initial selection; to do this, use the `set (value or selection)` function. You can also define callbacks for lists.

Example

```
DB coffeeBox = create "Coffees"

string coffees[] = {"Mocha", "Sumatra Blue",
    "Jamaica Mountain",
    "Mysore", "Kenya", "Java"}

DBE coffeeList = list(coffeeBox, "Choose one
of:", 5, coffees)
```

```

void getCoffees(DBE coffeeList) {
    int i = get coffeeList
    if (i == 0) ack "Mmm, Mocha..."
    if (i == 5) ack "Watch out for trademark
                    violations"
} // getCoffees
// run callback directly upon list selection
set(coffeeList, getCoffees)
show coffeeBox

```

multiList

Declaration

```

DBE multiList(DB box,
              string label,
              [int width,]
              int visible,
              string values[ ]
              [,int noOfValues])

```

Operation

Creates a list element containing the given values, from which the user can choose one or more items. In all other respects this function is exactly the same as the list function.

Example

```

DB attrShow = create "Attributes"
string attrNames[100]
int noOfAttrs = 0
string an
if (null current Module) {
    ack "Please run this function from a module"
    halt
}
for an in current Module do
    attrNames[noOfAttrs++] = an
DBE attrList = multiList(attrShow, "Attributes:",
                        5, attrNames, noOfAttrs)
void printAttrs(DB box) {
    string attrName

```

```

        for attrName in attrList do {
            print attrName " = " ((current
                Object).attrName) "\n"
        }
    } // printAttrs
apply(attrShow, "Print", printAttrs)
void clearSelection(DB box) {
    int i
    for i in 0:noOfAttrs do
        set(attrList, i, false)
    } // clearSelection
apply(attrShow, "Clear", clearSelection)
show attrShow

```

selectedElems

Declaration

```
int selectedElems (DBE listView)
```

Operation

Returns the number of elements currently selected in the specified list view.

Typically this is either 0, 1 or a positive integer (if the list view was created using the `listViewOptionMultiselect` style).

If the DBE is not a list view, a run-time error occurs.

for value in list (selected items)

Syntax

```
for s in list do {
    ...
}
```

where:

s is a string variable

list is a multilist of type DBE

Operation

Assigns the string *s* to be each successive selected item in a multilist, *list*.

Example

```
string at
for at in attrList do print at " is selected\n"
```

for position in list (selected items)

Syntax

```
for i in list do {
    ...
}
```

where:

i is an integer variable
list is a multilist of type DBE

Operation

Assigns the integer *i* to be the index of each successive selected item in a multilist, *list*.

Example

```
int totalWeight = 0
int index
for index in components do
    totalWeight += compWeights[index]
```

View elements

This section defines functions and `for` loops that allow you to create list views and tree views in your dialog boxes.

Drag-and-drop

Drag-and-drop operations are possible in list views and tree views, provided a callback function is specified when the list view or tree view is created. The callback takes the form:

```
void callback(DropEvent dropEvent)
```

The `DropEvent` structure is unique to the source of the drag; it exists for only as long as the dialog box element being dragged.

Properties are defined for use with the `.` (dot) operator and `DropEvent` structure to extract information about drop events, as shown in the following syntax:

dropEvent.property

where:

dropEvent is a variable of type `DropEvent`
property is one of the drag-and-drop properties

The following tables list the properties and the information they extract:

String property	Extracts
<code>sourcePath</code>	The path of the source item of a drag operation; this is only valid if <code>sourceIsListView</code> is <code>true</code> , otherwise, it is <code>null</code> .
<code>targetPath</code>	The path of the target item of a drag operation; this is only valid if <code>targetIsListView</code> is <code>true</code> , otherwise, it is <code>null</code> .

Boolean property	Extracts
<code>sourceIsTreeView</code>	Whether the source of the drag is a tree view.
<code>sourceIsListView</code>	Whether the source of the drag is a list view.
<code>targetIsTreeView</code>	Whether the target of the drag is a tree view.
<code>targetIsListView</code>	Whether the target of the drag is a list view.

Integer property	Extracts
<code>sourceIndex</code>	The index of the source item of a drag operation; this is only valid if <code>sourceIsListView</code> is <code>true</code> , otherwise, it is <code>-1</code> .
<code>targetIndex</code>	The index of the target item of a drag operation; this is only valid if <code>targetIsListView</code> is <code>true</code> , otherwise, it is <code>-1</code> .

DBE property	Extracts
<code>source</code>	The source dialog box element of the drag operation; this is always the element for which the callback was defined.
<code>target</code>	The target dialog box element of the drag operation.

Example

`DropEvent de`

```
bool b = de.targetIsTreeView
DBE testList = de.source
```

listView

Declaration

```
DBE listView(DB box
             [,void callback(DropEvent event),
              int options,
              int width,
              int lines,
              string items[ ]
              [,int noOfItems])
```

Operation

Creates a list view having the specified width in pixels and with the specified number of lines.

The optional callback function allows the list view to participate in drag-and-drop events. When this list view is the source of a drop operation, the callback fires and the `DropEvent` structure can be queried. For further information, see “Drag-and-drop,” on page 465. If the callback function is not supplied, the user cannot use drag-and-drop in the list view.

The string array *items* must have been declared at a fixed size, with each element containing a string. The optional *noOfItems* argument specifies the number of elements of the *items* array that contain real choices.

The argument *options* controls whether the list view has check boxes. The value can be one of the following:

<code>listViewOptionCheckboxes</code>	provides check boxes
<code>listViewOptionMultiselect</code>	makes it possible to select more than one item
<code>0</code>	no check boxes or multi-select capability
<code>listViewOptionCheckboxes listViewOptionMultiselect</code>	provides check boxes and multi-select capability
<code>listViewOptionSortText</code>	for use with the <code>setSortColumn</code> perm

deleteColumn

Declaration

```
string deleteColumn(DBE listView,
                   int columnIndex)
```

Operation

Deletes from *listView* the column identified by *columnIndex* counting from 0. This works only for list views.

insertColumn (list view)

Declaration

```
void insertColumn(DBE listView,
                 int columnIndex,
                 string title,
                 int width,
                 Icon icon)
```

Operation

Inserts a column in *listView* after the column identified by *columnIndex* counting from 0. The new column has title *title*, width in pixels of *width*, and icon *icon*. To insert a column without an icon use the value `iconNone`. For other valid icon values, see “Icons,” on page 407.

This works only for list views.

getColumnValue

Declaration

```
string getColumnValue(DBE listView,
                     int row,
                     int column)
```

Operation

Returns the value of the item or subitem identified by *row* in *column*. Both *row* and *column* count from 0. This works only for list views.

Example

This example returns the 34th row of the first column in list view `main`.

```
string s = getColumnValue(main, 33, 0)
```

getCheck

Declaration

```
bool getCheck(DBE listView,
              int index)
```

Operation

Returns `true` if the check box identified by *index* is selected; otherwise, returns `false`. This works only for list views.

setCheck

Declaration

```
void setCheck(DBE listView,  
             int index,  
             bool checked)
```

Operation

Selects or clears the check box identified by *index* according to the value of *checked*. This works only for list views.

getSortColumn

Declaration

```
int getSortColumn(DBE listView)
```

Operation

Returns the column in *listView* that is being sorted. This works only for list views.

setSortColumn

Declaration

```
void setSortColumn(DBE listView,  
                  int columnIndex)
```

Operation

Sets the column to be sorted to the column specified by *columnIndex*. This works only for list views.

treeView

Declaration

```
DBE treeView(DB box  
             [,void callback(DropEvent event)],  
             int options,  
             int width,  
             int visible)
```

Operation

Creates a tree view having the specified width in pixels and with the specified number of visible items (which controls the height of the tree view).

The optional callback function allows the list view to participate in drag-and-drop events. When this list view is the source of a drop operation, the callback fires and the `DropEvent` structure can be queried. For further information, see “Drag-and-drop,” on page 465. If the callback function is not supplied, the user cannot use drag-and-drop in the list view.

The `options` argument can be `0` or `treeViewOptionSorted`, which sorts the tree view.

exists (tree view)

Declaration

```
bool exists(DBE treeView,
            string fullPath)
```

Operation

Returns `true` if a `fullPath` is the full path name of a tree view; otherwise, returns `false`.

layoutDXL

Declaration

```
void layoutDXL(DBE treeView)
```

Operation

Loads the specified tree view with a hierarchy of DXL files, which can be used for column layout DXL.

If the DBE is not a tree view, a run-time error occurs.

attributeDXL

Declaration

```
void attributeDXL(DBE treeView)
```

Operation

Loads the specified tree view with a hierarchy of DXL files, which can be used for DXL attribute.

If the DBE is not a tree view, a run-time error occurs.

getDXLFileHelp, getDXLFileName

Declaration

```
string getDXLFileHelp(DBE treeView)
string getDXLFileName(DBE treeView)
```

Operation

These functions assume that the specified tree view contains a hierarchy of DXL files loaded using the `layoutDXL` function (similar to the contents of the DXL Browser dialog box). If one of the files is selected, and you call either of these functions, typically from a button callback, they behave as described here.

The first function returns the help text associated with the selected DXL file.

The second function returns the name of the selected file.

If the dialog box element is not a tree view, a run-time error occurs.

templates

Declaration

```
void templates(DBE treeView)
```

Operation

Populates the specified tree view with a hierarchy of available templates (DXL files) that are in the `lib\dxl\standard\ template` directory.

getTemplateName

Declaration

```
string getTemplateName(DBE treeView)
```

Operation

Assumes that the specified tree view contains a hierarchy of available templates previously loaded using the `templates` function.

When a template is selected on a user's PC or workstation, returns the full path of the selected file. Otherwise, returns a null string.

Example

```
// prevent dxl timeout dialog
#pragma runLim, 0
// constants
const int INITIAL_TREE_WIDTH = 500
const int INITIAL_TREE_HEIGHT = 20
// dxl dialog
DB dlg = null
// dxl elements
DBE dbeTree, dbeLabel
// function
```

```

void fnTreeSelect(DBE xx)
{
    string sTemplate = getTemplateFileName(xx)

    // only relevant if actual template was
    // selected

    if (sTemplate != null)
    {
        // inform user
        infoBox(dlg, sTemplate)
    }
}

dlg = create(dbExplorer, "Templates", styleCentered | styleFixed)
// label
dbeLabel = label(dlg, "Please select an item from
                  the tree...")

dbeLabel->"top"->"form"
dbeLabel->"left"->"form"
dbeLabel->"right"->"unattached"
dbeLabel->"bottom"->"unattached"

// tree view
dbeTree = treeView(dlg, 0, INITIAL_TREE_WIDTH, INITIAL_TREE_HEIGHT)
dbeTree->"top"->"spaced"->dbeLabel
dbeTree->"left"->"form"
dbeTree->"right"->"form"
dbeTree->"bottom"->"form"

realize dlg
{
    // callbacks
    set(dbeTree, fnTreeSelect)

    // load templates into tree view
    templates(dbeTree)
}

block dlg

```

for value in list view (selected items)

Syntax

```
for s in listView do {  
  ...  
}
```

where:

s is a string variable
listView is a list view of type DBE

Operation

Assigns the string *s* to be each successive selected item in a list view.

for position in list view (selected items)

Syntax

```
for i in listView do {  
  ...  
}
```

where:

i is an integer variable
listView is a list view of type DBE

Operation

Assigns the integer *i* to be the index of each successive selected item in a list view, *listView*.

Text editor elements

This section defines text editor functions, which allow you to create a full function text editing panel in your dialog box. These have the same functions as all DOORS text panels, including pop-up menu support for loading and saving files.

text (box)

Declaration

```
DBE text(DB box,
         string label,
         string initial,
         [int width,]
         int height,
         bool readOnly)
```

Operation

Creates a multi-line text element in the dialog box *box*. The arguments define a label, an initial value, the width of the text box in pixels, the height of the text box in pixels, and whether the text box is read only (`true` means the user cannot modify the contents of the text box). If *width* is omitted, the box takes the full width of the window.

Example

```
void sendRID(DB RIDbox) {
    // process RID in some way
} // sendRID

DB RIDbox = create "Review Item Discrepancy"
DBE response = text(RIDbox, "Your response:", "",
                   200, false)

apply(RIDbox, sendRID)
show RIDbox
```

richText (box)

Declaration

```
DBE richText(DB box,
             string label,
             {string
              initial|richText(string initial)},
             int width,
             [int height,]
             bool readOnly)
```

Operation

Creates a multi-line rich text element in the dialog box *box*. The arguments define a label, an initial value (which can be rich text), the width of the text box in pixels, the height of the text box in pixels, and whether the text box is read only (`true` means the user cannot modify the contents of the text box). If *height* is omitted, the box takes the full height of the window.

If the blinking cursor appears at the end of the text in the box when it is displayed, append "" to the end of the rich text string before passing it to the perm.

home

Declaration

```
void home(DBE textElem)
```

Operation

Causes the cursor to go to the first character in *textElem*.

Example

```
home messageArea
```

modified

Declaration

```
bool modified(DBE textElem)
```

Operation

Returns `true` if the text in *textElem* has been modified since it was last set.

Example

```
if (modified errorLog && confirm
    "Save error log changes?")
    saveErrorLog
```

get (selected text)

Declaration

```
bool get(DBE textElem,
         int &first,
         int &last)
```

Operation

Returns the selection indices for a text element. If there is a selection, the function returns `true`, and sets the *first* and *last* arguments to the zero-based indices of the first character and the character immediately after the last one selected.

If there is no selection, the function returns `false`.

Example

```
DB splitBox = create "Text splitter"
DBE objTextElem = text(splitBox, "Object text:",
                      "1234567890", 200, false)
```

```

void getSelection(DB splitBox) {
    int first, last

    if (get(objTextElem, first, last)) {
        string ot = get objTextElem
        string selection = ot[first:last-1]
        print "You selected:\n" selection "\n"
    } else {
        print "No selection\n"
    }
} // getSelection
apply(splitBox, "Get selection", getSelection)
show splitBox

```

Buttons

This section defines functions that allow you to create buttons on dialog boxes. DOORS dialog boxes provide two kinds of buttons: those across the bottom of the dialog box, and those that appear in the dialog box area itself.

ok

Declaration

```

DBE ok(DB box,
       [string label,]
       void callback(DB))

```

Operation

Adds a button to the row of standard buttons on the dialog box, and associates it with the given callback function. If the *label* argument is passed, the button has that label; otherwise it has the standard label **OK**. On Windows platforms, if *label* contains an ampersand (&), the character after the & is underscored, which creates a shortcut key for use with the **ALT** key.

When the user clicks the button, the function is called with the parent dialog box as the argument, and the dialog box is removed from the screen.

Example

```

void writeout(DB box) {
    // user code here
} // writeout

ok(fileOpBox, "Write", writeout)

```

apply

Declaration

```
DBE apply(DB box,
          [string label,]
          void callback(DB))
```

Operation

Adds a button to the row of standard buttons on the dialog box, and associates it with the given callback function. If the *label* argument is passed, the button has that label; otherwise it has the standard label `Apply`. On Windows platforms, if *label* contains an ampersand (&), the character after the & is underscored, which creates a shortcut key for use with the **ALT** key.

When the user clicks the button, the function is called with the parent dialog box as the argument. The dialog box remains on the screen, allowing this or other buttons to be clicked.

Example

```
void sumAttrs(DB box) {
    // user code here
}

apply(analysisBox, "Calculate", sumAttrs)
```

close

Declaration

```
void close(DB box,
           bool includeButton,
           void closeAction(DB))
```

Operation

Normally a **Close** button is added to the row of standard buttons on a dialog box. The normal action of the **Close** button is to close the dialog box.

If the *includeButton* argument is `false`, the **Close** button is omitted from the dialog box, although the user can still close the window via the window manager or system menu. This allows you to supply a close-action button that has an alternative label.

Because closing the dialog box may not always be desirable behavior, this function allows you to replace the standard close action with a callback function. When a callback function is supplied, windows are **not** automatically closed; the callback must explicitly hide the dialog box (see the `hide (dialog box)` function).

Example

```
DB exBox = create "Example"
DBE tp = text(exBox, "Text", "Type in here", 100,
             false)
```

```

DBE check = toggle(exBox, "Check before closing",
    true)

void checkText(DB exBox) {
    if (modified(tp) && !confirm("Text modified,
        really close?"))
        return
    hide exBox
} // checkText

ok(exBox, "Cancel", checkText)

close(exBox, false, checkText)

show exBox

```

button

Declaration

```

DBE button(DB box, string label, void callback(DBE)           [,bool
variableSize|int style])

DBE button(DB box, string label, void callback [, bool variableSize | int style
[, int width] ] )

```

Operation

Creates a button in the specified dialog box. The *callback* function fires whenever the user clicks on the button. On Windows platforms, if *label* contains an ampersand (&), the character after the & is underscored, which creates a shortcut key for use with the **ALT** key.

The button can have either a label or an arrow symbol defined by one of the following constants in “ok, apply, button (arrows),” on page 479.

The optional fourth argument allows you to specify the size or style of the button.

If *variableSize* is *false*, the button is 50 pixels wide by 13 pixels high. If *variableSize* is missing or *true*, the button size depends on the label.

The possible values for *style* are: *styleIsDefault*, *styleIsCloseBtn*, *styleStandardSize*, or any OR combination of these values.

The second variant has an optional *width* argument that allows the user to specify the width of the button, in pixels. (As a guide, *standardSize* buttons are 50 pixels wide.) This argument has no effect if the *variableSize* argument is specified as *false*, or if the *style* argument is specified and includes the *standardSize* option.

Example

```

DB resultsBox = create "Summary Results Display"
DBE caption

```

```

void repaint(DBE canv) {
    background(canv, colorLightBlue)
    color(canv, colorMaroon)
    string cap = get caption
    draw(canv, 100, 50, cap)
} // repaint

DBE canv = canvas(resultsBox, 400, 100, repaint)
caption = field(resultsBox, "Caption:",
                "Callbacks will plot data", 20)
beside resultsBox
void trendPlot(DBE calledfrom) {
    // user code here
    repaint canv
} // trendPlot

DBE trends = button(resultsBox, "Show trends", trendPlot)
show resultsBox

```

ok, apply, button (arrows)

Both standard and dialog-area buttons can be created with an arrow instead of a text label. To do this, replace the string label with one of the following constants:

```

topLeftArrow
upArrow
topRightArrow
leftArrow
allWaysArrow
rightArrow
bottomLeftArrow
downArrow
bottomRightArrow
leftRightArrow
upDownArrow

```

Example

```

DB arrowBox = create "Arrow Demo"
void doNothing(DBE x) {}
void doNothing(DB x) {}
DBE t1 = button(arrowBox, topLeftArrow,
                doNothing)

```

```

beside arrowBox
DBE up = button (arrowBox, upArrow, doNothing)
DBE tr = button (arrowBox, topRightArrow,
                doNothing)

leftAligned arrowBox
DBE l = button (arrowBox, leftArrow, doNothing)
beside arrowBox
DBE all = button (arrowBox, allWaysArrow,
                 doNothing)
DBE r = button (arrowBox, rightArrow, doNothing)
leftAligned arrowBox
DBE bl = button (arrowBox, bottomLeftArrow,
                doNothing)

beside arrowBox
DBE down = button (arrowBox, downArrow, doNothing)
DBE br = button (arrowBox, bottomRightArrow,
                doNothing)

leftAligned arrowBox
apply (arrowBox, leftRightArrow, doNothing)
apply (arrowBox, upDownArrow, doNothing)
show arrowBox

```

Canvases

This section defines functions for canvases, which allow DXL programs to draw graphics, such as charts and diagrams, in dialog boxes.

Any graphics layout DXL should always specify all co-ordinates in drawing units (du), for example:

```
rectangle (myCanv, 10 du, 10 du, 20 du, 20 du)
```

Otherwise the graphics do not print properly.

Keyboard event constants

Declaration

```

const char keyInsert
const char keyDelete

```

```
const char keyHome
const char keyEnd
const char keyPageUp
const char keyPageDown
const char keyUp
const char keyDown
const char keyLeft
const char keyRight
const char keyHelp
const char keyF1
const char keyF2
const char keyF3
const char keyF4
const char keyF5
const char keyF6
const char keyF7
const char keyF8
const char keyF9
const char keyF10
const char keyF11
const char keyF12
```

Operation

These are character constants that represent keyboard presses for invisible characters. They are returned by callbacks defined using `set`.

canvas

Declaration

```
DBE canvas(DB box,
           int width,
           int height,
           void repaint(DBE art))
```

Operation

Creates a drawing surface, which can be used for graphical output with the DXL Graphics Library functions.

Graphics must only be directed to the canvas from the callback function, *repaint*, which you must define, otherwise they are lost at the next repainting. The function is called back when the window appears on the screen, when it is de-iconified, or when an overlapping window is moved.

To add a mouse or key callback to a canvas, use the `set (select)` function.

Example

```
DB artBox = create "Try resizing this window"

void doDrawing(DBE art){
    // repaint callback function
    int i, x, y, w, h
    int cw = width art
    int ch = height art

    for i in 0 : 15 do {
        color(art, i)
        x = random cw // size graphics to canvas
        y = random ch
        w = (cw - x) / 2
        h = (ch - y) / 2
        rectangle(art, x, y, w, h)
    }
}
DBE art = canvas(artBox, 400, 300, doDrawing)
show artBox
```

background

Declaration

```
void background(DBE canvas,
               int colorNo)
```

Operation

Colors the whole of the canvas with the given color. For information on valid color numbers, see “Logical colors,” on page 510. This function destroys any existing drawing, and is equivalent to drawing a rectangle the size of the canvas. This function is recommended if you wish to color the whole canvas or erase the current image.

Example

```
DB graphBox = create "Graphics"

void repaint(DBE graph) {
    background(graph,
               logicalMediumIndicatorColor)
    // draw picture here
} // repaint

DBE graph = canvas(graphBox, 250, 75, repaint)
show graphBox
```

realBackground

Declaration

```
void realBackground(DBE canvas,
                   int colorNo)
```

Operation

Colors the whole of the canvas with the given color. For information on valid color numbers, see “Real colors,” on page 513. This function destroys any existing drawing, and is equivalent to drawing a rectangle the size of the canvas. This function is recommended if you wish to color the whole canvas or erase the current image.

Example

```
DB colorBox = create "To demonstrate the colors"
void doDrawing(DBE colorCanvas) {
    // repaint callback function
    // background(art, logicalPageBackgroundColor)
    realBackground(colorCanvas, realColor_Black)
    color(colorCanvas, logicalPageBackgroundColor)
    draw(colorCanvas, 15, 15,
         "logicalPageBackgroundColor")
    realColor(colorCanvas, realColor_Green)
    draw(colorCanvas, 15, 45, "Red")
    realColor(colorCanvas, realColor_Magenta)
    draw(colorCanvas, 15, 60, "Magenta")
}
DBE colorCanvas = canvas(colorBox, 400, 300, doDrawing)
show colorBox    // draw picture here
```

color

Declaration

```
void colo[u]r(DBE canvas,
              int colorNo)
```

Operation

Sets the drawing color for the *canvas* to be the given *colorNo*. For information on valid color numbers, see “Logical colors,” on page 510.

Example

```
color(board, logicalDataTextColor)
```

realColor

Declaration

```
void realColor(DBE canvas,
              int realColor)
```

Operation

Sets the drawing color for the canvas to be the given *realColor*. For information on valid color numbers, see “Real colors,” on page 513.

Example

See the example for the `realBackground` function.

font

Declaration

```
void font(DBE canvas,
         int level,
         int mode)
```

Operation

Sets the font for drawing strings on the canvas. The font is specified by two logical values corresponding to those in the Font Options window. The *level* argument is in the range 1 to 9 to represent the level in the tree at which a node appears. Essentially, this argument controls the size; level 1 is the top level of heading and typically appears in a large typeface. The *mode* argument controls which font is used: 0 sets body font, 1 sets heading font, and 2 sets graphics font. You can also use the constants `HeadingFont`, `TextFont`, and `GraphicsFont`.

Note: The actual font size and typeface depend on the user’s settings.

Example

```
DB graphBox = create "Graphics"
void repaint(DBE graph) {
    background(graph, logicalPageBackgroundColor)
    color(graph, logicalDataTextColor)
    int x = 10
    int fsize
    for fsize in 1:9 do {
        font(graph, fsize, 0)
        draw(graph, x, 20, fsize "")
        font(graph, fsize, 1)
        draw(graph, x, 60, fsize "")
    }
}
```



```

        font(graph, fsize, 2)
        draw(graph, x, 90, fsize "")
        x += 20
    }
} // repaint
DBE graph = canvas(graphBox, 300, 100, repaint)
show graphBox

```

height

Declaration

```
int height(DBE canvas
           [,string s])
```

Operation

With a single argument, this returns the height of *canvas*. This function must be used in repaint functions to obtain the size of the area into which to draw, as this may change.

When the second argument is passed, the function returns the height of the space required to render the string *s* in the current font.

Example

This example obtains the height of the canvas:

```
int h = height board
```

width

Declaration

```
int width(DBE canvas
           [,string s])
```

Operation

With a single argument, this returns the width of a *canvas* element. This function must be used in repaint functions to obtain the size of the area into which to draw, as this may change.

When the second argument is passed, the function returns the width of the space required to render the string *s* in the current font.

Example

This example obtains the width of the canvas:

```
int w = width board
```

This example obtains the height and width of the string variable *message*:

```
DB graphBox = create "Graphics"
```

```

void repaint(DBE graph) {
    background(graph,
        logicalMediumIndicatorColor)
    color(graph, logicalHighIndicatorColor)

    int w = width graph
    int h = height graph
    string message = w " by " h ""
    int tw = width(graph, message)
    int th = height(graph, message)
    int x = (w - tw)/2
    int y = (h - th)/2
    draw(graph, x, y, message)
} // repaint

DBE graph = canvas(graphBox, 250, 150, repaint)
show graphBox

```

rectangle

Declaration

```

void rectangle(DBE canvas,
               int x,
               int y,
               int w,
               int h)

```

Operation

Draws a rectangle filled with the current color at position (x,y) , width w , height h on canvas. The co-ordinate system has its origin at the top left.

Example

```

DB graphBox = create "Graphics"

void repaint(DBE graph) {
    background(graph,
        logicalMediumIndicatorColor)
    color(graph, logicalHighIndicatorColor)
    rectangle(graph, 50, 50, 150, 50)
} // repaint

DBE graph = canvas(graphBox, 250, 150, repaint)
show graphBox

```

box

Declaration

```
void box(DBE canvas,
        int x,
        int y,
        int w,
        int h)
```

Operation

Draws an outline rectangle with the current color at position (x, y) , width w , height h on canvas. The co-ordinate system has its origin at the top left.

Example

```
DB graphBox = create "Graphics"
void repaint(DBE graph) {
    background(graph,
               logicalMediumIndicatorColor)
    color(graph, logicalHighIndicatorColor)
    box(graph, 50, 50, 150, 50)
} // repaint
DBE graph = canvas(graphBox, 250, 150, repaint)
show graphBox
```

line

Declaration

```
void line(DBE canvas,
         int x1,
         int y1,
         int x2,
         int y2)
```

Operation

Draws a line from $(x1,y1)$ to $(x2,y2)$ in the current color. The co-ordinate system has its origin is at top left.

Example

```
DB graphBox = create "Graphics"
void repaint(DBE graph) {
    background(graph,
               logicalMediumIndicatorColor)
```

```

        color(graph, logicalHighIndicatorColor)
        line(graph, 0, 0, width graph, height graph)
    } // repaint
    DBE graph = canvas(graphBox, 250, 150, repaint)
    show graphBox

```

ellipse

Declaration

```

void ellipse(DBE canvas,
            int x,
            int y,
            int w,
            int h)

```

Operation

Draws an ellipse filled with the current color within the bounding box specified by position (x, y) , width w , height h on *canvas*. The co-ordinate system has its origin at the top left. If w and h are the same, this draws a circle.

Example

```

DB graphBox = create "Graphics"
void repaint(DBE graph) {
    background(graph,
        logicalMediumIndicatorColor)
    color(graph, logicalHighIndicatorColor)
    ellipse(graph, 0, 0, width graph, height
        graph)
} // repaint
DBE graph = canvas(graphBox, 250, 150, repaint)
show graphBox

```

draw

Declaration

```

void draw(DBE canvas,
         int x,
         int y,
         string s)

```

Operation

Draws the string *s* at position (*x,y*), in the current color with the current font. The co-ordinate system has its origin at top left. The vertical position of the text is at the baseline of the font, so the co-ordinates must be the position for the bottom of most characters. Characters with a descender, such as *g*, use height above and below the baseline.

Example

```
DB graphBox = create "Graphics"
void repaint(DBE graph) {
    background(graph,
        logicalMediumIndicatorColor)
    color(graph, logicalHighIndicatorColor)
    string message = (width graph) " by " (height
        graph) ""
    draw(graph, 10, 20, message)
} // repaint
DBE graph = canvas(graphBox, 250, 150, repaint)
show graphBox
```

drawAngle

Declaration

```
void drawAngle(DBE canvas,
    int x,
    int y,
    string s
    real angle)
```

Operation

Draws the string *s* rotated counter-clockwise by the given angle (in degrees). The rotation is centered around the baseline of the font, at the start of the string.

Example

```
string message = "Hello world"
real angle
DB graphBox = create "drawAngle test"
void repaint (DBE graph) {
    background(graph,
        logicalMediumIndicatorColor)
    color(graph, logicalHighIndicatorColor)
    font(graph, 1, 1)
```

```

draw(graph, 0, 25, message)
for (angle = 0.0; angle < 360.0; angle +=
    360.0 / 8.0)
    drawAngle(graph, 130, 125, message,
        angle)
}
DBE graph = canvas(graphBox, 300, 250, repaint)
show graphBox

```

polarLine

Declaration

```

void polarLine(DBE myCanvas,
    int x,
    int y,
    int lineLength,
    int lineAngle)

```

Operation

Draws a line on the specified canvas from the co-ordinates (x, y) , with a length of *lineLength* at an angle of *lineAngle* degrees to the horizontal. The horizontal starts at the 3 o'clock position, and the angle increases in a clockwise direction.

Example

```

int offset = 0
void doDrawing(DBE myCanvas) {
    int i = 0
    ellipse(myCanvas, 50, 50, 200, 200)
    for (i = 0; i < 360; i += 20) {
        polarLine(myCanvas, 150, 150, 100, i +
            offset)
    }
    offset++
    if (offset >= 20) offset = 0
}
DB myWindow = create "Example"
DBE myCanvas = canvas(myWindow, 300, 300, doDrawing)
show myWindow

```

polygon

Declaration

```
void polygon(DBE myCanvas,  
            int coordArray[ ])
```

Operation

Draws a polygon on the specified canvas using successive co-ordinates held in the specified array.

Example

```
void doDrawing(DBE myCanvas) {  
    int count = 6  
    int coords[8]  
  
    background(myCanvas,  
               logicalPageBackgroundColor)  
  
    color(myCanvas, logicalDataTextColor)  
    coords[0] = 20  
    coords[1] = 20  
    coords[2] = 100  
    coords[3] = 30  
    coords[4] = 200  
    coords[5] = 100  
    coords[6] = 80  
    coords[7] = 150  
    polygon(myCanvas, coords)  
}  
  
DB myWindow = create "Example"  
DBE myCanvas = canvas(myWindow, 300, 300,  
                      doDrawing)  
  
show myWindow
```

bitmap

Declaration

```
void bitmap(DBE myCanvas,  
           string fileName,  
           int x,  
           int y)
```

Operation

Draws the bitmap stored in the specified file, at co-ordinates (x,y) on the specified canvas. This is functionally equivalent to calling `loadBitmap`, `drawBitmap` and `destroyBitmap`.

loadBitmap

Declaration

```
Bitmap loadBitmap(DBE myCanvas,  
                 string fileName,  
                 bool colorMap,  
                 int& w,  
                 int& h)
```

Operation

Loads and caches, for the canvas *myCanvas*, the bitmap stored in file *fileName*.

If *colorMap* is true a private color map is used; otherwise, the system color map is used.

Returns in *w* and *h* the width and height of the bitmap.

Returns the handle of the bitmap.

drawBitmap

Declaration

```
void drawBitmap(DBE myCanvas,  
               Bitmap myBitMap,  
               int x,  
               int y)
```

Operation

Draws the specified bitmap on the specified canvas at co-ordinates (*x,y*).

destroyBitmap

Declaration

```
void destroyBitmap(DBE myCanvas,  
                  Bitmap bitMapHandle)
```

Operation

Destroys the specified bitmap cached for the canvas *myCanvas*.

export

Declaration

```
void export(DBE myCanvas,
           string fileName,
           string formatName)
```

Operation

Exports the specified canvas to the specified file in the specified format, which can be one of these values:

formatName	Format	Platforms
"EPS"	Encapsulated PostScript®	All
"EMF"	Enhanced Metafile	Windows
"WMF"	Windows Metafile	Windows
"PICT2"	Macintosh native picture format	All
"HTML"	HTML to drive Java® applet	All

print

Declaration

```
void print(DBE myCanvas,
          real hScale,
          real vScale)
```

Operation

Prints the specified canvas, horizontally scaled by *hScale* and vertically scaled by *vScale*. The width of the printed image is *hScale* times the width of the on-screen image. The height of the printed image is *vScale* times the height of the on-screen image.

startPrintJob, endPrintJob

Declaration

```
void startPrintJob(string title)
void endPrintJob()
```

Operation

Allows you to package up several prints into one job, to avoid having the Print dialog box shown repeatedly.

Example

```
// Canvas printing demo
int counter = 1
DB theBox = centered "Canvas print demo"
DBE tog, canv

void repaint(DBE canv) {
    realBackground(canv, realColor_White)
    font(canv, 1,1)
    draw(canv, 150, 150, "This is page " counter
        "")
}

void getSettings() {
    bool b = get tog
    showPrintDialogs b
}

void printOne(DB xx) {
    getSettings
    counter = 1
    print(canv, 1.0, 1.0)
}

void printThree(DB xx) {
    getSettings
    startPrintJob "Batch print job"
    counter = 1
    print(canv, 1.0, 1.0)
    counter = 2
    print(canv, 1.0, 1.0)
    counter = 3
    print(canv, 1.0, 1.0)
    endPrintJob
    counter = 1
}

canv = canvas(theBox, 400, 400, repaint)
tog = toggle(theBox, "Show dialogues",
    showPrintDialogs())

apply(theBox, "Print one", printOne)
apply(theBox, "Print three", printThree)

show theBox
```

Complex canvases

This section defines functions for dialog box canvases, which support all the functions of the standard DOORS windows, such as in-place editing, tool tips, header bars, scroll bars, menu bars, status bars, tool bars, and tool bar combo boxes. Normally, canvases do not have these dialog box elements, but functions are available to implement them.

In-place editing

There are three types of in-place editors available in each canvas. They are selected through the following constants:

<code>inPlaceString</code>	specifies a line editor
<code>inPlaceText</code>	specifies a text editor
<code>inPlaceChoice</code>	provides a drop-down list of choices

In-place editing is normally disabled on canvases. The `hasInPlace` function defines an in-place edit callback function, and enables the editors.

hasInPlace

Declaration

```
void hasInPlace(DBE da,
               void cb(DBE el, event))
```

Operation

The callback function is called on one of two event types. The event type is the second argument passed to callback function with one of the following values:

<code>inPlaceTextFilled</code>	the text box is full and needs to be expanded
<code>inPlaceTextChange</code>	the text box contents has been modified

inPlaceMove

Declaration

```
void inPlaceMove(DBE da,
                editor,
                int x,
                int y,
                int w,
                int h)
```

where:

editor is one of the in-place editors: `inPlaceString`, `inPlaceText`, or `inPlaceChoice`

Operation

Moves the specified type of editor to the given location within the canvas.

inPlaceShow

Declaration

```
void inPlaceShow(DBE da,
                editor,
                bool showing)
```

where:

editor is one of the in-place editors: `inPlaceString`, `inPlaceText`, or `inPlaceChoice`

Operation

Displays or hides the specified type of editor, at the location defined by the `inPlaceMove` function, depending on the value of *showing*.

This function automatically triggers the repaint callback.

inPlaceChoiceAdd

Declaration

```
void inPlaceChoiceAdd(DBE da,
                     string item)
```

Operation

Adds an option to the in-place choice editor.

inPlaceCut, inPlaceCopy, inPlacePaste

Declaration

```
void inPlace{Cut|Copy|Paste}(DBE da,
                             editor)
```

where:

editor is one of the in-place editors: `inPlaceString`, `inPlaceText`, or `inPlaceChoice`

Operation

Perform cut, copy, or paste operations on the contents of the in-place text or string editor.

inPlaceGet

Declaration

```
{string|int} inPlaceGet(DBE da,
                       editor)
```

where:

editor is one of the in-place editors: `inPlaceString`, `inPlaceText`, or `inPlaceChoice`

Operation

Returns the in-place editor specified by *editor*. The return value is a string for the text or string editors, and an integer for the choice editor.

inPlaceSet

Declaration

```
void inPlaceSet(DBE da,
                editor,
                {string s|int i})
```

where:

editor is one of the in-place editors: `inPlaceString`, `inPlaceText`, or `inPlaceChoice`

Operation

Sets the text or string editor to have the value *s*, or sets the choice editor to have the value *i*.

inPlaceReset

Declaration

```
void inPlaceReset(DBE da,
                  editor)
```

where:

editor is one of the in-place editors: `inPlaceString`, `inPlaceText`, or `inPlaceChoice`

Operation

Resets the specified editor to have no value.

inPlaceTextHeight

Declaration

```
int inPlaceTextHeight(DBE da)
```

Operation

Returns the number of lines of text displayed in the text editing box.

addToolTip

Declaration

```
void addToolTip(DBE canvas,
               int xpos,
               int ypos,
               int activeWidth,
               int activeHeight,
               type userData
               string tooltipCallback(DBE,
                                     type))
```

Operation

Adds a tool tip to the area of a canvas defined by *xpos*, *ypos*, *activeWidth* and *activeHeight*. The upper left corner of the rectangle is defined by *xpos* and *ypos*.

When the canvas is displayed, if the user places the cursor over this rectangle, the callback function is called with *canvas* as the first argument and the *userData* specified in the call to `addToolTip` as the second argument. The *userData* argument can be of any type. The *tooltipCallback* function returns a string, which is displayed at the cursor's position as a tool tip.

You can use *userData* to customize the tool tip message, so that a single callback function can display different messages depending on the area from which it was activated.

Example

This example produces a tool tip, which appears as: The cursor is in the [upper|lower] [left|right] corner.

```
DB box = create "Tooltip example"
```

```

string toolTipCallback(DBE xx, string mystring) {
    return "The cursor is in the " mystring "
        corner"
}
void repaint(DBE c)
{
    clearToolTips c
    addToolTip(c, 0, 0, 100, 100, "upper left",
        toolTipCallback)
    addToolTip(c, 0, 100, 100, 100, "lower left",
        toolTipCallback)
    addToolTip(c, 100, 0, 100, 100, "upper right",
        toolTipCallback)
    addToolTip(c, 100, 100, 100, 100, "lower
        right", toolTipCallback)
}
DBE canvasWithTips = canvas(box, 200, 200,
    repaint)
show box

```

clearToolTips

Declaration

```
void clearToolTips(DBE canvas)
```

Operation

Removes all tool tips associated with *canvas*.

hasHeader

Declaration

```
void hasHeader(DBE da,
               void cb(DBE el,
                       headerEvent,
                       int hIndex,
                       int param))
```

Operation

This function prepares a canvas for headers. It sets a canvas to have a header bar, and defines a callback. This callback is called by one of the four possible event types, through one of the following constants:

<code>headerResize</code>	a header has been resized; <i>hIndex</i> specifies which heading was changed, and <i>param</i> is its new width
<code>headerEdit</code>	header <i>hIndex</i> was double-clicked to request an edit operation
<code>headerSelect</code>	header <i>hIndex</i> was single-clicked to select
<code>headerReorder</code>	header <i>hIndex</i> was dragged into position <i>param</i>

headerAddColumn

Declaration

```
void headerAddColumn(DBE da,
                    string title,
                    int width)
```

Operation

Adds a header, with the specified title and width. If there is no header selected, the new column appears at the right of the header bar; otherwise it appears to the left of the currently selected header.

headerChange

Declaration

```
void headerChange(DBE da,
                  int index,
                  string title,
                  int width)
```

Operation

Changes the title and width of the header specified by *index*.

headerRemoveColumn

Declaration

```
void headerRemoveColumn(DBE da,
                       int index)
```

Operation

Deletes the header specified by *index* from the header bar.

headerReset

Declaration

```
void headerReset(DBE da)
```

Operation

Removes all the headers defined for the canvas, typically before adding new ones.

headerSelect

Declaration

```
void headerSelect(DBE da,  
                 int index)
```

Operation

Sets header *index* to be selected.

headerSetHighlight

Declaration

```
void headerSetHighlight(DBE da,  
                       int index,  
                       int highlight)
```

Operation

Sets highlight *highlight* in header *index*. Valid highlight indices are 0 and 1; 0 is the upper indicator, 1 is the lower indicator.

headerShow

Declaration

```
void headerShow(DBE da,  
               bool onOff)
```

Operation

Turns header display on or off in the canvas. Headers must already have been enabled for them to be displayed.

hasScrollbars

Declaration

```
void hasScrollbars(DBE da,
                  void cb(DBE canv,
                          ScrollEvent event,
                          ScrollSide scrollBar,
                          int newPos,
                          int oldPos))
```

Operation

This function prepares a canvas for scroll bars. It sets a canvas to have scroll bars, and defines a callback. The callback is called with one of the seven possible event types defined through the following constants:

<code>scrollToEnd</code>	The thumb has been dragged to the bottom or right-hand end of the bar.
<code>scrollToHome</code>	The thumb has been dragged to the top or left-hand end of the bar.
<code>scrollPageUp</code>	The user has clicked in the trough above or to the left of the thumb.
<code>scrollPageDown</code>	The user has clicked in the trough below or to the right of the thumb.
<code>scrollUp</code>	The user has clicked on the left, or up button section of the scroll bar.
<code>scrollDown</code>	The user has clicked on the right, or down button section of the scroll bar.
<code>scrollToPos</code>	The user has dragged the scroll bar to a new position using the thumb.

In each case, the arguments passed to the callback function are as follows:

<i>canv</i>	The canvas to which the event applies.
<i>event</i>	One of the scroll events above.
<i>scrollBar</i>	Either <code>vertical</code> or <code>horizontal</code> to indicate the scroll bar to which the event applies.
<i>new</i>	The new thumb position.
<i>old</i>	The previous thumb position.

scrollSet

Declaration

```
void scrollSet(DBE da,
              scrollbar,
              int maxPos,
              int view,
              int pos)
```

Operation

This function sets the position and size of the thumb; *maxPos* is the maximum possible position, *view* is the size of the thumb, and *pos* is the position to which the start of the thumb is to be moved. When the thumb is at *maxPos*, the end of the thumb is at *maxPos+view*, making the length of the scroll bar *maxPos+view*. The *scrollBar* argument can be vertical or horizontal.

Example

In this example, the thumb has a size of 1 and can move between 0 and 3. The total length of the scroll bar is 4.

```
scrollSet(can, horizontal, 3, 1, 0)
```

menuBar

Declaration

```
DBE menuBar(DB box)
```

Operation

Creates a menu bar within a dialog box. The menu bar automatically appears at the top of the window. Returns a DBE, which must be used for adding menus to the menu bar.

statusBar

Declaration

```
DBE statusBar(DB box,
              string initial,
              int sectionEndpoints[ ]
              [,int noOfSections])
```

Operation

This function creates a status bar within a dialog box. The status bar automatically appears at the bottom of the window. The returned DBE must be used for displaying status values.

Status bars contain a number of text areas, which are specified by their *end point* in pixels. To create a status bar with three areas of 100, 120, and 150 pixels, you must specify *sectionEndpoints* as:

```
{100, 220, 370}
```

You can opt to have either a fixed-size array, and omit *noOfSections*, or a dynamically filled array, in which case specify the number of sections in *noOfSections*.

When creating status bars, you should ensure that any dialog box button elements are hidden.

To place a message in the status bar, use the `set (status bar message)` function.

Menus, status bar and tool bars example

```
#include <utils/icons.inc>
nt backColor = colorYellow
int sizes[] = {150, 300}
DB menuDemo = create "Menu Demo"
void doClose(DB x) {
    hide x
}
close(menuDemo, false, doClose)
BE mb = menuBar(menuDemo)
DBE sb = statusBar(menuDemo, "Initial", sizes)
void repaint(DBE c) {
    background(c, backColor)
}
DBE canv = canvas(menuDemo, 300, 200, repaint)
string entries[] = {"Size",
                   ">Small",
                   ">Normal",
                   ">Large",
                   "Style",
                   ">Bold",
                   ">Italic"}

char mn[] = {'S',
             'm',
             'N',
             'L',
             't',
             'B',
             'I'}

har hot[] = {ddbNone,
             ddbNone,
             ddbNone,
             ddbNone,
             ddbNone,
             ddbNone,
             ddbNone}
```

```

string help[] = {"Set size",
                "Small fonts",
                "Normal fonts",
                "Large fonts",
                "Set style",
                "Bold font",
                "Italic font"}

string inactive[]= {"Never",
                   "Never",
                   "Never",
                   "Never",
                   "Never",
                   "Never",
                   "Never"}

Sensitivity sensitive(int index) {
    if (index == 2 || index == 6)
        return ddbChecked
    return ddbAvailable
}

void cb(int index) {
    ack "Menu " help[index] " activated"
}

addMenu(mb, "Format", 'F', entries, mn, hot,
        help, inactive, sensitive, cb)

show menuDemo

```

This generates the following dialog box:



Toolbars

This section defines functions for using toolbars in dialog boxes, module windows and canvases.

toolBar

Declaration

```
DBE toolBar(DB Box[, string name, Sensitivity mappingCallback()], ToolType
types[], int param[], string toolTip[], string help[], string inactiveHelp[][,
int noOfTools], Sensitivity sensitive(int entryIndex), void callback(int
entryIndex)[, bool newRow, bool showName])
```

Operation

Creates a tool bar within a dialog box. Tool bars can be displayed anywhere in a dialog box and can be placed either with constraints or with the normal automatic placement. Normally tool bars appear between a menu bar and a canvas, which is usually followed by a status bar.

Tool bar contents are specified as arrays all containing the same number of elements. To use fixed-size arrays all containing the same number of elements, omit *noOfTools*. To use freely-defined arrays, specify the minimum number of elements in *noOfTools*.

The arguments passed to the function are defined as follows:

<i>types</i>	the type of the tool, which can have one of the following values:
<code>toolButton</code>	A regular click-to-activate icon.
<code>toolToggle</code>	A toggle in/out icon.
<code>toolRadio</code>	A mutually exclusive toggle icon.
<code>toolCombo</code>	A drop-down list of strings.
<code>toolSpacer</code>	A larger gap.
<code>toolEditableCombo</code>	A drop down list of strings plus an area in which to enter new strings.
<i>param</i>	For a <code>toolButton</code> or <code>toolToggle</code> , this is the id of the icon; the include file <code>utils/icons.inc</code> defines all the icons available as constants; for a <code>toolCombo</code> , it specifies the width of the drop-down list in pixels; there is no value for <code>toolSpacer</code> .
<i>toolTip</i>	String that is displayed in the tool tip for this tool.
<i>help</i>	String that is displayed in the status bar of the window, if one exists, as the user passes the mouse over an active tool.

inactive String that is displayed in the status bar of the dialog box, if one exists, as the user passes the mouse over an inactive tool.

Two callback functions are required: one to determine whether tools are sensitive, and one that is called when a tool is activated. `sensitive(int entryIndex)` is called for each entry when the toolbar is first displayed or when the `updateToolBars` function is called.

The function must return one of the following values:

<code>ddbUnavailable</code>	The tool\toolbar is unavailable.
<code>ddbAvailable</code>	The tool\toolbar is active.
<code>ddbChecked</code>	The tool\toolbar is active and has a check beside it.
<code>ddbInvisible</code>	The tool\toolbar is not shown

When the user selects an entry, `callback(int entryIndex)` is called with the index of the tool, and your program must perform the appropriate operation. For both `sensitive` and `callback` functions, `entryIndex` starts at 0, and counts up, so there is a direct correspondence between the array elements and the index returned by the menu.

Optional are name and callback function parameters, as well as booleans determining whether or not the toolbar should be allocated a new row in the container, and whether or not the name should be shown.

If the name parameter is specified, the toolbar will be hosted within a container control at the top of the dialog, if not, the toolbar will be generated on the canvas. If name is specified then `newRow` and `showName` are mandatory.

The callback function determines how the toolbar option will appear in the context menu for the container control. The possible return values are the same Sensitivity values listed in the table above.

There is also a new `ToolType` available: `ToolEditableCombo`. It behaves the same as `ToolCombo` other than that the text in the editable area of the combo box is editable, i.e. a drop down list of strings plus an area in which to enter new strings.

updateToolBars

Declaration

```
void updateToolBars(DB box)
```

Operation

Refreshes the state of the tools in all tool bars in dialog box `box`.

toolBarComboGetSelection

Declaration

```
{string|int} toolBarComboGetSelection(DBE tb,
                                     int index)
```

Operation

Returns the string value of the currently selected option or the index of the currently selected option. The *index* argument specifies which tool is to be processed, counting from 0. All tools are included in the count.

toolBarComboGetItem

Declaration

```
string toolBarComboGetItem(DBE tb,
                          int cIndex,
                          int iIndex)
```

Operation

Returns the string value of option *iIndex* in the tool bar combo box specified by *cIndex*. The *iIndex* argument specifies which tool is to be processed, counting from 0. All tools are included in the count.

toolBarComboSelect

Declaration

```
void toolBarComboSelect(DBE tb,
                       int index,
                       {string item|int position})
```

Operation

Selects the option with value *item* (or in indexed *position*) in the tool bar combo box. The *index* argument specifies which tool is to be processed, counting from 0.

toolBarComboCount

Declaration

```
int toolBarComboCount(DBE tb,
                     int index)
```

Operation

Returns the number of options in the tool bar combo box. The *index* argument specifies which tool is to be processed, counting from 0.

toolBarComboEmpty

Declaration

```
void toolBarComboEmpty(DBE tb,
                      int index)
```

Operation

Deletes all the options in the tool bar combo box. The *index* argument specifies which tool is to be processed, counting from 0.

toolBarComboAdd

Declaration

```
void toolBarComboAdd(DBE tb,
                    int index,
                    string item)
```

Operation

Adds an option with value *item* at the end of the tool bar combo box. The *index* argument specifies which tool is to be processed, counting from 0.

toolBarComboInsert

Declaration

```
void toolBarComboInsert(DB tb, int index, int position, string item)
```

Operation

Adds an option with value *item* at the specified *position* of the tool bar combo box list. If the *position* parameter is -1, the item is added to the end of the list. The *index* argument specifies which tool is to be processed, counting from 0.

toolBarComboDelete

Declaration

```
void toolBarComboDelete(DB tb, int index, int position)
```

Operation

Used to delete a record within a drop down combo. Takes the *position* in the list of the item to be deleted. The first item has an index of 0. The *index* argument specifies which tool is to be processed, counting from 0.

toolBarVisible

Declaration

```
bool toolBarVisible({Module mod|DBE toolbar|DB box, string name})
```

Operation

Used to retrieve the visibility state of a toolbar. Only applies to toolbars that are hosted within the appropriate container control, i.e. those that were created with the name parameter specified.

toolBarMove

Declaration

```
void toolBarMove({Module mod|DBE toolbar|DB box, string name}, int iposition,  
bool newRow)
```

Operation

Used to change the position of a toolbar. The toolbar is identified differently depending on which parameters are supplied. This method applies only to toolbars that are hosted within the appropriate container control, i.e. those that were created with the name parameter specified.

The `newRow` parameter defines whether the toolbar is shown on a new row within the ReBar control or not.

toolBarShow

Declaration

```
void toolBarShow({Module mod|DBE toolbar|DB box, string name}, bool bShow)
```

Operation

Used to change the visibility of a toolbar, as identified by the supplied parameters. Applies only to toolbars that are hosted within the appropriate container control, i.e. those that were created with the name parameter specified.

createEditableCombo

Declaration

```
void createEditableCombo({linksetCombo|viewCombo|helpCombo})
```

Operation

Creates an editable combo box in a tool bar in a module or user-created dialog box

Colors

This section defines constants and a function that allow you to use color in dialog boxes within DOORS. Colors can be used with attribute types and with canvas dialog box elements.

Logical colors

Logical colors are defined on the options menu.

Declaration

`const int color`

where `color` can be one of the following:

`logicalCurrentObjectOutline`

`logicalGridLines`

`logicalDefaultColor`

`logicalPageBackgroundColor`

`logicalTextBackgroundColor`

`logicalCurrentBackgroundColor`

`logicalCurrentCellBackgroundColor`

`logicalTitleBackgroundColor`

`logicalReadOnlyTextBackgroundColor`

`logicalUnlockedTextBackgroundColor`

`logicalDataTextColor`

`logicalTitleTextColor`

`logicalSelectedTextColor`

`logicalReadOnlyTextColor`

`logicalDeletedTextColor`

`logicalHighIndicatorColor`

`logicalMediumIndicatorColor`

`logicalLowIndicatorColor`

`logicalGraphicsBackgroundColor`

`logicalGraphicsShadeColor`

`logicalGraphicsElideBoxColor`

`logicalGraphicsTextColor`

`logicalGraphicsBoxColor`

`logicalGraphicsLinkColor`

`logicalGraphicsCurrentColor`

`logicalGraphicsSelectedColor`

`logicalGraphicsBoxEdgeColor`

`logicalLinkPageBackgroundColor`

`logicalLinkTextBackgroundColor`

`logicalLinkCurrentBackgroundColor`

`logicalLinkTitleBackgroundColor`

logicalLinkDataTextColor
logicalUser1Color
logicalUser2Color
logicalUser3Color
logicalUser4Color
logicalUser5Color
logicalPageBackgroundFilterColor
logicalPageBackgroundSortColor
logicalPageBackgroundFilterSortColor
logicalTitleBackgroundColor
logicalInPlaceTextColor
logicalInPlaceBackgroundColor
logicalPartitionOutTextColor
logicalPartitionInReadTextColor
logicalPartitionInWriteTextColor
logicalHighlightURLColor
logicalLinksOutIndicatorColor
logicalLinksInIndicatorColor
logical0IndicatorColor
logical111IndicatorColor
logical22IndicatorColor
logical33IndicatorColor
logical44IndicatorColor
logical55IndicatorColor
logical66IndicatorColor
logical77IndicatorColor
logical88IndicatorColor
logical100IndicatorColor
logicalPrintPreviewBackgroundColor
logicalPrintPreviewPageColor
logicalPrintPreviewTextColor
logicalPrintPreviewShadeColor

Actual colors

Actual colors are dependent on the default DOORS setup. These may not make sense if you change your color options.

Declaration

```
const int color
```

where *color* can be one of:

```
colorLightBlue
```

```
colorMediumLightBlue
```

```
colorDarkTurquoise
```

```
colorPink
```

```
colorBlue
```

```
colorMaroon
```

```
colorRed
```

```
colorYellow
```

```
colorGreen
```

```
colorMagenta
```

```
colorCyan
```

```
colorWhite
```

```
colorOrange
```

```
colorBrown
```

```
colorBlack
```

```
colorGrey82
```

```
colorGrey77
```

```
colorRedGrey
```

```
colorGrey
```

Real colors

Real colors are the colors you assign to logical colors.

Declaration

```
const int color
```

where *color* can be one of:

```
int realColor_Light_Blue2
```

```
int realColor_Light_Blue
```

```
int realColor_Dark_Turquoise
int realColor_Pink
int realColor_Blue
int realColor_Maroon
int realColor_Red
int realColor_Yellow
int realColor_Green
int realColor_Cyan
int realColor_Magenta
int realColor_White
int realColor_Orange
int realColor_Brown
int realColor_Purple
int realColor_Navy
int realColor_Sea_Green
int realColor_Lime_Green
int realColor_Rosy_Brown
int realColor_Peru
int realColor_Red_Grey
int realColor_Firebrick
int realColor_Thistle
int realColor_Grey82
int realColor_Grey77
int realColor_Grey66
int realColor_Grey55
int realColor_Grey44
int realColor_Grey33
int realColor_Grey22
int realColor_Grey11
int realColor_Black
int realColor_NewGrey1
int realColor_NewGrey2
int realColor_NewGrey3
int realColor_NewGrey4
```

Real colors are applied using the `realBackground` and `realColor` functions.

getLogicalColorName

Declaration

```
string getLogicalColorName(int logicalColor)
```

Operation

Returns the name of *logicalColor*, which can be any of the values defined in “Logical colors,” on page 510.

getRealColor

Declaration

```
int getRealColor(int logicalColor)
```

Operation

Returns the actual color value assigned to *logicalColor*, which can be any of the values defined in “Real colors,” on page 513.

getRealColorIcon

Declaration

```
Icon getRealColorIcon(int realColorIndex)
```

Operation

Returns the icon of *realColorIndex*, which can be any of the values defined in “Real colors,” on page 513. The icon is for use in a list view or tree view that is all the specified color.

getRealColorName

Declaration

```
string getRealColorName(int realColor)
```

Operation

Returns the name of *realColor*, which can be any of the values defined in “Real colors,” on page 513.

setRealColor

Declaration

```
string setRealColor(int logicalColor,  
                   int realColor)
```

Operation

Sets *logicalColor* (which can have any of the values defined in “Logical colors,” on page 510) to *realColor* (which can be any of the values defined in “Real colors,” on page 513).

Example

This example sets the logical data text color to green:

```
setRealColor(logicalDataTextColor,  
            realColor_Green)
```

Simple placement

This section defines the simple, more or less automatic placement mechanism. This allows you to specify where to place the next element, relative to the previous one. A fully constrainable mechanism is described in “Constrained placement,” on page 519.

beside

Declaration

```
void beside(DB box)
```

Operation

Places the next element to the right of the last one.

below (element)

Declaration

```
void below(DB box)
```

Operation

Places the next element below the last one, and aligned with it.

left

Declaration

```
void left(DB box)
void flushLeft(DB box)
```

Operation

Places the next element below the last one, at the left of the dialog box.

The `flushLeft` function is only provided for v2.1 compatibility.

leftAligned

Declaration

```
void leftAligned(DB box)
```

Operation

Places the next element in the column at the left-hand side of the dialog box. This is the default placement option: if there are no other alignment options specified items are aligned in a single column.

right

Declaration

```
void right(DB box)
void flushRight(DB box)
```

Operation

Places the next element below the last one, at the right of the dialog box.

The `flushRight` function is only provided for v2.1 compatibility.

opposite

Declaration

```
void opposite(DB box)
```

Operation

Places the next element on the same row as the last one, but aligned with the right of the dialog box. After creating the next element another placement mode must be set.

full

Declaration

```
void full(DB box)
```

Operation

Specifies that subsequent elements are created at full window width. Labels are aligned on the left; the data area is stretched to be aligned to the right edge of the window. When the dialog box is resized, the element resizes with it. This is most useful with field elements.

stacked

Declaration

```
void stacked(DBE element)
```

Operation

Stacks this dialog-box element on top of the preceding one. This is most useful when building an attribute value editor dialog box. Obviously it does not make sense to leave several stacked elements visible, so this is normally used in conjunction with `hide`.

Example

```
string enums[] = {"one", "two", "three"}
DB dbBox = "Stacked Example"
DBE stringEdit = field(dbBox, "String:", null,
                      20, false)
DBE enumEdit = choice(dbBox, "Enum:", enums, 3,
                     0)

stacked enumEdit
hide enumEdit
DBE intEdit = slider(dbBox, "Int:", 0, 100, 0)
stacked intEdit
hide intEdit
show(dbBox)
```

Constrained placement

This section defines the constrained placement functions, which expose the full power of the DOORS dialog placement mechanism. As with all power, responsibility is required. You can easily create broken dialog boxes with this mechanism. It is intended for experienced users only, especially those who are sufficiently familiar with simple placement to have reached its limitations.

Constrained placement basics

Here is a standard dialog box, or form:

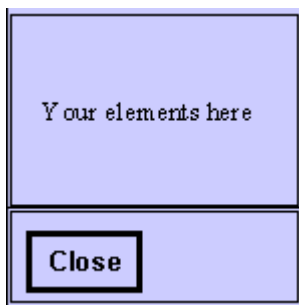

Dialog box elements are attached to each other and to the dialog box on all edges:

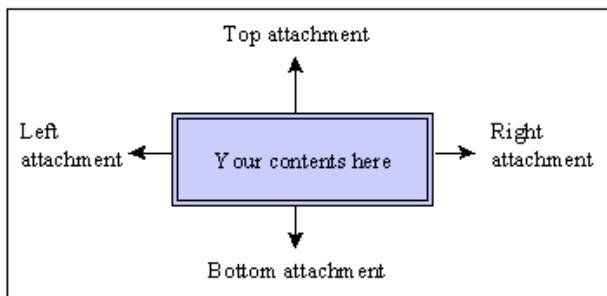

Attachments can be any of the following:

- spaced
- flush
- unattached
- aligned
- inside (normally used within frames or tab strips)

When you place your first element in the dialog box, it has its attachment points connected up for you as follows:

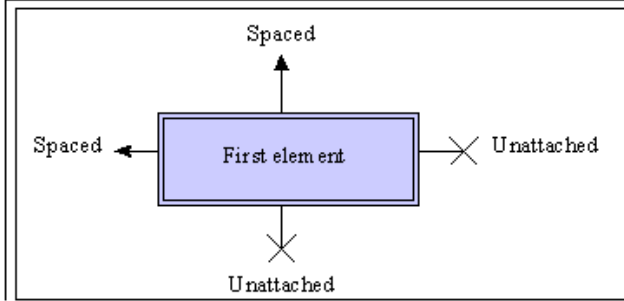

When you add your next DBE, it is hooked up as follows:

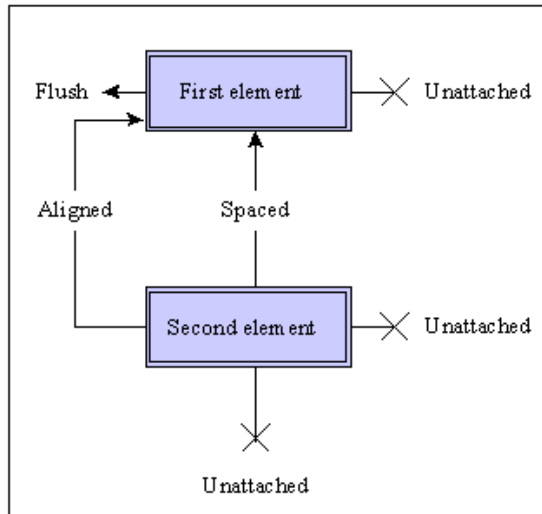

And so on, until the last one is hooked up to the separator as follows:

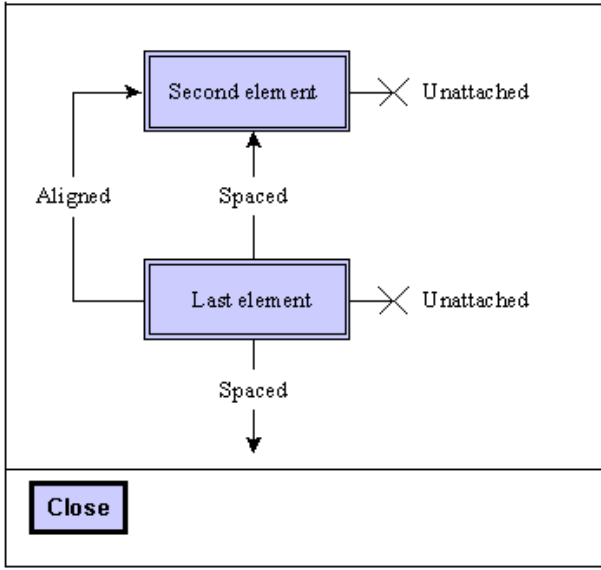

Some elements, such as lists, texts, and canvases, come joined onto the form on both vertical edges:

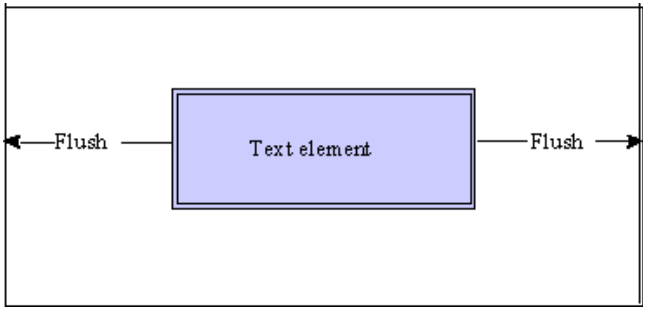

All the other options are implemented in the same style. In implementing a constraint based dialog box layout, it is advisable to draw all the items and their relationships on a piece of paper before encoding them.

Attachment placement

The `->` operator is used in constrained placement, as shown in the following syntax:

```
DBE elem -> string side -> string attachment [-> DBE other]
```

where:

elem Is a dialog box element of type DBE .

<i>side</i>	Is the side the attachment is on: <code>left</code> , <code>right</code> , <code>top</code> or <code>bottom</code> (these are not case sensitive).
<i>attachment</i>	Is the type of attachment: <code>flush</code> , <code>spaced</code> , <code>aligned</code> , <code>unattached</code> , <code>inside</code> or <code>form</code> (these are not case sensitive).
<i>other</i>	Is the dialog box element of type DBE that is the one relative to which placement is to be performed.

The three operators together make a complete specification for the attachment.

Note: You must place dialog box elements in the order they are defined. In the following examples, `mylist` must be declared before `otherList`, and `theFrame` must be declared before `theTab` for the placement to work.

Example

```
mylist->"left"->"unattached"
mylist->"right"->"form"
mylist->"left"->"flush" // not complete
mylist->"left"->"flush"->otherList
theFrame->"left"->"inside"->theTab
theFrame->"right"->"inside"->theTab
theFrame->"top"->"inside"->theTab
theFrame->"bottom"->"inside"->theTab
```

Worked example

This is a worked example of placing three lists side by side in a dialog box. The first step is to work out the attachments:

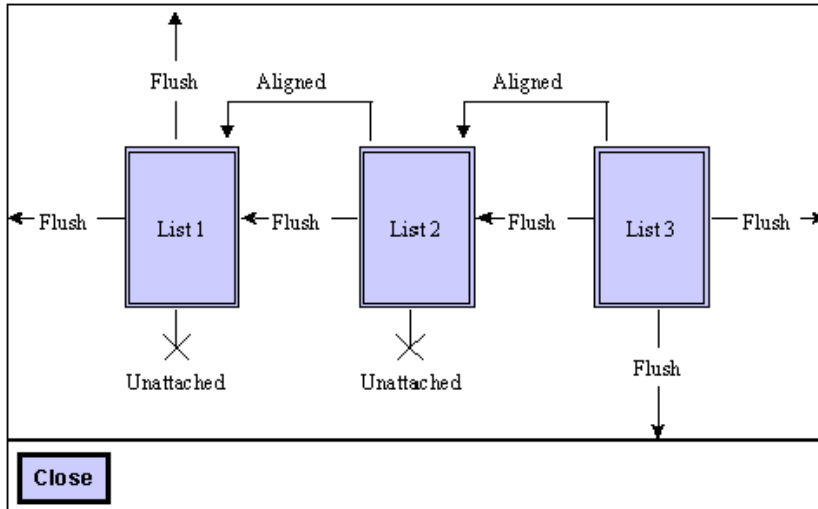

Initially, declare the dialog box and lists:

```
DB threeListBox = create "The Three Lists play Carnegie Hall"
DBE list1 = list(threeListBox, "One", 100, 10, listOneData)
DBE list2 = list(threeListBox, "Two", 100, 10, listTwoData)
DBE list3 = list(threeListBox, "Three", 100, 10, listThreeData)
```

Now connect each one up, remembering to *disconnect* attachments where they would be problematic. This disconnects the first list from the right-hand edge of the form:

```
list1->"right"->"unattached"
```

This connects the left edge of List 2 to the right hand edge of List 1, then aligns the top of List 2 with the top of List 1, and then disconnects the right-hand edge of List 2 from the form:

```
list2->"left"->"flush"->list1
list2->"top"->"aligned"->list1
list2->"right"->"unattached"
```

This does much the same, but note that List 3 remains connected to the form:

```
list3->"left"->"flush"->list2
list3->"top"->"aligned"->list1
```

Instead of aligning the tops of the lists you could connect them all to the form:

```
list1->"top"->"form"
```

```
list2->"top"->"form"
```

```
list3->"top"->"form"
```

but that only works in this case. If List 1 is preceded by another element, for example a field, and you still want the three parallel lists, you need to use alignment.

Constrained placement full example program

```
// parallel list DB example
/*
   example of DXL dialog boxes which
   builds parallel lists.
*/
DBE plistBox = create "Parallel lists"
string listOne[] = {"One", "Two", "Three"}
string listTwo[] = {"Un", "Deux", "Trois"}
string listThree[] = {"Uno", "Dos", "Tres"}
DBE l1 = list(plistBox, "English", 80, 5,
              listOne)
DBE l2 = list(plistBox, "French", 80, 5,
              listTwo)
DBE l3 = list(plistBox, "Spanish", 80, 5,
              listThree)
DBE t1 = text(plistBox, null, null, 80, 50,
              false)
DBE t2 = text(plistBox, null, null, 80, 50,
              false)
DBE t3 = text(plistBox, null, null, 80, 50,
              false)
l1->"right"->"unattached"
l2->"left"->"spaced"->l1
l2->"top"->"aligned"->l1
l2->"right"->"unattached"
l3->"left"->"spaced"->l2
l3->"top"->"aligned"->l1
l3->"right"->"form"
t1->"top"->"spaced"->l1
t1->"right"->"unattached"
t2->"left"->"spaced"->t1
```



```

t2->"top"->"spaced"->l2
t2->"right"->"unattached"
t3->"left"->"spaced"->t2
t3->"top"->"spaced"->l3
t3->"right"->"form"
void listSel(DBE l) {
    string w = get l
    DBE t
    if (!null w) {
        if (l == l1) t = t1
        if (l == l2) t = t2
        if (l == l3) t = t3
        set(t, w)
    }
}
set(l1, listSel)
set(l2, listSel)
set(l3, listSel)
show plistBox

```

Progress bar

This section defines functions for the progress bar, which is not a dialog box element as such, but a secondary window that is displayed over the parent window. It contains a title, a message, a progress bar and a **Cancel** button.

progressStart

Declaration

```

void progressStart(DB box,
                  string title,
                  string message,
                  int limit)

```

Operation

Displays the progress bar and window. The *limit* argument specifies the maximum value that is passed to *progressStep*.

progressStep

Declaration

```
void progressStep(int position)
```

Operation

Moves the progress bar to the given position, which must be between 0 and *limit* defined in the preceding call to `progressStart`. Progress can be forward, backward, or cyclic.

progressMessage

Declaration

```
void progressMessage(string message)
```

Operation

Sets the message field in the progress window.

progressRange

Declaration

```
void progressRange(string message,  
                  int position,  
                  int limit)
```

Operation

Specifies new message, position and limit values for the progress bar.

progressCancelled

Declaration

```
bool progressCancelled()
```

Operation

Returns `true` if the **Cancel** button has been clicked in the progress bar window; otherwise, returns `false`. This can be used to terminate a long-running operation.

progressStop

Declaration

```
void progressStop()
```

Operation

Removes the progress bar window from the screen.

Progress bar example

```
void progCB(DB x) {
    Object o
    int nos = 0
    for o in current Module do nos++
    progressStart(x, "Experiment", "Something",
                 nos)

    nos = 0
    for o in current Module do {
        string h = o."Object Heading"
        progressStep ++nos
        if (null h) h = "null heading"
        progressMessage h

        if (progressCancelled) {
            if (confirm("Exit loop?")) {
                progressStop
                halt
            }
        }
    }

    progressStop
}

if (null current Module) {
    ack "Please run from a module"
    halt
}

DB progressDB = create "Progress test"
label(progressDB, "Demonstration of the progress
        bar")

apply(progressDB, progCB)
```

```
show progressDB
```

DBE resizing

setExtraWidthShare(DBE)

Declaration

```
string setExtraWidthShare(DBE control, real share)
```

Operation

Sets the share of any extra width that will go to the DBE when the DB is resized.

share should be between 0 and 1.0.

setExtraHeightShare(DBE)

Declaration

```
string setExtraHeightShare(DBE control, real share)
```

Operation

Sets the share of any extra height that will go to the DBE *control* when the DB is resized.

share should be between 0 and 1.0.

Example

```
DB test = create("Field Test")
DBE rich = richText(test, "Rich Text", "This one should expand", 200, 50, false)
DBE readOnlyRich = richText(test, "Rich Text", "This one should expand", 200,
150, true)
DBE rtfField = richField(test, "Rich Field", "This one should be fixed height",
31, false)
DBE lab = label(test, "A label")
realize(test)
setExtraHeightShare(rich, 0.25)
setExtraHeightShare(readOnlyRich, 0.75)
show test
```

HTML Control

The section describes the DXL support for the HTML control.

Note: Some of the functions listed below take an ID string parameter to identify either a frame or an HTML element. In each of these methods, frames or elements nested within other frames are identified by concatenating the frame IDs and element IDs as follows: `<top frame ID>/[<sub frame ID>/...]<element ID>`.

In methods requiring a frame ID, passing `null` into this parameter denotes the top level document.

These methods refer to all frame types including IFRAME and FRAME elements.

htmlView

Declaration

```
DBE htmlView (DB parentDB, int width, int height, string URL, bool
before_navigate_cb(DBE element, string URL, string frame, string postData), void
document_complete_cb(DBE element, string URL), bool navigate_error_cb(DBE
element, string URL, string frame, int statusCode), void progress_cb(DBE
element, int percentage))
```

Operation

Creates an HTML view control where the arguments are defined as follows:

parentDB	The dialog box containing the control.
<code>width</code>	The initial width of the control.
<code>height</code>	The initial height of the control.
<code>URL</code>	The address that will be initially loaded into the control. Can be null to load a blank page (about:blank).

parentDB**The dialog box containing the control.**`before_navigate_cb`

Fires for each document/frame before the HTML window/frame navigates to a specified URL. It could be used, amongst other things, to intercept and process the URL prior to navigation, taking some action and possibly also navigating to a new URL.

The return value determines whether or not to cancel the navigation. Returning `false` cancels the navigation.

Its arguments are defined as follows:

- `element`: The HTML control itself
- `URL`: The address about to be navigated to.
- `frame`: The frame for which the navigation is about to take place.
- `postData`: The data about to be sent to the server if the HTTP POST transaction is being used.

`document_complete_cb`

Fires for each document/frame once they are completely loaded and initialized. It could be used to start functionality required after all the data has been received and is about to be rendered, for example, parsing the HTML document.

Its arguments are defined as follows:

- `element`: The HTML control itself
- `URL`: The loaded address.

`navigate_error_cb`

Fires when an error occurs during navigation. Could be used, for example, to display a default document when internet connectivity is not available.

Its arguments are defined as follows:

- `elements`: The HTML control itself.
- `URL`: The address for which navigation failed.
- `frame`: The frame for which the navigation failed.
- `statusCode`: Standard HTML error code.

`progress_cb`

Used to notify about the navigation progress, which is supplied as a percentage.

set(html callback)

Declaration

```
void set (DBE HTMLView, bool event_cb(DBE element, string ID, string tag, string event_type))
```

Operation

Attaches a callback to HTML control element that receives general HTML events. The `ID` argument identifies the element that sourced the event, the `tag` argument identifies the type of element that sourced the event, and the `event_type` argument identifies the event type. Note that the only event types currently supported are `click` and `dblclick`.

If this function is used with an incorrect DBE type, a DXL run-time error occurs.

set(html URL)

Declaration

```
void set (DBE HTMLView, string URL)
```

Operation

Navigates the given *HTMLView* to the given *URL*.

Can only be used to navigate the top level document and cannot be used to navigate nested frame elements.

setURL

Declaration

```
void setURL (DBE HTMLView, string ID, string URL)
```

Operation

Navigates the frame identified by *ID* to the given *URL*. The ID may be null.

getURL

Declaration

```
string getURL (DBE HTMLView, string ID)
```

Operation

Returns the URL for the currently displayed frame as identified by its *ID*. The ID may be null.

get(HTML view)

Declaration

```
string get (DBE HTMLView)
```

Operation

Returns the URL currently displayed in the given *HTMLView*, if there is one.

get(HTML frame)

Declaration

```
Buffer get (DBE HTMLView, string ID)
```

Operation

Returns the URL for the currently displayed frame as identified by its *ID*.

set(HTML view)

Declaration

```
string set (DBE HTMLView, Buffer HTML)
```

Operation

Sets the HTML fragment to be rendered inside the <body> tags by the HTML view control directly. This allows the controls HTML to be constructed dynamically and directly rendered.

setHTML

Declaration

```
string setHTML (DBE HTMLView, string ID, Buffer HTML)
```

Operation

Sets the HTML fragment to be rendered inside the <body> tags by the HTML view controls frame as identified by *ID*. This allows the HTML of the given document or frame to be constructed dynamically and directly rendered.

Note: The contents of the frame being modified must be in the same domain as the parent HTML document to be modifiable. A DXL error will be given on failure (for example, if the wrong type of DBE is supplied).

getHTML

Declaration

```
Buffer getHTML (DBE HTMLView, string ID)
```

Operation

Returns the currently rendered HTML fragment inside the <body> tags of the document or frame as identified by its *ID*.

getBuffer

Declaration

```
Buffer getBuffer (DBE HTMLView)
```

Operation

Returns the currently rendered HTML.

getInnerText

Declaration

```
string getInnerText (DBE HTMLView, string ID)
```

Operation

Returns the text between the start and end tags of the first object with the specified *ID*.

setInnerText

Declaration

```
void setInnerText (DBE HTMLView, string ID, string text)
```

Operation

Sets the text between the start and end tags of the first object with the specified *ID*.

getInnerHTML

Declaration

```
string getInnerHTML (DBE HTMLView, string ID)
```

Operation

Returns the HTML between the start and end tags of the first object with the specified *ID*.

setInnerHTML

Declaration

```
void setInnerHTML (DBE HTMLView, string ID, string html)
```

Operation

Sets the HTML between the start and end tags of the first object with the specified *ID*.

Note: The `innerHTML` property is read-only on the `col`, `colGroup`, `frameSet`, `html`, `head`, `style`, `table`, `tBody`, `tFoot`, `tHead`, `title`, and `tr` objects.

Example

```
DB dlg
DBE htmlCtrl
DBE htmlBtn
DBE html

void onTabSelect(DBE whichTab){
    int selection = get whichTab
}

void onSetHTML(DBE button){
    Buffer b = create
    string s = get(htmlCtrl)
    print s
    b = s
    set(html, b)
    delete b
}

void onGetInnerText(DBE button){
    string s = getInnerText(html, "Text")
    confirm(s)
}

void onGetInnerHTML(DBE button){
    string s = getInnerHTML(html, "Text")
    confirm(s)
}

void onGetAttribute(DBE button){
    string s = getAttribute(html, "Text", "Align")
```

```
        confirm(s)
    }

void onSetInnerText(DBE button){
    Buffer b = create
    string s = get(htmlCtrl)
    setInnerText(html, "Text", s)
}

void onSetInnerHTML(DBE button){
    Buffer b = create
    string s = get(htmlCtrl)
    setInnerHTML(html, "Text", s)
}

void onSetAttribute(DBE button){
    Buffer b = create
    string s = getAttribute(html, "Text", "Align")
    if (s == "left"){
        s = "center"
    }
    else if (s == "center"){
        s = "right"
    }
    else if (s == "right"){
        s = "left"
    }

    setAttribute(html, "Text", "align", s)
}

bool onHTMLBeforeNavigate(DBE dbe, string URL, string frame, string body){
    string buttons[] = {"OK"}
```

```

        string message = "Before navigate - URL: " URL "\r\nFrame: " frame
"\r\nPostData: " body "\r\n"
        print message ""
        return true
    }

void onHTMLDocComplete(DBE dbe, string URL){
    string buttons[] = {"OK"}
    string message = "Document complete - URL: " URL "\r\n"
    print message ""
    string s = get(dbe)
    print "url: " s "\r\n"
}

bool onHTMLError(DBE dbe, string URL, string frame, int error){
    string buttons[] = {"OK"}
    string message = "Navigate error - URL: " URL "; Frame: " frame "; Error: "
error "\r\n"
    print message ""
    return true
}

void onHTMLProgress(DBE dbe, int percentage){
    string buttons[] = {"OK"}
    string message = "Percentage complete: " percentage "%\r\n"
    print message
    return true
}

dlg = create("Test", styleCentered | styleThemed | styleAutoparent)
htmlCtrl = text(dlg, "Field:", "<html><body>\r\n<p id=\"Text\"
align=\"center\">Welcome to <b>DOORS <i>ERS</i></b></p>\r\n</body></html>",
200, false)
htmlBtn = button(dlg, "Set HTML...", onSetHTML)
DBE getInnerTextBtn = button(dlg, "Get Inner Text...", onGetInnerText)

```

```

DBE getInnerHTMLBtn = button(dlg, "Get Inner HTML...", onGetInnerHTML)
DBE getAttributeBtn = button(dlg, "Get Attribute...", onGetAttribute)
DBE setInnerTextBtn = button(dlg, "Set Inner Text...", onSetInnerText)
DBE setInnerHTMLBtn = button(dlg, "Set Inner HTML...", onSetInnerHTML)
DBE setAttributeBtn = button(dlg, "Set Attribute...", onSetAttribute)

```

```

DBE frameCtrl = frame(dlg, "A Frame", 800, 500)

```

```

string strTabLabels[] = {"One", "Two"}

```

```

DBE tab = tab(dlg, strTabLabels, 800, 500, onTabSelect)

```

```

htmlCtrl->"top"->"form"

```

```

htmlCtrl->"left"->"form"

```

```

htmlCtrl->"right"->"unattached"

```

```

htmlCtrl->"bottom"->"unattached"

```

```

htmlBtn->"top"->"spaced"->htmlCtrl

```

```

htmlBtn->"left"->"form"

```

```

htmlBtn->"right"->"unattached"

```

```

htmlBtn->"bottom"->"unattached"

```

```

getInnerTextBtn->"top"->"spaced"->htmlCtrl

```

```

getInnerTextBtn->"left"->"spaced"->htmlBtn

```

```

getInnerTextBtn->"right"->"unattached"

```

```

getInnerTextBtn->"bottom"->"unattached"

```

```

getInnerHTMLBtn->"top"->"spaced"->htmlCtrl

```

```

getInnerHTMLBtn->"left"->"spaced"->getInnerTextBtn

```

```

getInnerHTMLBtn->"right"->"unattached"

```

```

getInnerHTMLBtn->"bottom"->"unattached"

```

```

getAttributeBtn->"top"->"spaced"->htmlCtrl

```

```

getAttributeBtn->"left"->"spaced"->getInnerHTMLBtn

```

```

getAttributeBtn->"right"->"unattached"

```

```
getAttributeBtn->"bottom"->"unattached"
```

```
setInnerTextBtn->"top"->"spaced"->htmlBtn
```

```
setInnerTextBtn->"left"->"aligned"->getInnerTextBtn
```

```
setInnerTextBtn->"right"->"unattached"
```

```
setInnerTextBtn->"bottom"->"unattached"
```

```
setInnerHTMLBtn->"top"->"spaced"->htmlBtn
```

```
setInnerHTMLBtn->"left"->"spaced"->setInnerTextBtn
```

```
setInnerHTMLBtn->"right"->"unattached"
```

```
setInnerHTMLBtn->"bottom"->"unattached"
```

```
setAttributeBtn->"top"->"spaced"->htmlBtn
```

```
setAttributeBtn->"left"->"spaced"->setInnerHTMLBtn
```

```
setAttributeBtn->"right"->"unattached"
```

```
setAttributeBtn->"bottom"->"unattached"
```

```
frameCtrl->"top"->"spaced"->setInnerTextBtn
```

```
frameCtrl->"left"->"form"
```

```
frameCtrl->"right"->"form"
```

```
frameCtrl->"bottom"->"form"
```

```
tab->"top"->"inside"->frameCtrl
```

```
tab->"left"->"inside"->frameCtrl
```

```
tab->"right"->"inside"->frameCtrl
```

```
tab->"bottom"->"inside"->frameCtrl
```

```
html = htmlView(dlg, 800, 500, "http://news.bbc.co.uk", onHTMLBeforeNavigate,
onHTMLDocComplete, onHTMLError, onHTMLProgress)
```

```
html->"top"->"inside"->tab
```

```
html->"left"->"inside"->tab
```

```
html->"right"->"inside"->tab
```

```
html->"bottom"->"inside"->tab
```

```
realize (dlg)
show (dlg)
```

HTML Edit Control

The section describes the DXL support for the HTML edit control.

The control behaves in many ways like a rich text area for entering formatted text. It encapsulates its own formatting toolbar allowing the user to apply styles and other formatting.

htmlEdit

Declaration

```
DBE htmlEdit (DB parentDB, string label, int width, int height)
```

Operation

Creates an HTML editor control inside *parentDB*.

htmlBuffer

Declaration

```
Buffer getBuffer (DBE editControl)
```

Operation

Returns the currently rendered HTML fragment shown in the control. The fragment includes everything inside the <body> element tag.

set (HTML edit)

Declaration

```
void set (DBE editControl, Buffer HTML)
```

Operation

Sets the HTML to be rendered by the edit control. The HTML fragment should include everything inside, but not including, the <body> element tag.

Example

```
DB MyDB = create "hello"
DBE MyHtml = htmlEdit(MyDB, "HTML Editor", 400, 100)

void mycb (DB dlg){

    Buffer b = getBuffer MyHtml
    string s = stringOf b
    ack s
}

apply (MyDB, "GetHTML", mycb)
set (MyHtml, "Initial Text")
show MyDB
```

Chapter 19

DOORS window control

This chapter describes the DXL library and Addins menus. It also defines functions and standard items that control the way DOORS displays information and its windows.

- The DXL Library and Addins menus
- Module status bars
- DOORS built-in windows
- Module menus

The DXL Library and Addins menus

DXL libraries are directories stored in the DOORS file tree. They can be found at `$DOORSHOME/lib/dxl`. Each library must contain a description file for that library with the same name as the directory but with a `.hlp` extension. Only files ending in `.dxl` are recognized as library elements.

The standard directory adds functions to the DOORS formal module **Tools** menu. Each directory in `addins` appears as a new menu in formal modules. Subdirectories appear as submenus.

The order of menu items as well as their names, mnemonics and accelerators are defined in an index file with the same name as the library directory but with a `.idx` extension.

As an example, see the user-defined function `fn.dxl` included in the formal module menus:

```
dxl/addins/addins.hlp
    addins.idx
    user/user.hlp
        user.idx
        fn.dxl
```

Library description file format

Each library must contain a description file for the library with the same name as the directory but with a `.hlp` extension.

The first line of the description file is a one-line description of the library. The rest of the file can expand on this, with descriptive text providing detailed information about the library.

Example

This example is the start of file: `$DOORSHOME/dxl/addins/acme/acme.hlp`:

The ACME Spindles Inc DXL function library
 This library contains a set of functions
 developed by ACME Spindles Inc to support
 our internal use of DOORS.

Menu index file format

Each subdirectory within the `addins` directory can contain a menu index file with the same name as the directory but with a `.idx` extension. Each line of the menu index file must contain:

- DXL file or directory name, without extension
- mnemonic (character used with ALT to access menu from keyboard)
- accelerator (character used with CTRL to access menu from keyboard); an underscore means no accelerator
- menu label

A line containing only hyphens (-) (as in line 3 of the following example), inserts a separator within the menu.

Example

This example is the first four lines of file `$DOORSHOME/dxl/addins/acme/acme.idx`:

```
comps    C _ Component book
template T _ Templates
-----
parsers  I _ Input parsers
```

Menu DXL file format

Each DXL file to be included in the menu must conform to the following comment convention:

- The first line of the file contains a `//` comment with a single-line description of the program, which appears in the DXL Library window.
- This must be followed by a `/* ... */` multi-line comment which describes in more detail what the program does. This can be viewed from the DXL Library window by clicking the **Describe** button.

Example

```
File: $DOORSHOME/dxl/addins/acme/example.dxl
// A simple example program
/*
This program simply displays an ack box.
*/
ack "This is a Menu DXL example program"
```

Alternative Addins Location

Additional addins directories can also be created outside of the standard DOORS installation path. Here are steps on how to create a such a configuration on a DOORS client machine:

- Create the directory where you want to contain your addins library, which can be created on any drive, for example E:\addins. Each library must contain a description file for the library with the same name as the directory but with a .hlp extension. See above for further details.
- Create another directory for your DXL, for example E:\addins\MyDXL. Again, each directory must contain a description file for the library with the same name as the directory but with a .hlp extension. See above for further details.
- Add your DXL, making sure the comment convention used in ‘Menu DXL file format’ above is adhered to.
- Create a Registry string value for your addins:
 - This is created in the key HKEY_LOCAL_MACHINE\SOFTWARE\Telelogic\DOORS*<DOORS version number>*\Config
 - A new string value should be created in this key with ‘Value Name’ set to ‘Addins’ and ‘Value Data’ set to the path of the addins directory, for example E:\addins

Module status bars

This section defines functions for the module window status bar, in which DOORS displays information such as the username, access rights, or other information. These functions allow your DXL program to place information in the status bar.

status

Declaration

```
void status(Module m,  
            string message)
```

Operation

Displays string *message* in the left-most field of the status bar of module *m*.

Example

```
status(current Module, "Power validated")
```

menuStatus

Declaration

```
void menuStatus(Module m
                [,string message])
```

Operation

Displays string *message* in the full status bar area of module *m*, in the same way that help menu explanations are displayed.

If *message* is omitted, the status bar returns to its normal state.

Example

```
menuStatus(current Module, "Module exported in
            GREN III format")
```

updateToolBars

Declaration

```
void updateToolBars(Module m)
```

Operation

Redraws the tool bars for module *m*. May be needed when certain display modes are altered via a DXL program.

DOORS built-in windows

This section gives the syntax for functions that operate on DOORS built-in windows. The functions use an internal data type, so declarations are not stated.

See also “Scrolling functions,” on page 603.

window

Syntax

```
window m
```

Operation

Returns a handle to the window displaying module *m*, for use in the width and height functions.

Example

```
print width window current Module
```

show (window)

Syntax

```
show win
```

Operation

Shows a DOORS built-in window, if it is available.

hide

Syntax

```
hide win
```

Operation

Hides a DOORS built-in window, if it is showing.

Specific windows

Syntax

```
editor(attrRef)
```

```
print(m)
```

where:

m is a module of type Module

attrRef is in one of the following formats:

(Object o).(string attrName)

(Module m).(string attrName)

(Link l).(string attrName)

Operation

These functions return the appropriate window, for use with `show (window)` and `hide`, as follows:

`editor(attrRef)` object attribute editor

`print` print

Example

```
show editor (current Object)."Status"
```

```
show print current Module
```

Module menus

This section lists constants and gives the syntax for functions that create and manage menus. Many of the functions use internal data types, so declarations are not stated. For examples of how to build menus, look in `$DOORSHOME/lib/dx1/config`.

Standard menus and submenus

The following constants are defined as standard menus and submenus:

clipCopyMenu
clipPasteMenu
clipboardMenu
projectMenu
moduleMenu
editMenu
oleMenu
viewMenu
objectMenu
linkMenu
linksetMenu
attributeMenu
columnMenu
extractMenu
toolsMenu
usersMenu
optionsMenu
helpMenu
objCopyMenu
objCreateMenu
objMoveMenu
objUnlockMenu

Standard items

The following constants are defined as standard items:

OLECutItem
OLECopyItem
OLEPasteItem
OLEPasteSpecialItem
OLEClearItem
OLEInsertItem
OLERemoveItem
OLEVerbItem
attrDefItem
attrTypeItem
clipCutItem
clipCopyFlatItem
clipCopyHierItem
clipPasteItem
clipPasteDownItem
clipClearItem
columnCreateItem
columnEditItem
columnDeleteItem
columnLeftJustifyItem
columnRightJustifyItem
columnCenterJustifyItem
columnFullJustifyItem
columnUseInGraphicsItem
columnUseAsToolTipsItem
dispGraphicsItem
dispOutlineItem
dispFilterDescendantsItem
dispFilteringItem
dispSortingItem
dispDeletionItem
dispReqOnlyItem
dispFilterParentsItem
dispGraphicsLinksItem

dispGraphicsToolTipsItem
dispLevelAllItem
dispLevel1Item
dispLevel2Item
dispLevel3Item
dispLevel4Item
dispLevel5Item
dispLevel6Item
dispLevel7Item
dispLevel8Item
dispLevel9Item
dispLevel10Item
editDXLItem
editUsersItem
EXIT_Item
extractSetupItem
extractSameItem
extractDownItem
filterItem
helpContentsItem
helpSearchItem
helpIndexItem
helpHelpItem
helpProjManItem
helpFormalItem
helpDescriptiveItem
helpLinkItem
helpAboutItem
inplaceRejectItem
inplaceAcceptItem
inplaceHeadingItem
inplaceTextItem
inplaceAttrItem
inplaceResetAttrItem

linkCreateItem
linkEditItem
linkDeleteItem
linkSourceItem
linkTargetItem
linkMatrixItem
linkGraphicsItem
linksetCreateItem
linksetDeleteItem
linksetRefreshItem
modAccessItem
modAttrEditItem
modBaselineItem
modCloseItem
modHistoryItem
modLayoutItem
modPrintItem
modSaveItem
modDowngradeItem
modPrintPreviewItem
objAccessItem
objCompressItem
objUncompressItem
objCompressionItem
objCopyItem
objCopyDownItem
objCreateItem
objCreateDownItem
objDeleteItem
objUndeleteItem
objPurgeItem
objEditItem
objHistoryItem
objMoveItem

objMoveDownItem
objLockItem
colorOptionsItem
fontOptionsItem
optionsSaveItem
optionsRestoreItem
optionsDefaultsItem
pictureItem
createProjectItem
openProjectItem
deleteProjectItem
undeleteProjectItem
purgeProjectItem
duplicateProjectItem
closeProjectItem
projectAttrItem
unlockModulesItem
purgeModulesItem
projectArchiveItem
projectRestoreItem
createFormalModuleItem
createLinkModuleItem
createDescriptiveModuleItem
openModuleEditItem
openModuleShareItem
openModuleReadItem
deleteModuleItem
undeleteModuleItem
purgeModuleItem
duplicateModuleItem
renameModuleItem
archiveModuleItem
restoreModuleItem
showFormalModulesItem

```

showLinkModulesItem
showDescriptiveModulesItem
showDeletedModulesItem
showDeletedProjectsItem
sortNameItem
sortTypeItem
sortDescriptionItem
selectItem
deselectItem
sortItem
spellCheckItem
undoItem
redoItem
viewCreateItem
viewShowItem
viewDeleteItem

```

Standard combo box controls

The following constants are defined as standard combo box controls:

```

linksetCombo
viewCombo
helpCombo

```

createMenu

Syntax

```

createMenu(menuIdentifier
           [,string label,
            char mnemonic,
            string dxlDirectory])

createMenu(int mappingFunction(),
           string label,
           char mnemonic,
           string dxlFile)

```

Operation

Creates a standard or configurable menu or submenu, according to context. The arguments are defined as follows:

<i>menuIdentifier</i>	Provides a standard menu definition, which is particularly useful as a source of menu gray-out behavior; for a standard menu, it must take one of the values listed in “Standard menus and submenus,” on page 546.
<i>label</i>	The text of the menu item or null.
<i>mnemonic</i>	The character of the label that is to be used with ALT for keyboard access, or null.
<i>dxlDirectory</i>	Provides the name of a standard-format DXL library directory, or null.
<i>mappingFunction()</i>	<p>Callback function which returns an integer that specifies whether the menu item is available, checked, or invisible; possible values are:</p> <pre>menuAvailable_ menuAvailableChecked_ menuUnavailable_ menuInvisible_</pre> <p>Note: This functionality is not supported for menus created on the module menu bar. It is just for menus within these menu bar menus that have been created. Also, the callback function cannot be in the same file as the as the one that uses the perms that call them and they also have to be in the top context which means placing the file in \$DOORSHOME\lib\dxl\startupfiles.</p>
<i>dxlFile</i>	Full path name of the DXL file containing the menu.

For a standard menu only the *menuIdentifier* is required. For a configurable menu or submenu, *menuIdentifier* provides basic information, including predefined gray-out behavior. In this case it can also be null. If not null, *label* and *mnemonic* override the predefined appearance of the menu. If not null, the contents of *dxlDirectory* are used for the menu.

The second form takes a DXL mapping function as a callback. If not null, the contents of *dxlFile* are used for the menu.

Example

```
createMenu moduleMenu
```

createButtonBar

Declaration

```
void createButtonBar([string name, Sensitivity mappingCallback(), bool newRow,
bool showName])
```

Operation

Creates a button bar in a module or user-created dialog box. If the name is supplied the toolbar will be hosted in a container control at the top of the dialog, if not it will be generated on the canvas. The `newRow` parameter defines whether the toolbar is shown on a new row within the container control or not. The `showName` parameter defines whether the name of the toolbar is shown or not. Both `newRow` and `showName` are mandatory when the toolbar is hosted outwith a canvas.

When a user right-clicks within the container control of a dialog, a context menu will be shown to allow the user to show or hide the toolbars inside it. The mapping callback function is called for each toolbar if provided to allow the DXL to control the display of context menu items for the given toolbar. It can be set to null. The function must return one of the following Sensitivity values:

<code>ddbUnavailable</code>	The tool is unavailable.
<code>ddbAvailable</code>	The tool is active.
<code>ddbChecked</code>	The tool is active and has a check beside it.
<code>ddbInvisible</code>	The tool is not shown

createItem

Declaration

```
void createItem(standardItem
                [,string label,
                char mnemonic,
                char accelerator,
                {IconID icon_id|string iconFileName},
                string tooltip,
                string helptext,
                string inactiveHelp,
                string dxlFile])

void createItem(int mappingFunction(),
                string label,
                char mnemonic,
                char accelerator,
                int modifierKeyFlags,
                {IconID icon_id|string iconFileName},
```

```

        string tooltip,
        string helptext,
        string inactiveHelp,
        string dxlFile)

void createItem(int mappingFunction(),
               void dxlCallback(),
               string label,
               char mnemonic,
               char accelerator,
               int modifierKeyFlags,
               {IconID icon_id|string iconFileName},
               string tooltip,
               string helptext,
               string inactiveHelp)

```

Operation

Creates a DXL menu item in a module or user-created dialog box. In the first form, if the optional arguments are omitted, creates a standard item. The arguments are defined as follows:

<code>standardItem</code>	Provides a standard menu item definition, which is particularly useful as a source of menu gray-out behavior; it must have one of the values listed in “Standard items,” on page 546.
<code>label</code>	The text of the menu item.
<code>mnemonic</code>	The character of the label that is to be used with ALT for keyboard access or null.
<code>accelerator</code>	The character that is to be used with the CTRL for direct keyboard access or null. This option does not function for pop-up menus.
<code>modifierKeyFlags</code>	Used in conjunction with the <code>accelerator</code> parameter to change which key should be pressed with the accelerator key. Possible values are <code>modKeyNone</code> , <code>modKeyCtrl</code> , <code>modKeyShift</code> and <code>null</code> .
<code>icon_id</code>	The icon identifier of the standard icon, used for button bars only or null; it must have one of the values listed below.
<code>iconFileName</code>	The file to be used as an icon. Must be a valid icon format .ico file.
<code>tooltip</code>	Text to be displayed in the button-bar tooltip or null.
<code>helptext</code>	Text to appear in the status bar for the item (if active) or null.
<code>inactiveHelp</code>	Text to appear in the status bar for the item (if inactive) or null.
<code>dxlFile</code>	Complete path name of the DXL file to execute or null (usually null).

<code>mappingFunction ()</code>	Callback function which returns an integer that specifies whether the menu item is available, checked, or invisible; possible values are: <code>menuAvailable</code> <code>menuAvailableChecked</code> <code>menuUnavailable</code> <code>menuInvisible</code>
<code>dx1Callback ()</code>	Callback function which runs when the menu is selected (instead of running a DXL file).

The possible values for `IconID` constants are:

`levelAllIcon`
`level1Icon`
`level2Icon`
`level3Icon`
`level4Icon`
`level5Icon`
`level6Icon`
`level7Icon`
`level8Icon`
`level9Icon`
`level10Icon`
`dispGraphicsIcon`
`dispOutlineIcon`
`dispFilterIcon`
`dispSortIcon`
`createObjSameIcon`
`createObjDownIcon`
`deleteObjIcon`
`columnInsertIcon`
`columnEditIcon`
`columnRemoveIcon`
`justifyLeftIcon`
`justifyRightIcon`
`justifyCenterIcon`

justifyFullIcon
folderOpenIcon
folderNewIcon
folderCloseIcon
projOpenIcon
projNewIcon
projCloseIcon
editUsersIcon
createModIcon
editModIcon
shareModIcon
readModIcon
copyModIcon
deleteModIcon
createLinkIcon
editLinkIcon
deleteLinkIcon
matrixModeIcon
startLinkIcon
endLinkIcon
createLinksetIcon
createFormalModIcon
createLinkModIcon
deleteLinksetIcon
editHeadingIcon
editTextIcon
extractObjIcon
extractOneDownIcon
showMarkedObjsIcon
spellcheckIcon
undeleteModIcon
increaseLevelIcon
decreaseLevelIcon
noIcon

```

yesIcon
wordIcon
projWizIcon
viewWizIcon
layWizIcon
repWizIcon
repManIcon
tableCreateIcon
tableInsertRowIcon
tableInsertColIcon
tableSetBordersIcon
textBold
textItalic
textUnderline
textStrikeThrough
saveIcon
printIcon
propertiesIcon
copyIcon
cutIcon
pasteIcon
deleteIcon

```

Example

```

createItem(linkCreateItem, "Create link", 'C',
           null, null, null, null, null, null)

```

createCombo

Syntax

```

createCombo({linksetCombo|viewCombo})

```

Operation

Creates a standard combo box in a tool bar in a module or user-created dialog box.

Example

```

createButtonBar

```

```
separator  
createCombo viewCombo  
separator  
end buttonbar
```

createPopup

Declaration

```
void createPopup()
```

Operation

Creates a popup menu in a module or user-created dialog box.

separator (menu)

Declaration

```
void separator()
```

Operation

Adds a menu separator.

end (menu, button bar, popup)

Syntax

```
end({menu|buttonbar|popup})
```

Operation

Ends a menu, button bar or popup section.

Example

```
end menu  
end buttonbar  
end popup
```

Chapter 20

Display control

This chapter describes DXL functions that control what information is displayed in DOORS module windows.

- Filters
- Filtering on multi-valued attributes
- Sorting modules
- Views
- View access controls
- View definitions
- Columns
- Scrolling functions
- Layout DXL

Filters

This section defines operators and functions for building display filters.

The data type `Filter` allows the construction of complex filters which can then be applied with the `set` command. The data type `LinkFilter` can take one of the following values:

```
linkFilterIncoming
```

```
linkFilterOutgoing
```

```
linkFilterBoth
```

These allow the construction of filters with reference to incoming links, outgoing links, or both. They are used with the `hasLinks` and `hasNoLinks` functions.

The DXL functions for filtering mimic the capability provided by the DOORS GUI, except for `accept` and `reject`, which allow a DXL program to set an arbitrary filter.

attribute (value)

This function is used to generate a filter attribute handle, as shown in the following syntax:

```
attribute(string attrName)
```

The returned handle for the attribute named `attrName` is used by other functions.

Example

This example filters on all objects in the current module that have a "Priority" attribute value of "Mandatory".

```
set(attribute "Priority" == "Mandatory")
```

column (value)

Syntax

```
Filter column(string ColumnName,
              string SearchText
              [, bool CaseSensitive,
              bool RegularExpression])
```

Operation

Filters on the contents of *ColumnName*. The last two parameters are optional.

Attribute comparison

Operators can be used to compare filter attribute handles and text strings.

Syntax

The syntax for using these operators is as follows:

```
attribute(string attr) operator string text
```

where:

<i>attr</i>	is the name of the attribute
<i>operator</i>	is one of == != < <= > >=
<i>text</i>	is a string

Operation

Compares the filter attribute handle returned by the call to `attribute` with the string *text*. If *text* is a variable of another type, you can convert it to a string by concatenating it with the empty string.

Example

This example filters on only those objects in the current module that have attribute "Cost" values greater than 4:

```
set(attribute "Cost" > "4")
// using wrong type
real cost = 4.0
set(attribute "Cost" > cost "")
```

Compound filters

Compound filters can be constructed.

Syntax

```
Filter compound = Filter 1 operator Filter 2
                    [operator Filter 3]...
```

where:

<i>compound</i>	is a variable		
<i>operator</i>	is one of:	&&	meaning AND
			meaning OR
		!	meaning NOT
<i>1 2 3</i>	are strings		

Operation

Combines filters to create a complex filter.

Example

This example filters on those objects that contain the words `shall` or `must`, regardless of case.

```
Filter required = contents("shall", false) || contents("must", false)
```

accept

Declaration

```
void accept(Object o)
```

Operation

Marks object `o` as accepted under the current filter. Allows a DXL program to set an arbitrary filter on the current module. Compare with the `reject` function.

addFilter

Declaration

```
void addFilter([Module m,]
               Filter f
               int &accepted,
               int &rejected)
```

Operation

Adds a filter in the current module, or to module *m* where it is specified. The third and fourth parameters pass back the number of objects accepted and rejected respectively under the filter.

contents

Declaration

```
Filter contents(string text[, bool caseSensitive[, bool useRegExp]])
```

Operation

Filters on objects that include the string *text* in any string or text attributes. If *caseSensitive* is set to `true`, the filter takes character case into account when searching. If *caseSensitive* is `false`, the filter ignores case. If *caseSensitive* is omitted, the filter accepts regular expressions.

The optional `useRegExp` parameter allows the use of regular expressions to be specified independently of case sensitivity.

Example

This example matches objects that contain literally `f.*h`, but not `F.*H`, `f.*H`, or `F.*H`.

```
Filter f = contents("f.*h", true)
```

This example matches objects that contain the regular expression `f.*h`, for example, `fish` or `fourteenth`.

```
Filter f = contents "f.*h"
```

contains

Declaration

```
Filter contains(attribute(string attributeName), string text, [bool caseSensitive[, bool useRegExp]])
```

Operation

Filters on objects that include the string *text* in a specific attribute *attributeName*. If *caseSensitive* is set to `true`, the filter takes character case into account when searching. If *caseSensitive* is `false`, the filter ignores case. If *caseSensitive* is omitted, the filter accepts regular expressions.

The optional `useRegExp` parameter allows the use of regular expressions to be specified independently of case sensitivity.

Example

```
Module m = current
```

```
Filter f = contains(attribute "Object Text", "shall", false)
```

```
set f
```

```
filtering on
```

excludeCurrent

Declaration

```
Filter excludeCurrent()
```

Operation

Excludes the current object from the filter.

excludeLeaves

Declaration

```
Filter excludeLeaves()
```

Operation

Excludes leaves from the filter.

filterTables

Declaration

```
void filterTables(bool onOff)
```

```
bool filterTables(Module m)
```

Operation

The first form sets whether tables are filtered in the current module.

The second form returns whether table contents are being filtered in the specified module *m*.

includeCurrent

Declaration

```
Filter includeCurrent()
```

Operation

Includes the current object in the filter.

includeLeaves

Declaration

```
Filter includeLeaves()
```

Operation

Includes leaves in the filter.

hasLinks

Declaration

```
Filter hasLinks(LinkFilter value,
               string linkModName)
```

Operation

Includes in the filter objects that have links through link module *linkModName*. The string can also take the special value `"*"`, which means any link module. The *value* argument defines the type of links; it can be one of `linkFilterIncoming`, `linkFilterOutgoing`, or `linkFilterBoth`.

Example

This example filters on objects that have incoming links through any link module:

```
Module m = current
Filter f = hasLinks(linkFilterIncoming, "*")
set(m, f)
filtering on
```

hasNoLinks

Declaration

```
Filter hasNoLinks(LinkFilter value,
                 string modName)
```

Operation

Includes in the filter objects that have no links through link module *linkModName*. The string can also take the special value `"*"`, which means any link module. The *value* argument defines the type of links; it can be one of `linkFilterIncoming`, `linkFilterOutgoing`, or `linkFilterBoth`.

Example

This example filters on objects that have neither incoming nor outgoing links through the link module `Project Links`:

```
Module m = current
Filter f = hasNoLinks(linkFilterBoth,
                    "Project Links")
set(m, f)
filtering on
```

isNull

Declaration

```
Filter isNull (attribute (string attrName))
```

Operation

Returns `true` if the call to `attribute` returns `null`.

Returns `false` if the call to `attribute` returns an attribute other than `null`.

notNull

Declaration

```
Filter notNull (attribute (string attrName))
```

Operation

Returns `true` if the call to `attribute` returns an attribute other than `null`.

Returns `false` if the call to `attribute` returns `null`.

reject

Declaration

```
void reject (Object o)
```

Operation

Marks object `o` as rejected under the current filter. Allows a DXL program to set an arbitrary filter on the current module. Compare with the `accept` function.

Example

```
Object o
filtering off
// following loop only accesses displayed objects
// cycle through all displayed objects
for o in current Module do {
    bool accepted = false
    Link l
    for l in o->"*" do {
        // accept o if any out going links
        accept o
    }
}
```

```

        accepted = true
        break
    }
    if (!accepted)
    {
        reject o // no outgoing links, reject o
    }
}
filtering on // activate our new filter

```

set (filter)

Declaration

```

void set(Module m,
         Filter f
         [,int &accepted,
          int &rejected])

```

Operation

Applies the filter in the current module, or to module *m* where it is specified. The third and fourth parameters return the number of objects accepted and rejected respectively under the filter.

stringOf (filter)

Declaration

```

string stringOf(Module m,
                Filter f)

```

Operation

Returns a string representation of filter *f* in module *m*.

ancestors (show/hide)

Declaration

```

void ancestors(bool show)

```

Operation

Shows filtered object ancestors if *show* evaluates to `true`. Hides filtered object ancestors if *show* evaluates to `false`.

ancestors (state)

Declaration

```
bool ancestors (Module myModule)
```

Operation

Returns `true` if filtered object ancestors are showing in the specified module. Returns `false` if filtered object ancestors are not showing in the specified module.

applyFiltering

Declaration

```
void applyFiltering (Module)
```

Operation

Sets the module explorer display to reflect the current filter applied to the specified module.

unApplyFiltering

Declaration

```
void unApplyFiltering (Module)
```

Operation

Switches off filtering in the module explorer for the specified module.

applyingFiltering

Declaration

```
bool applyingFiltering (Module)
```

Operation

Returns a boolean indicating whether filtering is turned on in the module explorer for the specified module.

Filters example program

```
// filter DXL example
/*
```

```

example program building DXL filters
can be used in Car Project "Car user reqts"
module.
*/
// "show" sets the passed filter, refreshes
// the screen and waits for the next filter.
//
void show(Filter f, bool last, string what) {
    set f
    refresh current
    if (!last) what = what "\n\nready for next
                        filter?"
    ack what
}
load view "Collect reqts"      // if present
filtering on
// declare a filter
Filter f1 = attribute "Acceptability" ==
            "Acceptable"
// display it
show(f1, false, "Acceptability == Acceptable")
// a compound filter
Filter f2 = f1 && attribute "Priority" !=
            "luxury"
show(f2, false, "previous filter && Priority !=
                luxury")
Filter f3 = excludeLeaves
show(f3, true, "exclude Leaves")
filtering off

```

Filtering on multi-valued attributes

This section defines the functions that can be used to filter on multi-valued attributes.

includes

Declaration

```
Filter includes(attribute(string attrName),
               string s)
```

Operation

Returns the definition of a simple filter on a multi-valued attribute named *attr*, where *s* contains the filtering value.

If the attribute contains *s*, it is included in the filter set. The string *s* can only contain one value.

Example

This example filter set includes all objects with multi-valued attributes, one value of which is "ABC":

```
Filter f1 = includes(attribute "attribute name",
                    "ABC")

set f1
filtering on
```

excludes

Declaration

```
Filter excludes(attribute(string attrName),
                string s)
```

Operation

Returns the definition of a simple filter on a multi-valued attribute, where *s* contains the filtering value.

If the attribute contains *s*, it is excluded from the filter set. The string *s* can only contain one value.

Example

This example filter set excludes all objects with multi-valued attributes, one value of which is "ABC":

```
Filter f2 = excludes(attribute "attribute name", "ABC")

set f2
filtering on
```

Sorting modules

This section defines the operators and functions that allow you to sort a formal module in a similar way to the DOORS GUI. These language elements use the data type `Sort`.

ascending

Declaration

```
Sort ascending(string attrName)
```

Operation

Returns a type *Sort*, which sorts the current display with respect to the values of the object attribute named *attrName*, in ascending order.

DOORS always refreshes the current module at the end of a script's execution. If a sorted display is to be viewed before that time, you must call `refresh current Module`.

Example

```
set ascending "Absolute Number"  
sorting on
```

descending

Declaration

```
Sort descending(string attrName)
```

Operation

Returns a type *Sort*, which sorts the current display with respect to the values of the object attribute named *attrName*, in descending order.

DOORS always refreshes the current module at the end of a script's execution. If a sorted display is to be viewed before that time, you must call `refresh current Module`.

Example

```
set descending "Absolute Number"  
sorting on
```

Compound sort

Compound sort rules can be constructed, as shown in the following syntax:

Syntax

```
Sort compound = Sort 1 && Sort 2
```

where:

compound is a variable

&& means AND

1 2 are strings

Operation

Combine a first sort with a second sort which discriminates between the objects that share the same value in the first sort.

Example

This example sorts by the user who created the object and then by the most recently created objects:

```
Sort compound = ascending "Created By" &&
                descending "Absolute Number"

set compound
sorting on
```

set (sort)

Declaration

```
void set([Module m,]
         Sort s)
```

Operation

Applies the sort rule *s* in the module specified by *m* or, if *m* is omitted, in the current module. The command `sorting` can be used to display sorted output in the current module.

sorting

Declaration

```
void sorting(bool onOff)
```

Operation

Displays sorted output in the current module.

Example

```
set descending "Absolute Number"
sorting on
```

stringOf (sort)

Declaration

```
string stringOf(Sort s)
```

Operation

Returns a string representation of sort s in the current module.

isAscending

Declaration

```
bool isAscending(Column c)
```

Operation

Determines whether a column c is sorted in ascending order. If the column is not sorted then `false` is returned.

isDescending

Declaration

```
bool isDescending(Column c)
```

Operation

Determines whether a column c is sorted in descending order. If the column is not sorted then `false` is returned.

for sort in sort

Declaration

```
for s in sr do {
  ...
}
```

where

s is a variable of type `Sort`

sr is a variable of type `Sort`

Operation

Assigns s to be each successive sort in a given compound sort sr .

Example

This example prints all sorting information for the currently defined sort in the current module. Must be run from an open module.

```
Sort sr = current
```

```
Sort s
```

```
for s in sr do {
```



```
print stringOf s"\n"
}
```

destroySort

Declaration

```
void destroySort (Module m)
```

Operation

This perm removes any sort criteria stored with the specified module *m*

Sorting example program

```
// sort DXL example
/*
  example program building DXL sorts
*/
Sort s1 = ascending "Absolute Number"
Sort s2 = descending "Absolute Number"
sorting on
refresh current
set s1
ack "hello"
set s2
refresh current
ack "hello"
set s1
refresh current
ack "hello"
set s2
refresh current
```

Views

This section defines functions and a for loop for building and manipulating DOORS views. Some of these elements use the View data type, which is a handle created for use by other functions.

If a view is to be created you must make sure that the module is in display mode.

The standard view is displayed by default. It cannot be altered or deleted, but can be loaded.

currentView

Declaration

```
string currentView(Module m)
```

Operation

Returns the name of the view that is currently selected for the given module.

descendants (show/hide)

Declaration

```
void descendants(bool expression)
```

Operation

Shows descendants in the module window if *expression* is `true`. Hides descendants if *expression* is `false`.

descendants (state)

Declaration

```
bool descendants(Module m)
```

Operation

Returns `true` if the current *view* in module *m* is set to show descendants; otherwise returns `false`.

view

Declaration

```
View view([Item item,]
          string viewName)
```

Operation

Returns a handle to a specific view in *item*, or if *item* is omitted, the current module. The *item* argument must have the value `Formal` or `Descriptive` (a formal or descriptive module). If *item* is any other value, the function returns `null`.

The view need not exist; if it does not, a new view is created but not saved until the `save (view)` function is called.

delete (view)

Declaration

```
string delete([Module m,] View v)
```

Operation

Deletes the view having handle *v* from module *m*, or if *m* is omitted, from the current module. The returned string is non-NULL on error, else NULL.

Example

```
View v = view("Basic view")
string s = delete(v)
```

setPreloadedView

Declaration

```
bool setPreloadedView(ViewDef view, string name)
```

Operation

Sets the preloaded view name for the specified ViewDef *view*. Returns `true` on success, and `false` on failure. Will fail and generate a run-time DXL error if there is no current module. Will also fail if the specified *name* does not designate a view in the current module to which the current user has Read access.

Note that this perm does not check the relative access controls on the inheriting and inherited views, because the ViewDef *view* does not include access controls. These checks are made if and when the ViewDef settings are saved using the `change` or `save perm`.

preloadedView

Declaration

```
string preloadedView(ViewDef view)
```

Operation

Returns the preloaded view name for the specified ViewDef *view*. Returns a null (empty) string if no preloaded view is specified for this ViewDef *view*, or if the current user does not have read access to the inherited view. Generates a run-time DXL error and returns an empty string if there is no current module.

isinheritedView

Declaration

```
bool isInheritedView(string viewName)
```

Operation

This returns `true` if any view in the current module is configured to inherit settings from a view whose name matches the supplied string `viewName`, and to which the current user has read access. The user does not need to have read access to the inheriting view for this perm to return `true`. It generates a run-time DXL error and returns `false` if there is no current module.

isValidName

See “`isValidName`,” on page 219.

linkIndicators (show/hide)

Declaration

```
void linkIndicators(bool show)
```

Operation

Shows the link indicators in the current module if `show` evaluates to `true`. Hides the link indicators in the current module if `show` evaluates to `false`.

linkIndicators (state)

Declaration

```
bool linkIndicators(Module myModule)
```

Operation

Returns `true` if link indicators are showing in the specified module. Returns `false` if link indicators are not showing in the specified module.

load

Declaration

```
bool load([Module m, ]
          View v)
```

Operation

Attempts to load the view handle `v` in module `m`, or if `m` is omitted, in the current module. Supports loading the standard view. If the function fails, it returns `false`.

Example

```
load view "cost analysis"
load view "Standard view"
```

name (view)

Declaration

```
string name (View view)
```

Operation

Returns the name of *view*.

next, previous (filtered)

Declaration

```
Object next (Object o,  
            Filter filter)
```

```
Object previous (Object o,  
               Filter filter)
```

Operation

These functions return the next or previous object at the current level of hierarchy that matches *filter*.

clearDefaultViewForModule

Declaration

```
string clearDefaultViewForModule (Module m)
```

Operation

Clears the default view setting for the specified module. Returns a null string if the operation succeeds; otherwise, returns an error message.

clearDefaultViewForUser

Declaration

```
string clearDefaultViewForUser (Module m)
```

Operation

Clears the default view setting, for the current user, for the specified module. Returns a null string if the operation succeeds; otherwise, returns an error message.

getDefaultViewForModule

Declaration

```
string getDefaultViewForModule (Module m)
```

Operation

Returns the name of the default view for the specified module. If no default is specified, returns null.

getDefaultViewForUser

Declaration

```
string getDefaultViewForUser (Module m)
```

Operation

Returns the name of the default view for the current user, for the specified module. If no default is specified for the current user, returns null.

save (view)

Declaration

```
void save (View v)
```

Operation

Saves the view having handle *v* in the current module.

setDefaultViewForModule

Declaration

```
string setDefaultViewForModule (Module m,  
                                string viewName)
```

Operation

Sets the default view for the specified module to *viewName*. Returns a null string if the operation succeeds; otherwise, returns an error message.

setDefaultViewForUser

Declaration

```
string setDefaultViewForUser (Module m,  
                             string viewName)
```

Operation

Sets the default view, for the current user, for the specified module, to *viewName*. Returns a null string if the operation succeeds; otherwise, returns an error message.

showDeletedObjects (get)

Declaration

```
bool showDeletedObjects (void)
```

Operation

Returns `true` if the current view in the current module is set to show deleted objects; otherwise returns `false`.

showDeletedObjects (show/hide)

Declaration

```
void showDeletedObjects (bool show)
```

Operation

Shows deleted objects in the module window if *show* is `true`. Hides deleted objects if *show* is `false`.

showChangeBars (get)

Declaration

```
bool showChangeBars (Module module)
```

Operation

Returns `true` if the specified module shows object change bars. Otherwise, returns `false`.

showChangeBars (show/hide)

Declaration

```
void showChangeBars (bool show)
```

Operation

Sets the option for showing object change bars in the current module.

showGraphicsDatatips (get)

Declaration

```
bool showGraphicsDatatips (Module module)
```

Operation

Returns `true` if the specified module shows datatips in Graphics Mode. Otherwise, returns `false`.

showGraphicsDatatips (show/hide)

Declaration

```
void showGraphicsDatatips (bool show)
```

Operation

Sets the option for showing datatips in Graphics Mode in the current module.

showGraphicsLinks (get)

Declaration

```
bool showGraphicsLinks (Module module)
```

Operation

Returns `true` if the specified module shows links in Graphics Mode. Otherwise, returns `false`.

showGraphicsLinks (show/hide)

Declaration

```
void showGraphicsLinks (bool show)
```

Operation

Sets the option for showing links in Graphics Mode in the current module.

showingExplorer

Declaration

```
bool showingExplorer (Module module)
```

Operation

Returns `true` if the specified module is showing the Module Explorer. Otherwise, returns `false`.

showExplorer, hideExplorer

Declaration

```
void showExplorer (Module module)
```

```
void hideExplorer (Module module)
```

Operation

Sets the specified module to show or hide the Module Explorer.

showPrintDialogs (get)

Declaration

```
bool showPrintDialogs ()
```

Operation

Gets the current setting for displaying print dialog boxes.

Printing from the DOORS user interface, rather than from DXL, automatically sets `showPrintDialogs` back to `true`.

showPrintDialogs (set)

Declaration

```
void showPrintDialogs (bool onOff)
```

Operation

Sets whether print dialog boxes should be displayed when printing from DXL. This includes the printer selection dialog box, the warnings issued when printing in graphics view, or in a view that spans more than one page.

When `showPrintDialogs` is turned off, the printer selection dialog box is not displayed, so the default Windows printer, or the printer referred to in the appropriate environment variable on UNIX, is used for all printed output.

for view in module

Syntax

```
for s in views (Module m) do {
  ...
}
```

where:

s is a string variable
m is a module of type `Module`

Operation

Assigns the string *s* to be each successive view name in the module *m*.

Example

This example prints all views in the current module:

```
string name
for name in views current Module do
    print name "\n"
```

canInheritView

Declaration

```
string canInheritView(View v1, View v2, bool &b)
string canInheritView(ViewDef vd1, View v2, bool &b)
```

Operation

The first form returns true if view *v1* can inherit settings from view *v2* in the current module according to access control restrictions. The restrictions are that every user who has read access to *v1* must also have read access to *v2*.

The second form determines whether or not a `ViewDef` can inherit settings from a `View`.

In both cases an error is returned on failure, or null on success.

Note that the test does not take into account group membership, so a user who is given specific access to *v1* or *vd1* and who is granted access to *v2* by virtue of group membership will not qualify *v2* as inheritable.

clearInvalidInheritanceOf

Declaration

```
bool clearInvalidInheritanceOf(string viewname[, ViewDef vd])
```

Operation

This clears the `preloadView` setting of any views which currently inherit settings from the named view in the current module if that inheritance is invalid according to the access rights constraints as reflected by the `canInheritView` perm. It returns true on success and false on failure, and generates a run-time DXL error if there is no current module or if the views index file cannot be locked.

If the `defn` argument is specified, then the validity test is applied as if the named view had the access controls in the `defn` argument.

invalidInheritedView

Declaration

```
bool invalidInheritedView(string viewname[, ViewDef vd])
```

Operation

This returns true if any view in the current module is configured to inherit settings from a view of the specified name to which the current user has read access, and the access control restrictions applied by *canInheritView* prohibit the inheritance relationship. The user does not have to have read access to the inheriting view. If a *ViewDef* is specified, then the restrictions are those which would apply if the view had the access rights contained within it.

setViewDescription

Declaration

```
void setViewDescription (ViewDef vd, string desc)
```

Operation

Sets the description for a view where *vd* is the view definition handle.

getViewDescription

Declaration

```
string getViewDescription (ViewDef vd)
```

Operation

Returns the description for a view where *vd* is the view definition handle.

for View in View

Syntax

```
for View1 in View2 do {
...
}
where:
```

<i>View1</i>	is a variable of type <i>View</i>
--------------	-----------------------------------

<i>View2</i>	is a variable of type <i>View</i>
--------------	-----------------------------------

Operation

Assigns *View1* to be each successive View whose settings can be inherited by the specified *View2* according to the same access control restrictions applied by the *canInheritView* perm.

View access controls

canCreate (view)

Declaration

```
bool canCreate (ModName_ modRef, View v)
```

Operation

Returns `true` if the current DOORS user has create access to view *v*, which can be specified as in the module *modRef*. Otherwise, returns `false`.

canControl (view)

Declaration

```
bool canControl (ModName_ modRef, View v)
```

Operation

Returns `true` if the current DOORS user can change the access controls on view *v*, which is specified as module *modRef*. Otherwise, returns `false`.

canRead (view)

Declaration

```
bool canRead (ModName_ modRef, View v)
```

Operation

Returns `true` if the current DOORS user can read view *v*, which is specified as the module *modRef*. Otherwise, returns `false`.

canModify (view)

Declaration

```
bool canModify (ModName_ modRef, View v)
```

Operation

Returns `true` if the current DOORS user can modify view `v`, which is specified as module `modRef`. Otherwise, returns `false`.

canDelete (view)

Declaration

```
bool canDelete(ModName_ modRef, View v)
```

Operation

Returns `true` if the current DOORS user can delete view `v`, which is specified as module `modRef`. Otherwise, returns `false`.

canWrite (view)

Declaration

```
bool canWrite(ModName_ modRef, View v)
```

Operation

Returns `true` if the current DOORS user can write view `v`, which is specified as the module `modRef`. Otherwise, returns `false`.

Views example program

```
// view DXL example
/* construct a new view containing a selection of
   attributes. Save as the view "View DXL
   example".
*/
string viewName = "View DXL example"
DBE attrList
// contains selection of attributes to display
void buildFn(DBE dbe) {
// construct view of attributes chosen
    string attr
    Column c
    int n = 0        // number of existing columns
    int i           // column index
    for c in current Module do n++
    // count the columns
```

```

for i in 1:n do
    delete(column 0)
    // delete n column 0s
i=0
for attr in attrList do {
    insert(column i)
    attribute(column i, attr)
    width(column i, 100)
    justify(column i, center)
    i++
}
// important! (last column does not appear
// otherwise)
refresh current
save view viewName
}
// Main program
// first look to see if we have an old view to
// display
if (load view viewName)
    ack "loaded the last constructed view for
        this example program"
else
    ack "first run of view dxl example"
DB viewDB = create "Create View"
string empty[] = {}
attrList = multiList(viewDB, "Attributes:", 5,
    empty)
button(viewDB, "Build View", buildFn)
realize viewDB
// populate attrList
string attr
for attr in current Module do
    insert(attrList, 0, attr)
show viewDB

```

View definitions

This section defines functions that use the `ViewDef` data type, which holds all the settings from the Advanced tab of the Views dialog box, such as compression and outlining.

create (view definition)

Declaration

```
ViewDef create([Module m,
               bool allSettings])
```

Operation

Creates a view definition in the module *m*, or if no arguments are supplied, in the current module. The *allSettings* argument specifies whether by default all of the view settings are saved.

createPrivate

Declaration

```
ViewDef createPrivate([Module m, bool allSettings])
```

Operation

This new perm creates a new private module view. It saves the view with non-inherited access, giving the current user full access and everyone else no access.

createPublic

Declaration

```
ViewDef createPublic([Module m, bool allSettings])
```

Operation

This new perm creates a new public module view. It saves the view with non-inherited access, giving the current user full access and everyone else Read access.

get (view definition)

Declaration

```
ViewDef get([Module m,]
            View v)
```

Operation

Returns the underlying view definition in *v* for the specified module, or if *m* is omitted, for the current module.

change (view definition)

Declaration

```
ViewDef change(View v,
               ViewDef viewDef
               [,string viewName])
```

Operation

Changes the underlying view definition in *v*. Optionally, changes the name of the view.

delete (view definition)

Declaration

```
void delete(ViewDef viewDef)
```

Operation

Deletes the view definition *viewDef* from the current module. The returned string is non-NULL on error, else NULL.

Example

```
View v = view("Basic View")
ViewDef vdef = get(v)
string s = delete(current Module, v)
```

save (view definition)

Declaration

```
void save([Module m,]
          View v,
          ViewDef viewDef)
```

Operation

Saves the view definition *viewDef* into view *v* in module *m*, or if *m* is omitted, in the current module.

useAncestors (get and set)

Declaration

```
bool useAncestors(ViewDef viewDef)
```



```
void useAncestors(ViewDef viewDef,
                 bool save)
```

Operation

The first form returns `true` if the option to save the advanced filter option for showing ancestors is currently set. Otherwise, returns `false`.

The second form sets the option to save the advanced filter option for showing ancestors.

If the option for showing ancestors is set, a filtered view contains objects that match the given filter and that object's parent hierarchy too.

useDescendants (get and set)

Declaration

```
bool useDescendants(ViewDef viewDef)
void useDescendants(ViewDef viewDef,
                 bool save)
```

Operation

The first form returns `true` if the option to save the advanced filter option for showing descendants is currently set. Otherwise, returns `false`.

The second form sets the option to save the advanced filter option for showing descendants.

If the option to show descendants is set, a filtered view contains objects that match the given filter and that object's child hierarchy too.

useCurrent (get and set)

Declaration

```
bool useCurrent(ViewDef viewDef)
void useCurrent(ViewDef viewDef,
                 bool save)
```

Operation

The first form returns `true` if the option to save information about the currently selected object is currently set. Otherwise, returns `false`.

The second form sets the option to save information about the currently selected object.

useSelection (get and set)

Declaration

```
bool useSelection(ViewDef viewDef)
```

```
void useSelection(ViewDef viewDef,
                 bool save)
```

Operation

The first form returns `true` if the option to save information about currently selected objects is currently set. Otherwise, returns `false`.

The second form sets the option to save information about currently selected objects.

useColumns (get and set)

Declaration

```
bool useColumns(ViewDef viewDef)
void useColumns(ViewDef viewDef,
                 bool save)
```

Operation

The first form returns `true` if the option to save column information is currently set. Otherwise, returns `false`.

The second form sets the option to save column information.

useFilterTables (get and set)

Declaration

```
bool useFilterTables(ViewDef viewDef)
void useFilterTables(ViewDef viewDef,
                     bool save)
```

Operation

The first form returns `true` if the option to save the advanced filter option for hiding non-matching table cells is currently set. Otherwise, returns `false`.

The second form sets the option to save the advanced filter option for hiding non-matching table cells.

useGraphicsColumn (get and set)

Declaration

```
bool useGraphicsColumn(ViewDef viewDef)
void useGraphicsColumn(ViewDef viewDef,
                       bool save)
```

Operation

The first form returns `true` if the option to save information about which column's values are displayed in the object boxes when in Graphics Mode is currently set. Otherwise, returns `false`.

The second form sets the option to save information about which column's values are displayed in the object boxes when in Graphics Mode.

useShowExplorer (get and set)

Declaration

```
bool useShowExplorer (ViewDef viewDef)
void useShowExplorer (ViewDef viewDef,
                      bool save)
```

Operation

The first form returns `true` if the option to save the **Module Explorer** setting (shown on the **View** menu) is currently set. Otherwise, returns `false`.

The second form sets the option to save the **Module Explorer** setting.

useGraphics (get and set)

Declaration

```
bool useGraphics (ViewDef viewDef)
void useGraphics (ViewDef viewDef,
                  bool save)
```

Operation

The first form returns `true` if the option to save the **Graphics Mode** setting (shown on the **View** menu) is currently set. Otherwise, returns `false`.

The second form sets the option to save the **Graphics Mode** setting.

useOutlining (get and set)

Declaration

```
bool useOutlining (ViewDef viewDef)
void useOutlining (ViewDef viewDef,
                  bool save)
```

Operation

The first form returns `true` if the option to save the **Outline** setting (shown on the **View** menu) is currently set. Otherwise, returns `false`.

The second form sets the option to save the **Outline** setting.

useCompression (get and set)

Declaration

```
bool useCompression(ViewDef viewDef)
void useCompression(ViewDef viewDef,
                    bool save)
```

Operation

The first form returns `true` if the option to save the **Compress** setting (shown on the **View** menu) is currently set. Otherwise, returns `false`.

The second form sets the option to save the **Compress** setting.

useLevel (get and set)

Declaration

```
bool useLevel(ViewDef viewDef)
void useLevel(ViewDef viewDef,
              bool save)
```

Operation

The first form returns `true` if the option to save the **Level** setting (shown on the **View** menu) is currently set. Otherwise, returns `false`.

The second form sets the option to save the **Level** setting.

useSorting (get and set)

Declaration

```
bool useSorting(ViewDef viewDef)
void useSorting(ViewDef viewDef,
                bool save)
```

Operation

The first form returns `true` if the option to save the **Sort** setting (shown on the **View > Show** menu) is currently set. Otherwise, returns `false`.

The second form sets the option to save the **Sort** setting.

useFiltering (get and set)

Declaration

```
bool useFiltering(ViewDef viewDef)
void useFiltering(ViewDef viewDef,
                  bool save)
```

Operation

The first form returns `true` if the option to save the **Filter** setting (shown on the **View > Show** menu) is currently set. Otherwise, returns `false`.

The second form sets the option to save the **Filter** setting.

useShowDeleted (get and set)

Declaration

```
bool useShowDeleted(ViewDef viewDef)
void useShowDeleted(ViewDef viewDef,
                    bool save)
```

Operation

The first form returns `true` if the option to save the **Deletions** setting (shown on the **View > Show** menu) is currently set. Otherwise, returns `false`.

The second form sets the option to save the **Deletions** setting.

useShowPictures (get and set)

Declaration

```
bool useShowPictures(ViewDef viewDef)
void useShowPictures(ViewDef viewDef,
                    bool save)
```

Operation

The first form returns `true` if the option to save the **Pictures** setting (shown on the **View > Show** menu) is currently set. Otherwise, returns `false`.

The second form sets the option to save the **Pictures** setting.

useShowTables (get and set)

Declaration

```
bool useShowTables (ViewDef viewDef)
void useShowTables (ViewDef viewDef,
                    bool save)
```

Operation

The first form returns `true` if the option to save the **Table Cells** setting (shown on the **View > Show** menu) is currently set. Otherwise, returns **false**.

The second form sets the option to save the **Table Cells** setting.

useShowLinkIndicators (get and set)

Declaration

```
bool useShowLinkIndicators (ViewDef viewDef)
void useShowLinkIndicators (ViewDef viewDef,
                            bool save)
```

Operation

The first form returns `true` if the option to save the **Link Arrows** setting (shown on the **View > Show** menu) is currently set. Otherwise, returns `false`.

The second form sets the option to save the **Link Arrows** setting.

useShowLinks (get and set)

Declaration

```
bool useShowLinks (ViewDef viewDef)
void useShowLinks (ViewDef viewDef,
                  bool save)
```

Operation

The first form returns `true` if the option to save the **Graphics Links** setting (shown on the **View > Show** menu) is currently set. Otherwise, returns `false`.

The second form sets the option to save the **Graphics Links** setting.

useTooltipColumn (get and set)

Declaration

```
bool useTooltipColumn(ViewDef viewDef)
void useTooltipColumn(ViewDef viewDef,
                      bool save)
```

Operation

The first form returns `true` if the option to save the **Graphics Datatips** setting (shown on the **View > Show** menu) is currently set. Otherwise, returns `false`.

The second form sets the option to save the **Graphics Datatips** setting.

useWindows (get and set)

Declaration

```
bool useWindows(ViewDef viewDef)
void useWindows(ViewDef viewDef,
                bool save)
```

Operation

The first form returns `true` if the option to save the current window size and position is currently set. Otherwise, returns `false`.

The second form sets the option to save the current window size and position.

If a view is saved in batch mode with the option to save the current window size and position set to `true`, the view will be saved with a module window which is not visible.

useAutoIndentation

Declaration

```
void useAutoIndentation(ViewDef vDef, Bool)
bool useAutoIndentation(ViewDef vDef)
```

Operation

The first form sets the auto-indentation status of the supplied `ViewDef` (this equates to the setting of the “Indentation of main column” check box on the advanced tab of the “Manage Views” dialog).

The second form returns the auto-indentation status of the supplied `ViewDef`.

Example

```
ViewDef viewInfo = get(view "viewName")
```

```
print useAutoIndentation (viewInfo)
```

Columns

This section defines functions and a `for` loop for building and manipulating DOORS columns. These elements use the data types `Column` and `Justification`.

Note: The data type `Justification` is used for constants specifying text alignment.

column

Declaration

```
Column column([Module m, ]
              int n)
```

Operation

Returns a handle on the n th column, starting from 0, in module m , or if m is omitted, in the current module. The handle is used in other column functions.

Column alignment constants

The following constants of type `Justification` are defined for reading or setting the alignment of text in a column.

<code>left</code>	aligns text to the left column
<code>right</code>	aligns text to the right column
<code>center</code>	centers text
<code>centre</code>	centers text
<code>full</code>	justifies text

attribute (in column)

Declaration

```
void attribute(Column c,
              string attr)
```

Operation

Makes column c display the attribute $attr$.

attrName

Declaration

```
string attrName(Column c)
```

Operation

Returns the name of the attribute displayed in a column; this is the value that the `attribute (in column)` function sets. Returns `null` if the column does not display an attribute.

Example

This example prints out the names of all the attributes displayed in the current view:

```
Module m = current
Column c
for c in m do {
    print "<" (attrName c) ">\n"
}
```

color (get)

Declaration

```
string colo[u]r(Column c,)
```

Operation

Returns the name of the attribute used for coloring a column, or `null` if none is set.

color (set)

Declaration

```
void colo[u]r(Column c,
               string attrName)
```

Operation

Uses `color` on column `c` as specified by the attribute named `attrName`.

delete (column)

Declaration

```
void delete(Column c)
```

Operation

Deletes column *c*. This command should not be used inside the `for . . do` loop. If every column must be deleted, use the following example.

Example

```
int n = 0          // number of existing columns
int i             // column index
Column c
for c in current Module do
    n++ // count the columns
// delete n column 0s
for i in 1:n do {
    delete column 0
}
```

dxl (get)

Declaration

```
string dxl(Column c)
```

Operation

Returns the DXL code set for DXL column *c*.

Example

```
Column col
for col in current Module do {
    string att = attrName(col)
    if (null att) {
        if (main(col)) {
            print "main\t"
        } else {
            print dxl(col) "\t"
        }
    } else {
        print att "\t"
    }
}
```

dxl (set)

Declaration

```
void dxl(Column c,  
         string dxlCode)
```

Operation

Sets the DXL code to use in a DXL column. This is equivalent to the menu option **Column > Edit > dxl**.

If you wish to use a Windows-style file separator (\), you must duplicate it (\\) so that DXL does not interpret it as a meta character in the string. Because DOORS automatically converts UNIX-style file separators (/) for Windows, it is usually more convenient to use them.

Example

```
dxl(column 0, "display obj.\"Object Heading\"")  
dxl(column 1, "#include <layout/trace.dxl>")
```

graphics (get)

Declaration

```
bool graphics(Column c)
```

Operation

Returns `true` when `c` is the column nominated for viewing in a graphics display; otherwise, returns `false`.

graphics (set)

Declaration

```
void graphics(Column c)
```

Operation

Nominates the column for viewing in a graphics display.

info (get)

Declaration

```
bool info(Column c)
```

Operation

Returns `true` when `c` is the column nominated for use by the datatips mechanism in Graphics mode; otherwise, returns `false`.

info (set)

Declaration

```
void info(Column c)
```

Operation

Nominates the column for use by the datatips mechanism in Graphics mode.

insert (column in module)

Declaration

```
Column insert(Column c)
```

Operation

Inserts a column, pushing subsequent columns one right. Returns a handle to the new column. If a column is inserted at a new position, it is important to initialize the width of the new column (see the `width (get)` function).

Example

This example inserts a new column 1 as a copy of the old column 1, if present:

```
insert(column 1)
```

justify (get alignment)

Declaration

```
string justify(Column c)
Justification justify(Column c)
```

Operation

The first form returns a string version of the type `Justification` constants.

The second form returns the type `Justification` constant for the specified column `c`. The constants are defined in “Column alignment constants,” on page 596.

justify (set alignment)

Declaration

```
void justify(Column c,
              Justification j)
```

Operation

Sets the alignment or justification of column *c* to the `Justification` constant *j*, which can be one of the constants defined in “Column alignment constants,” on page 596.

Example

```
justify(column 1, center)
```

main (get)

Declaration

```
bool main(Column c)
```

Operation

Returns `true` if the column is the main text column (with the appearance of the second column in the standard view).

main (set)

Declaration

```
void main(Column c)
```

Operation

Makes column *c* the main text column (with the appearance of the second column in the standard view).

text (column)

Declaration

```
string text(Column c,  
            Object o)
```

Operation

Returns the text contained in column *c* for object *o*.

When *c* is the main column, this function returns the empty string. You must assemble the elements of the main column from the "Object Heading" and "Object Text" attributes, and the number function. You can use the `main (get)` function to check for this condition.

Example

```
Object o
```

```
Column c
```

```

for o in current Module do {
  for c in current Module do {
    if (main c) {
      print o."Object Heading" "\n\n"
      print o."Object Text" "\n\n"
    } else {
      print text(c, o) "\n"
    }
  }
}

```

title (get)

Declaration

```
string title(Column c)
```

Operation

Returns the string that is the title of column *c*.

title (set)

Declaration

```
void title(Column c,
            string heading)
```

Operation

Sets the title of column *c* to the string *heading*.

width (get)

Declaration

```
int width(Column c)
```

Operation

Returns the number of screen pixels used by column *c*.

Example

```

Column c
for c in current Module do {
  print (title c) " " (justify c) " "
  print (width c) "\n"
}

```

width (set)

Declaration

```
void width(Column c,
           int w)
```

Operation

Sets the width of column *c* to *w* in pixels.

for columns in module

Syntax

```
for c in m do {
  ...
}
```

where:

c is a variable of type Column

m is a module of type Module

Operation

Assigns the variable *c* to be each successive column in the current view in module *m*. The command `delete (Column)` should not be used inside the body of the loop.

Example

```
Column c
for c in current Module do print (title c) "\n"
```

Scrolling functions

This section gives the syntax for scrolling functions, which control view scrolling. The functions use internal data types, so declarations are not stated.

scroll

Syntax

```
scroll(position)
```

Operation

Scrolls to the position determined by the supporting functions: `top`, `bottom`, `to`, `up`, `down`, and `page`. The syntax for these functions is as follows:

```
top (Module m)
bottom (Module m)
to ({top|bottom} (Module m))
to (Object o)
up (Module m)
down (Module m)
page ({up|down} (Module m))
```

Example

```
scroll up current Module
scroll down current Module
scroll page up current Module
scroll page down current Module
```

Layout DXL

This section describes the DXL features unique to layout DXL. Layout DXL is used to populate a column within a DOORS view, typically to construct traceability or impact analysis reports.

The Insert Column dialog box in the DOORS GUI has a **Layout DXL** option which pops up a DXL Library window, which allows you to browse several layout DXL programs; they can also be found in `$DOORSHOME/lib/dxl/layout`.

For information on how to check the validity of your DXL code, see the `checkDXL` function.

Layout context

Layout DXL programs run in a context where the variable `obj` is pre-declared. You can have a column that contains DXL code. The code calculates the value to display for each object. The current object to calculate is referred to as `obj`.

display

Declaration

```
void display(string line)
void display(attrRef)
```

where *attrRef* is in one of the following formats:

```
(Object o).(string attrName)
```

```
(Module m).(string attrName)
```

```
(Link l).(string attrName)
```

Operation

Adds a new line to the column. The new line contains the specified string or the value of the referenced attribute.

If you pass a referenced attribute and the value contains rich text markup, this function interprets the rich text markup.

If you pass a string that contains rich text markup, this function does not interpret the rich text markup; it passes the rich text tags as text characters. Use the `displayRich` function if you want the rich text markup to be interpreted.

For more information, see “Rich text,” on page 723.

Example

This example takes two attribute values from the current object `obj` and calculates a derived value for display. The empty string is needed to convert the area’s `int` value into a string:

```
// calculate area of obj
int length = obj."Length"
int width = obj."Width"
display (length*width) ""
```

This example adds another line to the column with the attribute "Object Text":

```
display obj."Object Text"
```

This example is for a module where column A is text and column B is the following DXL:

```
string s=obj."A" ""
display "<"s s">"
```

For values of A of hello and bye, you see:

```
Column: ID A (text) B (DXL)
Values: 1 hello <hellohello>
2 bye <byebye>
```

displayRich

Declaration

```
void displayRich(string richTextString)
```

Operation

Adds a new line to the column. The new line contains the specified string.

This function operates in the same way as the `display` function, except that it interprets any rich text markup in the specified string. For more information, see “Rich text,” on page 723.

Example

```
displayRich richText obj."Object Text"
```

displayRichWithColo[u]r

Declaration

```
void displayRichWithColo[u]r(string richTextString)
```

Operation

Like the existing `displayRich` for displaying text in layout dxl, but respects the text colour specified in the string argument, which must be RTF (not plain text).

Example

```
bool fullRTF=true
Buffer b1=create
Buffer b2=create
Buffer res=create

b1=obj."Specification"
b2=obj."Proposed_specification"

diff(res, b1, b2, fullRTF)
displayRichWithColour stringOf(res)
```

getCanvas

Declaration

```
DBE getCanvas()
```

Operation

Returns a handle to a virtual canvas with which normal canvas drawing functions can be used. The canvas is in the DOORS formal module `display` in a column driven by layout DXL. When using this perm, checks should be made for the perm returning a null value, to prevent DXL errors.

hasPicture/exportPicture

Declaration

```
bool hasPicture(Column c)
string exportPicture(Column c, Object o, string filename, int format)
```

Operation

The two perms here are for use along with the `htmlText` perm. After calling `htmlText` on a column, `hasPicture` will tell you whether a picture of some layout DXL has been stored with the column. You can then call `exportPicture` to export the picture.

isFirstObjectInDXLSet(Object)

Declaration

```
bool isFirstObjectInDXLSet(Object o)
```

Operation

This perm has been added for use only within layout DXL.

Exposes to DXL the processing of objects during various stages of the execution of layout DXL.

Layout DXL processes sets of objects at a time. When layout DXL is running against an object, that object may be in a set of objects that will be processed. For example, during the repaint of a formal module display, the set is those objects that will be drawn to the display.

This perm returns `true` in the following cases:

- Layout DXL is not executing
- Layout DXL is executing against a set of objects, and `Object` is the first to be processed in that set

An object may be simultaneously the first such object in a set and the last such object in a set; the set may contain a single object.

This perm, and its partner, `isLastObjectInDXLSet()`, allow layout DXL to perform certain actions only at the start or end of a particular set processing. This can support the DXL programmer to write more efficient layout DXL.

isLastObjectInDXLSet(Object)

Declaration

```
bool isLastObjectInDXLSet(Object o)
```

Operation

This perm has been added for use only within layout DXL.

Exposes to DXL the processing of objects during various stages of the execution of layout DXL.

Layout DXL processes sets of objects at a time. When layout DXL is running against an object, that object may be in a set of objects that will be processed. For example, during the repaint of a formal module display, the set is those objects that will be drawn to the display.

This perm returns `true` in the following cases:

- layout DXL is not executing
- layout DXL is executing against a set of objects, and `Object` is the last to be processed in that set

An object may be simultaneously the first such object in a set and the last such object in a set; the set may be singleton.

This perm, and its partner, `isFirstObjectInDXLSet()`, allow layout DXL to perform certain actions only at the start or end of a particular set processing. This can support the DXL programmer to write more efficient layout DXL.

Example

Insert a Layout DXL column containing the following:

```
if (isFirstObjectInDXLSet(obj))
{
    display "This is the first object in the module window."
}
else if (isLastObjectInDXLSet(obj))
{
    display "This is the last object in the module window."
}
else
{
    // do nothing
}
```

You can then click your mouse on the bottom right hand corner of the module window and resize to see the perms in operation.

Chapter 21

Partitions

This chapter describes DOORS partitions.

- Partition concepts
- Partition definition management
- Partition definition contents
- Partition management
- Partition information
- Partition access

Partition concepts

Any partition operation can be performed through DXL. These operations fall into the following categories:

- Management of partition definitions
- Management of partitions
 - Exporting a partition from the home database
 - Accepting a partition in the away database
 - Adding data to a partition in the away database
 - Returning a partition from the away database
 - Rejoining a partition to the home database

Partition definition management

A partition definition describes the information that is to be included in partition. This is a list of modules, called partition modules, and, for each partition module, a list of attributes, views, and (for link modules) linksets to be included. A partition module is really just a placeholder for the real module, but it is associated with a real module. This manual refers to it as if it were the regular module.

In a partition definition, a set of maximum access rights is associated with each partition module, partition attribute, and partition view. These maximum access rights determine what users at the away database can do when the partition definition is used to create a partition.

create (partition definition)

Declaration

```
PartitionDefinition create(Project p,  
                           string name,  
                           string desc)
```

Operation

Creates a partition definition in project *p* with name *name* and description *desc*. The partition definition created must be saved before use.

delete (partition definition)

Declaration

```
string delete(PartitionDefinition pd)
```

Operation

Removes the partition definition *pd* from its project.

If successful, returns a null string; otherwise returns a string containing an error message.

dispose (partition definition)

Declaration

```
string dispose(PartitionDefinition pd)
```

Operation

Frees up the memory used by DXL to store the partition definition *pd*. It does not affect the partition definition as stored in the database.

If successful, returns a null string; otherwise returns a string containing an error message.

copy (partition definition)

Declaration

```
string copy(PartitionDefinition pd,  
            string name,  
            string desc)
```

Operation

Creates a copy of a partition definition with the name *name*, and the description *desc*.

If successful, returns a null string; otherwise returns a string containing an error message.

rename (partition definition)

Declaration

```
string rename(PartitionDefinition pd,
              string newName)
```

Operation

Changes the name of a partition definition to *newName*.

If successful, returns a null string; otherwise returns a string containing an error message.

load (partition definition)

Declaration

```
PartitionDefinition load(Project p,
                        string name)
```

Operation

Loads partition definition *name* in project *p*. This is used to obtain a handle for editing with the `addModule`, `addLinkModule`, and `removeModule` functions, but not the `addAwayModule`, `addAwayLinkModule` functions.

loadInPartitionDef

Declaration

```
PartitionDefinition
loadInPartitionDef(Project p, string name)
```

Operation

Loads partition definition associated with the partition *name*, which is a partition that has been accepted into project *p*. This is used in the away database to add data to a partition with the `addAwayModule`, `addAwayLinkModule` functions.

save (partition definition)

Declaration

```
string save(PartitionDefinition pd)
```

Operation

Saves a partition definition in the home database.

If successful, returns a null string; otherwise returns a string containing an error message.

saveModified (partition definition)

Declaration

```
string saveModified(Project p,
                   string inPartname
                   PartitionDefinition pd)
```

Operation

Saves a partition definition in the away database. The partition definition is associated with the partition *inPartname*, which has been accepted into the away database.

If successful, returns a null string; otherwise returns a string containing an error message.

Example

```
pd = loadInPartitionDef(project, "N")
(...)
saveModified(project, "N", pd)
```

setDescription (partition definition)

Declaration

```
string setDescription(PartitionDefinition pd,
                     string newDesc)
```

Operation

Changes the description of a partition definition to *newDesc*.

If successful, returns a null string; otherwise returns a string containing an error message.

Partition definition contents

This section describes functions and `for` loops concerned with the contents of a partition definition.

addModule, addLinkModule

Declaration

```
string add[Link]Module(PartitionDefinition pd,
                      string modName)
```

Operation

Adds module *modName* to the partition definition *pd*. The module name must be specified with a full path name relative to the project (beginning with the project name).

If successful, returns a null string; otherwise returns a string containing an error message.

Use the function `addModule` for formal modules; use `addLinkModule` for link modules.

These perms will add the module to the partition definition with access rights set to RMCD by default.

addAwayModule, addAwayLinkModule

Declaration

```
string
addAway[Link]Module(PartitionDefinition pd,
                    string modName)
```

Operation

Adds module *modName* to the partition definition *pd* in the away database. This means that *pd* must be obtained from the `loadInPartitionDef` function. The module name must be specified relative to the folder in the away database created when the partition was accepted.

If successful, returns a null string; otherwise returns a string containing an error message.

Use the function `addAwayModule` for formal modules; use `addAwayLinkModule` for link modules.

This marks the module as being partitioned in. When the partition is finally returned, the module is returned with the other partitioned-in data.

Example

If you accept a partition called N into a folder B, a folder called N is created inside B. If you then create a module A in folder N, you can add it to the partition definition with:

```
pd = loadInPartitionDef(project, "N")
addAwayModule(pd, "A")
```

findModule

Declaration

```
PartitionModule
findModule(PartitionDefinition pd,
           string modName)
```

Operation

Returns a handle to the description of the module in the partition definition *pd*. In the home database, the *modName* argument must be an absolute path from the containing project (not including the project name). In the away database, the *modName* argument must be a path relative to the partition folder.

The handle is used with the `findLinkset`, `addLinkset`, `addAwayLinkset`, and `addView`, `addAwayView` functions to edit the information, including linksets, associated with this module in the partition definition.

findLinkset

Declaration

```
PartitionLinkset findLinkset(PartitionModule pm,
                             string source,
                             string target)
```

Operation

Returns a handle for the linkset between `source` and `target` in the partitioned link module `pm`. The names specified for both the source and target modules must be absolute paths from the containing project (not including the project name).

findAttribute

Declaration

```
PartitionAttribute
findAttribute(PartitionModule pm,
              string attrName)
```

Operation

Returns a handle for the attribute called `attrName` in the partition module `pm`.

The handle can be used with dot notation to extract the name of the attribute.

findView

Declaration

```
PartitionView findView(PartitionModule pm,
                       string viewName)
```

Operation

Returns a handle for the view called `viewName` in the partition module `pm`.

The handle can be used with dot notation to extract the name of the view.

addAttribute, addAwayAttribute

Declaration

```
string add[Away]Attribute(PartitionModule pm,
                          string attrName)
```

Operation

Specifies that attribute *attrName* is to be included with the information in partition module *pm*. Use the function `addAwayAttribute` when adding information in the away database.

If successful, returns a null string; otherwise returns a string containing an error message.

addLinkset, addAwayLinkset

Declaration

```
string add[Away]Linkset(PartitionModule pm,
                       string srcName,
                       string trgName)
```

Operation

Adds a linkset to a partition definition containing *pm*, which must be a link module in the partition definition. The linkset has source *srcName* and target *trgName* in module *pm*.

Use the function `addAwayLinkset` when adding information in the away database.

For `addLinkset` the module name must be specified without a full path name. Only the module name is required.

For `addAwayLinkset` the module name must be specified relative to the folder in the away database created when the partition was accepted.

If successful, returns a null string; otherwise returns a string containing an error message.

addView, addAwayView

Declaration

```
string add[Away]View(PartitionModule pm,
                    string viewName)
```

Operation

Specifies that view *viewName* is to be included with the information in partition module *pm*, which must describe a formal module. Use the function `addAwayView` when adding information in the away database.

If successful, returns a null string; otherwise returns a string containing an error message.

removeModule

Declaration

```
string removeModule(PartitionDefinition pd,
                   string modName)
```

Operation

Removes a partition module from a partition definition.

If successful, returns a null string; otherwise returns a string containing an error message.

removeAttribute

Declaration

```
string removeAttribute(PartitionModule pm,  
                      string attrName)
```

Operation

Removes attribute *attrName* from the information to be included with partition module *pm*. You cannot remove information from a partition definition in the away database.

If successful, returns a null string; otherwise returns a string containing an error message.

removeLinkset

Declaration

```
PartitionLinkset  
removeLinkset(PartitionModule pm,  
              string source,  
              string target)
```

Operation

Removes a particular linkset from the information to be included with partition module *pm*, which must be a link module. The names specified for both the source and target modules must be absolute paths from the containing project (not including the project name).

removeView

Declaration

```
string removeView(PartitionModule pm,  
                  string viewName)
```

Operation

Removes view *viewName* from the information to be included with partition module *pm*. You cannot remove information from a partition definition in the away database.

If successful, returns a null string; otherwise returns a string containing an error message.

allowsAccess

Declaration

```
bool
allowsAccess({PartitionAttribute pa|
             PartitionModule pm|
             PartitionView pv},
             PartitionPermission pp)
```

Operation

Returns `true` if the data is to be included in the partition with the maximum access rights `pp`. Otherwise, returns `false`.

setAccess

Declaration

```
void setAccess({PartitionAttribute pa|
              PartitionModule pm|
              PartitionView pv},
              PartitionPermission pp)
```

Operation

Sets the maximum access rights to the data in the away database to be `pp`.

for partition module in partition definition

Syntax

```
for partModule in partDefinition do {
  ...
}
```

where:

<i>partModule</i>	is a variable of type <code>PartitionModule</code>
<i>partDefinition</i>	is a variable of type <code>PartitionDefinition</code>

Operation

Assigns *partModule* to be each successive module within *partDefinition*.

for partition attribute in partition module

Syntax

```
for partAttr in partModule do {  
  ...  
}
```

where:

partAttr is a variable of type `PartitionAttribute`

partModule is a variable of type `PartitionModule`

Operation

Assigns *partAttr* to be each successive attribute within *partModule*.

for partition view in partition module

Syntax

```
for partView in partModule do {  
  ...  
}
```

where:

partView is a variable of type `PartitionView`

partModule is a variable of type `PartitionModule`

Operation

Assigns *partView* to be each successive view within *partModule*.

Partition management

This section describes the functions for exporting, accepting, returning, and rejoining partitions.

apply (partition definition)

Declaration

```
string apply(Project p,
             string partDefName,
             string partName,
             string partDesc,
             string filename[, bool overwrite])
```

Operation

Applies partition definition *partDefName* to create a partition with name *partName* and description *partDesc*. The partition is written to file *filename*, which should have a file type of `.par`. Note that the same partition definition can be used on different occasions to create partitions with different names. If the boolean argument *overwrite* is specified as `true`, and the specified export file already exists, it will be overwritten. If the argument is `false`, or is not given, then the perm will not overwrite the file, but will return an error message.

open (partition file)

Declaration

```
PartitionFile open(string filename)
```

Operation

Creates a partition file and returns a handle. The file type must be `.par`.

The handle can be used with dot notation to extract any of the properties available from a variable of type `PartitionFile`.

Example

This example checks that the file is a valid partition file:

```
PartitionFile pf = open("partition.par")
```

close (partition file)

Declaration

```
string close(PartitionFile pf)
```

Operation

Closes a partition file and releases the handle.

If successful, returns a null string; otherwise returns a string containing an error message.

acceptReport

Declaration

```
string acceptReport(PartitionFile pf,
                   string foldername)
```

Operation

Returns a string containing a report on information that would be produced if the partition in *pf* is accepted into folder *foldername*. This includes the names of the modules, attributes, and views which would be created.

acceptPartition

Declaration

```
string acceptPartition(Project p,
                      PartitionFile pf,
                      folder foldername)
```

Operation

Accepts the partition in *pf* into folder *foldername* in project *p*.

If successful, returns a null string; otherwise returns a string containing an error message.

returnPartition

Declaration

```
string returnPartition(Project p,
                      string partName,
                      string returnDesc,
                      string partFileName,
                      bool isFinal,
                      bool deleteData[, bool overwrite])
```

Operation

Returns the accepted partition with name *partName*, using the description *returnDesc*. This creates file *partFileName*.

If *isFinal* is true, the return is a final return: the data cannot be returned again. If *isFinal* is false, the return is a synchronize operation, and the value of *deleteData* is ignored.

If *deleteData* is true, the return operation deletes all accepted data. If *deleteData* is false, the return operation removes partition locks on the data, so that it remains in the database but is no longer partitioned in.

If the argument *overwrite* is specified as true, and the specified file already exists, it will be overwritten. If the argument is false, or is not given, then the perm will not overwrite the file, but will return an error message.

If successful, returns a null string; otherwise returns a string containing an error message.

rejoinReport

Declaration

```
string rejoinReport(PartitionFile pf,
                   string pathname)
```

Operation

Returns a string containing a report on information that would be produced if the partition in *pf* is rejoined. This includes the names of the modules, attributes, and views which would be created. The *pathname* argument is reserved for future enhancements; currently, it is ignored.

rejoinPartition

Declaration

```
string rejoinPartition(Project p,
                      PartitionFile pf)
```

Operation

Rejoins the partition in *pf* into folder *foldername* in project *p*.

If successful, returns a null string; otherwise returns a string containing an error message.

removePartition

Declaration

```
string removePartition(Project p,
                      string partName)
```

Operation

Recovers the information exported in *partName*, which must be the name of a partition exported from project *p*. This removes its partitioned out status, which allows it to be edited. Once removed, the partition can never be rejoined.

If successful, returns a null string; otherwise returns a string containing an error message.

Partition information

This section describes the functions and properties that allow access to the attributes of partitions and partition definitions. Some functions use the data type `PartitionPermission`, which has the same range of values as `Permission`, but applies only to data in partition definitions. This is the data type that confers the maximum access rights for users at the away database, if the partition definition is used to create a partition.

Partition properties

Partition properties are defined for use with the `.` (dot) operator and a partition handle to extract information from a partition or partition definition, as shown in the following syntax:

```
variable.property
```

where:

```
variable      is a variable of type PartitionDefinition,
                PartitionModule, PartitionAttribute,
                PartitionView, PartitionFile, InPartition, or
                OutPartition.
```

The properties available vary according to the type being examined.

The types `PartitionDefinition`, `PartitionModule`, `PartitionAttribute`, and `PartitionView` refer to information in a partition definition.

You can obtain an object of type	Using
<code>PartitionDefinition</code>	<code>load (partition definition) function</code> or for partition definition in project loop.
<code>PartitionModule</code>	<code>findModule function</code> or for partition module in partition definition loop
<code>PartitionAttribute</code>	<code>findAttribute function</code> or for partition attribute in partition module loop
<code>PartitionView</code>	<code>findView function</code> or for partition view in partition module loop
<code>PartitionFile</code>	<code>open (partition file) function</code> An object of type <code>PartitionFile</code> is created after a user at a home database has exported a partition and created a partition file.
<code>OutPartition</code>	for out-partition in project loop An object of type <code>OutPartition</code> is created after a user at a home database has exported a partition definition. You can only access a type <code>OutPartition</code> using this loop.

You can obtain an object of type	Using
InPartition	for in-partition in project loop An object of type InPartition is created after a user at a home database has exported a partition definition. You can only access a type InPartition using this loop.

Partition definition properties

After a user at the home database has created a partition definition you can use these properties on a variable of type PartitionDefinition.

String property	Extracts
description	Description of partition definition
name	Name of partition definition

Partition module properties

After a user at the home database has created a partition definition you can use this property on a variable of type PartitionModule.

String property	Extracts
name	Name of partition module

Partition attribute properties

After a user at the home database has created a partition definition you can use this property on a variable of type PartitionAttribute.

String property	Extracts
name	Name of partition attribute

Partition view properties

After a user at the home database has created a partition definition you can use this property on a variable of type PartitionView.

String property	Extracts
name	Name of partition view

Partition file properties

After a user at the home database has exported a partition and created a partition file, or after a user at the away database has synchronized or returned a partition, you can use these properties on a variable of type `PartitionFile`.

String property	Extracts
<code>author</code>	The user who created the partition file
<code>date</code>	Date the partition file was created
<code>definitionName</code>	Name of partition definition
<code>description</code>	Description of partition contained in file
<code>name</code>	Name of partition contained in file
<code>subtype</code>	If the type is <code>Initial</code> , returns <code>"ReadOnly"</code> if the file contains a partition in which all the data is read-only. Otherwise, returns <code>"Writeable"</code> . If the type is <code>Final</code> , returns <code>"Final"</code> if the file contains a partition that has been returned for the last time (not synchronized). Otherwise, if the file is a synchronize file, returns <code>"Intermediate"</code> .
<code>timestamp</code>	Timestamp of partition file
<code>type</code>	Returns <code>"Initial"</code> if the file contains a partition that is yet to be imported into the away database. Returns <code>"Final"</code> if the file contains a partition that has been returned or synchronized from the away database, and which should be rejoined or synchronized at the home database.

Out-partition properties

After a partition has been exported, the user at the home database can use these properties on a variable of type `OutPartition`.

String property	Extracts
<code>author</code>	The user who exported the partition
<code>applyDate</code>	Date the partition was exported
<code>definitionName</code>	Name of partition definition
<code>description</code>	Description of partition
<code>folderName</code>	Folder that contains all of the modules included in the partition definition

String property	Extracts
name	Name of partition
rejoinedBy	User who rejoined the partition
rejoinedDate	Date the partition was rejoined

In-partition properties

After a partition has been imported, the user at the away database can use these properties on a variable of type `InPartition`.

String property	Extracts
acceptDate	Date the partition was imported to the away database
applyDate	Date the partition was exported from the home database
author	The user who created the partition file
definitionName	Name of partition definition
description	Description of partition
folderName	Folder the partition was accepted into
name	Name of partition
returnedBy	User who returned the partition
returnedDate	Date the partition was returned
type	If the partition contains writable data, returns "Writeable"; otherwise, returns "ReadOnly"

for in-partition in project

Syntax

```
for inPartition in project do {
  ...
}
```

where:

inPartition is a variable of type `InPartition`

project is a variable of type `Project`

Operation

Assigns *outPartition* to be each successive imported partition record in the specified project. This is primarily for use in the away database.

for out-partition in project

Syntax

```
for outPartition in project do {
  ...
}
```

where:

outPartition is a variable of type `OutPartition`

project is a variable of type `Project`

Operation

Assigns *outPartition* to be each successive exported partition record in the specified project. This is primarily for use in the home database.

for partition definition in project

Syntax

```
for partDefinition in project do {
  ...
}
```

where:

partDefinition is a variable of type `PartitionDefinition`

project is a variable of type `Project`

Operation

Assigns *partitionDefinition* to be each successive partition definition within the specified project.

Partition access

This section describes the functions and properties that manage the partition and rejoin access rights.

isPartitionedOut, isPartitionedOutDef, isPartitionedOutVal

Declaration

```
string
isPartitionedOut({Item i|Folder f|Project p|
                 Module m|Object o|View v},
                bool &result)

string isPartitionedOut(AttrType at,
                       bool &result)

string isPartitionedOutDef(AttrDef ad,
                           bool &result)

string isPartitionedOutVal(AttrDef ad,
                           bool &result)
```

Operation

If the current user has read access to the entity identified by the argument, sets *result* to indicate whether the entity is partitioned out, and returns a null string. If the current user does not have read access, returns an error message.

getPartitionMask, getPartitionMaskDef, getPartitionMaskVal

Declaration

```
string
getPartitionMask({Item i|Folder f|Project p|
                 Module m|Object o|View v},
                 Permission &p)

string getPartitionMask(AttrType at,
                       Permission &p)

string getPartitionMaskDef(AttrDef ad,
                           Permission &p)

string getPartitionMaskVal(AttrDef ad,
                           Permission &p)
```

Operation

This perm should only be used in the away database.

If the current user has read access to the entity identified by the argument, sets *p* to a mask of the entity's permissions, and returns a null string. The mask describes the maximum access allowed to users in the away database. If the current user does not have read access, returns an error message.

If the data is partitioned in, the mask passed back is a bitwise OR of read, create, modify, and delete, access rights. If the data is not partitioned in, the mask is null.

Chapter 22

OLE objects

This chapter describes DOORS DXL support for OLE technology. These functions are currently only available on Windows platforms. OLE technology support encompasses the linking and embedding of OLE objects and the use of the system clipboard to manipulate embeddable and linkable objects. OLE DXL supports automation with DOORS as either client or server.

- Embedded OLE objects and the OLE clipboard
- OLE Information Functions
- Picture object support
- Automation client support
- Controlling DOORS from applications that support automation

Embedded OLE objects and the OLE clipboard

This section defines DXL functions that allow OLE objects to be manipulated within DOORS, and provide a programmatic means of controlling the OLE clipboard.

oleActivate

Declaration

```
bool oleActivate(Object o)
string oleActivate(Object o, Column c, integer index)
```

Operation

The first form activates the first OLE object embedded in the object text of *o*. The function returns `true` if the object text of *o* contains an OLE object and the activation of that object succeeds. Otherwise, it returns `false`.

The second form activates the OLE object at position *index* in the column *c*, for the object *o*.

The command uses the OLE object's primary verb. For example, a Word object chooses to open in edit mode, while a video object chooses to play.

Example

```
/*
   this code segment checks whether the object text of the current formal object
   contains an OLE object, and if so, activates the first one.
*/
Object obj = current
```

```

if (oleIsObject obj){
    if (oleActivate obj == false){
        print "Problem trying to activate object\n"
    }
} else {
    print "Does not contain an embedded object in its object text\n"
}
/*
this DXL script activates the second OLE object that exists
in column 1 of the module display
*/
oleActivate(current Object, column 1, 1)

```

oleDeactivate

Declaration

```

bool oleDeactivate(Object o)
bool oleDeactivate(Object o, Column col, int oleIndex)

```

Operation

Deactivates the OLE object embedded *o*. The function returns `true` if *o* contains an activated OLE object and the deactivation succeeds. Otherwise, it returns `false`.

The second variant of this perm deactivates the OLE object specified by *oleIndex* in the specified column of the passed formal object. If the `oleGetAutoObject()` function was called to get the object's dispatch pointer, the `oleCloseAutoObject()` function must be called to release the dispatch pointer before calling this function.

Example

```

/*
this code segment checks whether the current formal object contains an OLE
object in its object text, and if so, deactivates it
*/
Object obj = current
if (oleIsObject obj){
    if (oleDeactivate obj == false){
        print "Problem trying to deactivate
            object\n"
    }
} else {
    print "Does not contain an embedded object\n"
}

```

oleCopy

Declaration

```
bool oleCopy(EmbeddedOleObject oleObject)
string oleCopy(Object o, Column c, integer index)
```

Operation

The first form copies the embedded OLE object *oleObject* into the system clipboard. The OLE object can then be pasted into another DOORS formal object or into any other Windows application that supports automation.

The second form copies the embedded OLE object at position *index* in *column c* for *object o*, into the system clipboard. The OLE object can then be pasted into another DOORS formal object or into any other Windows application that supports automation.

Examples

```
void checkOLECopy(Object o, string attributeName)
{
    RichText rtf
    string s = richTextWithOle o.attributeName
    for rtf in s do
    {
        if (rtf.isOle)
        {
            EmbeddedOleObject ole = rtf.getEmbeddedOle
            oleCopy(ole)
            break
        }
    }
}

checkOLECopy(current Object, "Object Text")
/*
    this example copies the first OLE object in
    the current object, in column 1.
*/
string s = oleCopy(current Object, column 1, 0)
```

oleCut

Declaration

```
string oleCut(Object o, Column c, integer index)
bool oleCut(Object o)
```

Operation

The first form cuts the embedded OLE object at position *index* in column *c* for object *o*, into the system clipboard. The OLE object can then be pasted into another DOORS formal object or into any other Windows application that supports automation.

The second form cuts the embedded OLE object *o* into the system clipboard. The OLE object can then be pasted into another DOORS formal object or into any other Windows application that supports automation.

The function returns `true` if *o* contains an OLE object and the cut operation succeeds. Otherwise, it returns `false`.

Example

```
/*
  this code segment checks whether the current formal object
  contains an OLE object in its object text, and if it so, cuts it to the
  system clipboard, and then pastes it into the next formal
  object in the current formal module
*/
Object obj = current
if (oleIsObject obj){
  if (oleCut obj){
    obj = next current
    if (obj != null){
      if (olePaste obj == false)
        print "Problem trying to paste object\n"
    }
  } else {
    print "Problem trying to cut object\n"
  }
} else {
  print "Does not contain an embedded object in its object text\n"
}
/*
  this DXL script cuts the second OLE object that exists in
  column 1 of the module display
*/
string s = oleCut(current Object, column 1, 0)
```

oleDelete

Declaration

```
bool oleDelete(Object o)
string oleDelete(Object o, Column c, integer index)
```

Operation

The first form removes the embedded OLE object from the object text of *o*. The function returns `true` if the object text of *o* contains an OLE object and the removal of that object succeeds. Otherwise, it returns `false`.

The second form deletes the OLE object in column *c*, for object *o*, at the index *index*.

Example

```
/*
this code segment removes an embedded OLE object from the object text of the
current formal object.
*/
oleDelete (current Object)
```

oleInsert

Declaration

```
bool oleInsert(Object o, string fileName)
bool oleInsert(Object o, string fileName, bool insertAsIcon)
```

Operation

Embeds the file *fileName* as an OLE object in DOORS formal object *o* in the Object Text attribute. The function returns `true` on successful insertion of the OLE object. Otherwise, it returns `false`.

The second variant of the perm inserts an OLE object pointed to by *fileName* into the specified DOORS object *o*. If the *insertAsIcon* parameter is `true`, the OLE object is displayed as an icon, otherwise it is displayed as content (the equivalent of the existing perm).

An OLE package is created if a file has no associated applications that support OLE. OLE packages even allow executable files to be embedded into documents. It is then possible to execute such a file from within the document.

Example

```
/*
this code segment embeds an existing word document into the current formal
object
*/
string docName = "c:\\docs\\details.doc"
Object obj = current
```

```

if (oleInsert(obj, docName)){
    print "Successfully embedded document\n"
} else {
    print "Problem trying to embed document\n"
}

```

oleIsObject

Declaration

```
bool oleIsObject(Object o)
```

Operation

Returns true if *o* contains an embedded OLE object in its Object Text attribute; otherwise, returns false.

Example

```

/*
this code segment checks to whether the current formal object contains an OLE
object in its Object Text attribute, and if it does not, embeds a word document.
*/

string docName = "c:\\docs\\details.doc"
Object obj = current
if (oleIsObject obj){
    print "Already contains embedded object\n"}
else {
    oleInsert(obj, docName )
}

```

oleCloseAutoObject

Declaration

```
void oleCloseAutoObject(OleAutoObj &oa)
```

Operation

Closes an open OLE handle (interface) and deallocates the memory associated with it. It also sets the argument passed to it to null.

This function is useful for releasing handles that have been allocated, for example, through the `oleGetAutoObject` function. These handles are not normally released until the DXL program exits.

oleOpen

Declaration

```
bool oleOpen(Object o)
```

Operation

Opens the OLE object embedded in the object text of *o* in a new instance of its application. The function returns `true` if *o* contains an OLE object in its object text and the opening of that object succeeds. Otherwise, it returns `false`.

The command uses the OLE object's primary verb. For example, a Word object chooses to open in edit mode, while a video object chooses to play.

olePaste

Declaration

```
bool olePaste(Object o)
```

Operation

Pastes the contents of the system clipboard into the object text of *o* as an embedded OLE object. The function returns `true` if *o* does not contain an OLE object and the paste operation succeeds. Otherwise, it returns `false`.

Example

```
/*
this code segment checks whether the current formal object contains an OLE
object in its object text, and if it so, cuts it to the system clipboard, and
then pastes it into the next formal object in the current formal module
*/

Object obj = current
if (oleIsObject obj){
    if (oleCut obj){
        obj = next current
        if (obj != null){
            if (olePaste obj == false){
                print "Problem trying to paste
                    object\n"
            }
        }
    } else {
        print "Problem trying to cut object\n"
    }
} else {
    print "Does not contain an embedded object in its object text\n"
}
```

olePasteLink

Declaration

```
bool olePasteLink(Object o)
bool olePasteLink(attrRef)
```

Operation

The first form pastes the contents of the system clipboard `o` as a link to an OLE object. This function only succeeds if there is enough information about the data in the system clipboard to describe its location. Typically this function is used to link to a section of data in a larger body of data, for example, a paragraph in a Word document. The function returns `true` if `o` does not contain an OLE object and the paste operation succeeds. Otherwise, it returns `false`.

The second form inserts from the system clipboard into the text attribute referred to by `attrRef`.

Example

```
/*
this code segment checks to see whether the current formal object contains an
OLE object in its object text, and if it does not, pastes a link to the object
described in the system clipboard.
*/
Object obj = current
if (oleIsObject obj == false){
    if (olePasteLink obj == false){
        print "Problem trying to paste link to
            object\n"
    }
} else {
    print "Does not contain an embedded object\n"
}
```

oleSaveBitmap

Declaration

```
oleSaveBitmap(Object o)
```

Operation

Forces a write of the picture for the current object. This affects OLE display on UNIX platforms.

Example

```
Object o = current
oleSaveBitmap (o)
```

oleCount

Declaration

```
int oleCount(attrRef)
```

Operation

Returns the number of OLE objects embedded in the attribute (new version of `oleIsObject (Object)`)

Example

```
Object o = current
int n = oleCount(o."Object Text")
print "Number of OLE objects in Object Text attribute for current object: " n ""
```

isOleObjectSelected

Declaration

```
bool isOleObjectSelected(Object o)
```

Operation

Returns `true` if an OLE object is selected in the specified Object `o`. If anything other than an OLE object is selected (e.g. text and an OLE object), the function returns `false`. If two or more contiguous OLE objects are selected, the function returns `true`.

showOlePropertiesDialog

Declaration

```
void showOlePropertiesDialog(Object o)
```

Operation

Shows the OLE properties dialog for the selected OLE object in the specified Object `o`.

- If no OLE object is selected, the dialog will not appear.
- If anything other than an OLE object is selected (e.g. text and an OLE object), the function returns `false`.
- If two or more contiguous OLE objects are selected, the options dialog will appear for the first object.

containsOle

Declaration

```
bool containsOle(Attr__ attrRef)
```

Operation

Returns `true` if the specified attribute contains OLE data

Example

```
Object o = current
if (containsOle(o."Object Text")){
    oleActivate(o)
}
```

OLE Information Functions

getOleWidthHeight

Declaration

```
string getOleWidthHeight(EmbeddedOleObject embedOle, int &width, int &height)
```

Operation

These functions provide information on Embedded OLE objects as demonstrated by the following examples.

Example 1

```
void checkOLEcount(Object o, string attributeName)
{
    int n = oleCount(o.attributeName)
    RichText rtf
    string s = richTextWithOle o.attributeName
    int j = 0
    for rtf in s do
    {
        if (rtf.isOle)
        {
            j++
        }
    }
    if (j != n)
    {
        print "ERROR: oleCount gives " n " and for rtf in string gives " j "\n"
    } else {
        print "OK: they both give " n "\n"
    }
}

Object o = current
checkOLEcount(o, "Object Text")
```

Example 2

```

void checkExportPicture(Object o, string attributeName, string baseFileName)
{
    EmbeddedOleObject ole
    int i = 1
    string errmess = null
    RichText rtf
    string s = richTextWithOle o.attributeName
    i = 1
    for rtf in s do
    {
        if (rtf.isOle)
        {
            ole = rtf.getEmbeddedOle
            string filename = baseFileName "-rtfloop-" i ".png"
            print "Exporting " filename "\n"
            errmess = exportPicture(ole,filename , formatPNG)
            if (!null errmess)
            {
                print "ERROR: " errmess "\n"
            }
            i++
        }
    }
}
Object o = current
checkExportPicture(o, "Object Text", "C:\\temp\\")

```

Example 3

```

void checkOLECopy(Object o, string attributeName)
{
    RichText rtf
    string s = richTextWithOle o.attributeName

    for rtf in s do

```

```

    {
        if (rtf.isOle)
        {
            EmbeddedOleObject ole = rtf.getEmbeddedOle
            oleCopy(ole)
            break
        }
    }
}

```

```
checkOLECopy(current Object, "Object Text")
```

Example 4

```
void checkOLEWidthHeight(Object o, string attributeName)
```

```

{
    EmbeddedOleObject ole
    RichText rtf
    string s = richTextWithOle o.attributeName
    int width, height
    for rtf in s do
    {
        if (rtf.isOle)
        {
            ole = rtf.getEmbeddedOle
            getOLEWidthHeight(ole, width, height)
            print("width = " width ", height = " height "\n")
        }
    }
}

```

```
checkOLEWidthHeight(current Object, "Object Text")
```

```
//run with an object containing several OLEs of different sizes in the object
text
```

Example 5

```
Object o = current
int width
int height
string mess = getPictWidthHeight(o, width, height)
if (null mess)
{
    print "w = " width ", h = " height "\n"
}else{
    print mess "\n"
}
```

Run this against an object with an embedded picture, an object with at least one OLE object in the object text and an object with no OLE objects or pictures.

oleSetMaxWidth

Declaration

```
string oleSetMaxWidth(Attr__ attrRef, int width)
```

Operation

Sets the maximum width of an OLE object in the attribute *attrRef*. Any OLE object wider will be scaled down to fit the column (i.e. the aspect ratio will be maintained).

Returns an error message if anything goes wrong.

oleSetMinWidth

Declaration

```
string oleSetMinWidth(Attr__ attrRef, int width)
```

Operation

Sets the minimum width of an OLE object in the attribute *attrRef*. Any OLE object narrower will be scaled up to fit the column (i.e. the aspect ratio will be maintained).

Returns an error message if anything goes wrong.

oleResetSize

Declaration

```
string oleResetSize(Attr__ attrRef)
```

Operation

Resets the width and height of the OLE objects in the attribute *attrRef* to their actual size.

Example 1

Scale to fit main column

Sets the max and min width of OLEs in the object text to the width of the main column.

Object obj

Column col

Column mainColumn

```
for col in current Module do
{
    if (main col)
    {
        mainColumn = col
        break
    }
}
int width = width(mainColumn)
string errmess = ""
for obj in current Module do
{
    int numOles = oleCount(obj."Object Text")
    if (numOles > 0)
    {
        errmess = oleSetMaxWidth(obj."Object Text", width)
        if (!null errmess)
        {
            break
        }
        errmess = oleSetMinWidth(obj."Object Text", width)
    }
}
```

```

        if (!null errmess)
        {
            break
        }
    }
}
if (!null errmess)
{
    print "ERROR:" errmess "\n"
}

```

Example 2

Reset main column OLEs

Resets the size of all OLE objects in the Object Text

Object obj

Column col

Column mainColumn

```

for col in current Module do
{
    if (main col)
    {
        mainColumn = col
        break
    }
}
int width = width(mainColumn)
string errmess = ""
for obj in current Module do
{
    int numOles = oleCount(obj."Object Text")
    if (numOles > 0)
    {
        errmess = oleResetSize(obj."Object Text")
        if (!null errmess){
            break
        }
    }
}

```

```

        }
    }
}
if (!null errmsg)
{
    print "ERROR:" errmsg "\n"
}

```

Picture object support

These functions allow DXL to import pictures into DOORS, and work with objects that contain pictures. In DOORS 6.0 and later, pictures are unique to an object, and it is not necessary to identify a picture with a name. The functions using a picture name argument should be used for backwards compatibility only.

Constants

The following constants of type `int` are valid values for arguments that specify the format of a picture:

Import format	Description
<code>formatBMP</code>	Bitmap
<code>formatDIB</code>	Bitmap
<code>formatWMF</code>	Windows meta file
<code>formatEPSF</code>	Encapsulated PostScript
<code>formatUNKNOWN</code>	Unknown format

Export format
<code>formatPNG</code>

changePicture

Declaration

```

bool changePicture(string currentName,
                  string newName)

```

Operation

Changes the name of a given picture by passing the current and new names. Returns `true` if the operation succeeds. This function is retained only for compatibility with earlier releases.

copyPictureObject

Declaration

```
void copyPictureObject(Object source, Object target)
```

Operation

Copies a picture from the source object to the target object. It generates a run-time DXL error if either argument is null.

deletePicture

Declaration

```
bool deletePicture(Object o)
bool deletePicture(string pictureName)
```

Operation

Deletes the picture in object *o*. If the object is not a picture, the call fails.

The second form is retained only for compatibility with earlier releases. All new programs should use the first form.

Example

```
if (deletePicture current) {
    print "Successful deletion\n"
} else {
    print "Failed to delete picture\n"
```

exportPicture

Declaration

```
string exportPicture(Object obj,
                    string fileName,
                    int format)
```

Operation

Exports a picture, including OLE objects, associated with a given object to the file *fileName* in the specified format. Some pictures, when exported, may have a black border.

This function does not support WMF.

The only supported export format is `formatPNG`.

Example

```
Object o = current
string n = o."PictureName"
string s = exportPicture(o, n ".png",
                        formatPNG)

if (!null s) {
    print s " : " n "\n"
}
```

exportPicture

Declaration

```
string exportPicture(EmbeddedOleObject oleObject,
                    string fileName,
                    int format)
```

Operation

Exports a picture, including OLE objects, associated with a given object to the file *fileName* in the specified format.

Example

```
void checkExportPicture(Object o, string attributeName, string baseFileName)
{
    EmbeddedOleObject ole
    int i = 1
    string errmess = null
    RichText rtf
    string s = richTextWithOle o.attributeName
    i = 1
    for rtf in s do
    {
        if (rtf.isOle)
        {
            ole = rtf.getEmbeddedOle
            string filename = baseFileName "-rtfloop-" i ".png"
            print "Exporting " filename "\n"
            errmess = exportPicture(ole,filename , formatPNG)
            if (!null errmess)
            {
                print "ERROR: " errmess "\n"
            }
        }
    }
}
```

```

        i++
    }
}
Object o = current
checkExportPicture(o, "Object Text", "C:\\temp\\")

```

getPictBB

Declaration

```

void getPictBB(Object o,
               int &llx,
               int &lly,
               int &urx,
               int &ury)

```

Operation

Returns the picture's bounding box measured in tenths of a point. The bounding box is specified by its lower-left and upper-right co-ordinates.

Only for compatibility with DOORS 2.1, the function

```

void getpictbb(Object o,
               int &llx,
               int &lly,
               int &urx,
               int &ury)

```

is supported. New programs should use the `getPictBB` function.

getPictFormat

Declaration

```

string getPictFormat(Object o)
int getPictFormat(Object o)

```

Operation

The first form returns the name of the format of the picture in object `o`.

The second form returns an integer corresponding to the format of the picture in object `o`.

Possible format names and integers are:

"EPSF"	1	Encapsulated PostScript
"BMP"	2	Windows Bitmap

`"WMF"`

3

Windows Meta File

Example

```

if (getPictFormat current Object != "EPSF") {
    ack "Cannot output this picture format"
    halt
}

```

getPictName

Declaration

```
string getPictName(Object o)
```

Operation

If `o` contains a picture in a format supported by DOORS, this function returns the picture file name; otherwise, it returns `null`. The returned file name should be treated as a read-only handle. This function is intended for use by exporters.

If the operation fails, returns `null`.

getPictWidthHeight

Declaration

```

string getPictWidthHeight(Object o,
                           int &width,
                           int &height,)

```

Operation

On return, passes back by reference the picture's width and height in pixels. The object must contain either a picture or an OLE object.

On Windows platforms, if it is an OLE object, a bitmap is generated of the OLE object, then the width and height taken of the bitmap.

On UNIX platforms, this function returns the width and height of the picture snapshot of the OLE object (picture snapshots are stored in the database if `oleunix=true` is included in the registry). If a snapshot does not exist, returns an error message to indicate that the width and height are unavailable.

If the operation succeeds, returns `null`; otherwise returns an error message.

Example

```

int width
int height
Object o = current
bool bIsPicture = o."Picture"

```

```

bool bIsOLE = o."OLE"
if(bIsPicture || bIsOLE){
    string errmsg = getPictWidthHeight(o)
    if(null errmsg)
    {
        print "width = " width " ,height=" height
            ""
    } else {
        print errmsg
    }
}

```

importPicture

Declaration

```

bool importPicture(string pictureName,
                  string fileName,
                  string format)

```

Operation

Imports pictures into DOORS. This function is retained for compatibility with earlier releases, but is redundant in DOORS 6.0 and later.

The *pictureName* argument is the name for the picture once it is imported; *fileName* is the file you are importing from; and *format* is the format of the picture, which can be one of "WMF", "BMP" or "EPSF" (case insensitive).

Returns true if the import succeeds; otherwise, returns false.

Example

```

if (importPicture("Test", "c:\\test.bmp", "BMP")) {
    print "Successfully imported picture
        test.bmp\n"
} else {
    print "Failed to import picture test.bmp\n"
}

```

insertBitmapFromClipboard

Declaration

```

bool
insertBitmapFromClipboard(Object insertHere)

```

Operation

Inserts a bitmap of any format except an OLE object from the Windows clipboard into the object *insertHere*. The object must already contain a picture, which is replaced. If the operation succeeds, returns true; otherwise, returns false. If *insertHere* is null, the call fails.

For UNIX platforms, returns `false`.

saveClipboardBitmapToFile

Declaration

```
bool saveClipboardBitmapToFile(string fileName)
```

Operation

If there is a valid bitmap on the Windows clipboard, saves it to the specified file. The argument *fileName* can be an absolute or relative path. If the operation succeeds, returns `true`; otherwise, returns `false`.

For UNIX platforms, returns `false`.

Example

```
string FileName=tempFileName()  
saveClipboardBitmapToFile(FileName)
```

insertPictureAfter

Declaration

```
bool insertPictureAfter(string pictureName,  
                        Object insertHere)
```

Operation

Inserts picture *pictureName* after an object *insertHere*. This function is supported only for compatibility with earlier releases. In new programs, use the `insertPictureFileAfter` function.

Example

```
if (insertPictureAfter("Test", current Object)) {  
    print "Successful picture insertion\n"  
} else {  
    print "Failed to insert the picture\n"}
```

insertPictureBelow

Declaration

```
bool insertPictureBelow(string pictureName,  
                        Object insertHere)
```

Operation

Inserts picture *pictureName* below an object *insertHere*. This function is supported only for compatibility with earlier releases. In new programs, use the `insertPictureFileBelow` function.

Example

```
if (insertPictureBelow("Test", current Object)) {
    print "Successful picture insertion\n"
} else {
    print "Failed to insert the picture\n"
}
```

insertPictureFile

Declaration

```
bool insertPictureFile(string fileName,
                      int format
                      Object insertHere)
```

Operation

Inserts picture *fileName* into object *insertHere*, which must be a picture object. If the operation succeeds, an existing picture in the object is replaced with that in *fileName*. The format argument can be one of the import values listed in “Constants,” on page 644.

Example

```
Object currentObject = current
bool Result = false
string BitmapFileName = "c:\\test.bmp"
if (currentObject == null) {
    //No objects currently exist in the module
    Result = insertPictureFile(BitmapFileName,
                              formatBMP, currentObject)
} else {
    Result = insertPictureFile(BitmapFileName,
                              formatBMP, currentObject)
}
if(Result) {
    print "Successful picture insertion\n"
}
```

insertPictureFileAfter

Declaration

```
bool insertPictureFileAfter(string fileName,
                            int format
                            Object insertHere)
```

Operation

Inserts picture *fileName* after an object *insertHere*. The format argument can be one of the import values listed in “Constants,” on page 644.

Example

```
Object currentObject = current
bool Result = false
string BitmapFileName = "c:\\test.bmp"
if (currentObject == null) {
    //No objects currently exist in the module
    Result = insertPictureFileAfter(BitmapFileName,
        formatBMP,null)
} else {
    Result = insertPictureFileAfter(BitmapFileName,
        formatBMP,currentObject)
}
if(Result) {
    print "Successful picture insertion\n"
}
```

insertPictureFileBelow

Declaration

```
bool insertPictureFileBelow(string fileName,
    int format
    Object insertHere)
```

Operation

Inserts picture *fileName* below an object *insertHere*. The format argument can be one of the import values listed in “Constants,” on page 644.

Example

```
Object currentObject = current
bool Result = false
string BitmapFileName = "c:\\test.bmp"
if (currentObject == null) {
    //No objects currently exist in the module
    Result = insertPictureFileBelow(BitmapFileName,
        formatBMP,null)
} else {
    Result = insertPictureFileBelow(BitmapFileName,
        formatBMP,currentObject)
}
```



```

if(Result) {
    print "Successful picture insertion\n"
}

```

oleLoadBitmap

Declaration

```

Bitmap oleLoadBitmap(DBE dialog,
                    Object fromHere,
                    bool lockColors,
                    int& width,
                    int& height)

```

Operation

Returns a bitmap handle for the given OLE object, provided the OLE bitmap has been stored.

The handle to the bitmap can then be used to draw the picture onto a canvas.

The function requires passed width and height; when the function exits these become the width and height of the picture.

OLE bitmaps are only stored in DOORS 4.1 and later releases, and then only if you have not run DOORS with the command line option to prevent it storing the picture.

Example

```

b = oleLoadBitmap(dbMain, current Object, true,
                 w, h)

DBE dbMain

void doDraw(DBE dbMain) {
    Bitmap b
    int w, h
    b = oleLoadBitmap(dbMain, current Object, true,
                    w, h)
    drawBitmap(dbMain, b, 0,0)
}

DB artBox = create "Try resizing"
dbMain = canvas(artBox, 400, 300, doDraw)
show artBox

```

openPictFile

Declaration

```

Stream openPictFile(Object o)

```

Operation

Opens a read-only stream for the file containing the picture referenced in the named object.

Only for compatibility with DOORS 2.1, the function:

```
Stream openpictfile(Object)
```

is supported. New programs should use the `openPictFile` function.

Example

```
Stream picture = openPictFile thisObj
```

pictureCopy

Declaration

```
bool pictureCopy(Object object)
```

Operation

On Windows platforms only, copies the picture in the specified object to the system clipboard.

Example

```
bool Result = pictureCopy(current)
if(Result) {
    print "Picture successfully copied\n"
} else {
    print "Picture not copied\n"
}
```

reimportPicture

Declaration

```
bool reimportPicture(string pictureName)
```

Operation

This function is provided only for compatibility with earlier releases. It has no effect in DOORS 6.0 or later.

for pictures in project

Syntax

```
for s in pictures(Project p) do {
    ...
}
```

where:

s is a string variable
p is a project of type `Project`

Operation

This loop is retained for compatibility with earlier release. Because of the changes to access restrictions in DOORS 6.0, where pictures are specific to a module, this loop returns the names of the pictures in the current module only.

Example

This example prints the names of all pictures in the current module.

```
string s
for s in pictures current Project do {
    print s " \n"
}
```

supportedPictureFormat

Declaration

```
bool supportedPictureFormat(int format)
```

Operation

Returns true if the specified format is supported by the current client.

Example

```
if(supportedPictureFormat(formatWMF)){
    print "WMF format is supported.\n"
}
```

pictureCompatible

Declaration

```
bool pictureCompatible(string filename, int format)
```

Operation

Returns true if the specified file has header information which indicates that it contains a picture of the specified format.

Example

```
string fileName = "C:\\temp\\mypic.bmp"
if(pictureCompatible(fileName, formatBMP)){
    print fileName " is a valid BMP file.\n"
}
```

Automation client support

This section defines DXL functions with which DOORS can be used as an automation client. That means DOORS can be used to control other Windows applications that provide automation interface objects. Information on interface objects, methods and properties for other applications is available in the relevant automation documentation.

The functions fall into three groups:

- Accessing an interface

The DXL functions `oleCreateAutoObject` and `oleGetAutoObject` provide access to automation interfaces in other applications. In addition to obtaining interface objects in these specific ways, interface objects can also be retrieved by accessing the properties or making method calls to other interface objects.

- Getting and setting properties

The DXL functions `oleGet` and `olePut` provide access to automation object properties. The values of a property can be retrieved from an automation object, and where the object allows it, they can also be set.

- Calling automation methods

In addition to providing access to properties, automation interfaces can also provide methods. These provide access to capability in the other application and can return data as a result of their execution. In addition they may require data to be passed to them as arguments. DOORS provides support for automation methods with the various `oleMethod` functions, the `OleAutoArgs` variable type and the various functions that can be used to manipulate variables of that type: `create (OleAutoArgs)`, `delete (OleAutoArgs)`, `clear (OleAutoArgs)`, `put (OleAutoArgs)`, and `oleMethod`.

oleGetResult

Declaration

```
string oleGetResult()
```

Operation

DOORS provides the read-write `Result` property to automation clients, allowing them to exchange information with DXL programs. This function gets the value of this property.

Example

```
if (oleGetResult == "OK") {  
    // operation was successful  
}
```

oleSetResult

Declaration

```
void oleSetResult(string message)
```

Operation

DOORS provides the read-write `Result` property to automation clients, allowing them to exchange information with DXL programs. This function sets the value of this property.

oleCreateAutoObject

Declaration

```
OleAutoObj
oleCreateAutoObject(string autoObjName)
```

Operation

Obtains a reference to a named automation interface. With a type `OleAutoObj` it is then possible to access properties and call methods. The application to support the interface object is started when this function is called.

Example

```
OleAutoObj theWordApp = oleGetAutoObject("Word.Application")
if (null theWordApp){
    theWordApp =
        oleCreateAutoObject("Word.Application")
}
olePut (theWordApp, "visible", true)
infoBox "Now you see it."
olePut (theWordApp, "visible", false)
infoBox "Now you don't."
```

oleGetAutoObject

Declaration

```
OleAutoObj oleGetAutoObject(Object o)
OleAutoObj oleGetAutoObject(string autoObjName)
```

Operation

The first form obtains a reference to an automation interface object for the OLE object embedded in `o`. With a type `OleAutoObj` it is then possible to access properties and call methods. The application to support the interface object is started when this function is called.

This function returns the base level interface to the embedded object. Not all objects that support embedding and automation also support automation of embedded objects. For objects that are not supported, null is returned.

The second form obtains a reference to an instance of the application that is already running. For an example of its use, see the example for the `oleCreateAutoObject` function.

Example

This example is for Excel 95; it does not work with Excel 97. It obtains a reference to an automation interface for an embedded Excel Chart document, and changes its chart style to a pie chart:

```
int xlPieChart = -4102

OleAutoObj objExcelChart = oleGetAutoObject(current Object)

if (objExcelChart != null){
    int currentType
    oleGet(objExcelChart, "type", currentType)
    if (currentType != xlPieChart){
        olePut (objExcelChart, "type",
            xlPieChart)
    } else {
        print "Already a pie chart\n"
    }
} else {
    print "No Auto Object\n"
}
```

For other examples that control Office 97 applications, see the programs in `lib/dxl/standard/export/office`.

oleGet

Declaration

```
string oleGet(OleAutoObj autoObj,
             string propertyName,
             [OleAutoArgs argumentList,]
             {string|int|bool|char|OleAutoObj}
             &Result)
```

Operation

Obtains the value of a specified property for a specified automation object, with optionally a list of arguments of type `OleAutoArgs`, and with `Result` set to the appropriate type.

The variation of this function that allows access to an `OleAutoObj` value is particularly useful when controlling an application that has a hierarchy of objects.

If the value of a property is successfully returned, returns null; otherwise returns a string containing an error message.

Example

This example obtains a reference to an automation interface to Excel, gets the visible attribute, and makes it visible if it is hidden:

```
OleAutoObj objExcel = oleCreateAutoObject("Excel.Application")

if (objExcel != null){
    bool excelVisible
    oleGet(objExcel, "Visible", excelVisible)
```

```

    if (excelVisible == false){
        olePut(objExcel, "Visible", true)
    }
}

```

For other examples that control Office 97 applications, see the programs in `lib/dxl/standard/export/office`.

olePut

Declaration

```

string olePut(OleAutoObj autoObj,
              string propertyName,
              {string|int|char|bool|OleAutoObj}
              newValue)

```

Operation

Sets the value of a specified property for a specified automation object, with *newValue* set to the appropriate type. If the value of a property is successfully set, returns null; otherwise, it returns a string containing an error message.

Example

This example is for Excel 95; it does not work with Excel 97. This example uses a variety of DXL automation functions to create an Excel spreadsheet including adding values and formulae to specific cells using the `olePut` function:

```

/*
This function sets a specific property for a specific cell in a specific Excel
Worksheet. If it succeeds it returns null otherwise it returns an error string
*/

string SetExcelCell(OleAutoObj objSheet,
                   int          xCellLoc,
                   int          yCellLoc,
                   string       property,
                   string       value)
{
    OleAutoObj objCell = null
    OleAutoArgs autoArgs = create
    string result = null
    put(autoArgs, yCellLoc)
    put(autoArgs, xCellLoc)

    result = oleMethod(objSheet, "Cells",
                       autoArgs, objCell)
}

```

```

    if (result == null){
        OleAutoObj objInterior = null
        result = olePut(objCell, property, value)
    }
    return result
} /* SetExcelCell */

OleAutoObj objExcel =
    oleCreateAutoObject("Excel.Application")
OleAutoArgs autoArgs = create
OleAutoObj objSpreadSheet
OleAutoObj objWorkbooks
bool excelVisible

/* Make Excel visible to the user */
oleGet(objExcel, "visible", excelVisible)

if (excelVisible == false)
    olePut(objExcel, "visible", true)

/* Add new workbook */
oleGet(objExcel, "Workbooks", objWorkbooks)
oleMethod(objWorkbooks, "Add")

clear(autoArgs)
put(autoArgs, "Sheet1")

/* Add new worksheet and activate it */
oleMethod(objSpreadSheet, "Activate")
SetExcelCell(objSpreadSheet, 2, 2, "Value", (10
    ""))
SetExcelCell(objSpreadSheet, 2, 3, "Value", (20
    ""))
SetExcelCell(objSpreadSheet, 2, 4, "Value", (30
    ""))
SetExcelCell(objSpreadSheet, 2, 5, "Value", (40
    ""))
SetExcelCell(objSpreadSheet, 2, 6, "Value", (50
    ""))
SetExcelCell(objSpreadSheet, 2, 7, "Formula",
    "=SUM(B2:B6) ")

```

For other examples that control Office 97 applications, see the programs in `lib/dx1/standard/export/office`.

create (OleAutoArgs)

Declaration

```
OleAutoArgs create(void)
```

Operation

Initializes and returns a type `OleAutoArgs` variable.

Example

```
/*Typical call to create for an OleAutoArgs variable*/  
OleAutoArgs autoArgs = create
```

delete (OleAutoArgs)

Declaration

```
void delete(OleAutoArgs autoArgs)
```

Operation

Destroys a type `OleAutoArgs` variable and frees any system resources used by it. After a type `OleAutoArgs` variable has been deleted with this function, it becomes invalid and cannot be used again until initialized with the `create (OleAutoArgs)` function.

Example

This example is a typical call to delete for a variable of type `OleAutoArgs`:

```
OleAutoArgs autoArgs = create  
delete(autoArgs)
```

clear (OleAutoArgs)

Declaration

```
void clear(OleAutoArgs autoArgs)
```

Operation

Empties the contents of a type `OleAutoArgs` variable, returning it to the state it was in immediately after it was initialized with the `create` command. This allows a single type `OleAutoArgs` variable to be created and then reused again and again throughout a DXL application.

Example

This example is a typical call to clear for a variable of type `OleAutoArgs`:

```
OleAutoArgs autoArgs = create
```

```

clear(autoArgs)
/*
code using the same autoArgs variable for something different
*/
delete(autoArgs)

```

put (OleAutoArgs)

Declaration

```

void put(OleAutoArgs autoArgs,
        [string argName,]
        {string|int|char|bool|OleAutoObj} value)

```

Operation

Stores a value of the appropriate type in a type `OleAutoArgs` variable *autoArgs*. The optional argument *argName* allows arguments to be named. If it is omitted, the values are inserted into the argument block in the order in which they are supplied.

This means that where the automation object supports named arguments, the formal ordering of arguments is not necessary. Both named and ordered arguments are permitted in the same `OleAutoArgs` variable.

For examples of usage see the example for the `oleMethod` function.

oleMethod

Declaration

```

string
oleMethod(OleAutoObj autoObj,
          string methodName
          [,OleAutoArgs autoArgs
          [, {string|int|char|bool|OleAutoObj}
            result]])

```

Operation

Uses a specific automation interface to call a specific automation method. Optionally you can specify an argument block. With an argument block, optionally, you can specify a return value of a specific type. If the operation succeeds, `oleMethod` returns `null`; otherwise, it returns a string containing an error message.

Example

This example is for Excel 95; it does not work with Excel 97. This example shows how an `OleAutoArgs` variable can be set up to contain a number of arguments to be passed via an `oleMethod` call to an automation method. The code creates an Excel spreadsheet, populates it with some data, and then uses that data to create a chart:

```

/*
The function SetExcelCell, defined in a previous example, is used.
*/

```

```

OleAutoObj  objExcel = oleCreateAutoObject("Excel.Application")
OleAutoObj  objWorkbooks
OleAutoObj  objCharts
OleAutoObj  objChart
OleAutoObj  objActiveChart
OleAutoObj  objSpreadSheet
OleAutoObj  objRange
OleAutoArgs autoArgs = create
bool        excelVisible = false
string      result
/* Make Excel visible to the user */
oleGet(objExcel, "Visible", excelVisible)
if (!excelVisible)
    olePut(objExcel,"Visible", true)
/* Add new workbook */
oleGet(objExcel,"Workbooks", objWorkbooks)
oleMethod(objWorkbooks,"Add")
put(autoArgs, "Sheet1")
/* Add new worksheet and activate it */
oleMethod(objExcel,"Sheets", autoArgs,
          objSpreadSheet)
oleMethod(objSpreadSheet, "Activate")
/* Add some data to the spreadsheet */
for (i = 1; i < 8; i++){
    for (j = 1; j < 8; j++){
        string value = ( ( 10*i) + j ) ""
        SetExcelCell(objSpreadSheet, i, j,
                    "Value", value)
    }
}
clear(autoArgs)
/* Selected the data that has been entered */
put(autoArgs, "a1:h8")
oleMethod (objSpreadSheet, "Range", autoArgs,
          objRange)
oleMethod (objRange, "Select")
clear(autoArgs)

```

```

/* Create a chart object */
put(autoArgs, "Chart1")
result = oleGet(objSpreadSheet,"ChartObjects",
               objCharts)
if (result != null) print result "\n"
clear(autoArgs)
/* Define the size and location of the new chart */
put(autoArgs, 50)
put(autoArgs, 80)
put(autoArgs, 400)
put(autoArgs, 200)
oleMethod(objCharts,"Add", autoArgs, objChart)
oleMethod(objChart, "Activate")
oleGet(objExcel, "ActiveChart", objActiveChart)
clear(autoArgs)
/* Use named arguments this time round - then we
   don't have to fill them all in
*/
put(autoArgs, "source", objRange)
put(autoArgs, "gallery", -4100)
put(autoArgs, "format", 5)
put(autoArgs,"categoryLabels", 2)
put(autoArgs,"seriesLabels",2)
put(autoArgs,"HasLegend",true)
result = oleMethod(objActiveChart, "ChartWizard", autoArgs)
if (result != null) print result "\n"

```

For other examples that control Office 97 applications, see the programs in `lib/dxl/standard/export/office`.

Controlling DOORS from applications that support automation

This section defines functions for controlling DOORS from other applications that support automation. For example, Visual Basic macros can be created in Excel to send commands to DOORS.

Automation interface

DOORS provides an automation interface for other applications to use to control DOORS. This object is called `DOORS.Application`. It provides two methods that can be called from other applications, along with the property `Result`.

The property, `DOORS.Application.Result`, allows other applications to exchange information with DOORS in both directions. From DOORS, use the `oleGetResult` and `oleSetResult` functions to pass information to and from a Visual Basic program.

Example

```
/*
This is an example of an Excel macro that calls DOORS, logging in as user 'John
Smith' with password 'password', and sets the result message for use with
oleGetResult.
*/

Sub testDoors()
    Set DOORSObj = CreateObject("DOORS.Application")

    SendKeys "John Smith" & "{TAB}" & "password" &
        "{ENTER}", True

    DOORSObj.Result = "Just checking"
End Sub
```

runFile

Syntax

```
runFile(dxlFileName)
```

where:

dxlFileName is a full path

Operation

This method allows other applications to pass DOORS the path and file name of a DXL file, then requests DOORS to run it.

Example

This example is an Excel macro that calls DOORS, logging in as user **John Smith** with password **password**, and requests it to run the `ddbintro` example from the DXL library:

```
Sub testDoors()
    Set DOORSObj = CreateObject("DOORS.Application")

    SendKeys "John Smith" & "{TAB}" & "password" &
        "{ENTER}", True
```

```

DOORSObj.runFile ("c:\doors\lib\dxl\example\
                 ddbintro.dxl")
End Sub

```

Note: There has been a change in functionality between DOORS 7.x and DOORS 8 concerning `runFile`. Any files passed to `runFile` must be transcoded to UTF-8 encoding rather than Latin-1. Alternatively, you can use `runStr` to `#include` a file. The behavior of `runStr` is unchanged since version 7.

runStr

Syntax

```
runStr(dxlText)
```

where:

dxlText is a string

Operation

This method allows other applications to pass DOORS a string containing DXL functions for DOORS to execute.

You can send more than one line to `runStr` at a time by using `\n` or `;` in the string.

Example

This example is an Excel macro that calls DOORS, logging in as user **John Smith** with password **password**, and requests it to create a new module. The macro then creates an object in the module:

```

Sub testDoors()
    Set DOORSObj = CreateObject("DOORS.Application")
    SendKeys "John Smith" & "{TAB}" & "password" &
           "{ENTER}", True
    DOORSObj.runStr("current = create(""Demo"",
                                     ""Demo"", "", 1);
    Object o = create first current Module;
    o."Object Heading" = "From Excel via OLE" "")
End Sub

```

Chapter 23

Triggers

This chapter describes triggers, a powerful mechanism for associating DOORS scripts with events in DOORS.

- Introduction to triggers
- Trigger constants
- Trigger definition
- Trigger manipulation
- Drag-and-drop trigger functions

Introduction to triggers

Triggers are a mechanism in DXL for associating an event, such as opening a project or modifying an attribute, with a DXL program. This provides a very powerful customization facility.

There are two examples demonstrating the use of triggers: `defview.dxl` and `delview.dxl` which permit the automatic loading of a user's preferred view in a formal module. These can be found in the directory: `$DOORSHOME/lib/dxl/example`

Triggers are described in terms of **level**, **type** and **event**:

Trigger levels	Trigger types
module	post
object	
attribute	
discussion	
comment	

A **pre-event** trigger is a mechanism for performing an action or a check before an event happens. The code executed can return a veto, which prevents the subsequent event from happening. When multiple triggers have been defined for the same event, trigger execution is ordered on the trigger's priority. For a pre-event to succeed, all pre-events must succeed.

A **post-event** trigger is executed after the associated event happens, for example after a module is opened.

Basic trigger events

There are four basic event types:

Event	Synonyms
open	edit, read
close	
save	write, modify
sync	
drag	
drop	
create	

The only current application for the sync event is changing the current object in a formal and link module. The following table shows currently supported event and level combinations:

	open	close	save	sync	drag	drop	create
module	x	x					
object	x			x	x	x	
attribute			x				
discussion							x
comment							x

Both pre and post event types are supported for all marked combinations.

Trigger levels have the following two extra dimensions: **scope** and **priority**.

The object open event will only occur when double-clicking on the object. Viewing the object through Object Properties will not cause an open event.

Trigger scope

Triggers are database wide or specific to a module, object, or attribute. They can be generic or specific.

generic	Trigger applies to all entities at trigger level, for example, all modules, all objects, all attributes.
----------------	--

specific Trigger applies to a specific entity, for example, `module "URD"` means the module called `URD`, `current` means the current entity (as in `current Module`) at a trigger level.

Specific items defined are for each level.

project	project name
module	module name
object	absolute number, as string
attribute	attribute name

Generic module triggers are stored in the specified project or the current project, unless the trigger is specified as database wide using the `project->all` syntax. In this case, they are stored in the database root folder. Project level triggers are not supported.

Specific module triggers, including all object level and attribute level triggers, are stored in the module to which they apply. If the trigger specification does not name a specific module, they are stored in the current module.

For modules, you can also restrict to a particular type of module: formal, link, or descriptive.

If you want an object trigger to apply only to the current object at definition time, you must give its absolute number as a specific argument:

```
project->module->object->"13"
```

To simplify the notation you can omit mention of the project or module levels when you want the current project or module. The example becomes:

```
attribute->"Cost"
```

In summary, if you do not mention a level, you mean the current position in the DOORS schema at the time of definition.

Trigger events

There are four classes of event, with synonyms:

open, read	Synonyms for the same fundamental event, open is usually used with projects and modules, while read is used with objects.
close	Triggered when DOORS is about to close a project or a module.
write, save, modify	Synonyms for wanting to make a change; currently only supported for attribute modification.
sync	Triggered when the current object changes in a formal module.
drag	Triggered when the user starts a drag operation from a formal module object.

drop	Triggered when data is dragged from another application and dropped onto a displayed formal module object.
create	Applies to discussions and comments, fires on their creation,

If you try to define an unsupported trigger combination, an error message is issued.

Trigger priority

Triggers are assigned an integer priority; lower valued priorities are executed before higher valued priorities.

Persistent versus dynamic triggers

There are two further classes of trigger:

persistent	Stored in DOORS; once defined, persists between sessions until deleted.
dynamic	Not stored; persists only for the loaded lifetime of the project or module that defines it.

Note: In DOORS 8.2 and later versions, drag-and-drop triggers can only be dynamic.

Triggers overview

The following tables show what information is available to triggers of various types.

Dynamic triggers

kind	dynamic	dynamic	dynamic	dynamic	dynamic	dynamic	dynamic	dynamic	dynamic	dynamic
level	module	module	object	object	attribute	module	module	object	object	attribute
type	pre	pre	pre	pre	pre	post	post	post	post	post
event	open	close	open	sync	save	open	close	open	sync	save
priority	✓	✓	✓	✓	✓	✓	✓	✓	✓	✓
attribute	✗	✗	✗	✗	✓ ¹	✗	✗	✗	✗	✓ ¹
levelModifier	✗	✗	✗	✗	✗	✗	✗	✗	✗	✗
name	✓ ²	✓ ²	✓ ²	✓ ²	✓ ²	✓ ²	✓ ²	✓ ²	✓ ²	✓ ²
string object	✗	✗	✓	✓	✓	✗	✗	✓	✓	✓
string module	✗	✗	✗	✗	✗	✗	✗	✗	✗	✗
value	✗	✗	✗	✗	✓	✗	✗	✗	✗	✓
dxl	✗	✗	✗	✗	✗	✗	✗	✗	✗	✗
Module module	✗	✓	✓	✓	✓	✗	✓	✓	✓	✓
Object object	✗	✗	✓	✓	✓	✗	✗	✓	✓	✓
attrdef	✗	✗	✗	✗	✓	✗	✗	✗	✗	✓

¹ Only if trigger is on a named attribute.

² Trigger name generated by system

Persistent triggers

kind	stored	stored	stored	stored	stored	stored	stored	stored	stored	stored
level	module	module	object	object	attribute	module	module	object	object	attribute
type	pre	pre	pre	pre	pre	post	post	post	post	post
event	open	close	open	sync	save	open	close	open	sync	save
priority	✓	✓	✓	✓	✓	✓	✓	✓	✓	✓
attribute	✗	✗	✗	✗	✓ ³	✗	✗	✗	✗	✓ ³
levelModifier	✗	✗	✗	✗	✗	✗	✗	✗	✗	✗
name	✓	✓	✓	✓	✓	✓	✓	✓	✓	✓
string object	✗	✗	✓	✓	✓	✗	✗	✓	✓	✓
string module	✓	✓	✓	✓	✓	✓	✓	✓	✓	✓
value	✗	✗	✗	✗	✓	✗	✗	✗	✗	✓
dxi	✓	✓	✓	✓	✓	✓	✓	✓	✓	✓
Module module	✗	✓	✓	✓	✓	✗	✓	✓	✓	✓
Object object	✗	✗	✓	✓	✓	✗	✗	✓	✓	✓
attrdef	✗	✗	✗	✗	✓	✗	✗	✗	✗	✓

³ Only if trigger is on a named attribute

Trigger constants

This section lists constants that are used in the definition of triggers. Some are defined through internal data types; others are of type `TriggerStatus`.

levels

A level can be one of the following values:

```

project
module
object
attribute
discussion
comment

```

level modifiers

A level modifier can be one of the following values:

`all`

`formal`

`link`

`descriptive`

These values specify the type of module affected.

event types

An event type can be one of the following values:

`pre`

`post`

event names

An event name can be one of the following values:

`open`

`read`

`close`

`save`

`modify`

`sync`

`create`

trigger status

A trigger status can be one of the following values:

`trigPreConPass`

`trigPreConFail`

`trigRunOK`

`trigError`

These constants are of type `TriggerStatus`. They are used with the `set` function. They are assigned to persistent pre-event triggers to set a return condition.

Trigger definition

This section defines an operator for assembling triggers and functions for triggers. They use internal data types or the data type `Trigger`.

Trigger level assembly

The `->` operator is used to describe the extent to which a trigger is applied:

Syntax

The syntax for using the `->` operator is as follows:

```
l -> l2
```

```
l -> mod
```

```
l -> string name -> mod
```

```
l -> string name -> string name2
```

where:

`l l2` are levels: project, module, object or attribute

`name name2` are strings

`mod` is a modifier: all, formal, link, or descriptive

Operation

The operator combines trigger level descriptions and specifies the scope of a trigger.

Example

- This attribute-level trigger is applied to the `Cost` attribute in the module named `URD` in the current folder:

```
module->"URD"->attribute->"Cost"
```

- This module-level trigger is applied to all formal modules in the current project:

```
module->all->formal
```

```
project->module->all>formal
```

These level descriptors are invalid if there is no current project.

- This module-level trigger is applied to all formal modules in the database:

```
project->all->module->formal->all
```

- This object-level trigger is applied to all formal modules in the `improvements` project:

```
project->"improvements"->module->all->formal->object->all
```

- This object-level trigger is applied to the current module:

```
module->object->"23"
```

This level descriptor is invalid if there is no current module.

trigger (persistent)

Declaration

```
Trigger trigger(string name,
                l,
                t,
                e,
                int p,
                string dxl)
```

where:

- l* is a level: project, module, object, or attribute
- t* is a type: pre or post
- e* is an event: open, read, close, save, modify or sync

Operation

Creates a trigger, named *name*, at level *l*, of type *t*, of event *e*, with priority *p*, and code *dxl*. If the operation fails, the function returns null. If the user does not have the appropriate modify access, the call fails.

- To create a stored database wide trigger, the user must have modify access to the database root folder.
- To create a trigger stored in a project, the user must have modify access to the project.
- To create a trigger stored in a module, the user must have modify access to the module.

Optionally, the level can be a compound level description.

These triggers are persistent between sessions, and so need be created only once.

Example

This example creates a project level, pre-type, open event trigger of priority 10, using a program stored in `$DOORSHOME/lib/dxl/triggers/projOpen.dxl`:

```
Trigger t = trigger("init", project, pre,
                  open, 10,
```

```
"#include <triggers/projOpen>")
```

This example sets up a trigger, which is executed when any module is about to be closed:

```
Trigger t2 = trigger("mod", module->all,
                   pre, close, 10,
                   "#include <triggers/modClose>")
```

trigger (dynamic)

Declaration

```
Trigger trigger(l,
               e,
               int p,
               {bool pre(Trigger) |
                void post(Trigger)})
```

where:

- l* is a level: project, module, object, or attribute
- e* is an event: open, read, close, save, modify or sync

Operation

Creates a dynamic trigger, which is not persistent between sessions, at level *l*, of event *e* and priority *p*. The `pre` callback function determines whether the operation happens or not. The callback function for a `post` event is a void function.

Optionally, the level can be a compound level description.

delete (trigger)

Declaration

```
string delete(string name,
              l,
              [string name2,]
              t,
              e,
              int p,)
              string delete(Trigger &d)
```

where:

- l* is a level: project, module, object, or attribute
- t* is a type: pre or post
- e* is an event: open, read, close, save, modify or sync

Operation

The first form deletes the specified trigger. The second form deletes trigger *d*, and sets *d* to null. If the operation succeeds, returns null; otherwise, returns an error message. If the user does not have the appropriate modify access, the call fails.

To delete a stored database wide trigger, the user must have modify access to the database root folder. To delete a trigger stored in a project, the user must have modify access to the project. To delete a trigger stored in a module, the user must have modify access to the module.

Trigger manipulation

This section defines functions that return information about, or modify triggers.

level, type, event (trigger)

These functions are used as shown in the following syntax:

```
level (Trigger t)
```

```
type (Trigger t)
```

```
event (Trigger t)
```

Operation

These functions return values for the level, type and event of trigger *t*, as follows:

level	project module object attribute
type	pre post
event	open read close save modify sync

stringOf (trigger)

These functions are used as shown in the following syntax:

```
string stringOf (level)
```

```
string stringOf (type)
```

```
string stringOf (event)
```

Operation

Return the string version of trigger level *level*, the trigger type *type*, or trigger event *event*, as follows:

<i>level</i>	project module object attribute
<i>type</i>	pre post
<i>event</i>	open read close save modify sync

attribute (trigger)

Declaration

```
string attribute (Trigger t)
```

Operation

Returns the name of the attribute to which trigger *t* applies, (if there is one); otherwise, returns `null`.

attrdef (trigger)

Declaration

```
AttrDef attrdef(Trigger t)
```

Operation

Returns the name of the attribute about to be saved for attribute pre-save triggers. For pre-open attribute triggers, returns `null`.

current (trigger)

Declaration

```
Trigger current()
```

Operation

Gets the current trigger handle in persistent trigger code.

dxl (trigger)

Declaration

```
string dxl(Trigger t)
```

Operation

Returns the DXL code associated with trigger *t*.

kind

Declaration

```
string kind(Trigger t)
```

Operation

Returns the kind of trigger *t*: one of `dynamic`, `stored` or `builtin`.

levelModifier

Declaration

```
string levelModifier(Trigger t)
```

Operation

Returns the module level modifier of trigger *t*, which can be one of the following values:

"F"	formal module
"L"	link module
"D"	descriptive module

name (trigger)

Declaration

```
string name(Trigger t)
```

Operation

Returns the name of trigger *t*.

object (trigger)

Declaration

```
string object(Trigger t)
```

```
Object object(Trigger t)
```

module

Declaration

```
Module module(Trigger t)
```

```
string module(Trigger t)
```

```
Module module(Trigger t, int unused)
```

Operation

Fetches the module associated with the specified trigger.

The notion of associated module is as follows:

Trigger	Returns...
Pre-open module and post-close module triggers	Normally a NULL module is returned. When a non-null module is returned, it will be the module against which this trigger last fired.
Post-open module trigger	The current version module or null is returned. When a baseline is opened, this perm will return the current version of the module only when that current version has been separately loaded.
Pre-close module trigger	The current version module or null is returned. When a baseline is closed, this perm will return the current version of the module only when that current version has been separately loaded.
Data-related triggers within a module (object and attribute open/sync, and so on)	The tree where the data resides. Note: Data with a baseline will return the baseline module.

For the following triggers, the associated module is the module containing the data (this will be a baseline when the data is in a baseline):

- object attribute, pre-save
- object attribute, post-save
- link attribute, pre-save
- link attribute, post-save

The third form is as `Module module (Trigger)`, but this variant will return baselined modules when a module-level trigger is running against a baseline of a module. For non-module triggers, the returned module is the same as `Module module (Trigger)`.

The unused integer parameter should be 0.

version

Declaration

```
ModuleVersion version(Trigger t)
```

Operation

Returns the version information pertaining to the specified trigger. The returned value will be null in the case that version information is not appropriate to the trigger.

It is not currently possible to associate a trigger with a specific module version, and thus only executing triggers have an associated version.

link

Declaration

```
Link link(Trigger t)
```

Operation

When a trigger fires because of an operation on a link, for example modification of an attribute) this perm provides access to the corresponding link. In all other cases null is returned.

value

Declaration

```
void value(Trigger t, Buffer b)
```

Operation

Similar to `string value(Trigger)`, but returns in buffer the RTF, inclusive of any OLE objects, of the new value (where that is appropriate).

The creation and deletion of `b` is the responsibility of the user.

priority

Declaration

```
int priority(Trigger t)
```

Operation

Returns the priority of trigger `t`. Lower numbers have higher priority.

set (trigger status)

Declaration

```
void set(TriggerStatus ts)
```

Operation

Sets a return condition in the DXL code assigned to persistent pre-event triggers. Possible values are: `trigPreConPass`, `trigPreConFail`, `trigRunOK`, and `trigError`.

Example

```
set trigPreConFail
```

stored

Declaration

```
string stored(Trigger t)
```

Operation

Returns the name of the module where trigger *t* is stored.

scope

Declaration

```
string scope(Trigger t)
```

```
Item scope(Trigger t)
```

Operation

Returns the item (or its unqualified name) to which the specified trigger applies. If the item is a project, then the trigger applies to all modules within the project. For static triggers, this returns the same as the stored () perm.

value

Declaration

```
string value(Trigger t)
```

Operation

Similar to `string value(Trigger)`, but returns the value being proposed for attribute modification by trigger *t*.

for trigger in database

Syntax

```
for t in database do {  
  ...  
}
```

where:

t is a variable of type `Trigger`

Operation

Assigns trigger *t* to be each successive database wide trigger.

for trigger in project

Syntax

```
for t in project do {
  ...
}
```

where:

t is a variable of type `Trigger`

project is a variable of type `Project`

Operation

Assigns trigger *t* to be each successive trigger in the specified project, and in any open modules in the project. The appropriate modules in the project must be open to allow access to the relevant trigger information. It includes all subprojects.

Example

This example deletes all triggers:

```
Trigger t
for t in current Project do delete t
```

for trigger in module

Syntax

```
for t in m do {
  ...
}
```

where:

m is a variable of type `Module`

t is a variable of type `Trigger`

Operation

Assigns trigger *t* to be each successive trigger in *m*, which must be an open module to allow access to the relevant trigger information.

Drag-and-drop trigger functions

This section defines functions that are used to setup drag or drop trigger callback functions, as well as those functions which can be used within them.

createDropCallback

Declaration

```
void createDropCallback(int fmt, int type, void cb(Trigger), Trigger t)
```

Operation

When used in a callback for drag trigger *t*, this registers a DXL callback functions *cb* to be run when the drop target application requests data in the specified clipboard format *fmt* and media *type* with a value included in the bitmap value *type*. The *fmt* and *type* argument should match the format of data which is supplied by the callback function using `setDropString()`, `setDropList()` etc.

registeredFormat

Declaration

```
int registeredFormat(string formatName)
```

Operation

Returns the format ID for the specified format name. If the named format has not already been registered, then this perm registers it.

dropDataAvailable

Declaration

```
bool dropDataAvailable(format, int type, Trigger t)
```

Operation

Returns true if dragged data is available in the specified clipboard format, which may be specified as a string registered format name, or a format ID number. The *type* argument is used to specify which media formats should be checked for.

droppedString

Declaration

```
string droppedString(format, Trigger t[, bool unicode])
```

Operation

When used in a callback function for a drop event trigger *t*, this returns any text supplied in the specified clipboard format by the data source application. The *format* argument can be either the name of a registered clipboard format (a string), or a format ID (int). If the *unicode* argument is specified and is true, and the clipboard format is a registered (i.e. non-standard) clipboard format, then the string data in the clipboard will be assumed to be in wide-char Unicode format.

droppedAttrTextAvailable

Declaration

```
bool droppedAttrTextAvailable(string attr, Trigger t)
```

Operation

When used in a callback function for a drop event trigger *t*, this function tells whether a dragged text value is available for the named DOORS Object attribute *attr* from the drag source object. Returns true when the drag source is another DOORS client, and the *attr* is an Object attribute in the drag source module whose value can be expressed as a string, and to which the current user in the source has read access.

droppedAttributeText

Declaration

```
string droppedAttributeText(string attr, Trigger t)
```

Operation

When used in a callback function for a drop event trigger *t*, if the drag source is a DOORS client this returns the text form of the named Object attribute *attr*. Returns an empty (null) string when there is no accessible text value corresponding to the named attribute.

droppedAttrRichTextAvailable

Declaration

```
bool droppedAttrRichTextAvailable(string attr, Trigger t)
```

Operation

When used in a callback function for a drop event trigger *t*, this tells whether a dragged Rich Text value (excluding OLE objects) is available for the named DOORS Object attribute *attr* from the drag source object. This returns true when the drag source is another DOORS client, and the named attribute is an Object attribute with base-type Text or String in the drag source module, and to which the current user in the source has read access.

droppedAttributeRichText

Declaration

```
string droppedAttributeRichText(string attr, Trigger t)
```

Operation

When used in a callback function for a drop event trigger *t*, this returns the Rich Text value (excluding OLE objects) of the named Object attribute *attr*, when the drag source is a DOORS client. This returns an empty (null) string when the named attribute is not of base type String or Text.

droppedAttrOLETextAvailable

Declaration

```
bool droppedAttrOLETextAvailable(string attr, Trigger t)
```

Operation

When used in a callback function for a drop event trigger *t*, this tells whether a dragged Rich Text value (including OLE objects) is available for the named DOORS Object attribute *attr* from the drag source object. This returns true when the drag source is another DOORS client, and the named attribute is an Object attribute with base-type Text in the drag source module, and to which the current user in the source has read access.

droppedAttributeOLEText

Declaration

```
string droppedAttributeOLEText(string attr, Trigger t)
```

Operation

When used in a callback function for a drop event trigger *t*, this returns the Rich Text form (including OLE objects) of the named Object attribute *attr*, when the drag source is a DOORS client. This returns an empty (null) string when the named attribute is not of base type Text.

draggedObjects

Declaration

```
Skip draggedObjects()
```

Operation

This returns a Skip list of the objects in the selection where the latest drag has begun. Its return value is only valid within the context of a drag trigger or a drop callback registered by a drag trigger.

droppedList

Declaration

```
Skip droppedList(format, Trigger t)
```

Operation

When used in a callback function for a drop event trigger *t*, this returns any list of strings supplied in the specified clipboard format by the data source application. The *format* argument can be either the name of a registered clipboard format (a string), or a format ID (int).

The data should be supplied as in the standard CF_HDROP format.

setDropString

Declaration

```
string setDropString(int fmt, Trigger t, string s [, bool unicode])
```

Operation

When used in a callback for a drag trigger *t*, or in a drop callback function registered by `createDropCallback()`, this passes the string *s* to the drop target in the specified clipboard format *fmt*, in TYMED_HGLOBAL media type. If *fmt* is a non-standard registered clipboard format and *unicode* is specified and is true, then the string data will be supplied in wide-char Unicode format.

Returns null on success, and an error string on failure.

setDropList

Declaration

```
string setDropList(int fmt, Trigger t, Skip sk)
```

Operation

When used in a callback for a drag trigger *t*, or in a drop callback function registered by `createDropCallback()`, this passes the strings in the supplied Skip list to the drop target in the specified clipboard format *fmt*, in TYMED_HGLOBAL media type, as supplied in the standard CF_HDROP clipboard format.

Returns null on success, and an error string on failure.

insertDroppedPicture

Declaration

```
bool insertDroppedPicture(Object, Trigger t, int fmt [, int type])
```

Operation

When used in a callback for a drop trigger *t*, and when the specified Object is an editable Picture object, and if picture data is available in the specified format *fmt* and *type*, then this replaces the Object's picture with the picture from the drag source.

If *type* is `TYMED_MFPICT` or *fmt* is `CF_METAFILEPICT`, then Windows Metafile data will be expected. Otherwise, if *fmt* is `CF_BITMAP` then a Device Dependent Bitmap is expected. Otherwise, a Device Independent Bitmap is expected.

The default value for *type* is `TYMED_MFPICT` for `CF_METAFILEPICT` clipboard format, and `TYMED_GDI` for `CF_BITMAP`, `CF_DIB` and all other formats.

Returns true on success, false on failure.

saveDroppedPicture

Declaration

```
bool saveDroppedPicture(Trigger t, string filename, int fmt[, int type])
```

Operation

When used in a callback for a drop trigger *t*, this saves any picture data available in the specified format *fmt* and data type *type* in the file specified by the full path *filename*.

If *type* is `TYMED_MFPICT` or *fmt* is `CF_METAFILEPICT` then Windows Metafile data will be expected. Otherwise, if *fmt* is `CF_BITMAP` then a Device Dependent Bitmap is expected. Otherwise, a Device Independent Bitmap is expected.

The default value for *type* is `TYMED_MFPICT` for `CF_METAFILEPICT` clipboard format, and `TYMED_GDI` for `CF_BITMAP`, `CF_DIB` and all other formats.

Returns true on success, false on failure.

Example

The following two examples, when run in the global context, will define drag-and-drop triggers, thus allowing some control over the dragging and dropping of data to and from DOORS clients.

Drag trigger example:

```
/*
    dragTrigger.inc
*/
// Drop callback to supply Object Text in CF_OEMTEXT format.
void dropCB(Trigger t)
{
    Object o = object(t)
    setDropString(CF_OEMTEXT, t, o."Object Text" "")
}
```

```

string formatName = "RichEdit Text and Objects"

// Test drop callback
void testCB(Trigger t)
{
    Object o = object(t)
    setDropString(registeredFormat(formatName), t, o."Object Text" "")
}

// Drag trigger: Register callbacks to set CF_OEMTEXT and CF_HDROP
//                format data.
bool preDrag(Trigger t)
{
    Object o = object(t)
    createDropCallback(CF_OEMTEXT, TYMED_HGLOBAL, dropCB, t)
    createDropCallback(registeredFormat(formatName), TYMED_HGLOBAL, testCB, t)
    return true
}

trigger(project->all->module->all->object->all, drag, 1, preDrag)

```

Drop trigger example:

```

/*
    dropTrigger.inc
*/

// Append registered format drag-drop data info to the buffer for display.
void appendData(Buffer &b, string fmtName, Trigger t, bool unicode)
{
    int tyled
    int types = 0

```

```

for (tymed = TYMED_HGLOBAL; tymed <= TYMED_ENHMF; tymed *= 2)
{
    if (dropDataAvailable(fmtName,tymed,t))
    {
        types |= tymed
    }
}
if (types > 0)
{
    int fmt = registeredFormat(fmtName)
    b += fmt " (" fmtName ", " types ") :\n"
    b += " " droppedString(fmtName,t,unicode) "\n"
}
}

void appendText(Buffer &b, string attrName, bool isSpecial, Trigger t)
{
    if (droppedAttrTextAvailable(attrName,t,isSpecial))
    {
        b += "Attribute Text: " attrName ":\n"
        b += " " droppedAttributeText(attrName,t,isSpecial) "\n"
    }
}

void appendRTF(Buffer &b, string attrName, Trigger t)
{
    if (droppedAttrRichTextAvailable(attrName,t))
    {
        b += "Attribute RichText: " attrName ":\n"
        b += " " droppedAttributeRichText(attrName,t) "\n"
    }
}

void appendOLE(Buffer &b, string attrName, Trigger t)

```

```

{
    if (droppedAttrOLETextAvailable(attrName,t)
        {
            b += "Attribute OLE Text: " attrName ":\n"
            b += " " droppedAttributeOLEText(attrName,t) "\n"
        }
    }

// Custom trigger: Displays a dialog listing available clipboard formats
// from drag and drop, and displays any string data and list data.
// Prompts the user to insert any available picture-format data if the
// module is open for edit.
bool preDrop(Trigger t)
{
    if (!confirm("Run custom trigger?"))
    {
        return true
    }
    Buffer b = create
    Object o = object(t)
    int fmt
    int types
    // Check for available data in standard clipboard formats.
    for (fmt = 1; fmt < CF_MAX; fmt++)
    {
        int tyled = TYMED_HGLOBAL
        types = 0
        for (tyled = TYMED_HGLOBAL; tyled <= TYMED_ENHMF; tyled *= 2)
        {
            if (dropDataAvailable(fmt,tyled,t)
                {
                    types |= tyled
                }
            }
        }
    }
}

```

```

if (types > 0)
{
    b += fmt " (" clipboardFormatName(fmt) ", " types ") :\n"
    if (fmt == CF_HDROP)
    {
        Skip skp = droppedList(fmt,t)
        string s
        for s in skp do
        {
            b += " - " s "\n"
        }
        delete skp
    }
    else if (fmt == CF_DIB || fmt == CF_BITMAP || fmt == CF_METAFILEPICT)
    {
        if (isEdit(module o) && confirm("Insert picture format "
clipboardFormatName(fmt) "?"))
        {
            if (formatUNKNOWN != getPictFormat(o))
            {
                // Dropping onto a picture object -
                // replace the existing picture
                insertDroppedPicture(o,t,fmt)
                refresh(module o)
            }
            else
            {
                // Not a picture object: append a new one.
                string filename = tempFileName()
                int tyled = TYMED_GDI
                int picFmt = formatBMP
                if (fmt == CF_METAFILEPICT)
                {
                    tyled = TYMED_MFPICT
                }
            }
        }
    }
}

```



```

        picFmt = formatWMF
    }
    if (saveDroppedPicture(t, filename, fmt, tamed))
    {
        insertPictureFileAfter(filename, picFmt, o)
        deleteFile(filename)
        refresh(module o)
    }
}
}
else
{
    b += " " droppedString(fmt,t) "\n"
}
}
}

if (droppedAttrTextAvailable("Object Heading",t))
{
    if (confirm("Replace Object Heading?"))
    {
        o."Object Heading" = droppedAttributeText("Object Heading",t)
    }
}

if (droppedAttrRichTextAvailable("Object Text",t))
{
    if (confirm("Replace Object Rich Text?"))
    {
        o."Object Text" = droppedAttributeRichText("Object Text",t)
    }
}

if (droppedAttrOLETextAvailable("Object Text",t))

```

```

    {
        if (confirm("Replace Object Rich Text with OLE?"))
        {
            o."Object Text" = droppedAttributeOLEText("Object Text",t)
        }
    }

    // Check for specific registered clipboard formats.
    appendData(b,"Telelogic DOORS Object URL",t,false)
    appendData(b,"RichEdit Text and Objects",t,false)
    appendText(b,"Object Heading",false,t)
    appendText(b,"Object Text",false,t)
    appendText(b,"Last Modified Time",true,t)
    appendData(b,"UniformResourceLocator",t,false)
    b += "\nonto Object " o."Absolute Number" ""

    // Display the results.
    DB thedb = create (module(o), "Dropped data")
    DBE thetext = text(thedb,"",stringOf(b),200,true)
    block thedb
    destroy thedb
    delete b
    return false
}

trigger (project->all->module->all->object->all, drop, 1, preDrop)

```

Chapter 24

Page setup functions

This chapter describes the page setup functions.

- Page attributes status
- Page dimensions
- Document attributes
- Page setup information
- Page setup management

Page attributes status

This section describes the page setup functions that return the status of a page attribute or set it. They are intended for use in exporters.

In each case there are two versions of the function that gets the status of a page attribute: one for a specific page; the other with no page specified, which operates on the current page. Similarly, there are two versions of each function that sets the status of a page attribute. The functions that get or set data for a specific page use the data type `PageLayout`.

Get page properties status

Declaration

```
bool pageChangeBars([PageLayout myPageSetup])
bool pagePortrait([PageLayout myPageSetup])
bool pageRepeatTitles([PageLayout myPageSetup])
bool pageTitlePage([PageLayout myPageSetup])
```

where:

myPageSetup Specifies a page setup

Operation

Returns `true` for the properties described below on *myPageSetup*, or if *myPageSetup* is omitted, on the current page; otherwise, it returns `false`.

<code>pageChangeBars</code>	Shows change bars
<code>pagePortrait</code>	Is portrait

<code>pageRepeatTitles</code>	Repeats titles on every page
<code>pageTitlePage</code>	Shows a title page

Set page properties status

Declaration

```
bool pageChangeBars ([PageLayout myPageSetup, ]
                    bool expression)

bool pagePortrait ([PageLayout myPageSetup, ]
                 bool expression)

bool pageRepeatTitles ([PageLayout myPageSetup, ]
                      bool expression)

bool pageTitlePage ([PageLayout myPageSetup, ]
                  bool expression)
```

where:

<i>myPageSetup</i>	Specifies a page setup
<i>expression</i>	Is an expression

Operation

Sets the properties described below on *myPageSetup*, or if *myPageSetup* is omitted, on the current page. Returns `true` if the operation succeeds; otherwise, returns `false`.

Argument expression	Evaluates true	Evaluates false
<code>pageChangeBars</code>	Shows change bars	Hides change bars
<code>pagePortrait</code>	Sets portrait	Sets landscape
<code>pageRepeatTitles</code>	Repeats titles on every page	Shows titles on first page only
<code>pageTitlePage</code>	Shows a title page	Suppresses a title page

Page dimensions

This section describes the page setup functions that return or set the size of a page dimension.

In each case there are two versions of the function that gets the size of a page dimension: one for a specific page; the other with no page specified, which operates on the current page. Similarly, there are two versions of each function that sets the size of a page dimension. The functions that get or set dimensions for a specific page use the data type `PageLayout`.

Get page dimension

Declaration

```
int pageSize([PageLayout myPageSetup])
int pageWidth([PageLayout myPageSetup])
int pageHeight([PageLayout myPageSetup])
int pageTopMargin([PageLayout myPageSetup])
int pageBottomMargin([PageLayout myPageSetup])
int pageLeftMargin([PageLayout myPageSetup])
int pageRightMargin([PageLayout myPageSetup])
```

where:

myPageSetup Specifies a page setup

Operation

Returns the size as described below on *myPageSetup*, or if *myPageSetup* is omitted, on the current page.

<code>pageSize</code>	Page size indicated by 0 (A4), 1 (A3), 2 (A5), 3 (legal), 4 (letter), 5 (custom)
<code>pageWidth</code>	Page width in mm
<code>pageHeight</code>	Page height in mm
<code>pageTopMargin</code>	Top margin in tenths of a point
<code>pageBottomMargin</code>	Bottom margin in tenths of a point
<code>pageLeftMargin</code>	Left margin in tenths of a point
<code>pageRightMargin</code>	Right margin in tenths of a point

Set page dimension

Declaration

```
bool pageSize([PageLayout myPageSetup, ]
              int dimension)
bool pageWidth([PageLayout myPageSetup, ]
              int dimension)
bool pageHeight([PageLayout myPageSetup, ]
               int dimension)
```

```

bool pageTopMargin([PageLayout myPageSetup, ]
                  int dimension)

bool pageBottomMargin([PageLayout myPageSetup, ]
                      int dimension)

bool pageLeftMargin([PageLayout myPageSetup, ]
                   int dimension)

bool pageRightMargin([PageLayout myPageSetup, ]
                    int dimension)

```

where:

<i>myPageSetup</i>	Specifies a page setup
<i>dimension</i>	Specifies a dimension

Operation

Sets the size of the dimension described below on *myPageSetup*, or if *myPageSetup* is omitted, on the current page. Returns true if the operation succeeds; otherwise, returns false.

<i>pageSize</i>	Page size indicated by 0 (A4), 1 (A3), 2 (A5), 3 (legal), 4 (letter), 5 (custom)
<i>pageHeight</i>	Page height in mm
<i>pageWidth</i>	Page width in mm
<i>pageTopMargin</i>	Top margin in tenths of a point
<i>pageBottomMargin</i>	Bottom margin in tenths of a point
<i>pageLeftMargin</i>	Left margin in tenths of a point
<i>pageRightMargin</i>	Right margin in tenths of a point

Example

```

const int paperA4 = 0,
       paperA3 = 1,
       paperA5 = 2,
       paperLegal = 3,
       paperLetter = 4,
       paperCustom = 5

if (pageSize == paperCustom) {
    // do something specific
}

```

Document attributes

This section describes the page setup functions that return or set a document attribute. These are features of a complete document rather than a page.

For `pageBreakLevel`, `pageTOCLevel` and `pageHeaderFooter`, there are two versions of the function that gets the document attribute: one for a specific page; the other with no page specified, which operates on the current page. Similarly, there are two versions of these functions that set the document attribute. The functions that get or set data for a specific page use the data type `PageLayout`. Note that a statement such as `'pageBreakLevel = 1'` is not supported.

pageBreakLevel, pageTOCLevel (get)

Declaration

```
int pageBreakLevel([PageLayout myPageSetup])
```

```
int pageTOCLevel([PageLayout myPageSetup])
```

where:

myPageSetup Specifies a page setup

Operation

Returns the document attribute as described below on *myPageSetup*, or if *myPageSetup* is omitted, on the current page.

`pageBreakLevel` Heading level at which a page break is automatically inserted

`pageTOCLevel` Lowest heading level included in table of contents

pageBreakLevel, pageTOCLevel (set)

Declaration

```
bool pageBreakLevel([PageLayout myPageSetup, ]
                    int level)
```

```
bool pageTOCLevel([PageLayout myPageSetup, ]
                  int level)
```

where:

myPageSetup Specifies a page setup

level Specifies a level

Operation

Sets the document attribute described below on *myPageSetup*, or if *myPageSetup* is omitted, on the current page. Returns `true` if the operation succeeds; otherwise, returns `false`.

<code>pageBreakLevel</code>	Heading level at which a page break is automatically inserted
<code>pageTOCLevel</code>	Lowest heading level included in table of contents

pageHeaderFooter (get)

Declaration

```
string pageHeaderFooter([PageLayout myPageSetup,
                        int fieldNumber)
```

where:

<i>myPageSetup</i>	Specifies a page setup
<i>fieldNumber</i>	Identifies a header or footer field

Operation

Returns the header or footer string defined for *myPageSetup*, or if *myPageSetup* is omitted, for the current page, as follows:

	<i>fieldNumber</i> for page type		
	body	contents	title
left header	0	6	12
center header	1	7	13
right header	2	8	14
left footer	3	9	15
center footer	4	10	16
right footer	5	11	17

pageHeaderFooter (set)

Declaration

```
bool pageHeaderFooter([PageLayout myPageSetup,
                      int fieldNumber, string s)
```

where:

<i>myPageSetup</i>	Specifies a page setup
<i>fieldNumber</i>	Identifies a header or footer field
<i>s</i>	Is the string to be placed in the specified field

Operation

Places the header or footer string in the specified field (see the `pageHeaderFooter (get)` function) on `myPageSetup`, or if `myPageSetup` is omitted, on the current page. Returns `true` if the operation succeeds; otherwise, returns `false`.

pageExpandHF

Declaration

```
string pageExpandHF(string HF,
                   string thisPage,
                   string maxPage)
```

Operation

Takes a header or footer string, *HF*, a current page number as a string, and a maximum page number as a string, and returns the string to be printed. Page numbers are passed as strings to permit roman and other numerals.

Typically, the *HF* value is returned from the `pageHeaderFooter (get)` function.

The options are:

&N	Current page number, for a contents page in Roman numerals; not available on a title page
&C	Total page count; not available for title page or contents pages
&M	Current module name
&P	Project name
&V	Current version of module
&U	Username
&D	Session date
&T	Time of printing
&A	DOORS product name
&B	DOORS product version

Example

This example prints Page 1 of 10:

```
print pageExpandHF("Page &N of &C", "1", "10")
```

Page setup information

This section describes the page setup functions that return or set specific information.

For `pageColumns`, and `pageFormat`, there are two versions of the function that gets the layout information: one for a specific page; the other with no page specified, which operates on the current page. Similarly, there are two versions of each function that sets the layout information. The functions that get or set layout information for a specific page use the data type `PageLayout`.

Setting current page setup

The assignment operator `=` can be used as shown in the following syntax:

```
current = PageLayout setup
```

Makes `setup` the current page setup, provided the user has read access to the page setup. See also, the `current (page setup)` function.

For large DXL programs, when you set the current page setup, cast the `current` on the left hand side of the assignment to the correct type. This speeds up the parsing of the DXL program, so when your program is first run, it is loaded into memory quicker. It does not affect the subsequent execution of your program. So:

```
current = newCurrentPageSetup
```

becomes

```
(current ModuleRef__) = newCurrentPageSetup
```

Note: This cast only works for assignments to `current`. It is not useful for comparisons or getting the value of the current page setup.

current (page setup)

Declaration

```
PageLayout current()
```

Operation

Returns the current page setup.

pageColumns, pageFormat (get)

Declaration

```
int pageColumns([PageLayout myPageSetup])
```

```
int pageFormat([PageLayout myPageSetup])
```

where:

myPageSetup Specifies a page setup

Operation

Returns the information described below on *myPageSetup*, or if *myPageSetup* is omitted, on the current page.

`pageColumns` Column style indicated by 0 (filled), 1 (table), 2 (not marked)

`pageFormat` Page format indicated by 0 (columns), 1 (book)

pageColumns, pageFormat (set)

Declaration

```
bool pageColumns([PageLayout myPageSetup,]
                 int style)
```

```
bool pageFormat([PageLayout myPageSetup,]
                int style)
```

where:

myPageSetup Specifies a page setup

style Specifies a style

Operation

Sets the information described below on *myPageSetup*, or if *myPageSetup* is omitted, on the current page. Returns `true` if the operation succeeds; otherwise, returns `false`.

`pageColumns` Column style indicated by 0 (filled), 1 (table), 2 (not marked)

`pageFormat` Page format indicated by 0 (columns), 1 (book)

pageTitlePage

Declaration

```
bool pageTitlePage()  
bool pageTitlePage(PageLayout)
```

Operation

These functions allow the user to get the signature page setting for either the current page layout or the specified one.

bool pageSignaturePage

Declaration

```
bool pageSignaturePage(bool)  
bool pageSignaturePage(PageLayout, bool)
```

Operation

These functions allow the user to set the signature page setting for either the current page layout or the specified one.

Page setup management

This section defines the functions that allow you to manage page setups.

create

Declaration

```
PageLayout create(string myPageSetup)
```

Operation

Creates the page setup *myPageSetup*.

delete

Declaration

```
bool delete(PageLayout myPageSetup)
```

Operation

Deletes the page setup *myPageSetup*. Returns `true` if the operation succeeds; otherwise, returns `false`.

isValidName

See “isValidName,” on page 230.

pageLayout

Declaration

```
PageLayout pageLayout (string myPageSetup)
```

Operation

Returns the page setup of *myPageSetup*.

pageName

Declaration

```
string pageName ([PageLayout myPageSetup])
```

Operation

Returns the name of the page setup *myPageSetup*, or if *myPageSetup* is omitted, of the current page.

save (page setup)

Declaration

```
bool save (PageLayout myPageSetup)
```

Operation

Saves the page setup *myPageSetup*. Returns `true` if the operation succeeds; otherwise, returns `false`.

for setup name in setups

Syntax

```
for setupName in pageSetups database do {
  ...
}
```

where:

setupName is a string variable

Operation

Assigns the string *setupName* to be each successive page setup name found in the database.

Example

```
string setupName
for setupName in pageSetups database do {
    print setupName "\n"
}
```

Chapter 25

Tables

This chapter describes the table handling functions, many of which are useful for making exporters.

- Table concept
- Table constants
- Table management
- Table manipulation
- Table attributes

Table concept

In DOORS, a table is an object hierarchy displayed in the form of a table.

The table's top level is referred to as the table header object; for each row it has a sub-object, called a row object. These row objects, in turn, have sub-objects, which are the table cells.

Table constants

You can use the column alignment constants of type `Justification` for tables. For further information, see “Column alignment constants,” on page 596.

You define table borders using constants of type `TableBorderStyle` and `TableBorderPosition`.

Declaration

```
const TableBorderStyle noborder
const TableBorderStyle solidBorder
const TableBorderStyle dottedborder
const TableBorderPosition left
const TableBorderPosition right
const TableBorderPosition top
const TableBorderPosition bottom
```

Operation

These constants are used to define tables with the `setCellBorder` and `setAllCellsBorder` functions.

Table management

This section defines the table management functions.

table (create)

Declaration

```
Object table(Module m,
             int rows,
             int cols)

Object table(Object o,
             int rows,
             int cols)

Object table(before(Object o),
             int rows,
             int cols)

Object table(below(Object o),
             int rows,
             int cols)

Object table(last(below(Object o)),
             int rows,
             int cols)
```

Operation

The first form creates a table of size *rows*, *cols* as the first object in a module.

The second form creates a table of size *rows*, *cols* at the same level and immediately after object *o*.

The third form creates a table of size *rows*, *cols* at the same level and immediately before the object *o*.

The fourth form creates a table of size *rows*, *cols* as the first child of the object *o*.

The fifth form creates a table of size *rows*, *cols* as the last child of the object *o*.

Example

```
// create as first object
Object params = table(current Module, 10, 3)

// create at same level and after object
Object analysis = table(current object, 4, 4)

// create at same level and before object
Object revisions = table(before first current,
                          noOfChanges, 3)
```



```
// create as first child
Object wordCount = table(below checkedObject,
                        noOfWords, 2)
```

table

Declaration

```
bool table(Object o)
```

Operation

Returns `true` if `o` is a table header object; otherwise, returns `false`.

Use this function in an exporter that does not handle tables.

row

Declaration

```
bool row(Object o)
```

Operation

Returns `true` if `o` is a row header object; otherwise, returns `false`.

cell

Declaration

```
bool cell(Object o)
```

Operation

Returns `true` if `o` is a table cell; otherwise, returns `false`.

tableContents (get)

Declaration

```
bool tableContents(Module m)
```

Operation

Gets the status of tables in the specified module. It returns `true` for tables shown or `false` for tables hidden.

Example

```
if (tableContents current Module &&
    table current Object) {
    dumpTable(current, outStream)
}
```

tableContents (set)

Declaration

```
void tableContents(bool expression)
```

Operation

Shows or hides tables in the current module, if *expression* evaluates to true or false, respectively.

deleteCell, deleteColumn, deleteRow, deleteTable

Declaration

```
string deleteCell(Object tableCell)
string deleteColumn(Object tableCell)
string deleteRow(Object tableCell)
string deleteTable(Object tableObj)
```

Operation

Deletes the cell, column, row, or table containing *tableCell*, which must be a table cell.

If successful, returns a null string. Otherwise, returns an error message. If the object is not a table cell, the call fails but no error is reported.

undeleteCell, undeleteColumn, undeleteRow, undeleteTable

Declaration

```
string undeleteCell(Object tableCell)
string undeleteColumn(Object tableCell)
string undeleteRow(Object tableCell)
string undeleteTable(Object tableObj)
```

Operation

Undeletes the cell, column, row, or table containing *tableCell*, which must be a table cell.

If successful, returns a null string. Otherwise, returns an error message. If the object is not a table cell, the call fails but no error is reported.

for row in table

Syntax

```
for ro in table(Object o) do {
  ...
}
```

where:

ro is a row variable of type *Object*
o is an object of type *Object*

Operation

Assigns the cell variable *ro* to be each successive table row, returning row objects, which can be passed to the `for cell` in row loop.

for cell in row

Syntax

```
for co in row(Object o) do {
  ...
}
```

where:

co Is a cell variable of type *Object*
o Is an object of type *Object*

Operation

Assigns the cell variable *co* to be each successive row cell.

This loop respects the current display set; a row is only returned if it is displayed under the current filter, level setting, and so on. Deleted rows are included when they are displayed and excluded when they are not displayed. Object numbering depends on whether deleted objects are displayed. If they are displayed, they are numbered. If they are not displayed, they are not numbered.

Example

```
Object rowHead
for rowHead in table current Object do {
  Object cell
```

```
    for cell in row rowHead do {  
        print identifier cell "\n"  
    }  
}
```

Table manipulation

This section defines functions for editing and manipulating tables.

appendCell

Declaration

```
Object appendCell(Object tableCell)
```

Operation

Appends a table cell after the given object, which must be a table cell.

If the user does not have permission to create cells, or the specified object is not a table cell, a run-time error occurs.

appendColumn (table)

Declaration

```
Object appendColumn(Object tableCell)
```

Operation

Appends a table column after the given object, which must be a table cell.

If the user does not have permission to create columns, or the specified object is not a table cell, a run-time error occurs.

appendRow

Declaration

```
Object appendRow(Object tableCell)
```

Operation

Appends a table row after the given object, which must be a table cell.

If the user does not have permission to create rows, or the specified object is not a table cell, a run-time error occurs.

insertCell

Declaration

```
Object insertCell(Object tableCell)
```

Operation

Inserts a table cell before the given object, which must be a table cell.

Example

```
Object o = current Object
if (cell o) {
    Object newCell = insertCell o
    newCell."Object Text" = "New cell"
} else {
    ack "current object is not a cell"
}
```

insertColumn (table)

Declaration

```
Object insertColumn(Object tableCell)
```

Operation

Inserts a table column before the given object, which must be a table cell.

Example

```
Object o = current Object
if (cell o) {
    Object newColumn = insertColumn o
    newColumn."Object Text" = "New column"
} else {
    ack "current object is not a column"
}
```

insertRow

Declaration

```
Object insertRow(Object tableCell)
```

Operation

Inserts a table row above the given object, which must be a table cell.

Example

```
Object o = current Object
if (cell o) {
    Object newRow = insertRow o
    newRow."Object Text" = "New row"
} else {
    ack "current object is not a row"
}
```

getTable

Declaration

```
Object getTable(Object tableCell)
```

Operation

Returns the header object of the table containing *tableCell*. This object is not visible. It is used in calls to functions that set all the cells in a table.

getRow

Declaration

```
Object getRow(Object tableCell)
```

Operation

Returns the header object of the row containing *tableCell*. This object is not visible. It is used when you want to do something to all the objects in a row.

Example

```
Object tableCell
Object rowObject = getRow(aCellIntheRow)
for tableCell in rowObject do{
    // do something to the cell
}
```

getCellAlignment

Declaration

```
Justification
getCellAlignment(Object tableObject)
```

Operation

Returns the alignment of cells in *tableObject*.

getCellWidth

Declaration

```
int getCellWidth(Object tableCell)
```

Operation

Returns the width in pixels of *tableCell*.

getCellShowChangeBars

Declaration

```
bool getCellShowChangeBars(Object tableCell)
```

Operation

If *tableCell* is set to show change bars, returns `true`; otherwise, returns `false`.

getCellShowLinkArrows

Declaration

```
bool getCellShowLinkArrows(Object tableCell)
```

Operation

If *tableCell* is set to show link arrows, returns `true`; otherwise, returns `false`.

getShowTableAcrossModule

Declaration

```
bool getShowTableAcrossModule(Object tableCell)
```

Operation

If *tableCell* is set to show the table across the module, instead of just in the main column, returns `true`; otherwise, returns `false`.

setAllCellsAlignment

Declaration

```
void  
setAllCellsAlignment(Object tableObject,  
                     Justification alignment)
```

Operation

Sets all cells alignment within *tableObject* to have *alignment*. The *tableObject* argument must be the object returned by a call to the *getTable* function.

setAllCellsBorder

Declaration

```
void setAllCellsBorder(Object tableObject,  
                      TableBorderPosition edge,  
                      TableBorderStyle style)
```

Operation

Sets all specified border edges within *tableObject* to have the specified style.

setAllCellsShowChangeBars

Declaration

```
void  
setAllCellsShowChangeBars (Object tableObject,  
                           bool show)
```

Operation

If *show* is true, sets the all the cells in *tableObject* to show change bars. Otherwise, sets all the cells to hide change bars. The *tableObject* argument must be the object returned by a call to the *getTable* function.

setAllCellsShowLinkArrows

Declaration

```
void  
setAllCellsShowLinkArrows (Object tableObject,  
                           bool show)
```

Operation

If *show* is `true`, sets the all the cells in *tableObject* to show link arrows. Otherwise, sets all the cells to hide link arrows. The *tableObject* argument must be the object returned by a call to the `getTable` function.

setAllCellsWidth

Declaration

```
void setAllCellsWidth(Object tableObject,
                     int width)
```

Operation

Sets all the cells in *tableObject* to have *width* in pixels. The *tableObject* argument must be the object returned by a call to the `getTable` function.

setCellAlignment

Declaration

```
void setCellAlignment(Object tableCell,
                     Justification alignment)
```

Operation

Sets cell alignment within *tableCell* to have *alignment*.

setCellBorder

Declaration

```
void setCellBorder(Object tableCell,
                  TableBorderPosition edge
                  TableBorderStyle style)
```

Operation

Sets the specified border edge to the specified style on the given cell.

setCellShowChangeBars

Declaration

```
void setCellShowChangeBars(Object tableCell,
                           bool show)
```

Operation

If *show* is `true`, sets the cell containing *tableCell* to show change bars. Otherwise, sets the cell to hide change bars.

setCellShowLinkArrows

Declaration

```
void setCellShowLinkArrows(Object tableCell,
                           bool show)
```

Operation

If *show* is true, sets the cell containing *tableCell* to show link arrows. Otherwise, sets the cell to hide link arrows.

setCellWidth

Declaration

```
void setCellWidth(Object tableCell,
                  int width)
```

Operation

Sets the cell containing *tableCell* to have *width* in pixels.

setColumnAlignment

Declaration

```
void setColumnAlignment(Object tableCell,
                        Justification alignment)
```

Operation

Sets the column containing *tableCell* to have *alignment*.

setColumnShowChangeBars

Declaration

```
void setColumnShowChangeBars(Object tableCell,
                              bool show)
```

Operation

If *show* is true, sets the column containing *tableCell* to show change bars. Otherwise, sets the column to hide change bars.

setColumnShowLinkArrows

Declaration

```
void setColumnShowLinkArrows(Object tableCell,
                              bool show)
```

Operation

If *show* is true, sets the column containing *tableCell* to show link arrows. Otherwise, sets the column to hide link arrows.

setColumnWidth

Declaration

```
void setColumnWidth(Object tableCell,
                    int width)
```

Operation

Sets the column containing *tableCell* to have *width* in pixels.

setRowWidth

Declaration

```
void setRowWidth(Object tableCell,
                 int width)
```

Operation

Sets the row containing *tableCell* to have *width* in pixels.

setShowTableAcrossModule

Declaration

```
void setShowTableAcrossModule(Object tableCell,
                              bool showTable)
```

Operation

If *showTable* is true, sets the table containing *tableCell* to show the table across the module, instead of just in the main column. Otherwise, sets the table not to show across the module.

toTable

Declaration

```
void toTable(Object header)
```

Operation

Converts a three-level object hierarchy into a table. For DOORS versions prior to 4.0, which used a tree structure to store tables, this function converts tables into DOORS native tables.

Example

This loop function detects objects that have been imported from an imaginary format called XYZ as DOORS 3.0 tables, and converts them into DOORS native tables.

```
Object o = first current Module
while (!null o) {
    string importType = o."XYZ Type"
    if (!table o) {
        if (importType == "Table") {
            toTable o
            o = next sibling o
        } else {
            o = next o
        }
    }
}
```

Table attributes

This section defines the functions which deal with the attributes shown in tables.

useDefaultTableAttribute

Declaration

```
bool useDefaultTableAttribute(ViewDef vd)
void useDefaultTableAttribute(ViewDef vd, bool setting)
```

Operation

The first form returns true if the default table attribute is being used in the given view, otherwise it returns false. The second form turns the use of the default table attribute in the given view on or off.

enableDefaultTableAttribute

Declaration

```
void enableDefaultTableAttribute (bool setting)
bool enableDefaultTableAttribute (Module)
```

Operation

The first form enables or disables the ability to specify a default table attribute in the current module. The second form returns true if the use of a default table attribute is enabled in the given module, otherwise it returns false.

overrideTableAttribute

Declaration

```
void overrideTableAttribute (bool setting)
bool overrideTableAttribute (Module)
```

Operation

The first form sets a flag indicating that the specified default attribute for the current module should override the display attribute for all tables in the module. Setting this value will have no effect if the Default Table Attribute option is not enabled. The second form returns true if the Override Table Attribute option is enabled in the given module, otherwise it returns false.

defaultTableAttribute

Declaration

```
void defaultTableAttribute (string AttrName)
string defaultTableAttribute (Module)
```

Operation

The first form sets the default table cell attribute on the current module. If the name provided is not a valid attribute name, then the default “Main Column” will be displayed. Setting this value will have no effect if the Default Table Attribute option is not enabled. The second form returns the name of the Default Table Attribute for the given module.

Example

```
//This example re-saves the current view having set the default table attribute
//to be the Object Heading, with some verification along the way.
string curViewName = currentView (current Module)
View curView = view curViewName
ViewDef vd = get curView
```

```
string MyDefTableAttr = "Object Heading"

if (!enableDefaultTableAttribute (current Module)){
    enableDefaultTableAttribute (true)
}

defaultTableAttribute (MyDefTableAttr)

if (defaultTableAttribute (current Module) != MyDefTableAttr){
    print "An error occurred setting the default table attribute.\n"
} else {
    useDefaultTableAttribute (vd, true)

    if (!useDefaultTableAttribute (vd)){
        print "An error occurred while activating the default table attribute on
the current view."
    } else {
        save (curView, vd)
    }
}
```

Chapter 26

Rich text

This chapter describes the functions that allow manipulation of rich text.

- Rich text processing
- Rich text strings
- Enhanced character support
- Importing rich text
- Diagnostic perms

Rich text processing

This section gives the syntax for operators, functions and a `for` loop, which can be used to process rich text. These elements use internal data types, so declarations are not stated.

A rich text string contains sections of formatting, referred to as **chunks**. Each chunk can be processed using the core `for` loop that performs the decomposition. Chunks are processed as variables of type `RichText`, from which different properties can be extracted.

These decomposition functions are particularly valuable for implementing exporters that have to generate formatting information.

Rich text tags

The following tags can be used in DXL code to create rich text strings:

<code>\b</code>	bold text
<code>\i</code>	italic text
<code>\ul</code>	underlined text
<code>\strike</code>	struck through text
<code>\sub</code>	subscript text
<code>\super</code>	superscript text
<code>\nosubersub</code>	neither subscript nor superscript

The syntax for using these tags within a string is as follows:

```
{tag<space>text}
```

or

```
{tag{text}}
```

Tags can be nested, to apply more than one type of formatting, as follows:

```
{tag<space>text{tag<space>text}}
```

Note: Remember that the back-slash character (\) must be escaped with another back-slash character in a string.

Rich text constructors

The dot operator (.) is used to extract information from rich text chunks.

Syntax

```
richString.richTextProperty
```

where:

richString Is a chunk of rich text of type RichText

richTextProperty Is one of the properties described below

Operation

The properties act on the chunk of rich text as follows:

String property	Extracts
<code>text</code>	The text of a chunk of rich text as a string without formatting

Boolean property	Extracts
<code>bold</code>	Whether the chunk of rich text has bold formatting
<code>last</code>	Whether the chunk of rich text is the last in the string
<code>italic</code>	Whether the chunk of rich text has italic formatting
<code>newline</code>	Whether the chunk of rich text is immediately followed by a newline character
<code>strikethru</code>	Whether the chunk of rich text has strike through formatting
<code>subscript</code>	Whether the chunk of rich text has subscript formatting

Boolean property	Extracts
<code>superscript</code>	Whether the chunk of rich text that has superscript formatting
<code>underline</code>	Whether the chunk of rich text that has underline formatting

For examples, see the `for rich text in string` loop.

`richText (column)`

Declaration

```
string richText(Column c,
                Object o)
```

Operation

Returns the text contained in column `c` for the object `o` as rich text.

`richTextWithOle (column)`

Declaration

```
string richTextWithOle(Column c, Object o)
```

Operation

Returns the text contained in column `c` for the object `o` as rich text, including OLE objects.

`richTextNoOle (column)`

Declaration

```
string richTextNoOle(Column c, Object o)
```

Operation

Returns the text contained in column `c` for the object `o` as rich text, excluding OLE objects.

`removeUnlistedRichText`

Declaration

```
string removeUnlistedRichText(string s)
```

Operation

Removes rich text markup that DOORS does not recognize. Fonts are preserved when importing Word or RTF documents. Fonts can be specified by inserting a symbol from a specific font.

Example

This example prints `{\b bold text}` in the DXL Interaction window's output pane:

```
string s = "{\\b \\unknown bold text}"
print removeUnlistedRichText s
```

for rich text in string

Syntax

```
for rt in string s do {
  ...
}
```

where:

<code>rt</code>	is a variable of type <code>RichText</code>
<code>s</code>	is a string containing rich text

Operation

Assigns the rich text variable `rt` to be each successive chunk of formatting in a rich text string, returning each as a pointer to a structure of type `RichText`. This structure can tell you whether a piece of text is bold, italic, underlined, struck through, subscript, superscript, or at the end of a line.

Example

```
string s = "{\\b Bold}{\\i Italic}DXL"
RichText rt
for rt in s do {
  if (rt.italic) print rt.text " is italic\n"
  else
    if (rt.bold) print rt.text " is bold\n"
    else print rt.text " is neither\n"
}
```

This example prints:

```
  Bold is bold
  Italic is italic
  DXL is neither
```

RichTextParagraph type properties

Properties are defined for use with the `.` (dot) operator and a `RichTextParagraph` type handle to extract information from a `RichTextParagraph` type, as shown in the following syntax:

Syntax

```
for <RichTextParagraph> in <string> do
```

Operation

Loops through the rich text paragraph `RichTextParagraph` in the string `string`.

The following tables list the properties and the information they extract:

Integer property	Extracts
<code>indentLevel</code>	The indent level of the paragraph. The units are twips (= 1/20 point or 1/1440 inch). Currently the base unit of indentation in DOORS is 360 twips, so values of <code>indentLevel</code> will be multiples of 360.
<code>bulletStyle</code>	The bullet style, as an integer. Currently the only values are 0 (no bullets) and 1 (bullets).

Boolean property	Extracts
<code>isBullet</code>	Whether the paragraph has a bullet point.

String property	Extracts
<code>text</code>	The plain text of the paragraph.

Example

```
void dumpParagraphs(string s)
{
    RichTextParagraph rp

    for rp in s do {
        print "****New paragraph\n"
        print "text:" rp.text ":\n "
        print "indent:" rp.indentLevel ": "
        print "bullet:" rp.isBullet ": "
        print "bulletStyle:" rp.bulletStyle ":\n"
    }
}
```

```
Object o = current
string s = richText o."Object text"
dumpParagraphs s
```

RichText type properties

Properties are defined for use with the `.` (dot) operator and a `RichText` type handle to extract information from a `RichText` type, as shown in the following syntax:

Syntax

```
for <RichText> in <RichTextParagraph> do
```

Operation

Loops through the rich text chunks *RichText* in the `RichTextParagraph` *RichTextParagraph*.

The following tables list the properties and the information they extract:

Integer property	Extracts
<code>indentLevel</code>	The indent level of the rich text chunk. The units are twips (= 1/20 point or 1/1440 inch). Currently the base unit of indentation in DOORS 6.0 is 360 twips, so values of <code>indentLevel</code> will be multiples of 360. The value will remain the same for all chunks in a line.
<code>bulletStyle</code>	The bullet style, as an integer. Currently the only values are 0 (no bullets) and 1 (bullets). The value will remain the same for all chunks in a line.

Boolean property	Extracts
<code>isBullet</code>	Whether the paragraph has a bullet point. The value will remain the same for all chunks in a line.
<code>isUrl</code>	Whether the rich text chunk is a URL.
<code>isOle</code>	Whether the rich text chunk represents an OLE object.

EmbeddedOleObject property	Extracts
<code>getEmbeddedOle</code>	The embedded OLE object represented by the chunk.

Example

```

void dumpAllInfo(RichText rt)
{
    print "*****New chunk:\n"
    print "text:" rt.text ": "
    print "bold:" rt.bold ": "
    print "italic:" rt.italic ": "
    print "underline:" rt.underline ":\n"
    print "strikethru:" rt.strikethru ": "
    print "superscript:" rt.superscript ": "
    print "subscript:" rt.subscript ": "
    print "charset:" rt.charset ":\n"
    print "newline:" rt.newline ": "
    print "last:" rt.last ":\n"
// new in 6.0
    print "isOle:" rt.isOle ": "
    print "indent:" rt.indentLevel ": "
    print "bullet:" rt.isBullet ": "
    print "bulletStyle:" rt.bulletStyle ": "
    print "isUrl:" rt.isUrl ":\n"
}

void dumpAllParagraphs(string s)
{
    RichTextParagraph rp
    RichText rt

    for rp in s do {
        print "****New paragraph\n"
        print "text:" rp.text ":\n "
        print "indent:" rp.indentLevel ": "
        print "bullet:" rp.isBullet ":\n"
        print "bulletStyle:" rp.bulletStyle ":\n"
        for rt in rp do
        {
            dumpAllInfo rt
        }
    }
}

Object o = current
string s = richTextWithOle o."Object text"

dumpAllParagraphs s

```

Rich text strings

This section defines an operator and functions for strings containing rich text.

Assignment (rich text)

The equals operator (=) is used to assign rich text format to attributes, as follows:

Syntax

```
attrRef = richText(string s)
```

where *attrRef* can be one of:

```
(Object o). (string attrName)
```

```
(Module m). (string attrName)
```

```
(Link l). (string attrName)
```

where:

<i>o</i>	is an object of type Object
<i>m</i>	is a module of type Module
<i>l</i>	is a link of type Link
<i>attrName</i>	is a string identifying the attribute

Operation

Sets the attribute called *attrName* to the rich text string contained in *s*.

Example

```
Object o = current
```

```
o. "Object Text" = richText "{\\b BOLD}"
```

```
o. "Object Heading" = "{\\b BOLD}"
```

This sets:

- The current object's text to **BOLD**
- The current object's heading to `{\\b BOLD}` which is displayed as `{\b bold}`

This demonstrates the importance of using the `richText` function in both getting and setting attribute values if you wish to maintain the rich text content. If you do not process the string value with `richText`, all the markup is escaped with backslashes and becomes apparent to the user.

cutRichText

Declaration

```
string cutRichText(string s,
                  int start,
                  int end,)
```

Operation

Returns the string *s* with the displayed characters from *start* to *end* removed. For the purposes of counting characters, rich text markup is ignored, and markup is preserved.

Example

```
cutRichText("{\\b 0123456}", 1, 3)
```

This example returns: `{\\b 0456}`

findRichText

Declaration

```
bool findRichText(string s,
                 string sub,
                 int& offset,
                 int& length,
                 bool matchCase)
```

Operation

Returns `true` if string *s* contains the substring *sub*.

If *matchCase* is `true`, string *s* must contain string *sub* exactly with matching case; otherwise, any case matches.

The function returns additional information in *offset* and *length*. The value of *offset* is the number of characters in *s* to the start of the first match with string *sub*. The value of *length* contains the number of characters in the matching string. The function `replaceRichText` uses *offset* and *length* to replace the matched string with another string.

Example

```
string s = "{\\b This is Bo{\\i ld and italic}"}"
string sub = "bold"
int offset
int len
```

```

if (findRichText(s, sub, offset, len, false)) {
    print "Offset = " offset "\n"
    print "Length = " len "\n"
} else {
    print "Failed to match"
}

```

This example prints:

```
Offset = 12
```

```
Length = 8
```

because the braces are delimiters, not characters in the string.

isRichText

Declaration

```
bool isRichText(string s)
```

Operation

Returns `true` if string `s` is in the DOORS rich text format; otherwise, returns `false`.

If `false` is returned, `s` cannot be used to set any object attribute value.

Example

This example prints `true` in the DXL Interaction window's output pane:

```
print isRichText "{\\i correct balance}"
```

This example prints `false` in the DXL Interaction window's output pane:

```
isRichText "{\\b missing bracket}"
```

replaceRichText

Declaration

```
string replaceRichText(string s,
                       int offset,
                       int length,
                       string r)
```

Operation

Returns a string, which is equivalent to `s` but with the characters between `offset` and `offset+length` replaced with `r`, whilst retaining formatting tags.

Example

```
RichText rt
```

```
string s = "{\\b This is Bo{\\i ld and italic}"
```



```
string r = "bOLD"
string result = replaceRichText(s, 12, 8, r)
print result "\n"
Prints:
{\b This is bO{\i LD and italic}}
```

richtext_identifier(Object)

Declaration

```
string richtext_identifier(Object o)
```

Operation

Returns the object identifier (which is a combination of module prefix and object absno) as an RTF string.

Example

```
Object o = current
print richtext_identifier(o)
```

pasteToEditbox

Declaration

```
bool pasteToEditbox()
```

Operation

Pastes the contents of the clipboard into a module object that is ready for in-place editing. If the paste fails, the function returns `false`.

Example

This example pastes bold text to an open module:

```
setRichClip richText "{\\b bold text}"
pasteToEditbox
```

richClip

This function has the following syntax:

```
richClip()
```

Gets the rich text contents of the system clipboard as a rich text string.

Example

```
o."Object Text" = richClip
```

setRichClip

Declaration

```
void setRichClip(richText(string s)
                [,string styleName])
```

Operation

Sets the system clipboard to contain the rich text string *s*. Optionally, you can include a minimal RTF style sheet that contains a supplied style name, which sets the string style.

Example

```
setRichClip richText o."Object Text"
// with style sheet
setRichClip(richText o."Object Heading,
            "Heading 1")
```

setRichClip (Buffer/RTF_string__)

Declaration

```
void setRichClip(RTF_string__ s, string styleName, string fontTable)
void setRichClip(Buffer buff, string styleName, string fontTable)
void setRichClip(RTF_string__ s, string styleName, string fontTable, bool
keepBullets, bool keepIndents)
void setRichClip(Buffer buff, string styleName, string fontTable, bool
keepBullets, bool keepIndents)
```

Operation

First form sets the system clipboard with the rich text obtained by applying the style *styleName* to the string *s*, using the font table *fontTable* supplied, which should include a default font. Font numbers in the string *s* will be translated to the supplied font table *fontTable*.

Second form is same as the first but the source is a buffer *buff* rather than an RTF_string__.

Third form sets the system clipboard with the rich text obtained by applying the style *styleName* to the string *s*, using the font table *fontTable* supplied. If *keepBullets* is false, any bullet characters are removed from string *s*. If *keepIndents* is false, any indentation is removed from string *s*. If *keepBullets* and *keepIndents* are both true, the behavior is exactly the same as the first form.

Fourth form is same as the third but the source is a buffer *buff* other than an RTF_string__.

Example 1

The following code:

```
string s = "hello"
```

```
string fontTable = "\\deff0{\\fonttbl {\\f1 Times New Roman;}}"
setRichClip(richText s, "Normal", fontTable)
```

puts the following rich text string onto the system clipboard:

```
{\rtf1 \deff0{\\fonttbl {\\f1 Times New Roman;}}{\stylesheet {\\s1 Normal;}}{\\s1
hello\par}}
```

Example 2

```
string bulletedString =
"{\\rtf1\\ansi\\ansicpg1252\\deff0\\deflang1033{\\fonttbl{\\f0\\fswiss\\fcharse
t0 Arial;}{\\f1\\fnil\\fcharset2 Symbol;}}
\\viewkind4\\uc1\\pard\\f0\\fs20 Some text with\\par
\\pard{\\pntext\\f1\\'B7\\tab}{\\*\\pn\\pnlvlblt\\pnf1\\pnindent0{\\pntxtb\\'B7
}}\\fi-720\\li720 bullet 1\\par
{\\pntext\\f1\\'B7\\tab}bullet 2\\par
\\pard bullet points in it.\\par
\\par
}"
```

```
string fontTable = "\\deff0{\\fonttbl{\\f0\\fswiss\\fcharset0
Arial;}{\\f1\\fnil\\fcharset2 Symbol;}}"
```

```
setRichClip(richText bulletedString, "Normal", fontTable)
```

```
// the previous call puts
```

```
// "{\\rtf1 \deff0{\\fonttbl{\\f0\\fswiss\\fcharset0 Arial;}{\\f1\\fnil\\fcharset2
Symbol;}}{\stylesheet {\\s1 Normal;}}{\\s1 Some text with\\par {\\f1\\'b7\\tab}bullet
1\\par {\\f1\\'b7\\tab}bullet 2\\par bullet points in it.\\par \\par}}"
```

```
// on the clipboard
```

```
setRichClip(richText bulletedString, "Normal", fontTable, false, false)
```

```
// the previous call puts
```

```
// "{\\rtf1 \deff0{\\fonttbl{\\f0\\fswiss\\fcharset0 Arial;}{\\f1\\fnil\\fcharset2
Symbol;}}{\stylesheet {\\s1 Normal;}}{\\s1 Some text with\\par bullet 1\\par bullet
2\\par bullet points in it.\\par \\par}}"
```

```
// on the clipboard -- note no bullet symbols (\\'b7) in the markup
```

rtfSubString

Declaration

```
Buffer rtfSubString(Buffer input, Buffer output, int start, int end)
```

Operation

This function takes an RTF buffer and returns the RTF sub-string between the defined start and end points.

Variable	Description
<i>input</i>	The complete RTF text. This can be full RTF or an RTF fragment, but must be valid RTF and not plain text.
<i>output</i>	The buffer in which the sub-string will be returned. This buffer must be created before calling <code>rtfSubString</code> . This return value will always be full RTF. A reference to this buffer is the return value of the function.
<i>start</i>	The zero-based start point of the sub-string.
<i>end</i>	The end point of the sub-string.

Example

```
Object o = current
Buffer input = create
Buffer output = create
input = o."Object Text"
rtfSubString(input, output, 4, 8)
print stringOf(output)
```

richText (of attribute)

Declaration

```
string richText(attrRef
                [,bool includeFontTable])
```

where *attrRef* can be one of:

```
(Object o).(string attrName)
```

```
(Module m).(string attrName)
```

```
(Link l).(string attrName)
```

where:

o is an object of type `Object`

m is a module of type `Module`
l is a link of type `Link`
attrName is a string identifying the attribute

Operation

Returns the rich text version of an attribute called *attrName*, if *includeFontTable* is `false`, or not present.

If the boolean argument is `true`, it returns the rich text version of an attribute value appended to the font table for that module. This preserves the meaning of font markup when moving rich text attribute values between modules.

Example

```
print richText (current Object) . "Object Text"
```

If the `Object` text attribute of the current object is **Engine**:

```
{\b Engine }
```

```
Module oldm, newm
```

```
Object oldo, newo
```

```
oldo = first oldm
```

```
newo = create newm
```

```
newo."Object Text" = richText(oldo."Object Text", true)
```

richText (of string)

Declaration

```
string richText(string s)
```

Operation

Returns a string, which is the correct rich text version of string *s*. It inserts a backslash escape character before unescaped braces and unescaped backslashes. This makes it suitable for assignment to attribute values.

Example

```
print richText "{ \\hello }"
```

Prints:

```
"\{ \\hello \}"
```

stringOf (rich text)

Declaration

```
string stringOf(richText(string s))
```

Operation

Allows access to rich text as a string.

richTextWithOle

Declaration

```
string richTextWithOle (Attr__ attr)
```

Operation

Returns the rich text of attribute *attr*, including the OLE objects. The use of this perm should be confined to copying rich text values from one attribute to another.

richTextNoOle

Declaration

```
string richTextNoOle (Attr__ attr)
```

Operation

Returns the rich text of attribute *attr*, excluding the OLE objects. The use of this perm should be confined to copying rich text values from one attribute to another.

applyTextFormattingToParagraph

Declaration

```
string applyTextFormattingToParagraph (string s, bool addBullets, int indentLevel, int paraNumber)
```

Operation

Applies bullet and/or indent style to the given text, overwriting any existing bulleting/indenting.

- If *addBullets* is true, adds bullet style.
- If *indentLevel* is nonzero, adds indenting to the value of *indentLevel*. The units for *indentLevel* are twips = twentieths of a point.
- If *paraNumber* is zero, the formatting is applied to all the text. Otherwise it is only applied to the specified paragraph number.

The input string *s* must be rich text. For example, from `string s = richText o."Object Text"`.

Returns a rich text string which describes the text with the formatting applied.

Example

```
Object o = current
string s = o."Object text"
```

```
o."Object text" = richText (applyTextFormattingToParagraph(richText
s,true,0,0))
```

Adds bullet style to all of the current object's text.

exportRTFString

Declaration

```
string exportRTFString (string text)
```

Operation

Translates a DOORS rich text string to the RTF standard. Newlines are converted into \par tags, not \newline.

Example

```
Object o = current
string str = o."Object Text"
string rtf_string = exportRTFString(str)
```

richTextFragment

Declaration

```
string richTextFragment(string richString)
string richTextFragment(string richString, string fontTable)
    string richTextFragment(string richText [, string fontTable [, bool
    inTable]])
```

Operation

The first form takes an argument *richFrag* which should be a rich text string. Returns an equivalent representation of the rich text with RTF header information removed. Useful for building up a real RTF string without having to cope with the header information every time. Font markup will be mapped to the DOORS default font table.

The second form is the same as the first except for the second argument, *fontTable*, which is a font table string. Any font markup in the string is mapped to the first font in the font table passed in which has the same character set as the original markup.

The third form has an optional boolean argument which, if provided and set to `true`, ensures that the returned rich text string is valid as contents of a rich text table. Use this setting if multiple paragraphs are exported to a single table cell and the resulting rich text output is to be opened by MS-Word 2000.

Example 1

```
string richString =
"{\rtf1\ansi\ansicpg1252\deflang1033
{\fonttbl{\f0\fnil\prq1\charset0 Times New Roman;}
{\f1\froman\prq2\charset2 Symbol;}}
```

```

{\\colortbl ;\\red0\\green0\\blue0;}
\\viewkind4\\uc1\\pard\\cf1\\f0\\fs20
Some plain text.
\\b Some bold text.\\b0
  \\b\\i Some bold and italic text. \\b0\\i0
A symbol \\f1 a\\f0 (alpha).\\b\\i\\par }"

print richTextFragment richString

// returns

// Some plain text. \\b Some bold text.\\b0  \\b \\i Some bold and italic text.
\\b0 \\i0 A symbol \\{\\f1001 a}\\{\\f1007 (alpha).\\}

```

Example 2

```

string fontTable =
"\\deff1{\\fonttbl
{\\f0\\fswiss\\fcharset0 Arial;}
{\\f1\\froman\\fprq2\\fcharset0 Times New Roman;}
{\\f2\\froman\\fprq2\\fcharset2 Symbol;}}"

print richTextFragment( richString, fontTable)

// returns

// Some plain text. \\b Some bold text.\\b0  \\b \\i Some bold and italic text.
\\b0 \\i0 A symbol \\{\\f2 a}\\{\\f0 (alpha).\\}

```

Enhanced character support

This section lists constants and defines functions for the display and printing of characters outside the ANSI character set.

Character set constants

For the display and printing of characters outside the ANSI character set, you can specify another character set. For the results to be correct, you must have the appropriate fonts installed. The following integer character set constants are declared:

```
charsetAnsi
charsetSymbol
charsetGreek
charsetRussian
charsetEastEurope
charsetTurkish
charsetHebrew
```

Certain UNIX machines may not display some characters correctly.

For an example of the use of character set constants, see "Character set identification" below.

Character set identification

The dot operator (.) is used to identify the character set of rich text, as follows:

Syntax

```
richString.charset()
```

where:

richString is a chunk of rich text of type RichText

Operation

Returns the character set of a chunk of rich text.

Example

```
for rt in s do {
  if (rt.charset == charsetAnsi) {
    print rt.text " is in the ANSI character
      set\n"
  } else if (rt.charset == charsetSymbol) {
    print rt.text " is in the Symbol character
      set\n"
  } else {
    print rt.text " is in character set number
      " rt.charset "\n"
  }
}
```

charsetDefault

Declaration

```
int charsetDefault()
```

Operation

Returns the system default character set. On UNIX platforms, this is always `charsetAnsi`. On Windows systems, this is the user's local setting.

Example

```
string s
RichText rt
for rt in s do {
    if (rt.charset == charsetAnsi) {
        print rt.text " is in the ANSI character
            set\n"
    } else if (rt.charset == charsetSymbol) {
        print rt.text " is in the Symbol character
            set\n"
    } else {
        print rt.text " is in the character set
            number " rt.charset "\n"
    }
    if (rt.charset == charsetDefault) {
        print rt.text " is in your system default
            character set\n"
    }
}
```

characterSet

Declaration

```
void characterSet(DBE canvas,
                 int level,
                 int mode,
                 int characterSet)
```

Operation

Sets the level, mode and character set for drawing strings on the canvas. Through the font tables, this sets the font.

Example

```
DB symbolBox = create "Symbols"
```

```

void repaint(DBE symbol) {
    int fsize = 1 // level 1 size
    int mode = 0 // body text style

    background(symbol,
                logicalPageBackgroundColor)

    color(symbol, logicalDataTextColor)

    characterSet(symbol, fsize, mode,
                 charsetAnsi)

    draw(symbol, 10, 20, "abc")
    // appears as abc

    characterSet(symbol, fsize, mode,
                 charsetSymbol)

    draw(symbol, 40, 20, "abc")
    // appears as alpha beta chi
}

DBE symbol = canvas(symbolBox, 100, 50, repaint)
show symbolBox

```

fontTable

Declaration

```
string fontTable(Module m)
```

Operation

Returns the module's font table, which is used for mapping rich text font markup to character set information.

Example

```
print fontTable current Module
```

In a newly created module, the DOORS default font table is:

```

{\f1012\fswiss\fcharset177 Arial;}{\f1011\fswiss\fcharset162
Arial;}{\f1010\fswiss\fcharset238 Arial;}{\f1009\fswiss\fcharset204
Arial;}{\f1008\fswiss\fcharset161 Arial;}{\f1007\fswiss\fcharset0
Arial;}{\f1006\froman\fcharset177 Times New
Roman;}{\f1005\froman\fcharset162 Times New
Roman;}{\f1004\froman\fcharset238 Times New
Roman;}{\f1003\froman\fcharset204 Times New
Roman;}{\f1002\froman\fcharset161 Times New Roman;}{\f1001\fttech\fcharset2
Symbol;}{\f1000\froman\fcharset0 Times New Roman;}

```

Importing rich text

This section defines a function for importing rich text.

importRTF

Declaration

```
int importRTF(string file,
              Module m,
              bool mapStyles,
              bool dynamicUpdate)
```

Operation

Imports a rich text format file into the current object of module *m*.

Example

```
if (importRTF("c:\\doors\\examples\\parse.rtf",
             current Module, false, false) == 0)
    print "Successful\n"
} else {
    print "Failed\n"
}
```

Diagnostic perms

These perms are for run-time richText/OLE DXL diagnostics. DXL scripts written for pre-V6 DOORS do not specify whether OLE objects should be included in richText extracted from Object Text attributes or the main column in a view. If diagnostics are enabled, the user can be given warnings when this occurs, enabling the user to replace the richText () call with richTextWithOle () or richTextNoOle (). The user can also be warned when a new value is assigned to an Object Text attribute, as this will now replace any OLE objects in the Object Text.

enableObjectTextAssignmentWarnings

Declaration

```
enableObjectTextAssignmentWarnings(string logFile)
```

Operation

Enables warnings whenever a new value is assigned to an Object Text attribute. Warnings are disabled by default. This perm returns no value. The *logFile* argument allows the user to specify a file where filenames and line numbers will be logged, where warnings are issued. If this argument is null, no logging is done. If the file cannot be opened, a warning message is displayed. If a log file has already been opened, this argument has no effect.

disableObjectTextAssignmentWarnings

Declaration

```
disableObjectTextAssignmentWarnings()
```

Operation

Disables warnings whenever a new value is assigned to an Object Text attribute. Warnings are disabled by default. This perm returns no value.

enableObjectTextRichTextWarnings

Declaration

```
enableObjectTextRichTextWarnings(string logFile)
```

Operation

Enables warnings whenever the *richText (Attribute)* perm is applied to an Object Text attribute, or the *richText (Column, Object)* perm is applied to the Main column. The *logFile* argument is treated the same way as that for *enableObjectTextAssignmentWarnings()*. If a *logFile* has already been opened, this argument has no effect.

This perm returns no value.

disableObjectTextRichTextWarnings

Declaration

```
disableObjectTextRichTextWarnings()
```

Operation

Disables warnings when the *richText (Attribute)* perm is applied to an Object Text attribute, or the *richText (Column, Object)* perm is applied to the Main column. If *enableGeneralRichTextWarnings()* has been called, warnings will still be issued for all *richText()* perms, until *disableGeneralRichTextWarnings()* is called.

This perm returns no value.

enableGeneralRichTextWarnings

Declaration

```
enableGeneralRichTextWarnings(string logFile)
```

Operation

Enables warnings whenever the `richText (Attribute)` or `richText (Column, Object)` perm is called. The `logFile` argument is treated the same way as for the other `enable` perms above. This perm returns no value.

disableGeneralRichTextWarnings

Declaration

```
disableGeneralRichTextWarnings()
```

Operation

Normally disables warnings whenever the `richText (Attribute)` or `richText (Column, Object)` perm is called. The exception to this is if `enableObjectTextRichTextWarnings()` has been called, warnings will still be issued when these `richText` perms are applied to Object Text or the Main column. This perm returns no value.

enableRepeatWarnings

Declaration

```
enableRepeatWarnings()
```

Operation

Enables multiple repeated warnings to be issued for the same DXL script file/line-number combination, whenever that code is executed by the interpreter. By default, only one warning is issued for any file/line in any one DOORS client session. This perm returns no value.

disableRepeatWarnings

Declaration

```
disableRepeatWarnings()
```

Operation

This perm negates the effect of `enableRepeatWarnings()`. It returns no value. Note that the repeat prevention does not apply to DXL scripts run from the DXL Interaction window.

disableDisplayWarnings

Declaration

```
disableDisplayWarnings ()
```

Operation

Disables the pop-up warning dialogs. If enabled, warnings are still logged in the specified `logFile`. This perm returns no value.

enableDisplayWarnings

Declaration

```
enableDisplayWarnings ()
```

Operation

Enables pop-up warning dialogs. It returns no value.

dxlWarningFilename

Declaration

```
string dxlWarningFilename ()
```

Operation

Returns the filename quoted in the last pop-up warning dialog.

dxlWarningLineNumber

Declaration

```
int dxlWarningLineNumber ()
```

Operation

Returns the line number quoted in the last pop-up warning dialog.

Chapter 27

Spelling Checker

This chapter describes the following features of the spelling checker:

- Constants and general functions
- Language and Grammar
- Spelling Dictionary
- Miscellaneous Spelling
- Spelling\Dictionary Examples

Constants and general functions

Language Constants

Operation

The following are used to specify one of the standard supported languages:

`USEnglish`

`UKEnglish`

`French`

`German`

`GermanReform`

Example

```
SpellingOptions options
```

```
getOptions(options, userSpellingOptions)
```

```
setLanguage(options, German)
```

```
saveOptions(options)
```

Options Constants

Operation

The following are used by the `getOptions` function to specify which set of spelling options are to be opened:

`databaseSpellingOptions`

```
userSpellingOptions
```

Example

```
SpellingOptions options
getOptions(options, databaseSpellingOptions)
```

Dictionary Constants

Operation

The following are used by the open function to indicate which type of dictionary is to be opened:

```
databaseDictionary
clientDictionary
```

Example

```
Dictionary d
open(d, clientDictionary)
insert(d, "Telelogic")
```

Grammar Constants

Operation

The following are used to define the formality of grammar checking:

```
informalGrammar
standardGrammar
formalGrammar
```

Example

```
SpellingOptions options
getOptions(options, userSpellingOptions)
setGrammarLevel(options, informalGrammar)
saveOptions(options)
```

Spell Check Mode Constants

Operation

The following are used to define the level of spell checking to be carried out:

```
spellingOnly
```

```
quickProof
```

```
fullProof
```

Example

```
SpellingOptions options
```

```
getOptions(options, userSpellingOptions)
```

```
setCheckMode(options, quickProof)
```

spell

Declaration

```
string spell(string word)
```

```
string spell(Object o,
              string attrName,
              int &start,
              int &end)
```

Operation

The first form checks the word for spelling, and returns a null string if it is correct or if *word* is a null string. If the spelling is not correct, returns an error message.

The second form checks the attribute name for spelling, and returns a null string if it is correct, if *attrName* is a null string, or if the specified attribute is not contained in the specified object. If the spelling is not correct, returns an error message. It only works with string or text attributes.

The *start* and *finish* arguments must be initialized to *zero* before the function is called. If the contents of *attrName* are misspelled, the function sets the values of *start* and *finish* to identify the first and last characters of the incorrectly spelled substring.

Example

```
Object o = current
```

```
// check status
```

```
if (o != null)
```

```
{
```

```
    int iStart = 0, iFinish = 0
```

```
    // get attribute info
```

```
    string sObjectHeading = probeRichAttr_(o,
                                           "Object Heading")
```

```
    int iLength = length(sObjectHeading)
```

```
    // process attribute
```

```
    while (iStart < iLength)
```

```
    {
```

```
        // check attribute
```

```

    if (spell(o, "Object Heading", iStart,
              iFinish) != null)
    {
        // warn user
        print "Spelling mistake located ["
              iStart ":" iFinish "] - '"
              sObjectHeading[iStart:iFinish] "'\n"
        // adjust accordingly
        iStart = iFinish
    }
}

```

spellFix

Declaration

```

string spell(Object o,
              string attrName,
              int &start,
              int &end,
              string newString)

```

Operation

Replaces a misspelled string within the specified attribute, which must be a string or text attribute. The string is identified using *start* and *finish*, provided the `spell` function has previously been called on the object and attribute.

In cases where the new string is a different length from the misspelled substring, the function resets the values of *start* and *finish*.

Returns a null string if it the substring is replaced successfully or if the specified attribute is not contained in the specified object. Otherwise, returns an error message.

alternative

Declaration

```

string alternative(int n)

```

Operation

Returns the *n*th spelling for the word last passed to `spell`.

alternatives

Declaration

```

int alternatives()

```

Operation

Returns the number of options found for the last call to `spell`.

for all spellings

Syntax

```
for s in alternatives do {
    ...
}
```

where:

`s` is a string variable

Operation

Assigns string `s` to be each successive value found for the last spelling check.

Example

```
string mess = spell("whta")
if (null mess) {
    print "You are a spelling bee\n"
} else {
    int n = alternatives
    print "There are " n " other spellings:\n"
        string altSpelling
    for altSpelling in alternatives do
        print altSpelling "\n"
}
```

spell

Declaration

```
Buffer spell(Buffer returnBuffer, Buffer word)
```

```
Buffer spell(Buffer returnBuffer, Object o, string attribute, int &wordStart,
int &wordEnd, int &sentenceStart, int &sentenceEnd, int &ruleType, bool
spellingErrorsFirst, bool &deletionError)
```

Operation

First form of the `spell` perm that returns a buffer `returnBuffer`, to reduce memory usage caused by using strings. The perm returns an empty Buffer if the `word` is correct, or an error message otherwise.

- `returnBuffer`
Buffer used to create the return value - must be created before calling.
- `word`

The word to be checked.

The second form of this perm checks spelling and grammar in the named attribute *attribute* of the specified object *o*. If an error is found, the error details returned in the parameters relate to the first error. Call `getNextError()` to view subsequent error details.

Variable	Description
<i>returnBuffer</i>	Buffer used to create the return value - must be created before calling.
<i>o</i>	The object to be checked.
<i>attribute</i>	Name of the specific attribute to be checked.
<i>wordStart</i>	If an error is found, returns the start position of the incorrect word in the attribute text.
<i>wordEnd</i>	If an error is found, returns the end position of the incorrect word.
<i>sentenceStart</i>	If an error is found, returns the start position of the sentence containing the error.
<i>sentenceEnd</i>	If an error is found, returns the end position of the sentence containing the error.
<i>ruleType</i>	If an error is found, returns the code of the rule that triggered the error.
<i>spellingErrorsFirst</i>	Specifies whether spelling errors should be reported before grammar errors - note that this operates at a sentence level.
<i>deletionError</i>	If an error is found, this flag indicates that the error type recommends that text is deleted (e.g. this will occur when a word is duplicated, such as "This is an error.")

getNextError

Declaration

```
void getNextError(Buffer errorString, int &wordStart, int &wordEnd, int
&sentenceStart, int &sentenceEnd, bool &correctionComplete, bool skipSentence,
int &ruleType, bool &deletionError)
```

Operation

Returns errors found after a call to `spell(Buffer, Object, string, int, int, int, int, int, bool, bool)`. Note that this perm does not return errors found after calling any other variant of the spell perm.

Variable	Description
<i>returnBuffer</i>	If an error is found, the description will be placed in this buffer - must be created before calling.

Variable	Description
<i>wordStart</i>	If an error is found, returns the start position of the incorrect word in the attribute text.
<i>wordEnd</i>	If an error is found, returns the end position of the incorrect word.
<i>sentenceStart</i>	If an error is found, returns the start position of the sentence containing the error.
<i>sentenceEnd</i>	If an error is found, returns the end position of the sentence containing the error.
<i>correctionComplete</i>	This flag will be returned <code>true</code> if no more errors were found.
<i>skipSentence</i>	Set this flag when calling to ignore any remaining errors in the current sentence.
<i>ruleType</i>	If an error is found, returns the code of the rule that triggered the error.
<i>deletionError</i>	If an error is found, this flag indicates that the error type recommends that text is deleted.

SpellingErrors__

Declaration

```
SpellingErrors__ spellingErrors()
```

Operation

Structure encapsulating information about spelling and grammatical errors.

for SpellingError in SpellingErrors__

Declaration

```
for SpellingError in SpellingErrors__
```

Operation

Loop to iterate over errors found after calling the `spell(Buffer, Object, string, int&, int&, int&, int&, int&, bool, bool&)` perm. Note that this loop does not list errors found after calling any other variant of the `spell` perm.

getErrorString

Declaration

```
Buffer getErrorString(Buffer returnBuffer, SpellingError spellErr)
```

Operation

Returns a description for the specified error *spellErr*. The *returnBuffer* parameter must be created before calling.

getErrorStartPos(SpellingError)

Declaration

```
int getErrorStartPos(SpellingError spellErr)
```

Operation

Used inside the 'for error in spellingErrors do' loop. Returns the position of the start of the spelling/grammatical error relative to the start of the object.

getErrorStopPos(SpellingError)

Declaration

```
int getErrorStopPos(SpellingError spellErr)
```

Operation

Used inside the 'for error in spellingErrors do' loop. Returns the position of the last character of the spelling/grammatical error relative to the start of the object.

getSentenceStartPos(SpellingError)

Declaration

```
int getSentenceStartPos(SpellingError spellErr)
```

Operation

Used inside the 'for error in spellingErrors do' loop. Returns the position of the first character in the sentence containing the spelling/grammatical error relative to the start of the object.

getSentenceStopPos(SpellingError)

Declaration

```
int getSentenceStopPos(SpellingError spellErr)
```

Operation

Used inside the 'for error in spellingErrors do' loop. Used inside the 'for error in spellingErrors do' loop. Returns the position of the last character in the sentence containing the spelling/grammatical error relative to the start of the object.

getCorrectionComplete(SpellingError)

Declaration

```
bool getCorrectionComplete(SpellingError spellErr)
```

Operation

Used inside the 'for error in spellingErrors do' loop. Returns true if the spell check is complete otherwise false.

ignoreWord

Declaration

```
void ignoreWord(string word)
```

Operation

Causes the specified *word* to be ignored if it is found to be incorrect during spell checking. The *word* is ignored until `resetSpellingState` is called.

for Buffer in SpellingAlternatives__

Declaration

```
for b in spellAlt do {
    ...
}
```

where:

<i>b</i>	is a variable of type Buffer
<i>spellAlt</i>	is a variable of type SpellingAlternatives__

Operation

A loop to iterate through alternative words found after a spelling error. Alternative words are returned in a Buffer object, but note that the user should not create or destroy the Buffer.

alternative

Declaration

```
Buffer alternative(Buffer returnBuffer, int index)
```

Operation

Returns the alternative word at the specified index position, after a spelling error. The *returnBuffer* parameter must be created before calling. An error will be reported if the *index* is out of range.

Language and Grammar

Languages__

Declaration

```
Languages__ languages ()
```

Operation

Type to iterate through `spLanguageInfo`

Language

Declaration

```
Language lang
```

Operation

Type to encapsulate details of available language databases.

spGetLanguages

Declaration

```
int spGetLanguages ()
```

Operation

Fills the list of available languages. This will be a list of those languages that are supported by the spell checker and whose language database is present on the local client. Returns the number of available languages.

for Language in Languages__

Declaration

```
for Language in Languages__
```

Operation

Iterates through the specified Languages.

getLanguage

Declaration

```
Language getLanguage(int index)
```

Operation

Returns the `spLanguageInfo` structure for the language at the specified `index` in the list of available languages. If the `index` value is outwith the range of available languages, an error report is generated.

getId

Declaration

```
int getId(Language lang)
```

Operation

Returns the ID of the specified language `lang`. (e.g. "English", "German").

getName

Declaration

```
string getName(Language lang)
```

Operation

Returns a string identifying the specified language `lang`. (e.g. "UK English", "German").

isSupported

Declaration

```
bool isSupported(Language lang)
```

Operation

Returns a boolean indicating if the specified language `lang` is officially supported by DOORS. At present, this covers US English, UK English, French and German (pre- and post-Reform).

getGrammarRules

Declaration

```
int getGrammarRules(SpellOptions &spellOptions, GrammarRules &gramRules)
```

Operation

Gets a list of active grammar rules for the specified options set *spellOpt*, returning the number of active rules *&gramRules*. Active rules are determined by the current language and grammar strictness level.

The `GrammarRules` parameter must be initialized to 'null' before calling.

getName

Declaration

```
Buffer getName(GrammarRules &gramRules, int index, Buffer buf)
```

Operation

Returns the short name of the grammar rule at the position specified by the *index* parameter in the set of grammar rules *&gramRules*. If the value of *index* is greater than the number of active rules, an error report is generated. The *buf* parameter is a Buffer that is used to create the return value; it must be created by the user before calling and deleted afterwards.

getExplanation

Declaration

```
string getExplanation(GrammarRules &gramRules, int index, Buffer buf)
```

Operation

Returns a full explanation of the grammar rule at the position specified by the *index* parameter in the set of grammar rules *&gramRules*. If the value of *index* is greater than the number of active rules, an error report is generated. The *buf* parameter is a Buffer that is used to create the return value; it must be created by the user before calling and deleted afterwards.

getOptions

Structure encapsulating spell checker options.

Declaration

```
string getOptions(SpellingOptions &spellOptions, int optionsSet)
```

Operation

Gets set of spelling options. The *optionsSet* parameter indicates which set of options to load. At present this is limited to the database-wide default settings (defined by `spDatabaseOptions` with a value of 0) and the user's personal setting (`spUserOptions` with a value of 1). Any other value will return a failure message. Where a user's settings have not yet been configured, the database default values will be returned. An error string is returned if there is a problem reading the options files, but in this case the `SpellingOptions` parameter will contain standard defaults.

save(SpellingOptions)

Declaration

```
string save(SpellingOptions &spellOptions)
```

Operation

Saves the spelling options.

If the options was loaded as the database defaults, the user must have sufficient access rights to modify database settings, otherwise the function will return an error string.

getLanguage

Declaration

```
int getLanguage(SpellingOptions &spellOptions)
```

Operation

Returns the ID of the spelling checking language defined in the SpellingOptions parameter.

setLanguage

Declaration

```
string setLanguage(SpellingOptions &spellOptions, int languageId)
```

Operation

Sets the spell checking language in the specified set of SpellingOptions. If the *languageId* is invalid, the function will return an error string.

getEnglishOptions

Declaration

```
string getEnglishOptions(SpellingOptions &spellOptions, bool &legalLexicon,  
bool &financialLexicon)
```

Operation

Returns boolean values indicating the state of options specific to US and UK English. Returns error string if the parameters are missing from the options set.

setEnglishOptions

Declaration

```
string setEnglishOptions(SpellingOptions &spellOptions, bool &legalLexicon,  
bool &financialLexicon)
```

Operation

Sets a boolean value indicating the state of options specific to US and UK English. These can be modified if a language other than English is selected.

getUKOptions

Declaration

```
string getUKOptions(SpellingOptions &spellOptions, bool &izeEndings)
```

Operation

Returns a boolean value indicating the state of an option specific to UK English.

setUKOptions

Declaration

```
string setUKOptions(SpellingOptions spellOptions, bool izeEndings)
```

Operation

Sets a boolean value indicating the state of an option specific to UK English. This option can be set even if a language other than UK English is selected.

getFrenchOptions

Declaration

```
string getFrenchOptions(SpellingOptions &spellOptions, bool &openLigature, bool  
&accentedUpperCase)
```

Operation

Gets boolean values indicating the state of options specific to French.

setFrenchOptions

Declaration

```
string setFrenchOptions(SpellingOptions &spellOptions, bool &openLigature, bool &accentedUpperCase)
```

Operation

Sets boolean values indicating the state of options specific to French. These options can be set even if a language other than French is selected.

getGermanOptions

Declaration

```
string getGermanOptions(SpellingOptions &spellOptions, bool &scharfes)
```

Operation

Gets boolean values indicating the state of options specific to German.

setGermanOptions

Declaration

```
string setGermanOptions(SpellingOptions &spellOptions, bool &sharfes)
```

Operation

Sets boolean values indicating the state of options specific to German. These options can be set even if a language other than German is selected.

getGreekOptions

Declaration

```
string getGreekOptions(SpellingOptions, bool& accentedUpperCase)
```

Operation

Gets boolean values indicating the state of options specific to Greek.

setGreekOptions

Declaration

```
string setGreekOptions(SpellingOptions, bool accentedUpperCase)
```

Operation

Sets boolean values indicating the state of options specific to Greek. These options can be set even if a language other than Greek is selected.

getSpanishOptions

Declaration

```
string getSpanishOptions(SpellingOptions, bool& accentedUpperCase)
```

Operation

Gets boolean values indicating the state of options specific to Spanish.

setSpanishOptions

Declaration

```
string setSpanishOptions(SpellingOptions, bool accentedUpperCase)
```

Operation

Sets boolean values indicating the state of options specific to Spanish. These options can be set even if a language other than Spanish is selected.

getCatalanOptions

Declaration

```
string getCatalanOptions(SpellingOptions, bool& periodMode)
```

Operation

Gets boolean values indicating the state of options specific to Catalan.

setCatalanOptions

Declaration

```
string setCatalanOptions(SpellingOptions, bool periodMode)
```

Operation

Sets boolean values indicating the state of options specific to Catalan. These options can be set even if a language other than Catalan is selected.

getRussianOptions

Declaration

```
string getRussianOptions(SpellingOptions, bool& joMode)
```

Operation

Gets boolean values indicating the state of options specific to Russian.

setRussianOptions

Declaration

```
string setRussianOptions(SpellingOptions, bool joMode)
```

Operation

Sets boolean values indicating the state of options specific to Russian. These options can be set even if a language other than Russian is selected.

getGrammarLevel

Declaration

```
int getGrammarLevel(SpellingOptions &spellOptions)
```

Operation

Returns an integer value indicating the strictness of grammar checking.

setGrammarLevel

Declaration

```
string setGrammarLevel(SpellingOptions &spellOptions, int grammar)
```

Operation

Sets an integer value indicating the strictness of grammar checking. Returns an error string if the grammar level is invalid, or if the user does not have sufficient rights to modify settings.

setSpellingCheckingMode

Declaration

```
string setSpellingCheckingMode(int spellMode)
```

Operation

Sets the mode for spell checking - the parameter is a value indicating spelling only, quick proof, or full proof modes. Returns an error string if the mode value is invalid or the user does not have sufficient rights to modify settings.

getSpellingCheckingMode

Declaration

```
int getSpellingCheckingMode()
```

Operation

Returns a value indicating the current spell checking mode.

getSpellingFirst

Declaration

```
bool getSpellingFirst(SpellOptions &spellOptions)
```

Operation

Returns a flag indicating if spelling errors are to be returned before grammar errors in the specified options set.

setSpellingFirst

Declaration

```
string setSpellingFirst(SpellOptions &spellOptions, bool errors)
```

Operation

Sets a flag indicating if spelling errors are to be returned before grammar errors in the specified options set. Returns an error string if the user does not have sufficient rights to modify settings.

getIgnoreReadOnly

Declaration

```
bool getIgnoreReadOnly(SpellOptions &spellOptions)
```

Operation

Returns a flag indicating if objects that are read only are to be ignored (i.e. not checked) in the specified options set.

setIgnoreReadOnly

Declaration

```
string setIgnoreReadOnly(SpellOptions &spellOptions, bool read)
```

Operation

Sets a flag indicating if objects that are read only are to be ignored (i.e. not checked) in the specified options set. Returns an error string if the user does not have sufficient rights to modify settings.

Spelling Dictionary

Dictionary

A new type to represent a dictionary, including its type (database or client) and contents. A variable of this type should be initialized to null before opening the dictionary.

open(Dictionary)

Declaration

```
string open(Dictionary &dict, int dictionaryType)
```

```
string open(Dictionary &dict, int languageId, int dictionaryType)
```

Operation

The first form opens a client or database dictionary for the language defined in the current user's spelling options. The Dictionary parameter should be initialized to null before calling this function. Returns a string indicating failure, or null if successful. A dictionary must be opened to make its contents available to the spell checker.

Note that there is an upper limit on the number of dictionaries that can be opened at any one time, so it is important that the dictionary is explicitly closed using `spCloseDictionary` after use.

This function will load the dictionary ACL if the dictionary type is set to `spDatabaseDictionary`.

The second form opens a client or database dictionary for the language specified. This opens a temporary dictionary for management functions (such as adding and removing words), and the contents of this dictionary will not be used in normal spell checking. The Dictionary parameter should be initialized to null before calling this function. Returns a string indicating failure, or null if successful.

It is important that the dictionary is explicitly closed using `spCloseDictionary` after use.

This function will load the dictionary ACL if the dictionary type is set to `spDatabaseDictionary`.

close(Dictionary)

Declaration

```
string close(Dictionary &dict, bool saveContents)
string close(Dictionary &dict, bool saveContents, bool saveACL)
```

Operation

The first form closes the specified dictionary. If the *saveContents* parameter is `true`, and the user has sufficient permissions, the contents of the dictionary will be saved. This function will not save any changes to the dictionary access control list. Note that this function resets the dictionary parameter to 'null'.

The second form closes the specified dictionary. If the *saveContents* parameter is `true`, and the user has sufficient permissions, the contents of the dictionary will be saved. If the *saveACL* parameter is `true`, and the dictionary type was Database dictionary, and the user has sufficient permissions, the dictionary access control list will be saved. Note that this function resets the dictionary parameter to 'null'.

alternativeWord

Declaration

```
alternativeWord
```

Operation

Structure to encapsulate a word and its suggested alternative.

for Buffer in Dictionary

Declaration

```
for b in &dict do {
    ...
}
```

where:

b is a variable of type `Buffer`

&dict is a variable of type `Dictionary`

Operation

Iterator over the words in a dictionary. The user does not need to create the `Buffer` before the loop; the user should not delete the `Buffer` inside or after the loop.

for alternativeWord in Dictionary

Declaration

```
for altWord in &dict do {
    ...
}
```

where:

altWord is a variable of type alternativeWord
&dict is a variable of type Dictionary

Operation

Iterator over the alternative words in a dictionary.

getWord

Declaration

```
Buffer getWord(alternativeWord altWord, Buffer b)
```

Operation

Returns the word component of an spAltWord structure. The *b* parameter is used to create the return value and should be created before calling and deleted afterwards.

getAlternative

Declaration

```
Buffer getAlternative(alternativeWord altWord, Buffer b)
```

Operation

Returns the alternative word component of an spAltWord structure. The *b* parameter is used to create the return value and should be created before calling and deleted afterwards.

insert

Declaration

```
string insert(Dictionary &dict, string word, string alternative)
```

Operation

Adds a word and a preferred alternative word to the specified dictionary.

Returns an error string if the user does not have sufficient rights to modify the dictionary.

remove

Declaration

```
string remove(Dictionary &dict, string word)
```

Operation

Removes a *word* from the specified dictionary.

Returns an error string if the user does not have sufficient rights to modify the dictionary.

isDatabaseDict

Declaration

```
bool isDatabaseDict(Dictionary &dict)
```

Operation

Returns a flag indicating whether the specified dictionary is a database dictionary (`true`) or client dictionary (`false`).

Miscellaneous Spelling

anagram

Declaration

```
bool anagram(string word, int minLength)
```

Operation

Gets up to a maximum of twenty anagrams of the specified *word*, with the specified minimum length.

Returns a flag indicating if any anagrams were found.

Anagrams are accessed by the same method as getting spelling alternatives.

Example

```
if (anagram("word", 2))  
{  
    string s
```

```

    for s in alternatives do
    {
    print s "\n"
    }
}

```

wildcard

Declaration

```
bool wildcard(string pattern)
```

Gets up to a maximum of twenty wildcards based on the specified *pattern*. The *pattern* string, a '?' matches a single letter, and "*" matches zero or more letters.

Returns a flag indicating if any wildcard matches were found.

Wildcard matches are accessed by the same method as getting spelling alternatives.

Example

```

if (wildcard("w?a*d"))
{
    string s
    for s in alternatives do
    {
        print s "\n"
    }
}

```

Spelling\Dictionary Examples

Example 1

```
//Check single word and show corrections
```

```

string result
result = spell("helo")
if (!null result)
{

```

```

print result "\n"
Buffer suggestion
for suggestion in alternatives do
{
    print stringOf(suggestion) "\n"
}
}

```

Example 2

```
//Open dictionary and show contents
```

```

Dictionary dict
if (null open(dict, databaseDictionary))
{
    print "Words\n"
    Buffer word
    for word in dict do
    {
        print stringOf(word) "\n"
    }

    print "\n"
    AlternativeWord altWord
    Buffer wordBuffer = create
    for altWord in dict do
    {
        print stringOf(getWord(altWord, wordBuffer) )
        print " -> "
        print stringOf(getAlternative(altWord, wordBuffer)) "\n"
    }
    delete wordBuffer
    print close(dict, true)
}

```

Example 3

```
//List names of available languages

Language language
if (getLanguages > 0)
{
    for language in languages do
    {
        print getName(language) "\n"
    }
}
```

Example 4

```
//Open user's spell settings and show current language
SpellingOptions options
getOptions(options, userSpellingOptions)
// get the user's current language
int languageId = getLanguage(options)
// get the details for this language
Language language = getLanguage(languageId)

print getName(language) "\n"
// set the language to French and save the options
print setLanguage(options, French)
print saveOptions(options)
```

Example 5

```
//Show grammar options and active rules
SpellingOptions options
getOptions(options, userSpellingOptions)
int grammarLevel = getGrammarLevel(options)
int checkingMode = getCheckMode(options)

if (grammarLevel == formalGrammar)
    print "Formal \n"
else if (grammarLevel == standardGrammar)
```

```
    print "Standard \n"
else
    print "Informal \n"
if (checkingMode == spellingOnly)
    print "Spelling Only\n"
else if (checkingMode == quickProof)
    print "Quick Proof \n"
else
    print "Full Proof \n"
GrammarRules rules = null
int numRules = getGrammarRules(options, rules)
int index
Buffer ruleName = create
for (index = 0; index < numRules; index++)
{
    print stringOf(getName(rules, index, ruleName)) "\n"
}
delete ruleName
```

Chapter 28

Database Integrity Checker

This chapter describes:

- Database Integrity Types
- Database Integrity Perms

Database Integrity Types

IntegrityResultsData

This type is a handle to an object that is created and returned by the `checkDatabaseIntegrity` perm (see below), and which contains the results of the integrity check.

IntegrityCheckItem

This type is contained in an ordered list in the `IntegrityResultsData` object. Each item in the list corresponds to the start or completion of the checking of a folder, or a discovered inconsistency (problem) with the data integrity.

IntegrityProblem

This type is contained in a list in the `IntegrityResultsData` object. Each item corresponds to a problematical reference to a hierarchy `Item` by one folder in the hierarchy, or, in the case of orphaned items, to an item that is not referenced by any folder.

ProblemItem

This type is contained in a list in the `IntegrityResultsData` object. Each item corresponds to a hierarchy `Item` that has one or more `IntegrityProblem` records associated with it.

IntegrityItemType

This enumerated type is returned by the `type (IntegrityCheckItem)` and `type (IntegrityProblem)` perms, to identify the meaning of each item.

Both perms can return the following values:

- `referencesInvalidFolder`
- `referencesValidFolder`
- `noDataFound`
- `orphanedItem`.
- `invalidProjectListEntry`
- `missingProjectListEntry`

In addition, the type (`IntegrityCheckItem`) perm can return the following values:

- `startedCheck`
- `completedCheck`
- `failedCheck`

Database Integrity Perms

The Database Integrity functionality is only accessible to Administrator users. For any other user, the `checkDatabaseIntegrity` perm (see below) returns null, without performing any database integrity checks.

In general, the following perms generate run-time DXL errors when passed null arguments.

`checkDatabaseIntegrity(Folder, IntegrityResultsData&)`

Declaration

```
string checkDatabaseIntegrity(Folder orphansFolder, IntegrityResultsData&
results)
```

Operation

Performs an integrity check on the database, and returns the results in an `IntegrityResultsData` object. Parent/child references are checked for consistency, the database project list is checked for missing items, and the database file system is scanned for orphaned items (data that has become detached from the folder hierarchy, and is therefore no longer accessible to DOORS clients), and these items are placed in the specified orphans folder.

The perm returns null on success, and an error string on failure.

Passing a null argument to this perm causes a run-time error.

Note that the value of the `Folder` argument may be changed by the checking process.

For any user other than Administrator, this perm will not perform any checking, and will return an error string and set results to null.

checkFolderIntegrity(Folder&, IntegrityResultsData& , bool)

Declaration

```
string checkFolderIntegrity(Folder& f, IntegrityResultsData& results, bool
recurse)
```

Operation

Performs a parent/child reference consistency check on the contents of the specified *folder*, checks for a missing entry in the global project list if the *folder* is a Project, and puts the results in the *IntegrityResultsData* object. If the *recurse* argument is *true*, it performs the same check on all descendants of the folder.

This perm is restricted to Administrator users. Error conditions are handled as by the *checkDatabaseIntegrity* perm.

canceled/cancelled(IntegrityResultsData)

Declaration

```
bool canceled/cancelled(IntegrityResultsData results)
```

Operation

Returns *true* if the integrity check was cancelled by the user pressing the cancel button on the progress bar.

for IntegrityCheckItem in IntegrityResultsData

Declaration

```
for integchkitem in integresdata
```

Operation

This iterator returns the *IntegrityCheckItem* objects in the order in which they were created during the integrity check. Information from these objects can then be used to compile a report of the integrity check.

for ProblemItem in IntegrityResultsData

Declaration

```
for probitem in integresdata
```

Operation

This iterator returns an object for each hierarchy item *probitem* for which one or more problems are found.

for IntegrityProblem in ProblemItem

Declaration

```
for integprob in probitem
```

Operation

This iterator returns an object for each problem found for the same item.

for IntegrityProblem in IntegrityResultsData

Declaration

```
for integprob in integresdata
```

Operation

This returns all `IntegrityProblem` objects in the `IntegrityResultsData` object. These are grouped by unique ID.

uniqueID(IntegrityCheckItem)

Declaration

```
string uniqueID(IntegrityCheckItem integchkitem)
```

Operation

This returns the index of the item to which the `IntegrityCheckItem` applies. For `Started/Failed/CompletedCheck` items, it refers to the folder whose contents are being checked. For others, it refers to the item in the folder that exhibits a problem.

uniqueID(IntegrityProblem)

Declaration

```
string uniqueID(IntegrityProblem integprob)
```

Operation

This returns the index of the item that exhibits the problem.

uniqueID(ProblemItem)

Declaration

```
string uniqueID(ProblemItem probitem)
```

Operation

This returns the index of the problem item *problem*.

problems(IntegrityResultsData, string)

Declaration

```
ProblemItem problems(IntegrityResultsData integresdata, string uniqueID)
```

Operation

This is the converse of the unique ID perm above, returning the *ProblemItem* for a given index. It returns null if no problems are listed in the *IntegrityResultsData* variable for the given Item index.

timestamp(IntegrityCheckItem)

Declaration

```
Date timestamp(IntegrityCheckItem integchkitem)
```

Operation

This returns the timestamp (date and time) indicating when the *IntegrityCheckItem* was generated.

folder(IntegrityProblem)

Declaration

```
Folder folder(IntegrityProblem integprob)
```

Operation

Returns the parent folder that contains the problematical reference. It returns null for orphaned items.

type(IntegrityCheckItem)

Declaration

```
IntegrityItemType type(IntegrityCheckItem integchkitem)
```

Operation

Can return any one of the following values:

- referencesInvalidFolder
- referencesValidFolder
- noDataFound
- orphanedItem

- `invalidProjectListEntry`
- `missingProjectListEntry`
- `startedCheck`
- `completedCheck`
- `failedCheck`

type(IntegrityProblem)

Declaration

`IntegrityItemType type(IntegrityProblem integprob)`

Operation

Can return any one of the following values:

- `referencesInvalidFolder`
- `referencesValidFolder`
- `noDataFound`
- `orphanedItem`.
- `invalidProjectListEntry`
- `missingProjectListEntry`

type(ProblemItem)

Declaration

`IntegrityItemType type(ProblemItem probitem)`

Operation

Returns the type of the first problem associated with the specified item *probitem*. It can return any one of the following values:

- `referencesInvalidFolder`
- `referencesValidFolder`
- `noDataFound`
- `orphanedItem`
- `invalidProjectListEntry`
- `missingProjectListEntry`

text(IntegrityCheckItem)

Declaration

```
string text(IntegrityCheckItem integchkitem)
```

Operation

Returns the error message string (if any) for the given IntegrityCheckItem.

parentRefID(IntegrityProblem | ProblemItem)

Declaration

```
string parentRefID(IntegrityProblem integprob| ProblemItem probitem)
```

Operation

Returns the index of the parent referenced by the problem item's data.

parentRef(IntegrityProblem | ProblemItem)

Declaration

```
Folder parentRef(IntegrityProblem integprob| ProblemItem probitem)
```

Operation

Returns the folder that the problem item references as its parent, if the folder exists.

setParent(ProblemItem, Folder)

Declaration

```
string setParent(ProblemItem probitem, Folder f)
```

Operation

Sets the parent of the item referenced by the ProblemItem to the specified folder, removing all references in any other folders that are known to list the item in their contents (other parent folders associated with IntegrityProblems for the same ProblemItem). The perm returns null on success, and an error string on failure. If the specified Folder does not already contain a reference to the item, then a reference is added. The affected IntegrityProblems are marked as repaired (see below).

If the ProblemItem type is noDataFound, then the Folder argument can be null, in which case all folder entries are removed. If the ProblemItem type is noDataFound and the folder argument is not null, new data is created if the item is a Project or Folder.

addProjectEntry(ProblemItem)

Declaration

```
string addProjectEntry(ProblemItem probitem)
```

Operation

If the `ProblemItem` includes a "missingProjectListEntry" problem, this perm adds the missing entry in the global project list. On successful completion, it marks any `missingProjectListEntry` problems for the `ProblemItem` as repaired, and returns null. On failure, it returns an error message.

If the entry name matches an existing entry (project), or a top-level folder in the database, then the project is renamed by appending a space and a decimal integer (defaulting to 1, but incremented as required to achieve uniqueness).

convertToFolder(ProblemItem)

Declaration

```
string convertToFolder(ProblemItem probitem)
```

Operation

If the `ProblemItem` includes a `missingProjectListEntry` problem, this perm converts the referenced Project to a Folder. In the case of duplicate references to the item, this is done for all known references. On successful completion, the perm marks the affected `IntegrityProblems` as repaired, and returns null. On failure, it returns an error message.

repaired(IntegrityProblem)

Declaration

```
bool repaired(IntegrityProblem integprob)
```

Operation

Returns `true` if the problem described by the specified `IntegrityProblem` has been repaired by the `setParent` perm.

repaired(ProblemItem)

Declaration

```
bool repaired(ProblemItem probitem)
```

Operation

Returns `true` if all of the problems associated with the specified `IntegrityProblem` have been repaired by the `setParent` perm.

delete(IntegrityResultsData&)

Declaration

```
string delete(IntegrityResultsData& integresdata)
```

Operation

Deletes the `IntegrityResultsData` object and sets its value to null.

checkItem(IntegrityProblem)

Declaration

```
IntegrityCheckItem checkItem(IntegrityProblem integprob)
```

Operation

Returns an `IntegrityCheckItem` reference, for the given `IntegrityProblem`. The returned value can be passed to any perm or function taking an `IntegrityCheckItem` argument.

everSectioned

Declaration

```
bool everSectioned({ModName_|ModuleVersion})
```

Operation

Reports whether or not the specified `ModName_` or `ModuleVersion` shows evidence that the module was ever save with shareable sections. If a supplied `ModuleVersion` references a baseline, rather than a current version, false will be returned.

Chapter 29

Discussions

This chapter describes features that operate on DOORS discussions:

- Discussion Types
- Properties
- Iterators
- Operations
- Triggers
- Example

Discussion Types

Discussion

Represents a discussion.

Comment

Represents a comment in a discussion.

DiscussionStatus

Represents the status of a discussion. The possible values are `Open` and `Closed`.

Properties

The following tables describe the properties available for the `Discussion` and `Comment` types. Property values can be accessed using the `.` (dot) operator, as shown in the following syntax:

variable.property

where:

variable is a variable of type `Discussion` or `Comment`

property is one of the discussion or comment properties

Discussion

Property	Type	Extracts
<code>status</code>	<code>DiscussionStatus</code>	The status of the discussion: whether it is open or closed.
<code>summary</code>	<code>string</code>	The summary text of the discussion, which may be null
<code>createdBy</code>	<code>User</code>	The user who created the discussion, if it was created in the current database. Otherwise it returns null.
<code>createdByName</code>	<code>string</code>	The name of the user who created the discussion, as it was at the time of creation.
<code>createdByFullName</code>	<code>string</code>	The full name of the user who created the discussion, as it was at the time of creation.
<code>createdOn</code>	<code>Date</code>	The date and time the discussion was created.
<code>createdDataTimestamp</code>	<code>Date</code>	The last modification timestamp of the object or module that the first comment in the discussion referred to.
<code>lastModifiedBy</code>	<code>User</code>	The user who added the last comment to the discussion, or who last changed the discussion status
<code>lastModifiedByName</code>	<code>string</code>	The username of the user who added the last comment to the discussion, or who last changed the discussion status.
<code>lastModifiedByFullName</code>	<code>string</code>	The full name of the user who added the last comment to the discussion, or who last changed the discussion status.
<code>lastModifiedOn</code>	<code>Date</code>	The date and time the last comment was added, or when the discussion status was last changed.
<code>lastModifiedDataTimestamp</code>	<code>Date</code>	The last modification timestamp of the object or module that the last comment in the discussion referred to.
<code>firstVersion</code>	<code>ModuleVersion</code>	The version of the module the first comment was raised against. Note: If a comment is made against the current version of a module and the module is then baselined, this property will return a reference to that baseline. If the baseline is deleted, it will return the deleted baseline.
<code>lastVersion</code>	<code>ModuleVersion</code>	The version of the module the latest comment was raised against. See note for the <code>firstVersion</code> property above.

Property	Type	Extracts
<code>firstVersionIndex</code>	<code>string</code>	The baseline index of the first module version commented on in the discussion. Can be used in comparisons between module versions.
<code>lastVersionIndex</code>	<code>string</code>	The baseline index of the last module version commented on in the discussion. Can be used in comparison between module versions.

Comment

Property	Type	Extracts
text	string	The plain text of the comment.
moduleVersionIndex	string	The baseline index of the module version against which the comment was raised. Can be used in comparisons between module versions.
status	DiscussionStatus	The status of the discussion in which the comment was made.
moduleVersion	ModuleVersion	The version of the module against which the comment was raised. Note: If a comment is made against the current version of a module and the module is then baselined, this property will return a reference to that baseline. If the baseline is deleted, it will return the deleted baseline.
onCurrentVersion	bool	True if the comment was raised against the current version of the module or an object in the current version.
changedStatus	bool	Tells whether the comment changed the status of the discussion when it was submitted. This will be true for comments which closed or re-opened a discussion.
dataTimestamp	Date	The last modified time of the object or module under discussion, as seen at the commenting users client at the time the comment was submitted.
createdBy	User	The user that created the comment. Returns null if the user is not in the current user list.
createdByName	string	The username of the user who created the comment.
createdByFullName	string	The full name of the user who created the comment.
createdOn	Date	The data and time when the comment was created.
discussion	Discussion	The discussion containing the comment.

Iterators

for Discussion in Type

Syntax

```
for disc in Type do {
...
}
```

where:

disc is a variable of type `Discussion`

Type is a variable of type `Object`, `Module`, `Project` or `Folder`

Operation

Assigns the variable *disc* to be each successive discussion in *Type* in the order they were created. The first time it is run the discussion data will be loaded from the database.

The `Module`, `Folder` and `Project` variants will not include discussions on individual objects.

Note: The `Folder` and `Project` variants are provided for forward compatibility with the possible future inclusion of discussions on folders and projects.

for Comment in Discussion

Syntax

```
for comm in disc do {
...
}
```

where:

comm is a variable of type `Comment`

disc is a variable of type `Discussion`

Operation

Assigns the variable *comm* to be each successive comment in *disc* in chronological order. The first time it is run on a discussion in memory, the comments will be loaded from the database. Note that if a discussion has been changed by a refresh (e.g. in terms of the last `Comment` timestamp) then this will also refresh the comments list.

The discussion properties will be updated in memory if necessary, to be consistent with the updated list of comments.

Operations

create (Discussion)

Declaration

```
string create(target, string text, string summary, Discussion& disc)
```

Operation

Creates a new `Discussion` about `target`, which can be of type `Object` or `Module`. Returns null on success, error string on failure. Also add `text` as the first comment to the discussion.

addComment

Declaration

```
string addComment(Discussion disc, target, string text, Comment& comm)
```

Operation

Adds a `Comment` about `target` to an open `Discussion`. Note that `target` must be an `Object` or `Module` that the `Discussion` already relates to. Returns null on success, error string on failure.

closeDiscussion

Declaration

```
string closeDiscussion(Discussion disc, target, string text, Comment& comm)
```

Operation

Closes an open `Discussion` `disc` by appending a closing comment, specified in `text`. Note that `target` must be an `Object` or `Module` that `disc` already relates to. Returns null on success, error string on failure.

reopenDiscussion

Declaration

```
string reopenDiscussion(Discussion disc, target, string text, Comment& comm)
```

Operation

Reopens a closed `Discussion` `disc` and appends a new comment, specified in `text`. Note that `target` must be an `Object` or `Module` that `disc` already relates to. Returns null on success, error string on failure.

delete (Discussion)

Declaration

```
string delete (Discussion& d)
```

Operation

Deletes the specified `Discussion` if the user has the permission to do so. Returns null on success, or an error string on failure.

sortDiscussions

Declaration

```
void sortDiscussions ({Module m|Object o|Project p|Folder f}, property, bool ascending)
```

Operation

Sorts the discussions list associated with the specified item according to the given *property*, which may be a date, or a string property as listed in the discussions properties list. String sorting is performed according to the lexical ordering for the current user's default locale at the time of execution.

If the discussion list for the specified item has not been loaded from the database, this perm will cause it to be loaded.

Note: The `Folder` and `Project` forms are provided for forward compatibility with the possible future inclusion of discussions on folders and projects.

getDiscussions

Declaration

```
string getDiscussions ({Module m|Object o|Project p|Folder f})
```

Operation

Refreshes from the database the `Discussion` data for the specified item in memory. Returns null on success, or an error on failure.

getObjectDiscussions

Declaration

```
string getObjectDiscussions (Module m)
```

Operation

Refreshes from the database all `Discussions` for all objects in the specified module. Returns null on success, or an error on failure

getComments

Declaration

```
string getComments (Discussion d)
```

Operation

Refreshes from the database the comments data for the specified `Discussion` in memory. Returns null on success, or an error on failure.

Note: The `Discussion` properties will be updated if necessary, to be consistent with the updated comments list.

mayModifyDiscussionStatus

Declaration

```
bool mayModifyDiscussionStatus (Discussion d, Module m)
```

Operation

Checks whether or not the current user has rights to close or re-open the specified discussion on the specified module.

baselineIndex

Declaration

```
string baselineIndex (Module m)
```

Operation

Returns the baseline index of the specified `Module`, which may be a baseline or a current version. Can be used to tell whether or not a `Comment` can be raised against the given `Module` data in a given `Discussion`.

Note: A `Comment` cannot be raised against a baseline index which is less than the `lastVersionIndex` property of the `Discussion`.

Triggers

Trigger capabilities have been expanded so that triggers can now be made to fire before or after a `Discussion` or a `Comment` is created.

As follows:

	pre	post
Comment	x	x

	pre	post
Discussion	x	x

comment

Declaration

```
Comment comment(Trigger t)
```

Operation

Returns the `Comment` with which the supplied `Trigger` is associated, null if not a `Comment` trigger.

discussion

Declaration

```
Discussion discussion(Trigger t)
```

Operation

Returns the `Discussion` with which the supplied `Trigger` is associated, null if not a `Discussion` trigger.

dispose (Discussion/Comment)

Declaration

```
void dispose({Discussion& d|Comment& c})
```

Operation

Disposes of the supplied `Comment` or `Discussion` reference freeing the memory it uses.

Can be called as soon as the reference is no longer required.

Note: The disposing will take place at the end of the current context.

Example

```
// Create a Discussion on the current Module, with one follow-up Comment...
Module m = current
Discussion disc = null
create(m, "This is my\nfirst comment.", "First summary", disc)
Comment cmt
```

```

addComment(disc, m, "This is the\nsecond comment.", cmt)

// Display all Discussions on the Module
for disc in m do
{
    print disc.summary " (" disc.status ") \n"
    User u = disc.createdBy
    string s = u.name
    print "Created By: " s "\n"
    print "Created By Name: \"" disc.createdByName "\" \n"
    print "Created On: " stringOf(disc.createdOn) "\n"
    u = disc.lastModifiedBy
    s = u.name
    print "Last Mod By: " s "\n"
    print "Last Mod By Name: \"" disc.lastModifiedByName "\" \n"
    print "Last Mod On " stringOf(disc.lastModifiedOn) "\n"
    print "First version: " (fullName disc.firstVersion) " [" //-(
        versionString disc.firstVersion) "]" \n"
    print "Last version: " (fullName disc.lastVersion) " ["
        versionString disc.lastVersion) "]" \n"
    Comment c
    for c in disc do
    {
        print "Comment added by " (c.createdByName) " at " //-(
            stringOf(c.createdOn)) ":\n"
        print "Module Version: " (fullName c.moduleVersion) " [" //-(
            versionString c.moduleVersion) "]" \n"
        print "Data timestamp: " (stringOf c.dataTimestamp) "\n"
        print "Status: " c.status " (" (c.changedStatus ? "Changed" //-(
            : "Unchanged") ") ) \n"
        print "On current: " c.onCurrentVersion "\n"
        print c.text "\n"
    }
}

```

}

Chapter 30

General functions

This chapter describes miscellaneous functions that do not belong to any major grouping.

- Error handling
- Archive and restore
- Locking
- HTML functions
- htmlhelp
- Broadcast Messaging

Error handling

This section defines functions for handling errors.

When parse time errors occur when running DXL scripts, the `#include` nesting of files is reported, in addition to the file and line number of the error.

Take two DXL files, `c:\temp\a.dxl` and `c:\temp\b.dxl`:

```
//file a.dxl
#include <c:\temp\b.dxl>
//file b.dxl
while //syntax error
```

Execute the DXL statement:

```
#include <c:\temp\a.dxl>
```

This returns:

```
-E- DXL: <c:\temp\b.dxl:2> syntax error
```

```
Included from:
```

```
<c:\temp\a.dxl:1>
```

```
<Line:1>
```

```
-I- DXL: all done with 1 error and 0 warnings
```

Notice that the file containing the error is displayed first, followed by a list of 'included from' files.

For run-time error reports of DXL scripts, the function backtrace, or callstack, is reported.

Run the following DXL program:

```

void f()
{
    string s
    print s
}

void g()
{
    f
}

g

```

The result will be:

```

-R-E- DXL: <Line:4> unassigned variable (s)
Backtrace:
    <Line:9>
    <Line:12>
-I- DXL: execution halted

```

Notice that there is a backtrace showing the function call nesting at the time the runtime error occurred.

error

Declaration

```
void error(string message)
```

Operation

Terminates the current DXL program, prints the string *message* in the DXL Interaction window's output pane, and pops up a modal dialog box, which announces the presence of errors.

Example

```
error "No links to trace"
```

lastError

Declaration

```
string lastError()
```

Operation

Returns the last error as a string. If the `noError` function has been called, certain key functions do not fail and halt when they discover an error condition. Instead, they set an error message, which can be checked by this function. Calling `lastError` terminates `noError`.

Returns null if there are no errors.

This function can be used to turn error box messages back on after the function has been used.

Example

```
noError
Module m = share("Key data", false)
string openStatus = lastError
if (null openStatus) {
// we opened the module for full access
} else {
// some one has the module open for edit
}
```

noError

Declaration

```
void noError()
```

Operation

Switches off DXL run-time errors until `lastError` is called. Any function that can produce a run-time error is affected. Instead of failing and halting when they discover an error condition, they set an error message, which can be checked by the `lastError` function.

Calling this function resets the error message to null, so you must store any potential error messages for reuse.

unixerror

Declaration

```
void unixerror(string message)
```

Operation

Similar to the `error` function except that the last known operating system error is printed, as well as the string *message*.

The name `unixerror` is not well chosen, because the function works correctly on all DOORS platforms. The name is derived from the UNIX `perror` function.

Example

```
Stat s = create "/no-such-file"
if (null s) unixerror "trouble with filename: "
```

warn

Declaration

```
void warn(string message)
```

Operation

Similar to the `error` function except that the program is not halted.

dxlHere()

Declaration

```
string dxlHere()
```

Operation

This returns the file and line of DXL code currently being executed. Useful for debugging DXL scripts. It only returns the file information for DXL scripts executed by using the `#include` mechanism.

Example

```
print dxlHere() "\n"
```

Archive and restore

This section defines properties, constants, and functions for use with DOORS archive and restore. Two main data types are introduced:

<code>ArchiveItem</code>	An item in an archive
<code>ArchiveData</code>	A list of the contents of an archive

Archive properties

Properties are defined for use with the `.` (dot) operator and `ArchiveItem` structure to extract information about archives, as shown in the following syntax:

```
archiveItem.property
```

where:

<i>archiveItem</i>	Is a variable of type <code>ArchiveItem</code>
<i>property</i>	Is one of the archive properties

The following tables list the properties and the information they extract.

String property	Extracts
<code>archiveItemName</code>	The name of the archive item
<code>archiveItemDescription</code>	The description of the archive item
<code>archiveItemType</code>	The type of the archive item

Boolean property	Extracts
<code>archiveItemSelected</code>	Whether the item is selected
<code>archiveItemSoftDeleted</code>	Whether the item is soft deleted

for archive item in archive

Syntax

```
for archiveItem in archive do {
...
}
```

where:

<code><i>archiveItem</i></code>	Is a variable of type <code>ArchiveItem</code>
<code><i>archive</i></code>	Is a variable of type <code>ArchiveData</code>

Operation

Assigns *archiveItem* to be each successive archive item in *archive*.

Example

```
ArchiveData archiveData
string message
message = get("c:\\project.dpa", archiveData)
ArchiveItem archiveItem
for archiveItem in archiveData do {
    if (archiveItem.archiveItemName ==
        "my module" ) {
        if (archiveItem.archiveItemSelected) {
```

```

        deselect(archiveItem)
    }
}
}

```

archive (modules and projects)

Declaration

```

string archive(string projectName,
               string fileName,
               bool span)

string archive(ModName_ modRef,
               string fileName,
               bool span)

string archive(string projectName,
               string user,
               string password,
               string fileName,
               bool span)

string archive (Modname_ modfref,
               string filename,
               bool spanDisks,
               bool incBackups,
               allInclusionDescriptor allbaselines/noBaselines)

```

Operation

The first form creates an archive of the project *projectName*, and puts it in *fileName*. The default file type is *.dpa*.

The second form creates an archive of the module named *modRef*, and puts it in *fileName*. The default file type is *.dma*.

The third form creates an archive of the project *projectName*, and puts it in *fileName*. This form is supported only for compatibility with earlier releases. In DOORS 6.0, the *user* and *password* arguments are ignored.

The fourth form includes baselines and file backups.

If *span* is true and the path specified is on a removable disk, the archive spans multiple disks.

Example

This example archives a module:

```

string message = archive(module "Car", "d:\\temp\\car.dma", false)
if (!null message) {
    ack message
    halt
}

```

This example archives a project:

```

string message = archive ("Car project",
                          "a:\\car_project.dpa", true)

if (!null message) {
    ack message
    halt
}

```

archive (user list)

Declaration

```

string archive(string fileName,
              bool span)

```

Operation

Creates an archive of the user list, and puts it in *fileName*. The default file type is `.dua`.

archiveFiles

Declaration

```

string archiveFiles(string fileName,
                   string dir,
                   bool span)

```

Operation

Archives the files recursively from the directory *dir* into the zip file *fileName*. The zip file is compatible with `pkzip`.

If *span* is true and the path specified is on a removable disk, the archive spans multiple disks.

Example

This example archives all the files in a directory:

```

string message

message = archiveFiles("d:\\temp\\temp.zip",
                      "d:\\temp\\archive\\", false)

if (! null message) {
    ack message
    halt
}

```

getArchiveType

Declaration

```

string getArchiveType(string fileName,
                     ZipType& zip, [bool serverArchive])

```

Operation

Returns the type of archive file as one of the following constants:

<code>zipNotArchive</code>	Archive is not a project or module
<code>zipProjectArchive</code>	Project archive
<code>zipModuleArchive</code>	Module archive
<code>zipPre3ProjectArchive</code>	Project archived under a version of DOORS prior to 3.0
<code>zipPre3ModuleArchive</code>	Module archived under a version of DOORS prior to 3.0
<code>zipPre5ProjectArchive</code>	Project archived under a version of DOORS prior to 5.0
<code>zipPre5ModuleArchive</code>	Module archived under a version of DOORS prior to 5.0
<code>zipProject5Archive</code>	Project archived under DOORS 5.x
<code>zipModule5Archive</code>	Module archived under DOORS 5.x
<code>zipUserListArchive</code>	User list archive
<code>zipUserList5Archive</code>	User list archived under DOORS 5.x

Example

This example finds out whether a zip file is a project archive:

```
string file = "d:\\temp\\temp.dpa"
string message
ZipType zip
message = getArchiveType(file, zip)
if (!null message){
    print "Failed: " message "\n"
    halt
}
if (zip == zipProjectArchive) {
    print file " is a project archive from the
        latest DOORS version"
} else if (zip == zipProject5Archive) {
    print file " is a project archive from DOORS
        version 5"
} else {
    print file " is neither a version 5 nor a
        version 6 project archive"
}
```

getModuleDetails

Declaration

```
string getModuleDetails(string fileName,
                       string &moduleName,
                       string &projectName,
                       [string &databaseID,
                       string &databaseName,]
                       Date &archiveDate, [bool serverArchive], [ZipType& zt] [])
```

Operation

Passes back module details from the archive *fileName*. Module details comprise the module name, the project name from which it originates, and the archive date. If the optional arguments *databaseID* and *databaseName* are supplied, the function passes back the database ID and name.

If the archive is not a module archive, the function passes back a null string for any parameter it cannot identify, and sensible results for the rest.

The last two flags are for indicating that the archive file is on the server and an additional pointer to a variable used to return the type of zip to the caller.

If *serverArchive* flag is set to `true` and the user does not have permission to read a server archive, an error message will be returned.

If the call fails, the function returns an error message.

Example

This example passes back the details of the module archived in `d:\temp\car.dma`.

```
string moduleName
string projectName
Date archiveDate
string mess= getModuleDetails("d:\\temp\\car.dma", modName,
                             projName, archiveDate)
if (!null message) {
    ack message
    halt
} else {
    string d = archiveDate ""
    print "The archived file contains the module
          " moduleName "
    print "and was archived from "
    print "the project " projectName " on the " d
          "\n"
}
```

getProjectDetails

Declaration

```
string
getProjectDetails(string fileName,
                  string &projectName,
                  string &projectDescription,
                  [string &databaseID,
                  string &databaseName,]
                  Date &archiveDate, [bool serverArchive], [ZipType& zt])
```

Operation

Gets project details from the archive *fileName*. Project details are the name, description and archive date of the project that was archived. If the optional arguments *databaseID* and *databaseName* are supplied, the function passes back the database ID and name in them.

If the archive is not a project archive, the function passes back a null string for any parameter it cannot identify, and sensible results for the rest.

The last two flags are for indicating that the archive file is on the server and an additional pointer to a variable used to return the type of zip to the caller.

If *serverArchive* flag is set to `true` and the user does not have permission to read a server archive, an error message will be returned.

If the call fails, the function returns an error message.

Example

This example gets the details of the project archived in a `: \car_project.dpa`.

```
string projectName
string projectDescription
Date archiveDate
string databaseId
string databaseName

message=getProjectDetails("a:\car_project.zip", projectName,
projectDescription, databaseId,
                        databaseName,
archiveDate)

if (!null message) {
    ack message
    halt
} else {
    string d = archiveDate ""
    print "The archived file contains the project
        "projectName
    print "with the description "
        projectDescription
```

```

    print " from the database called "
        databaseName
    print " with database ID" databaseId
    print "on the " d "\n"
}

```

getUserlistDetails

Declaration

```

string getUserlistDetails(string fileName,
                          string &databaseId,
                          string &databaseName,
                          Date &archiveDate)

```

Operation

Gets user list details from the archive *fileName*. User list details are the ID and name of the database from which the archive was taken.

If the archive is not a user list archive, the function passes back a null string for any parameter it cannot identify, and sensible results for the rest.

If the call fails, the function returns an error message.

restore (archive)

Declaration

```

string restore(ArchiveData archive
              [,string archiveName], [bool serverArchive])

```

Operation

Restores *archive* to *archiveName*. If the operation succeeds, returns a null string; otherwise, returns an error message.

For a project archive, if you specify *archiveName*, this must be a non-existent location. The function then creates a project with this name, and restores the contents of the archive but not the project itself, into the new project. If you do not specify *archiveName*, the function uses the name of the archived project, and restores it to the current location.

For a module archive, if you specify *archiveName*, this must be an existing location. The function then creates the module archive in this existing folder or project. If you do not specify *archiveName*, the function restores the module to the current location.

For a user list archive, if you specify *archiveName*, it is ignored.

The *serverArchive* flag is an additional flag indicating that the archive file is on the server.

If *serverArchive* flag is set to `true` and the user does not have permission to read a server archive, an error message will be returned.

restoreModule

Declaration

```
string restoreModule(string fileName
                    [,string moduleName], [bool serverArchive])
```

Operation

Restores a module from the archive file *fileName*. Optionally renames the module to the name *moduleName*.

If you are restoring a module without defining its name, it can only be restored into a project that does not already contain a module of that name.

If you are restoring a module with a defined name, the *moduleName* must be unique within the restored folder.

The flag *serverArchive* indicates that the archive file is on the server.

If *serverArchive* flag is set to `true` and the user does not have permission to read a server archive, an error message will be returned.

Example

This example restores a module from `d:\temp\car.dma`.

```
string message = restore "d:\\temp\\car.dma"
if (!null message) {
    ack message
    halt
}
```

This example restores a module from `d:\temp\car.dma` to the module `Car user reqts 2`.

```
string message = restore("d:\\temp\\car.dma", "Car user reqts 2")
if (!null message) {
    ack message
    halt
}
```

restoreFiles

Declaration

```
string restoreFiles(string fileName,
                   string destination)
```

Operation

Restores all the files from the zip file *fileName* to the specified directory *destination*.

Example

This example restores all the files from a zip file.

```

string
    message = restoreFiles("d:\\temp\\temp.zip",
        "d:\\temp\\new\\")
if (message !=null){
    ack message
    halt
}

```

restoreProject

Declaration

```

string
restoreProject(string fileName
    [,string projectName
    [,string projectDescription]], [bool serverArchive])

```

Operation

Restores a project from the archive file *fileName*, optionally renaming the project to *projectName* with the description *projectDescription*.

If you are restoring a project without defining its name, it can only be restored into a database that does not already contain a project of that name.

If you are restoring a project with a defined name and description, the *projectName* must be unique.

Example

This example restores the project `Car project` from the file `a:\car_project.dpa`.

```

string message = restore "a:\\car_project.dpa"
if (!null message) {
    ack message
    halt
}

```

This example restores a project from `a:\car_project.dpa` to the project `Car project 2` with the description `Restored project`.

```

string message=restore("a:\\car_project.dpa", "Car project 2", "Restored
project")
if (message != null) {
    ack messagehalt
}

```

restoreUserlist

Declaration

```

string restoreUserlist(string fileName)

```

Operation

Restores the user list from the archive file *fileName*.

select (archive item)

Declaration

```
bool select(ArchiveItem item)
```

Operation

Selects *item*. If the operation succeeds, returns `true`; otherwise, returns `false`.

deselect (archive item)

Declaration

```
bool deselect(ArchiveItem item)
```

Operation

Deselects *item*. If the operation succeeds, returns `true`; otherwise, returns `false`.

rename (archive item)

Declaration

```
bool rename(ArchiveItem item,  
            string newName)
```

Operation

Renames *item* to *newName*. If the operation succeeds, returns `true`; otherwise, returns `false`.

get (archive data)

Declaration

```
string get(string fileName,  
           ArchiveData &archive, [bool serverArchive])
```

Operation

Retrieves the archive data structure from the given file. If the operation succeeds, returns a null string; otherwise, returns an error message.

The *serverArchive* flag indicates that the archive file is on the server.

If *serverArchive* flag is set to `true` and the user does not have permission to read a server archive, an error message will be returned.

canCreateServerArchive

Declaration

```
bool canCreateServerArchive()
```

Operation

Returns `true` if the current user has permission to create an archive at the server and the server has been set up with the archive directory defined.

canRestoreServerArchive

Declaration

```
bool canRestoreServerArchive()
```

Operation

Returns `true` if the current user has permission to restore an archive from the server and the server has been set up with the archive directory defined.

canReadServerArchiveFile

Declaration

```
string canReadServerArchiveFile(string s)
```

Operation

Used to test for an archive existing and being available on the server before attempting a restore operation. The filename supplied is relative to the archive directory on the server.

Returns `NULL` if the file exists and can be read or a non-null error message if the specified file cannot be accessed on the server.

canWriteServerArchiveFile

Declaration

```
string canWriteServerArchiveFile(string s)
```

Operation

Used to test for an archive being available to write to on the server before attempting an archive operation. The filename supplied is relative to the archive directory on the server.

Returns `NULL` if the file can be written or a non-null error message if the specified file cannot be written to on the server. Overwriting server archives is not permitted so if the file already exists, this will return an error message.

canUseServerArchive

Declaration

```
string canUseServerArchive ()
```

Operation

Used to return a string indicating if server archiving by the current user is allowed.

Returns a string indicating if server archiving is permitted and, if it is not permitted, why it is not.

The reasons server archiving may not be permitted are:

Message	Description
Server archiving not allowed - directory not defined	DOORS_ARCHIVE_LOCATION has not been defined
Server archive directory does not exist	The directory defined in DOORS_ARCHIVE_LOCATION does not exist or is not a sub-directory of SERVERDATA.
No permission to restore a server archive	The archive directory is valid but the user does not have permission to archive on the server.

If archiving is permitted, the following message is returned:

```
User has permission and directory is defined
```

Locking

This section defines functions that are used by the manipulation of data locks. They are rarely needed by normal DXL programs.

Most use the data types `LockList` and `Lock`.

Note: To obtain a type `Lock` handle, you must use the `for lock in lock list` loop.

Lock properties

Properties are defined for use with the `.` (dot) operator and a lock handle, as shown in the following syntax:

```
lock.property
```

where:

<i>lock</i>	Is a variable of type <code>Lock</code>
<i>property</i>	Is one of the lock properties

The value of *property* can be one of the following:

String property	Extracts
<code>annotation</code>	Annotation associated with the lock
<code>host</code>	Host name to which the lock is assigned
<code>id</code>	Lock id, which distinguishes shared locks on an item
<code>resourceName</code>	The name of the locked resource For items in the module hierarchy, this is the unqualified name of the item. For locks on the user list, this is <code>User List (Read)</code> or <code>User List (Write)</code> . Separate read and write locks are used, for example, while archiving and restoring the user list.
<code>user</code>	The user account to which the lock is assigned

Boolean property	Extracts
<code>childLocked</code>	Whether the lock is associated with a lock on a descendant of the locked item
<code>removed</code>	Whether the lock has been removed

Date property	Extracts
<code>date</code>	Date the lock was created

Integer property	Extracts
<code>lockMode</code>	One of the values: <code>lockShare</code> , <code>lockWrite</code> , or <code>lockRemoved</code>

Item property	Extracts
<code>item</code>	Handle to the locked item, which can be used to access the name of the item
<code>connectionId</code>	An integer value equal to the connection ID associated with the lock

All locks in a lock list are initially in either `lockShare` or `lockWrite` mode. To change them to `lockRemoved`, use the `remove (lock)` function.

Example

```
Lock lockItem
string username
int connId
LockList lcklist = getLocksInDatabase(true)
for lockItem in lcklist do {
    username = lockItem.user
    connId = lockItem.connectionId
    print "User: " username ", Connection ID: " connId "\n"
}
```

getLocksInDatabase

Declaration

```
LockList getLocksInDatabase([bool allUsers])
```

Operation

Returns a lock list of type `LockList`, which lists lock information on locks held anywhere in the database. If `allUsers` is `true`, and if the current user has may manage power, the list contains locks held by all users. If `allUsers` is `true` and the user does not have sufficient power, this function returns null. If `allUsers` is `false`, or missing, the list contains only locks held by the current user. Locks on items that the user currently has open are not included in this list.

Example

```
LockList llist
llist = getLocksInDatabase(true)
```

getLocksInFolder

Declaration

```
LockList
getLocksInFolder({Folder|Project} reference,
                 bool recurse
                 [,bool allUsers])
```

Operation

Returns a lock list of type `LockList`, which lists lock information on locks held anywhere in the folder or project *reference*. If *recurse* is `true`, the list contains all locks on descendants of the folder. If *allUsers* is `true`, and if the current user has may manage power, the list contains locks held by all users. If *allUsers* is `true` and the user does not have sufficient power, this function returns `null`. If *allUsers* is `false`, or missing, the list contains only locks held by the current user

Example

```
LockList llist
llist = getLocksInFolder(current project,true,true)
```

getLocksInModule

Declaration

```
LockList getLocksInModule (ModName_ modRef
                          [,bool allUsers])
```

Operation

Returns a lock list of type `LockList`, which lists lock information on locks held anywhere in module *modRef*. If *allUsers* is `true`, and if the current user has may manage power, the list contains locks held by all users. If *allUsers* is `true` and the user does not have sufficient power, this function returns `null`. If *allUsers* is `false`, or missing, the list contains only locks held by the current user

isLocked

Declaration

```
bool isLocked (ModName_ modRef)
```

Operation

Returns `true` if the specified module is locked by a user; otherwise returns `false`.

Note that this function returns `true` even if a specified module is locked by the current user.

Example

```
print isLocked(module "New Module")
```

isLockedClosed

Declaration

```
bool isLockedClosed (ModName_ modRef)
```

Operation

Returns `true` if the current user has an exclusive lock on module *m*, and the module is not currently open. Otherwise, returns `false`.

isLockedByUser

Declaration

```
bool isLockedByUser(Object o)
```

Operation

Returns `true` if the specified object is locked by the current user when in edit shareable mode. Otherwise, returns `false`. This function is not equivalent to checking whether the current user can modify the given object.

lock (module)

Declaration

```
string lock(ModName_ modRef
            [,string annotation])
```

Operation

Places an exclusive lock on module *modRef*, without opening it. Also places share locks on all of its ancestor folders (up to the nearest project). The optional second argument associates an annotation with the lock, which can be retrieved through the annotation property (see “Lock properties,” on page 812). If annotation is a null string or only white space characters, no annotation is stored with the lock.

If the user does not have modify, create, delete, or control access to *modRef*, the call fails.

If the operation succeeds, returns `null`; otherwise, returns an error message.

Example

```
string errormess
errormess = lock(module "My module")
if (null errormess)
    print "My module locked.\n"
else
    print errormess "\n"
```

lock (object)

Declaration

```
string lock(Object o [, bool& unavailable])
```

Operation

Locks object *o*. If supplied, the `unavailable` parameter is set to true if the section cannot be locked due to a lock not being available. This is usually because another client has locked the section. If the operation succeeds, returns `null`; otherwise, returns an error message.

This function only makes sense when *o* is in a module that has been opened shareable.

Example

```
if (isShare current) {
    string mess = lock current Object
    if (!null mess)
        print "lock failed: " mess "\n"
}
```

unlock (module)

Declaration

```
string unlock(ModName_ modRef)
```

Operation

Removes an exclusive lock placed on module *m* by the same user. Fails if the module is open or this user has no exclusive lock on it. Removes the associated share locks on ancestor folders.

If the operation succeeds, returns `null`; otherwise, returns an error message.

Example

```
string errormess
errormess = unlock(module "My module")
if (null errormess)
    print "My module unlocked.\n"
else
    print errormess "\n"
```

delete (lock list)

Declaration

```
string delete(LockList list)
```

Operation

Frees up memory used by the variable *list*. If *list* is null, this function has no effect.

Example

```
LockList myList = getLocksInDatabase
```

```
delete myList
```

remove (lock)

Declaration

```
string remove(Lock lock)
```

Operation

Attempts to remove *lock* from the database. Any associated locks in the lock list are also removed. Associated locks are locks on descendants of a folder, and associated locks on ancestor folders that are not associated with locks on other descendants.

If the operation succeeds, returns a null string; otherwise, returns an error message.

shareLock

Declaration

```
string shareLock({Folder|Project} reference,
                 string &lockID
                 [,string annotation])
```

Operation

Places a share lock on the folder or project *reference*, until it is removed by the `remove (lock)` function. It does not lock ancestor folders. It passes back the lock ID in the second argument. The optional third argument associates an annotation with the lock, which can be retrieved through the `annotation` property (see “Lock properties,” on page 812).

If the operation succeeds, returns a null string; otherwise, returns an error message.

for lock in lock list

Syntax

```
for lock in list do {
  ...
}
```

where:

<i>lock</i>	Is a variable of type Lock
<i>list</i>	Is a variable of type LockList

Operation

Assigns the variable *lock* to be each successive lock in *list*.

Example

```

Lock lockItem
string username
LockList lcklist = getLocksInDatabase
for lockItem in lcklist do {
    username = lockItem.user
    print username "\n"
}

```

Unlock object functions

Declaration

```

bool unlockDiscard{All|Section}(Object o)
bool unlockSave{All|Section}(Object o)

```

Operation

These functions unlock sections. The functions `unlockDiscardAll` and `unlockSaveAll` unlock all sections in the module containing `o`. The functions `unlockDiscardSection` and `unlockSaveSection` unlock the section containing `o`.

The functions either discard changes or save changes before unlocking according to the function name.

If the operation is successful, returns `true`; otherwise, returns `false`.

requestLock

Declaration

```

string requestLock(Module m, Object o, bool exclusive, string msg, bool alert)
string requestLock(Module m, bool exclusive, string msg, bool alert)
string requestLock(Object o, string msg, bool alert)

```

Operation

The first form places a lock request on the specified module/object in the specified lock mode. If `exclusive` is set to `true`, an exclusive lock will be requested, otherwise a share lock will be requested. `msg` is the message (if any) to be sent.

The second form requests a lock on the module itself.

The third form requests a lock on the section containing the specified object.

All return errors on failure.

HTML functions

This section defines functions that create HTML to represent a DOORS object attribute, and set an attribute value based on HTML.

htmlText

Declaration

```
string htmlText(Buffer &htmlOutput,
               Column c,
               Object o,
               bool showURL,
               bool newWin,
               string preLink,
               string postLink)

string htmlText(Buffer &htmlOutput,
               attrRef,
               bool showURL,
               bool newWin,
               string preLink,
               string postLink)
```

where *attrRef* is in one of the following formats:

```
(Object o).(string attrName)
(Module m).(string attrName)
(Link l).(string attrName)
```

Operation

The first form fills the buffer *htmlOutput* with a fragment of HTML representing the object *o* in column *c*. The second form does the same for the given object attribute.

The argument *showURL* controls whether URLs in the text are shown as hyperlinks. The argument *newWin* controls whether the hyperlinks should open a new browser window.

If *showURL* is true, the strings *preLink* and *postLink* contain text that appears before the hyperlink and after the hyperlink respectively.

If the call succeeds, returns a null string; otherwise, returns an error message.

Example

```
Buffer b = create
Object o = current Object
htmlText(b, o."Object Text", true, false, "", "")
print b"\n"
```

setAttrFromHTML

Declaration

```
string setAttrFromHTML(Buffer &html,  
                        attrRef,
```

where *attrRef* is in one of the following formats:

```
(Object o).(string attrName)
```

```
(Module m).(string attrName)
```

```
(Link l).(string attrName)
```

Operation

Sets the value of the specified attribute based on the HTML in the buffer.

If the call succeeds, returns a null string; otherwise, returns an error message.

Example

```
Buffer b = create  
Object o = current Object  
b = "hello <b>world</b>"  
setAttrFromHTML(b, o."Object Text")
```

htmlhelp

helpOnEx

Declaration

```
helpOnEx()
```

Operation

Invokes DOORS help on the given topic, using chm (html) help file format. Arguments are the same as for existing perm `helpOn()`.

helpOnFileEx

Declaration

```
helpOnFileEx()
```

Operation

Invokes help from the given `htmlhelp` `chm` file

Broadcast Messaging

sendBroadcastMessage

Declaration

```
string sendBroadcastMessage(string msg)
```

Operation

Sends a message to the database server for broadcasting to all connected clients. Returns an error string if broadcasting fails, otherwise returns null. The executing user must have the Manage Database privilege.

Example

```
if (null sendBroadcastMessage("Please save your work and logout immediately.")){  
    ack "Message sent"  
}
```

Chapter 31

Character tables

This chapter describes:

- Character codes and their meanings
- Table of symbols

Character codes and their meanings

The following table lists the characters for ASCII codes 0-127. For ASCII codes 128 and higher, DOORS uses Latin-1 encoding. The character sets for Latin-1 differ between platforms.

ASCII code			Ctrl	ASCII code			ASCII code			ASCII code			Code/
Dec	Hex	Code	+	Dec	Hex	Char	Dec	Hex	Char	Dec	Hex	Char	
0	00	NUL	@	32	20	<sp>	64	40	@	96	60	`	
1	01	SOH	A	33	21	!	65	41	A	97	61	a	
2	02	SIX	B	34	22	"	66	42	B	98	62	b	
3	03	EIX	C	35	23	#	67	43	C	99	63	c	
4	04	EOI	D	36	24	\$	68	44	D	100	64	d	
5	05	ENQ	E	37	25	%	69	45	E	101	65	e	
6	06	ACK	F	38	26	&	70	46	F	102	66	f	
7	07	BEL	G	39	27	'	71	47	G	103	67	g	
8	08	BS	H	40	28	(72	48	H	104	68	h	
9	09	HI	I	41	29)	73	49	I	105	69	i	
10	0A	LF	J	42	2A	*	74	4A	J	106	6A	j	
11	0B	VI	K	43	2B	+	75	4B	K	107	6B	k	
12	0C	FF	L	44	2C	,	76	4C	L	108	6C	l	
13	0D	CR	M	45	2D	-	77	4D	M	109	6D	m	
14	0E	SO	N	46	2E	.	78	4E	N	110	6E	n	
15	0F	SI	O	47	2F	/	79	4F	O	111	6F	o	
16	10	SLE	P	48	30	0	80	50	P	112	70	p	
17	11	CSI	Q	49	31	1	81	51	Q	113	71	q	
18	12	DC2	R	50	32	2	82	52	R	114	72	r	
19	13	DC3	S	51	33	3	83	53	S	115	73	s	
20	14	DC4	T	52	34	4	84	54	T	116	74	t	
21	15	NAK	U	53	35	5	85	55	U	117	75	u	
22	16	SYN	V	54	36	6	86	56	V	118	76	v	
23	17	EIB	W	55	37	7	87	57	W	119	77	w	
24	18	CAN	X	56	38	8	88	58	X	120	78	x	
25	19	EM	Y	57	39	9	89	59	Y	121	79	y	
26	1A	SIB	Z	58	3A	:	90	5A	Z	122	7A	z	
27	1B	ESC	[59	3B	;	91	5B	[123	7B	{	
28	1C	FS	\	50	3C	<	92	5C	\	124	7C		
29	1D	GS]	61	3D	=	93	5D]	125	7D	}	
30	1E	RS	^	62	3E	>	94	5E	^	126	7E	~	
31	1F	US	_	63	3F	?	95	5F	_	127	7F	DEL	

Table of symbols

The table of symbols shows:

- Symbols that can be displayed in DOORS, but cannot be typed on a standard keyboard
- The plain text representation of symbols that are used in contexts that do not permit symbol display, such as tooltips, object descriptions in link modules, and history
- The symbol character codes

Chapter 32

Contacting customer support

This chapter contains the following topics:

- Contacting IBM Rational Software Support
- What to do before you contact Support
- Sending an automated problem report form
- Other information

Contacting IBM Rational Software Support

Support and information for Telelogic products is currently being transitioned from the Telelogic Support site to the IBM Rational Software Support site. During this transition phase, your product support location depends on your customer history.

Product support

- If you are a heritage customer, meaning you were a Telelogic customer prior to November 1, 2008, please visit the [DOORS Support Web site](#).
Telelogic customers will be redirected automatically to the IBM Rational Software Support site after the product information has been migrated.
- If you are a new Rational customer, meaning you did not have Telelogic-licensed products prior to November 1, 2008, please visit the [IBM Rational Software Support site](#).

What to do before you contact Support

If your site has a designated on-site support person, please contact that person before you contact our Support team.

To help our Support team solve your problem, please have the following information available:

- Your name, title, company name, e-mail address, fax number and telephone number.
- Your support ID and support password.
- The version and build number of DOORS that you're running.

To get this information, run DOORS, and click **Help > About DOORS**.

- The operating system you're running DOORS on, for example Windows XP.

- What operating system your DOORS database is running on, if different.
- If you are reporting a new problem, please have a clear statement of the problem, including the exact text of any error messages produced by DOORS, your operating system, or any other tools that were running when the problem occurred.
- If you are calling about a problem you reported earlier, you need the original tracking number the Support team assigned to your problem.
- If you want, you can use the automated problem report form. For information, see “Sending an automated problem report form,” on page 826.

The support center on our web site is at <https://support.telelogic.com>.

Sending an automated problem report form

To send an automated problem report to Support:

1. Select **Help > Generate Support Request**.

The **Telelogic Support Information** dialog box is displayed with some of your product information automatically included.

Review the information to make sure it's accurate.

2. From the **Impact** drop down list box, select the severity of the problem.

3. In the **Summary** box, summarize the problem.

4. In the **Problem** box, type a detailed description of the problem.

5. If available, attach a snapshot.

Click either **DOORS Window Snapshot** or **Screen Snapshot**, whichever is applicable, and select the snapshot from your machine.

6. If possible, use the buttons in the **Attachment Information** area to add video capture, system details and files.

Note: The **Add Product Files** button is unavailable in DOORS. Product information is collected and added automatically.

Add any relevant information to help Support resolve the problem.

7. You can either:

- Display the information you've entered in a new window so that you can copy it. For example, you may want to add this information to someone else's information.

Click **Just Text (No Email)**.

- Open the email to edit it before sending it to Support.

Click **Preview and Send** to submit the report.

Guidelines for writing a problem report

- Be as specific as possible when you summarize the problem in the **Summary** box and when you explain the situation and provide details in the **Problem** box. For example, “The system crashed when I tried to add an attribute” is more helpful than “It crashed.”
- Indicate if there were any system changes, such as customizations or upgrades, before the problem occurred.
- If the problem is reproducible, list the specific steps to be followed in order to demonstrate the problem and also indicate the model you are using to perform the steps.
- In the problem description, include anything different or unusual that you observed before the problem happened.
- Make screen captures of anything that you feel will help and attach them to the problem report.
- Include any error messages and code samples you have related to the problem.
- If you have multiple unrelated questions or issues, please submit them separately.

Automatic responses and recording defects

When you send the online form to Support, the customer service system immediately searches the Knowledge Base based on the **Summary** and **Problem** descriptions you entered. If there is an exact match of your problem in the knowledge base, the system automatically sends an email to you with a pointer to the most likely solution.

The problem is also automatically recorded in the defect tracking system as assigned to a support representative. This representative works with you to be certain that your problem is solved. The defect tracking system also records new problems with their solutions in the Knowledge Base to provide rapid assistance for other customers.

Automatically generated problem reports

If your DOORS system crashes, it displays a message asking if you want to send a problem report about the crash to DOORS Support.

If you decide to send this generated report, the system displays the same online form that is available from **Help > Generate Support Request**. In this case, the form contains information about the crash condition, in addition to the information that is usually filled in describing your system.

Add any more information that you can to help the Support staff identify the problem before you click the **Preview and Send** button.

Changing the email address of the problem report

If you want to send the problem to someone other than DOORS Support, for example to your internal support, you can change the default email address of the problem report.

To change the email address of the problem report:

1. Open **System** in the **Control Panel**.
2. On the **Advanced** tab, click **Environment Variables**, then click **New** under **variables**.

The **New User Variable** window is displayed

3. In **Variable Name** enter **ILX_RECIP**, the variable that controls the address used by the problem report.
4. In **Variable Value** enter the email address you want to use.
5. Click **OK** to add the value.
6. Click **OK** to save the value in the environment variables.
7. Click **OK** to save the value in the system properties.

Other information

For Rational software product news, events, and other information, visit the [IBM Rational Software Web site](#).

Chapter 33

Notices

This information was developed for products and services offered in the U.S.A. IBM may not offer the products, services, or features discussed in this document in other countries. Consult your local IBM representative for information on the products and services currently available in your area. Any reference to an IBM product, program, or service is not intended to state or imply that only that IBM product, program, or service may be used. Any functionally equivalent product, program, or service that does not infringe any IBM intellectual property right may be used instead. However, it is the user's responsibility to evaluate and verify the operation of any non-IBM product, program, or service.

IBM may have patents or pending patent applications covering subject matter described in this document. The furnishing of this document does not grant you any license to these patents. You can send written license inquiries to:

IBM Director of Licensing
 IBM Corporation
 North Castle Drive
 Armonk, NY 10504-1785
 U.S.A.

For license inquiries regarding double-byte character set (DBCS) information, contact the IBM Intellectual Property Department in your country or send written inquiries to:

IBM World Trade Asia Corporation
 Licensing
 2-31 Roppongi 3-chome, Minato-ku
 Tokyo 106-0032, Japan

The following paragraph does not apply to the United Kingdom or any other country where such provisions are inconsistent with local law: INTERNATIONAL BUSINESS MACHINES CORPORATION PROVIDES THIS PUBLICATION “AS IS” WITHOUT WARRANTY OF ANY KIND, EITHER EXPRESS OR IMPLIED, INCLUDING, BUT NOT LIMITED TO, THE IMPLIED WARRANTIES OF NON-INFRINGEMENT, MERCHANTABILITY OR FITNESS FOR A PARTICULAR PURPOSE. Some states do not allow disclaimer of express or implied warranties in certain transactions. Therefore, this statement may not apply to you.

This information could include technical inaccuracies or typographical errors. Changes are periodically made to the information herein; these changes will be incorporated in new editions of the publication. IBM may make improvements and/or changes in the product(s) and/or the program(s) described in this publication at any time without notice.

Any references in this information to non-IBM Web sites are provided for convenience only and do not in any manner serve as an endorsement of those Web sites. The materials at those Web sites are not part of the materials for this IBM product and use of those Web sites is at your own risk.

IBM may use or distribute any of the information you supply in any way it believes appropriate without incurring any obligation to you.

Licensees of this program who wish to have information about it for the purpose of enabling: (i) the exchange of information between independently created programs and other programs (including this one) and (ii) the mutual use of the information which has been exchanged, should contact:

Intellectual Property Dept. for Rational Software
IBM Corporation
1 Rogers Street
Cambridge, Massachusetts 02142
U.S.A.

Such information may be available, subject to appropriate terms and conditions, including in some cases, payment of a fee.

The licensed program described in this document and all licensed material available for it are provided by IBM under terms of the IBM Customer Agreement, IBM International Program License Agreement or any equivalent agreement between us.

Any performance data contained herein was determined in a controlled environment. Therefore, the results obtained in other operating environments may vary significantly. Some measurements may have been made on development-level systems and there is no guarantee that these measurements will be the same on generally available systems. Furthermore, some measurements may have been estimated through extrapolation. Actual results may vary. Users of this document should verify the applicable data for their specific environment.

Information concerning non-IBM products was obtained from the suppliers of those products, their published announcements or other publicly available sources. IBM has not tested those products and cannot confirm the accuracy of performance, compatibility or any other claims related to non-IBM products. Questions on the capabilities of non-IBM products should be addressed to the suppliers of those products.

This information contains examples of data and reports used in daily business operations. To illustrate them as completely as possible, the examples include the names of individuals, companies, brands, and products. All of these names are fictitious and any similarity to the names and addresses used by an actual business enterprise is entirely coincidental.

If you are viewing this information softcopy, the photographs and color illustrations may not appear.

Additional legal notices are described in the `legal_information.html` file that is included in your software installation.

Trademarks

IBM, the IBM logo, `ibm.com`, Telelogic, and Telelogic DOORS are trademarks or registered trademarks of International Business Machines Corporation in the United States, other countries, or both. These and other IBM trademarked terms are marked on their first occurrence in this information with the appropriate symbol (® or ™), indicating US registered or common law trademarks owned by IBM at the time this information was published. Such trademarks may also be registered or common law trademarks in other countries. A current list of IBM trademarks is available on the Web at www.ibm.com/legal/copytrade.html.

HP is a registered trademark of Hewlett-Packard Corporation.

Java and all Java-based trademarks and logos are trademarks of Sun Microsystems, Inc. in the United States, other countries, or both.

Microsoft, Windows and/or other Microsoft products referenced herein are either trademarks or registered trademarks of Microsoft Corporation.

PostScript is a trademark of Adobe Systems Incorporated or its subsidiaries and may be registered in certain jurisdictions.

Sun and Solaris are trademarks or registered trademarks of Sun Microsystems, Inc. in the United States and other countries.

UNIX is a registered trademark of The Open Group in the United States and other countries.

Text proofing system copyrights

International Proofreader™ English (US and UK) text proofing system © 2003 by Vantage Technology Holdings, Inc. All rights reserved. Reproduction or disassembly of embodied algorithms or database prohibited.

International Proofreader™ French text proofing system © 2003 by Vantage Technology Holdings, Inc. All rights reserved. Reproduction or disassembly of embodied algorithms or database prohibited.

International Proofreader™ German text proofing system © 2003 by Vantage Technology Holdings, Inc. All rights reserved. Reproduction or disassembly of embodied algorithms or database prohibited.

International Proofreader™ Afrikaans text proofing system © 2003 by Vantage Technology Holdings, Inc. All rights reserved. Reproduction or disassembly of embodied algorithms or database prohibited.

International Proofreader™ Catalan text proofing system © 2003 by Vantage Technology Holdings, Inc. All rights reserved. Reproduction or disassembly of embodied algorithms or database prohibited.

International Proofreader™ Czech text proofing system © 2003 by Vantage Technology Holdings, Inc. All rights reserved. Reproduction or disassembly of embodied algorithms or database prohibited.

International Proofreader™ Danish text proofing system © 2003 by Vantage Technology Holdings, Inc. All rights reserved. Reproduction or disassembly of embodied algorithms or database prohibited.

International Proofreader™ Dutch text proofing system © 2003 by Vantage Technology Holdings, Inc. All rights reserved. Reproduction or disassembly of embodied algorithms or database prohibited.

International Proofreader™ Finnish text proofing system © 2003 by Vantage Technology Holdings, Inc. All rights reserved. Reproduction or disassembly of embodied algorithms or database prohibited.

International Proofreader™ Greek text proofing system © 2003 by Vantage Technology Holdings, Inc. All rights reserved. Reproduction or disassembly of embodied algorithms or database prohibited.

International Proofreader™ Italian text proofing system © 2003 by Vantage Technology Holdings, Inc. All rights reserved. Reproduction or disassembly of embodied algorithms or database prohibited.

International Proofreader™ Norwegian, text proofing system © 2003 by Vantage Technology Holdings, Inc. All rights reserved. Reproduction or disassembly of embodied algorithms or database prohibited.

International Proofreader™ Portuguese, text proofing system © 2003 by Vantage Technology Holdings, Inc. All rights reserved. Reproduction or disassembly of embodied algorithms or database prohibited.

International Proofreader™ Russian, text proofing system © 2003 by Vantage Technology Holdings, Inc. All rights reserved. Reproduction or disassembly of embodied algorithms or database prohibited.

International Proofreader™ Spanish, text proofing system © 2003 by Vantage Technology Holdings, Inc. All rights reserved. Reproduction or disassembly of embodied algorithms or database prohibited.

International Proofreader™ Swedish, text proofing system © 2003 by Vantage Technology Holdings, Inc. All rights reserved. Reproduction or disassembly of embodied algorithms or database prohibited.

Other company, product or service names may be trademarks or service marks of others.

Index

Symbols

:: operator 16
 ::do(AccessRec&, SignatureInfo, void) 285
 ::do(AccessRec&, SignatureInfoSpecifier___, void) 285
 ::do(SignatureEntry&, SignatureInfo, void) 289

A

accept (IPC) 132
 accept (object) 561
 acceptPartition 620
 acceptReport 620
 Access status 390
 accessed (date) 126
 AccessRec get(SignatureInfo, string name, string& error) 286
 acknowledge 410
 activateURL function 24
 active(element) 427
 Actual colors 513
 addAttribute 614
 addAwayAttribute 614
 addAwayLinkModule 613
 addAwayLinkset 615
 addAwayModule 613
 addAwayView 615
 addBaselines(BaselineSet) 260
 addComment (Discussions) 791
 addFilter 561
 addGroup 179
 addLinkModule 612
 addLinkModuleDescriptor 334
 addLinkset 615
 addMember 180
 addMenu 424
 addModule 612
 addModule(BaselineSetDefinition) 249
 addNotifyUser 162
 addProjectEntry(ProblemItem) 782
 addRecentlyOpenModule(ModuleVersion) 277
 addRecentlyOpenModule(string) 277
 addToolTip 498
 addUser 180
 addView 615
 all (module) 304
 allAttributesReadable(SignatureEntry) 292
 allowsAccess 617
 alternative 752, 757
 Alternative Addins Location 543
 alternatives 752
 alternativeWord 768
 anagram 770
 ancestors (show/hide) 566
 ancestors (state) 567
 annotation(BaselineSet) 258
 append 149
 append (open file) 77
 Append operator 106
 appendCell 712
 appendColumn (table) 712
 appendRow 712
 appendSignatureEntry(SignatureInfo si, string label, string comment) 288
 Application of regular expressions 102
 apply 477
 apply (arrows) 479
 apply (partition definition) 619
 applyFiltering 567
 applyingFiltering 567
 applyTextFormattingToParagraph 738
 Archive
 and restore 800
 properties 800
 archive (modules and projects) 802
 archive (user list) 803
 archiveFiles 803
 Arithmetic operators (int) 63
 Arithmetic operators (real) 66
 Arrays 115
 ascending 570
 Assignment (buffer) 105
 Assignment (date) 90
 Assignment (enumerated option) 361
 Assignment (from attribute) 354
 Assignment (int) 64
 Assignment (real) 67
 Assignment (rich text) 730
 Assignment (to attribute) 355
 Attachment placement 521
 attrdef (trigger) 678
 attrDXLName 386
 attribute (in column) 596
 attribute (trigger) 677
 attribute (value) 559

- Attribute definitions
 - access controls 373
 - example program 372
 - introduction 362
 - properties 362
- Attribute types
 - access controls 380
 - manipulation 381
 - properties 375
 - values 374
- Attribute values
 - access controls 359
 - extraction 353
- attributeDXL 470
- attributeValue 143, 368
- attrName 597
- Auto-declare 7
- autoIndent 236
- Automated problem report form 826
- Automation
 - interface 665
- Automation client 656

B

- background 482
- backSlasher 73
- Backtrace 797
- baseline 239
- baseline (history session) 270
- baseline(ModuleVersion) 245
- baselineExists 239
- baselineExists(ModuleVersion) 245
- baselineIndex (discussions) 793
- baselineInfo(current Module) 245
- Baselines,example program 243
- baselineSet(ModuleVersion) 261
- baseWin 413
- batchMode function 25
- below (element) 516
- beside 516
- bitmap 491
- block 413
- bool pageSignaturePage 704
- Boolean operators 60
- box 487
- Break statement 21
- bringToFront 238
- Browsing the DXL library 5
- Buffer comparison 107

- Buffers and regular expressions 112
- busy 414
- button 478
- button (arrows) 479
- Buttons 476

C

- Callstack 797
- canceled(IntegrityResultsData) 777
- cancelled(IntegrityResultsData) 777
- canControl (attribute type) 380
- canControl (attribute) 360
- canControl (item) 200
- canControl (module) 223
- canControl (object) 302
- canControl (view) 584
- canControlDef 373
- canControlVal 374
- canCreate (attribute type) 380
- canCreate (attribute) 359
- canCreate (item) 200
- canCreate (module) 223
- canCreate (object) 302
- canCreate (view) 584
- canCreateDef 373
- canCreateServerArchive 811
- canCreateVal 373
- canDelete 314
- canDelete (attribute type) 381
- canDelete (attribute) 361
- canDelete (item) 201
- canDelete (link) 327
- canDelete (module) 224
- canDelete (object) 302
- canDelete (view) 585
- canDelete(external link) 344
- canDeleteDef 374
- canDeleteVal 374
- canLock (object) 303
- canModify (attribute type) 380
- canModify (attribute) 360
- canModify (item) 200
- canModify (module) 224
- canModify (object) 302
- canModify (view) 584
- canOpenFile 77
- canRead (attribute type) 381
- canRead (attribute) 356
- canRead (item) 200

- canRead (module) 229
- canRead (object) 302
- canRead (view) 584
- canReadServerArchiveFile 811
- canRestoreServerArchive 811
- canUnlock (object) 303
- canUseServerArchive 812
- canvas 481
- canWrite (attribute) 356
- canWrite (module) 229
- canWrite (view) 585
- canWriteServerArchiveFile 811
- Casts 19
- cell 709
- centered 414
- change (view definition) 588
- changed (date) 126
- changePasswordDialog 163
- changePicture 644
- Character constants 11
- Characters
 - ASCII codes 823
 - classes 61
 - codes and their meanings 823
 - extracting from a buffer 107
 - extracting from a string 61
 - set constants 741
 - set identification 741
- characterSet 742
- charOf 62
- charsetDefault 742
- checkBox 452
- checkConnect 184
- checkDatabaseIntegrity(Folder, IntegrityResultsData&) 776
- checkDN 185
- checkDXL function 23
- checkFolderIntegrity(Folder&, IntegrityResultsData& , bool) 777
- checkItem(IntegrityProblem) 783
- choice 460
- Choice dialog box elements 460
- cistrcmp 71
- clear (oleAutoArgs) 661
- clearDefaultViewForModule 577
- clearDefaultViewForUser 577
- clearInvalidInheritanceOf 582
- clearSearchObject 320
- clearToolTips 499
- client 132
- Clipboard general functions 321
- clipClear 202
- clipCopy 201
- clipCut 201
- clipLastOp 203
- clipPaste 202
- clipUndo 203
- close 477
- close (configuration area stream) 87
- close (module) 232
- close (partition file) 619
- close (stream) 78
- close(baselineSet) 259
- close(Dictionary) 768
- closeDiscussion 791
- closeFolder 216
- closeProject 220
- codepageName 149
- color 483
- color (get) 597
- color (set) 597
- Color schemes 137
- Colors 510
- column 596
- column (value) 560
- Column alignment constants 596
- Columns 596
- combine 108
- Comment (Discussion Types) 785
- comment (Trigger) 794
- Comment variable (Discussions) 789
- Comments 9
- Common element operations 424
- Complex canvases 495
- Compound
 - filters 561
 - sort 570
 - statements 19
- Concatenation (attribute base type) 377
- Concatenation (attribute definition) 365
- Concatenation (attribute) 354
- Concatenation (base types) 57
- Concatenation (buffers) 106
- Concatenation (dates) 90
- Concatenation (history type) 266
- Conditional statements 19
- confAppend 86
- confCopyFile 86
- confDeleteDirectory 85

- confDeleteFile 87
- confDownloadFile 89
- confFileExists 87
- Configuration file access 83
- confirm 411
- confirmPasswordDialog 164
- confMkdir 85
- confRead 85
- confRenameFile 86
- confUploadFile 88
- confWrite 85
- Constants 11
 - and general functions 749
 - dictionary 750
 - icons 408
 - language 749
 - of type int 644
 - spell check modes 750
 - table 707
 - trigger 672
 - type bool 60
- Constants (history type) 265
- Constants for codepages 148
- Constrained placement
 - basics 519
 - introduction 519
- contains 109, 562
- containsOle 637
- contents 562
- Continue statement 21
- Controlling
 - DOORS from applications that support automation 664
 - Electronic Signature ACL 283
- Convert to real 67
- convertFolderToProject 215
- convertFromCodepage 150
- convertProjectToFolder 214
- convertToCodepage 150
- convertToFolder(ProblemItem) 782
- copy (module) 235
- copy (partition definition) 610
- copyFile 79
- copyPassword 164, 172
- copyPictureObject 645
- copyToClipboard 134
- cos (Real Angle) 69
- create 704
- create (array) 115
- create (attribute definition) 366
- create (attribute type) 381
- create (baseline) 240
- create (buffer) 109
- create (descriptive module) 274
- create (dialog box) 414
- create (Discussion) 791
- create (folder) 215
- create (link module) 232
- create (linkset) 340
- create (object) 312
- create (oleAutoArgs) 661
- create (partition definition) 610
- create (skip list) 97
- create (status handle) 125
- create (view definition) 587
- create(Baseline Set) 257
- create(BaselineSetDefinition) 247
- create(descriptive module) 232
- create(external link) 343
- create(formal module) 231
- create(Project) 219
- createButtonBar 415, 553
- createCombo 415, 557
- createDropCallback 684
- createEditableCombo 510
- createItem 415, 553
- createMenu 551
- createPasswordDialog 162
- createPopup 558
- createPrivate 587
- createPublic 587
- createString (skip list) 97
- Creating a user account example program 165
- current (folder) 213
- current (module) 225
- current (object) 308
- current (page setup) 702
- current (project) 217
- current (trigger) 678
- Current folder, setting 213
- Current module, setting 224
- Current object 308
- Current object, setting 308
- Current page setup, setting 702
- Current project, setting 216
- currentANSIcodepage 149
- currentDirectory 79
- currentView 574
- Customizing DOORS 137

cutRichText 731

D

data(for ModuleVersion) 244
 Database Integrity Checker 775
 Database Integrity Perms 776
 Database Integrity Types 775
 Database properties 155
 date 93
 date(DBE date_dbe) 454
 dateAndTime 95
 dateOf 93
 dateOf(BaselineSet) 259
 dateOnly 94
 Dates 90
 Dates, comparison 91
 DBE resizing 528
 Declarations 14
 Declarators 14
 decodeURL 347
 Default link module 339
 defaultTableAttribute 721
 delete 704
 delete (array) 116
 delete (attribute definition) 367
 delete (attribute type) 382
 delete (baseline) 240
 delete (buffer) 110
 delete (column) 597
 delete (Discussion) 792
 delete (entry) 97
 delete (IPC channel) 133
 delete (item in tree view) 429
 delete (item) 208
 delete (link) 337
 delete (linkset) 340
 delete (lock list) 817
 delete (ole.AutoArgs) 661
 delete (option or item) 428
 delete (partition definition) 610
 delete (regexp) 104
 delete (skip list) 97
 delete (status handle) 125
 delete (trigger) 676
 delete (user property) 178
 delete (view definition) 588
 delete (view) 575
 delete(Baseline) 246
 delete(BaselineSetDefinition) 250

delete(IntegrityResultsData&) 783
 deleteAllMembers 181
 deleteCell 710
 deleteColumn 467, 710
 deleteFile 80
 deleteGroup 179
 deleteKeyRegistry 130
 deleteMember 181
 deleteNotifyUser 162
 deletePicture 645
 deleteRow 710
 deleteTable 710
 deleteUser 180
 deleteValueRegistry 130
 Derived types 14
 descendants (show/hide) 574
 descendants (state) 574
 descending 570
 description 204
 description(BaselineSetDefinition) 249
 Descriptive modules 274
 deselect 319
 deselect (archive item) 810
 destroy (dialog box) 415
 destroy (icon) 409
 destroyBitmap 492
 destroySort 573
 Developing DXL programs 3
 Diagnostic perms 744
 Dialog boxes
 elements 424
 example program 523, 524
 functions 413
 Dictionary
 constants 750
 variable 767
 diff(buffer) 270
 directory 126
 disableDisplayWarnings 747
 disableGeneralRichTextWarnings 746
 disableObjectTextAssignmentWarnings 745
 disableObjectTextRichTextWarnings 745
 disableRepeatWarnings 746
 disconnect 133
 Discussion 785
 discussion (trigger) 794
 Discussion variable (Discussions) 787
 Discussions 785
 DiscussionStatus 785

- display 604
- Display Color Schemes 137
- displayRich 605, 606
- dispose (Discussion/Comment) 794
- dispose (partition definition) 610
- document (module) 304
- Document attributes 699
- DOORS
 - built-in windows 544
 - customizing 137
 - database access 155
- DOORS explorer 139
- DOORS URLs 346
- doorsInfo 162
- doorsVersion 220
- downgrade 233
- downgradeShare 233
- Drag-and-drop 465
- draggedObjects 686
- draw 488
- drawAngle 489
- drawBitmap 492
- dropDataAvailable 684
- droppedAttributeOLEText 686
- droppedAttributeRichText 686
- droppedAttributeText 685
- droppedAttrOLETextAvailable 686
- droppedAttrRichTextAvailable 685
- droppedAttrTextAvailable 685
- droppedList 687
- droppedString 684
- dxl (get) 598
- dxl (set) 599
- dxl (trigger) 678
- DXL attribute
 - example program 386
 - introduction 385
- dxlHere() function 800
- dxlWarningFilename 747
- dxlWarningLineNumber 747
- Dynamic triggers 670

E

- echoed
 - inlinks 333
 - outlinks 333
- edit (open module) 234
- ElectronicSignature Data Manipulation 287
- ellipse 488

- Embedded OLE objects 629
- empty (element) 429
- enableDefaultTableAttribute 721
- enableDisplayWarnings 747
- enableGeneralRichTextWarnings 746
- enableObjectTextAssignmentWarnings 744
- enableObjectTextRichTextWarnings 745
- enableRepeatWarnings 746
- end (configuration area stream) 87
- end (menu) 558
- end (of match) 104
- end (popup) 558
- end (stream) 80
- end(button bar) 558
- endPrintJob 493
- ensureUserRecordLoaded 169
- entire (module) 304
- error function 798
- errorBox 410
- Errors 797
- event (trigger) 677, 684
- events
 - names 673
 - types 673
- everSectioned 783
- Example (Discussions) 794
- Example (HTML Control) 534
- Example (HTML Edit Control) 540
- Example programs
 - add a signature 292
 - attribute definitions 372
 - baselines 243
 - creating a user account example 165
 - DXL attribute 386
 - files and streams 82
 - filters 567
 - history 273
 - list signatures 295
 - placing dialog boxes 523, 524
 - progress bar 527
 - regular expressions 104
 - setting access control 399
 - skip lists 100
 - sorting 573
 - spelling/dictionary 771
 - status handle 128
 - text buffers 113
 - views 585
- excludeCurrent 563

- excludeLeaves 563
 - excludes 569
 - exists (attribute definition) 368
 - exists (tree view) 470
 - existsGroup 168
 - existsUser 168
 - exp (Real x) 69
 - export 493
 - exportPicture 645, 646
 - exportRTFString 739
 - Expressions 17
 - ExternalLink 342
 - ExternalLink current 343
 - ExternalLinkBehavior 343
 - ExternalLinkDirection 343
 - extractAfter 276
 - extractBelow 276
- F**
- field 450
 - File inclusion 10
 - fileName 449
 - Files and streams
 - example program 82
 - introduction 75
 - Filter attributes, comparing 560
 - Filtering on multi-valued attributes 568
 - Filters
 - example program 567
 - introduction 559
 - filterTables 563
 - find 168
 - find (attribute definition in ModuleProperties) 279
 - find (attribute definition) 368
 - find (attribute type) 377
 - find (entry) 98
 - findAttribute 614
 - findByID 168
 - findGroupRDNFromName 184
 - Finding
 - links 327
 - objects 303
 - findLinkset 614
 - findModule 613
 - findPlainText 73, 582, 583
 - findRichText 731
 - findUserInfoFromDN 184
 - findUserRDNFromName 183
 - findUserRDNFromLoginName 184
 - findView 614
 - firstNonSpace 110
 - flush 78
 - flushDeletions 314
 - folder (handle) 214
 - folder (state) 204
 - folder(IntegrityProblem) 779
 - font 484
 - Font constants 139
 - fontTable 743
 - for {string|ModuleVersion} in recentModules 277
 - for all incoming external links 344
 - for all outgoing external links 344
 - for AttrType in ModuleProperties 280
 - for Comment in Discussion 790
 - for Discussion in Type 789
 - for group in ldapGroupsForUser 172
 - for int in installedCodepages 148
 - for int in supportedCodepages 148
 - for Locale in installedLocales 141
 - for Locale in supportedLocales 142
 - For loop
 - for access record in all Baseline Set Definition 253
 - for access record in all type 397
 - for access record in Baseline Set Definition 253
 - for access record in type 396
 - for access record in values 397
 - for all incoming links in 328
 - for all incoming links in all 331
 - for all items in folder 212
 - for all items in project 212
 - for all link references in 330
 - for all modules in project 226
 - for all outgoing links in 327
 - for all outgoing links in all 331
 - for all projects in database 218
 - for all source link references in 332
 - for all source links in 332
 - for all source references in 329
 - for all sources in 328
 - for all spellings in alternatives 753
 - for alternativeWord in Dictionary 769
 - for archive item in archive 801
 - for attribute definition in module 371
 - for attribute type in module 379
 - for baseline in module 242
 - for baseline Set in BaselineSetDefinition 256
 - for baselineSet in ModName_ 261
 - for baselineSetDefinition in Folder 247

- for baselineSetDefinition in ModName_ 247
 - for buffer in Dictionary 768
 - for buffer in SpellingAlternatives__ 757
 - for cell in row 711
 - for columns in module 603
 - for data element in skip list 99
 - for file in configuration area 88
 - for file in directory 81
 - for group in database 170
 - for history record in type 269
 - for history session in module 272
 - for in-partition in project 625
 - for IntegrityCheckItem in IntegrityResultsData 777
 - for IntegrityProblem in IntegrityResultsData 778
 - for IntegrityProblem in ProblemItem 778
 - for item in folder 211
 - for language in Languages__ 758
 - for link module descriptor in folder 330
 - for lock in lock list 818
 - for module attributes in module 358
 - for module in BaselineSetDefinition 249
 - for module in database 31, 32, 225
 - for Module in Folder do 227
 - for moduleVersion in all BaselineSet 260
 - for moduleVersion in BaselineSet 260
 - for object attributes in module 358
 - for object in all 305
 - for object in document 306
 - for object in entire 305
 - for object in module 306
 - for object in object 307
 - for object in top 307
 - for open module in project 226
 - for out-partition in project 626
 - for partition attribute in partition module 618
 - for partition definition in project 626
 - for partition module in partition definition 617
 - for partition view in partition module 618
 - for pictures in project 654
 - for position in list (selected items) 465
 - for position in list view (selected items) 473
 - for ProblemItem in IntegrityResultsData 777
 - for project in database 217
 - for property in user account 177
 - for rich text in string 726
 - for row in table 711
 - for setup name in setups 705
 - for spellingError in SpellingErrors__ 755
 - for trigger in database 682
 - for trigger in module 683
 - for trigger in project 683
 - for user in database 170
 - for user in group 171
 - for user in notify list 172
 - for value in list (selected items) 464
 - for value in list view (selected items) 473
 - for view in module 581
 - for module level attribute definition in {Module|ModuleProperties} 371
 - for sort in sort 572
 - for string in Fonts__ do 147
 - for string in longDateFormats 94
 - for string in ModuleProperties 279
 - for string in shortDateFormats 94
 - for View in View 583
 - forename 174
 - formalStatus 235
 - format 81
 - frame 448
 - full 518
 - fullHostname 123
 - fullName 173
 - fullName (item) 205
 - fullName(ModuleVersion) 246
 - Function calls 18
 - Function definitions 15
 - Functions
 - backtrace 797
 - callstack 797
 - key 98
 - match 102
 - put 99
 - Fundamental functions 57
 - Fundamental types 14, 57
- ## G
- General language facilities 75
 - get 391
 - get (archive data) 810
 - get (data from array) 116
 - get (element or option) 432
 - get (selected text) 434, 475
 - get (string from array) 117
 - get (user property) 178
 - get (view definition) 587
 - Get baseline data 240
 - Get display state 237
 - Get page dimension 697

Get page properties status 695
 get(BaselineSetDefinition) 251
 get(DBE date_dbe) 455
 get(HTML frame) 532
 get(HTML view) 531
 getAccountsDisabled 156
 getAddressAttribute 191
 getAdministratorName 165
 getAlternative 769
 getArchiveType 803
 getBorderSize 417
 getBoundedAttr 369
 getBoundedUnicode 359
 getBuffer 533
 getBuffer(DBE date_dbe) 456
 getBuffer(DBE) 444
 getCanvas 606
 getCaptionHeight 417
 getCatalanOptions 764
 getCellAlignment 714
 getCellShowChangeBars 715
 getCellShowLinkArrows 715
 getCellWidth 715
 getCheck 468
 getColumnBottom 317
 getColumnTop 317
 getColumnValue 468
 getComment(SignatureEntry) 291
 getComments (Discussion d) 793
 getCorrectionComplete(SpellingError) 757
 getCursorPosition 323
 getDatabaseIdentifier 156
 getDatabaseMailPrefixText 153
 getDatabaseMailServer 157
 getDatabaseMailServerAccount 158
 getDatabaseMinimumPasswordLength 157
 getDatabaseName 155
 getDatabasePasswordRequired 157
 getDate(DBE date_dbe) 455
 getDate(SignatureEntry) 290
 getDateFormat 141
 getDef 391
 getDefaultColorScheme 137
 getDefaultLineSpacing 146
 getDefaultLinkModule 339
 getDefaultViewForModule 578
 getDefaultViewForUser 578
 getDescription 335
 getDescriptionAttribute 191
 getDisableLoginThreshold 159
 getDiscussions 792
 getDoorsBindNameDN 186
 getDoorsGroupGroupDN 189
 getDoorsGroupRoot 188
 getDoorsUserGroupDN 188
 getDoorsUsernameAttribute 189
 getDoorsUserRoot 187
 getDOSstring 109
 getDXLFileHelp 470
 getDXLFileName 470
 getEmail(SignatureEntry) 290
 getEmailAttribute 190
 getEnglishOptions 761
 getenv 122
 getErrorStartPos(SpellingError) 756
 getErrorStopPos(SpellingError) 756
 getErrorString 755
 getExplanation 760
 getFailedLoginThreshold 159
 getFontSetting 147
 getFontSettings 139
 getFormattedLocalDate(SignatureEntry) 291
 getFrenchOptions 762
 getGermanOptions 763
 getGrammarLevel 765
 getGrammarRules 759
 getGreekOptions 763
 getGroupMemberAttribute 192
 getGroupNameAttribute 193
 getGroupObjectClass 192
 getHTML 532
 getId 759
 getIgnoreReadOnly 766
 getImplied 391
 getInnerHTML 533
 getInvalidCharInModuleName 230
 getInvalidCharInProjectName 218
 getInvalidCharInSuffix 241
 getIsValid(SignatureEntry) 292
 getLabel(SignatureEntry) 291
 getLabelOptions(SignatureEntry) 291
 getLabelSpecifier(SignatureInfo) 288
 getLanguage 759, 761
 getLdapServerName 185
 getLegacyLocale 144
 getLineSpacing 146
 getLineSpacing(Locale) 146
 getLocalDate(SignatureEntry) 291

- getLocksInDatabase 814
 - getLocksInFolder 814
 - getLocksInModule 815
 - getLogicalColorName 515
 - getLoginFailureText 153
 - getLoginLoggingPolicy 160
 - getLoginNameAttribute 190
 - getLoginPolicy 158
 - getMaxClientVersion 161
 - getMessageOfTheDay 152
 - getMessageOfTheDayOption 152
 - getMinClientVersion 161
 - getModuleDetails 805
 - getMostRecentBaseline 241
 - getMostRecentBaseline(Module) 246
 - getName 335, 759, 760
 - getNextError 754
 - getObjectDiscussions 792
 - getOleWidthHeight 638
 - getOptions 760
 - getOverridable 336
 - getParent 421
 - getParentFolder (item) 205
 - getParentProject (item) 205
 - getPartitionMask 627
 - getPartitionMaskDef 627
 - getPartitionMaskVal 627
 - getPictBB 647
 - getPictFormat 647
 - getPictName 648
 - getPictWidthHeight 648
 - getPort 132
 - getPortNo 186
 - getPos 416
 - getProjectDetails 806
 - getProperties 279
 - getRealColor 515
 - getRealColorIcon 515
 - getRealColorName 515
 - getRealColorOptionForTypes 379
 - getReference 207
 - getRegistry 128
 - getRow 714
 - getRussianOptions 765
 - getSearchObject 319
 - getSelectedCol 229
 - getSelection 318
 - getSentenceStartPos(SpellingError) 756
 - getSentenceStopPos(SpellingError) 756
 - getShowTableAcrossModule 715
 - getSignatureInfo(SignatureInfo si&, ModName_ document, int major, int minor, string suffix) 287
 - getSize 416
 - getSortColumn 469
 - getSource getTarget 340
 - getSourceName 335
 - getSourceVersion(Linkset) 333
 - getSpanishOptions 764
 - getSpellingCheckingMode 766
 - getSpellingFirst 766
 - getTable 714
 - getTargetName 336
 - getTDBindName 196
 - getTDPortNumber 195
 - getTDServerName 195
 - getTDSSOToken 347
 - getTDUseDirectoryPasswordPolicy 196
 - getTelephoneAttribute 191
 - getTemplateFileName 471
 - getTitle 416
 - getUKOptions 762
 - getURL 346, 531
 - getUseLdap() 182
 - getUserFullName 290
 - getUserlistDetails 807
 - getUserName(SignatureEntry) 290
 - getUseTelelogicDirectory 194
 - getVal 391
 - getWord 769
 - gluedHelp 417
 - goodFileName 79
 - goodStringOf 268
 - gotoObject 309
 - Grammar Constants 750
 - graphics (get) 599
 - graphics (set) 599
 - Groups and users
 - management 175
 - manipulation 167
 - properties 175, 193
- ## H
- halt function 23
 - hardDelete (module) 235
 - hardDelete (object) 315
 - hasHeader 499
 - hasInPlace 495
 - hasLinks 564

- hasNoLinks 564
 - hasPermission(SignatureInfo, Permission) 284
 - hasPermission(SignatureInfoSpecifier__, Permission) 284
 - hasPermission(string, SignatureInfo, Permission) 284
 - hasPermission(string, SignatureInfoSpecifier__, Permission) 285
 - hasPicture/exportPicture 606
 - hasScrollbars 502
 - hasSpecificValue 369
 - headerAddColumn 500
 - headerChange 500
 - headerRemoveColumn 500
 - headerReset 501
 - headerSelect 501
 - headerSetHighlight 501
 - headerShow 501
 - height 485
 - help 417
 - helpOn 418
 - helpOnEx 821
 - helpOnFileEx 821
 - hide 545
 - hide (dialog box) 418
 - hide (element) 427
 - hideExplorer 581
 - Hierarchy
 - clipboard 201
 - information 204
 - manipulation 208
 - highlightText 320
 - History
 - example program 273
 - introduction 265
 - properties 267
 - home 475
 - Horizontal navigation 311
 - hostname 122
 - HTML Control 529
 - HTML Edit Control 539
 - HTML functions 820
 - htmlBuffer 539
 - htmlEdit 539
 - htmlhelp 821
 - htmlText 820
 - htmlView 529
- I**
- IBM Customer Support 825
 - id(Locale) 143
 - identifier (object get) 317
 - Identifiers 10, 13
 - ignoreWord 757
 - ILX_RECIP 827
 - Immediate declaration 15
 - Importing rich text 744
 - importPicture 649
 - importRTF 744
 - inactive 427
 - inClipboard 203
 - includeCurrent 563
 - includeLeaves 563
 - includes 569
 - includesTime 94
 - info (get) 599
 - info (set) 600
 - infoBox 410
 - Information about objects 316, 319
 - inherited 392
 - inherited(BaselineSetDefinition) 252
 - inheritedDef 392
 - inheritedVal 392
 - In-partition properties 625
 - In-place editing 495
 - inPlaceChoiceAdd 496
 - inPlaceCopy 496
 - inPlaceCut 496
 - inplaceEditing 321
 - inPlaceGet 497
 - inPlaceMove 495
 - inPlacePaste 496
 - inPlaceReset 497
 - inPlaceSet 497
 - inPlaceShow 496
 - inPlaceTextHeight 498
 - insert 769
 - insert (column in module) 600
 - insert (item in list view) 430
 - insert (item in tree view) 430
 - insert (option or item) 429
 - insertBitmapFromClipboard 649
 - insertCell 713
 - insertColumn (list view) 468
 - insertColumn (table) 713
 - insertDroppedPicture 687
 - insertPictureAfter 650
 - insertPictureBelow 650
 - insertPictureFile 651
 - insertPictureFileAfter 651

insertPictureFileBelow 652
 insertRow 713
 installed(Locale) 143
 instance 403
 Integer comparison 65
 Integer constants 11
 IntegrityCheckItem 775
 IntegrityItemType 775
 IntegrityProblem 775
 IntegrityResultsData 775
 Interprocess communications 131
 intOf (char) 63
 intOf (date) 92
 intOf (real) 68
 Introducing DXL 3
 ipcHostname 131
 isAccessInherited 392
 isAccessInherited(BaselineSetDefinition) 252
 isanyBaselineSetOpen(BaselineSetDefinition) 251
 isAscending 572
 isAttribute (user) 178
 isBaseline(ModuleVersion | Module) 244
 isBaselinePresent(BaselineSet) 257
 isBaselineSignatureConfigured(SignatureInfo) 287
 isBatch function 25
 isDatabaseDict 770
 isDefault 393
 isDeleted (item) 205
 isDeleted (project name) 218
 isDescending 572
 isEdit 229
 isFirstObjectInDXLSet(Object) 607
 isinheritedView 575
 isLastObjectInDXLSet(Object) 607
 isLocked 815
 isLockedByUser 398, 816
 isLockedClosed 815
 isMember 362
 isNull 565
 isOleObjectSelected 637
 isOpen(BaselineSet) 259
 isPartitionedOut 627
 isPartitionedOutDef 627
 isPartitionedOutVal 627
 isRanged 378
 isRead 229
 isRichText 732
 isShare 229
 isSupported 759

isUsed 378
 isValidChar 150
 isValidDescription 230
 isValidInt 65
 isValidName 219, 230, 576, 705
 isValidPrefix 230
 isVisible 231
 isVisibleAttribute 369
 item (handle) 211
 Item access controls 200
 itemClipboardIsEmpty 203
 itemFromID (handle) 211
 itemFromReference 207
 Iterators (Discussions) 789

J

justify (get alignment) 600
 justify (set alignment) 600

K

key function 98
 Keyboard event constants 480
 keyword (buffer) 110
 kind 678

L

label 446
 Language 758
 and Grammar 758
 constants 749
 fundamentals 6
 language(Locale) 142
 Languages__ 758
 lastError function 798
 Layout
 context 604
 DXL 604
 layoutDXL 470
 LDAP
 configuration 183
 data configuration 189
 server information 185
 left 517
 leftAligned 517
 length 72
 length (buffer get) 110
 length (buffer set) 111

- level (module get) 236
- level (module set) 236
- level (object get) 317
- level (trigger) 677, 684
- level modifiers 673
- levelModifier 679
- levels 672
- Lexical conventions 9
- Library description file format 541
- line 487
- Line spacing constant for 1.5 lines 145
- link(Trigger) 681
- linkIndicators (show/hide) 576
- linkIndicators (state) 576
- Links
 - access control 326
 - creation 326
 - management 334
 - operators 326
 - source 337
 - target 338
- linkset 340
- list 462
- listView 467
- load 241, 409, 576
- load (linkset) 341
- load (partition definition) 611
- load(ModuleVersion) 244
- loadBitmap 492
- loadDirectory 169
- loadInPartitionDef 611
- loadLdapConfig() 182
- loadUserRecord 168
- locale 143, 144
- Locale type 141
- Lock
 - manager 812
 - properties 812
- lock (module) 816
- lock (object) 398, 816
- lock(BaselineSetDefinition) 250
- Locking 398
- log (Real x) 69
- Logical colors 510
- Loop statements 20
- Looping within
 - projects 221
- Loops 8
- lower 72

M

- main (get) 601
- main (set) 601
- major(BaselineSet) 257
- markUp 274
- match function 102
- matches 103
- maximumAttributeLength 353
- mayEditDXL 173
- mayModifyDiscussionStatus 793
- member 181
- Menu
 - DXL file format 542
 - index file format 542
- menuBar 503
- Menus, status bar and tool bars example 504
- menuStatus 544
- Message boxes 410
- messageBox 412
- Minimum and maximum operators 65
- minor(BaselineSet) 258
- Miscellaneous
 - object functions 320
 - spelling 770
- mkdir 123
- mode 126
- modified 475
- modified (date) 126
- modify (attribute definition) 370
- modify (attribute type) 382
- module (containing object) 304
- module (handle) 225
- module (link) 337
- module (state) 204
- module(handle) 243
- module(Trigger) 679
- ModuleProperties 279
- Modules
 - access controls 223
 - display state 236
 - information 227
 - manipulation 231
 - menus 546
 - properties 279
 - recently opened 276
 - references 224
 - state 228
 - status bars 543
- moduleVersion(handle) 244

move (item) 210
 move (object) 313
 multiList 463
 Multi-value enumerated attributes 361

N

name (item) 204
 name (trigger) 679
 name (view) 577
 name(BaselineSetDefinition) 248
 name(Locale) 142
 name(ModuleVersion) 245
 Naming conventions 8
 Navigation from an object 309
 next (filtered) 577
 nextMajor 242
 nextMinor 242
 noElems 430
 noError function 799
 notNull 565
 null 58
 null constant 12
 Null statement 22
 number (history session) 269
 number (object get) 318

O

object 321
 object (absno) 303
 object (trigger) 679
 Objects
 access controls 301
 managing 312
 status 316
 of function 22
 ok (arrows) 479
 ok (buttons) 476
 OLE
 information functions 638
 objects 629
 OLE clipboard 629
 oleActivate 629
 oleCloseAutoObject 634
 oleCopy 631
 oleCount 636
 oleCreateAutoObject 657
 oleCut 632
 oleDeactivate 630

oleDelete 633
 oleGet 658
 oleGetAutoObject 657
 oleGetResult 656
 oleInsert 633
 oleIsObject 634
 oleLoadBitmap 653
 oleMethod 662
 oleOpen 634
 olePaste 635
 olePasteLink 635
 olePut 659
 oleResetSize 642
 oleSaveBitmap 636
 oleSetMaxWidth 641
 oleSetMinWidth 641
 oleSetResult 656
 open (partition file) 619
 open(Dictionary) 767
 openPictFile 653
 openProject 220
 Operating system
 commands 121
 interface 121
 Operations on
 all types 57
 type bool 59
 type char 60
 type int 63
 type real 66
 type string 70
 Operator functions 16
 Operators 389
 minimum and maximum 65
 template expressions 404
 unary 64
 opposite 517
 Options Constants 749
 optionsExist 138
 Out-partition properties 624
 Overloaded functions and operators 18

P

pageBreakLevel (get) 699
 pageBreakLevel (set) 699
 pageColumns (get) 703
 pageColumns (set) 703
 pageExpandHF 701
 pageFormat (get) 703

- pageFormat (set) 703
 - pageHeaderFooter (get) 700
 - pageHeaderFooter (set) 700
 - pageLayout 705
 - pageName 705
 - Pages
 - dimensions 696
 - setup information 702
 - setup management 704
 - pageTitlePage 704
 - pageTOCLevel (get) 699
 - pageTOCLevel (set) 699
 - parentRef(IntegrityProblem | ProblemItem) 781
 - parentRefID(IntegrityProblem | ProblemItem) 781
 - Parse time errors 797
 - Parsing 7
 - partition 390
 - Partitions
 - access 626
 - attribute properties 623
 - definition contents 612
 - definition management 609
 - definition properties 623
 - file properties 624
 - information 621
 - management 618
 - module properties 623
 - properties 622
 - view properties 623
 - pasteToEditbox 733
 - path (item) 205
 - Persistent triggers 670
 - Picture object support 644
 - pictureCompatible 655
 - pictureCopy 654
 - platform 121
 - polarLine 490
 - polygon 491
 - pow (Real x) 70
 - Pragmas 11
 - preloadedView 575
 - previous (filtered) 577
 - print 493
 - print (attribute base type) 378
 - print (base types) 58
 - print (date) 91
 - print (history type) 269
 - printCharArray 118
 - printModule 233
 - priority 681
 - ProblemItem 775
 - problems(IntegrityResultsData, string) 779
 - Progress bar
 - example program 527
 - introduction 525
 - progressCancelled 526
 - progressMessage 526
 - progressRange 526
 - progressStart 525
 - progressStep 526
 - progressStop 527
 - project (handle) 217
 - project (state) 204
 - Properties 389
 - Properties (Discussions) 785
 - purge (item) 209
 - purgeObjects_ 316
 - put (data in array) 117
 - put (oleAutoArgs) 662
 - put function 99
 - putString 118
- Q**
- qualifiedUniqueID 207
 - query 412
- R**
- radioBox 453
 - raise 419
 - random (int) 66
 - random (real) 70
 - Range 19
 - Read
 - and write operators 107
 - from stream 76, 83
 - line from stream 76, 84
 - read 149
 - read (open file) 77
 - read (open module) 234
 - read(BaselineSetDefinition) 251
 - readFile 78, 150
 - ready 419
 - Real colors 513
 - realBackground 483
 - realColor 484
 - realize (pending) 419
 - realize (show) 420

- realOf 68
- recentModules 277
- rectangle 486
- recv 133
- Reference operations 17
- refresh 238
- refreshDBExplorer 140
- refreshExplorer 140
- regexp 103
- regexp2 104
- region(Locale) 143
- registeredFormat 684
- regular 126
- Regular expressions
 - example program 104
 - introduction 101
- reimportPicture 654
- reject 565
- rejoinPartition 621
- rejoinReport 621
- release 420
- remove 770
- remove (lock) 818
- removeAttribute 616
- removeLinkModuleDescriptor 334
- removeLinkset 616
- removeModule 615
- removeModule(BaseLineSetDefinition) 250
- removePartition 621
- removeRecentlyOpenModule(ModuleVersion) 277
- removeUnlistedRichText 725
- removeView 616
- rename (archive item) 810
- rename (item) 210
- rename (partition definition) 611
- rename(BaselineSetDefinition) 248
- renameFile 80
- reopenDiscussion 791
- repaired(IntegrityProblem) 782
- repaired(ProblemItem) 782
- replaceRichText 732
- Reporting access control example 400
- requestLock 819
- resetColor 138
- resetColors 138
- restore (archive) 807
- restoreFiles 808
- restoreModule 808
- restoreProject 809

- restoreUserlist 809
- Return statement 21
- returnPartition 620
- Rich text
 - constructors 724
 - processing 723
 - strings 730
 - tags 723
- richClip 733
- richField 451
- richText (box) 474
- richText (column) 725
- richText (of attribute) 736
- richText (of string) 737
- RichText type properties 728
- richtext_identifier(Object) 733
- richTextFragment 739
- richTextNoOle 738
- richTextNoOle (column) 725
- RichTextParagraph type properties 727
- richTextWithOle 738
- richTextWithOle (column) 725
- right 517
- row 709
- rtfSubString 736
- runFile 665
- runStr 666
- Run-time errors 797

S

- save (module) 234
- save (page setup) 705
- save (partition definition) 611
- save (view definition) 588
- save (view) 578
- save(BaselineSetDefinition) 251
- save(SignatureInfo si, int &code) 289
- save(SpellingOptions) 761
- saveClipboardBitmapToFile 650
- saveDirectory 170
- saveDroppedPicture 688
- saveLdapConfig() 182
- saveModified (partition definition) 612
- saveUserRecord 169
- Scope 13
- scroll 603
- Scrolling functions 603
- scrollSet 503
- search 113

- sectionNeedsSaved 315
- select (archive item) 810
- select (element) 431
- selected (element) 431
- selected (item) 431
- selectedElems 464
- Semicolon and end-of-line 9
- send 133
- sendBroadcastMessage 822
- sendEMailNotification 165
- separator (dialog box) 446
- separator (menu) 558
- server 132
- serverMonitorIsOn 124
- session 92
- set 393
- set (char in buffer) 111
- set (choice element values) 436
- set (file selector) 437
- set (filter) 566
- set (HTML edit) 539
- set (icon) 438
- set (item value) 437
- set (key or mouse callback) 439
- set (list view callback) 442
- set (select and activate) 441
- set (select) 438
- set (select, deselect, and activate) 442
- set (selected status) 436
- set (sort function) 443
- set (sort) 571
- set (status bar message) 437
- set (tree view expand) 443
- set (trigger status) 681
- set (user property) 178
- set (value or selection) 434
- Set display state 238
- Set page dimension 697
- Set page properties status 696
- set(BaselineSetDefinition) 252
- set(DBE date_dbe) 455
- set(html callback) 530
- set(html URL) 531
- set(HTML view) 532
- set(SignatureInfo, Permission, string name) 285
- set(SignatureInfoSpecifier___, Permission, string name) 285
- setAccess 617
- setAccountsDisabled 156
- setAddressAttribute 192
- setAllCellsAlignment 716
- setAllCellsBorder 716
- setAllCellsShowChangeBars 716
- setAllCellsShowLinkArrows 716
- setAllCellsWidth 717
- setAnnotation(BaselineSet) 259
- setAttrFromHTML 821
- setCatalanOptions 764
- setCellAlignment 717
- setCellBorder 717
- setCellShowChangeBars 717
- setCellShowLinkArrows 718
- setCellWidth 718
- setCenteredSize 422
- setCheck 469
- setColumnAlignment 718
- setColumnShowChangeBars 718
- setColumnShowLinkArrows 719
- setColumnWidth 719
- setDatabaseMailPrefixText 153
- setDatabaseMailServer 158
- setDatabaseMailServerAccount 158
- setDatabaseMinimumPasswordLength 157
- setDatabaseName 155
- setDatabasePasswordRequired 157
- setDef 393
- setDefaultColorScheme 138
- setDefaultLinkModule 339
- setDefaultViewForModule 578
- setDefaultViewForUser 579
- setDescription 379
- setDescription (partition definition) 612
- setDescription(BaselineSetDefinition) 248
- setDescriptionAttribute 191
- setDisableLoginThreshold 159
- setDoorsBindNameDN 187
- setDoorsBindPassword 187
- setDoorsBindPasswordDB 187
- setDoorsGroupGroupDN 189
- setDoorsGroupRoot 188
- setDoorsUserGroupDN 188
- setDoorsUsernameAttribute 189
- setDoorsUserRoot 188
- setDropList 687
- setDropString 687
- setEmailAttribute 190
- setempty 111
- setEnglishOptions 762
- setenv 123

setExtraHeightShare(DBE) 528
 setExtraWidthShare(DBE) 528
 setFailedLoginThreshold 160
 setFocus 419, 444
 setFontSettings 139, 147
 setFrenchOptions 763
 setFromBuffer(DBE date_dbe) 456
 setFromBuffer(DBE, Buffer) 444
 setGermanOptions 763
 setGotFocus 427
 setGrammarLevel 765
 setGreekOptions 763
 setGroup 179
 setGroupMemberAttribute 193
 setGroupNameAttribute 193
 setGroupObjectClass 192
 setHTML 532
 setIgnoreReadOnly 767
 setImplied 394
 setInnerHTML 533
 setLabelSpecifier(SignatureInfo si, string newLabel) 288
 setLanguage 761
 setLdapServerName(string) 186
 setLegacyLocale 145
 setLimits(DBE date_dbe) 455
 setLineSpacing 145
 setLineSpacing(Locale) 146
 setLinkModuleDescriptorsExclusive 334
 setLocale 144
 setLoginFailureText 153
 setLoginLoggingPolicy 160
 setLoginNameAttribute 190
 setLoginPolicy 159
 setLostFocus 428
 setlower 112
 setMaxClientVersion 161
 setMaxValue 384
 setMessageOfTheDay 151
 setMessageOfTheDayOption 151
 setMinClientVersion 161
 setMinValue 385
 setOverridable 336, 337
 setParent 421
 setParent(ProblemItem, Folder) 781
 setPortNo 186
 setPos 422
 setPreloadedView 575
 setRealColor 516
 setRealColorOptionForTypes 379
 setRegistry 129
 setRichClip 134, 734
 setRichClip (buffer/RTF_string__) 734
 setRowWidth 719
 setRussianOptions 765
 setSearchObject 319
 setSelection 318
 setServerMonitor 124
 setShowDeletedItems(bool) 206
 setShowDescriptiveModules 140
 setShowFormalModules 140
 setShowLinkModules 140
 setShowTableAcrossModule 719
 setSize 422
 setSortColumn 469
 setSource 341
 setSpanishOptions 764
 setSpellingCheckingMode 765
 setSpellingFirst 766
 setTarget 341
 setTDBindName 196
 setTDBindPassword 196
 setTDPortNumber 195
 setTDServerName 195
 setTDUseDirectoryPasswordPolicy 197
 setTelephoneAttribute 191
 Setting access control, example program 399
 setTitle 423
 setUKOptions 762
 setUpExtraction 275
 setuppper 112
 setURL 531
 setUseLdap() 182
 setUser 179
 setUseTelelogicDirectory 194
 setVal 393
 share (open module) 234
 shareLock 818
 show (dialog box) 420
 show (element) 428
 show (window) 545
 showChangeBars (get) 579
 showChangeBars (show/hide) 579
 showDeletedModules 238
 showDeletedObjects (get) 579
 showDeletedObjects (show/hide) 579
 showDescriptiveModules (get) 141
 showExplorer 581
 showFormalModules (get) 141

- showGraphicsDatatips (get) 580
- showGraphicsDatatips (show/hide) 580
- showGraphicsLinks (get) 580
- showGraphicsLinks (show/hide) 580
- showing 421
- showingExplorer 580
- showLinkModules (get) 141
- showOlePropertiesDialog 637
- showPrintDialogs (get) 581
- showPrintDialogs (set) 581
- side1 (module) 341
- side2 (module) 342
- Signature types 283
- SignatureInfoSpecifier__ specifier(SignatureInfo) 283
- Simple
 - elements for dialog boxes 446
 - placement 516
- sin (Real Angle) 69
- Single line spacing constant 145
- size 126
- sizeof function 22
- Skip lists
 - example program 100
 - introduction 96
- slider 451
- softDelete (module) 235
- softDelete (object) 153, 315
- sort function 24
- sortDiscussions 792
- Sorting
 - example program 573
 - modules 569
- sorting 571
- soundex 72
- source 344
- sourceAbsNo 338
- sourceVersion 332
- Specific
 - object 309
 - windows 545
- specific 394
- specific(BaselineSetDefinition) 252
- specificDef 394
- specificVal 394
- spell 751, 753
- Spell check mode constants 750
- spellFix 752
- Spelling dictionary 767
- Spelling/Dictionary Example programs 771
- SpellingErrors__ 755
- spGetLanguages 758
- splitHeadingAndText 322
- splitter 447
- sqrt (Real x) 70
- stacked 518
- Standard
 - combo box controls 551
 - items 546
 - menus and submenus 546
 - streams 75
- start (of match) 104
- startConfiguringMenus 423
- startPrintJob 493
- Statements
 - break 21
 - compound 19
 - conditional 19
 - continue 21
 - loop 20
 - null 22
 - return 21
- status 543
- Status handle programs example 128
- statusBar 503
- stopConfiguringMenus 423
- stored 682
- string
 - ansi(utf8String) 194
 - utf8(ansiString) 194
- stringOf 93
- stringOf (attribute base type) 378
- stringOf (buffer) 112
- stringOf (filter) 566
- stringOf (history type) 268
- stringOf (rich text) 737
- stringOf (sort) 571
- stringOf (trigger) 677
- stringOf (user class) 181
- Strings 13
- struct
 - signatureEntry {} 283
 - signatureInfo {} 283
- Substring extraction from buffer 108
- suffix 242
- suffix(BaselineSet) 258
- Support 826
- supportedPictureFormat 655
- surname 174

symbolic 126
 synchExplorer 140
 synergyUsername 173
 Syntax 7
 system 124

T

tab 461
 Table
 constants 707
 management 708
 manipulation 712
 of symbols 824
 table 709
 table (create) 708
 tableContents (get) 709
 tableContents (set) 710
 tan (Real Angle) 69
 targetAbsNo 339
 targetVersion 333
 tempFileName 79
 Template
 expressions 404
 functions 403
 template 403
 templates 471
 Text
 buffers 105
 buffers example program 113
 editor elements 473
 text (box) 474
 text (column) 601
 text(IntegrityCheckItem) 781
 timestamp(IntegrityCheckItem) 779
 title (get) 602
 title (set) 602
 today 91
 toggle 454
 toolBar 506
 toolBarComboAdd 509
 toolBarComboCount 508
 toolBarComboDelete 509
 toolBarComboEmpty 508
 toolBarComboGetItem 508
 toolBarComboGetSelection 507
 toolBarComboInsert 509
 toolBarComboSelect 508
 toolBarMove 510
 Toolbars 506

toolBarShow 510
 toolBarVisible 509
 top (module) 304
 topMost 423
 toTable 720
 treeView 469
 trigger (dynamic) 676
 trigger (persistent) 675
 trigger status 673
 Triggers
 constants 672
 definition 674
 dynamic 670
 events 668, 669
 introduction 667
 level assembly 674
 manipulation 677, 684
 overview 670
 persistent 670
 priority 670
 scope 668
 type (attribute) 357
 type (item) 206
 type (trigger) 677, 684
 Type bool
 comparison 60
 constants 60
 operations on 59
 Type char
 comparison 61
 operations on 60
 Type int, operations on 63
 Type real
 comparison 67
 operations on 66
 pi 66
 Type real constants 12
 Type string
 comparison 70
 operations on 70
 substring extraction 71
 type(IntegrityCheckItem) 779
 type(IntegrityProblem) 780
 type(ProblemItem) 780
 Types 14

U

unApplyFiltering 567
 Unary operators 64

- undelete (item) 209
- undelete (object) 315
- undeleteCell 710
- undeleteColumn 710
- undeleteRow 710
- undeleteTable 710
- undoMarkUp 275
- unicodeString 359
- uniqueID 206
- uniqueID(IntegrityCheckItem) 778
- uniqueID(IntegrityProblem) 778
- uniqueID(ProblemItem) 778
- unixerror function 799
- unload (linkset) 342
- unload (module) 342
- unlock (module) 817
- Unlock object functions 399, 819
- unlock(BaselineSetDefinition) 250
- unset 395
- unset(BaselineSetDefinition) 253
- unset(SignatureInfo, string name) 286
- unset(SignatureInfoSpecifier__, string name) 286
- unsetAll 395
- unsetAll(BaselineSetDefinition) 253
- unsetAll(SignatureInfo) 286
- unsetAll(SignatureInfoSpecifier__) 286
- unsetDef 395
- unsetVal 395
- updateGroupList() 183
- updateToolBars 507, 544
- updateUserList() 183
- upper 72
- useAncestors (get and set) 588
- useAutoIndentation 595
- useColumns (get and set) 590
- useCompression (get and set) 592
- useCurrent (get and set) 589
- useDefaultTableAttribute 720
- useDescendants (get and set) 589
- useFiltering (get and set) 593
- useFilterTables (get and set) 590
- useGraphics (get and set) 591
- useGraphicsColumn (get and set) 590
- useLevel (get and set) 592
- useOutlining (get and set) 591
- user 126
- User class constants 175
- user(BaselineSet) 258
- userLocale 142

- username 124, 396
- useRTFColour 445
- useSelection (get and set) 589
- useShowDeleted (get and set) 593
- useShowExplorer (get and set) 591
- useShowLinkIndicators (get and set) 594
- useShowLinks (get and set) 594
- useShowPictures (get and set) 593
- useShowTables (get and set) 594
- useSorting (get and set) 592
- useTooltipColumn (get and set) 595
- useWindows (get and set) 595

V

- validateDOORSURL 351
- value 682
- value(Trigger) 681
- Variables 13
- version 228
- version(Trigger) 680
- Versioned links 331
- versionID(BaselineSet) 258
- versionString(ModuleVersion) 246
- Vertical navigation 309
- view 574
- Views
 - access controls 584
 - definitions 587
 - elements 465
 - example program 585

W

- warn function 800
- warningBox 411
- when (history session) 270
- who (history session) 270
- width 485
- width (get) 602
- width (set) 603
- wildcard 771
- window 544
- Windows registry 128
- write 149
- write (open file) 77
- Write to stream 77, 84

