

# User Guide

RATIONAL ROSE® REALTIME CONNEXIS

VERSION: 2002.05.00

PART NUMBER: 800-025101-000

WINDOWS/UNIX



**IMPORTANT NOTICE**

**COPYRIGHT**

Copyright ©1993-2001, Rational Software Corporation. All rights reserved.

Part Number: 800-025101-000

Version Number: 2002.05.00

**PERMITTED USAGE**

THIS DOCUMENT CONTAINS PROPRIETARY INFORMATION WHICH IS THE PROPERTY OF RATIONAL SOFTWARE CORPORATION (“RATIONAL”) AND IS FURNISHED FOR THE SOLE PURPOSE OF THE OPERATION AND THE MAINTENANCE OF PRODUCTS OF RATIONAL. NO PART OF THIS PUBLICATION IS TO BE USED FOR ANY OTHER PURPOSE, AND IS NOT TO BE REPRODUCED, COPIED, ADAPTED, DISCLOSED, DISTRIBUTED, TRANSMITTED, STORED IN A RETRIEVAL SYSTEM OR TRANSLATED INTO ANY HUMAN OR COMPUTER LANGUAGE, IN ANY FORM, BY ANY MEANS, IN WHOLE OR IN PART, WITHOUT THE PRIOR EXPRESS WRITTEN CONSENT OF RATIONAL.

**TRADEMARKS**

Rational, Rational Software Corporation, Rational the e-development company, ClearCase, ClearCase Attache, ClearCase MultiSite, ClearDDTS, ClearQuest, ClearQuest MultiSite, DDTS, Object Testing, Object-Oriented Recording, ObjecTime & Design, Objectory, PerformanceStudio, ProjectConsole, PureCoverage, PureDDTS, PureLink, Purify, Purify'd, Quantify, Rational, Rational Apex, Rational CRC, Rational Rose, Rational Suite, Rational Summit, Rational Visual Test, Requisite, RequisitePro, RUP, SiteCheck, SoDA, TestFactory, TestFoundation, TestMate, The Rational Watch, AnalystStudio, ClearGuide, ClearTrack, Connexis, e-Development Accelerators, ObjecTime, Rational Dashboard, Rational PerformanceArchitect, Rational Process Workbench, Rational Suite AnalystStudio, Rational Suite ContentStudio, Rational Suite Enterprise, Rational Suite ManagerStudio, Rational Unified Process, SiteLoad, TestStudio, VADS, among others, are either trademarks or registered trademarks of Rational Software Corporation in the United States and/or in other countries. All other names are used for identification purposes only, and are trademarks or registered trademarks of their respective companies.

Microsoft, the Microsoft logo, Active Accessibility, Active Channel, Active Client, Active Desktop, Active Directory, ActiveMovie, Active Platform, ActiveStore, ActiveSync, ActiveX, Ask Maxwell, Authenticode, AutoSum, BackOffice, the BackOffice logo, BizTalk, Bookshelf, Chromeffects, Clearlead, ClearType, CodeView, Computing Central, DataTips, Developer Studio, Direct3D, DirectAnimation, DirectDraw, DirectInput, DirectMusic, DirectPlay, DirectShow, DirectSound, DirectX, DirectXJ, DoubleSpace, DriveSpace, FoxPro, FrontPage, Funstone, IntelliEye, the

IntelliEye logo, IntelliMirror, IntelliSense, J/Direct, JScript, LineShare, Liquid Motion, the Microsoft eMbedded Visual Tools logo, the Microsoft Internet Explorer logo, the Microsoft Office Compatible logo, Microsoft Press, the Microsoft Press logo, Microsoft QuickBasic, MS-DOS, MSDN, Natural, NetMeeting, NetShow, the Office logo, One Thumb, OpenType, Outlook, PhotoDraw, PivotChart, PivotTable, PowerPoint, QuickAssembler, QuickShelf, Realation, RelayOne, Rushmore, SourceSafe, TipWizard, TrueImage, TutorAssist, V-Chat, VideoFlash, Virtual Basic, the Virtual Basic logo, Visual C++, Visual FoxPro, Visual InterDev, Visual J++, Visual SourceSafe, Visual Studio, the Visual Studio logo, Vizact, WebBot, WebPIP, Win32, Win32s, Win64, Windows, the Windows CE logo, the Windows logo, Windows NT, the Windows Start logo, and XENIX are trademarks or registered trademarks of Microsoft Corporation in the United States and other countries.

FLEXIm and GLOBEtrotter are trademarks or registered trademarks of GLOBEtrotter Software, Inc. Licensee shall not incorporate any GLOBEtrotter software (FLEXIm libraries and utilities) into any product or application the primary purpose of which is software license management.

Portions Copyright ©1992-20xx, Summit Software Company. All rights reserved.

**PATENT**

U.S. Patent Nos. 5,193,180 and 5,335,344 and 5,535,329 and 5,835,701. Additional patents pending.

Purify is licensed under Sun Microsystems, Inc., U.S. Patent No. 5,404,499.

**GOVERNMENT RIGHTS LEGEND**

Use, duplication, or disclosure by the U.S. Government is subject to restrictions set forth in the applicable Rational Software Corporation license agreement and as provided in DFARS 277.7202-1(a) and 277.7202-3(a) (1995), DFARS 252.227-7013(c)(1)(ii) (Oct. 1988), FAR 12.212(a) (1995), FAR 52.227-19, or FAR 227-14, as applicable.

**WARRANTY DISCLAIMER**

This document and its associated software may be used as stated in the underlying license agreement. Rational Software Corporation expressly disclaims all other warranties, express or implied, with respect to the media and software product and its documentation, including without limitation, the warranties of merchantability or fitness for a particular purpose or arising from a course of dealing, usage, or trade practice.



# *Contents*

---

## **Preface i**

Road Map ii

Related Documentation ii

How to Get Help iii

When contacting Rational technical support iii

Rational web site iii

Other Resources iii

Contacting Rational Technical Publications iv

Contacting Rational Technical Support iv

## **Chapter 1 Rational Connexis Overview 5**

Key Benefits of Connexis 5

Connexis Leverages Proven Standards 6

Connexis is Tightly Integrated with Rose RealTime 6

Connexis Provides Access Transparency 7

Connexis Provides Location Transparency 7

Connexis is Very Flexible and Easily Configurable 8

Connexis Provides Support for Testing Distributed Applications 9

Connexis is Designed to be Fault-tolerant and Reliable 9

Connexis Terminology and Definitions 11

---

Connexis Application Layers	13
UML Application	14
Ports in Rose RealTime	14
Distributed Connection Service	16
Transport	16
Locator Service	17
Using the locator	17
The HelloWorld Model	18
Running the HelloWorld Model	18
Additional HelloWorld Models	19
HelloWorldHotStandby	19
HelloWorldLoadSharing	19
HelloWorldOverflowToBackupService	19
HelloWorldRedundantLocator	20
Using Connexis	20

## **Chapter 2 Using Connexis Model Examples 21**

The BasicTest Model	21
The Quick Start Model	22
Quick Start Iteration 1 Model	22
Quick Start Iteration 2 Model	22
The HelloWorld Model	23
Running the HelloWorld Model	23
Additional HelloWorld Models	24
HelloWorldHotStandby	24
HelloWorldLoadSharing	24
HelloWorldOverflowToBackupService	24
HelloWorldRedundantLocator	25
The DCS Performance Model	25
Running the Performance Model	25
Performance model server output	27
Performance model client output	28

---

## **Chapter 3 Quick Start 31**

Quick Start Overview 31

Iteration 1: Creating the Rose RealTime Model 35

Step 1: Create a New Model 35

Step 2: Create Packages for the Model 35

Step 3: Create the Ping, Pong, and ContainerCapsules 38

Step 4: Create the PingPong Protocol Class 40

Step 5: Build the Structure of the Model 43

Step 6: Implement the State Machines for Ping and Pong 48

Step 7: Build and Test the Model 53

Iteration 2: Connexis Enabling our Application 59

Step 1: Remove the Connector Between the pingPong Ports 59

Step 2: Make Changes to Pong's pingPong Port 60

Step 3: Make Changes to Ping's pingPong Port 61

Step 4: Adding DCS Layer Notification to the Ping and Pong Capsules 63

Step 5: Modify Ping's State Machine to Wait for Connexis 64

Step 6: Modify Pong's State Machine to Wait for Connexis 65

Step 7: Modify Ping's State Machine to Wait for Notify 66

Step 8: Add Registration Code to the Ping and Pong Capsules 67

Step 9: Add the Connexis Configuration Capsules to Your Model 69

Step 10: Create and Configure the Ping Component 74

Step 11: Create and Configure the Pong Component 75

Step 12: Add Component Dependencies 77

Step 13: Build and Execute the Models 79

Basic Connexis Development Approach Summary 82

## **Chapter 4 Adding Connexis Support to Your Model 83**

Sharing DCS Interfaces 84

Sharing DCS Interfaces into your Model 84

Removing Shared Packages 85

---

Configuring Connexis Capsules	85
Manually Integrating Transports Into a Model	88
Configuring a Component for Connexis	90
Verifying Connexis Enabled Components	91
Initializing Your Connexis Capsule	92
Using the RTDInitStatus Protocol	93
Using Fixed Initialization Order	98
Converting Connexis Version 2000.02.10 Models to Connexis 2001A.04.00 Models	99
Verifying Component Compatibility with Connexis Version 2001A.04.00.	103
RTDErrorType Error Reporting	104

## **Chapter 5 Establishing Connections 107**

General Connection Patterns	108
Client/Server	108
Peer to Peer	109
Unwired Port Registration	110
What is Registration?	111
Port API	112
Automatic vs. Application Registration	113
Registration Parameters	115
Name Resolution	118
Connexis Connection Options	118
Local Connections	119
External Explicit Connections	124
External explicit examples	124
Locator Connections	125
Registration Summary	127
Scenario 1: Publisher Registered with the ILS	127
Scenario 2: Publisher Registered with the DCS	128
Scenario 3: Publisher Registered with the Locator	130
Multiple Publishers	131



---

Connection Design Heuristics	131
When to Use Replicated Publisher Ports	131
Use of Invokes	132
Use of Broadcast Sends	132
Use of Notification	133
Use of Defers	133
Sending Data	134
Sending Data Classes by Value	134

## **Chapter 6 Using the Connexis Locator Service 135**

Adding Locator Support to a Model	136
Publication and Subscription	136
Publication	136
Subscription	137
Ranking Published Ports	137
Load-sharing of Publishers	138
Examples	138
Locator Dynamics	140
Fully Subscribed Publishers	141
Subscriber Losing Connection to a Publisher	142
Locator Failure	142
Locator Race Condition	144
Unconnected Subscribers	145
Locator Configuration	145
Locator Parameters	145
Locator Parameter Examples	149
Creating your Own Name Service	150

## **Chapter 7 Using the Connexis Viewer 151**

Viewer Architecture	153
Adding Viewer Support to a Model	153
Adding Metrics Support to a Model	154

---

Starting the Connexis Viewer	155
Duplicate CNX Unique Identifiers	156
Viewer Main Window	156
Viewer Menus	158
File Menu	158
View Menu	158
Tools Menu	159
Windows Menu	161
Help Menu	161
Explorer Tree View	162
Processor Icons	163
Component Instance Icons	163
Filter Icons	164
Component Instance Status	164
Named Services Icons	165
Port Icons	165
Virtual Circuit Icons	166
Object Information Column	167
Popup Menus	168
Session Popup Menu	168
Processor Popup Menu	169
Component Instance Popup Menu	170
Port Reference Popup Menu	173
Virtual Circuit Popup Menu	174
Creating Processors and Component Instances	175
Adding a Processor	175
Changing the Properties of a Processor	176
Removing a Processor	177
Adding a Component Instance	177
Changing the Properties of a Component Instance	180

---

Performing Event Tracing	182
Defining a Trace Filter for a Component Instance	182
Setting trace filters	185
Defining a Port Reference Trace	188
Defining a Virtual Circuit Trace	192
Trace Window	194
Component Instance Trace Window	194
Virtual Circuit Trace Window	195
Trace Window Popup Menu	196
Show trace data	197
Define trace	199
Trace active	199
Select in tree	199
Clear	199
Save trace	199
Trace Header Context Menu	201
Generating Interaction Diagrams from Trace Output Files	202
Reporting of error messages	206
Log Window	206
Displaying the Metrics Collection	207
Starting Metrics Collection	208
Using the Metrics Window	208
Summary metrics collection	210
Detailed metrics collection	214
Messages metrics collection	216
Audits metrics collection	219
Engineering metrics collection	221
DCS errors metrics collection	225
Application errors metrics collection	228
Application incompatibility metrics collection	232
Stopping Metrics Collection	234
Saving Collected Metrics	234

---

Viewer Tips and Usage Notes	234
Capturing Pre-Viewer Session Messages	234
Error and Warning Tracing	235
Software errors	235
Software warnings	235
Maximizing Viewer Responsiveness	235

**Chapter 8 Using the Connexis Metrics Service 237**

Obtaining Metrics Data with a Metrics Service	237
Enabling Metrics in the DCS library	238
Adding a Metrics Port	238
Subscribing to the Metrics Service	238
Collecting and Processing Metrics	239
Using Metrics and the Connexis Viewer	243

**Chapter 9 Registration String Grammar 245**

Registration String Grammar for DCS Registrations	245
---	-----

**Chapter 10 Connexis Command Line Options 247**

Component Instance with Fixed Endpoints (no locator service)	247
Component Instance using CDM Endpoint, Locator using CDM	248
Component Instance using CDM and CRM Endpoints, Primary Locator using CDM, Backup Locator using CRM	249
Component Instance with CDM and CRM, CRM is Preferred Transport	250
Miscellaneous Command Line Options	250

**Chapter 11 Connexis Messages, Errors, and Warnings 255**

Initialization Messages	255
Initialization Errors	257
Parameter Errors	257

---

## **Chapter 12 Connexis Customization Reference 261**

- Engineering Rules Overview 262
  - Thread Configuration 262
    - Process view of a Connexis application 263
    - Default number of threads 264
    - The application layer 265
    - DCS and transport Layer 265
  - Buffer Configuration 266
    - Overall buffer configuration of a Connexis application 266
    - Application layer 267
    - DCS layer 268
    - Connexis buffer usage 270
  - Configuring the Number of Virtual Circuits 271
  - Verifying Connections 272
    - Handshake audit 272
    - Connection audit 273
    - Reset audit 273
- Command Line Options Reference 274
  - Setting Command Line Options 274
    - System wide 275
    - DCS options 277
    - Transporter options 278
    - Transport specific options 282
    - CDM 285
    - Locator 286
    - Connexis viewer/target agent 287

## **Chapter 13 Customizing and Porting DCS Libraries 289**

- Common customizations for the DCS 289
  - Other resources 290
  - Operating system capabilities 290
  - What to do before calling Rational support 290
- Porting the DCS to a New Target Configuration 290
  - Creating a New TargetRTS Library 291
  - Creating DCS Target Specific Header Files 292
  - Loading the DCS Model 293
  - Creating a C++ Library Component 293
  - Configuring the C++ Library Component Settings 294

---

- Configuring the CDR Encode/Decode Functionality 296
- Creating a Minimal DCS Library Configuration 296
- Building the Library 297
- Testing the Port 297

## **Chapter 14 Using the Transport Integration Framework 299**

- Transport Integration Overview 300
- DCS Architecture 301
- Terminology 302
- Connection Lifecycle 303
- DCS Threading Model 304
- Understanding your Transport 305
  - Determine the Name of your Transport and Protocols 306
  - Decide the String Format of the User-specified Address 306
  - Decide How to Validate the Address 306
  - Decide the Transformation of the Address 307
  - Determine the Internal Representation of your Address 308
  - Decide the Format of the Listening Point Information 309
  - Decide if your Transport is Blocking or Non-blocking 309
  - Decide the Recommended Address Resolution Configuration 310
  - Decide How the Transport will Recover from Transport Failures 311
  - Decide How to Audit your Transport 311
  - Decide the Format of your Messages 312
  - Decide Strategy for Listening for Messages 313
- Integrating your Transport 315
  - Setting up the Model 315
  - Understand the Integrated Transport 316
  - Implementing the RTDTransportAddressFactory Subclass 316
  - Implementing the RTDTransportAddress Subclass 317
  - Implementing the RTDTransportEndpointFactory Subclass 318
  - Implementing the RTDTransportEndpoint Subclass 319
  - Implementing the RTDTransport Subclass 320

---

Building the Transport Integration	321
Packaging the Transport Integration	321
Using the Transport Integration in Another Model	322
Testing the Transport Integration	322
TIF Classes	322
RTDTransportAddress	325
Constructors	327
RTDTransportEndpointFactory	331
RTDTransportEndpoint	332
Constructor	333
RTDTransport	339
RTDTIF	341
RTDTransportProfile	341
RTDConnexisAPI	348
<b>Appendix A Comparison of TCP/IP and UDP/IP</b>	<b>355</b>
<b>Index</b>	<b>357</b>







## *Preface*

---

This document is organized so that each chapter is as stand-alone as possible. This section provides a brief overview of the content of each chapter and several reading paths through the document based on reader knowledge.

“Rational Connexis Overview” on page 5, provides a brief introduction to Connexis, the solutions that it provides and its primary features.

“Quick Start” on page 31, provides a simple Connexis tutorial. This tutorial is also useful for those who are new to Rose RealTime.

“Adding Connexis Support to Your Model” on page 83 describes how to add Connexis support to your Rose RealTime model.

“Establishing Connections” on page 107, elaborates on the concepts presented in the Overview chapter. This chapter describes the different ways of creating connections using Connexis, the syntax for describing Connexis endpoints and the parameters that can be supplied as part of registering connection endpoints.

“Using the Connexis Locator Service” on page 135, describes the Connexis Locator Service and how to configure it to run in a distributed application.

“Using the Connexis Viewer” on page 151, describes the Connexis Viewer and how to configure it to view a distributed application.

“Using the Connexis Metrics Service” on page 237 describes how to collect DCS statistics from within a Rose RealTime executable model.

“Registration String Grammar” on page 245 provides information on the Backus-Naur Form (BNF) Grammar for the registerSAP and registerSPP commands.

“Connexis Command Line Options” on page 247 provides command line examples for commonly-used Connexis configurations.

“Connexis Messages, Errors, and Warnings” on page 255 provides information to assist users in developing and debugging their models.

“Connexis Customization Reference” on page 261, describes the different configuration options that can be used to customize how Connexis works.

“Customizing and Porting DCS Libraries” on page 289, describes the Distributed Connection Service and explains how to customize or port DCS libraries to a new target environment.

“Using the Transport Integration Framework” on page 299, describes the Connexis Transport Integration Framework and how to integrate common or customized transport in a distributed application.

“Comparison of TCP/IP and UDP/IP” on page 355, provides background information about TCP/IP and UDP/IP.

### Road Map

People who are new to Rose RealTime should review the Rose RealTime documentation followed by the Overview and Quick Start chapters of this document.

People who are new to Connexis, should read the Overview and Quick Start chapters before any other part of the manual.

If you are already familiar with Rose RealTime and have a good understanding of the problems that Connexis solves, you may want to start with Establishing Connections, and refer to the Overview chapter only when terms or concepts are unfamiliar to you.

### Related Documentation

---

The following is a list of documentation that is related to the Connexis product.

- Rose RealTime online Help and user documentation. This documentation is available online with the Rose RealTime product.
- ISO/IEC 10746-1 ODP Reference Model Part 1. This specification details the challenges and potential solutions to distributed computing.

## How to Get Help

---

This section describes procedures for interacting with Rational Software Corporation's technical support services.

### When contacting Rational technical support

When contacting technical support for Rose RealTime, please be prepared to supply the following information:

- Name, telephone number, and company name.
- Product version number (found in the viewer's **Help > About** dialog).
- Computer make and model.
- Make and version of the operating system.
- Make and version of development tools (configuration management program, compiler, linker, RTOS, requirements management program).
- Your log number (if you are calling about a previously reported problem).

If your site has a designated, on-site support person, please try to contact that person before contacting Rational technical support.

### Rational web site

You can contact technical support and obtain the latest product information through our web site at:

<http://www.rational.com/products/rosert>

## Other Resources

---

- Online Help is available for Rational Rose RealTime.  
Select an option from the **Help** menu.  
All manuals are available online, either in HTML or PDF format.  
To access the online manuals, click **Rose RealTime Online Documentation** from the **Start** menu.
- For more information on training opportunities, see the Rational University Web site: <http://www.rational.com/university>.

## Contacting Rational Technical Publications

---

To send feedback about documentation for Rational products, please send e-mail to our Technical Documentation Department at [techpubs@rational.com](mailto:techpubs@rational.com).

## Contacting Rational Technical Support

---

If you have questions about installing, using, or maintaining this product, contact Rational Technical Support.

Your Location	Telephone	Fax	E-mail
North America	(800) 433-5444 (toll free) (408) 863-4000 Cupertino, CA	(781) 676-2460 Lexington, MA	<a href="mailto:support@rational.com">support@rational.com</a>
Europe, Middle East, Africa	+31 (0) 20-4546-200 Netherlands	+31 (0) 20-4546-202 Netherlands	<a href="mailto:support@europe.rational.com">support@europe.rational.com</a>
Asia Pacific	+61-2-9419-0111 Australia	+61-2-9419-0123 Australia	<a href="mailto:support@apac.rational.com">support@apac.rational.com</a>

**Note:** When you contact Rational Technical Support, please be prepared to supply the following information:

- Your name, telephone number, and company name
- Your computer's make and model
- Your computer's operating system and version number
- Product release number and serial number
- Your case ID number (if you are following up on a previously-reported problem)



## *Chapter 1*

# *Rational Connexis Overview*

---

Rational Connexis is a Rational Rose for RealTime add-in product that provides connectivity for Unified Modeling Language (UML) models. Connexis is tightly integrated with Rose RealTime and is highly optimized for event-driven asynchronous systems.

Connexis improves an application's time to market by eliminating the need to design, develop, and test a custom Inter-Process Communications (IPC) mechanism. The use of a Commercial Off The Shelf (COTS) distribution component, such as Connexis, simplifies and de-risks the design and deployment of distributed systems.

## **Key Benefits of Connexis**

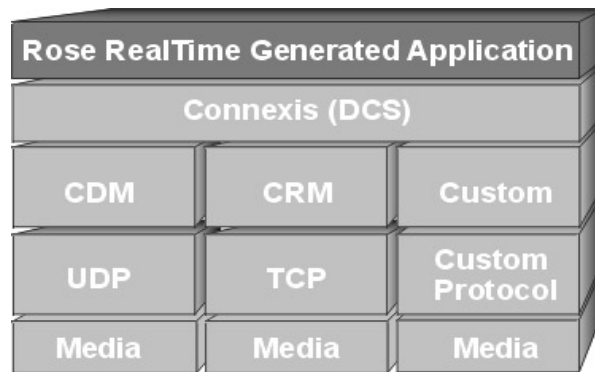
---

In addition to the time to market advantage of using Connexis, there are also several technical advantages to using Connexis. These are listed below and will be discussed in more detail in the following sections:

- Connexis Leverages Proven Standards
- Connexis is Tightly Integrated with Rose RealTime
- Connexis Provides Access Transparency
- Connexis Provides Location Transparency
- Connexis is Very Flexible and Easily Configurable
- Connexis Provides Support for Testing Distributed Applications
- Connexis is Designed to be Fault-tolerant and Reliable

## Connexis Leverages Proven Standards

Connexis is built upon current industry-standard technologies. Connexis supports sending UML-defined data classes between Rose RealTime models running in different processes and lets you integrate proven transports using the Connexis Transport Integration Framework. As shown in Figure 1, Connexis Datagram Messaging (CDM) is designed on top of UDP and Connexis Reliable Messaging (CRM) is designed on top of TCP. Connexis also supports custom messaging transports, allowing your applications to support native communication protocols to improve service.



**Figure 1** Connexis Architecture

## Connexis is Tightly Integrated with Rose RealTime

The Connexis product is tightly integrated with Rose RealTime. Adding Connexis support to a Rose RealTime model simply involves sharing Connexis packages, adding Connexis capsule roles to the model, and configuring components for your application. Transports that are integrated into Connexis are available to the application in the same manner as standard Connexis transports. Using transports provided by Connexis and using integrated transports are very similar. Once you have used one, you can use any other.

If you know how to use Rose RealTime, learning how to use Connexis is easy. Connexis ports are unwired ports in your Rose RealTime model that you register with the Target RSL using a Connexis registration string. The only concept that is new to a Rose RealTime user is the format of the Connexis registration string. Once the ports are registered, sending and receiving messages on them occurs in the exact same way as it does in a UML model that does not use Connexis.

### **Connexis Provides Access Transparency**

The flexible encoding and decoding strategy that is used by Connexis allows Connexis to work on different types of hardware environments. The endian of the target environment is transparent to the executing application.

### **Connexis Provides Location Transparency**

The Connexis Locator service provides location transparency for a distributed application. The application uses service names to refer to the endpoints that are being connected. As a result, the physical address of these endpoints never has to be revealed to the application. Locator features are available for services published on integrated transport addresses. Connexis also supports many different distribution options which allow the design of the application to be very flexible.

The following are the most common types of connections supported:

- **Local connections**

Connexis supports local connections which are optimized to be as efficient as directly wired ports. The endpoints of the local connections are registered using service names and Connexis takes care of binding the endpoints together. Once bound, these local connections have the same performance characteristics as two wired ports that have been bound together.

- **Explicit endpoint connections**

Connexis accepts registrations that use explicit endpoint addresses in the registration string. This can be used if the application knows the processor location of the services that it wants to access. In this way a client can bind to a service using the explicit processor location and the service name of the desired service.

- Locator connections

The Connexis Locator service can be used to find a service (given the service name) anywhere in the distributed application. Once the Locator has been started, one side of the connection registers with it as the publisher, and the other side registers as the subscriber. The Connexis Locator finds the appropriate endpoints, and feeds them back to the connection service which establishes the connection.

### Connexis is Very Flexible and Easily Configurable

Connexis supports a wide range of configuration options. This enables the engineering of Connexis to be very flexible and adaptable to different target environments. Configuration options are available to:

- configure connection audits
- adjust buffer counts and sizes
- adjust thread priorities and stack sizes
- adjust message delivery timing characteristics

The Target Agent, which interfaces to the Connexis Viewer, and the Connexis Locator Service do not have to be a part of every Connexis application. If your application does not use the Locator and you do not need access to the Connexis Viewer, these components can be left out of the node's configuration. This helps minimize the size of the Connexis code that gets linked in your application. For more information about the Connexis Viewer refer to "Using the Connexis Viewer" on page 151. For more information on the Connexis Locator Service refer to "Using the Connexis Locator Service" on page 135.

Connexis allows multiple ports to be registered with the same service name. This, coupled with the normal Rose RealTime feature of port multiplicity, enables several simple distribution patterns to be supported automatically by Connexis. Patterns that are not directly supported can usually be implemented very easily in Rose RealTime.

Connexis is shipped with full source. The library can be rebuilt if needed for a custom environment configuration.



## Connexis Provides Support for Testing Distributed Applications

One of the tools that comes with Connexis is the Connexis Viewer. The Connexis Viewer allows developers to attach to running Connexis applications and to graphically view connections as they are being established and taken down. The Viewer provides a minimally-intrusive tracing mechanism that allows you to trace messages that are being sent and received by any of the endpoints in a distributed application. The Viewer also receives messages from integrated transports and collects metrics information.

The traditional method of testing a distributed Rose RealTime application is to attach a probe on each end of a virtual circuit to make sure that the connection has been established. This method of testing does not scale well. In large systems, it is very difficult to know where the other end of a virtual circuit is in the model (consider systems with replicated publishers or multiple publishers with the same name). The Connexis Viewer simplifies the monitoring of distributed connections.

The Viewer also has the ability to import the deployment diagram from a Rose RealTime model so that the information about the distributed application does not have to be entered in two places. The Rose RealTime target observability feature can also be used to trace message flow on unwired Connexis ports.

The Connexis installation provides DCS libraries that are compiled with debugging capabilities for the Connexis Viewer and the Target Observability feature of Rose RealTime. This library configuration makes the initial debugging of distributed applications easier. As the application becomes more mature, consider building a minimal configuration of the DCS libraries for your target configuration. Building a minimal configuration is described in “Customizing and Porting DCS Libraries” on page 289.

## Connexis is Designed to be Fault-tolerant and Reliable

Fault tolerance and reliability are paramount to most real-time systems. Connexis has been designed with these requirements in mind. The following is a list of the different Connexis features that enhance the fault tolerance and reliability of Connexis:

- The Locator Service can be run in simplex or duplex mode. A binary elector is used to determine the health of the primary locator.

- Connexis has been designed with true non-blocking behavior. All potentially blocking system calls are handled by a user-configurable set of helper threads. Name resolving is an example of an operation that makes use of helper threads.
- A heart beat style audit is used over the UDP datagram based connections to detect connection / process / processor failure. This audit is tunable so that it can be used in a variety of environments. The audit is highly efficient since it monitors user messages to collect status information. This allows the explicit “Are you Alive” messages to be suppressed. When explicit “Are You Alive” messages are used, the number of such messages sent per unit of time can be capped to ensure that audits do not overutilize system resources. When a connection-oriented protocol (such as TCP) is used, only a very basic, “is the connection alive,” protocol is used.
- Buffering policies can be configured between the UML asynchronous messaging controller and the flow-controlled transport message router. This ensures that your model never hangs due to a slow or broken transport connection. When the queue fills up, messages are properly deleted from the system.
- It is easy to build a set of components that meet application specific requirements for fault-tolerance and reliability. A pair of generic signals, rtBound and rtUnbound, are supported for all Rose RealTime and Connexis ports. Notification can be enabled on a per-port basis and utilized by the application with minimal additional complexity.
- The underlying “try-forever” algorithm can be overridden by the application simply by deregistering the unwired port when quality of service parameters are not met.
- Patterns for distribution can be implemented using Connexis as the underlying distribution mechanism. For example, a single publisher can actually hide multiple distributed connections to a replicated service.
- Resource limits can be placed on publishers of services to limit the number of subscribers per publisher.
- The allocation of unwired ports to capsules is under the control of the designer and since the incarnation of capsules onto threads is also under control of the application, the application can dynamically control which resources are being used.

- Services can be ranked according to the preferred order of use. This ranking is done with full, dynamically updated knowledge of the resource limits. If a given service is full, one of a lower rank will be used if available.
- Configurable system audits verify that the internal system connection state matches across the entire system.

## Connexis Terminology and Definitions

---

Table 1 lists and defines Connexis and UML terms and acronyms.

**Table 1** *Definitions*

<b>Term</b>	<b>Definition</b>
CDM	Connexis Datagram Messaging. A thin layer on top of UDP that provides additional support for connection auditing and quality of service parameters.
CRM	Connexis Reliable Messaging. A thin layer on top of TCP that provides additional support for connection auditing and quality of service parameters.
DCS	Distributed Connection Service. This is the key component used for connecting and managing the different parties in a connection.
DNS	Domain Name System (or Service), an Internet service that translates domain names into IP addresses. Because domain names are alphanumeric, they are easier to remember; however, the Internet is really based on IP addresses. Every time you use a domain name, a DNS service must translate the name into the corresponding IP address. For example, the domain name www.example.com might translate to 198.105.232.4.
duplex locator service	Refers to a configuration in which there are two locators. In normal operation, one locator acts as the active locator and the other acts as the standby locator. This configuration is used to prevent a locator from being a single point of failure.
endpoint	An endpoint is an explicit network address used for finding a peer object. It consists of a protocol followed by a colon, followed by a protocol-address. For example: cdm://ipaddress:port.

**Table 1** *Definitions*

<b>Term</b>	<b>Definition</b>
ILS	Internal Layer Service. This is the connection service that is built into Rose RealTime. It can only be used for establishing intra-process connections.
IPC	Inter-Process Communication. This is a broad term that is being used to describe any mechanism that is used to share information between processes. This could be something as simple as shared memory or something as sophisticated as CORBA.
Locator	The Connexis Locator Service is a configurable service that is used to look up the physical location of an object given a service name for that object.
notification	The term used to describe the process of sending a message to a capsule to inform it when one of its ports has been connected to, or disconnected from, its peer.
SAP	Service Access Point. Term used to describe an unwired port that is participating in a connection as the subscriber. The SAP acronym appears in portions of the Run-time Service Library's API.
simplex locator service	Refers to a configuration in which there is only one locator. This configuration does not provide redundancy. See also "duplex locator service."
SPP	Service Provisioning Point. Term used to describe an unwired port that is participating in a connection as the publisher. The SPP acronym appears in portions of the Run-time Service Library's API.
tagged-values	Term used to represent the parameters that are being passed to the Connection Service when registering an unwired port.
Target RSL	Target Run-time System Libraries. These are the libraries that are compiled into a Rose RealTime model and that implement the messaging, state walking, and timing service (among other services) of a Rose RealTime model.
TCP/IP	Transmission Control Protocol / Internet Protocol. Connection-based transport protocol.
Transport	The underlying protocol that is being used to pass data between communicating objects.

**Table 1 Definitions**

<b>Term</b>	<b>Definition</b>
Transport Integration Framework (TIF)	A framework that lets 3rd parties (including developers) add additional transports for use in Connexis Messaging.
UDP	User Datagram Protocol. Connectionless transport protocol.
UML	Unified Modeling Language. An industry-standard modeling language used to model object-oriented software systems. UML is used by Rose RealTime and Connexis to model the software that is being built.
unwired port	An unwired port is a UML object that can have connections specified using registration names. These names can be specified at either design time or run-time.
virtual circuit	A virtual circuit is the term used to refer to a connection that has been established between two endpoints. This refers to a connection between a single subscriber and a single publisher.
wired port	A wired port is a UML object that can have an explicit connection (to another wired port) specified at design time. The connection will be established at system initialization time or at run-time if the port is contained in a capsule that is optional or plug-in.

## Connexis Application Layers

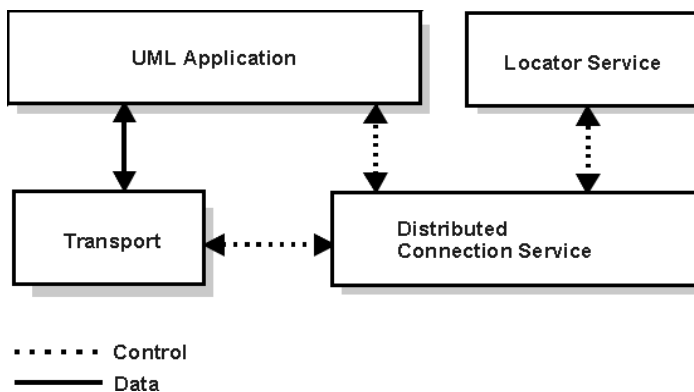
Connexis allows multiple Rose RealTime-generated executables to be connected in a robust and reliable manner. Executables are networked by connecting unwired ports across processor boundaries.

The Connexis programming model provides significant value:

- built for real-time - automatic mapping of UML communication ports onto a high-performance software backplane
- product-ready, but flexible - the software is ready to run as soon as it has been installed but can be adapted to handle project-specific requirements

- simple-to-use programming model - supports client/server type name binding and asynchronous messaging
- support for fault tolerance - detects failures and provides a framework for dealing with faults

A Rose RealTime application that is using Connexis to implement its inter-process communication has the high-level architecture shown in Figure 2. The control paths that are shown, indicate the components that are involved in registering and deregistering endpoints in the UML application. All data that is sent between endpoints in a Connexis-enabled application goes through the Transport component.



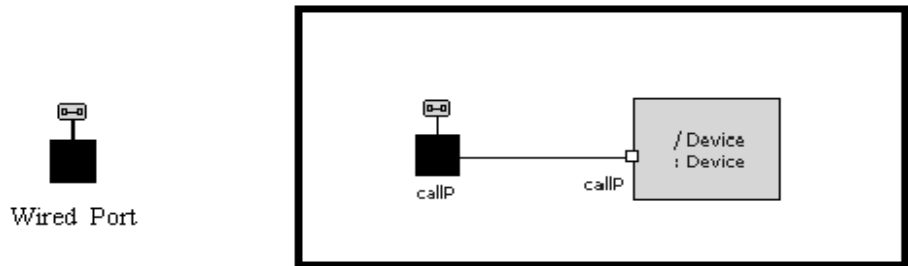
**Figure 2 High level view of a Connexis enabled application**

### UML Application

This section presents an overview of how Connexis is used from within Rose RealTime. For more information on Rose RealTime refer to the “*Rational Rose RealTime Toolset Guide.*”

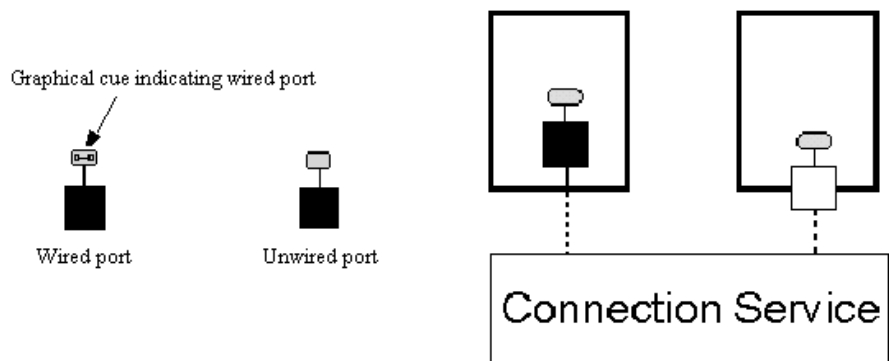
### Ports in Rose RealTime

In Rose RealTime, ports are used to send messages between the capsules in your model. Rose RealTime has several different kinds of ports. The most common type of port is a wired port as shown in Figure 3. Wired ports are visibly connected to other wired ports in Rose RealTime models. Wired ports are represented graphically with two connected squares in the oval part of the port icon.



**Figure 3 Connecting wired ports**

Another type of port that can be used in Rose RealTime is the unwired port. Unwired ports are the primary method for establishing Connexis connections. Once you have created an unwired port, you can specify the connection service, protocol, and endpoint address that it will use by registering the port with the Target RSL. This registration can either be done automatically or through application code. The Connection Service box in Figure 4 corresponds to the Distributed Connection Service box in Figure 2. The DCS is one implementation of a Connection Service.



**Figure 4 Connecting unwired ports**

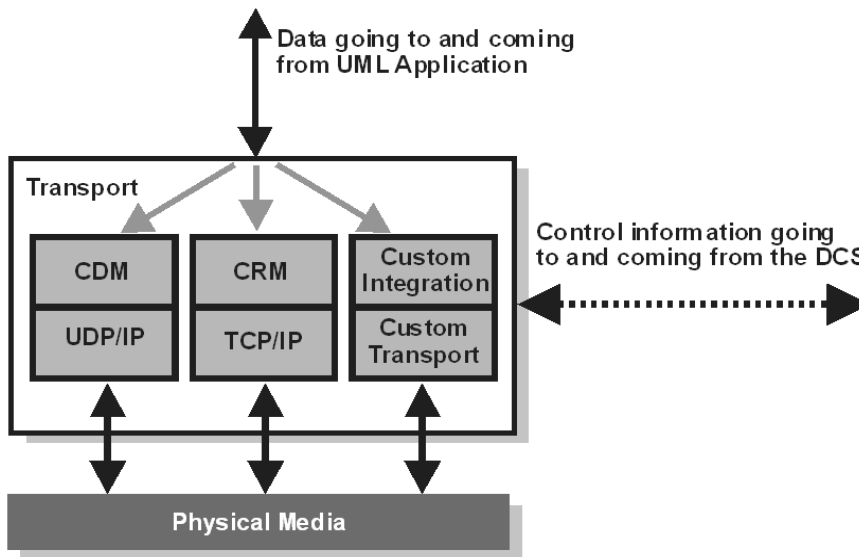
A more detailed discussion on the registration process is provided in “Establishing Connections” on page 107.

## Distributed Connection Service

The Distributed Connection Service (DCS) is the connection service that is provided with Connexis. It is responsible for maintaining information about the unwired ports that have been registered with it by a UML model. The DCS is the part of the system that is responsible for establishing connections between unwired ports. It does this by parsing the registration strings that are passed in when an unwired port registers with the Target RSL.

## Transport

The Transport is the component that is responsible for sending and receiving data between processes. It manages any incoming or outgoing data buffers and encodes and decodes data. A more detailed break-down of the Transport component is shown in Figure 5.



**Figure 5** Inside the Transport component



## Locator Service

Another key component of a robust distributed system is a fault-tolerant name service. A name service is used to find the actual location of a server given a predetermined service name. A well-known example of a name service is the Domain Naming Service (DNS) that is widely used on the Internet. The principle function of a name service is to look up a specific address when it is given a service name. This isolates the calling application from changes in the physical addressing of network components. In the Connexis product, the Locator Service provides the name service functionality.

The Locator Service actually does a bit more than just operate as a name server. The Locator can be configured to arbitrate between more than one endpoint that provides the same service and it can also be set up to run in duplex mode, which allows a backup Locator to automatically take over when the primary fails.

### Using the locator

An endpoint is defined to be the combination of a transport protocol and the address of a specific port in a distributed application. For example, `cdm://address:port`. If an explicit endpoint is provided, then the client will try to connect to the server at the specified endpoint. If a complete endpoint is not provided then the Locator is contacted. The Locator returns an endpoint that is then used by Connexis to choose the appropriate service provider or peer. The service name by which an endpoint is referred, is specified as part of the registration of that endpoint.

The Connexis Locator Service supports both a primary and a backup locator. In this way, a distributed application can be made more robust by ensuring that there is no single point of failure in the name server.

### The HelloWorld Model

---

The HelloWorld model implements a simple distributed model using Connexis. The model demonstrates the use of the Connexis Locator Service and how it can be used to easily provide backup service in a distributed environment.

The model contains two servers, a client, and the Connexis locator service, each running independently. The servers speak different languages (either English, or French). Initially, the client is bound to the server that comes up first. Once bound, the client makes requests to the server and the server sends back a greeting in the language it speaks.

If the server to which the client is bound becomes unavailable, the client is notified of the connection loss, and it rebinds to the backup server, which starts responding to the client requests in the language it speaks. For example, if the client is initially bound to the English server, it will start receiving greetings in English. If you then terminate the English server (for example, resetting through the RTS panel), the connection will be lost momentarily, the client will be rebound to the French server, and the client will start receiving the greetings in French.

**Note:** *The greetings are output to the DOS window (Windows) and the RTS Output window (Solaris), which comes up when the client is started.*

### Running the HelloWorld Model

The model can be run on all supported host platforms. To run the application, start up the matching (for example, VC++6.0) set of locator, client, EnglishServer and FrenchServer component instances.

- Keep the DOS (Windows) or RTS Output (Solaris) window for the client in view. The other DOS or RTS Output windows can be minimized to reduce screen clutter.
- Run all the component instances from the corresponding RTS panels.

- If you run the EnglishServer first, you should see “Hello World!!!” appear on the client DOS window repeatedly. At this point, you can terminate the EnglishServer instance by means of the RTS panel. The client will receive a connection loss, and will then switch over to the FrenchServer as soon it is rebound via the locator service. You should now start to see "Salut le monde!!!" displayed in the client DOS window.

### Additional HelloWorld Models

The following models are extensions of the HelloWorld model. They provide examples of distributed load-sharing and fault-tolerant patterns.

#### HelloWorldHotStandby

A client connects to two servers through a proxy actor, and continually sends greeting requests. The proxy forwards the message to both servers, and both of the servers respond back to the proxy, which in turn relays the message from the active server to the client. If there is no response from the active server within a specified time period, the other server becomes active, and starts to handle all the client requests.

#### HelloWorldLoadSharing

This model consists of two servers (an English and a French one) that supply greeting messages for multiple clients. The clients connect to the servers in a round-robin fashion. For example, if you had four clients, the first and the third client would connect to one server and the second and the fourth client would connect to the other server.

#### HelloWorldOverflowToBackupService

This model contains two servers (an English and a French one). One of the servers is given a higher rank so that it acts as the primary server. The clients connect to the primary server until the primary server has reached its full capacity. Any subsequent clients will connect to the backup server, which will handle their greeting requests for those clients.

### HelloWorldRedundantLocator

The model consists of one server, multiple clients, and a primary and a backup locator. The clients connect to the server using the primary locator. The server, in turn, provides greeting signals for the clients. If the primary locator is shut down, all subsequent client-server connections will be established using the backup locator.

## Using Connexis

---

There are several steps that must be taken to add Connexis support to a model. These are:

- share the RTDInterface package
- add Connexis component capsule roles to appropriate capsules in the model
- integrate transport protocols
- configure components for your application

**Note:** *The Connexis configuration dialogs on ports and capsules allow the user to perform these steps as well.*

In addition to these steps, there are also general design rules that must be followed to ensure that the Connexis components have been initialized properly before they are used.

Refer to “Adding Connexis Support to Your Model” on page 83 for more information on Connexis-enabling your application.



## *Chapter 2*

# *Using Connexis Model Examples*

---

With Connexis, four model examples are included to accelerate your learning and proficiency. The list of models are outlined below:

- The BasicTest Model can be used to verify your environment.
- The Quick start Model runs you through an introductory tutorial.
- The HelloWorld Model presents a simple distributed model.
- The Performance Model lets you evaluate the performance of Connexis-enabled models in your environment.

By default, components in these model examples specify 'localhost' (127.0.0.1) as the host machine. If you want to run the model examples remotely (that is, on a specific processor rather than the one you are on), you must modify the model examples first.

## **The BasicTest Model**

---

The BasicTest model implements a very simple client server distributed system and is intended for use as a simple model to test proper Connexis installation and operation on any of the Connexis-supported platforms.

All hosts and target configurations supported with your Connexis installation are provided.

To run the model on one of the supported configurations listed above, see "Verifying your installation using BasicTest, in the Release Notes and Installation Guide for Rational Rose RealTime Professional.

### The Quick Start Model

---

The “*Rational Connexis User Guide*” provides a Quick start tutorial (chapter 2) to allow you to quickly come up to speed on using Connexis. The tutorial is composed of three iterations. Iteration 1 takes you through building a simple ping pong model using Rose RealTime. Iteration 2 takes you through the steps required to Connexis-enable the ping pong model and make it distributed.

For your reference, complete, documented models for each iteration are provided as part of the model examples provided with Connexis. These examples can be run on all supported host platforms. For detailed instructions on using the Quick Start model, see “Quick Start” on page 31.

#### Quick Start Iteration 1 Model

The PingPong\_Iteration1 model is the completed version of the model developed in Connexis Quick start tutorial (Iteration 1). See “Quick Start” on page 31 for details.

This model implements a simple ping pong application using Rose RealTime. This model is used as a starting point for PingPong\_Iteration2 to show the simple steps required to quickly Connexis-enable an application built using Rose RealTime.

To run the model, compile the PingPongApp component instance corresponding to your host compiler, and choose run from the item menu of the component instance under the PingPongProcessor.

#### Quick Start Iteration 2 Model

The PingPong\_Iteration2 model is the completed version of the model developed in Connexis Quick start tutorial (Iteration 2). See “Quick Start” on page 31 for details.

This model implements a simple distributed ping pong application using Rose RealTime and Connexis. It is a Connexis-enabled version of the model developed in Iteration 1, and demonstrates the simplicity of distribution using Connexis.

To run the model, please compile the Ping and Pong component instances corresponding to your host compiler, and choose run from the item menu of the component instances under the PingPongProcessor.

## The HelloWorld Model

---

The HelloWorld model implements a simple distributed model using Connexis. The model demonstrates the use of the Connexis Locator Service and how it can be used to easily provide backup service in a distributed environment.

The model contains two servers, a client, and the Connexis locator service, each running independently. The servers speak different languages (either English, or French). Initially, the client is bound to the server that comes up first. Once bound, the client makes requests to the server and the server sends back a greeting in the language it speaks.

If the server to which the client is bound becomes unavailable, the client is notified of the connection loss, and it rebinds to the backup server, which starts responding to the client requests in the language it speaks. For example, if the client is initially bound to the English server, it will start receiving greetings in English. If you then terminate the English server (for example, resetting through the RTS panel), the connection will be lost momentarily, the client will be rebound to the French server, and the client will start receiving the greetings in French.

**Note:** *The greetings are output to the DOS window (Windows) and the RTS Output window (Solaris), which comes up when the client is started.*

## Running the HelloWorld Model

The model can be run on all supported host platforms. To run the application, start up the matching (for example, VC++6.0) set of locator, client, EnglishServer and FrenchServer component instances.

- Keep the DOS (Windows) or RTS Output (Solaris) window for the client in view. The other DOS or RTS Output windows can be minimized to reduce screen clutter.
- Run all the component instances from the corresponding RTS panels.

- If you run the EnglishServer first, you should see “Hello World!!!” appear on the client DOS window repeatedly. At this point, you can terminate the EnglishServer instance by means of the RTS panel. The client will receive a connection loss, and will then switch over to the FrenchServer as soon it is rebound via the locator service. You should now start to see "Salut le monde!!!" displayed in the client DOS window.

### **Additional HelloWorld Models**

The following models are extensions of the HelloWorld model. They provide examples of distributed load-sharing and fault-tolerant patterns.

#### **HelloWorldHotStandby**

A client connects to two servers through a proxy actor, and continually sends greeting requests. The proxy forwards the message to both servers, and both of the servers respond back to the proxy, which in turn relays the message from the active server to the client. If there is no response from the active server within a specified time period, the other server becomes active, and starts to handle all the client requests.

#### **HelloWorldLoadSharing**

This model consists of two servers (an English and a French one) that supply greeting messages for multiple clients. The clients connect to the servers in a round-robin fashion. For example, if you had four clients, the first and the third client would connect to one server and the second and the fourth client would connect to the other server.

#### **HelloWorldOverflowToBackupService**

This model contains two servers (an English and a French one). One of the servers is given a higher rank so that it acts as the primary server. The clients connect to the primary server until the primary server has reached its full capacity. Any subsequent clients will connect to the backup server, which will handle their greeting requests for those clients.



### HelloWorldRedundantLocator

The model consists of one server, multiple clients, and a primary and a backup locator. The clients connect to the server using the primary locator. The server, in turn, provides greeting signals for the clients. If the primary locator is shut down, all subsequent client-server connections will be established using the backup locator.

## The DCS Performance Model

---

With the DCS Performance Model, you collect performance data for intra-thread, inter-tread, and inter-processor messaging throughput. Using this data, you can evaluate message throughput and transport latency within your environment.

The performance model contains a client capsule and a server capsule that echo messages between each other. This lets you evaluate the amount of time required to send messages between capsules.

The model measures performance between capsules in the following scenarios:

- Client and server on the same thread
- Client and server on different threads
- Client and server in different processes (using the DCS)

The model also provides data that can be used to measure the message latency using raw socket-based inter-process communication (IPC).

## Running the Performance Model

Before compiling the components for the performance model, you must set the target configuration properties for the components. Once the components are built, the run-time operations must be configured to run either the CDM/UDP and CRM/TCP tests.

### To run the performance model

1. Set the C++ Compilation Target Services Library properly for the following components so that they can compile in your environment:
  - ThroughputClient
  - ThroughputServer

All intra-thread, inter-thread, and inter-process tests run within the `ThroughputClientInstance`. The `ThroughputServerInstance` is used for the IPC tests and the benchmark UDP/TCP tests.

2. Edit the properties of the “inclusion paths” to include the `TargetRTS` target specific header files.

For example, if you are running on a VxWorks target, the following inclusion path must be specified:

```
$RoseRT_Home/C++/TargetRTS/src/target/TORNADO1
```

**Note:** *These directories are not normally included in user models. They have been used in this model to facilitate portability to different target environments.*

3. Set the run-time options for the client’s component instance according to the following chart:

**Table 2 Run-time options for the client component**

Option	Description
-s<server address>:<port>	specifies the endpoint of the server and is used in the client's registration string. (ex.: -s192.139.252.84:9900). This parameter must correspond to the server endpoint specified using <code>-CNXep</code> .
-n<num msgs>	specifies the number of messages to be echoed between the client and server for each test.
-crm   -cdm	specifies which transport is to be tested.
-l<local port>	specifies the local port to be used for the raw TCP/UDP benchmarks.
-r<remote port>	specifies the remote port to be used for the raw TCP/UDP benchmarks. The remote address is obtained from the endpoint parameter (-s).

4. Set the run-time options for the server’s component instance according to the following chart:

**Table 3**

<b>Option</b>	<b>Description</b>
-crm   -cdm	specifies which transport is to be tested.
-l<local port>	specifies the local port to be used for the raw TCP/UDP benchmarks.
-CNXep = port -CNXep = CRM:port	specifies the endpoint where the server is listening.
-r<remote port>	specifies the remote port to be used for the raw UDP benchmarks.
-a<remote address>	specifies the remote address to be used for the raw UDP benchmarks.

5. Run CDM/UDP and CRM/TCP.

**Performance model server output**

```
Rational Rose RealTime C++ Target Run Time System
Release 6.30.B.01 (+c)
Copyright (c) 1993-2000 Rational Software
rosert: observability listening at tcp port 30503

*****
*           Please note: STDIN is turned off.           *
*   To use the command line, telnet to the above mentioned port. *
*   The _output_ of any command will be displayed in _this_ window. *
*****

Rational Software Corp. Connexis(tm) - Distributed Connection Service (dcs)
Release 6.30.B.154
Copyright (c) 1999-2000 Rational Software Corporation

dcs: CDM Transport : enabled
dcs: CDM listening at [cdm://192.139.252.171:9900]
dcs: locator service not available
dcs: metric service available

DCS Performance Test Begins
=====

Client address for benchmark tests: 192.139.252.171
Benchmark tests listening at port: 9800
Benchmark tests connecting to remote port: 8800
```

### Performance model client output

```
Rational Rose RealTime C++ Target Run Time System
Release 6.30.B.01 (+c)
Copyright (c) 1993-2000 Rational Software
rosert: observability listening at tcp port 30346
```

```
*****
*           Please note: STDIN is turned off.           *
*   To use the command line, telnet to the above mentioned port.   *
*   The _output_ of any command will be displayed in _this_ window. *
*****
```

```
DCS Performance Test Begins
=====
```

```
Number of messages per iteration: 10000
Server address for IPC tests: 192.139.252.171:9900
Benchmark tests listening at port: 8800
Benchmark tests connecting to remote port: 9800
Transport protocol to be tested: cdm
```

```
Intra-thread Througput Test
-----
```

```
Start time [s:ns]: 984682532:620000000
Finish time [s:ns]: 984682532:700000000
Message size: 16
Messages sent: 10000
Duration [in ms]: 80
```

```
Start time [s:ns]: 984682532:700000000
Finish time [s:ns]: 984682532:780000000
Message size: 64
Messages sent: 10000
Duration [in ms]: 80
```

```
Start time [s:ns]: 984682532:780000000
Finish time [s:ns]: 984682532:861000000
Message size: 256
Messages sent: 10000
Duration [in ms]: 81
```

```
Start time [s:ns]: 984682533:261000000
Finish time [s:ns]: 984682533:351000000
Message size: 1024
Messages sent: 10000
Duration [in ms]: 90
```

```
Start time [s:ns]: 984682533:351000000
Finish time [s:ns]: 984682533:501000000
Message size: 4096
Messages sent: 10000
Duration [in ms]: 150
```

```
Inter-thread Througput Test
-----
```

Start time [s:ns]: 984682533:501000000  
Finish time [s:ns]: 984682533:682000000  
Message size: 16  
Messages sent: 10000  
Duration [in ms]: 181

Start time [s:ns]: 984682533:912000000  
Finish time [s:ns]: 984682534:112000000  
Message size: 64  
Messages sent: 10000  
Duration [in ms]: 200

Start time [s:ns]: 984682534:112000000  
Finish time [s:ns]: 984682534:303000000  
Message size: 256  
Messages sent: 10000  
Duration [in ms]: 191

Start time [s:ns]: 984682534:513000000  
Finish time [s:ns]: 984682534:683000000  
Message size: 1024  
Messages sent: 10000  
Duration [in ms]: 170

Start time [s:ns]: 984682534:693000000  
Finish time [s:ns]: 984682534:914000000  
Message size: 4096  
Messages sent: 10000  
Duration [in ms]: 221

Rational Software Corp. Connexis(tm) - Distributed Connection Service (dcs)  
Release 6.30.B.154  
Copyright (c) 1999-2000 Rational Software Corporation

dcs: CDM Transport : enabled  
dcs: CDM listening at [cdm://192.139.252.171:2202]  
dcs: locator service not available  
dcs: metric service available

Inter-processor Throughput Test

-----

Start time [s:ns]: 984682535:134000000  
Finish time [s:ns]: 984682536:950000000  
Message size: 16  
Messages sent: 10000  
Duration [in ms]: 961

Start time [s:ns]: 984682536:105000000  
Finish time [s:ns]: 984682537:470000000  
Message size: 64  
Messages sent: 10000  
Duration [in ms]: 942

## Chapter 2 Using Connexis Model Examples

---

```
Start time [s:ns]: 984682537:57000000
Finish time [s:ns]: 984682538:68000000
Message size:      256
Messages sent:     10000
Duration [in ms]:  1011
```

```
Start time [s:ns]: 984682538:78000000
Finish time [s:ns]: 984682539:290000000
Message size:      1024
Messages sent:     10000
Duration [in ms]:  1212
```

```
Start time [s:ns]: 984682539:290000000
Finish time [s:ns]: 984682541:152000000
Message size:      4096
Messages sent:     10000
Duration [in ms]:  1862
```

### Inter-process Benchmark Test

-----

```
Start time [s:ns]: 984682541:173000000
Finish time [s:ns]: 984682541:513000000
Message size:      16
Messages sent:     10000
Duration [in ms]:  340
```

```
Start time [s:ns]: 984682541:523000000
Finish time [s:ns]: 984682541:823000000
Message size:      64
Messages sent:     10000
Duration [in ms]:  300
```

```
Start time [s:ns]: 984682541:833000000
Finish time [s:ns]: 984682542:144000000
Message size:      256
Messages sent:     10000
Duration [in ms]:  311
```

```
Start time [s:ns]: 984682542:144000000
Finish time [s:ns]: 984682542:524000000
Message size:      1024
Messages sent:     10000
Duration [in ms]:  380
```

```
Start time [s:ns]: 984682542:534000000
Finish time [s:ns]: 984682543:406000000
Message size:      4096
Messages sent:     10000
Duration [in ms]:  872
```

TESTS COMPLETE!!!!



## *Chapter 3*

# *Quick Start*

---

Connexis is a connection tool that provides robust, transparent communication between Rational Rose RealTime executable models. Rational Connexis is integrated with Rational Rose RealTime, which is a modeling tool that generates executables from UML models.

Connexis improves an application's time to market by eliminating the need to design, develop, and test a custom Inter-Process Communications (IPC) mechanism. The use of a production quality, Commercial Off The Shelf (COTS) distribution component, such as Connexis, simplifies and de-risks the design and deployment of distributed systems.

The Connexis Quick start presented in this chapter takes you through the general steps that are required to create and execute a Connexis-enabled application. To follow the steps laid out in this chapter, you should have:

- Rational Rose RealTime installed on your workstation
- Rational Connexis installed on your workstation
- a general understanding of Rational Rose RealTime and UML

## **Quick Start Overview**

---

The application to be created is a simple “ping pong” application. The clients send a ping message to the server, and the server responds with a pong message. Registration is accomplished using the Locator Service. The necessary command line options for starting the applications are also presented.

This application is created in three iterations:

- Iteration 1: Creating the Rose RealTime Model - creates the basic architecture using wired ports to connect the Ping and Pong capsules. This also involves a third capsule which acts as the container for the Ping and Pong capsules.
- Iteration 2: Connexis Enabling our Application- makes modifications so that Ping and Pong communicate through unwired ports that make use of Connexis connections.

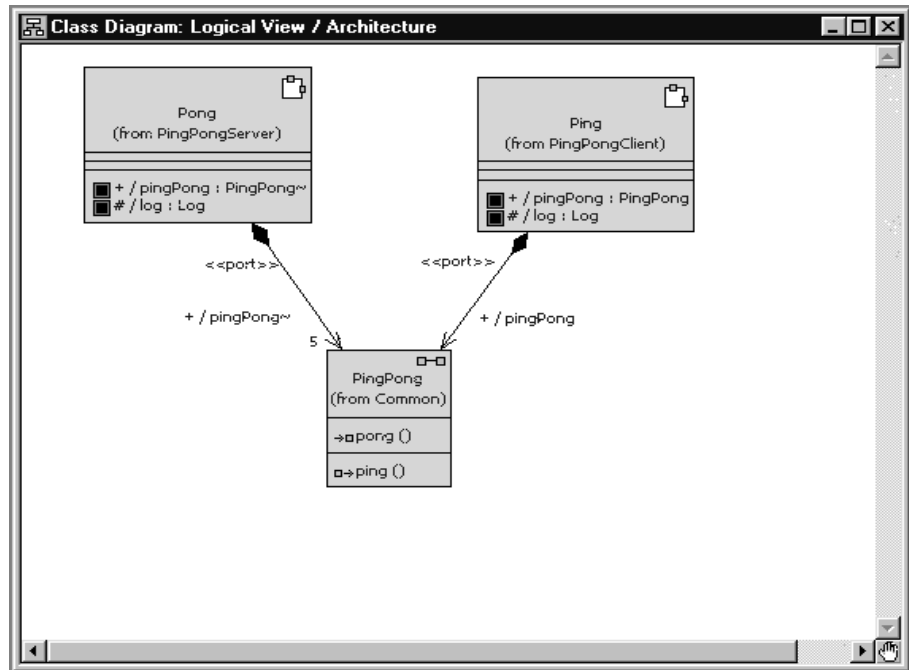
Iteration 1 focuses on creating a simple Rose RealTime model; therefore, readers who are familiar with Rose RealTime can start with the solution for Iteration 1, which is found in the examples directory, \$ROSET\_HOME\CONNEXIS\C++\examples. Iteration 2 focuses on Connexis-enabling the Rose RealTime model.

***Note:** The package organization of the example models differs slightly from this tutorial because the examples support multiple platforms; however, the model elements are the same.*

Many of the steps that are presented in these iterations are examples of good modeling practices. Explanations and the rationale behind these good modeling practices are presented where appropriate and are separated from the rest of the text by the heading “**Rationale for ...**”

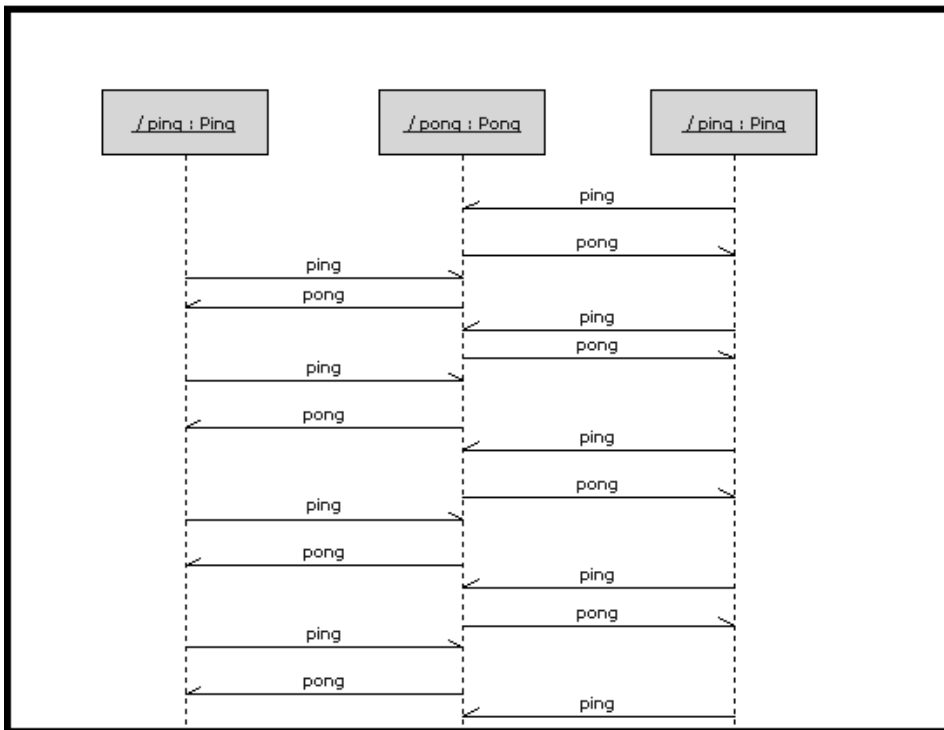


Figure 6 presents the final architecture of the model that is created in Iteration 2.



**Figure 6 Ping pong application architecture (at the end of Iteration 2)**

Even though the ping pong application is very simple it is still appropriate to present a sequence diagram that documents its behavior. The sequence diagram, shown in Figure 7, describes the messages that are sent between the Ping and Pong capsules. The events illustrated in this sequence diagram are discussed throughout the remainder of the Quick start.



*Figure 7 Ping Pong application sequence diagram*

## Iteration 1: Creating the Rose RealTime Model

Iteration 1 focuses on creating the Rose RealTime model that is used throughout the Quick start.

### Step 1: Create a New Model

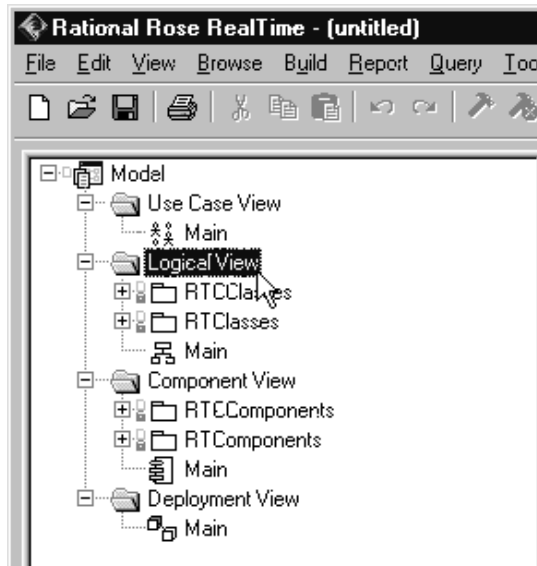
To create a new model in Rose RealTime:

1. Select **File > New**.

### Step 2: Create Packages for the Model

To create the ping pong client package:

1. Open the pop-up menu on the Logical View package in your Rose RealTime browser. Do this by right-clicking on the Logical View package as shown in Figure 8.



**Figure 8** *Creating packages*

2. Select **New > Package** from the pop-up menu.

3. While the default package name is selected, type in “PingPongClient” to set the name of the new package.

To create the ping pong server package:

Follow the same steps as those listed for “To create the ping pong client package:” except name the new package “PingPongServer.”

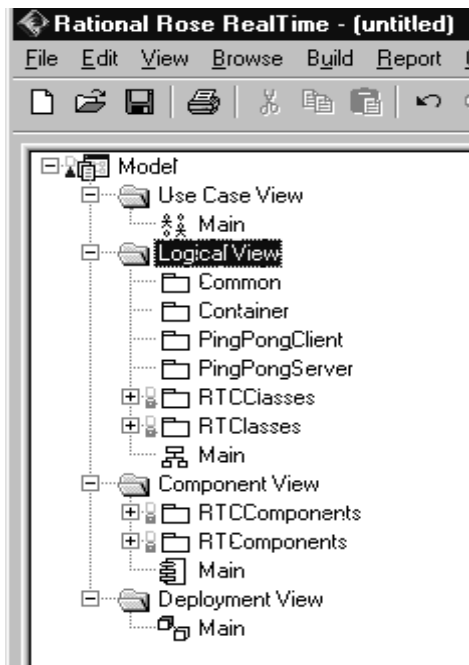
To create the ping pong container package:

Follow the same steps as those listed for “To create the ping pong client package:” except name the new package “Container.”

To create the ping pong utility package:

Follow the same steps as those listed for “To create the ping pong client package:”- except name the new package “Common.”

You should now have all of the packages that are required, as shown in Figure 9.



**Figure 9** Created packages

### **Rationale for creating packages**

It is good practice (although not required) to organize all of your Rose RealTime models into packages. You might think that it is overkill for a model that is as trivial as this one, but it is good to get in the habit of doing this, remember small models usually become big models eventually and it is easier to start off with packages than it is to add them later.

The main reasons for wanting to organize your models into packages are:

- ease of understanding and navigation - Packages give you an extra level of abstraction above what is provided by the classes and capsules in your model.
- separation of concerns - It is a good way of dividing the work that is to be done between teams or individuals on teams.

- configuration management - Packages are a possible unit of version control.
- access control - You can define the visibility of classes and capsules within packages. This makes it possible to control the access to design elements that are organized into packages.

There are many other reasons for wanting to organize your models into packages. For more information on this topic, refer to the “*Rose RealTime User’s Guide*.”

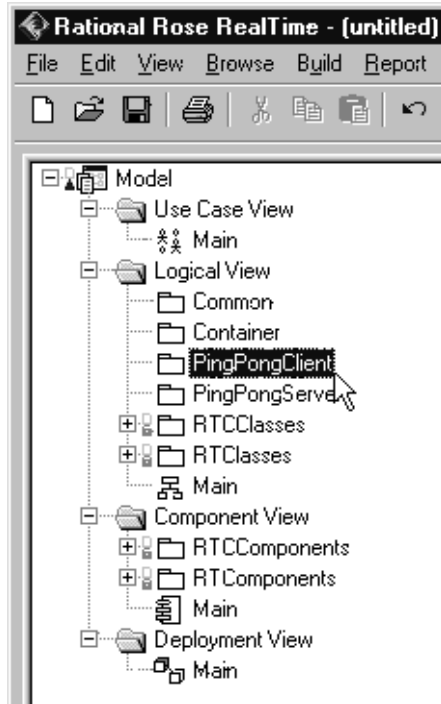
### Step 3: Create the Ping, Pong, and ContainerCapsules

In this application, the Ping capsule fulfills the role of a client. It is referred to as the client because it only manages a single connection. The server side of the application is responsible for managing multiple connections (one for each client it is connected to). The Pong capsule fulfills the role of the server in this application. The container capsule contains both the Ping and Pong capsules in Iteration 1 of the application.

Remember that the application is being built in two iterations; the first uses wired ports and the second uses Connexis-enabled, non-wired ports.

To create the Ping capsule:

1. Select the PingPongClient package as shown in Figure 10.



**Figure 10** Creating a new capsule

2. Open the pop-up menu and select **New > Capsule**.
3. While the default name of the new capsule is still highlighted, type in "Ping." This renames the new capsule.

To create the Pong capsule:

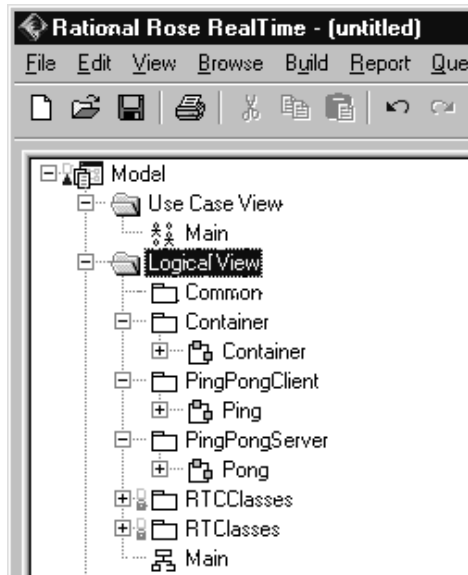
To create the Pong capsule, follow the same steps as those listed for "To create the Ping capsule:" except create the Pong capsule in the PingPongServer package.

To create the Container capsule:

To create the Container capsule, follow the same steps as those listed for "To create the Ping capsule:" except create the Container capsule in the Container package.

The connection topology that is used in this application is an oversimplification of a real-world distributed application. In real-world distributed applications, objects would typically take on the role of client in some communication scenarios and the role of server in others. Common connection topologies for distributed applications are discussed in “Establishing Connections” on page 107.

You should now have all of the capsules that are required as shown in Figure 11.



**Figure 11** Created capsules

### Step 4: Create the PingPong Protocol Class

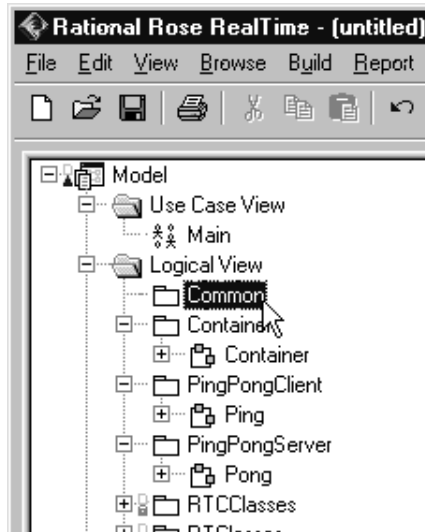
In Rose RealTime, capsules communicate with one another through ports. Ports are defined by a protocol. A protocol is a definition of a set of incoming signals, along with their associated data types, and a set of outgoing signals, along with their associated data types.

To create a protocol class:

1. Open the pop-up menu on the Common package by right-clicking on the Common Package as shown in Figure 12.
2. Select **New > Protocol** from the pop-up menu.



3. While the default name of the new protocol is still highlighted, type in "PingPong." This renames the new protocol.

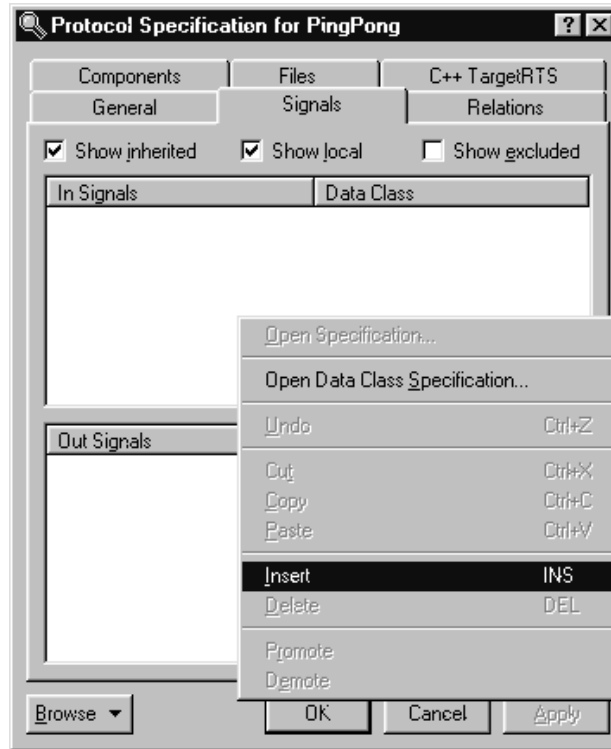


**Figure 12** *Creating protocol classes*

The PingPong protocol consists of an In Signal called pong, and an Out Signal called ping. Neither of these signals have data associated with them.

To add the signals to the protocol class:

1. Open the pop-up menu on the PingPong protocol class.
2. Select **Open Specification** from the pop-up menu.
3. Select the **Signals** tab.
4. Open the pop-up menu on the **In Signals** panel (by right clicking on the white space below **In Signals** as shown in Figure 13) and select **Insert**. A new signal is added and its default name is highlighted.



**Figure 13 Protocol specification window**

5. While the default name is highlighted, type in "pong." This names the In Signal pong.
6. Repeat steps 4 and 5 in the **Out Signal** panel. Name the Out Signal "ping."
7. Click the **OK** button.

**Rationale for choice of conjugation and signal names**


The In Signal is named pong because the protocol is defined from the perspective of the client. Remember that the client side of the application is implemented by the Ping capsule. The Ping capsule sends ping signals and receives pong signals; therefore, the protocol that is being used should have a pong In Signal and a ping Out Signal.

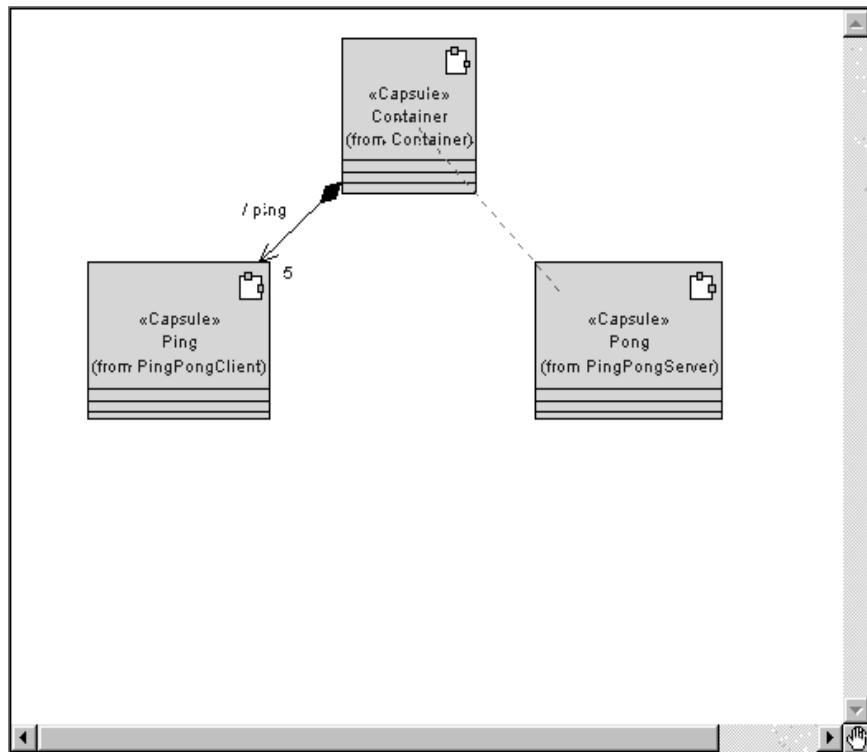
The practice of conjugating the server side of a connection is not required but it is a good way of keeping the naming of ports and protocols consistent. Conjugating the server side of a connection has the added benefit of reducing modeling efforts. Ports by default are not conjugated and there are usually more client ports than server ports.

### Step 5: Build the Structure of the Model

As was outlined in the introduction section of this chapter, the first iteration uses wired ports to connect the Ping and Pong capsules. This means that a capsule that acts as the container for the Ping and Pong capsules must be created. This is the capsule that was called Container.

To create Ping and Pong capsule roles in the Container capsule:

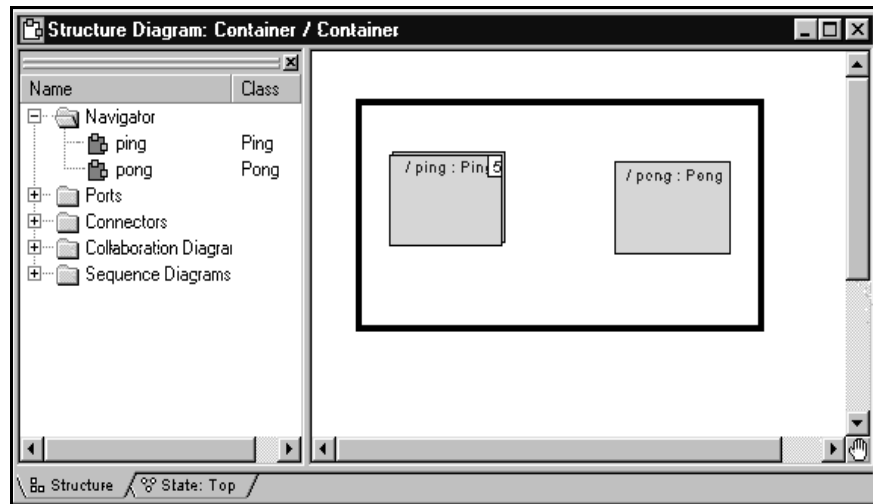
1. Create a new class diagram called "Architecture." This is done by right-clicking on the Logical View package and selecting **New > Class Diagram** from the pop-up menu.
2. Double-click Architecture to open the class diagram.
3. Drag one of each of the Ping, Pong, and Container capsule, from the browser onto the diagram.
4. Select the Unidirectional Aggregation tool .
5. Create an aggregation relationship between the Container capsule and the Ping capsule. Do this by clicking and dragging from the Container capsule to the Ping capsule as shown in Figure 14.



**Figure 14** *Creating aggregations between capsules*

6. Repeat step 5 to create an aggregation relationship between the Container capsule and the Pong capsule.
7. Select the Container/Ping aggregation and open its specification. Type in the name "ping."
8. Assign a cardinality of 5 to the Container/Ping aggregation.  
In a "real" application, the cardinality would be specified using a constant as opposed to a literal. A literal was used in this example only for brevity.
9. Click the **OK** button.
10. Select the Container/Pong aggregation and open its specification. Type the name "pong."
11. Click the **OK** button.

If you now open the structure diagram of the Container capsule, you should see a structure similar to what is shown in Figure 15.

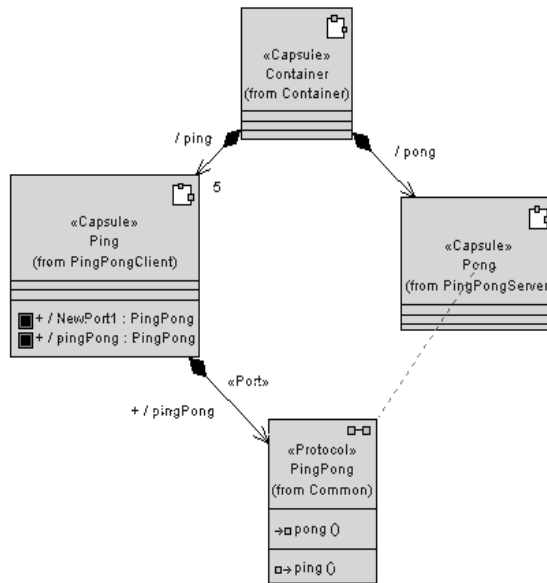


**Figure 15** Container capsule's structure diagram

**Note:** This containment structure could have been created just as easily from the structure editor of the Container capsule.

To create required ports on Ping and Pong capsules:

1. Drag the PingPong protocol class onto the Architecture class diagram.
2. Create an aggregation association between the Ping capsule and the PingPong protocol as shown in Figure 16. Name the association "pingPong."



**Figure 16 Creating ports from a class diagram**

3. Create an aggregation association between the Pong capsule and the PingPong protocol. Name the association “pingPong.”
4. Open the specification for the aggregation between the Pong capsule and the PingPong protocol.
5. Specify a cardinality of 5 and click the **Conjugated** check box.
6. Click the **OK** button.

To create a log protocol:

1. Select the Ping capsule.
2. Open its structure diagram.
3. Drag a log protocol onto the structure diagram. Do this by selecting the log protocol found in the RTClasses package in the Logical View package.
4. Select the log icon and open its specification.
5. Type in the name “log” and ensure that **Protected** is enabled.
6. Click the **OK** button.


### Rationale for visibility of ports

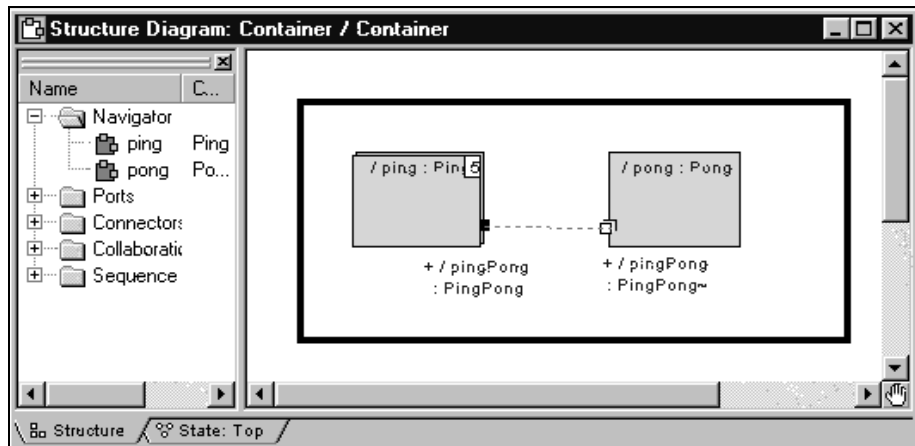
The log protocol is used to access the logging service that is built into the Rose RealTime libraries. The logging service is used primarily for printing messages to standard error during the initial debugging of models.

The PingPong port is shown in the class diagram because it is architecturally significant. The log port is shown in the structure diagram because it is an implementation detail; however, the log port could have been added to the class diagram, if desired, and the behavior would be exactly the same.

Repeat steps 1 to 6 for the Pong capsule.

To connect the Ping and Pong capsules:

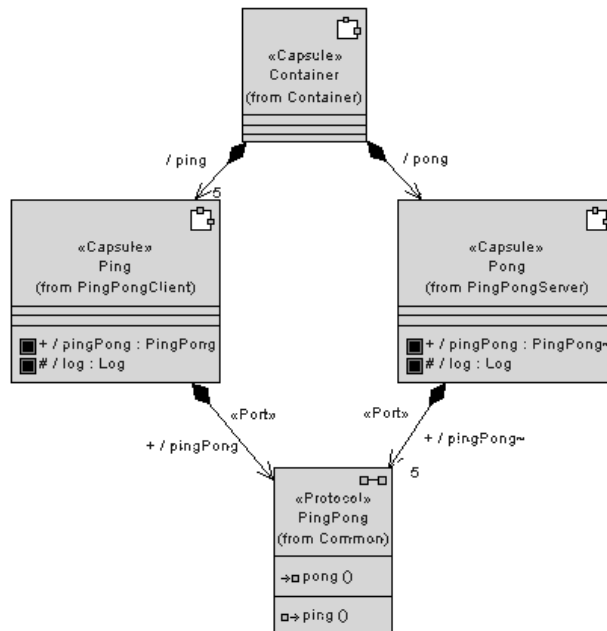
1. Open the structure editor for the Container capsule by right-clicking and choosing **Open Structure Diagram**.
2. Select the Connector tool .
3. Connect the pingPong port on the Ping capsule to the pingPong port on the Pong capsule as shown in Figure 17.



**Figure 17** Creating connectors between ports

The structure for Iteration 1 is now complete. Your class diagram should look the same as the one shown in Figure 18.

**Note:** To show the port and log icons, select the capsule and choose **Options > Show Visibility**.





**Figure 18 Completed structure for Iteration 1**

### Step 6: Implement the State Machines for Ping and Pong

To implement the state machines for the Ping and Pong capsules perform the steps listed below.

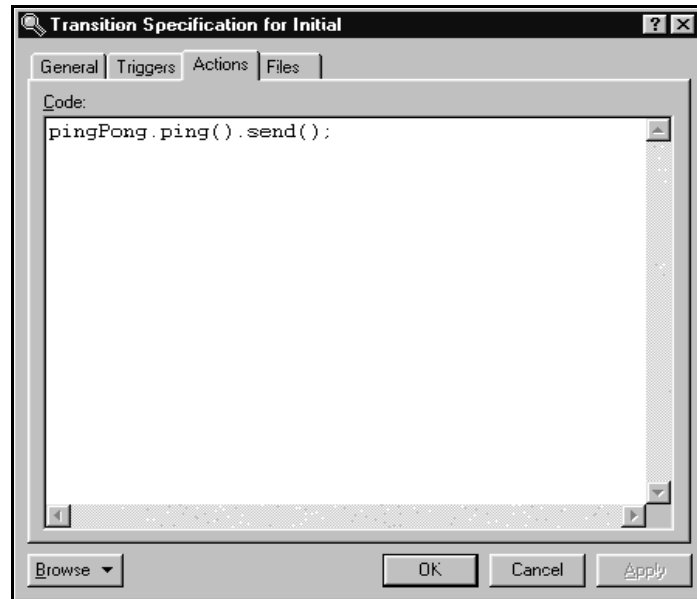
To create Ping’s state machine:

1. Select the Ping capsule.
2. Open the state editor by right-clicking and choosing **Open State Diagram**.
3. Select the state tool  and drop a state on the diagram. Do this by clicking the state tool and clicking anywhere on the diagram.
4. Name this state “ready.”
5. Select the transition tool  and draw the initial transition from the initial state to the ready state.




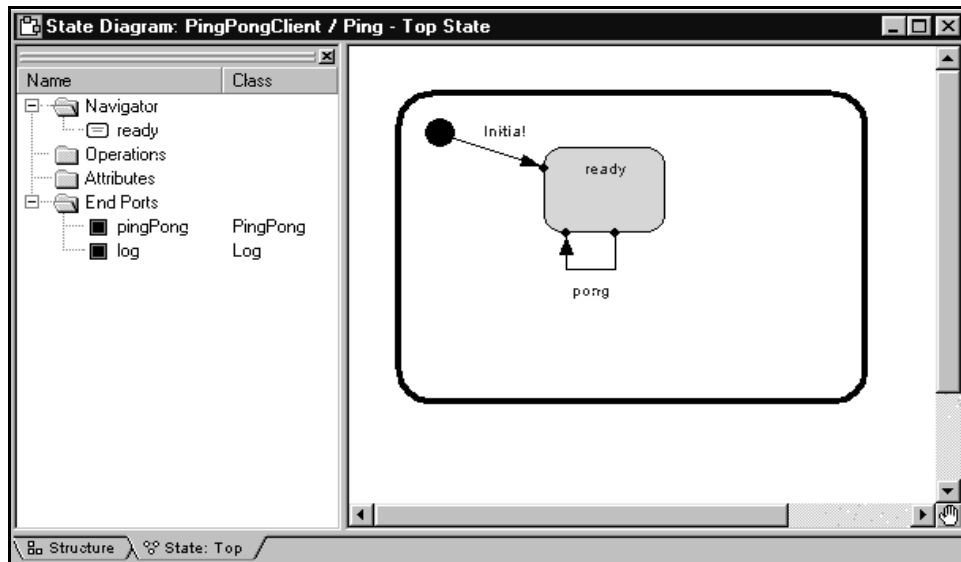
6. Double-click the transition, and select the **Actions** tab in the specification editor.
7. Type in the following code, and then click the **OK** button (see Figure 19).

```
pingPong.ping().send();
```



**Figure 19** Adding code to a transition

8. Select the self transition tool  and draw a self transition on the ready state, name this transition "pong." Your diagram should look similar to Figure 20.



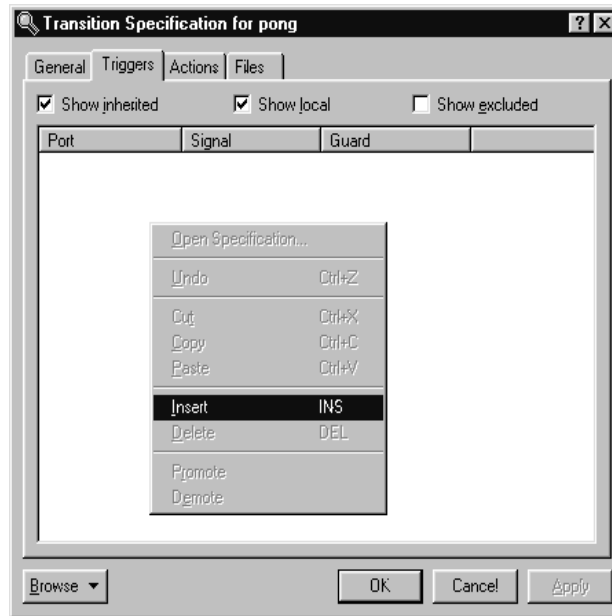
**Figure 20** Creating states

9. Double-click on the pong transition and select the **Actions** tab.
10. Type in the following code:

```
log.log("received a pong");
pingPong.ping().send();
```

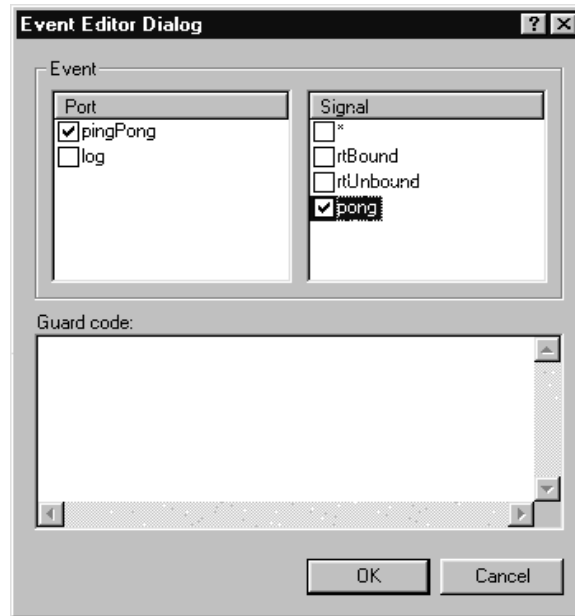
**Note:** In a real world application, you would not immediately send a Ping request. You would most likely perform additional processing where another event would trigger the sending of another Ping request.

11. Click the **Apply** button.
12. Select the **Triggers** tab.
13. Right-click in the control area and select **Insert** from the pop-up menu as shown in Figure 21.



**Figure 21** Adding triggers to a transition

14. Select the pingPong port and the pong signal from the resulting Event Editor dialog as shown in Figure 22 and click the **OK** button.



**Figure 22** *Selecting the port and signal*

To create Pong's state machine:

1. Open the state editor for the Pong capsule.
2. Select the state tool and drop a state on the diagram.
3. Name this state "ready."
4. Select the transition tool and draw the initial transition from the initial state to the ready state.
5. Select the self transition tool and draw a self transition on the ready state, name this transition "ping."
6. Double-click on the ping transition, and select the **Actions** tab in the specification editor.
7. Type in the following code:

```
log.log("received a ping");
rtport->pong().reply();
```
8. Click the **Apply** button.
9. Select the **Triggers** tab.

10. Right-click in the control area and select **Insert** from the pop-up menu.
11. Select the pingPong port and the ping signal from the resulting Event Editor dialog and click the **OK** button.

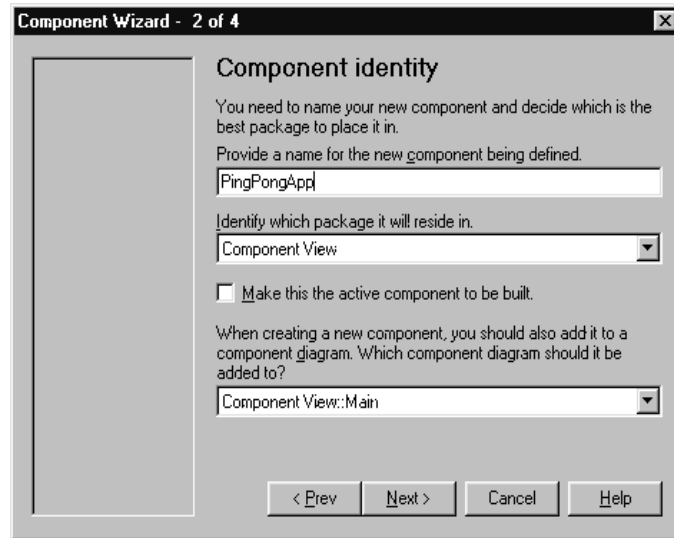
### Step 7: Build and Test the Model

To build and run a model from Rose RealTime, you must first create a component. Components are used to model the physical elements that may reside on a node, such as executables, libraries, source files, and documents. In other words, the component represents the physical packaging of the logical elements, such as classes and capsules. For the purposes of this example, the components that are created are going to represent executables.

Components have an associated top-level capsule. The top-level capsule defines what parts of the model are contained in the executable. In this case, the Container capsule should be made the top-level capsule of the new component.

To create a component:

1. Choose **Build > Component Wizard** to run the Build Component Wizard.
2. Click **Next**.
3. Type “PingPongApp” in the component name field as shown in Figure 23. Ensure that the package is Component View and click **Next**.

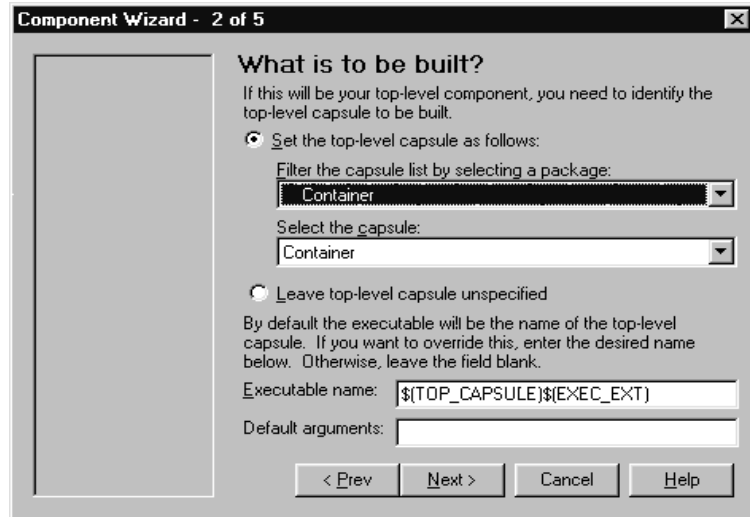


**Figure 23** *Setting the component identity - Iteration 1*

4. Select **C++** and click **Next**.
5. Click the **OK** button.

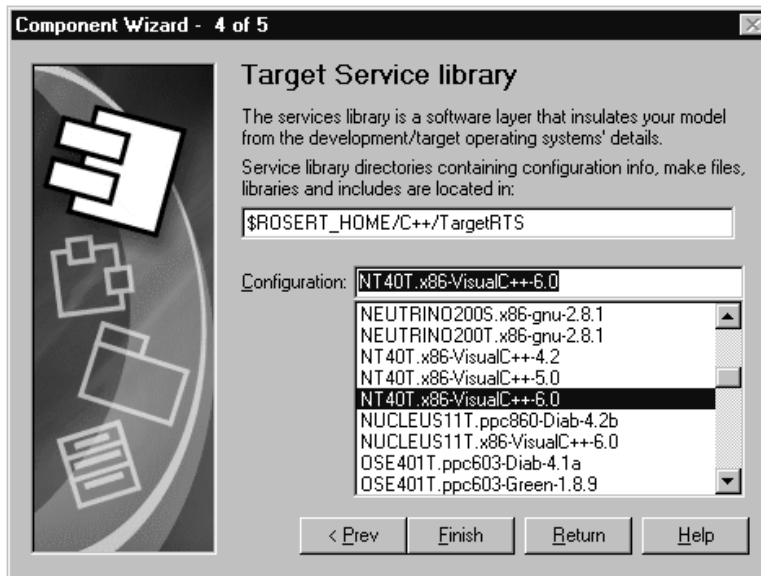
To customize the component:

1. Click **Next**.
2. Click **Set the top-level capsule** as shown in Figure 24.



**Figure 24** Setting the top-level capsule - Iteration 1

3. Select the package. In this case, select Container from the drop-down list.
4. Select the capsule. In this case, select the Container capsule from the drop-down list
5. Click **Next**.
6. Click **Next**.
7. Choose the target configuration as in Figure 25. If your development configuration is Visual C++ 6.0 in Windows NT, select NT40T.x86-VisualC++-6.0 and click **Next**. If your configuration is different, select the appropriate target.



**Figure 25** Setting the target service library

8. Click **Finish** and click the **OK** button.

There are many options that are associated with components. For the purposes of this example the default values are sufficient.

To create a processor:

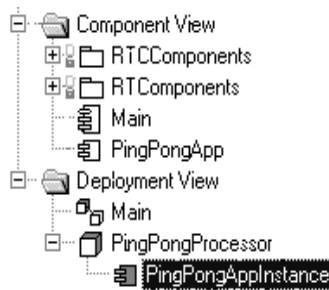
To execute the model from within the toolset, you must assign the component that was created in the last step to a processor. This tells Rose RealTime to execute the component on a specific machine on your network. There are many options that can be set for the processor and for executing a component instance on the processor. The defaults are sufficient in this case.

To create a processor:

1. Right-click on the Deployment View folder in the Rose RealTime browser and select **New > Processor** from the pop-up menu.
2. Name this processor "PingPongProcessor."
3. Drag and drop the PingPongApp component onto the PingPongProcessor.



You now should have a PingPongProcessor that contains a PingPongApp component instance as shown in Figure 26.



**Figure 26 Processor and component instance**

To build the model:

1. Save the model as "Tutorial\_Iteration1."
2. Select the PingPongApp component.
3. Open the pop-up menu and choose **Build > Quick Build**.
4. Click **Add References and Continue**.
5. Click the **OK** button.

### **Rationale for using Quick Build**

In this rapid prototyping example, we allow the tool to inform us about missing references and add them. In a large, managed application, references should be carefully managed and added manually to the component.

### **Run the PingPong component instance**

To run the PingPong application:

1. Right-click on the PingPongAppInstance and select **Run** from the pop-up menu. This creates the run-time environment within Rose RealTime.
2. Select **No** to "Build the component?" since it is already built.

The top left hand corner of the Rose RealTime application should now look something like what is illustrated in Figure 27. A console window also appears. This window is where the standard output from the model is displayed. Keep this window visible so that you can see the output that is being displayed.




**Figure 27** *Rose RealTime run-time environment*

3. Press the Start button to execute the model.

While the PingPongApp is running, you should see messages being printed to the console window. The Pong capsule receives ping signals from the Ping capsule and prints "received a ping" each time it does. Likewise, the Ping capsule receives pong messages from the Pong capsule and prints "received a pong" each time it does.

Because of the way that this model has been designed and the way the Target RSL message queuing works, this model prints five “received a ping” messages followed by five “received a pong” messages and continues doing this until the model is stopped. All messages that are sent to a capsule are queued in a priority queue. In this model, all five of the “ping” messages are queued before a “pong” response is generated. This causes the messages to be output as shown in the console window.

4. Click the Shutdown button  in the Runtime Viewer to stop the process.

## Iteration 2: Connexis Enabling our Application

---

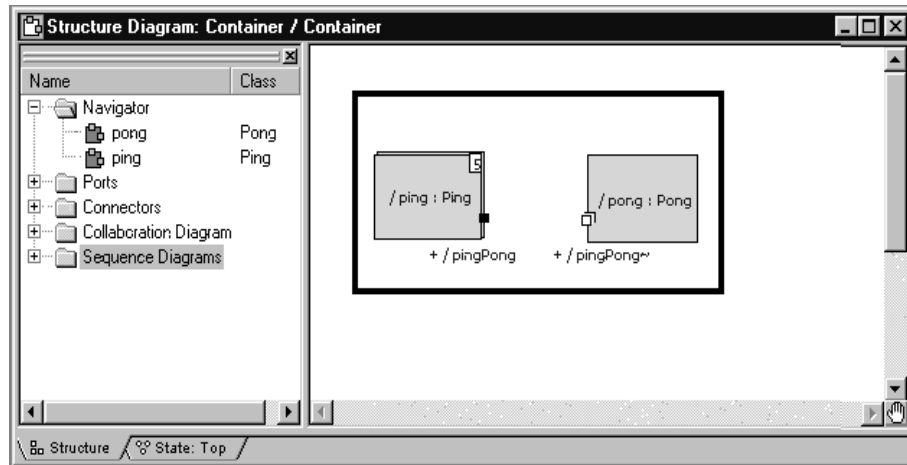
Connexis manages connections that are established between unwired ports. Unwired ports are ports whose connections are defined at run-time. Unlike wired ports, unwired ports cannot have connectors defined between themselves and other ports. The connections established between unwired ports can also be removed and reestablished at run-time.

Since unwired ports are used in Iteration 2, the first thing to do for Iteration 2 is to remove the wired connections that were created in Iteration 1 and make the wired pingPong ports unwired.

### Step 1: Remove the Connector Between the pingPong Ports

To remove the connector between the pingPong ports:

1. Open the model “Tutorial\_Iteration1” that you created in Iteration 1.
2. Save the model as “Tutorial\_Iteration2.”
3. Open the Container capsule’s structure diagram as shown in Figure 28.
4. Select the connector that is joining the pingPong ports on the Ping and Pong capsules. Right-click and choose **Remove/Exclude** to delete the connector.

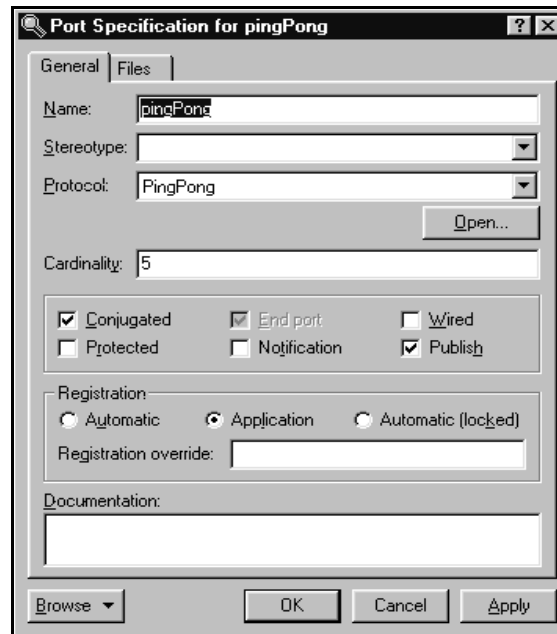


**Figure 28** Removing the connector between ping and pong

### Step 2: Make Changes to Pong's pingPong Port

To make changes to Pong's pingPong port:

1. Open the Pong capsule's structure diagram.
2. Select the pingPong port and open its specification.
3. Uncheck the **Wired** option as shown in Figure 29.
4. Check the **Publish** option.  
This makes the port externally visible.
5. Since the port is being registered in transition code, the **Application** radio button must also be checked.

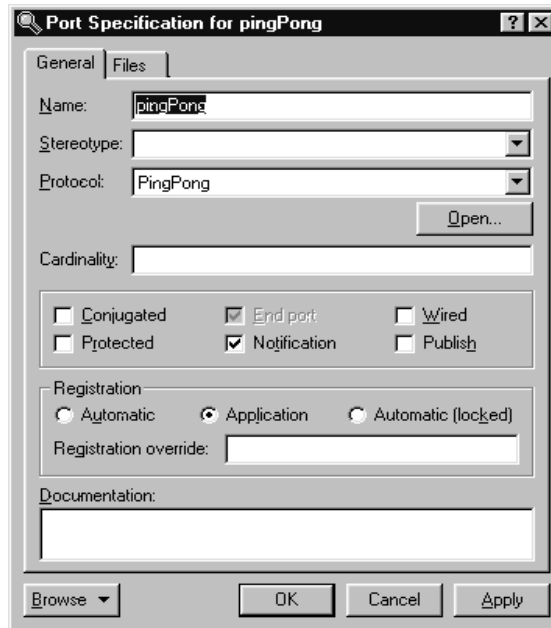


*Figure 29 Changing port specifications for Pong*

### Step 3: Make Changes to Ping's pingPong Port

To make changes to Ping's pingPong port:

1. Open the Ping capsule's structure diagram.
2. Select the pingPong port and open its specification.
3. Uncheck the **Wired** option as shown in Figure 30.
4. Check the **Notification** check box.
5. Since the port is being registered in transition code, the **Application** radio button must also be checked.



**Figure 30** Changing port specifications for Ping

The Notification box has been checked so the Ping capsule will be notified when a connection has been established on the pingPong port. The Notification box was not checked in the Pong capsule because it doesn't really care when connections have been established to its port. This is because the Pong capsule has published its interface and is just waiting for others to connect to it. In a more realistic design, the Pong capsule may be required to keep track of how many clients are connected at any given time. This would make Pong's state machine slightly more complicated.

In the Ping capsule, the notification event will be used. Ping's state machine must be changed so that it waits for an `rtBound` signal to be received on the pingPong port before sending a Ping message.

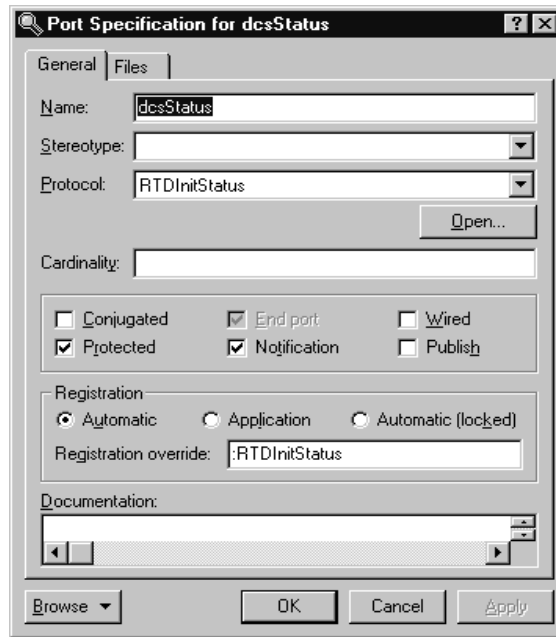
**Note:** The Target RSL sends the `rtBound` signal as notification that a connection was established.

### Step 4: Adding DCS Layer Notification to the Ping and Pong Capsules

To add DCS layer notification to Ping and Pong capsules:

1. Open the Class Diagram called Architecture you created in the first iteration.
2. Drag the RTDInitStatus protocol, located in the RTDInterface package in the Logical View, onto the diagram.
3. Select the Unidirectional Aggregation tool.
4. Create an aggregation association between the Pong capsule and the RTDInitStatus protocol. Name the association "dcsStatus."
5. Open the specification for the aggregation between the Pong capsule and the RTDInitStatus protocol.
6. Specify that it is:
  - a. protected
  - b. an end port
  - c. not wired, and
  - d. notification enabled
7. Specify that the Registration will be handled automatically, and specify a registration override of "RTDInitStatus."
8. Repeat steps 3 through 7 for the Ping capsule.

Before a model attempts to publish or subscribe to services through Connexis, it should verify that the DCS layer is active and properly initialized. If not, publication and subscription attempts will fail. The Connexis capsule will publish the RTDInitStatus service through the Internal Layer Service when it has completed its initialization. By subscribing to the service and enabling notification, the model can wait until it receives notification from Connexis before registering its SAPs or SPPs.



**Figure 31** Port Specification for dcsStatus

### Step 5: Modify Ping's State Machine to Wait for Connexis

To modify Ping's state machine to wait for Connexis:

1. Open the state diagram for Ping.
2. Add a new state to the diagram and call it "waitingForDCS."
3. Delete the Initial transition to the "ready" state.
4. Add a new Initial transition to the "waitingForDCS" state.
5. Add a transition from the "waitingForDCS" state to the "ready" state. Label this transition "dcsReady."
6. Open the specification for the "dcsReady" transition and click the **Triggers** tab.
7. Insert a trigger for the rtBound event on the dcsStatus port. We will add the action code to subscribe to the service in a later step.





**Figure 32** Add a transition for dcsStatus

## Step 6: Modify Pong's State Machine to Wait for Connexis

To modify Pong's state machine to wait for Connexis:

1. Open the state diagram for Pong.
2. Add a new state to the diagram and call it "waitingForDCS."
3. Delete the Initial transition to the "ready" state.
4. Add a new Initial transition to the "waitingForDCS" state.
5. Add a transition from the "waitingForDCS" state to the "ready" state. Label this transition "dcsReady."
6. Open the specification for the "dcsReady" transition and click the Triggers tab.
7. Insert a trigger for the rtBound event on the dcsStatus port. We will add the action code to publish the service in a later step.

## Step 7: Modify Ping's State Machine to Wait for Notify

To modify Ping's state machine to wait for notify:

1. Open the state diagram for Ping.
2. Add a new state to the diagram and call it "connected."
3. Add a transition between the "ready" state and the "connected" state. Label this transition "bound."
4. Open the specification for the "bound" transition and click on the **Triggers** tab.
5. Insert a trigger for the rtBound event on the pingPong port.

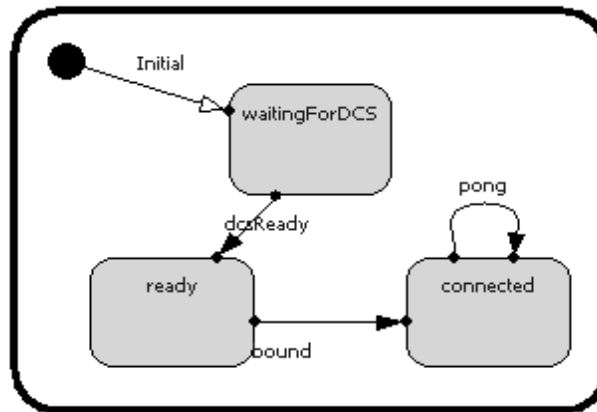


**Figure 33 Transition Specification for rtBound**

6. Click on the **Actions** tab and add the following code in the code editor:
 

```
pingPong.ping().send();
```
7. Move the pong transition from the ready state to the connected state.

To do this, select the transition and drag both ends of the transition over onto the Connected state one at a time. Your final state diagram should be similar to the one shown in Figure 34.



**Figure 34** Ping's state diagram

## Step 8: Add Registration Code to the Ping and Pong Capsules

Connexis needs to know how to connect the unwired ports in your model. A client can “lookup” a server in one of three places:

- locally - connect only with current TargetRTS
- explicit address - connect only to the TargetRTS at the specified address
- locator - connect using the Locator service

In addition to these options, there are also several parameters that can be passed to Connexis when you register a port. These parameters are discussed in detail in “Establishing Connections” on page 107.

In this example, the Ping and Pong capsules are going to register with the Locator service.

The basic syntax for registering a port with the Locator service is:

```

// for the client side of the connection
registerSAP("registrationString");

and

//for the server side of the connection
registerSPP("registrationString");
  
```

The registration string is different depending on which of the three lookup types you are using (local, explicit address, locator). In this example, the Locator service is being used, so the form of the registration string is:

```
connection_service:/registration_name
```

The only connection service currently available is the Distributed Connection Service (DCS) and Connexis Reliable Messaging (CRM). This leaves us with the following syntax for registering the pingPong port in the client:

```
registerSAP("dcs:/pingpong");
```

and the syntax for registering the pingPong port in the server as:

```
registerSPP("dcs:/pingpong");
```

In this example, the “pingpong” portion of the registration string could have been any string.

This is the simplest case of registration using the Locator. There are many parameters that can be supplied to the Locator as part of the registration string for doing things like setting the transport protocol that is being used. These parameters are discussed in “Establishing Connections” on page 107.

To add registration code to the Ping capsule:

1. Open the state diagram for the Ping capsule.
2. Double-click on the dcsReady transition and select the **Actions** tab in the resulting dialog.
3. Delete the existing text and enter the following code into the code window:

```
if (!pingPong.registerSAP("dcs:/pingpong")) {  
    log.log("Ping registration failed");  
}
```

4. Click the **OK** button.

To add registration code to the Pong capsule:

1. Open the state diagram for the Pong capsule.
2. Double-click on the dcsReady transition and select the **Actions** tab in the resulting dialog.

3. Enter the following code into the code window:

```
if (!pingPong.registerSPP("dcs:/pingpong")) {  
    log.log("Pong registration failed");  
}
```

4. Click the **OK** button.

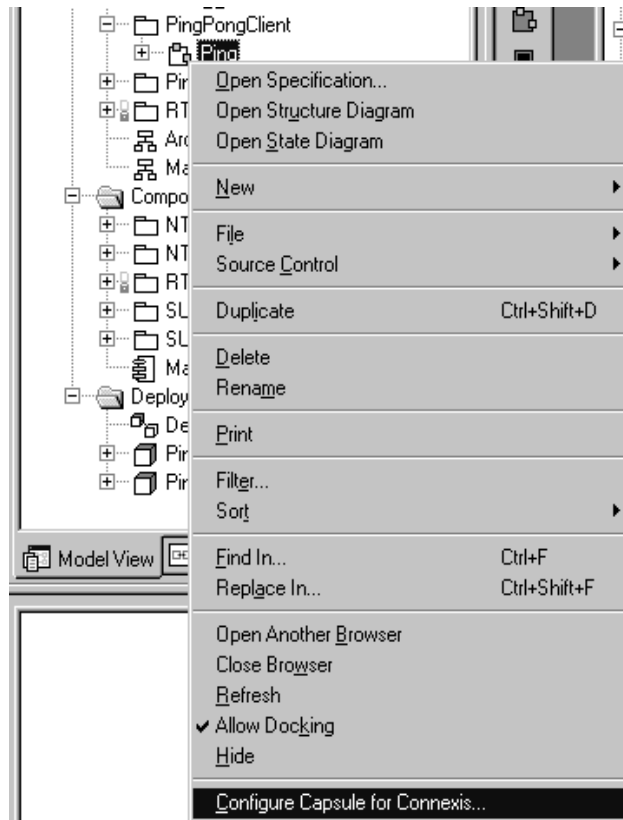
Now all of the model changes that are required have been completed. The next step is to set up the Connexis environment and create two new components. One of the components represents the Ping application and the other the Pong application.

### **Step 9: Add the Connexis Configuration Capsules to Your Model**

The Ping Pong Model requires the Ping and the Pong capsule to include the DCS capsule roles. We will use the Connexis configuration interface to add an RTDBase\_Agent to Ping and an RTDBase\_Locator\_Agent to Pong. (This configuration can also be done manually).

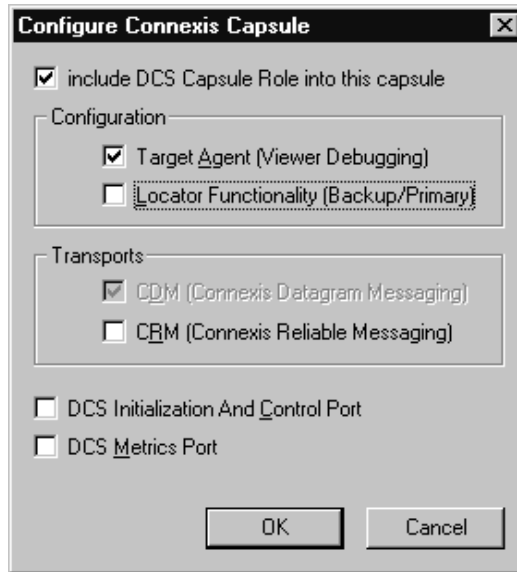
To configure the Ping Capsule:

1. Right-click the Ping capsule as in Figure 35.



**Figure 35** *Configuring the Ping Capsule*

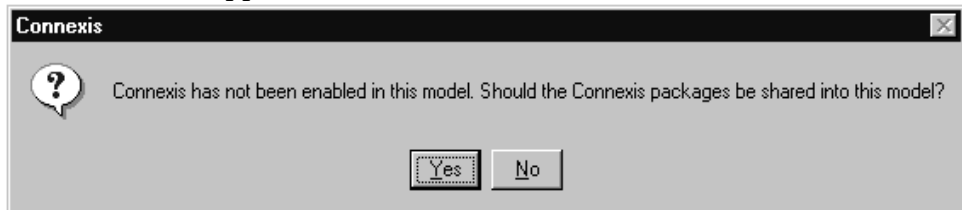
2. Select **Configure Capsule for Connexis**.  
The Configure Connexis Dialog appears.



**Figure 36** *Configure Connexis Capsule dialog*

3. Select the following options:
  - a. Include DCS capsule role into this capsule
  - b. Target Agent (Viewer Debugging)
4. Click **OK**.

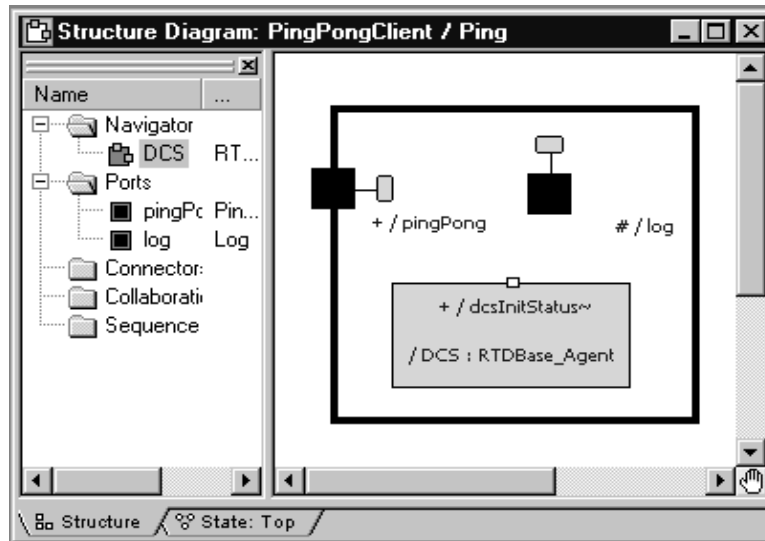
A dialog, suggesting that “Connexis packages be shared into this model,” appears.



**Figure 37** *Sharing Connexis Packages request dialog*

5. Click **Yes**.

You can see that the DCS capsule role has been added by viewing the Ping capsule structure (see Figure 38, Ping Capsule Structure).



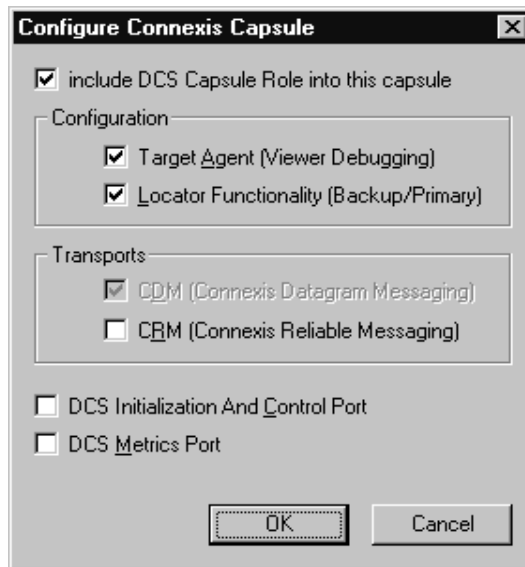
**Figure 38 Ping Capsule Structure**

To configure the Pong Capsule:

1. Right-click the Pong capsule.
2. Select **Configure Capsule for Connexis**.



The Configure Connexis dialog appears.



**Figure 39** *Configure Connexis Capsule*

3. Select the following options:
  - a. Include DCS Capsule Role into this capsule
  - b. Target Agent (Viewer Debugging)
  - c. Locator Functionality (Backup/Primary)
4. Click **OK**.

You can see that the DCS capsule role has been added by viewing the Pong capsule structure. Since Pong also supports the locator, the class of the DCS role is RTDBase\_Locator\_Agent instead of RTDBase\_Agent.

### **Rationale for selecting RTD interfaces**

In this configuration, only the Pong (server) capsule can be the locator. We could use an RTD\_Base\_Locator\_Agent reference in both Ping and Pong, in which case either capsule could serve as the primary locator. The locator's location is determined by the parameters specified in "Step 13: Build and Execute the Models."

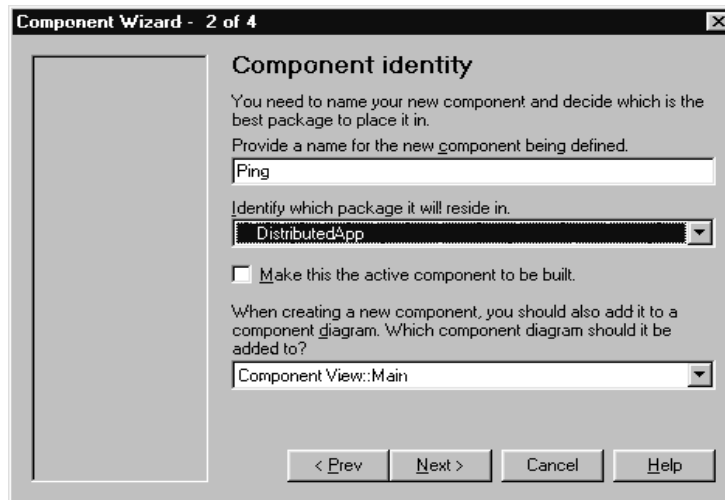
For more information about the features provided by the different RTDInterface capsules, refer to “Adding Connexis Support to Your Model” on page 83.

### Step 10: Create and Configure the Ping Component

Create a component for the Ping application.

To create the Ping component:

1. Select the Component View package.
2. Open the pop-up menu and select **New > Package**.
3. Name the package “DistributedApp.”
4. Choose **Build > Component Wizard** to run the Build Component Wizard.
5. Click **Next**.
6. Type “Ping” in the component name field as shown in Figure 40. Ensure that the package is DistributedApp and click **Next**.

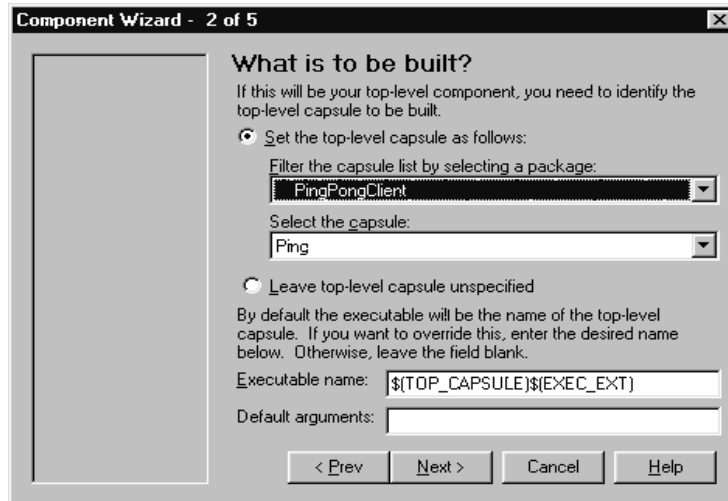


**Figure 40** Setting the component identity - Iteration 2

7. Select **C++** and click **Next**.
8. Click the **OK** button.

To customize the component:

1. Click **Next**.
2. Click **Set the top-level capsule** as shown in Figure 41.
  - a. Select PingPongClient package from the drop-down list.
  - b. Select Ping as the capsule.



**Figure 41** Setting the top-level capsule - Iteration 2

3. Click **Next**.
4. Click **Next**.
5. Choose the target configuration.

Use the same target configuration as in “To customize the component:” on page 54, step 7.

### Step 11: Create and Configure the Pong Component

Create a component for the Pong application.

To create the Pong component:

1. Choose **Build > Component Wizard** to run the Build Component Wizard.
2. Click **Next**.
3. Type “Pong” in the component name field. Ensure that the package is DistributedApp and click **Next**.

4. Select **C++** and click **Next**.
5. Click the **OK** button.

To customize the component:

1. Click **Next**.
2. Set the top level capsule:
  - a. Select PingPongServer package from the drop-down list.
  - b. Select Pong as the capsule.
3. Click **Next**.
4. Click **Next**.
5. Choose the target configuration.

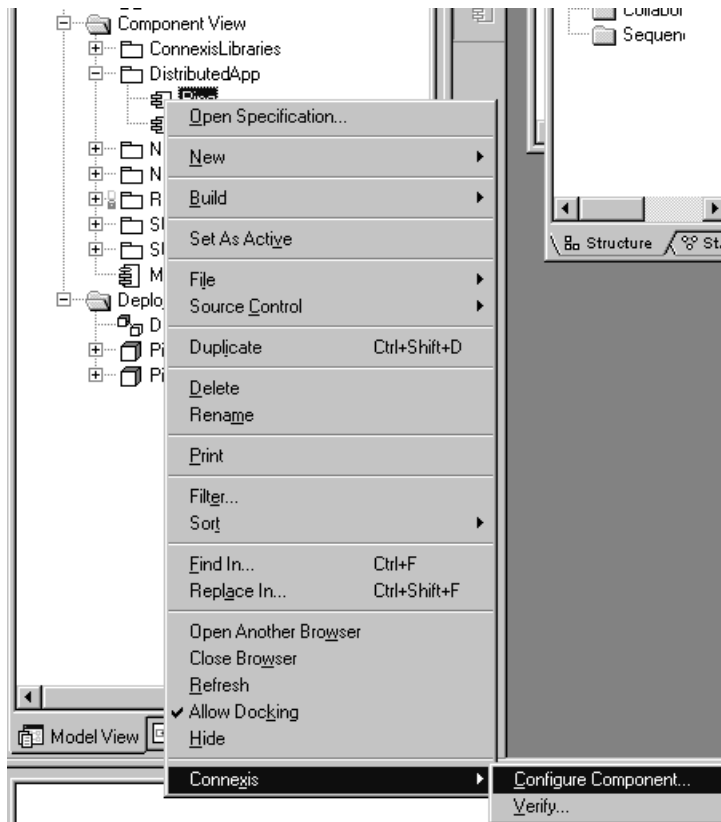
Use the same target configuration as in “To customize the component:” on page 54, step 7.

## Step 12: Add Component Dependencies

You need to create dependencies between the Ping component and the Connexis DCS library, and the Pong component and the DCS library.

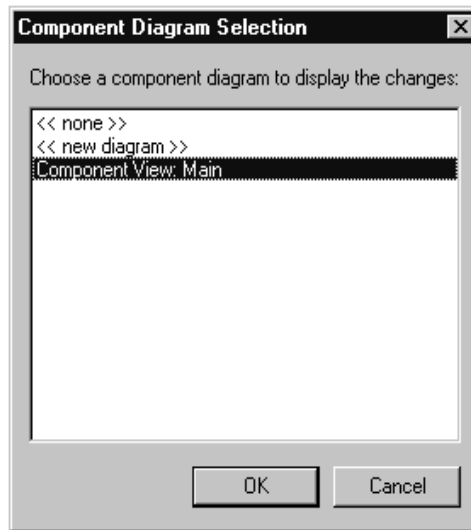
To add component dependencies:

1. Right-click the Ping Component.



**Figure 42** Configuring the Ping Component

2. Select **Connexis > Configure Component**.  
The Component Diagram Selection dialog appears.



**Figure 43** *Component Diagram Selection dialog*

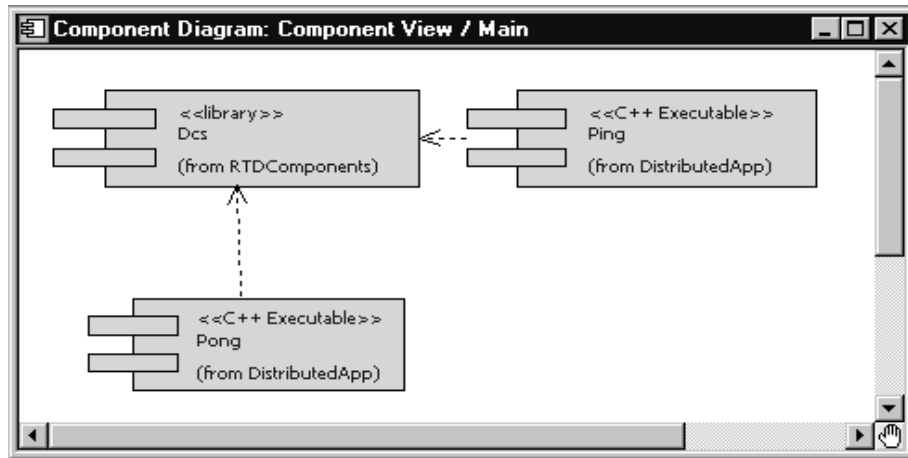
3. Select **Component View: Main**.
4. Click **OK**.

You have created a dependency between the Ping component and the DCS library.

5. Repeat steps one to four for the Pong component.

The Main diagram in Component View will appear as in Figure 44.

You should now have Ping and Pong components that are ready to be compiled.



**Figure 44** Main component view diagram

### Step 13: Build and Execute the Models

Now that the components have been created and configured, they must be built. This is done by right-clicking on the component and selecting Build from the pop-up menu.

To create a Ping processor and component instance:

1. Create a processor for the Ping component and name it "PingProcessor."
2. Drag the Ping component onto the PingProcessor to create a component instance.
3. Select the PingInstance and open its specification.
4. Add the following code to the Parameters field in front of the code "-obslisten=30468":

```
-CNXep=cdm://localhost:7777 -CNXlpep=cdm://localhost:8888
```

Your final code should appear similar to the line below. Note that the target observability port number, 30468, will vary from this example.

```
-CNXep=cdm://localhost:7777 -CNXlpep=cdm://localhost:8888 -  
obslisten=30468
```

**Note:** See page 253 for information on using "localhost."

5. Click the **OK** button.

To create a Pong processor and component instance:

1. Create a processor for the Pong component and name it "PongProcessor."
2. Drag the Pong component onto the PongProcessor to create a component instance.
3. Select the PongInstance and open its specification.
4. Add the following code to the Parameters field in front of the code

```
"-obslisten=30477":
```

```
-CNXep=cdm://localhost:8888 -CNXlp
```

Your final code should appear similar to the line below. Note that the target observability port number, 30477, will vary from this example.

```
-CNXep=cdm://localhost:8888 -CNXlp -obslisten=30477
```

5. Click the **OK** button.

### **Rationale for the Connexis parameters**

The `-CNXep=` parameter identifies the `cdm` endpoint at which the component instance listens. The `-CNXlp` parameter on the `PongInstance` specifies that the `PongInstance` will act as the primary locator. The `-CNXlpep=` parameter informs the `PingInstance` of the location of the primary locator. Note that the `-CNXep` of the `PongInstance` is the value of the `-CNXlpep` of the `PingInstance`. For more information about Connexis parameters, refer to "Establishing Connections" on page 107.

### **Run the Pong component instance**

To run the Pong component instance:

1. Right-click on the `PongInstance` and select **Run** from the pop-up menu.
2. Select **No** to "Build the component?" since it is already built.  
A console window appears.
3. Press the **Start** button to execute the model.



### **Run the Ping component instance**

To run the Ping component instance:

1. Right-click on the PingInstance and select Run from the pop-up menu.
2. Select **No** to “Build the component?” since it is already built.  
A second console window appears for the Ping component instance.
3. Press the Start button to execute the model.

**Note:** *The ping and pong reports appear in separate console windows. The two processes are communicating through Connexis.*

### **Optional: Distribute the model**

When a model has been Connexis-enabled, it may be distributed by simply changing the executable parameters.

The hostname "localhost" was used in previous component instance specifications. Since this has a different meaning on each host, it must be replaced with the actual hostname. For this example the machine "angus" will be used for Ping and "bruce" for Pong.

1. Start Rose RealTime running on angus and bruce. Build the Ping component on angus and the Pong component on bruce if you have not already done so.
2. On angus, open the PingInstance specification and change the -CNXep and -CNXlpep parameters to be:  
-CNXep=cdm://angus:7777 -CNXlpep=cdm://bruce:8888
3. On bruce, open the PongInstance specification and change the -CNXep parameter to be:  
-CNXep=cdm://bruce:8888
4. Run the PingInstance on angus and the PongInstance on bruce. Observe the same behavior that you saw in a single-processor environment.

**Note:** *To keep this exercise simple, Rose RealTime was run on each of the target processors. In a normal development situation you will run Rose RealTime on a single host from which all targets are observed and controlled.*

### **Optional: Complete the HelloWorld Tutorial**

Once you have completed the Quick Start, proceed to the HelloWorld tutorial, provided in the Rose RealTime online help. It provides information on using the Locator and shows you how to work with rtbound and rtunbound notifications.

## **Basic Connexis Development Approach Summary**

---

This section outlines the basic steps to follow to distribute your model using Connexis.

### 1. Design your Rose RealTime application.

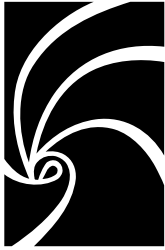
Although it is very easy to repartition your model and distribute it in a different manner using Connexis, it is still a good idea to consider distribution when you are doing your up-front designs. The reason for this is performance. Many of the performance issues that you encounter in a distributed application are a direct result of not partitioning your model properly. Remember, intra-thread messages are faster than inter-thread messages, which are faster than inter-process messages, which are faster than inter-node messages.

### 2. Specify the registration strings and connection parameters on your unwired ports.

If the nature of your application is such that you know the names of the endpoints that you want to communicate with (either through the use of an algorithmic mapping or by reading a configuration file), then explicit endpoint names can be used in the registration strings of the unwired ports in the model. For more information refer to “External explicit examples” on page 124.

If this is not the case, you may want to make use of the Locator Service.

In either case, each of the unwired ports in your model must be registered with an appropriate registration string. Once this has been completed and the connections are being initialized properly, you can send and receive messages through Connexis-enabled unwired ports in the same way as with normal Rose RealTime ports.



## Chapter 4

# *Adding Connexis Support to Your Model*

---

To add Connexis support to a Rose RealTime model complete the following sections:

- Sharing DCS Interfaces into your Model
- Configuring Connexis Capsules
- Manually Integrating Transports Into a Model

In addition to these steps, there are also general design rules that must be followed to ensure that the Connexis component in an application is initialized properly before it is used (see “Initializing Your Connexis Capsule” on page 92).

From the perspective of a Rose RealTime model, Connexis is distributed as a set of Rose RealTime capsules and components. To make use of Connexis in your Rose RealTime model, you need to share the appropriate Connexis packages, containing the Connexis capsules and components.

From a build perspective, Rational Connexis is shipped as an external library, libDCS. The libDCS library provides support for the CDM and CRM transports.

## Sharing DCS Interfaces

---

Connexis functionality is defined in a set of packages that must be shared into your model. There are logical packages containing the capsules that provide Connexis functionality for your application. There are also component packages representing the external Connexis libraries needed to build your application.

**Hint:** If you want to use the CDM or CRM transport, you only need to add the Distributed Connection Service (DCS).

**Note:** You must be able to modify your model, specifically the Logical View and Component View packages. If your model is under source control, you need to check out these packages first.

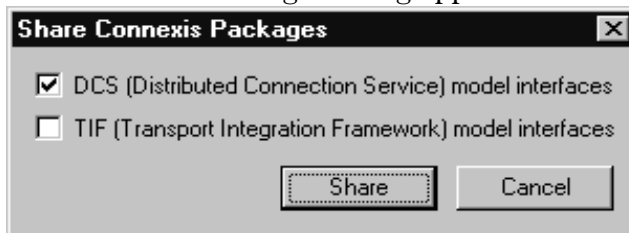
### Sharing DCS Interfaces into your Model

In order for your application to make use of the Distributed Communication Services (DCS), you must share the DCS model interfaces packages into your model.

To share the Connexis packages:

1. From the **Tools** menu, select **Connexis > Share Connexis Packages**.

The Share Connexis Packages dialog appears.



**Figure 45** Share Connexis Packages dialog

2. Select DCS (Distributed Connection Service) model interfaces.

**Note:** Do not select TIF (Transport Integration Framework) model interfaces unless you are developing a transport integration (see “Using the Transport Integration Framework” on page 299).

- a. DCS (Distributed Connection Service) model interfaces

The DCS model interfaces selection shares the capsules and components needed to make use of DCS. The RTDInterface logical package and the RTDComponents component package are shared into your model.

- b. TIF (Transport Integration Framework) model interfaces  
Models that make use of DCS do not share this package into the model. This package is only shared into a model in which a transport integration is being developed (see “Using the Transport Integration Framework” on page 299).

3. Click **Share**.

### Removing Shared Packages

Rose RealTime lets you remove Connexis packages from your model.

To remove Connexis packages:

1. From the **Tools** menu select **Connexis > Remove Connexis Packages**.  
Connexis packages are removed from your model.

### Configuring Connexis Capsules

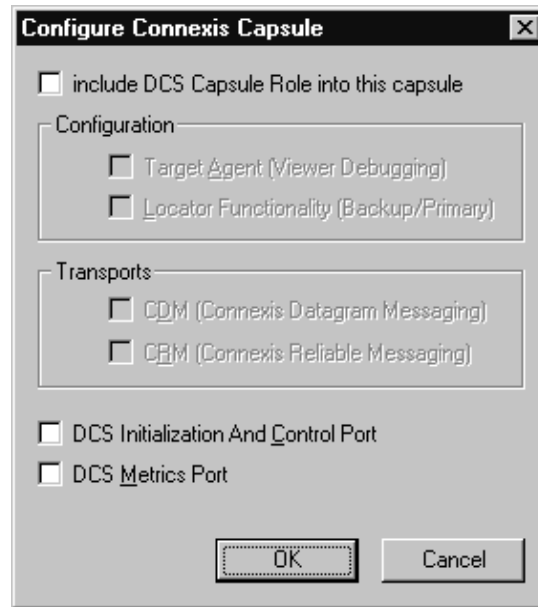
---

Once the Connexis packages are shared, you must add a capsule role for one of the Connexis capsules in the RTDInterface package to one capsule for each component that will use Connexis. It is suggested that you add one of these capsules as a fixed capsule role in the top-level capsule in each component. If the capsule or its containing package is in source control, check the capsule out of source control before applying the settings.

To add a capsule role in your model:

1. Right-click a capsule in your model or right-click the structure diagram of a capsule.
2. Select **Configure Capsule for Connexis**.

The Configure Connexis Capsule dialog appears, containing the current Connexis settings of the selected capsule, including the type of Connexis capsule role added to the capsule.



**Figure 46** *Configure Connexis Capsule dialog*

3. Check the “include DCS Capsule Role into this capsule” check box if you want to include the DCS Capsule Role into the selected capsule. If you do not, proceed to instruction five.

4. If you checked the “include the DCS Capsule Role into this capsule” check box, set the Configuration and Transports options to your requirements:

**Table 4 Configure Connexis Capsule dialog description**

<b>Configuration and Transports Settings</b>	<b>Description</b>
Transport Agent (Viewer Debugging)	Selecting this option lets you use the Connexis Viewer to provide debugging support (see “Using the Connexis Viewer” on page 151). Once you select this option the CDM transport is enabled. The Connexis Viewer uses the CDM transport.
Locator Functionality (Backup Primary)	Selecting this option lets you use the Connexis Locator that maps endpoint service names to physical endpoints (see “Locator Connections” on page 125 and “Using the Connexis Locator Service” on page 135).
CDM (Connexis Datagram Messaging)	Selecting this transport lets your component use the CDM transport.
CRM (Connexis Reliable Messaging)	Selecting this transport lets your component use the CRM transport.

5. Select the options that you want to make available to your model.
- a. DCS Initialization and Control Port (see “Using the RTDInitStatus Protocol” on page 93)
  - b. DCS Metrics Port (see “Using the Connexis Metrics Service” on page 237)

Once you configure the capsule, the Connexis Component Configuration tool prompts you to configure the capsules that reference the Connexis-enabled capsule that you configured.

Depending on the options that you selected in the “Configure Connexis Capsule” dialog, one of the following capsule roles are included in your capsule:

**Table 5 Configuration Descriptions**

<b>Configuration</b>	<b>Capsule</b>	<b>Description</b>
DCS	RTDBase	This configuration contains the core Connexis interfaces. With this component the Connexis Locator is not linked in with the executable and the Connexis Viewer is not used with the model.
DCS with Target Agent	RTDBase_Agent	This configuration contains the Target Agent which is the interface between the executable and the Connexis Viewer. With this component the Viewer is used with the model but the Locator is not linked in with the executable.
DCS with Locator	RTDBase_Locator	This configuration contains the Connexis Locator. With this component, the Locator is linked in with the executable but the Viewer is not used with the model.
DCS with Target Agent and Locator	RTDBase_Locator_Agent	This configuration contains both the Locator and the Target Agent. With this component, the Locator is linked into the executable and the Connexis Viewer can be used with the model.

### Manually Integrating Transports Into a Model

This section explains how to integrate transports into your model without using the Configure Connexis Capsules tool.

For a transport to be available for use in a DCS enabled model, the transport must first register with DCS, prior to the initialization of DCS. This constraint also applies to the CDM or CRM transports. The RTDCdm and RTDCrm classes in the RTDInterface logical package represent the CDM and CRM transports respectively. The constructors of each of these classes register their respective transport with DCS. As



a result, an instance of the class must be created prior to the initialization of the DCS. The easiest way to ensure this is to create an association (composite aggregation) between the capsule containing the DCS capsule and the classes that represent the transports to be integrated.

To register the CDM transport for use in the model, create an association (composite aggregation) of type RTDCdm on the capsule containing the RTDBase or RTDBase\_Locator capsule. The RTDBase\_Agent and RTDBase\_Agent\_Locator capsules automatically register the CDM transport, since the viewer uses the CDM transport. The constructor for RTDCdm accepts an argument of type bool indicating whether the CDM transport should listen on the transporter's thread for incoming messages ("true") or on a separate thread ("false"). Listening for messages on the transporter's thread can provide better performance. Only one transport can listen on the transporter's thread for messages. If the argument supplied to the constructor is "true" and another transport has already registered with DCS to listen on the transporter's thread, CDM will listen on a separate thread.

To register the CRM transport for use in the model, create an association (or attribute + dependency) of type RTDCrm on the capsule containing the RTDBase, RTDBase\_Locator, RTDBase\_Agent and RTDBase\_Agent\_Locator capsule. The constructor for RTDCrm accepts a bool indicating whether the CRM transport should listen on the transporter's thread for incoming messages ("true") or on a separate thread ("false"). Listening for messages on the transporter's thread can provide better performance. Only one transport can listen on the transporter's thread for messages. If the argument supplied to the constructor is "true" and another transport has already registered with DCS to listen on the transporter's thread, the CRM will listen on a separate thread.

If your model is using additional transports that have been integrated into DCS, they must also be registered with DCS prior to the initialization of DCS. The designers that developed the transport integration will be able to provide information on how to register the transport.

## Configuring a Component for Connexis

---

When you configure a component for Connexis, you create a component dependency to a DCS library. If a DCS dependency already exists in the selected component, the Configuration tool notifies you of the existing dependency.

To configure a Component for Connexis:

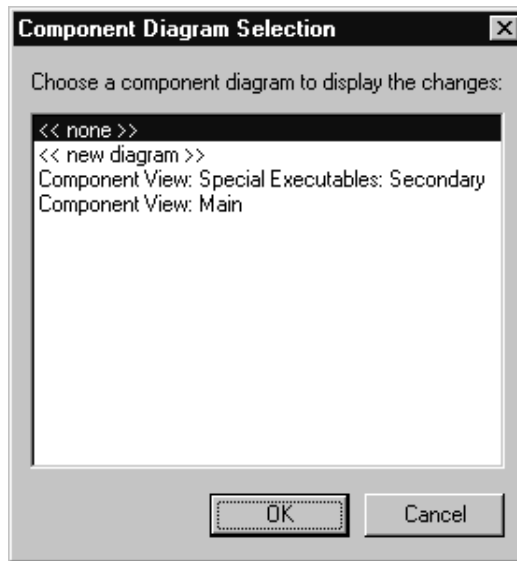
1. Right-click a component.
2. Select **Connexis > Configure Component**.

The “Component Diagram Selection” dialog appears.

**Note:** A DCS capsule role must be in one of the capsules referenced by the component before you configure the component (see “Configuring Connexis Capsules” on page 85).

3. Select how you want the changes to be displayed.

The dialog lists the display options available for the selected component.



**Table 6** *Component Diagram Selection options*

Options	Description
<<none>>	creates a component dependency to the DCS library, without a diagram displaying the changes.
<<new diagram>>	creates a new diagram showing the component dependency to the DCS library.
Existing component diagram	shows the component dependency to the DCS library from an existing diagram.

**Note:** A component may also be configured from the menu on its view in a component diagram.

## Verifying Connexis Enabled Components

---

Once you have shared Connexis components in your model, you can verify the model path and incompatibilities of each component in your model.

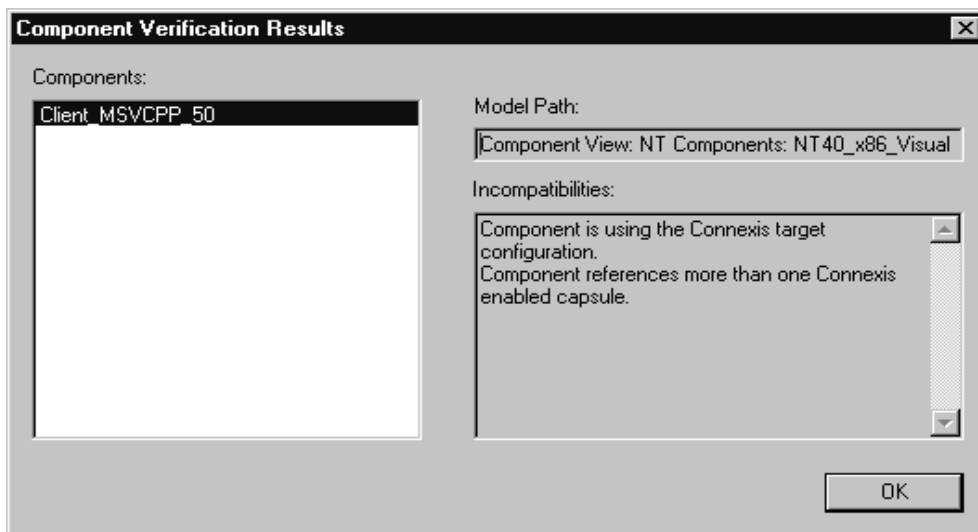
To verify a component:

1. Right-click a component.

**Note:** You can select several components at a time by pressing the **Ctrl** key.

2. Select **Connexis > Verify**.

The “Component Verification Results” dialog appears.



**Figure 47** *Component Verification Results*

3. Select a component from the “Components” area.

The “Model Path” information and “Incompatibilities” information are displayed.

## Initializing Your Connexis Capsule

---

The Connexis capsule that you are using in your application must be initialized before any ports can be registered with it.

There are two approaches that can be used to make sure that the Connexis component is initialized before it is used in the application:

- Use the `RTDInitStatus` protocol. This is the recommended approach and will work in all configurations.

- Use fixed initialization order. This approach will work in the most basic configuration, which is when the Connexis component is fixed and on the main application thread. This approach will not work when the Connexis component is created on a different thread.

### Using the RTDInitStatus Protocol

The recommended approach for ensuring the Connexis component is initialized before use is to subscribe to the RTDInitStatus publisher on the Connexis component and query DCS as to its status. If the Connexis component is initialized on a thread other than the main thread, this approach is required because there is no other way to ensure the Connexis component is initialized before use.

All of the Connexis components publish a port called RTDInitStatus. This port realizes the RTDInitStatus protocol. When the component is fully initialized, it sends an rtBound event on this port. When rtBound is received the DCS initialization was successful.

All of the capsules that are planning to register ports with the Connexis component must create a subscriber port that realizes the RTDInitStatus protocol. This port must be registered as RTDInitStatus and *notification must be turned on*. Once the Connexis component has been initialized, it will send an rtBound event on the RTDInitStatus port.

The code used to register the subscriber port (if application registration is used) is as shown below:

```
rtDInitStatus.registerSAP(":RTDInitStatus");
```

If automatic registration is used, the port must be protected and the registration override string must be defined as:

```
:RTDInitStatus
```

For an example of using the RTDInitStatus protocol, refer to the HelloWorld model in the examples directory (\$ROBERT\_HOME/CONNEXIS)/C++/examples.

The RTDInitStatus protocol also defines an interface that provides the following:

- access to the status of the Target Agent and Locator if present
- query which port the CDM is listening on

- access to the DCS Transport thread, and its Virtual Circuit limit
- ability to set the primary and backup locator endpoints dynamically at run-time

This interface is asynchronous, and is defined in more detail in Table 7 and Table 8. Table 7 summarizes the output signals that can be sent by the application. Table 8 summarizes the input signals that can be received by the application.

**Table 7 RTDInitStatus Out Signals**

<b>Out Signal</b>	<b>Description</b>
rtdAgentActive	Request for Target Agent activation status.
rtdBackup Endpoint	Used to set the endpoint of the backup locator. The data is the endpoint string, in the same format as the CNXlbep command line argument.  e.g., cdm://localhost:4000, or tcp://192.139.251.2:5000, etc.
rtdCDMport	Request for the value of the CDM port assigned.
rtdDCSrunning	No longer supported.
rtdLocator Available	Request for Locator availability status. If the Locator has been loaded into the system and properly configured it will be flagged as available.
rtdPrimary Endpoint	Used to set the endpoint of the primary locator. The data is the endpoint string, in the same format as the CNXlpep command line argument.  e.g., cdm://localhost:4000, or tcp://192.139.251.2:5000, etc.
rtdTransport Controller	Request for the Transport handle. This handle is required for high-performance DCS applications that will be collocated on the same thread as the Transport.
rtdVClimit	Request for internal limit on the number of Virtual Circuits (VCs). This limit is defined by the version of the library.

**Table 8 RTDInitStatus In Signals**

In Signal	Description
rtdAgentActiveReply	No longer supported.
rtdBackupEndpoint Reply	Reply to rtdBackupEndpoint containing the status of setting the backup locator endpoint, returned as an int.  int result = *rtdata;  The result is one of the following: 0 - success 1 - failed because this process is the backup locator 2 - failed due to an invalid endpoint string
rtdCDMportReply	Reply to rtdCDMport containing the CDM port assigned, returned as an int. The CDM port is derived either from the value for CNXep, or from a free port number.  int cdm_port = *rtdata;  A non-zero value indicates a software failure.
rtdDCSrunningReply	Reply to rtdDCSRunning containing the status of DCS, returned as an int.  int dcs_status = *rtdata;  A non-zero value indicates that DCS is running.

**Table 8 RTDInitStatus In Signals**

In Signal	Description
rtdLocatorAvailable Reply	<p data-bbox="619 279 1213 331">Reply to rtdLocatorAvailable containing availability status, returned as an int.</p> <pre data-bbox="619 369 971 392">int locator_available = *rtdata;</pre> <p data-bbox="619 430 1213 508">A zero value implies that the locator is NOT properly configured and the registration of global names will fail:</p> <pre data-bbox="619 517 1189 569">port-name.registerSAP("dcs:/service-name") // will fail</pre> <pre data-bbox="619 604 1213 682">port-name.registerSPP("dcs:/service-name") // will pass since SPPs can also be connected to locally and explicitly.</pre> <p data-bbox="619 720 1213 835">A non-zero value indicates that the Locator is properly configured though a connection may not exist at this time to a remote Locator. Registration of global names will pass.</p> <p data-bbox="619 869 886 892">Possible return values:</p> <ul data-bbox="619 899 1213 1187" style="list-style-type: none"> <li>1 == Primary Locator running locally (this process), Backup Locator not configured</li> <li>2 == Primary Locator running locally (this process), Backup Locator is remote (CNXIbep)</li> <li>3 == Backup Locator running locally (this process), Primary Locator is remote (CNXIpep)</li> <li>4 == Primary Locator is remote (CNXIpep), Backup locator not configured</li> <li>5 == Primary Locator is remote (CNXIpep), Backup locator is remote (CNXIbep)</li> </ul>

---



**Table 8 RTDInitStatus In Signals**

<b>In Signal</b>	<b>Description</b>
rtdPrimaryEndpoint Reply	<p>Reply to rtdPrimaryEndpoint containing the status of setting the primary locator endpoint, returned as an int.</p> <pre data-bbox="668 401 893 423">int result = *rtdata;</pre> <p>The result is one of the following:            0 - success            1 - failed because this process is the primary locator            2 - failed due to an invalid endpoint string</p>
rtdTransportController Reply	<p>Reply to rtdTransportController containing the Transport handle, returned as a (RTController *). This handle is needed to initialize capsules on the dcs: Transport thread.</p> <pre data-bbox="668 770 1240 793">RTController * t_thread = (RTController *)*rtdata;</pre> <p>A null pointer is returned if DCS is not running.</p>
rtdVClimitReply	<p>Reply to rtdVClimit containing the VC (virtual circuit) limit, returned as an int.</p> <pre data-bbox="668 991 912 1013">int vc_limit = *rtdata;</pre>

### Using Fixed Initialization Order

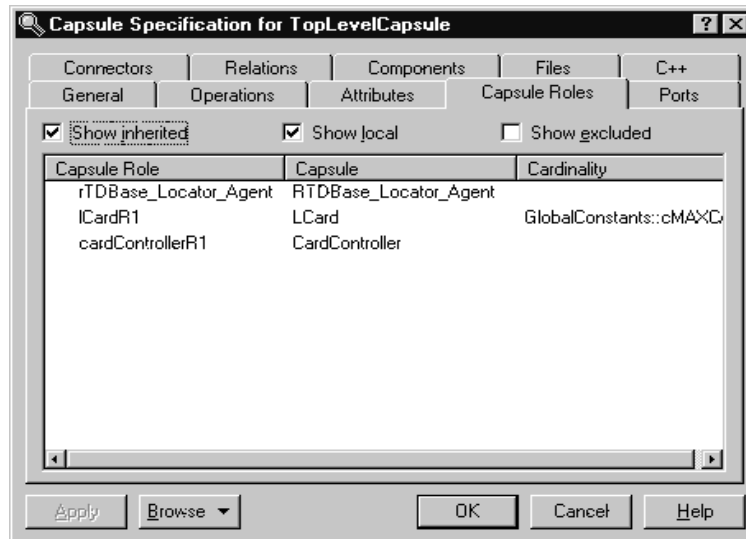
If the Connexis component's capsule role is fixed and is created on the main application thread, you can ensure that it is initialized before it is used by other capsules by placing it in the application's top capsule and putting the Connexis component's capsule role at the top of the initialization order for that capsule.

**Note:** *If the Connexis component's capsule role is created on a thread other than the main thread or is optional and on the main thread, this approach is not guaranteed to work.*

To ensure that the Connexis component's capsule role is initialized before any capsule roles that register with Connexis:

1. Make the Connexis component's capsule role fixed and place it in the top-level capsule of the application.
2. Open the **Capsule Specification** dialog for the top-level capsule.
3. Select the **Capsule Roles** tab.
4. Move the Connexis component's capsule role so that it is in the list before any capsule roles that register with Connexis. You can do this by dragging and dropping the appropriate capsule role to the top of the list of capsule roles. The resulting dialog is shown in Figure 48.

**Note:** *If you sort the list of capsule roles by clicking on one of the column headings, you will not be able to determine the initialization order until you close and reopen the specification dialog.*



**Figure 48** Capsule Role tab of top-level capsule

## Converting Connexis Version 2000.02.10 Models to Connexis 2001A.04.00 Models

---

If you are using the previous version of Connexis (version 2000.02.10), the Connexis Model Conversion Tool searches your model, identifying any incompatibilities, and provides a detailed description, explaining the changes. Table 9, Model Conversion for Connexis 2000.02.10 to Connexis 2001A.04.00, explains the changes that are made to your model during the conversion process.

**Table 9 Model Conversion for Connexis 2000.02.10 to Connexis 2001A.04.00**

<b>Condition</b>	<b>Change</b>
RTDXBase, RTDXBase_Agent, RTDXBase_Locator, RTDXBase_Agent_Locator fixed capsule roles are in the model	Replaces the capsule roles with the corresponding RTDBase configuration. Integrates the CDM transport with the capsules containing the new RTDBase or RTDBase_Locator capsule roles. Integrates the CRM transport into the containing capsule.
RTDBase, RTDBase_Locator fixed capsule roles are in the model but do not have the CDM transport as an attribute.	Integrates the CDM transport using a composite aggregation relationship into the capsules containing RTDBase or RTDBase_Locator capsule roles.
RTDXBase optional capsule role is in the model	Converts to the RTDBase and integrates the CRM and CDM transports.
RTDXBase_Agent optional capsule role is in the model	Converts to RTDBase_Agent and integrates the CRM transport.
RTDXBase_Locator optional capsule role is in the model	Converts to RTDBase_Locator and integrates the CDM and CRM transports
RTDXBase_Locator_Agent optional capsule role is in the model	Converts to RTDBase_Locator_Agent and integrates the CRM transport.
RTDBase or RTDBase_Locator optional capsule role is in the model	Users are notified that the CDM transport is integrated.
RTDBase_Agent or RTDBase_Locator_Agent optional capsule role is in the model	Searches the model identifying any of the components that reference a dependency. If a dependency exists, the CRM transport is integrated.

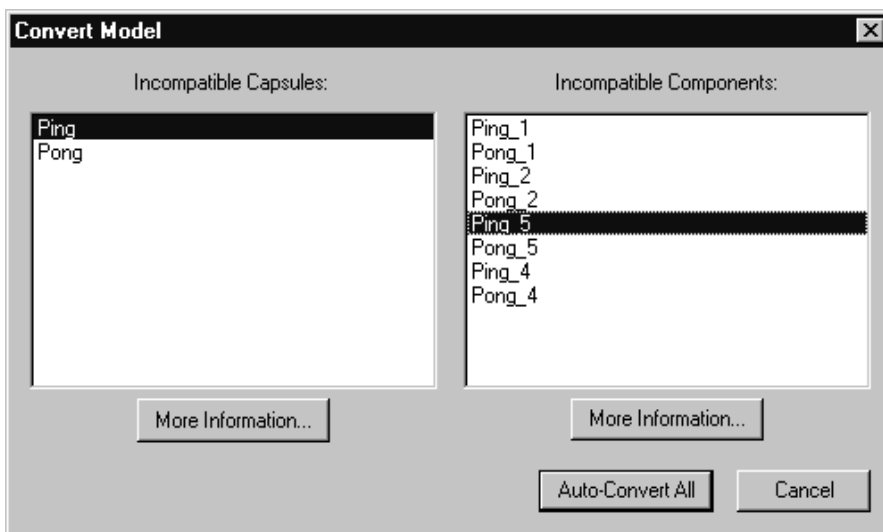
**Table 9 Model Conversion for Connexis 2000.02.10 to Connexis 2001A.04.00**

Condition	Change
A component depends on a XDCS library component	Changes the component dependency to use the DCS library component.
The TargetConfiguration property of a component references a -CNX-M or a -CNX- target configuration	Removes the -CNX- or -CNX-M from the TargetConfiguration name.

To convert your model:

1. Open a model that uses the previous version of Connexis (version 2000.02.10).
2. Select **Tools > Connexis > Convert Model**.

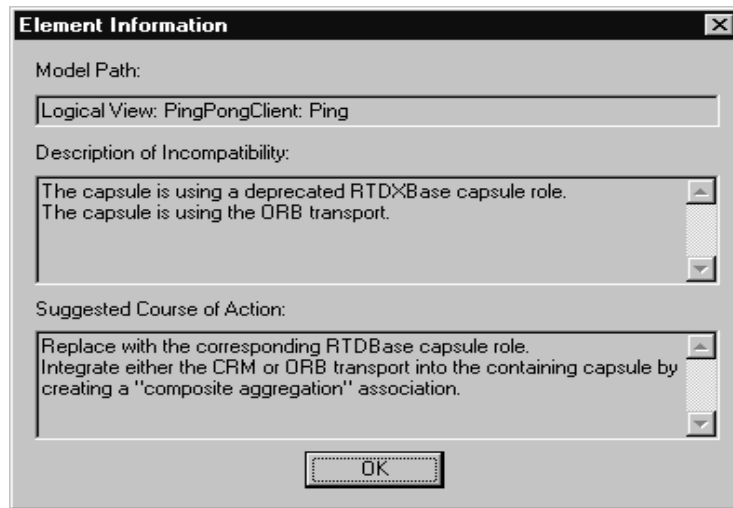
The “Convert Model” dialog appears.



**Figure 49 Convert Model dialog**

3. View more information about incompatible capsules and components by selecting the capsule or the component from the dialog and clicking **More Information**.

The “Element Information” dialog appears.



**Figure 50** *Element Information dialog*

The “Element Information” dialog provides the following information:

**Table 10** *Element Information dialog chart*

<b>Information Heading</b>	<b>Description</b>
Model Path	Shows the path of the selected capsule or component.
Description of Incompatibility	Explains the reason for the incompatibility between version 2000.02.10 and 2001A.04.00.
Suggested Course of Action	Explains how the Conversion tool will make the capsule or component compatible with Connexis version 2001A.04.00.

4. Click **OK** once you have read the information, and repeat step three for additional capsules and components that appear in the “Convert Model” dialog.
5. Click **Auto-Convert All** from the “Convert Model” dialog.

The Conversion Tool converts the incompatible capsules and components in your model. As the conversion takes place, the Conversion Tool may prompt you to confirm some conversion changes.

**Note:** Only run the Conversion Tool once. If you run the tool a second time, the information displayed in the Convert Model dialog may not be accurate.

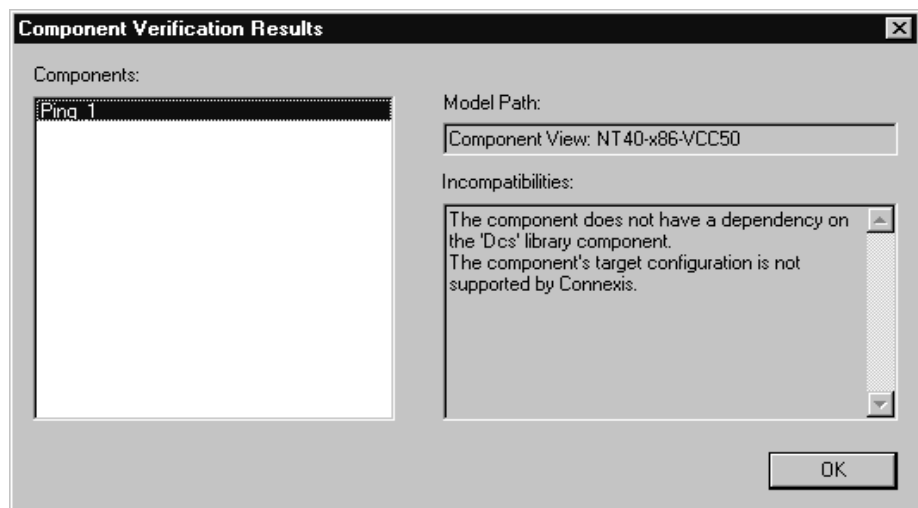
### Verifying Component Compatibility with Connexis Version 2001A.04.00.

The Component Verification Tool verifies that a component is compatible with Rational Connexis version 2001A.04.00.

To verify that a component is compatible with version 2001A.04.00:

1. Right-click a component.
2. Select **Connexis > Verify**.

The “Component Verification Results” dialog appears.



**Figure 51** Component Verification dialog

3. Select the component from the “Components” area.  
The model path and the incompatibilities for the selected component appear.

4. Open the component from the browser and fix the incompatibilities.

**Note:** *You do not have to close the Component Verification Results dialog while fixing the incompatibilities.*

5. Click **OK**.

### RTDErrorType Error Reporting

Connexis reports error types that are defined in the enumerated RTDErrorType class. To access these errors, define an input signal named rtdError with data type RTDErrorType, in the protocol class of the port to be registered with DCS. If any of the following errors occur, the port receives an rtdError message with the error type as data (see Table 11).

**Table 11** *RTDErrorType Error Reporting*

<b>Output</b>	<b>Description</b>
rtdDCSUninitialized = 1	Registration failed because DCS was not initialized.
rtdZeroReplication = 2	Registration failed because the replication factor of the port is zero.
rtdInvalidSyntax = 3	Registration failed because the registration string was of invalid syntax.
rtdInvalidTransport = 4	Registration failed because the specified transport is not supported by this component.
rtdCircuitUnavailable = 5	Registration failed because no virtual circuit is currently available for the remote binding.
rtdLocatorUnavailable = 6	Global registration failed because no locator is available.



**Table 11** *RTDErrorType Error Reporting*

<b>Output</b>	<b>Description</b>
rtdConnectTimeout = 7	Explicit registration failed because a connection could not be established with the remote endpoint.
rtdEndpointUnavailable = 8	A connection cannot be made at present with the remote endpoint because it is currently unavailable.
rtdEndpointInaccessible = 9	A connection can never be made with the remote endpoint.

**Note:** *The last two errors can occur after a successful registration and bind. For that reason they are sent at Background priority. All other errors are sent at General priority.*





## *Chapter 5*

# *Establishing Connections*

---

Establishing Connections provides information to help you decide how you plan to distribute your application and how you can use Connexis to set up connections:

- **General Connection Patterns** - provides information about client/server and peer to peer connection patterns.
- **Unwired Port Registration** - provides information about registration, automatic versus application registration, and registration parameters.
- **Name Resolution** - describes how Connexis resolves host names.
- **Connexis Connection Options** - describes how Connexis handles publisher/subscriber connection patterns. The three methods of establishing connections: local, explicit endpoint, and Locator connections are discussed.
- **Registration Summary** - provides several examples explaining how to use registration strings successfully.
- **Connection Design Heuristics** - provides a summary of connection design principles and how they are handled by Rose RealTime and Connexis. Replicated publisher ports, invokes, broadcast sends, notification, defers and sending data between capsules are discussed.

### General Connection Patterns

---

In the broadest sense there are two connection patterns that can be implemented by an application:

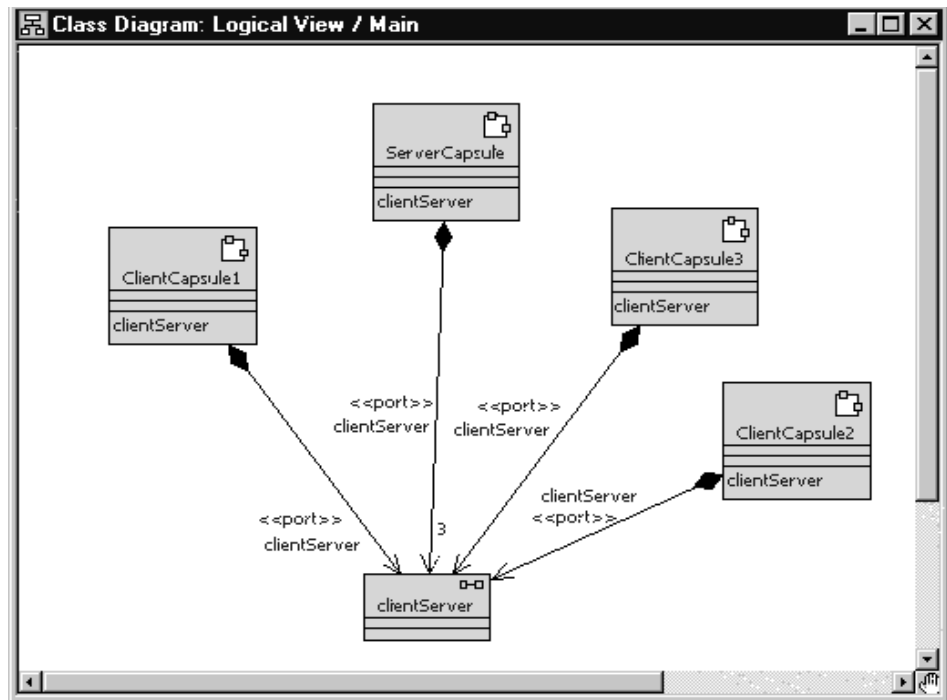
- client/server
- peer to peer

These two patterns are not mutually exclusive. A capsule that is participating in one connection as a client is not limited to that role. It could be participating as a client in one connection and a server in another. The same capsule may also be involved in several peer to peer connections with different capsules.

#### Client/Server

The client/server pattern is used to describe a connection topology in which there is a service provider that is capable of providing services to two or more capsules.

In Figure 52, the ServerCapsule supports three connections on its clientServer port. Each of the client capsules only supports one. In this example, the distinction between the server and the client is that the server publishes its service, and the client subscribes to it. In Rational Rose RealTime, unwired public and protected ports can each play the role of the publisher or subscriber.



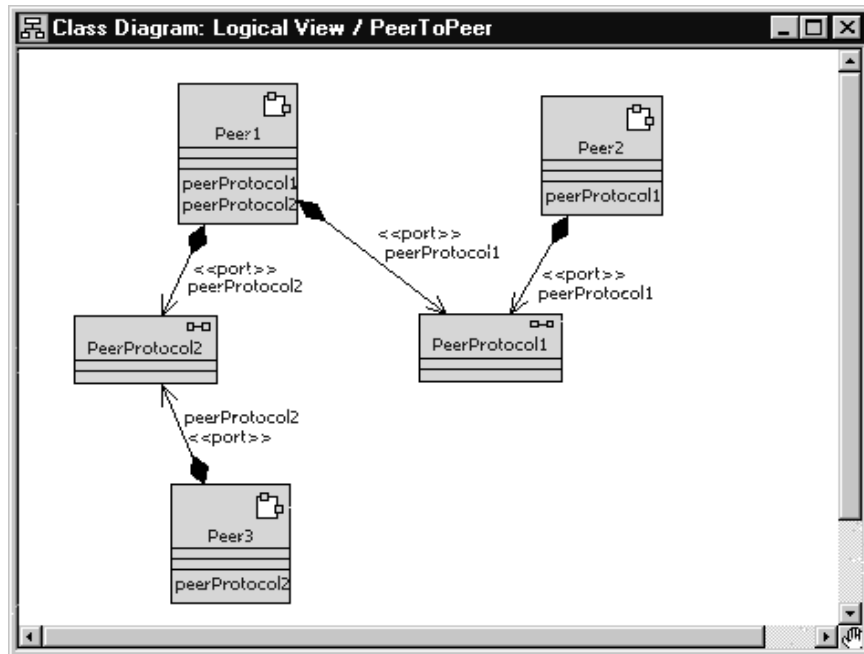
**Figure 52** Client / server pattern

In scenarios where Automatic registration is used, this is configured by selecting the Publish checkbox in the Port Specification dialog box. For more information, refer to the “*Rational Rose RealTime Toolset Guide.*” In scenarios where Application registration is used, publishers use the registerSPP operation and subscribers use the registerSAP operation.

## Peer to Peer

With the peer to peer connection pattern, one capsule is connected to one other capsule and they pass messages back and forth between each other. Even though the two capsules are peers in the communication, one of them must be responsible for publishing its interface and the other for subscribing to the interface.

In Figure 53, Peer1 is connected to both Peer2 and Peer3 in different connections through different unwired ports. In both of the connections, one of the capsules must play the role of the publisher and the other the role of the subscriber.



**Figure 53** Peer to peer connection pattern

## Unwired Port Registration

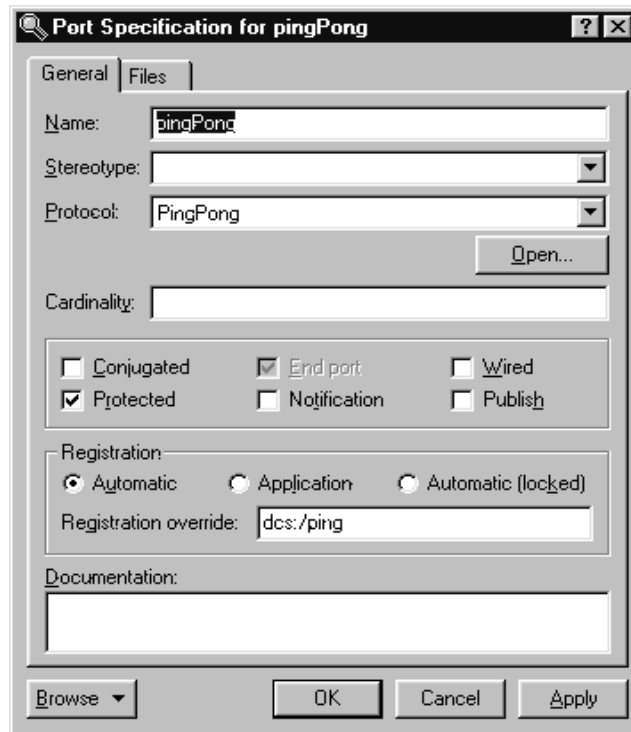
There are three ways to establish a connection using Connexis:

- locally - within the same process
- external explicit - between processes, using an explicit endpoint address
- locator - within the same process or between processes using a name lookup service

The registration string that is used when the port is registered with the Target RSL determines which of these methods is used.

## What is Registration?

In Rose RealTime, unwired ports must be registered with the Target RSL. This registration can be accomplished either automatically, or dynamically through application code. The choice as to which registration method is to be used is set in the specification dialog for the unwired port. This setting is illustrated in Figure 54.



**Figure 54** Port specification dialog

In Figure 54, the Wired check box is not selected. This means that the port must be registered using one of the two methods outlined. If the Automatic registration check box is checked, the port will be registered automatically using the name provided in the Registration override field. If no text has been entered into the Registration override field, the port will be registered under its own name with the ILS. If the Publish

checkbox is checked, the capsule will publish this interface. If the Publish checkbox is not checked, the capsule will request to subscribe to this interface. If the Application registration check box is checked, it is assumed that the registration of the port will be handled by the application code. In this case, the Registration override field is ignored.

### Port API

To register ports dynamically, you must use the functions that are provided on the Rose RealTime port objects. The RTProtocol class implements the concept of a port role in Rose RealTime. At design time, when you create a port role on a capsule, it corresponds to an instance of RTProtocol. The API provided by the Rose RealTime port objects to manage the registration of the ports is implemented on the RTProtocol class. For more information, refer to the “*Rational Rose RealTime Toolset Guide*.”

The RTProtocol class provides the functions required for registration and deregistration of unwired ports. Each function along with a brief description of its responsibilities is presented in the following table.

**Table 12 RTProtocol interface**

<b>Function</b>	<b>Description</b>
registerSAP(serviceName : const char*) : int	Register a subscriber side port with the connection service using the supplied serviceName. The connection service is either the ILS or DCS. Returns a 1 on success or a 0 on failure.
deregisterSAP( : void) : int	Deregisters a previously registered subscriber side port. Returns a 1 on success or a 0 on failure.
registerSPP(serviceName : const char*) : int	Register a publisher side port with the connection service, using the supplied serviceName. The connection service is either the ILS or DCS. Returns a 1 on success or a 0 on failure.
deregisterSPP( : void) : int	Deregisters a previously registered publisher side port. Returns a 1 on success or a 0 on failure.
isRegistered( : void) : int	Returns a 1 if the port is registered, or a 0 if the port is not registered.



**Table 12** *RTProtocol interface*

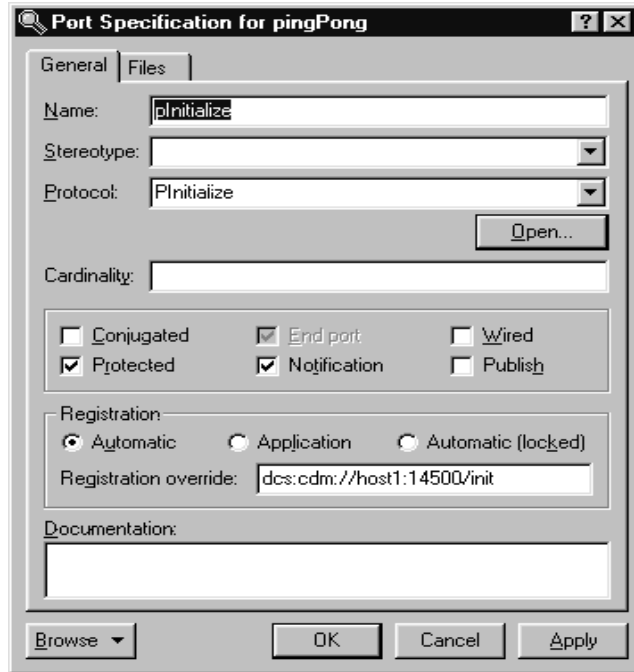
---

<b>Function</b>	<b>Description</b>
getRegisteredName( : void ) : const char*	Returns the service name that was used to register the current port. If the port is not registered, a null pointer is returned.
bindingNotification( on_off : int ) : void	Sets the binding notification of the port to either on (1) or off (0). This is used to programmatically set the notification property of a port.
bindingNotificationRequested( : void ) : int	Returns 1 if the port has notification turned on or returns 0 if the port has notification turned off.

---

### Automatic vs. Application Registration

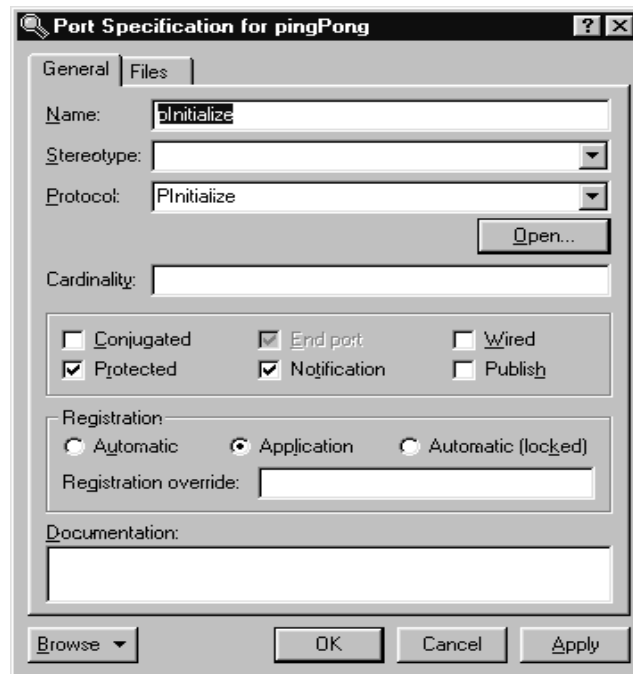
There are two ways to register a port. The first is to specify that the registration be completed automatically. This instructs the Target RSL to register the unwired port with the connection service using the name that was given to the port or with the specified Registration override. This approach is illustrated in Figure 55.



**Figure 55 Automatic port registration**

In this case, the port is registered using the string that was provided in the Registration override field (“dcs:cdm://host1:14500/init”). Since the Publish checkbox is not checked, it is a subscriber. If no override had been provided, the port would have been registered using the port’s name (pInitialize).

The second approach is to specify that the registration be completed by the application, and to then register the port through application code using the RTProtocol interface described in “Port API” on page 112. The port specification for implementing this registration method is shown in Figure 56.



**Figure 56 Application port registration**

When this registration method is used, a registration string similar to what is shown in the “Registration override:” field in Figure 55 must be specified as the argument to the registerSAP() or registerSPP() RTProtocol API function, somewhere in the state machine of the capsule. For example, code similar to the following could be written in the initial transition.

```
pInitialize.registerSAP("dcs:cdm://host1:14500/init");
```

## Registration Parameters

There are often cases where extra information may be required when registering a port with the connection service. Connexis supports passing parameters as part of the registration string. These parameters take the form of tagged-value pairs. The specification string is enclosed in a pair of delimiters. Each tag-value pair is also enclosed in a pair of delimiters. For example:

```
((tag1,value1) (tag2,value2))
```

The “(“ and “)” characters are used as tag-value pair delimiters, and also as delimiters to the entire parameter list. The “,” is used to separate the tag and the value in a tag-value pair.

### **Supported parameters**

For subscribing, Connexis provides registration options to set the transport for global registrations and to specify the quality of service parameters for a connection setup. For publishers, Connexis provides a registrations option to assign a rank to a publisher. The details of these registration parameters are outlined in Table 13.

**Table 13 Supported registration parameters**

<b>Parameter Name</b>	<b>Description</b>
locator_transport	<p>This parameter specifies the transport that is to be used by the subscriber to connect to a publisher.</p> <p><i>Type:</i> string <i>Possible values:</i> cdm, crm and any integrated transports</p>
locator_rank	<p>This parameter specifies the rank of the publisher that is being registered. This parameter only works for ports that are publishers. The higher the number, the higher the rank.</p> <p>If the rank is not specified, the default rank is zero.</p> <p><i>Type:</i> integer <i>Possible values:</i> any integer <math>\geq 0</math></p>
connect_retries	<p>This parameter specifies the maximum number of times that DCS attempts to send a connect message to a remote endpoint to establish a connection. The default, without the option, is infinity.</p> <p>The maximum connect timeout interval is equal to <math>(1 + \text{connect\_retries}) * \text{CNXdcrd}</math>.</p> <p>If connect_retries equals zero, then the maximum timeout is therefore CNXdcrd. If connect_retries equals one, then the maximum timeout is therefore <math>2 * \text{CNXdcrd}</math>, etc.</p> <p>If no connect acknowledgment is received within this timeout interval, a rtdError message with enumerated data rtdConnectTimeout is sent to the application.</p> <p>If the transport timeout interval is shorter than the maximum connect retry interval, a rtdError message with enumerated data rtdEndpointUnavailable may be sent to the application instead.</p>

### Registration parameter examples

The first example registers a subscriber port with “cdm” as the preferred protocol.

```
port1.registerSAP("dcs:/service1 ((locator_transport, cdm))");
```

This example registers a publisher port with the specified rank.

```
port2.registerSPP("dcs:/service1 ((locator_rank, 1))");
```

## Name Resolution

---

Whenever an endpoint is registered using a host name instead of an IP address, Connexis will translate the host name into a valid IP address. On development workstations this will typically be done through a Domain Name Service (DNS). Since the call to the DNS is blocking, Connexis performs this operation using a separate thread, called a helper thread. The following points describe the algorithm that is used by Connexis to resolve host names:

1. An attempt is made to resolve the host name.
2. If the host name cannot be resolved, the name resolution will be retried periodically until it is resolved successfully.

Host names that have been resolved are cached for a number of seconds. This means that if a resolution request is made for a host name that had just been looked up, the result from the last lookup will be returned.

## Connexis Connection Options

---

Connexis is able to handle the connection patterns listed in General Connection Patterns, as well as other connection topologies common in distributed systems. It does this using the publisher/subscriber pattern. With this pattern, every virtual circuit in a Connexis model has a publisher at one end of the communication channel and a subscriber at the other end. The publisher publishes its interface with the connection service (or the locator) and the subscriber subscribes to that interface.

At the highest level, there are three different ways that connections can be established using Connexis:

- locally - connect to another object within the same executable

- external using an explicit endpoint - connect to an object in another executable using an explicit endpoint
- using the locator service - connect to an object using the Locator service to resolve the endpoint address

### Local Connections

Rose RealTime has a built-in connection service called the Internal Layer Service (ILS). The ILS is used to connect unwired ports within the same executable, or to be more precise, within the same instance of the Rose RealTime Run-time Service Library (Target RSL).

The ILS establishes the connection between two local unwired ports. Registering ports locally is the simplest of the three registration types but it is also the least flexible. When a port is registered with the ILS, it cannot send or receive messages to or from ports in another executable model.

In addition to establishing local connections using the ILS, you may also use Connexis to accomplish the same thing. Using Connexis to establish local connections has the following advantages:

- Connexis supports multiple publishers with the same registration name (the ILS does not)
- Connexis allows you to establish loopbacks that can be used to fully trace the message flow between the connected ports. This can be very useful for debugging an application.

#### Local connection examples

This section presents two examples:

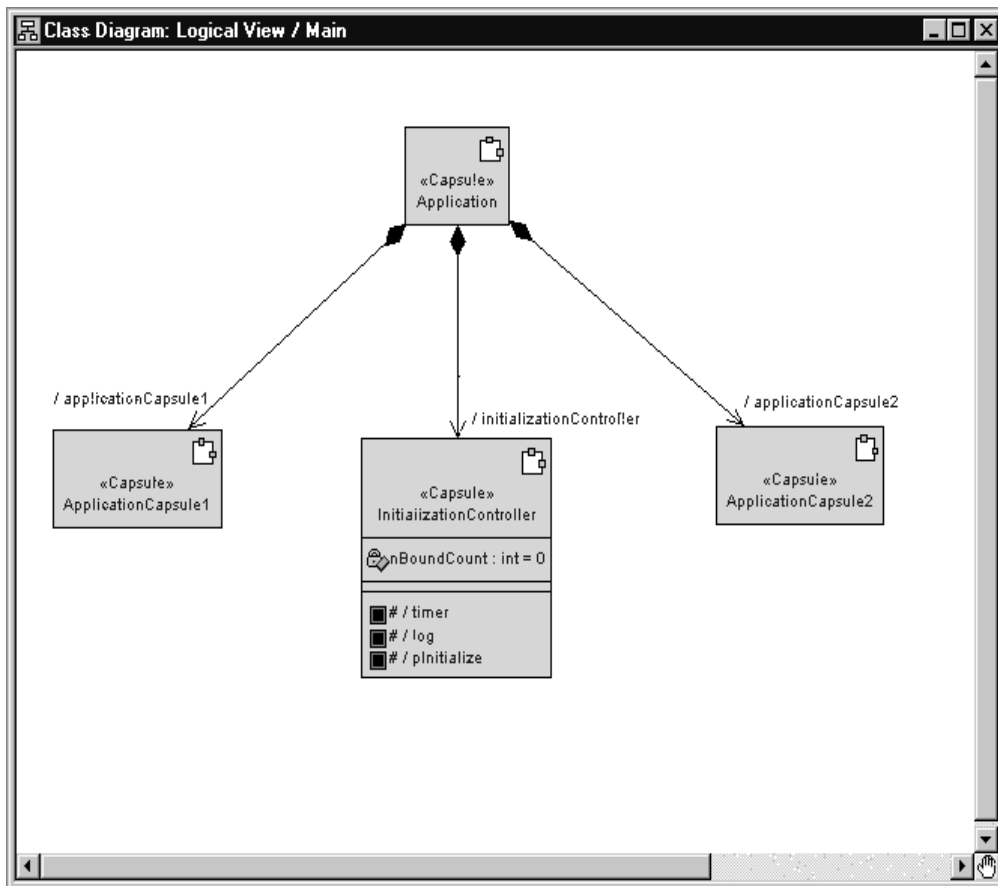
- local connection with DCS using automatic registration
- local connection with DCS using application registration

**Example 1: Local connection, ILS, automatic registration and override**

This example illustrates how to register an unwired client side port and a corresponding server side port using automatic registration.

This example implements a simple initialization controller. The controller is responsible for making sure that the components of an application are initialized in a predetermined order.

The structure for the initialization controller is shown in Figure 57.



**Figure 57 Class diagram of initialization controller**



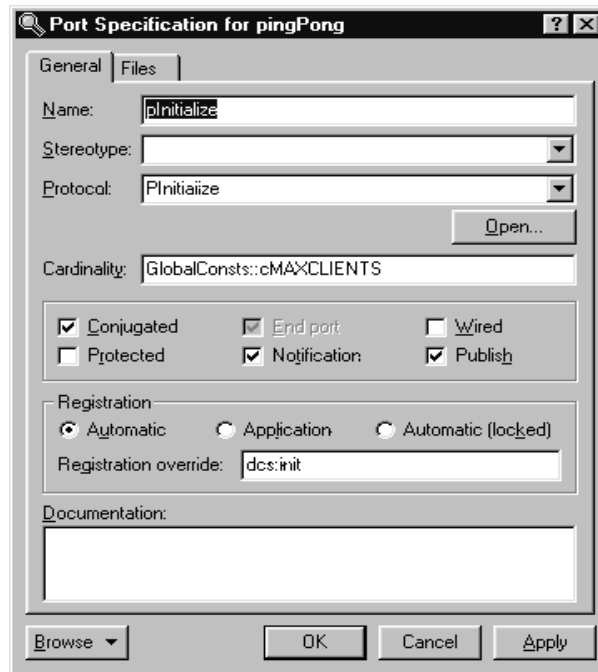
In this structure, the initialization controller capsule requires a connection to each of the capsules in the application. These connections are required so that it can send initialization messages to each of the capsules. If this application exists completely in a single executable, the initialization controller could connect to each component through a wired port. This implementation may cause the following problems:

- The structure is unnecessarily complex as a result of having to show all of the physical connections between the different capsules.
- The structure is not as flexible. More effort is required to separate some of the components out into separate applications.

For these reasons, the pattern is better modeled using unwired ports.

To automatically register the ports in this example for each initialization port:

1. Select the port and open its specification dialog.
2. Uncheck the **Wired** option.
3. If the port is being published (that is, server in a client/server distribution pattern), check the **Publish** checkbox.
4. Select the **Automatic** registration option.
5. If notification is being used, check the **Notification** check box.
6. Type in a DCS Registration string in the **Registration override** field.



**Figure 58** Specifying automatic registration

As mentioned in the Connexis Quick Start, the convention usually followed is to conjugate the port that is being published (this would correspond to the server in the client/server distribution pattern). The reason for this is twofold:

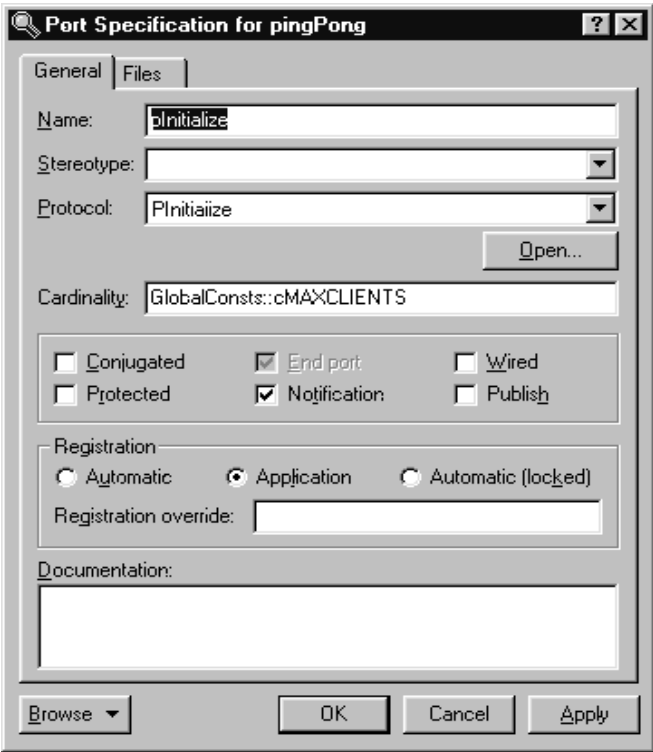
- By following a convention, the naming of protocols and signals will be consistent throughout the model.
- It requires fewer steps in a client/server pattern because only the one server port needs be conjugated (instead of all of the clients).

In this case, the registration name is overridden by entering “**dcs:init**” in the Registration override field. This means that this port is registered with the DCS with the name “init”. Since the Publish option is selected, the port is published. If nothing is entered in the Registration override field, the port name, pInitialize, is used and is registered with the ILS. Automatic registration using the DCS requires registration override; otherwise, it defaults to the ILS

If you register your ports with the DCS (instead of the built-in ILS) and you are making use of the Locator service, you will not have to make changes to the registration string if one side of the connection is moved to a different process.

**Example 2: Local connection and application registration**

This example illustrates registering an unwired client port and a corresponding server port using application registration. This example uses the same sample capsules as the previous example. In this case, the ports are defined as application registration as shown in Figure 59.



**Figure 59 Specifying application registration**

When a port is registered using application registration, the Registration override field is ignored and the functions described in the port API must be used to register the port with the connection service.

The code required to register the port with the DCS is written as follows:

```
pInitialize.registerSPP("dcs:init");
```

The above line of code registers the pInitialize port with the DCS using the "init" service name.

### External Explicit Connections

External explicit connections are connections that:

- are made with capsules that are running in another process, either on the same processor or a different processor on the network
- the name of the endpoint is known at design time or can be specified at run-time through a configuration file or command line argument

Explicit connections are typically used in a fixed network environment where the network configuration is known and rarely changes.

Using explicit connections is less flexible than making use of a Locator service, but in cases where the network addresses and endpoint names are known, it is a smaller (memory wise) and faster approach. The decision to use either the Locator service or explicit connections depends mostly on the requirements of the application and the network configuration that it will be running in.

### External explicit examples

With explicit connections, more information must be known by the applications about the other side of the connection. Each subscriber must know or be able to find out the explicit endpoint addresses of all of the other objects that it wants to subscribe to.

Registering the publisher side of the connection is similar to the local and Locator cases. The connection service and the service name are all that is required. When starting the publisher component instance, you usually specify endpoints on which it will be listening.

The subscriber side of the connection is quite a bit different. In this case, you must know the endpoint address of the publisher and specify it in the registration string.

### ***Queueing of Subscriptions***

If a subscriber registers before a transport connection has been established to the remote endpoint, the DCS repeatedly attempts to establish a connection to the remote endpoint. If the "conn\_retries" registration option has not been specified in the registration string, the DCS will try to establish the connection until the port is deregistered.

If a connection to the remote endpoint is established, but the registration takes place before the service is published at the remote endpoint, the registration is left pending until a service is published or the subscribing port is deregistered.

### ***Using the CDM transport protocol***

The publisher application would perform the following:

```
<port_name>.registerSPP("dcs:myService");
```

Assuming that the myService publisher is started on node "host2", and is listening on port 45678, the following registration string is used by the subscriber:

```
<port_name>.registerSAP("dcs:cdm://host2:45678/myService");
```

This tells Connexis to try to connect to port 45678 on host2 to get to the desired publisher. The format of the string is defined by the BNF Registration String Grammar. For more information, see "Registration String Grammar" on page 245.

For this example to work properly, the application in which the publisher is running must be started using the following CNXep command line parameter:

```
<app_name> -CNXep=45678
```

## **Locator Connections**

The most flexible way of registering unwired ports is to use the Locator service. The Locator service maps endpoint service names to physical endpoints on the network. This enables applications to not be intimately aware of the network topology, which also means that they do not have to change when the network topology changes.

The Connexis Locator is implemented as a Rose RealTime Connexis component. Unwired ports register (subscribe or publish) themselves with the Locator instead of the connection service. The Locator is then responsible for finding the appropriate endpoints and insuring that they are bound together.

Using the Locator is similar in nature to using local connections, you register a service name for the port with the Locator and the rest is handled for you. The key differences between using the Locator and using local connections are:

- A Locator component (RTDBase\_Locator, or RTDBase\_Locator\_Agent) must be included in the executables that are implementing the Locator (either primary or backup).
- The Locator service must be started when the Locator is being used.

This means that a primary Locator must have been configured using the `-CNXlp` configuration option on the Locator process, and the client processes must be started with the `-CNXlpep` configuration option, which specifies the address of the primary Locator.

- The registration string is slightly different. Instead of using a string with the syntax, `dcs:<service_name>` you must use a string with the syntax, `dcs:/<service_name>`. This registration string registers the port with the DCS and with the Locator.

When a subscriber is registered using this registration string syntax, it first looks for a local publisher to which to connect. If it finds a local publisher with the service it is looking for, it will connect to it. If no local publisher is found, it subscribes to the Locator service.

### Locator examples

To register a publisher named `QueryState` using the Locator, the following registration string would be used:

```
port1.registerSPP("dcs:/QueryState");
```

To register a subscriber that subscribes to the same `QueryState` service, the following registration string is used:

```
port2.registerSAP("dcs:/QueryState");
```

Note that this example assumes that the applications have been started using the appropriate command line arguments and the RTDBase\_Locator capsule has been dragged into the application providing locator services.

## Registration Summary

---

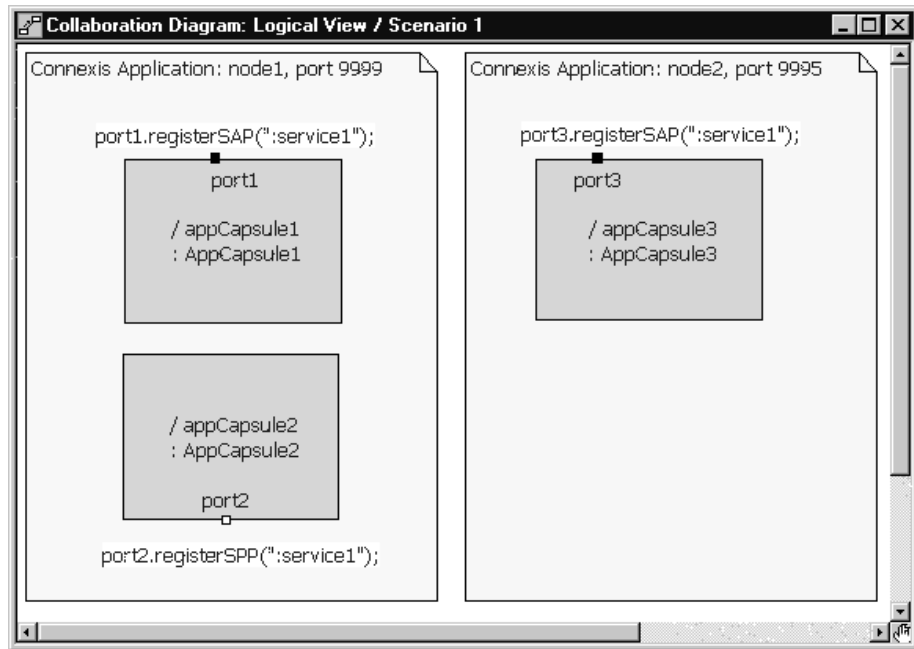
This section presents several registration scenarios and explains what registrations strings will succeed and fail in each. The important points to realize about Connexis registration are:

- Ports that are registered with the ILS are registered in a different namespace than those that are registered with the DCS. This means that a subscriber port registered as *:test1* will not bind with a publisher registered as *dcs:test1*.
- Ports that are registered with the Locator are also implicitly registered with the DCS. This means that they will bind with locally registered DCS ports and also explicit DCS ports with the same service name.
- Ports that are registered with the registration string “servicename” (as opposed to “:servicename” or “dcs:servicename”) share the same namespace as ports that are registered with the ILS (“:servicename”). This type of registration is present for backwards compatibility reasons only, and as a result, is not discussed in this section.

All of these examples assume that the publisher is replicated, that is, it can support the number of subscribers that are trying to connect to it.

### Scenario 1: Publisher Registered with the ILS

In this scenario, a publisher (port2) is registered with the ILS and two subscribers (port1 and port3) attempt to make connections to the publisher.



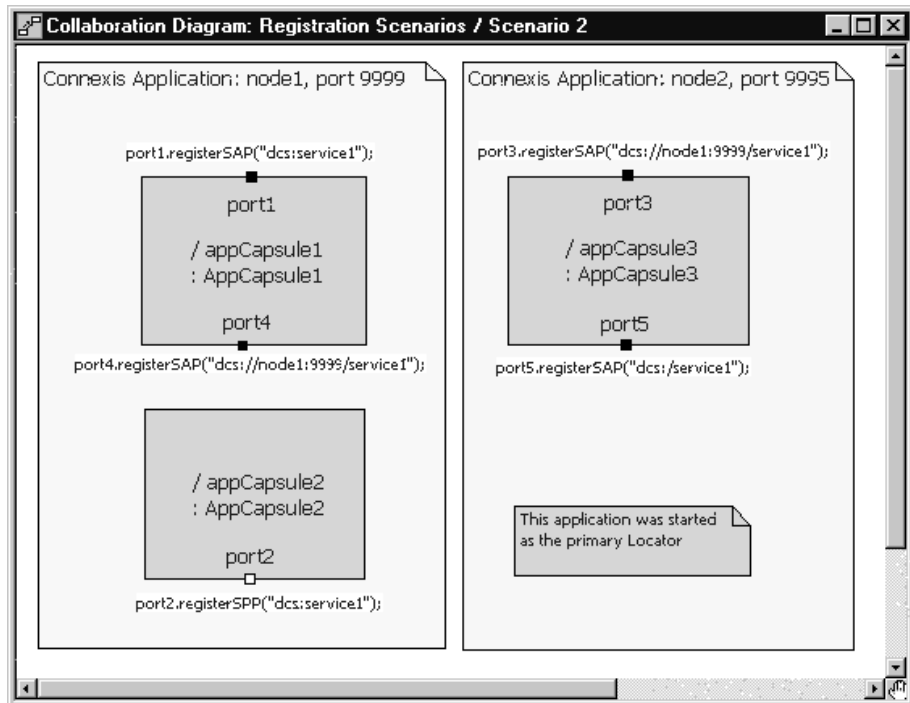
**Figure 60 Scenario 1: Registering ports with the ILS**

In this scenario, port1 will connect to port2 but port3 will not. This is because port2 has been registered with the ILS which is only capable of connecting ports locally. Port2 would also not be capable of receiving explicit or locator connections from a different process.

### Scenario 2: Publisher Registered with the DCS

In this scenario, the publisher is registered with the DCS. Several subscribers, each registered using different methods, attempt to establish connections to the subscriber.





**Figure 61 Publisher registered with DCS**

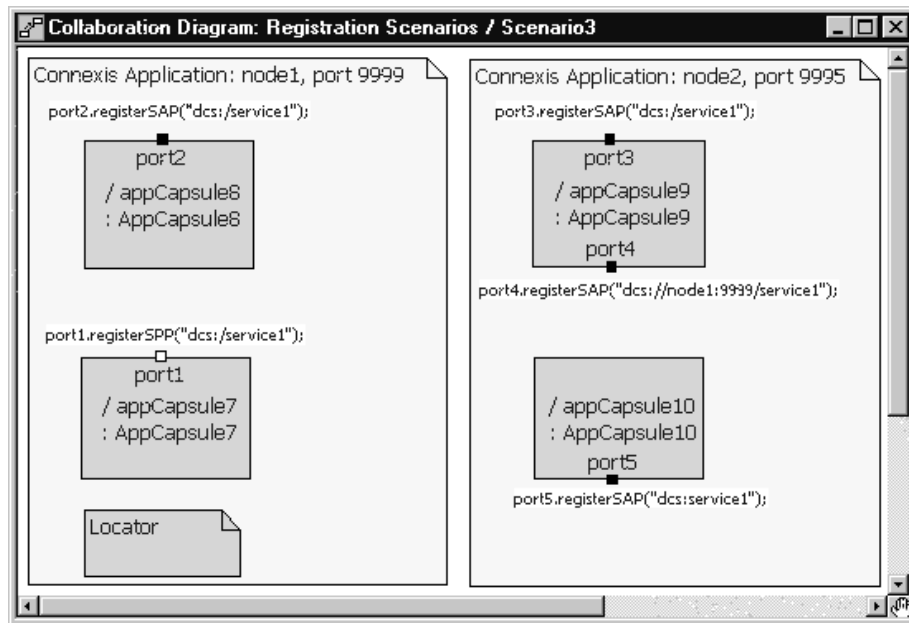
**Note:** In this scenario the location of the Locator Service is not relevant to the outcome of the registrations.

In this scenario, port2 registers with the DCS. Also, port1 connects to port2 by forming a local DCS connection. Port3 and port4 also connect because, by registering with the DCS, port2 is capable of receiving both local DCS connections and explicit connections (whether they are internal or external). In this scenario, the only registration string that will not result in a successful connection being established is the one that is used to register port5. This registration string is looking to the Locator to resolve the endpoint name. Since port2 did not register with the Locator, no compatible publisher will be found for port5.

**Note:** A local DCS connection is an intra-process connection that is using the DCS instead of the ILS. As with ILS connections, local DCS connections, once bound, have the same run-time performance as connections that are bound at design time.

### Scenario 3: Publisher Registered with the Locator

In this scenario, the publisher (port1) registers with the Locator Service. Several subscribers, each using a different registration string, attempt to establish connections to the publisher.



**Figure 62** Publisher registered with the Locator

**Note:** In this scenario, the location of the Locator Service is not relevant to the outcome of the registrations.

In this scenario, the publisher (port1) is registered with the Locator Service. The interesting aspect of this type of registration is that registering with the Locator Service implicitly registers the port with the DCS. This means that subscribers can make explicit (either local or remote) connections to a publisher that was registered with the Locator Service. Port2 and port3 will both successfully connect to port1 since they use the Locator. port4 will also connect because it is specifying the endpoint explicitly. Port5 will not be connected, since it is registering locally with the DCS.

### Multiple Publishers

Unlike the ILS, Connexis supports multiple publishers with the same registration name. The ILS restricts the naming of unwired ports that are publishing themselves, so that each published unwired port must be named uniquely. The port can be replicated but two capsules cannot have published ports with the same name.

This restriction is removed when using Connexis. Multiple capsules can have published unwired ports that use the same registration string. This can be very useful for distributing the load in a distributed system.

For example, if the application being built has a service provider that offers a database lookup service, Connexis could be used to distribute this service between two or more capsules running on separate processors in the network. This can also be modeled locally without having to change any code when the distributed version is released. This can be accomplished by using the Locator service or by reading a configuration file that contains the endpoints of the different components.

## Connection Design Heuristics

---

### When to Use Replicated Publisher Ports

This is a common design pattern. It is very common in real-time and non-real-time systems, for a single software element to provide services to multiple others. A very common example of this is a web server. When you connect to a website, like [www.rational.com](http://www.rational.com), you are connecting to a server process that is running on the host machine. The server process is listening on a particular TCP/IP port and when a request comes in, it spawns a task to handle that particular client interaction. Multiple clients can connect to [www.rational.com](http://www.rational.com) at the same time.

One thing to be careful of when using replicated publishers (or multiple publishers with the same name) is to make sure that the number of publishers is appropriate for servicing the number of subscribers. If the number of subscribers is significantly greater than the number of publishers thrashing could occur.

### Use of Invokes

Invokes in Rose RealTime are the equivalent of synchronous messages. Remember that the normal method of communication in a Rose RealTime model is through asynchronous message sends. In contrast, invokes are very similar to regular function calls on objects in a system. The issue that can arise with invokes is that they bypass the normal message queuing structure that is in place in Rose RealTime. The calling capsule is blocked until the receiving capsule completes the transition code that has been called and returns. In addition, the receiving capsule must know to reply to the invoke.

Rose RealTime invokes cannot be used across thread or processor boundaries. This means that if invokes are used in a particular situation, you will not be able to separate the two capsules involved in that connection into separate threads or processes without changes to the code. Since Connexis is used specifically to send inter-process messages, invokes cannot be used with Connexis-enabled connections.

### Use of Broadcast Sends

A broadcast send is a send that is performed on a replicated port without specifying an index. Broadcast sends result in a message being sent to each of the capsules that are connected on the other side of the port.

There are many cases where broadcast sends are a useful and appropriate technique. For example, when initializing capsules in an application, it may be necessary to send all of the capsules of a particular class an initialize message. If the order of the initialize messages is not important, a broadcast send may be used.

The consequences of using a broadcast send are performance-related. A broadcast send on a port that has a multiplicity of  $n$  results in  $n$  individual message sends. This can impose a significant amount of overhead on your system, especially in cases where  $n$  is large and the messages are sent between processes.

### Use of Notification

Notification is used to instruct the run-time libraries to send a message on a port whenever the port has been connected or disconnected from its peer on the other side of the connection. The `rtBound` message is sent when a connection is established and the `rtUnbound` message is sent when a connection is removed. In general the use of notification simplifies the job of the developer.

There is one rule that must be followed when notification is being used on a port: when you deregister the port, and plan to register it again later, you must wait to receive the `rtUnbound` event before reregistering the port.

This is required because the priority of the `rtBound` message is higher than that of the `rtUnbound` message. This means that if you deregister a port and then immediately register it again, the `rtBound` message could arrive first followed by an `rtUnbound` message. This could result in an unexpected message or it could cause the capsule to go into an incorrect state.

### Use of Defers

Message deferral is a Rose RealTime feature that allows you to defer messages that are received when a capsule's state machine is not ready to process them. Messages that have been deferred can be recalled at a later time for processing. Although message deferral is a useful, and in some cases, a necessary design technique, it does complicate the state machine design of your model. For this reason, defers should be used judiciously in Rose RealTime models.

In some cases, defers are used to get around the asynchronous implementation of a part of the design that is logically sequential. For example, if you are starting a service by asynchronously requesting an object from an object factory, you may receive messages destined for the new object before it has been created and returned by the object factory. There are two solutions to this problem. The first is to defer the incoming messages. The second is to request the object synchronously using an `invoke`.

Both of these solutions have trade-offs to consider. If you go the defer route, the state machine of the capsule becomes more complicated. There is also a greater probability of maintenance problems because state machine changes may require additional recalls to be placed in the code. If this is not done properly, errors may be introduced into the model.

With the invoke solution, an entirely different set of issues results. There are no longer any message order issues, and the state machine is typically cleaner, but the connector that the invoke is being called on is required to remain in the same thread.

### **Sending Data**

There are many performance issues to consider when sending data between capsules. The first thing to keep in mind is the relative performance of different kinds of message sends. In general, the types of message sends can be listed in order of relative performance (from fastest to slowest) as in the following list:

1. intra-thread
2. inter-thread
3. inter-process (same node)
4. inter-process (over network)

In addition, messages with little or no data associated with them are typically faster than messages with a large payload. This would lead you to believe that it is better to send small messages between capsules, especially when the messages are sent between processes. This is true in general but the decision is a little more complicated than that. The other factor that comes into play is the frequency of the messages that are being sent. If you are sending small pieces of data between two capsules hundreds of times a second, it would typically be faster to buffer this data on the sending side and send a few larger messages. These are some of the decisions that must be made when designing a distributed application.

### **Sending Data Classes by Value**

In order to send a data class by value across processes, it must be marshallable. Refer to the “Data Classes that are Marshallable” in the Rational Rose RealTime C++ Guide.



## *Chapter 6*

# *Using the Connexis Locator Service*

---

The Connexis Locator Service fulfills the role of the name server in a Connexis application. The Locator does not have to be configured or used in a Connexis application, but depending on the application's requirements, it can be very convenient.

The Connexis Locator Service supports both a primary and a backup locator. In this way, a distributed application can be made more robust by ensuring that the name server is not a single point of failure.

By using the Locator, the location of endpoints to which an application is sending messages can remain totally transparent to the application. The application uses service names to refer to the endpoints that are being connected. The physical address of these endpoints never has to be revealed to the application. This makes creating a network topology that can be dynamically changed without affecting currently executing software, much easier than if physical endpoints are used. This strategy also allows load sharing topologies to be created much more easily than if physical endpoints are used.

This chapter discusses:

- Adding Locator Support to a Model - describes the capsule roles required to add Locator service.
- Publication and Subscription - describes how the Locator handles publishers and subscribers. It provides information about ranking published ports and load-sharing publishers.

- **Locator Dynamics** - describes how the Locator operates when a publisher becomes fully subscribed, a subscriber loses its connection to a publisher, the primary Locator fails, or a subscriber is unconnected. It also discusses Locator race conditions.
- **Locator Configuration** - describes the Locator configuration parameters and provides examples of how to start your application using a primary locator and backup locator.
- **Creating your Own Name Service** - provides guidelines on using a custom name service in place of the Connexis Locator.

### Adding Locator Support to a Model

---

To add the Locator to your application you must add a capsule role for either the `RTDBase_Locator` or the `RTDBase_Locator_Agent` capsules to a capsule in your application. Each node that is going to have a Locator configured to run with it (either backup or primary) must have one of these capsule roles contained in it (see “Sharing DCS Interfaces” on page 84).

The `RTDBase_Locator` capsule only adds support for the Locator (primary or backup). The `RTDBase_Locator_Agent` adds support for both the Locator and for the Target Agent which is needed to run the Connexis Viewer.

### Publication and Subscription

---

In Connexis, one endpoint in every distributed connection is the publisher and the other is the subscriber. The publisher posts (or publishes) its interface, making it available for another endpoint to connect to it. The subscriber connects to an endpoint that has been published. This pattern can be used to implement any kind of distributed connection topology. For example, client/server, peer to peer, etc.

#### Publication

A port is published with the locator by providing its service name and the endpoints where it can be reached. Multiple ports can be published with the same server name from the same endpoint, or different endpoints.



The `registerSPP()` port function is used to publish a port. Deregistration of a published port (using the port's `deregisterSPP()` function) causes it to be unpublished from the locator and severs any connections that are using that port.

### Subscription

A port subscribes to the locator by providing its endpoint and the name of the service to which it wants to connect. If no port has previously been published with that service name, the subscription remains pending. Once one or more ports are published with that service name, the Locator returns the publisher with the highest rank using the preferred protocol, to the subscriber endpoint. If the subscriber has specified a protocol (`locator_transport`), the highest-ranked publisher which supports that protocol is returned. The DCS then makes an explicit registration on behalf of the subscriber port with the returned publisher.

The `registerSAP()` port function is used to subscribe a port to a service.

### Ranking Published Ports

The Locator supports the ranking of publishers. The default ranking of published ports is dependent on the following factors:

- the rank that the publisher is given
- the protocol that the publisher is using

The rank of a publisher is specified by the designer through the use of a registration parameter. For example:

```
<port_name>.registerSPP("dcs:/service1 ((locator_rank, 1))");
```

When the locator searches for an endpoint to return, it follows this algorithm. If a subscriber has specified a preferred transport, using the locator-transport parameter when the SAP is registered, the locator returns an endpoint published on that transport.

If the subscriber has not specified a preferred transport, but the locator has been started with the -CNXlpt=<transport> command line argument, it will return an endpoint published on the transport specified. This is the case if a publisher exists and if the subscriber has the transport available. If no endpoint has been found, the locator returns the first endpoint published on any transport the client has available. There is no default preferred transport version 2001.03.00 of Connexis.

In all cases, the locator respects the rank, if any, that the publisher specified using the locator-rank registration parameter. The highest ranking endpoint will always be returned. The selection of an endpoint from among many of the highest rank is arbitrary. The default rank is zero.

### Load-sharing of Publishers

Publishers of equal rank are load-shared among subscribers using a simple round-robin algorithm. As the publishers are load-shared, the assignment of a publisher to a subscriber is non-deterministic.

### Examples

Ports publish themselves using the registerSPP() function call on an unwired end port and subscribe to a published port using the registerSAP() function call on an unwired end port. This section presents several examples of registration strings that could be used with these functions to publish or subscribe to interfaces using the Locator service.

#### **Example 1: Basic Locator registration**

Publish:

```
<port_name>.registerSPP("dcs:/service1");
```

Subscribe:

```
<port_name>.registerSAP("dcs:/service1");
```

**Example 2: Locator registration using custom ranking**

Publish:

```
<port_name>.registerSPP("dcs:/service1((locator_rank, 1))");
```

Subscribe:

This parameter only applies to the publish side of a connection.

**Example 3: Specifying the protocol**

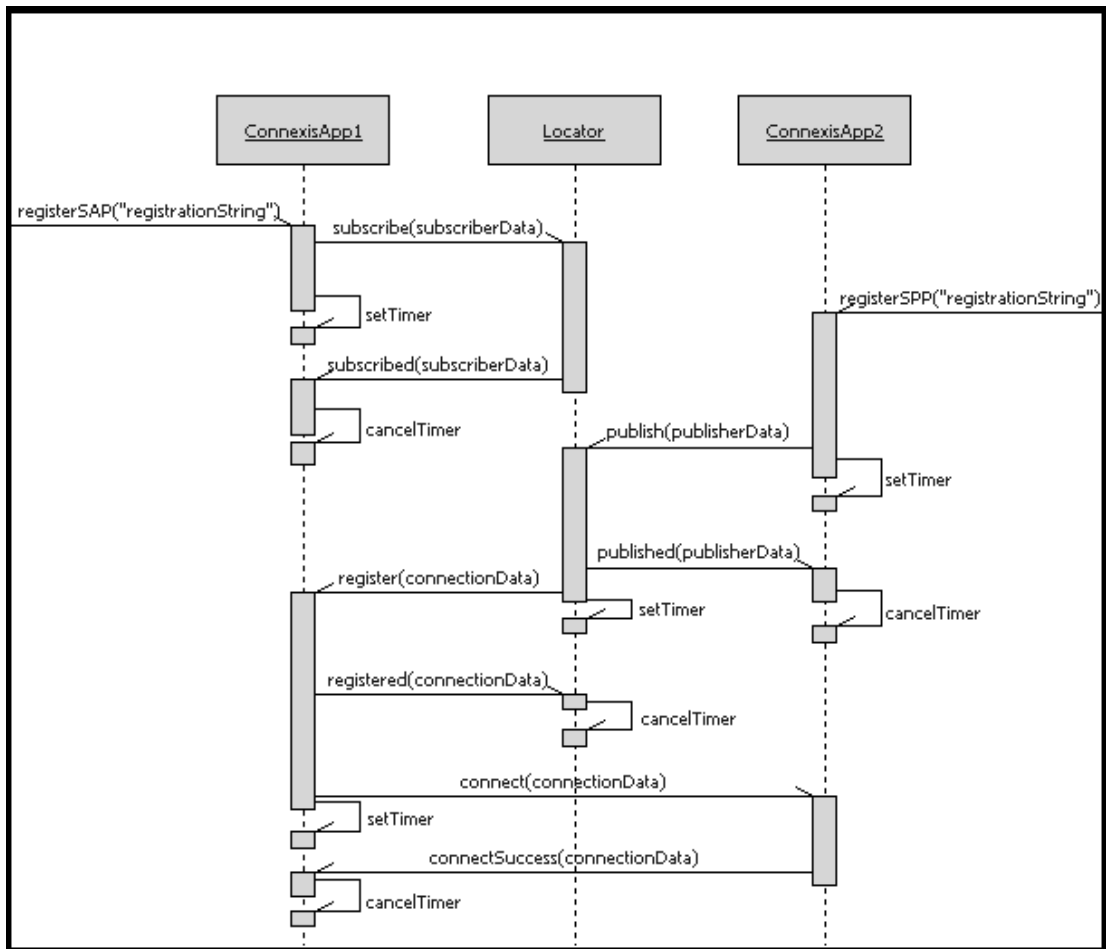
```
<port_name>.registerSAP("dcs:/service1((locator_transport, crm))");
```

Notice that in the simple cases (where a custom ranking or protocol is not being used), the registration string for both the publisher and the subscriber is the same and neither side of the connection has any knowledge of the value of the other side's physical endpoint address.

If a subscriber is registered using the Locator (registerSAP("dcs:/service1")) and no Locator is available (meaning the application was not launched with a -CNXlp or -CNXlpep parameter), then the registration will fail. If the same scenario exists for a publisher, the port will still be registered with the DCS and will be able to accept local and explicit connections.

## Locator Dynamics

Figure 63 is a sequence diagram that illustrates the basic publication and subscription operations of a Locator.



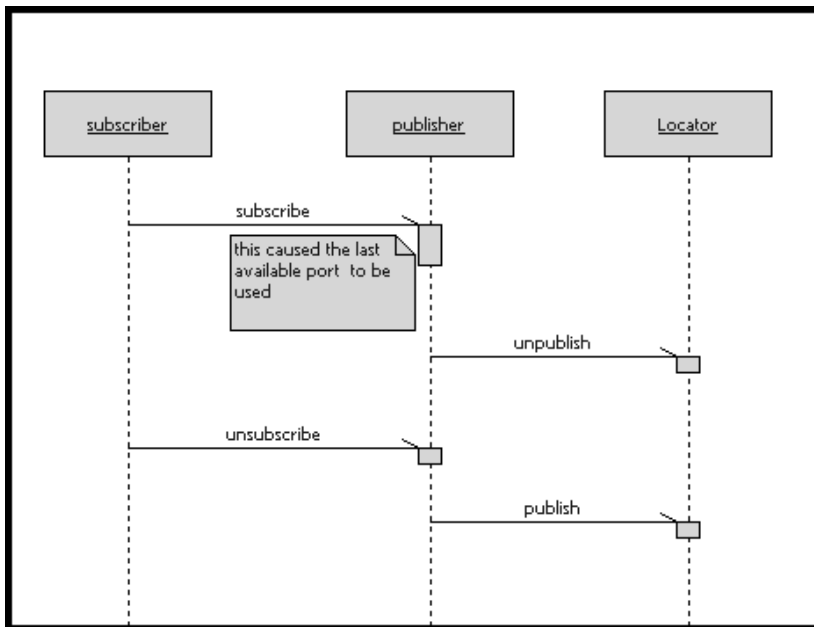
**Figure 63 Basic publication and subscription**

From the user application perspective, the publication and subscription is accomplished through the registerSPP() and registerSAP() function calls on the port objects. The rest of the messages shown on the sequence diagram in Figure 63 are internal messages that occur as the result of a registerSAP() or registerSPP() function call.

The Locator can be configured to execute on any node in the distributed application. This configuration is accomplished through command line parameters that are discussed later in this section.

### Fully Subscribed Publishers

When a publisher becomes fully subscribed (meaning that all of the ports on the publisher have been subscribed to), the publisher unregisters itself from the locator. At a later time, if a subscriber deregisters itself from that publisher, the publisher republishes itself with the locator. This sequence of events is illustrated in the sequence diagram shown in Figure 64.



**Figure 64 Fully subscribed publishers**

### Subscriber Losing Connection to a Publisher

If a subscriber that has successfully connected to a published endpoint later loses that connection (through deregistration of the publisher, failure of the publisher's host, etc.), and this is detected by the underlying transport, then the subscriber port is automatically resubscribed to the locator. If the underlying transport does not provide this quality of service, then it is up to the user application to implement a failure detection mechanism in the protocol to detect messaging failures and reregister as necessary.

One possible solution to this problem is to set up a timer on the subscriber that periodically sends a message to the publisher. If the publisher does not respond to this message within a specified amount of time, the subscriber resubscribes to the service.

### Locator Failure

If the primary Locator has been configured with a backup, and the primary Locator goes down, the backup Locator automatically takes over the role of primary Locator. When this primary/backup strategy is used, the primary and backup Locators should be placed on different nodes in the network. This ensures that there is not a single point of failure in your distributed application.

Figure 65 illustrates the basic fail-over scenario of a primary/backup Locator.

The backup continually polls the primary, and restarts the election protocol should the primary fail to respond. The backup assumes the role of the primary when the primary continues to fail to respond to the election protocol. When the backup takes over, it broadcasts a message to all endpoints stating that it is now the primary locator. The endpoints acknowledge this and republish all global publisher ports and pending subscription ports with the newly elected primary Locator.

Should the original primary locator become available again, it assumes the role of the backup locator.

During the time that it takes for the transition from primary to backup locator to take place, new publish or subscribe requests will be delayed until the backup locator takes over.

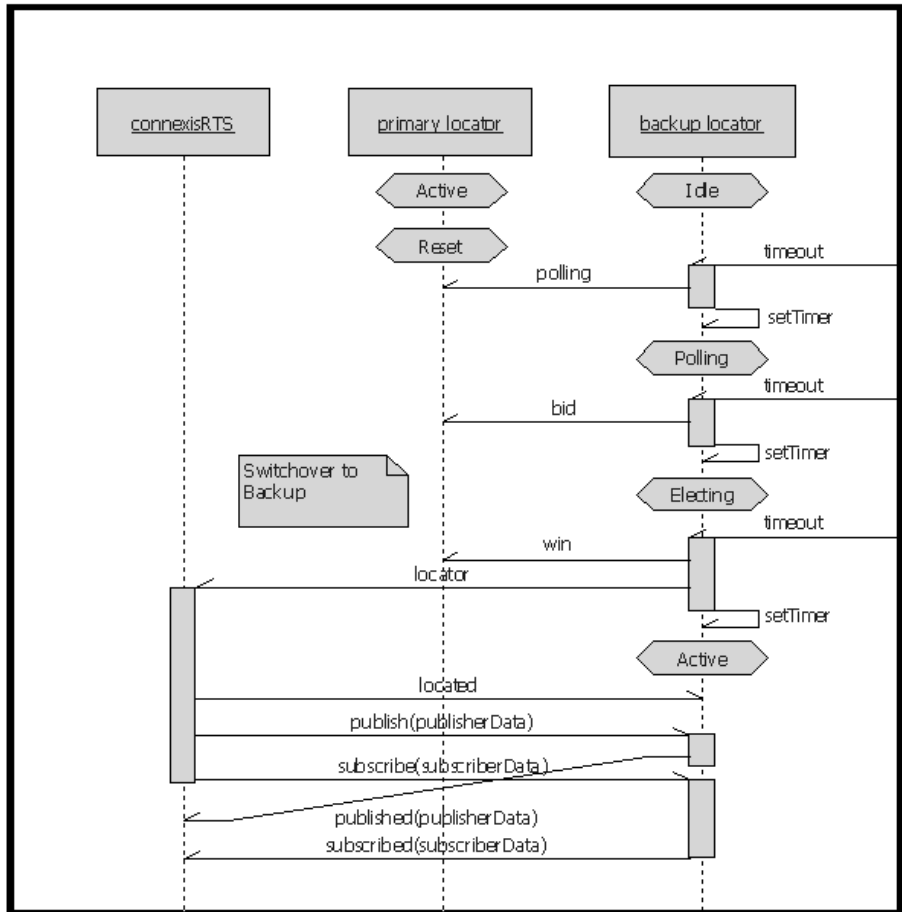
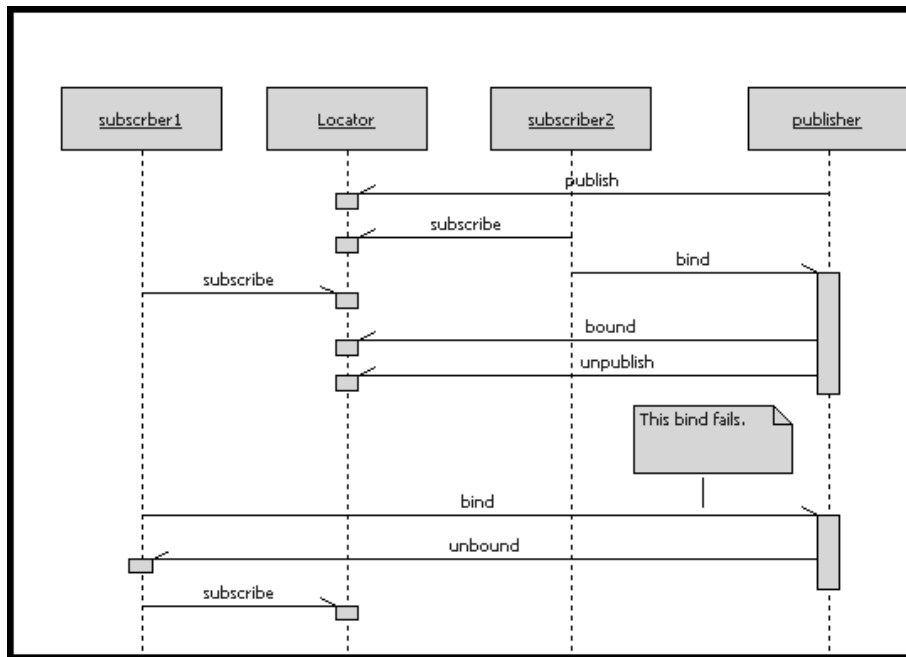


Figure 65 Primary to backup switchover

### Locator Race Condition

There may be cases where the publisher becomes unavailable in between the time that its endpoint is received from the locator and the time when the explicit registration is attempted. One scenario that would cause this to happen is illustrated in the sequence diagram in Figure 66.



**Figure 66** *Locator race condition*

In this case, subscriber2 got the endpoint from the locator and bound to the last available port on the publisher. Meanwhile, subscriber1 got the endpoint from the locator (before the publisher had unpublished with the locator), and attempted to bind to it. This bind fails because there are no ports left on the publisher. This scenario causes subscriber1 to resubscribe with the Locator.



## Unconnected Subscribers

If no unbound publishers are available, the subscriber remains pending at the locator forever. Deregistration of a subscriber port that has a pending subscription causes it to be unsubscribed from the Locator.

## Locator Configuration

The Locator service is an optional service that provides subscribers with an endpoint that will be used on a first-come, first-served basis when trying to connect to a publisher. The Locator service can be initialized with both a primary and a backup server.

The initial Connexis release only supports a single backup server. This limits the level of fault-tolerance to a single processor failure. This is not a fundamental restriction of the primary/backup approach and support for multiple backup servers may be added in future releases. It is possible to operate with a single Locator for test purposes or if fault-tolerance is not required in the product.

## Locator Parameters

There are several configuration options that can be used to set up the Locator for specific environments. These are listed in Table 14.

**Table 14** *Locator command line options*

<b>Command Line Option</b>	<b>Description</b>
CNXlocator_primary (CNXlp)	Specifies that this process should be made the primary locator.  <i>Argument Type:</i> none <i>Default Value:</i> none
CNXlocator_backup (CNXlb)	Specifies that this process should be made the backup locator.  <i>Argument Type:</i> none <i>Default Value:</i> none

**Table 14** *Locator command line options*

<b>Command Line Option</b>	<b>Description</b>
CNXlocator_primary_endpoint (CNXlpep)	Specifies the endpoint of the primary locator (if this process is not the primary locator).  <i>Argument Type:</i> string <i>Default Value:</i> none
CNXlocator_backup_endpoint (CNXlbep)	Specifies the endpoint of the backup locator (if this process is not the backup locator).  <i>Argument Type:</i> string <i>Default Value:</i> none
CNXlocator_retry_delay (CNXlrd)	Specifies the amount of time, in ms, to wait before retries. The value must be >50.  <i>Argument Type:</i> integer <i>Default Value:</i> 2000
CNXlocator_audit_delay (CNXlad)	Specifies the amount of time, in ms, to wait between audits of the primary and backup locators. The value must be >50.  <i>Argument Type:</i> integer <i>Default Value:</i> 2000
CNXlocator_audits_oos (CNXlao)	Specifies the number of failed audits required to take the primary locator out of service. Using the default of 3, the primary locator would be taken out of service after the third consecutive audit had failed.  <i>Argument Type:</i> integer <i>Default Value:</i> 3
CNXlocator_preferred_transport (CNXlpt)	Specifies that the first protocol to be chosen. This option can only be set at the primary or backup locators.  <i>Argument Type:</i> string <i>Default Value:</i> none

A locator is configured as the primary by starting the application with the `-CNXlp` command line option. When the locator starts up it publishes a port with the DCS. The backup locator will later connect to this port for the purpose of monitoring the primary locator. If the primary locator fails, future locator requests will be routed directly to the backup locator. If a backup is present, the `CNXlbep` option must also be specified when the primary is started so that collocated clients can use the locator if the backup takes over.

A locator is configured as the backup by informing the Connexis library that the application is acting as the backup locator and by specifying the explicit endpoint of the primary locator. This is done using the `-CNXlb` command line option (to specify that this application is the backup locator) and the `-CNXlpep` command line option (to inform Connexis of the address of the primary locator).

The backup locator subscribes to the port that is published by the primary locator. The backup uses this port to periodically poll the primary locator. If the primary fails to respond to the polling messages, the backup bids to takeover as the primary.

Client Connexis applications in this fault-tolerant configuration must be configured with the endpoints of both the primary and the backup. Each Connexis client explicitly subscribes to a port on both the primary and the backup locators. Registrations are only sent to the locator which has identified itself as the primary.

Figure 15 outlines the common Locator configurations and the parameter combinations that are required to support them.

**Table 15 Common Locator configurations and required parameters**

<b>Configuration</b>	<b>Required Options</b>	<b>Description</b>
When starting a client that is collocated with the primary locator and no backup is being used.	CNXlp	The CNXlp option is required to establish the process as the primary locator.
When starting a client that is collocated with the primary locator and a backup is being used.	CNXlp, CNXlbep	The CNXlp option is required to establish the process as the primary locator. The CNXlbep options is required so that the primary locator and the client know about the backup.
When starting a client that is collocated with the backup.	CNXlb, CNXlpep	The CNXlb option is required to establish the process as the backup locator. The CNXlpep option is required to inform the backup and the client of the primary locator.
When starting a client that is using a primary locator with no backup.	CNXlpep	The CNXlpep option is required to inform the client of the location of the primary locator.
When starting a client that is using a primary locator with a backup.	CNXlpep, CNXlbep	The CNXlpep and CNXlbep options are required to inform the client of the location of the primary and the backup locators respectively.

## Locator Parameter Examples

This section presents several examples of starting different components that are part of a distributed application that is using the Connexis Locator service.

### Example 1: Two node application with no backup locator

To start the application that acts as the primary locator:

```
<app_name> -CNXep=cdm://host1:9999 -CNXlp
```

The other application is started using the following command line syntax:

```
<app_name> -CNXep=cdm://host2:9991 -CNXlpep=cdm://host1:9999
```

### Example 2: Three node application with primary and backup locator

To start the application that acts as the primary locator:

```
<app_name> -CNXep=cdm://host2:9999 -CNXlp -  
CNXlbep=cdm://host3:9999
```

To start the application that will be acting as the backup locator:

```
<app_name> -CNXep=cdm://host3:9999 -CNXlb -  
CNXlpep=cdm://host2:9999
```

To start the other application:

```
<app_name> -CNXep=cdm://host2:9991 -CNXlpep=cdm://host2:9999 -  
CNXlbep=cdm://host3:9999
```

### Creating your Own Name Service

---

The Locator service that is provided with Connexis is designed in a very general fashion. It should satisfy most of the requirements for this type of service, but there may be cases where a different level of functionality is required by a specific application. In these cases, it may be desirable to design and use your own name service instead of using the Connexis Locator.

If you do this, there are several key differences between the Connexis Locator and a simple name service that you should be aware of. The Connexis Locator does more than simply translate a supplied service name into a physical endpoint. The Connexis Locator also provides the following features:

- allows for arbitration between several identically named publishers
- performs prioritized endpoint lookup on these publishers based on rank and protocol priority
- allows pending subscriptions which are automatically connected to publishers that are registered at a later time
- provides automatic re-subscription when publishers fail
- provides a fault-tolerant (no single point of failure) name service
- provides load-sharing of multiple publishers

A simple name service will typically only do a one-to-one mapping between an endpoint service name and the endpoint physical address.

If your application does not require the additional features provided by the Connexis Locator, you may want to create a custom name service. An example, where this may be desirable, is if all of the nodes in your distributed application can be determined by some kind of algorithmic mapping of a service name (for example, “tributaryPort03”) to an explicit endpoint. Another example, where this may be desirable, is in a static network environment where all of the endpoint mappings could be read from a configuration file at system start-up time.

In either of these cases, a Connexis connection could be used by all of the nodes in the distributed application to connect to a known “nameservice” port. This “nameservice” port returns an explicit endpoint given a service name that was passed in to it.



## Chapter 7

# *Using the Connexis Viewer*

---

Debugging the data flow between embedded component instances in a distributed network can be a very difficult task. For distributed systems that have been designed and generated using Rational Rose RealTime and Rational Connexis, the Connexis Viewer can be used to provide real-time insight and feedback to aid in the debugging process.

The Connexis Viewer consists of a workstation component that is provided for user interaction. The workstation component is launched from within a Rose RealTime session and consists of a target agent which monitors the DCS port registration process and collects trace events.

The Connexis Viewer provides the following information about an executing model:

- the status of unwired end ports that are registered with the DCS
- an indication of which DCS unwired end ports are bound to each other
- traces of user data sent from or received at a DCS registered port
- traces of DCS Locator and DCS Transport events -
  - transport connection establishment and failure
  - DCS locator switchover
  - synchronization of naming tables between the active and the standby DCS locators

The circuit tracing functionality provided with the Connexis Viewer offers features that are similar to the Rose RealTime's Target Observability with the following exceptions:

- Traces can be enabled and controlled independently of the Rose RealTime toolset.
- The output of trace information is handled on a separate (low priority) thread and is minimally intrusive to the running application.

**Note:** *The Connexis Viewer can be used at the same time as Rose RealTime's Target Observability feature. In fact, the easiest way to start viewing a distributed model is to launch the different applications directly from Rose RealTime.*

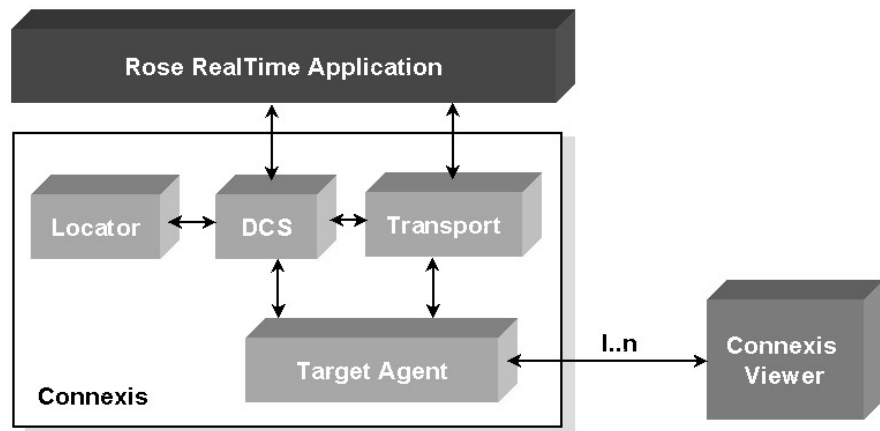
The metrics collecting functionality provided with the Connexis Viewer lets you control and view the metrics collection results of a component instance. It provides the following features:

- Controls start and stop function for metrics collection
- Displays metrics data for any registered transports
- Displays aggregate data for all registered transports
- Displays controller metrics
- Saves data in a format that allows for further analysis



## Viewer Architecture

The Viewer communicates with the executing model through the Target Agent as shown in Figure 67. The Target Agent component must be contained in every Rose RealTime executable to which the Viewer connects. The Target Agent operates on a low priority thread and relays information about the executing model back to the Viewer where it can be seen.



**Figure 67 High-level architecture**

## Adding Viewer Support to a Model

To add Viewer support to your application, you must add a capsule role from the RTDBase\_Agent or the RTDBase\_Locator\_Agent capsule, to a capsule in your application. Each node requiring Viewer support, must have one of these capsule roles contained in it.

The RTDBase\_Agent capsule only adds support for the Target Agent, which is needed to run the Connexis Viewer. The RTDBase\_Locator\_Agent adds support for both the Target Agent and the Locator.

For more information on Connexis-enabling a Rose RealTime application refer to “Adding Connexis Support to Your Model” on page 83.

Before starting the Viewer, there are two command line options that you should specify for your Rose RealTime component instances:

- **CNXep** - Used to specify the Connexis endpoint. The Viewer must know the Connexis endpoint of the executing model to be able to connect to the running application. This is a required parameter.
- **CNXui** - Used to specify a unique identifier for the endpoint. If this option is not specified, Connexis assigns a default identifier for the endpoint. The default is a hex code and does not easily identify the endpoint in the Viewer. For this reason, it is recommended that you define your own unique, descriptive identifier.

If the CNXep option is not specified on the component instance (in Rose RealTime), you can specify it using the Viewer. The CNXui option can only be modified in the Viewer on user-defined component instances. This means that if the component instance was read in from Rose RealTime, you cannot modify it in the Viewer.

### Adding Metrics Support to a Model

---

Like tracing, metrics gathering is done on the target itself and is reported to the Viewer. This capability is enabled by default in the DCS libraries that ship with Connexis, but it can be enabled or disabled when the DCS library is recompiled by the user. Like tracing, the model must contain either the RTDBase\_Agent or the RTDBase\_Locator\_Agent capsule. When the Viewer connects to the Target Agent in the component instance, it asks if metrics gathering is enabled on the target. If it is not, a warning message is displayed in the log of the viewer and no metrics reporting can be done.

## Starting the Connexis Viewer

---

You can start the Connexis Viewer from the Rose RealTime main menu, from a deployment diagram or from a deployment package.

To start the Connexis Viewer from the main menu:

1. Open the Connexis-enabled Rose RealTime model that you want to view.
2. Select **Tools > Connexis Viewer**.

If you have a deployment diagram active when you start the Viewer, it uses the processor and component instances from that diagram. If no deployment diagram is active, it uses the processors and component instances in the model.

To start the Connexis Viewer from a deployment diagram or a deployment diagram icon:

1. Right-click the deployment diagram or the deployment diagram icon. A popup menu appears.
2. Select **Connexis Viewer** from the popup menu. The Connexis Viewer appears.

The Connexis Viewer uses the processor and component instances from the deployment diagram icon that you have selected.

To start the Connexis Viewer from a deployment package:

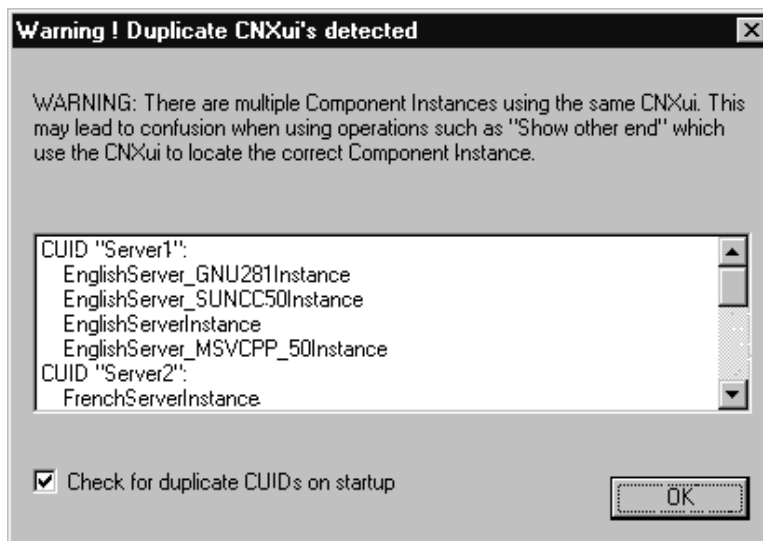
1. Right-click the deployment package. A popup menu appears.
2. Select **Connexis Viewer** for the popup menu. The Connexis Viewer appears.

The Connexis Viewer uses the processor and component instances from the deployment package.

## Duplicate CNX Unique Identifiers

---

The Duplicate CNXui dialog box indicates that there are multiple component instances that use the same CNXui. This may cause confusing information to be displayed when using Connexis Viewer features that rely on the CNXui. When this occurs, operations that involve displaying information about the remote end of a connection may not function correctly. The recommendation is that CNX unique identifiers be unique amongst all component instances in the Connexis Viewer session.



**Figure 68 Duplicate CNXuis dialog box**

## Viewer Main Window

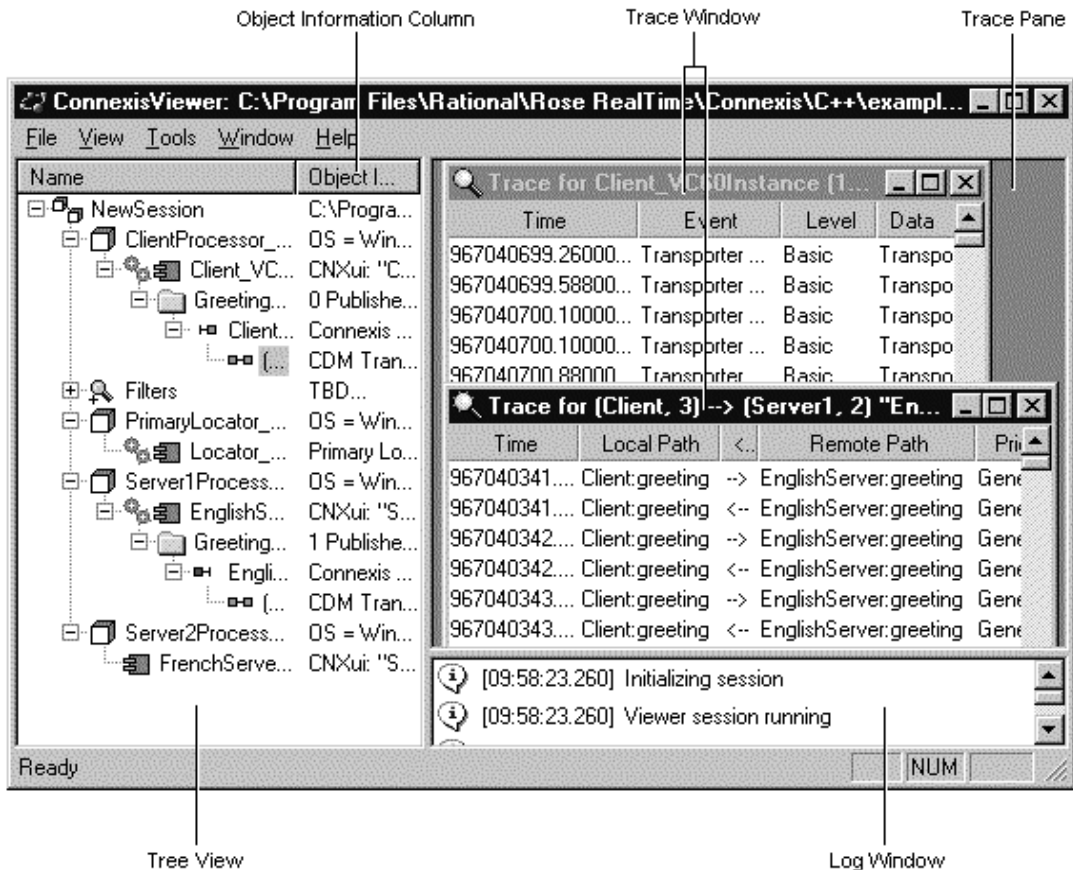
---

The Viewer main window contains the following:

- Main menu - is used to access application-specific operations
- Tree view - is the main interface to the user and is used to display and configure information about the executing application as well as to open trace windows
- Trace pane - is used to manage all of the trace windows that are currently open

- Log window - is used to log connection information
- Status bar - is used to display information about the state of the application

Figure 69 shows the Viewer main window with the HelloWorld model being viewed.

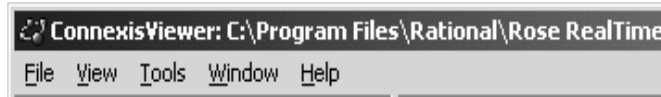


**Figure 69** The Viewer main window

### Viewer Menus

---

The main menu, as shown in Figure 70, consists of a File, View, Tools, Window and Help menu.



**Figure 70** Connexis Viewer Main menu

### File Menu

#### Import

Selecting **File > Import** displays a standard open dialog box that allows you to import a previously-saved Viewer configuration file.

Use the Import command when you want to view a model in addition to the one against which you launched the Connexis Viewer. The result of importing the other model's information is the same as manually adding each of the model's Processor and component instance definitions.

**Note:** Before you import, you must generate the *.CVMInfo* file for the model to be imported. This file is generated automatically when you use the Connexis Viewer with a model.

#### Exit

Selecting **File > Exit** exits the application.

### View Menu

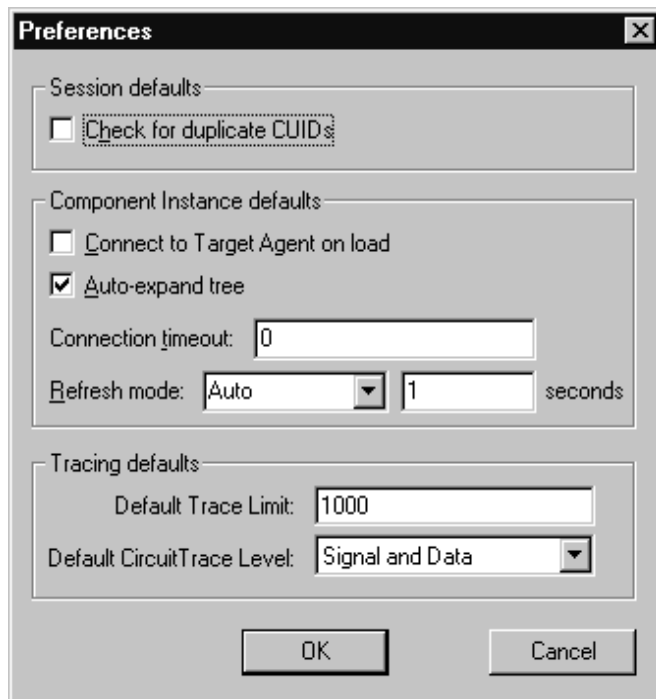
#### Status bar

The **View** menu allows you to toggle the visibility of the **Status Bar**. A check mark appears beside the menu item when it is visible.

## Tools Menu

### Options

Selecting **Tools > Options** displays a “Preferences” dialog (see Figure 71) that lets you select Session defaults, Component Instance defaults and Tracing defaults for the Connexis Viewer (see Table 16, “Preference dialog settings,” on page 160).



**Figure 71** Preferences dialog

**Table 16 Preference dialog settings**

<b>Option</b>	<b>Description</b>
Check for duplicate CUIDs	Checking this field lets Connexis identify, on startup, any duplicate CUIDs in a model. This occurs if you have the same logical CUID value (specified using the 'CNXui' parameter) for components that are being deployed on different configurations.
Connect to target agents on load	Checking this box lets all new Component Instances connect to target agents.
Auto-expand Tree	Checking this box lets all new Component Instances function with the Auto-expand tree feature.
Connection Timeout	Typing the number of seconds in this field sets the timeout period for all new Component Instances.
Refresh Mode	Refresh Mode lets you select the way component instances are refreshed (Auto, Manual or Timed). For the Viewer to refresh component instances automatically, select "Auto" from the list. Select "Manual" if you want to refresh the component instance manually or select "Timed" and set your desired refresh period in seconds.
Trace Limit	Setting the value of this field determines the initial size of the tracing buffer. This specifies the number of trace events stored for all trace windows, including Component Instances, Ports and Circuit traces.
Circuit Trace Level	Selecting the level from this list determines the initial setting (Disabled, Activity, Signal or Signal and Data) for Port and Circuit tracing. When you open a trace window onto a Publisher, Subscriber or Circuit without performing a 'Define...', the default trace level is the one defined in this field.



## Windows Menu

### **Tile**

Selecting **Window > Tile** causes all non-iconified Trace windows to be arranged in a format in which the trace windows do not overlap.

### **Cascade**

Selecting **Window > Cascade** causes all non-iconified Trace windows to be arranged in a 'stack' which allows the captions of each window to be visible.

### **Trace Windows List**

Selecting one of the entries in the Trace Windows List (the numbered entries) causes that window to become the active Trace Window. The window is brought to the top, and if it had been previously iconified, it is restored to its normal state.

## Help Menu

### **Contents**

Selecting **Help > Contents...** launches the main help for Connexis and the Viewer.

### **About Connexis Viewer**

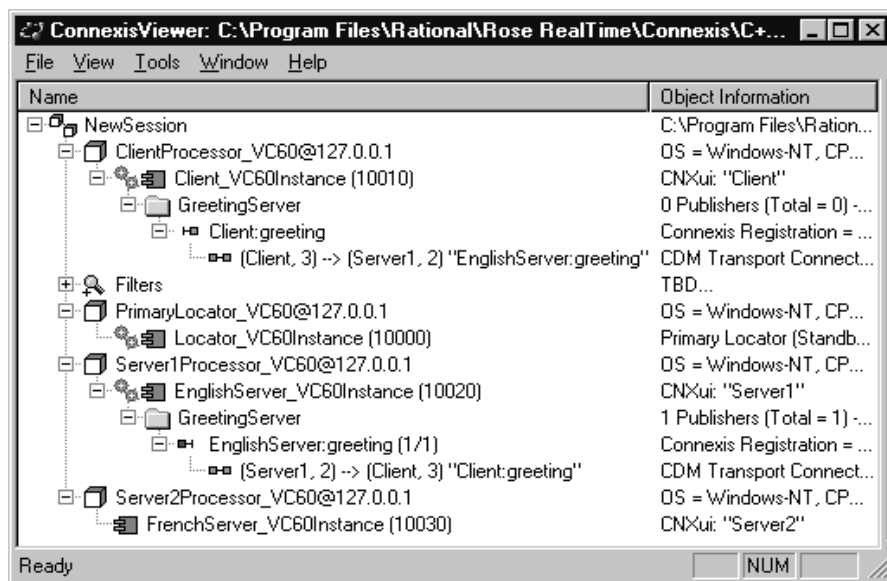
Selecting **Help > About Connexis Viewer**, displays the Viewer's about dialog. The about dialog contains information about the version of the Connexis Viewer that is being used and also contains information about how to contact Connexis support.

## Explorer Tree View

The primary way of configuring a Viewer session is through the tree view. Most of the objects on the tree view have popup menus that allow you to configure the object and to control the information that is displayed for the object when the application is executing.

Figure 72 shows the tree view while the HelloWorld model is executing. Every item in the tree view belongs to the session. The session contains zero or more processors. Processors contain zero or more component instances. Component instances contain zero or more named services. Named services contain zero or more registered end ports and registered end ports contain zero or more virtual circuit endpoints.

The processor and component instance information can be derived directly from a Rose RealTime model. The Viewer captures the information that is contained in the deployment view of the model that was open when the Viewer was launched. Additionally, you can add processors and component instances manually inside the Viewer. This is useful if you also want to monitor Connexis-enabled Rose RealTime executables that are not contained in the model from which the Viewer was launched.





**Figure 72** The Explorer tree view

## Processor Icons

Processors that have been added automatically by launching the Viewer are illustrated using the same processor icon as is used in Rose RealTime (see the ClientProcessor\_VC60@127.0.0.1 processor in Figure 72 and Table 17). Processors that are added manually in the Viewer are illustrated using the processor icon with a downward pointing arrow inside (see the Workstation1@127.0.0.1 processor in Figure 72 and Table 17). Processors that are added manually will be reloaded the next time the Viewer is opened from the same model.



**Table 17 Processor icons**

Icons	Meaning
	automatically-added processor
	manually-added processor

## Component Instance Icons

Component instances, that have been added automatically by launching the Viewer, are illustrated using the same component instance icon as is used in Rose RealTime (refer to the Client\_VC60Instance (10010) component instance in Figure 72). Component instances that are added manually are illustrated using the component instance icon with a downward pointing arrow inside (refer to the TestComponentInstance (9999) component instance in Figure 72). Component instances that are added manually will be reloaded the next time the Viewer is opened from the same model.

**Table 18 Component instance icons**

Icons	Meaning
	automatically-added component instances
	manually-added component instances

### Filter Icons

A Filter icon lets you add, select or remove a trace filter specification from the Explorer tree view. Clicking the plus symbol to the left of the Filter icon expands the tree and reveals the trace filter specifications that are available for use. If there are no trace filter specifications available, right-clicking the Filter icon lets you add a new trace filter specification. (see “Defining a Trace Filter for a Component Instance” on page 182).



**Figure 73** Filter Icon

### Component Instance Status

Component instance status is indicated in the tree view by varying the gear icon shown in Figure 74.



**Figure 74** Gear icon

When a target agent connection is established, the tree refresh mode (that is, manual, automatic, or timed) is reflected through the gear spin. Feedback is summarized in Table 19.

**Table 19** Gear spin and status

Icon behavior	Meaning
green, continuous spinning	Automatic refresh mode
green, intermittent spinning	Timed refresh mode
green, with no spin	Manual refresh mode

When the Viewer has lost contact with the target (red), is manually disconnected (gray), or is connecting (yellow), there is no feedback for the refresh mode (since there is no active refresh in these states).

**Table 20 Gear color and status**

<b>Icon appearance</b>	<b>Meaning</b>
No Gears	The Target Agent has not been connected to this component instance in this Viewer session.
Yellow Gears	The user has requested a connection to the Target Agent but the connection has not yet been established.
Green Gears	The Target Agent is connected to the component instance. If the component instance is in Auto Refresh mode, the gears will be spinning. (See Table 19)
Red Gears	The Viewer has determined that it has lost the connection with the Target Agent. This is most likely an indication that the component instance has stopped running or is hung. The Viewer maintains the last known state in the tree until the component instance is Reset.
Gray Gears	There is currently no connection established between the component instance and the Target Agent.

## Named Services Icons



Named services appear in the tree view as folders (see Figure 75) that are contained in component instances. Named services are identified using the name that they were registered as with the DCS. Inside each named service are zero or more registered end ports. The registered end ports are referred to by the names that they were given in the Rose RealTime model (this may or may not be the same as the name that they were registered as), followed by the Rose RealTime model path to the end port, the number of the end port instance, and the total number of instances.

**Figure 75 Named service icon**

## Port Icons

Publisher ports appear in the tree view with a red port icon beside them (refer to the EnglishServer:greeting(1/1) port in Figure 72 and Table 21). Subscriber ports appear with a yellow port icon if the port is not bound, or a green port icon if the port is bound.

**Table 21** *Port icons*

<b>Icons</b>	<b>Meaning</b>
	Publisher port icon
	Subscriber port icon

### Virtual Circuit Icons

The last items that appear on the left hand side of the tree view are the virtual circuits. Virtual circuits are contained inside of end port objects in the tree view and appear with a green protocol icon beside them (refer to (Client, 2) --> (Server1, 2) “EnglishServer:greeting” in Figure 72 and Figure 76).



**Figure 76** *Virtual circuit icon*

Virtual circuits represent the Connexis connections that are currently established in the running model as of the last time the Viewer was refreshed. The information that is displayed in the tree view about a virtual connection contains the following:

- the unique identifier for the local component instance followed by the virtual circuit ID for that side of the connection
- the unique identifier for the remote component instance followed by the virtual circuit ID for that side of the connection
- the name and Rose RealTime model path of the end port on the other side of the connection enclosed in quotation marks

The virtual circuit illustrates why it is important to specify the CNXui command line option on your component instances. If usable identifiers had not been used in this model, the Client and Server1 identifiers would have appeared as numbers that were generated by Connexis.

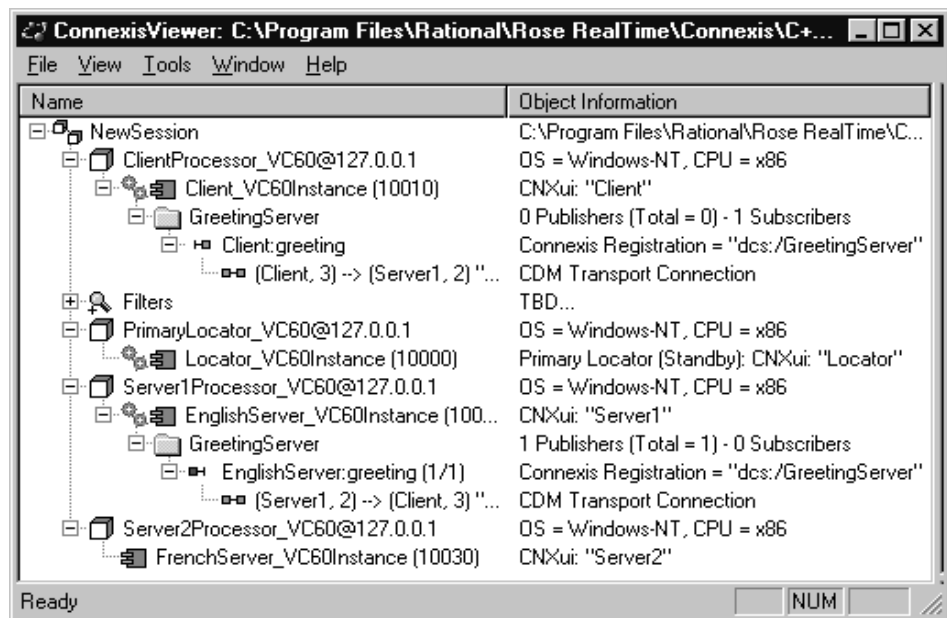
This would have caused the information for the virtual circuit contained in the EnglishServer:greeting (1/1) end port in Figure 72 to be something similar to the following:

```
(76f95d83,2) --> (76f98e45,2) "Client:greeting"
```

This information is much more difficult to keep track of when you are viewing an executing model.

## Object Information Column

The Object Information column is on the right-hand side of the tree view and is shown in Figure 77. It is used to display additional information about each of the objects in the tree view.



**Figure 77 The Object Information column**

Table 22 explains what information is displayed in the Object Information column for each object type.

**Table 22** *Object Information description*

<b>Object type</b>	<b>Information displayed</b>
Processor	Operating system and hardware architecture.
Component Instance	Connexis Unique Identifier. This displays the string that was specified using the CNXui command line option. If the user did not specify an identifier, the Connexis-generated identifier is not displayed until you connect to that component instance. This field also displays the locator configuration and status.
Named service	Number of publishers and subscribers that are currently registered, and in the case of publishers, the sum of the replication factors of the named service for the component instance.
Registered end port	The Connexis Registration string that was used to register the port.
Virtual circuit	This field indicates which transport protocol is used to establish the connection. This field also indicates the type of connection that has been established by Connexis.

## Popup Menus

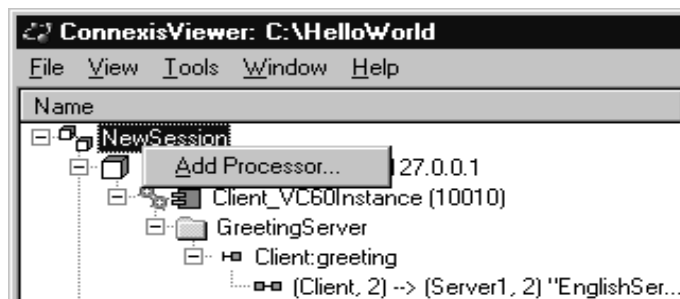
---

Most operations in the Connexis Viewer are performed by selecting an element and using the popup menu. Clicking the right mouse button on an element in the Explorer Tree View enables you to perform operations such as adding a processor or component instance, defining trace parameters, opening a trace window, and so on.

### Session Popup Menu

The session object in the tree view has a popup menu associated with it. This menu is shown in Figure 78. The only option available from this menu is to add a new processor to the session.





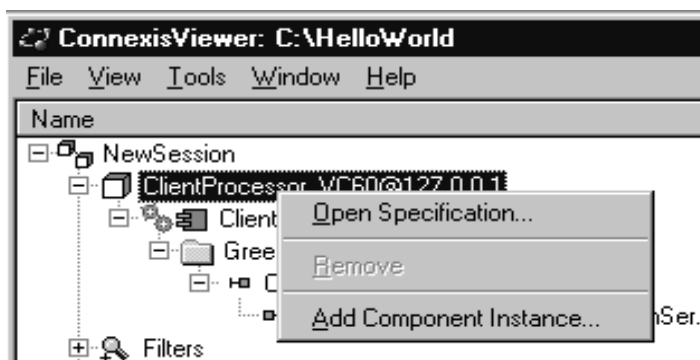
**Figure 78** The session popup menu

### Add Processor

The **Add Processor** command allows you to add a processor to the tree view. See also “Adding a Processor” on page 175.

## Processor Popup Menu

All processors in the tree view have a popup menu associated with them as shown in Figure 79.



**Figure 79** The processor popup menu

### Open Specification

The **Open Specification** command allows you to modify a processor’s properties. See also “Changing the Properties of a Processor” on page 176.

### Remove

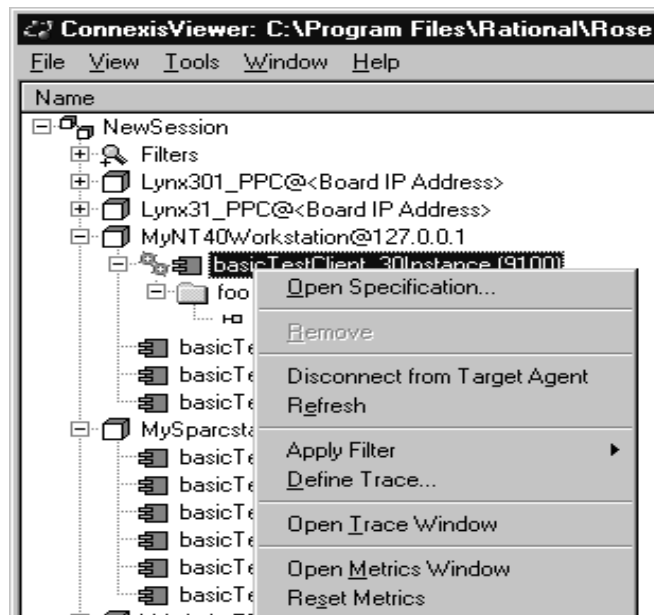
The **Remove** command allows you to remove a processor that you have manually added to the model. This command appears grayed out if the processor was read in from a Rose RealTime model.

### Add Component Instance

The **Add Component Instance** command allows you to add a new component instance to the tree view. See also “Adding a Component Instance” on page 177.

## Component Instance Popup Menu

The component instance popup menu is context-sensitive and is shown in Figure 80. Slightly different options will appear in this menu depending on the state of the component instance. Figure 80 shows what is displayed if the menu is opened from a component instance that was read in from a Rose RealTime model and where the Target Agent has been started on the component during the active session.



**Figure 80** The component instance popup menu

### Open Specification

The **Open Specification** command allows you to modify a component instance's properties. See also "Changing the Properties of a Component Instance" on page 180.

### Remove

The **Remove** command allows you to remove a component instance that you have manually added to the model. This command appears grayed out if the processor was read in from a Rose RealTime model.

### Connect to Target Agent on load

The **Connect to Target Agent on load** command changes context depending on the current Target State as summarized in Table 23.

**Table 23** *Connect to Target Agent*

Target State	Command text	Action
Not Connected (Gray gears)	Connect to Target Agent	Attempts to connect to this component instance's Target Agent
Waiting for Connection (Yellow gears)	Cancel Target Agent Connection	Cancels the attempt to connect
Connected (Green gears)	Disconnect from Target Agent	Disconnects from the Target Agent
Disconnected (Red gears)	Reset Target Agent Connection	Clears the tree information and returns to the "Not Connected" Target state

### Refresh

The **Refresh** command allows you to manually refresh the information that is being displayed about the component instance and all of the objects under it in the tree view. This option is available even if the Timed or Auto refresh methods are selected for the component instance. See also "Changing the Properties of a Component Instance" on page 180.

### **Apply Filter**

The **Apply Filter** command lets you select a previously-defined trace filter for a component instance. A popup menu appears, listing all available filters.

### **Define Trace**

The **Define Trace** command allows you to define trace settings for a component instance. See also “Defining a Trace Filter for a Component Instance” on page 182.

### **Open Trace Window**

The **Open Trace Window** command lets you open a trace window from a component instance. Once the trace window appears, you can right-click on the window to define or apply a trace filter to the component instance (see “Trace Window Popup Menu” on page 196).

### **Open Metrics Window**

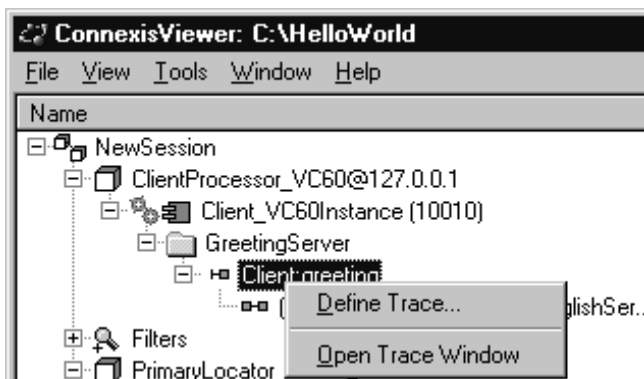
The **Open Metrics Window** command opens a metrics window on the component instance. The Viewer does not have to be connected to the component instance, but the component instance must be running for the metrics connection to work.

### **Reset Metrics**

The **Reset Metrics** command restarts the target metrics counter and resets the collection and reporting of metrics from the selected component instance. The component instance must be running for this menu item to be available.

## Port Reference Popup Menu

The Port reference popup menu is shown in Figure 81.



**Figure 81** *The Port Reference popup menu*

### Define Trace

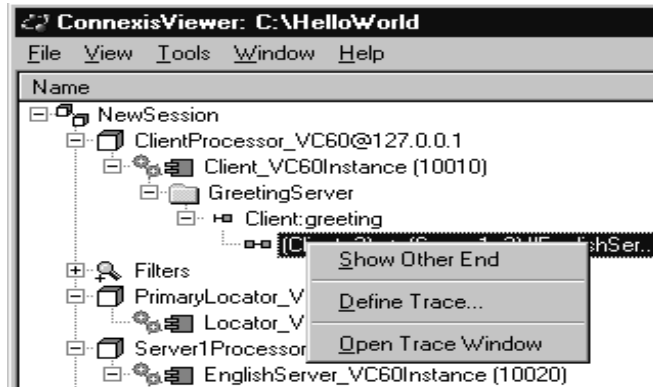
The **Define Trace** command allows you to define trace settings for a port reference. See also “Defining a Port Reference Trace” on page 188.

### Open Trace Window

The **Open Trace Window** command opens a trace window on the port reference. This trace window uses the filters that were defined in the **Define Trace** dialog.

## Virtual Circuit Popup Menu

The Virtual circuit popup menu is shown in Figure 82.



**Figure 82** The virtual circuit popup menu

### Show other end

The **Show other end** command allows you to highlight the virtual circuit endpoint that is at the other end of the connection.

### Define Trace

The **Define Trace** command allows you to define trace levels for a virtual circuit. See also “Defining a Virtual Circuit Trace” on page 192.

### Open Trace Window

The **Open Trace Window** menu item opens a trace window on the virtual circuit. This trace window will use the filters that were defined in the **Define Trace** dialog.

---

## Creating Processors and Component Instances

---

The Connexis Viewer lets you create processors and component instances that are not part of the current model. This is useful when you wish to perform traces on distributed systems that are composed of several models. Using the Import command to import all information from another model may be undesirable depending on the size and complexity of the model. The ability to add processors and component instances from another model allows you to:

- see information for a single component instance in a complex model without burdening your session with unnecessary information
- perform a trace when the model for the other component instances is not available (for example, the model was developed off-site)

New processor and component instances are stored in.CVEInfo file. Once defined, they will always appear when you open the model.

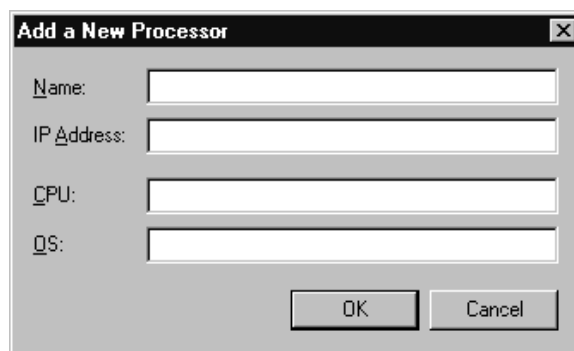
### Adding a Processor

You can add a processor that is not part of the current model to the tree view.

To add a processor:

1. Select New Session in the tree view.
2. Right-click and select **Add Processor** from the popup menu.

The dialog shown in Figure 83 appears.



**Figure 83** Add Processor dialog

3. Enter a processor name.

**Note:** Letters, numbers, and underscores are permitted in the name. Spaces are prohibited.

4. Enter the IP address of the processor.
5. Enter the CPU type.
6. Enter the operating system.
7. Click the **OK** button.

If you need to modify a processor's properties after you have created it, see "Changing the Properties of a Processor" on page 176.

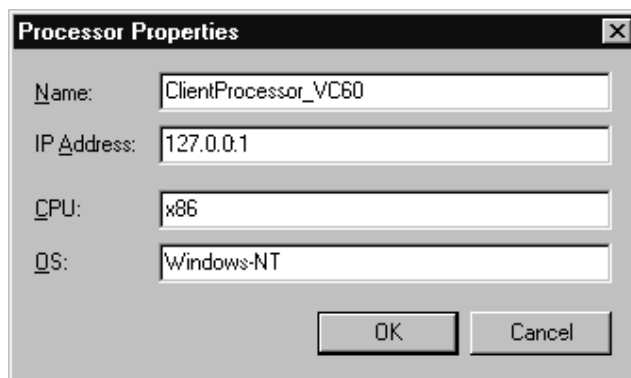
### Changing the Properties of a Processor

The Connexis Viewer allows you to edit a processor's properties after you have created it.

To change a processor's properties:

1. Select the processor.
2. Right-click and select **Open Specification** from the popup menu.

The dialog box shown in Figure 84 appears.



**Figure 84** Processor Specification dialog

3. Edit the fields as desired.
4. Click the **OK** button.



### Removing a Processor

You can remove a processor that you manually added to the model from the Connexis Viewer. Processors that have been read in from a Rose RealTime model cannot be removed, and as a result, appear grayed out on the menu.

To remove a processor:

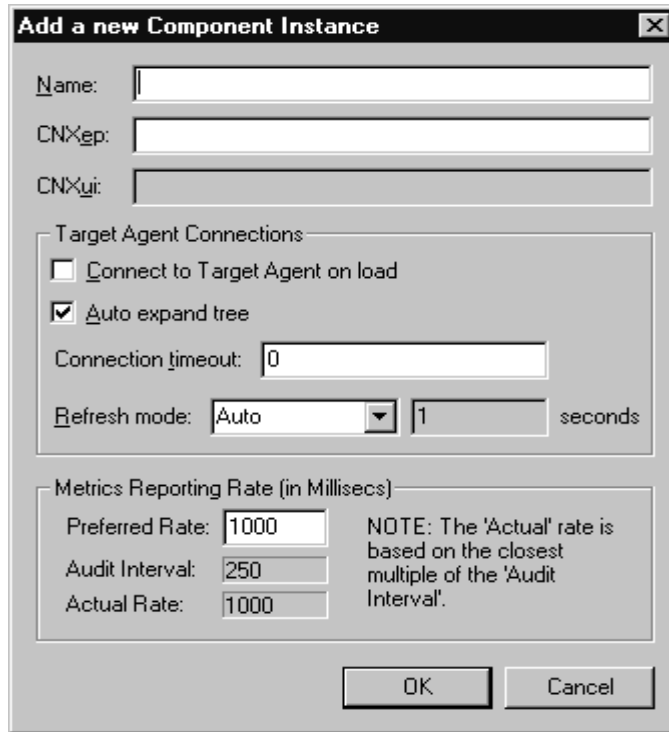
1. Select the processor.
2. Right-click and select **Remove** from the popup menu.

### Adding a Component Instance

You can add a component instance that is not part of the current model to the tree view.

To add a component instance:

1. Select the processor to which you want to add a new component instance.
2. Right-click and select **Add Component Instance** from the popup menu. The dialog box shown in Figure 85 appears.



**Figure 85 Add Component Instance dialog**

3. Enter a name for the component instance.  
**Note:** Letters, numbers, and underscores are permitted in the name. Spaces are prohibited.
4. Enter the CNX endpoint (**CNXep**). This must be a valid Connexis endpoint. Specifying just a port number translates into the endpoint `cdm://<IPAddr>:portnumber` where `<IPAddr>` is obtained from the processor containing this component instance.
5. Enter the **CNXui** field if you created the component instance manually.  
**Note:** You cannot edit this field if the component instance was read in from a Rose RealTime model.
6. Click to enable **Connect to Target Agent on load**.  
When this option is enabled, the Viewer:

- ❑ attempts to connect to the component instance's target agent on startup
- ❑ automatically attempts to reconnect to a Target Agent when it becomes 'Disconnected' (that is, unexpectedly loses its connection). This is useful in situations such as when the target is reset, rerun, or the communication link between the target and the Viewer is broken and re-established. All component instance trace filters established before the reset are maintained.

If this option is not selected, the Target Agent must be started manually.

7. Click to enable **Auto expand tree**.

When this option is enabled, the tree view is automatically expanded to show new objects underneath the component instance such as named services, publishers and subscribers, and connections.

8. Enter a **Connection timeout** value in seconds.

This is the amount of time that the Viewer will wait for a reply from the target agent before it assumes the connection has been terminated. This value is used in two situations:

- ❑ When the Viewer attempts to attach to a target agent, the value in the connection timeout field is used to decide how long the Viewer waits for the target agent to handshake with the Viewer. If the handshake is not received within the specified interval, the target agent must be reset and another connection attempt must be initiated. A value of 0 indicates that the Viewer should wait forever.
- ❑ After the connection has been established (during normal communication), the value in the connection timeout field is used to determine how long the Viewer should wait for a response from the target agent. Once a request for information is sent by the Viewer to the target agent, the target agent is expected to reply within the time specified in the connection timeout field. The target agent is given three attempts to respond within this interval. If it does not, the Viewer sends it a status query. If no response is received for the status query within the connection timeout period, the connection is assumed to have timed out and the target agent must be reset and reconnected. If the connection timeout is set to 0, the default connection timeout period of 30 seconds is used.

9. Choose a **Refresh mode** from the drop-down list:
  - ❑ Manual - All refreshes of the data that is displayed in the tree view must be done by selecting **Refresh** from the component instance's popup menu.
  - ❑ Auto - Refreshes the model in real-time. This causes the Viewer to refresh the display whenever a modification causes the information that is displayed in the Viewer to change. This operation may not be desirable for "highly active" models since a constantly-changing model will cause the tree display to fluctuate as it attempts to keep up-to-date.
  - ❑ Timed - If this option is selected, the refresh will occur every  $n$  seconds where  $n$  is the value entered in the seconds field.
10. Enter the rate (milliseconds) at which you want metrics data to be reported to the Viewer, in the Preferred Rate text box.

If the rate you request is more frequent than the rate at which the component instance audits its circuits, the rate you request will not be supported by the component instance. In such a case, metrics uses the auditing rate of the component instance.

For example, if the component instance "Client" uses the default audit period of 250 ms, and you set the Preferred Rate to 100 ms, metrics will be reported at an audit period of 250 ms.

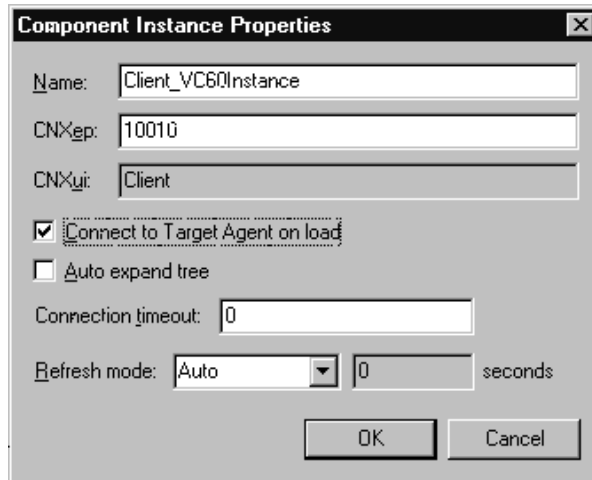
### Changing the Properties of a Component Instance

The Connexis Viewer lets you edit a component instance's properties after you have created it.

To change a component instance's properties:

1. Select the component instance you wish to modify.
2. Right-click and select **Open Specification**.

The dialog box shown in Figure 86 appears.



**Figure 86** Component Instance Properties dialog

3. Edit the fields as desired.

**Note:** You cannot edit the CNXep field if the component instance was read in from a Rose RealTime model. You can only edit this field if the component instance was created manually.

4. Click the OK button.

## Performing Event Tracing

---

The Connexis Viewer lets you perform event tracing on component instances, port references and virtual circuits.

The options available vary depending on the type of element selected for tracing and are described in detail in the following sections:

- Defining a Trace Filter for a Component Instance
- Defining a Port Reference Trace
- Defining a Virtual Circuit Trace

### Defining a Trace Filter for a Component Instance

Trace filters let you trace messages and event types from a distributed model. You can define a trace filter from a Component Instance icon or a Filter icon. Right-clicking either icon lets you access a dialog box that allows you to set the filter levels for different trace groups and trace types.

The component instance trace levels that are available for the trace groups and trace types are:

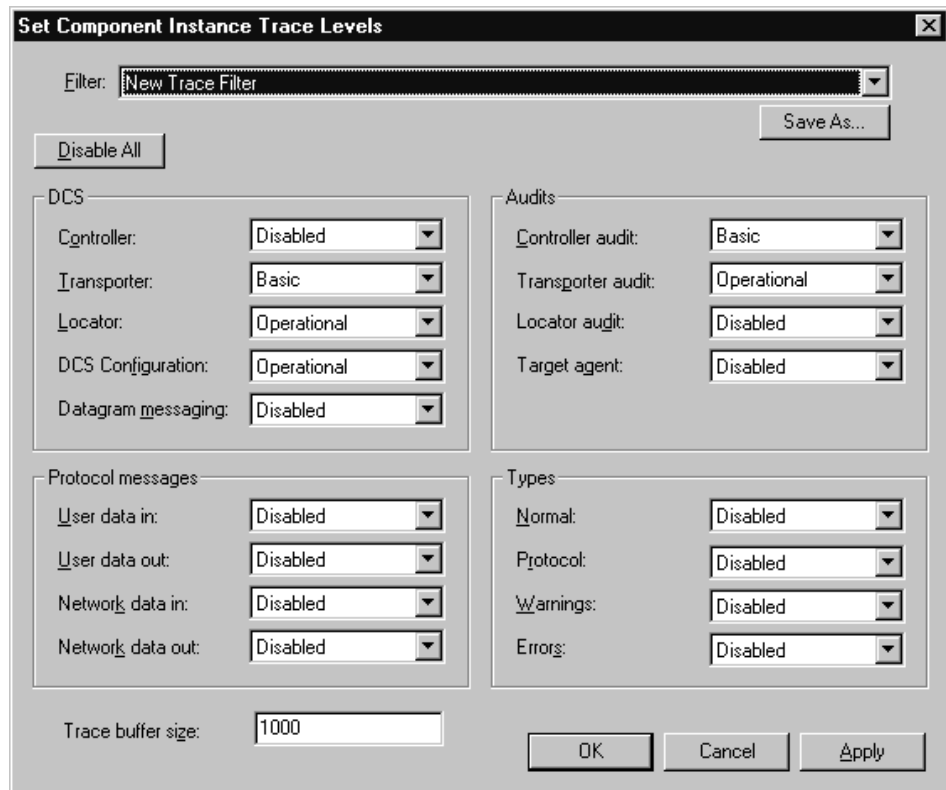
- Disabled - no tracing for the group/type
- Basic - events that are related to the static operation of a group or type. This includes start-up events, connect events and shutdown events
- Operational - events that are related to the dynamic behavior of a group. This is the trace level that is used to trace data transport
- Advanced - enables all tracing for a group. This is typically very detailed and includes all events from the other trace levels as well as audit information

**Note:** *When setting the trace levels for the different types and groups, keep in mind that the more tracing being performed, the more data is being sent to the Viewer. This can have a negative impact on the performance of the executing model.*

To define a trace filter from a Component Instance icon:

1. Right-click the Component Instance icon that you want to trace.
2. Select **Define Trace** from the popup menu.

The Set Component Instance Trace Levels dialog appears.



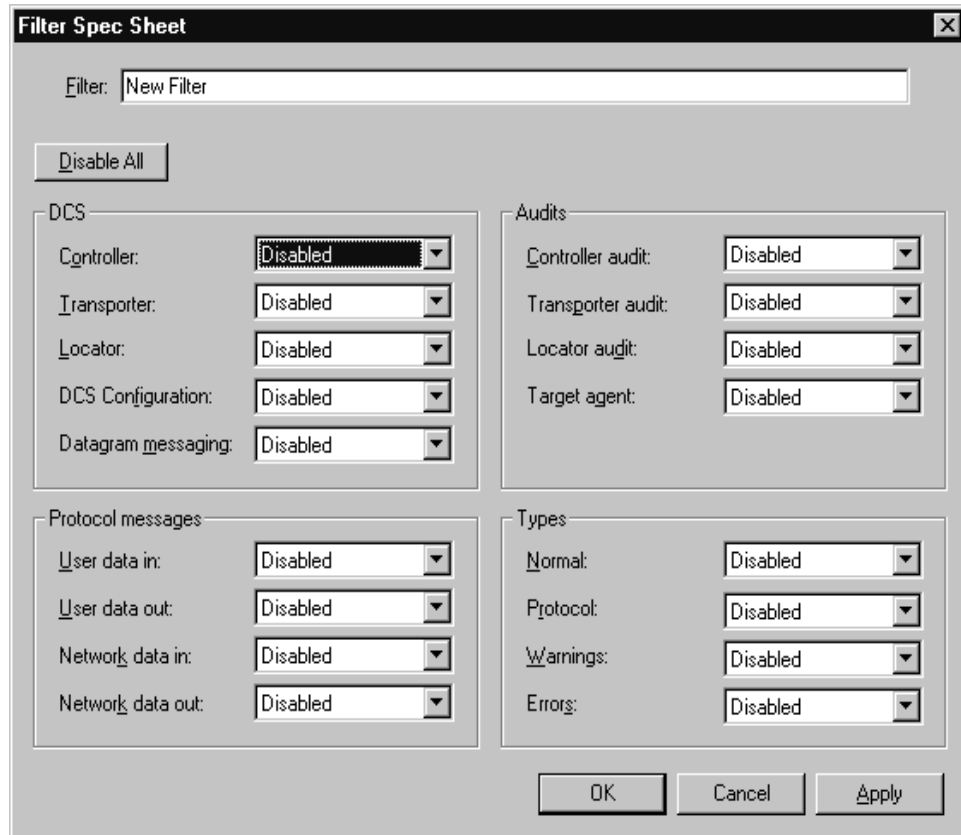
**Figure 87** Set Component Instance Traces Levels dialog

3. Define the trace filter according to your requirements (see Table 24, Table 25 and Table 26, for an explanation of the trace filter options).
4. Type the number of events that you want written to the trace buffer in the **Trace buffer size** text field.
5. Click **Apply** to trace the component instance.
6. Click **Save As** to save your trace options. This is only necessary if you want to reuse the same trace filter that you have created.

To define a trace filter from the Filter icon:

1. Right-click the Filter icon from the Explorer tree view.
2. Select **Add Filter**.

The Filter Spec Sheet dialog appears.



**Figure 88** Filter Spec Sheet dialog

3. Type a descriptive name to identify the filter in the Filter text box.
4. Define the trace filter according to your requirements (see Table 24, Table 25 and Table 26, for an explanation of the trace filter options).
5. Click **OK** to implement your changes and close the dialog.



### Setting trace filters

The “Set Component Instance Trace Levels” dialog and the “Filter Spec Sheet” dialog contain the trace groups and trace types that let you set your define your trace filter. Trace groups refer to a functional area where messages can be traced in the distributed model and trace types refer to event types that can be traced. The settings for the trace groups and trace types determine what messages are traced in the executing model.

When connecting to target agents in the minimal configuration, only error and warning type events for all trace groups are available. A description of how to configure the following trace groups is explained in Table 24, Table 25 and Table 26:

- DCS Trace Options
- Audit Trace Options
- Protocol Messages Trace Options

**Table 24 DCS Trace Options**

DCS Tracing Filters	Trace Options
Controller	<p>Basic</p> <ul style="list-style-type: none"> <li>■ Controller initialization status <i>Basic Errors:</i> Failure to initialize the DCS components (for example, transporter)</li> </ul> <p>Operational</p> <ul style="list-style-type: none"> <li>■ Subscriber and publisher registration</li> <li>■ Binding and unbinding of end ports</li> <li>■ Connection establishment progress</li> <li>■ Local binding indication</li> <li>■ Transport failure and recovery indications <i>Operational Warnings:</i> Registration failures due to configuration (for example, global registration with no locator configured) <i>Operational Errors:</i> Subscriber and publisher registration errors and failures</li> </ul> <p>Advanced</p> <ul style="list-style-type: none"> <li>■ End port proxy creation and removal</li> <li>■ Auditing of end port proxies</li> <li>■ Viewer/Target Agent service and connection information queries</li> </ul>
Transporter	<p>Basic</p> <ul style="list-style-type: none"> <li>■ Encoder/decoder mismatch between transport end points</li> <li>■ Data type lookup error <i>Basic Warnings:</i> <ul style="list-style-type: none"> <li>■ Local/remote virtual circuit mismatches</li> <li>■ Unknown control messages</li> </ul> </li> </ul> <p><i>Basic Errors:</i></p> <ul style="list-style-type: none"> <li>■ Encode/decode errors</li> <li>■ Unknown control messages</li> </ul>

**Table 24 DCS Trace Options**

---

**DCS Tracing Filters    Trace Options**

---

	Operational
	<ul style="list-style-type: none"> <li>■ Connection establishment and teardown</li> </ul>
	Advanced
	<ul style="list-style-type: none"> <li>■ An indication that a message was sent over the wire and the message size in bytes</li> </ul>
<hr/>	
Locator	Basic
	<ul style="list-style-type: none"> <li>■ Locator configuration (as primary or basic)</li> </ul>
	<i>Basic Errors:</i>
	<ul style="list-style-type: none"> <li>■ Encode/decode errors</li> </ul>
	Operational
	<ul style="list-style-type: none"> <li>■ Service publish and subscribe events</li> <li>■ Service registration and binding status</li> </ul>
	<i>Operational Errors:</i>
	<ul style="list-style-type: none"> <li>■ Encode/decode errors</li> </ul>
	Advanced
	<ul style="list-style-type: none"> <li>■ Primary and backup locator election process</li> </ul>
<hr/>	
DCS Configuration	Basic
	<ul style="list-style-type: none"> <li>■ Used to indicate that user configuration settings have been overridden</li> </ul>
	Operational
	<ul style="list-style-type: none"> <li>■ Displays the same information as basic</li> </ul>
	Advanced
	<ul style="list-style-type: none"> <li>■ Displays the same information as basic</li> </ul>
<hr/>	
Datagram Messaging	There are currently no trace events defined for Datagram Messaging.
<hr/>	

**Table 25 Audit Trace Options**

<b>Audit Trace Filters</b>	<b>Trace Options</b>
Controller Audit	Basic <ul style="list-style-type: none"> <li>■ None</li> </ul> Operational <ul style="list-style-type: none"> <li>■ Circuit audit status</li> <li>■ Circuit audit timeouts</li> <li>■ Unbinding of publishers or subscribers as a result of a circuit audit</li> </ul> Advanced <ul style="list-style-type: none"> <li>■ Displays same information as Operational</li> </ul>
Transporter Audit	Basic <ul style="list-style-type: none"> <li>■ None</li> </ul> Operational <ul style="list-style-type: none"> <li>■ Transport endpoint failure recovery</li> </ul> Advanced <ul style="list-style-type: none"> <li>■ Audit messages</li> </ul>
Locator Audit	There are currently no trace events defined for Locator Audits.
Target Agent	Basic <ul style="list-style-type: none"> <li>■ None</li> </ul> Operational <ul style="list-style-type: none"> <li>■ Viewer Operations</li> </ul> Advanced <ul style="list-style-type: none"> <li>■ Trace filter configuration operations</li> </ul>

## Defining a Port Reference Trace

When performing a trace on a port reference, you can specify where the messages are traced, set the trace level, and set the buffer size. You can also refine your trace to use only selected component instances (identified by the CNXu<sub>i</sub>). This is useful when you want to focus your trace on a particular component instance that may be experiencing errors (for example, an encode/decode error).

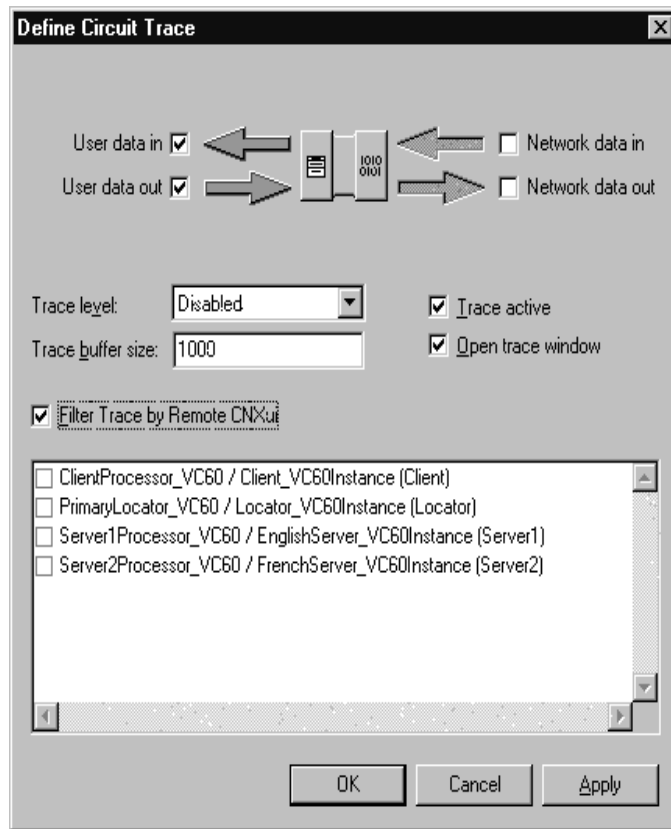
**Table 26 Protocol Messages Trace Options**

<b>Protocol Messages Trace option</b>	<b>Trace Options</b>
User Data In/Out	<p>Basic</p> <ul style="list-style-type: none"> <li>■ Enables component instance wide tracing of all circuit data that is injected into the model or sent by the model. User Data In trace events are collected after the user's data has been decoded. User Data Out trace events are collected before the user's data has been encoded.</li> </ul> <p>Operational</p> <ul style="list-style-type: none"> <li>■ Displays same information as basic</li> </ul> <p>Advanced</p> <ul style="list-style-type: none"> <li>■ Displays same information as basic</li> </ul>
Network Data In/Out	<p>Basic</p> <ul style="list-style-type: none"> <li>■ Enables component instance wide tracing of all circuit data that is received from or sent to the network. Network Data In trace events are collected before the data from a user is decoded. Network Data Out trace events are collected after the data of a user is encoded.</li> </ul> <p>Operational</p> <ul style="list-style-type: none"> <li>■ Displays same information as basic</li> </ul> <p>Advanced</p> <ul style="list-style-type: none"> <li>■ Displays same information as basic</li> </ul>

To define a port reference trace:

1. Select the port reference you wish to trace.
2. Right-click and select **Define Trace** from the popup menu.

The dialog box shown in Figure 89 appears.



**Figure 89 Define Trace Dialog (Port reference)**

3. Configure the trace reference settings according to Table 27.

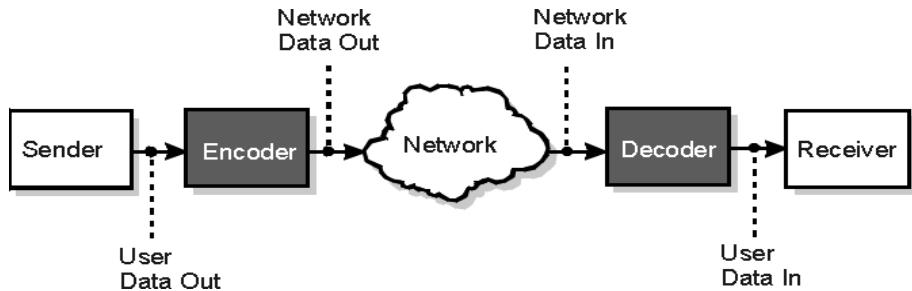
**Table 27 Trace location settings**

Option	Description
User data in	Causes the tracing of incoming messages to occur after the message data has been decoded.

**Table 27 Trace location settings**

Option	Description
User data out	Causes the tracing of outgoing messages to occur before the message data has been encoded.
Network data in	Causes the tracing of incoming messages to occur before the message data has been decoded.
Network data out	Causes the tracing of outgoing messages to occur after the message data has been encoded.

Figure 90 shows what reference point is used for each of the four options. If you encounter problems that you think may have been caused by encoding or decoding, you can use tracing on user and network data to ensure their accuracy.



**Figure 90 User and Network data designations**

Any combination of these checkboxes can be selected. Selecting all four causes the messages to be traced before and after encoding for outgoing messages, and before and after decoding for incoming messages.

4. Configure the **Trace Level** setting according to Table 28.
5. Enter a number to specify the number of events that can be written to the trace buffer in the **Trace buffer size** field.
6. Click the **Trace Active** box to apply the filter settings when you click Apply or OK.
7. Click the **Open Trace Window** to open a trace window for this port reference.

**Table 28** Trace location settings

Option	Description
Disabled	No tracing will be performed.
Activity	Only traces that messages are being sent. The trace event indicates both the local virtual circuit identifier and the remote virtual circuit identifier but the actual signal and message data are not traced.
Signal	Only the message signal will be traced.
Signal and data	Both the message signal and the message data will be traced.

8. Click the **Filter Trace by Remote CNXui** box if you want to specify the remote component instances to be included in the trace. In the list box, click on each component instance you wish to include.

**Note:** When disabled, trace data is gathered for all remote component instances.

9. Click the **OK** button.

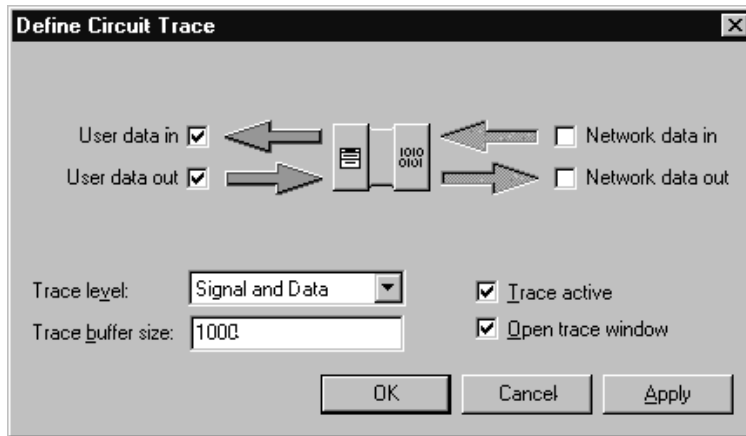
### Defining a Virtual Circuit Trace

When performing a trace on a virtual circuit, you can specify where the messages are traced, set the trace level, and the buffer size.

To define a virtual circuit trace:

1. Select the virtual circuit you wish to trace.
2. Right-click and select **Define Trace** from the popup menu.  
The dialog box shown in Figure 91 appears.





**Figure 91 Define Trace Dialog (Virtual circuit)**

3. Configure the trace reference settings according to Table 29.

**Table 29 Trace location settings**

Option	Description
User data in	Causes the tracing of incoming messages to occur after the message data has been decoded.
User data out	Causes the tracing of outgoing messages to occur before the message data has been encoded.
Network data in	Causes the tracing of incoming messages to occur before the message data has been decoded.
Network data out	Causes the tracing of outgoing messages to occur after the message data has been encoded.

For information on these trace reference points, refer to Figure 90. Any combination of these checkboxes can be selected. Selecting all four causes the messages to be traced before and after encoding for outgoing messages, and before and after decoding for incoming messages.

4. Configure the **Trace Level** setting according to Table 28.
5. Enter a number to specify the number of events that can be written to the trace buffer in the **Trace buffer size** field.

**Table 30 Trace location settings**

Option	Description
Disabled	No tracing will be performed.
Activity	Only traces that messages are being sent. The trace event indicates both the local virtual circuit identifier and the remote virtual circuit identifier but the actual signal and message data are not traced.
Signal	Only the message signal will be traced.
Signal and data	Both the message signal and the message data will be traced.

6. Click the **Trace Active** box apply to the filter settings when you click Apply or OK.
7. Click the **Open Trace Window** to open a trace window for this virtual circuit.
8. Click the **OK** button.

## Trace Window

---

The Trace window presents trace events formatted into columns. The Trace Window automatically scrolls to show new trace events as they arrive unless the scroll bar is not at the bottom. To pause scrolling, click anywhere in the scroll region but the bottom. To resume scrolling, drag the scroll bar to the bottom of the scroll region.

There are two types of trace windows available in the Connexis Viewer:

- Component instance trace windows.
- Virtual circuit trace windows.

Both types of trace windows provide the same function. They differ in the type of information that is displayed in them.

### Component Instance Trace Window

The component instance trace window is shown in Figure 92. It contains four fields of information:

- Time - contains a timestamp of when the message was traced.
- Event - this is the trace type for this trace event.

- Level - this is the level of the trace message.
- Data - this field contains the data that is associated with the trace.

Time	Event	Level	Data
945197351.0	Transporter	Advanced	Transporter CdmMsgType0v1_out : CDM Messa
945197351.15000...	Transporter	Advanced	Transporter CdmMsgType0v1_out : CDM Messa
945197351.15000...	Transporter	Advanced	Transporter CdmMsgType0v1_out : CDM Messa
945197351.15000...	Transporter	Advanced	Transporter CdmMsgType0v1_out : CDM Messa
945197351.15000...	Transporter	Advanced	Transporter CdmMsgType0v1_out : CDM Messa
945197351.15000...	Transporter	Advanced	Transporter CdmMsgType0v1_out : CDM Messa
945197362.81200...	User Data In	Operational	Virtual circuit ID: 2, Signal name: GreetingMessa
945197363.81200...	User Data In	Operational	Virtual circuit ID: 2, Signal name: GreetingMessa
945197364.81200...	User Data In	Operational	Virtual circuit ID: 2, Signal name: GreetingMessa
945197365.84300...	User Data In	Operational	Virtual circuit ID: 2, Signal name: GreetingMessa
945197366.84300...	User Data In	Operational	Virtual circuit ID: 2, Signal name: GreetingMessa
945197367.84300...	User Data In	Operational	Virtual circuit ID: 2, Signal name: GreetingMessa
945197368.84300...	User Data In	Operational	Virtual circuit ID: 2, Signal name: GreetingMessa
945197369.84300...	User Data In	Operational	Virtual circuit ID: 2, Signal name: GreetingMessa

**Figure 92** The component instance trace window

## Virtual Circuit Trace Window

The virtual circuit trace window is shown in Figure 93. It contains seven fields of information:

- Time - contains a timestamp of when the message was traced
- Local Path - contains the Rose RealTime model path for the local side of the virtual circuit
- <-> - contains either a --> or a <-- symbol, indicating the direction in which the message was sent
- Remote Path - contains the Rose RealTime model path for the far side of the virtual circuit if the Target Agent is running at the far end; otherwise, the CNXuI and the VCID are displayed
- Priority - corresponds to the message priority
- Signal - contains the message signal name if the **Signal** or **Signal and data** trace level is specified
- Data - contains the message data if the **Signal and data** trace level is specified

Time	Local Path	<->	Remote Path	Priority	Signal	Data
953060249.42100...	Client:greeting	<-	EnglishServer:greeting	General	GreetingMes...	RTStringHello World!!!
953060250.42100...	Client:greeting	->	EnglishServer:greeting	General	GreetingReq...	void
953060250.42100...	Client:greeting	->	EnglishServer:greeting	General	GreetingReq...	Binary Data...0 bytes
953060250.42100...	Client:greeting	<-	EnglishServer:greeting	General	GreetingMes...	Binary Data...39 bytes
953060250.42100...	Client:greeting	<-	EnglishServer:greeting	General	GreetingMes...	RTStringHello World!!!
953060251.42100...	Client:greeting	->	EnglishServer:greeting	General	GreetingReq...	void
953060251.42100...	Client:greeting	->	EnglishServer:greeting	General	GreetingReq...	Binary Data...0 bytes
953060251.42100...	Client:greeting	<-	EnglishServer:greeting	General	GreetingMes...	Binary Data...39 bytes
953060251.42100...	Client:greeting	<-	EnglishServer:greeting	General	GreetingMes...	RTStringHello World!!!
953060252.42100...	Client:greeting	->	EnglishServer:greeting	General	GreetingReq...	void
953060252.42100...	Client:greeting	->	EnglishServer:greeting	General	GreetingReq...	Binary Data...0 bytes
953060252.42100...	Client:greeting	<-	EnglishServer:greeting	General	GreetingMes...	Binary Data...39 bytes
953060252.42100...	Client:greeting	<-	EnglishServer:greeting	General	GreetingMes...	RTStringHello World!!!

**Figure 93** The virtual circuit trace window

### Trace Window Popup Menu

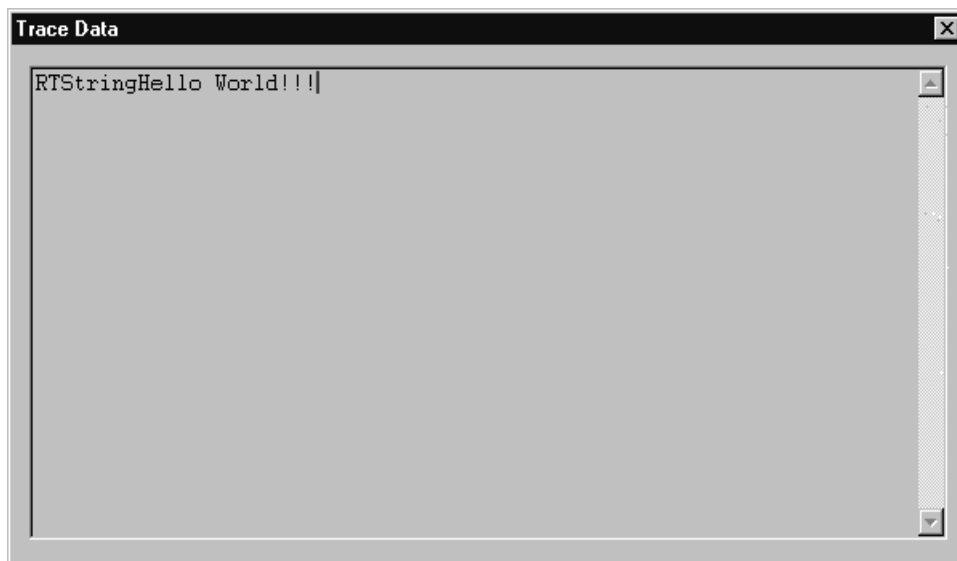
The Trace window has a popup menu associated with it as shown in Figure 94.



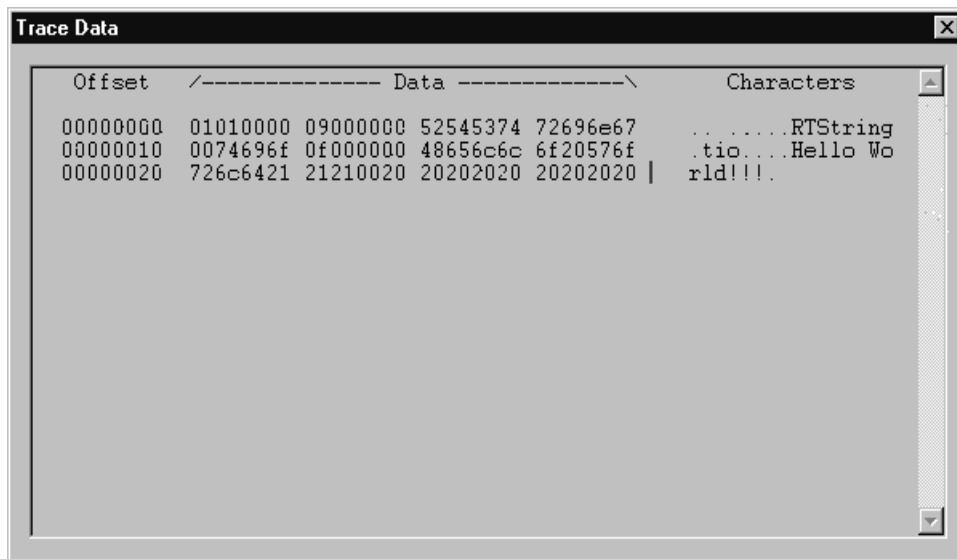
**Figure 94** Trace window popup menu

## Show trace data

This opens a trace data window onto the trace data field of the selected event. The format of this window depends on whether the trace event is a network or user-side trace event. Figure 95 shows an example of the Trace Data window for ASCII data. Figure 96 shows an example of the Trace Data window for binary (network) data.



**Figure 95** *The Trace Data Window with ASCII data*



**Figure 96** *The Trace Data Window with binary data*

## Define trace

Selecting the **Define Trace** command opens the Define Trace Levels dialog box. The content of this dialog box varies depending on the object being traced. Table 31 lists the types of traces that can be performed in Connexis and references the figures that display the Define Trace options.

**Table 31** *Types of Traces*

Trace Type	Figure
Component instance	Figure 87, "Set Component Instance Traces Levels dialog," on page 183
Port reference	Figure 89, "Define Trace Dialog (Port reference)," on page 190
Virtual circuit	Figure 91, "Define Trace Dialog (Virtual circuit)," on page 193

## Trace active

The Trace Active command toggles on and off and is used to select whether the Trace Data window should capture any new trace events. If an inactive trace is set to active, it will reuse the values that were set in the Define Trace dialog box.

## Select in tree

Selecting the **Select in Tree** command causes the object being traced to become active in the Explorer Tree View.

## Clear

Selecting the **Clear** command clears the contents of the trace window.

## Save trace

Selecting the **Save Trace** command brings up a Save As dialog which allows you to save the current contents of the Trace window to a file. There are two available 'formats' of trace output available. They are:

- Comma Delimited Trace (.cdTrace) which produces a simple comma delimited line for each trace event
- Formatted Trace (.fmtTrace) which produces a (tag : value) multi-line output for each trace event

Figure 97 shows a sample trace output for a virtual circuit. The top portion shows the information when Comma Delimited is selected. The bottom portion shows an example of the output when the Formatted Trace option is selected.

### Comma Delimited (cdTrace)

Captured using Connexis Viewer Version 6.1

Time, Trace Name, Trace Level, Trace Data

```
945197351.15000000, Transporter, Advanced, "Transporter CdmMsgType0v1_out : CDM Message sent of length 117"
945197351.15000000, Transporter, Advanced, "Transporter CdmMsgType0v1_out : CDM Message sent of length 117"
945197362.812000000, User Data In, Operational, "Virtual circuit ID: 2, Signal name: GreetingMessage"
945197363.812000000, User Data In, Operational, "Virtual circuit ID: 2, Signal name: GreetingMessage"
```

---

### Formatted Record (fmtTrace)

Captured using Connexis Viewer Version 6.1

```
Time: 945197350.609000000
Group: Transporter
Level: Advanced
Data:
"Transporter CdmMsgType0v1_out : CDM Message sent of length 117"

Time: 945197362.812000000
Group: User Data In
Level: Operational
Data:
"Virtual circuit ID: 2, Signal name: GreetingMessage"
```

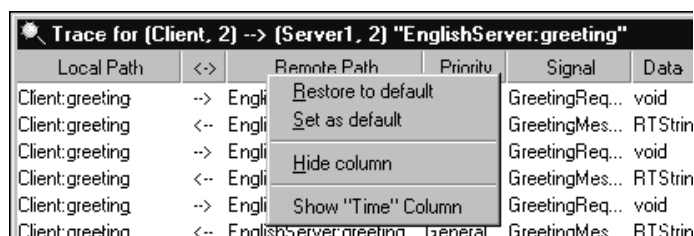
**Figure 97 Sample component trace output - Comma Delimited and Formatted Record**



## Trace Header Context Menu

There are times when it is desirable to define a custom layout for the Trace Window columns. Connexis Viewer allows you to perform these operations through a context menu that appears when you right-click on the header control (see Figure 98) of a Trace Window.

When a new Trace Window is opened, it uses the current system default information to determine the layout of the columns and the size of the window. If you change the layout of an open Trace Window, this information is saved and used the next time that the window is opened.



**Figure 98 Trace Header Context menu**

Selecting the **Restore to default** entry causes the Trace Window to revert to the current default layout.

Selecting the **Set as default** causes the Trace Window's current layout to become the new 'default' layout. Note that this will not affect windows that are already open but will cause all newly-opened trace windows to use this layout (unless they have been previously opened and modified by the user).

Selecting the **Hide column** will cause the column the cursor is on to become hidden (for example, in the image above, the Remote Path column would become hidden. Note that you cannot hide the Data column).

At the end of the menu, any currently hidden columns show up in the format Show "<column name>" Column. Selecting one of these entries will cause the (previously hidden) column to become visible again. The column will re-appear at its previously defined width.

## Generating Interaction Diagrams from Trace Output Files

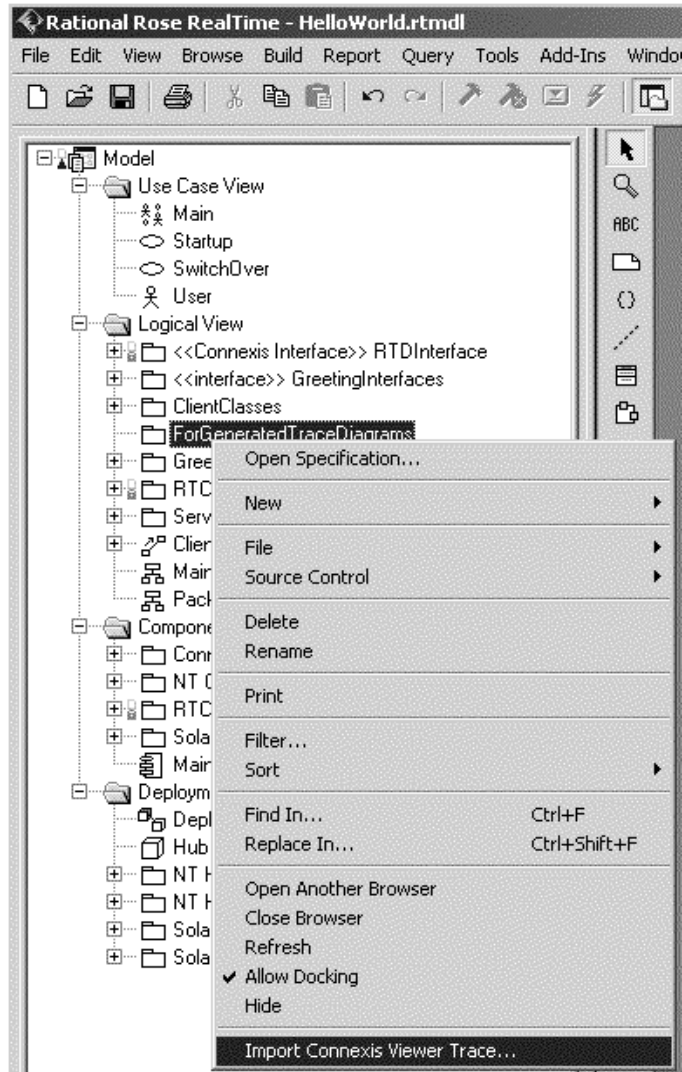
---

With Connexis, you can create interaction diagrams from trace output files, generated from traces on a port reference or a virtual circuit. The trace output files can be imported into a Rose RealTime model and rendered into collaboration and sequence diagrams.

Before you generate interaction diagrams, use the Connexis Viewer to perform an event trace on a port reference (see “Defining a Port Reference Trace” on page 188) or a virtual circuit (see “Defining a Virtual Circuit Trace” on page 192) and save the trace output to a file (see “Save trace” on page 199).

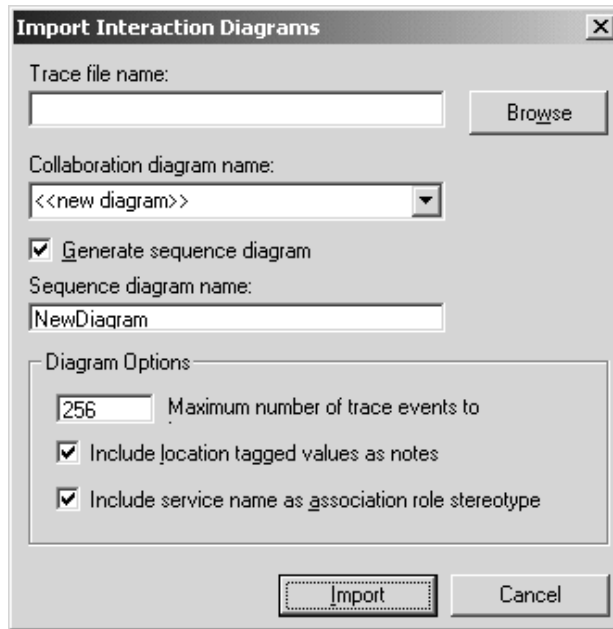
To generate interaction diagrams:

1. Perform an event trace on a port reference or on a virtual circuit. Ensure that the trace level is set to Signal or Signal and data.
2. Save the event trace information to file. The trace file can be formatted or comma-delimited.
3. From the tree browser of the Rose RealTime application, right-click the folder in which you want to save the collaboration and sequence diagrams that will be generated.



**Figure 99** Tree browser in Rose RealTime

4. Click **Import Connexis Viewer Trace**.  
The Import Interaction Diagram dialog appears.



**Figure 100** *Import Interaction Diagrams dialog*

- Complete the Import Interaction Diagrams dialog according to the following table:

**Table 32** *Description of Import Interaction Diagrams dialog*

<b>Option</b>	<b>Description</b>
Trace file name	Browse for the trace file that you stored. This is the file that you will use to generate your collaboration and sequence diagrams.
Collaboration diagram name	Type or select the name of the collaboration diagram that you want to generate.
Generate sequence diagram	If you want to generate a sequence diagram, ensure that this check box is checked.
Sequence diagram name	Type the name of the sequence diagram that you want to create.

**Table 32** *Description of Import Interaction Diagrams dialog*

<b>Option</b>	<b>Description</b>
Maximum number of trace events to	Type the maximum number of trace events that you want represented in your sequence diagrams. A maximum number of 256 can be selected.
Include location tagged values as notes	If you want to include location tagged values as notes on the collaboration diagram, ensure that this check box is selected.
Include service name as association role stereotype	If you want to include the service name that was used to establish the binding as the association role's stereotype, ensure that this check box is checked.

6. Click the **Import** button.

The collaboration diagram and the sequence diagram (if enabled) are generated. Once the generation process is complete, the diagrams appear in the display area of Rose RealTime.

**Note:** *If an error message occurs, see Reporting of error messages for a detailed description of the message.*

### Reporting of error messages

While generating interaction diagrams, you may receive an error message that provides feedback about the process. The following chart lists and explains the error messages:

<b>Error Message</b>	<b>Description</b>
Unknown file format	The file specified in the Trace file name text field is not an acceptable file format. Acceptable file formats are .cdTrace (comma delimited) or .fmtTrace (formatted). The file formats with the .cdTrace and the .fmtTrace extensions, identify the type of trace file to be processed.
Unable to process trace file because it is incompatible with the current version of the toolset add-in	The imported trace file has been generated by an earlier version of the Rational Connexis Viewer. The file format is incompatible with the format accepted by the toolset add-in. Import trace files must be generated by Rational Connexis version 2001A.04.00 or newer.
Invalid file format	The user has modified the file or an error occurred while the Connexis Viewer was attempting to write the file.
Cannot process more than 256 trace events	An attempt has been made to configure the tool to import more trace events than the feature can support.

### Log Window




---

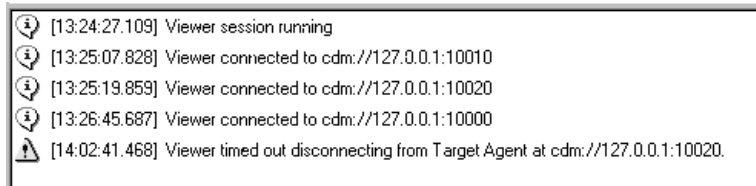
The log window displays the status of the connections in the executing model.

Each message is preceded by a timestamp in square brackets. This timestamp indicates the time that the message was received by the Viewer. Icons indicate the type of message as summarized in Table 33.

A sample log window output is shown in Figure 101.

**Table 33** *Log window icons*

<b>Icons</b>	<b>Meaning</b>
	normal messages
	warning messages
	error messages



**Figure 101** *The log window*

## Displaying the Metrics Collection

Metrics is a Connexis Viewer function that lets you start, display and save statistics collected on a component instance. Once metrics gathering is enabled on a Connexis library, statistics are collected on internal run-time operations and registered transports, active in the model.

A Connexis library that is enabled to gather metrics, collects statistics on its internal run-time operations and on any registered transport that are active in the model.

Internal run-time operations include:

- Creating and auditing circuits
- Encoding and decoding messages
- Publishing and subscribing to services

Transport statistics include:

- Totals on the number and the size of message sent and received
- Minimum and maximum sizes of the message payloads
- Number of messages sent with and without data
- Breakdown of application-level versus control message sent

**Note:** All transports supplied with Connexis reports these statistics. Transports built using the Transport Integration Framework must use the API supplied by Connexis to gather transport-specific statistics at run-time. For a complete discussion of this topic, see “Using the Transport Integration Framework” on page 299.

### Starting Metrics Collection

Metrics gathering is designed to have the smallest possible impact on performance. The Viewer connects to the component instance and request statistics on a running model that has metrics enabled in the DCS library, and the CDM transport registered.

When the Viewer connects to the component instance, it sends a request to start gathering metrics and requests a reporting rate (see “Adding a Component Instance” on page 177). The component instance tells the Viewer what reporting rate it supports, describes the registered transports, and reports statistics at the appropriate interval.

To collect metrics on a component instance:

1. Right-click the component instance on which you want to collect statistics. A popup window appears.
2. Select **Open Metrics Window** from the list. The Metrics window appears with the name of the component instance in the title bar.
3. Select the tab containing the information that you require (see “Using the Metrics Window” on page 208).

### Using the Metrics Window

The Metrics window displays statistics collected on the internal run-time operations and registered transports of a component instance. You can access metrics information from the following window tabs.

**Table 34 Metrics Window tabs**

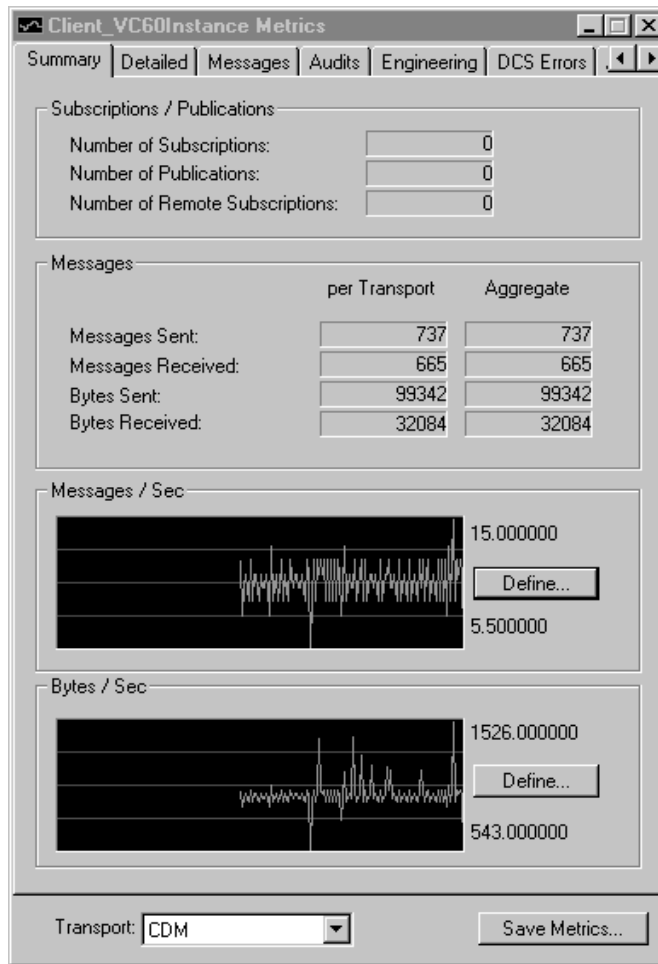
<b>Metrics window tabs</b>	<b>Description</b>
Summary	“Summary metrics collection” on page 210
Detailed	“Detailed metrics collection” on page 214
Messages	“Messages metrics collection” on page 216



**Table 34** *Metrics Window tabs*

<b>Metrics window tabs</b>	<b>Description</b>
Audits	“Stopping Metrics Collection” on page 234
Engineering	“DCS errors metrics collection” on page 225
DCS Errors	“DCS errors metrics collection” on page 225
App Errors	“Application errors metrics collection” on page 228
App Incompatibility	“Application incompatibility metrics collection” on page 232

## Summary metrics collection



**Figure 102 Metrics Window: Summary Information**

**Table 35 Subscriptions/Publications**

<b>Message Type</b>	<b>Description</b>
Number of Subscriptions	The total number of subscriptions that have been registered locally, registered explicitly, registered globally through the locator, and the number of remote subscriptions that have been registered to publications in the Component Instance.
Number of Publications	The total number of local and global publications registrations.
Number of Remote Subscriptions	The number of registrations from remote subscriptions.

**Table 36 Messages**

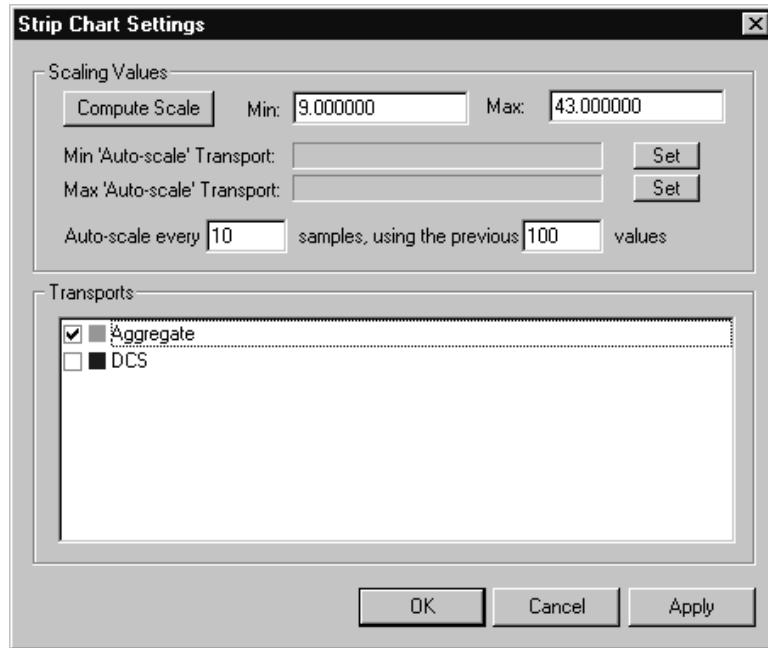
<b>Message Type</b>	<b>Description</b>
Messages Sent	Successfully sent user application messages with signal and data, including message data. These messages require a buffer to be send.
Messages Received	User application messages with signal and data received. These messages may or may not be passed to the application successfully and the application was unable to decode the message.
Bytes Sent	Total number of bytes sent on the transport. Includes audit, control and user messages.
Bytes Received	Total number of bytes received on the transport. Includes audit, control and user messages.

### **Defining Messages/Sec and Bytes/Sec**

From the Summary page of the Metrics dialog, you can set the way strip chart information is displayed in the Messages/Sec and the Bytes/Sec area. The Messages/Sec area displays the number of messages sent from the component instance per second. The Bytes/Sec area displays the number of bytes sent from the component instance per second.

To change the way chart settings are presented:

1. Click the **Define** button in the Messages/Sec or the Bytes/Sec area.  
The “Strip Chart Settings” dialog appears.

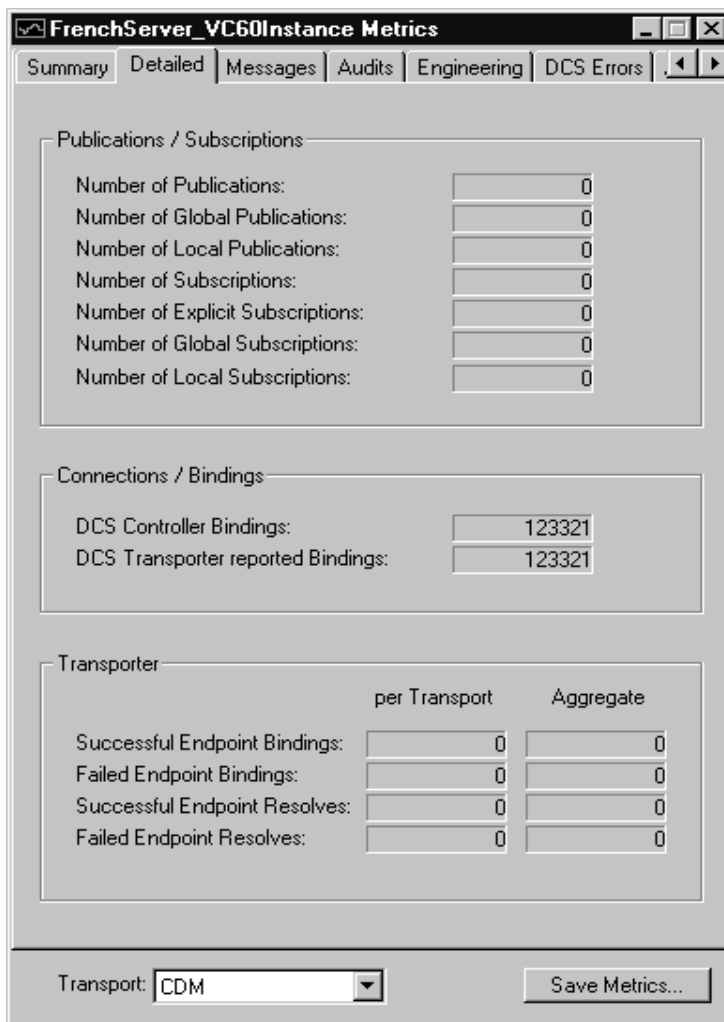


**Figure 103** Strip Chart Settings dialog

**Table 37 Strip Chart Settings**

<b>Settings</b>	<b>Description</b>
Compute Scale	<p>Clicking <b>Compute Scale</b> analyses the strip chart and determines the minimum and the maximum values.</p> <p><b>Note:</b> <i>To manually set the Compute Scale values without have them overridden, set <b>Auto-scale every</b> to zero.</i></p>
Min 'Auto-scale' Transport	<p>Lets you set the transport that you want the strip chart to use for the minimum auto-scale value. Before setting the minimum auto-scale value, select the transport from the <b>Transports</b> selection area.</p>
Max 'Auto-scale' Transport	<p>Lets you set the transport that you want the strip chart to use for the maximum auto-scale value. Before setting the maximum auto-scale value, select the transport from the <b>Transports</b> selection area.</p>
Auto-scale every	<p>This sets the number of samples received from the transport before the script chart calculates the result and presents the information.</p>
Using the previous values	<p>This sets the number of previous values that the strip chart uses to calculate the result.</p>
Transports	<p>This area displays the transports available for use.</p>

### Detailed metrics collection



**Figure 104 Metrics Window: Detailed Information**

**Table 38 Publications/Subscriptions**

<b>Message Type</b>	<b>Description</b>
Number of Publications	Total number of Publications.
Number of Global Publications	Total number of global SPP registrations.
Number of Local Publications	Total number of local SPP registrations.
Number of Subscriptions	Total number of Subscriptions.
Number of Explicit Subscriptions	Total number of explicit SAP registrations.
Number of Global Subscriptions	Total number of global SAP registrations.
Number of Local Subscriptions	Total number of local SAP registrations.

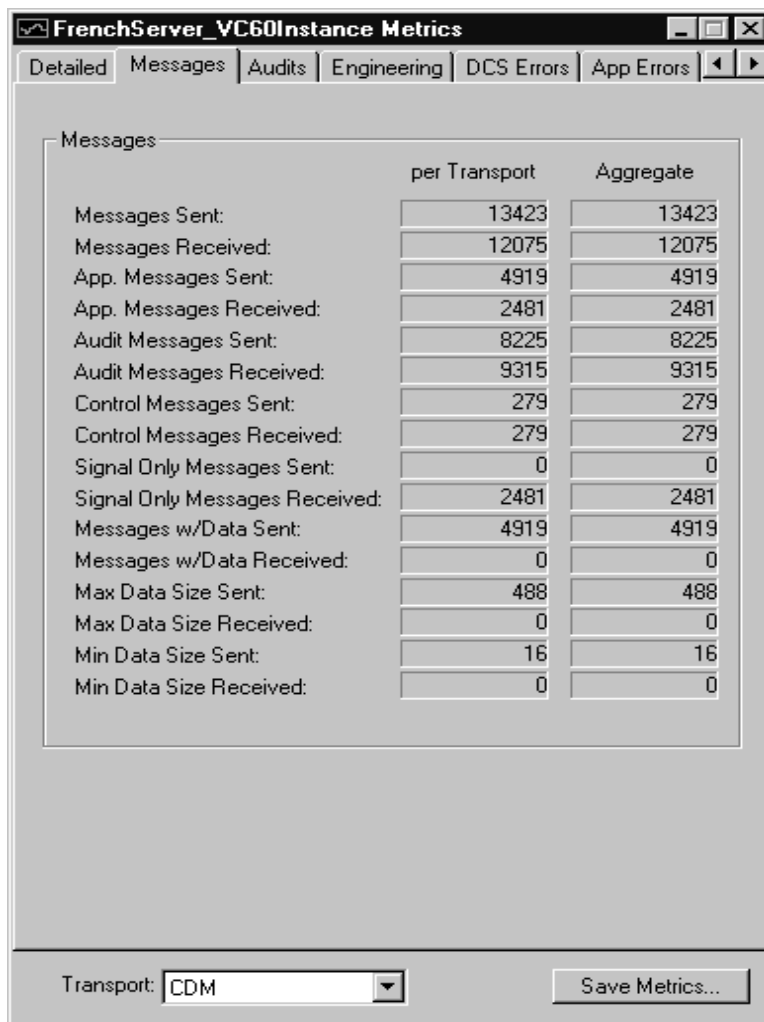
**Table 39 Connections/Bindings**

<b>Message Type</b>	<b>Description</b>
DCS Controller Bindings	Total number of SAP/SPP bindings.
DCS Transport reported Bindings	Number of ports successfully bound. This includes both SAP and SPP ports. This count may include duplicate binds if the underlying transport is lost and control messages have to be resent.

**Table 40 Transporter**

<b>Message Type</b>	<b>Description</b>
Successful Endpoint Bindings	Number of successful transport binds.
Failed Endpoint Bindings	Number of transport bind failures.
Successful Endpoint Resolves	Number of addresses resolved successfully.
Failed Endpoint Resolves	Number of address resolve failures.

### Messages metrics collection



**Figure 105 Metrics Window: Messages**



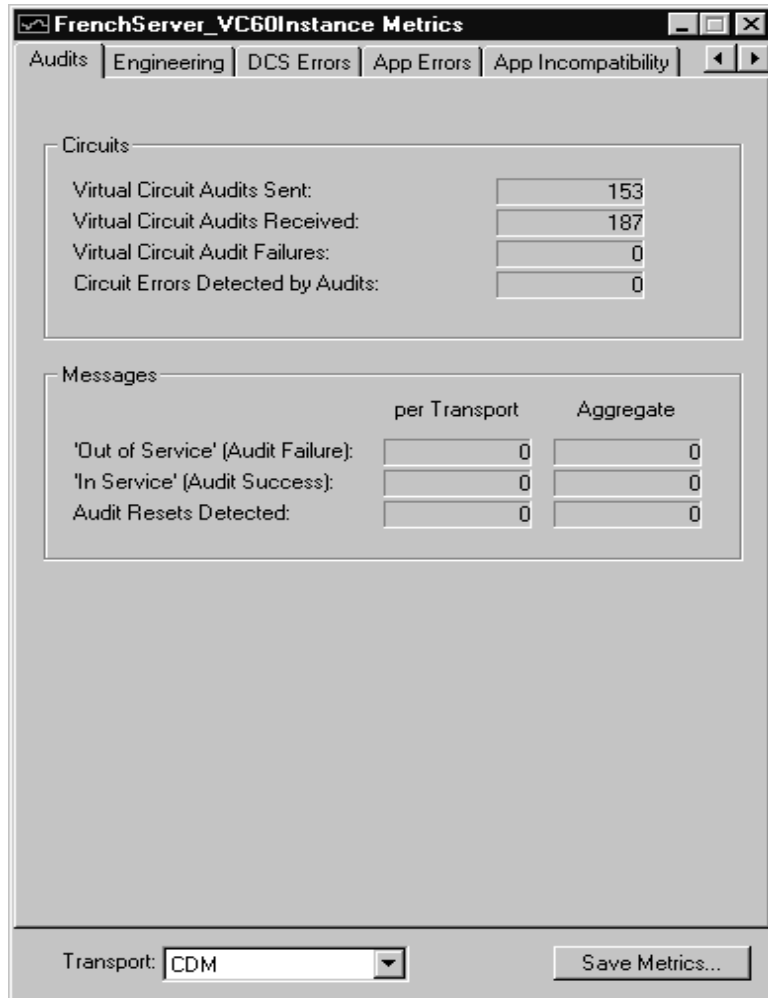
**Table 41 Messages**

<b>Message Type</b>	<b>Description</b>
Messages Sent	Connect, register registered, etc.
Messages Received	Connect, register registered, etc.
Application Messages Sent	The total number of message sent by the application. This count includes those messages sent with data and with signal only.
Application Messages Received	The total number of message received by the application. This count includes those messages received with data and with signal only.
Audit Messages Sent	Are You Alive, I Am Alive and You Are Not Responsive messages sent.
Audit Messages Received	Are You Alive, I Am Alive and You Are Not Responsive messages received.
Control Messages Sent	Connect, register registered, etc.
Control Messages Received	Connect, register registered, etc.
Signal Only Messages Sent	User application messages consisting only of a successfully sent signal.
Signal Only Messages Received	User application messages consisting only of a signal that was received. These messages may or may not be passed to the application successfully (for example, incompatible with protocol).
Messages with Data Sent	Successfully sent user application messages with signal and data, including message data. These messages require a buffer to be send.
Messages with Data Received	User application messages with signal and data received. These messages may or may not be passed to the application successfully and the application was unable to decode the message.

**Table 41 Messages**

<b>Message Type</b>	<b>Description</b>
Maximum Data Size Sent	Size of the largest encoded data object successfully sent. This information in conjunction with <code>EncodeExceedsMaxSize</code> helps you engineer the size of the larger buffers in the buffer pool.
Maximum Data Size Received	Size of the largest encoded data object received.
Minimum Data Size Sent	Size of the smallest encoded data object successfully sent. This helps you engineer what is the size of the smaller buffers needed in the buffer pool. It also helps you decide setting of <code>CNXtfms</code> .
Minimum Data Size Received	Size of the smallest encoded data object successfully received.

## Audits metrics collection



**Figure 106 Metrics Window: Audits Information**

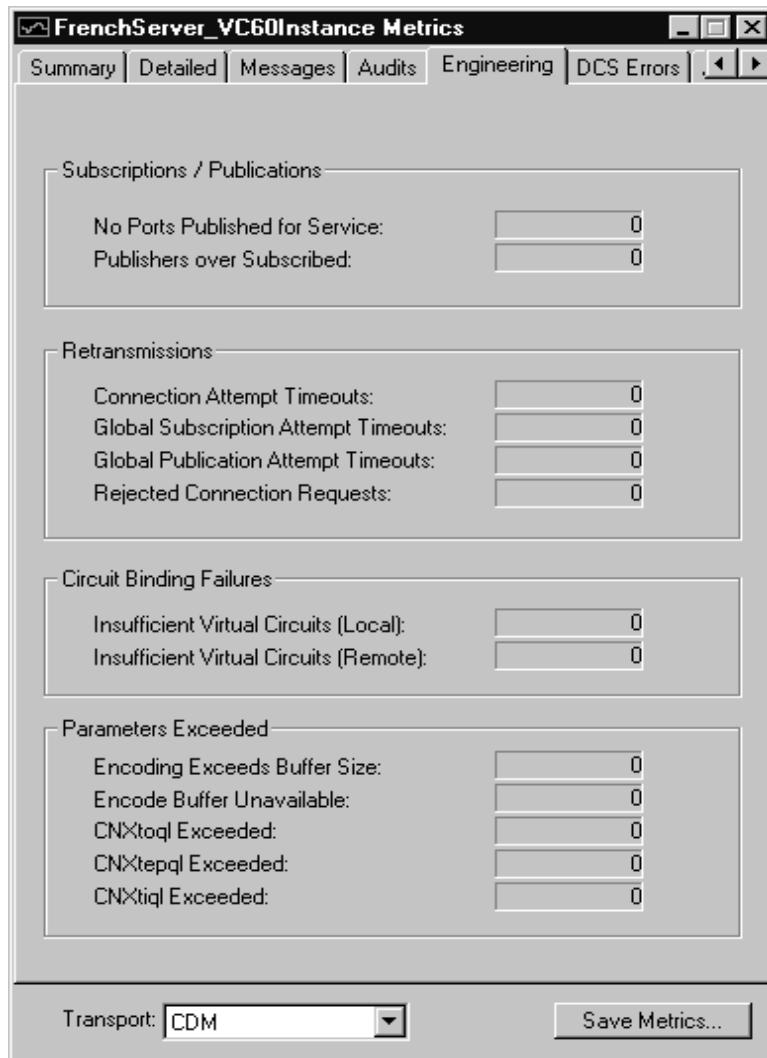
**Table 42** *Circuits*

<b>Message Type</b>	<b>Description</b>
Virtual Circuit Audits Sent	Total number of virtual circuit audits sent.
Virtual Circuit Audits Received	Total number of virtual circuit audits received.
Virtual Circuit Audit Failures	Total number of virtual circuits removed due to unacknowledged audits.
Circuit Errors Detected by Audit	Total number of invalid virtual circuits removed due to audits.

**Table 43** *Messages*

<b>Message Type</b>	<b>Description</b>
Out of Service (Audit Failure)	Number of times an endpoint went out of service (CDM did not get IAA responses).
In Service (Audit Failure)	Number of times an endpoint went back into service after an Audit unresponsive failure.
Audit Resets Detected	Number of times an endpoint went out of service and then back into service after detecting that the other side has gone away and come back. Applies to CDM only.

## Engineering metrics collection



**Figure 107 Metrics Window: Engineering Information**

**Table 44 Subscription/Publications**

<b>Message Type</b>	<b>Description</b>
No Ports Published for Service	Number of times SAPs could not bind to an SPP because no SPP was registered for that service.
Publications over Subscribed	Number of times SAPs could not bind to an SPP because the SPPs were all fully bound.

**Table 45 Retransmissions**

<b>Message Type</b>	<b>Description</b>
Connection Attempt Timeout	Total number of virtual circuit establishment retries.
Global Subscription Attempt Timeout	Total number of global SAP locator registration retries.
Global Publication Attempt Timeout	Total number of global SPP locator registration retries.
Rejected Connection Requests	The number of times retrying a connect request resulted in more than one virtual circuit being setup. The ConnectSuccess received is rejected, allowing the other side to terminate the additional circuit.

**Table 46 Circuit Binding Failures**

<b>Message Type</b>	<b>Description</b>
Insufficient Virtual Circuits (Local)	Total number of times a SAP failed to register because a free virtual circuit was not available on the client-side of a connection.
Insufficient Virtual Circuits (Remote)	Total number of times a SAP failed to register because a free virtual circuit was not available on the server-side of a connection.

**Table 47 Parameters Exceeded**

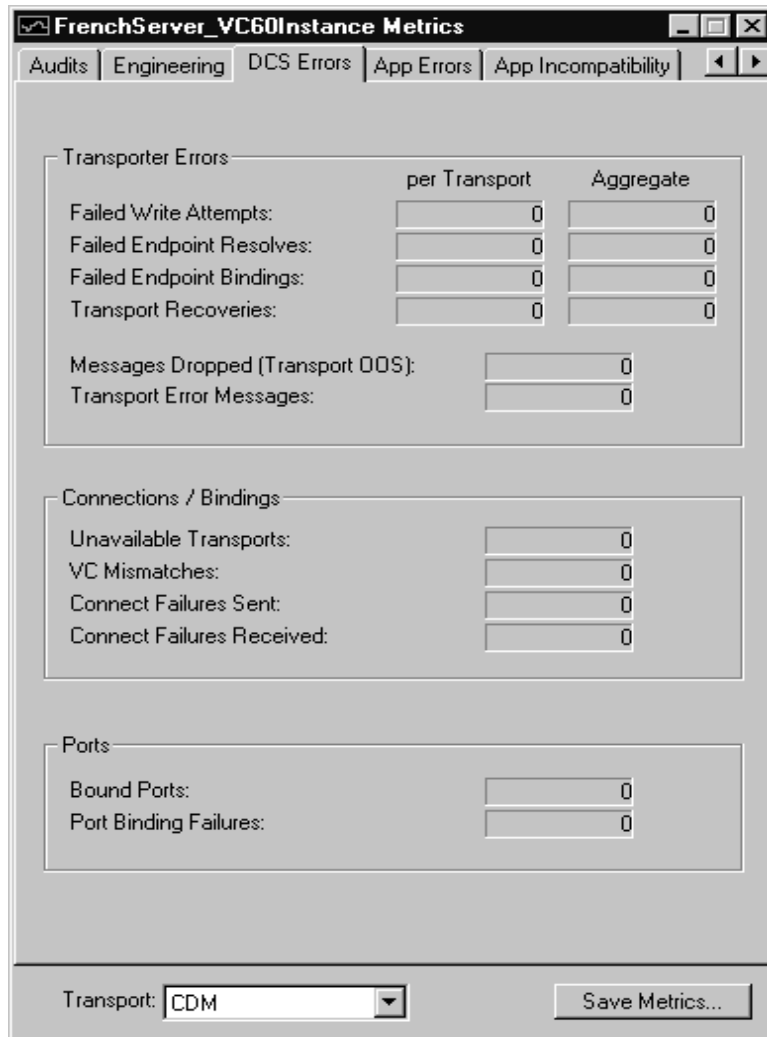
<b>Message Type</b>	<b>Description</b>
Encoding Exceeds Buffer Size	Number of times encoding an outgoing message failed. This occurs because a large enough buffer is not available. If any overridden encode function on one of the classes that describes the type being sent (i.e. attribute classes) returns 0, this results in a failure as well. Message is not sent.
Encode Buffer Unavailable	Number of times a buffer, of a suitable size to encode the message, was unavailable. All messages are encoded to a buffer before sending. This error may occur if the message is very large and there is no buffer available that can accept the payload. Blocking transports such as CRM also use this pool to buffer message sends while the transport is busy. If the transport becomes overloaded, message sends are buffered until there are no further buffers in the pool. Consider increasing the number of buffers in the transport pool using the -CNXtbp parameter. Message is not sent.

**Table 47 Parameters Exceeded**

Message Type	Description
CNXtoql Exceeded	The number of times the output queue limit is exceeded. Examine the CNXtoql parameter setting. The setting needed dependent on CNXtepql and the number of endpoints in use and number of host names being resolved (for CDM). If this only occurs during connection establishment and you also see the Connections rejected later, increase the retry delay. It could be due to retrying connects before the hostname can be resolved. If you have a highly replicated non-published unwired port doing automatic registration (i.e. a large number of SAP registrations going on at once), consider staggering the startup load on the system. Message is not sent.
CNXtepql Exceeded	The number of times the endpoint queue limit is exceeded. Examine the CNXtepql parameter setting. The setting needed is dependent on the maximum number of messages to be queued for an end point. If you increase this, examine the CNXtoql parameter setting as well. If this occurs during connection establishment, see the CNXtoqlExceeded description as well. Message is not sent.
CNXtiql Exceeded	The number of times the input queue limit is exceeded. Examine the CNXtiql parameter. It can be used to prevent Connexis from being swamped. Message is not received.



## DCS errors metrics collection



**Figure 108 Metrics Window: DCS Errors Information**

**Table 48 Transport Errors**

<b>Message Type</b>	<b>Description</b>
Failed Write Attempts	Number of times the send of a message failed on the write (CDM failed on the write). Message not sent.
Failed Endpoints Resolves	Number of host name resolve failures.
Failed Endpoints Bindings	Number of transport bind failures.
Transport Recoveries	Number of times a transport is brought back into service after an audit has failed.
Messages Dropped (Transport OOS)	Number of queued messages sent to an endpoint after the audit has determined that it has gone out of service.
Transport Error Messages	Number of times the controller sent the transport error message.

**Table 49 Connections/Bindings**

<b>Message Type</b>	<b>Description</b>
Unavailable Transports	The number of times an attempt to use an unavailable transport was made. Message is not sent/received.

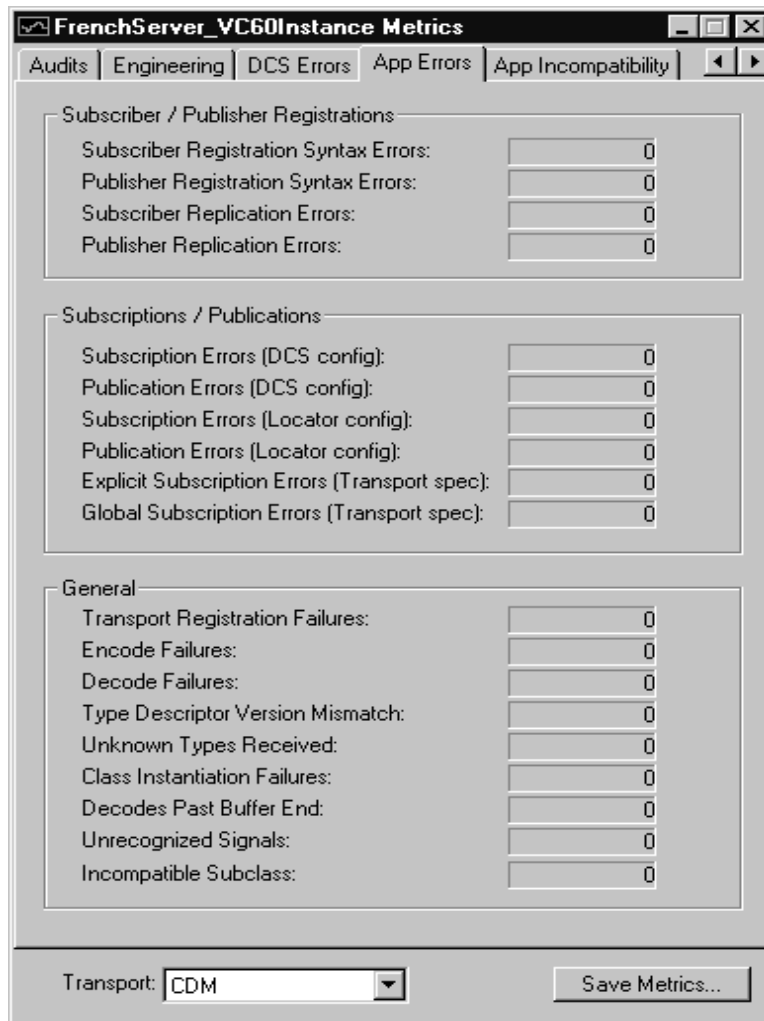
**Table 49 Connections/Bindings**

<b>Message Type</b>	<b>Description</b>
VC Mismatches	Number of times the virtual circuit information contained in a request does not match the current virtual circuit setup. Typically occurs during transport failures or after user applications have failed and restarted. The SAP or SPP that was previously being communicated which is no longer available (may be participating in another connection or is released). The Circuit Audit cleans up these situations. Message not sent/received.
Connect Failures Sent	Number of ConnectFailure responses sent in response to connect messages received. No virtual circuit is established. The reason for failing such a request is due to no further virtual circuits being available.
Connect Failures Received	Number of ConnectFailures received in response to connect messages sent. A virtual circuit could not be setup on the other endpoint.

**Table 50 Ports**

<b>Message Type</b>	<b>Description</b>
Bound Ports	Number of ports successfully bound. This includes both SPP and SAP ports and may include duplicate binds. For example, a bind may occur twice for the same port if dealing with a lost transport (control messages are re-sent), or if user data messages over-take control messages.
Port Binding Failures	Number of times binding a port failed. User messages are not be able to be exchanged through the port.

### Application errors metrics collection



**Figure 109 Metrics Window: Application Errors Information**

**Table 51 Subscriber/Publisher Registrations**

<b>Message Type</b>	<b>Description</b>
Subscriber Registration Syntax Errors	Number of times a SAP failed to register because its registration string had invalid syntax.
Publisher Registration Syntax Errors	.Number of times a SPP failed to register because its registration string had invalid syntax.
Subscriber Replication Errors	Number of times a SAP failed to register because its replication factor was zero.
Publisher Replication Errors	Number of times a SAP failed to register because its replication factor was zero.

**Table 52 Subscription/Publications**

<b>Message Type</b>	<b>Description</b>
Subscription Errors (DCS config)	Number of times a SAP failed to register because DCS was not configured correctly.
PublicationErrors (DCS config)	Number of times a SPP failed to register because DCS was not configured correctly.
Subscription Errors (Locator config)	Number of times a SAP failed to register globally because the locator was not configured.
Publication Errors (Locator config)	Number of times a SPP failed to register globally because the locator was not configured.
Explicit Subscription Errors (Transport spec)	Number of times an SAP failed to register explicitly (for example, registerSAP("dcs:<transport>//<host>:<port>/<service>")) using a transport protocol because the transport was not properly configured.
Global Subscription Errors (Transport spec)	Number of times a SAP failed to register globally (for example, registerSAP("dcs:/<service>")) using a transport protocol because the transport was not properly configured.

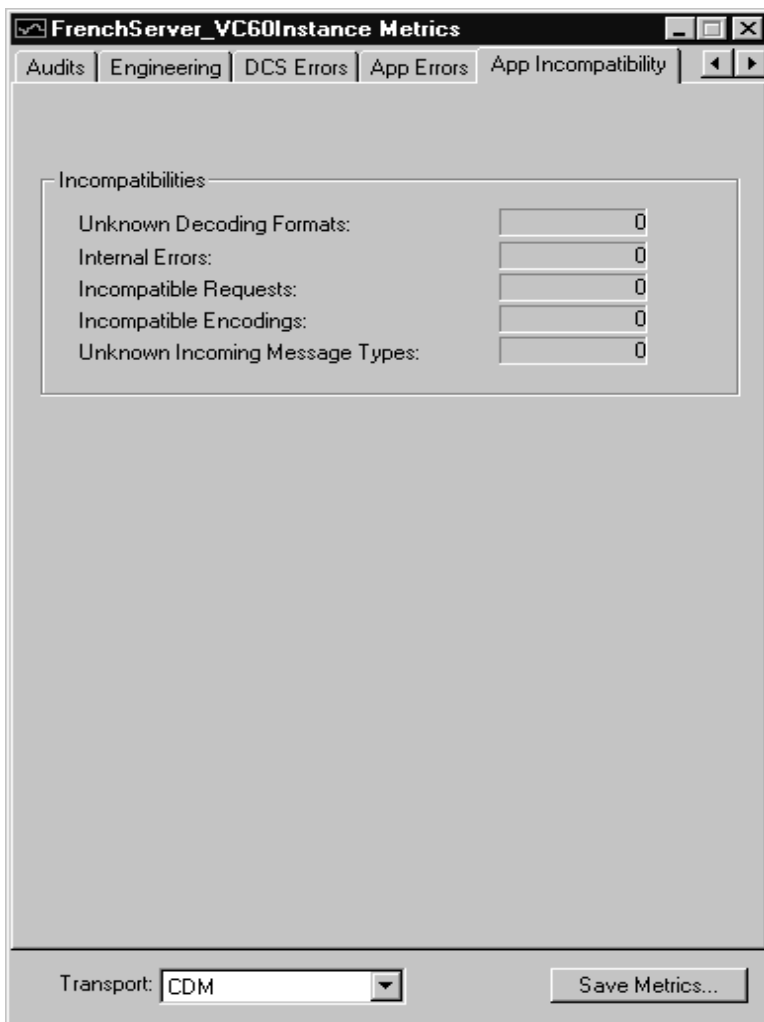
**Table 53 General**

<b>Message Type</b>	<b>Description</b>
Transport Registration Failures	The number of times an attempt to use an unavailable transport was made. Message is not sent or received.
Encode Failures	Number of times the encoding of an outgoing message failed. This can occur when there was no buffer large enough to encode the payload, or the overridden encode function returned 0. Message is not sent.
Decode Failures	Number of times the decoding of an incoming message failed.
Type Descriptor Version Mismatch	Number of times the version of the sender's class does not match the version expected in the receiver. You can specify the version of a class in its C++ TargetRTS property tab. Only the version of the class being sent is considered. The version(s) of its attributes are not. Message is not received.
Unknown Types Received	Number of times the sender's class is not known in the receiver's application. This can occur if the sender and receiver are in two different models (different .rtmdl files). If so, then the protocol and class being sent must be shared between the models. This failure can also occur if the class is not referenced anywhere in the receiver's model, and so is not compiled. Message not received.
Class Instantiation Failures	The number of times the receiver failed to create the class to be received. There may be a problem with the default or overridden allocation method for the type descriptor of the class. Message not received

**Table 53** *General*

<b>Message Type</b>	<b>Description</b>
Decodes Past Buffer End	Number of times Connexis read past the end of the encoded data while decoding an incoming message. Check that the encode and decode methods in the type descriptors match exactly on the sender and receiver side. Message not received
Unrecognized Signals	Number of times the signal received is not recognized as valid on the receiver's protocol. Verify that the protocols used in the sender and receiver are compatible, and properly conjugated. Message not received.
Incompatible Classes	The number of times the data type received with a signal is not a compatible subclass of the type that has been defined by the protocol. Verify that the protocols used in the sender and receiver are compatible and properly conjugated. Message not received.

### Application incompatibility metrics collection



**Figure 110 Metrics Window: Application Incompatibility Information**



**Table 54 Incompatibilities**

<b>Message Type</b>	<b>Description</b>
Unknown Decoding Formats	Number of times the data received was encoded in an unknown format.
Internal Errors	Number of times Connexis internal processes cannot process the message (can be user message or control message). Message is not sent.
Incompatible Requests	Number of times unknown control messages were received. This will not happen if all applications are running with Connexis release 6.1.1. Future Connexis releases may support additional control requests not supported by Connexis 6.1.1. Connexis informs the message sender so that a common request interface can be used. See your user guide for that Connexis release. Connexis 6.1.1 can not inter-operate with applications using an earlier Connexis release. Message is not received.
Incompatible Encoding	This will not happen if all applications are running with Connexis release 6.1.1. Future Connexis releases may support enhanced existing encoding formats that are not supported by Connexis 6.1.1. Connexis informs the message sender so that a common version of encoding can be used. See your user guide for that Connexis release. Connexis 6.1.1 can not inter-operate with applications using an earlier Connexis release. Message is not received.
Unknown Incoming Message Types	The number of times the incoming message was of an unknown type.

### Stopping Metrics Collection

Closing the metrics collection window stops metrics reporting on the selected component instance.

To stop collecting Metrics:

1. Click the **Close** button on the top right corner of the window.

### Saving Collected Metrics

Once you start collecting metrics on a component instance, you could save the statistics for further analysis. Metrics statistics are saved in a tab-separated format that can be imported directly into popular spreadsheet programs.

To save collected metrics:

1. Click the **Save Metrics** button.
2. Type the name of the file you want to save in the “Save Metrics As” dialog box. The file is saved as a ComponentInstanceMetrics (CIMetrics) file. You can open this file a spreadsheet application like Microsoft Excel or in any text application.

### Viewer Tips and Usage Notes

---

This section provides some tips and usage notes to make it easier to use the Connexis Viewer:

- Capturing Pre-Viewer Session Messages
- Error and Warning Tracing
- Maximizing Viewer Responsiveness

#### Capturing Pre-Viewer Session Messages

It is possible to capture traces before a target session is established. The CNXaas parameter will enable the following trace events:

- controller
- locator
- transporter
- component-wide tracing for all data sent to, and received from, all unwired DCS ports

- any errors or warnings

**Note:** *In this mode, only the signal, data, and virtual circuit are indicated.*

## Error and Warning Tracing

Connexis Viewer provides capabilities for tracing and filtering software errors and warnings.

### Software errors

Software errors are used to indicate anomalous conditions that prevent user data from being transported. Software errors are filtered on a component instance basis, that is, across all functional groups.

There are many causes of software errors. These include:

- Resource depletion, for example, running out of virtual circuits
- Application registration errors, for example, syntax errors in registration string
- Internal Connexis errors, for example, unexpected message type processed by a DCS Capsule, initialization errors
- messages being discarded due to type mismatches (on input)

### Software warnings

Software warnings are used to indicate conditions that will prevent Connexis from operating as configured or that can potentially lead to user data being lost. For example, an unexpected message or an unknown message type may cause a software warning.

## Maximizing Viewer Responsiveness

Under heavy load, you may sometimes notice that the Viewer becomes unresponsive, that is, right-clicking does not immediately bring up the context menu. This occurs especially if there are many components running 'locally', on the same CPU as the Viewer.

To remedy this situation, use the **Task Manager** to set the Priority of the Viewer to **High** as follows:

1. Right click on the Taskbar and select **Task Manager**.

2. In the Processes tab of the Task Manager, right click on the **ConnexisViewer** entry.
3. Use the **Set Priority** menu item to set the Viewer's priority to **High**.

**Note:** *If the Viewer is still unresponsive, you can try to reduce the Viewer load by closing trace windows that you do not need to have open.*



## *Chapter 8*

# *Using the Connexis Metrics Service*

---

Rational Connexis provides capabilities to collect real-time DCS metrics information within an executing Rose RealTime model. You can collect and report metrics on each running component instance. The DCS performance information that is collected by the DCS metrics service can be used to tune the DCS command line options.

Metrics services are only available within DCS library components that have been compiled with metrics collection capabilities enabled. At run-time, metrics data can be obtained from within a Connexis enabled model by subscribing to the metrics service. Although you can subscribe to the metrics service at anytime, you will not be connected to the metrics service until the service is published within the DCS layer.

## **Obtaining Metrics Data with a Metrics Service**

---

The following sections explain how to collect metrics from a Connexis component instance at runtime.

- Enabling Metrics in the DCS library
- Adding a Metrics Port
- Subscribing to the Metrics Service
- Collecting and Processing Metrics

### Enabling Metrics in the DCS library

The DCS libraries installed with Connexis are metrics-enabled by default. If you re-build your DCS library, make sure that the metrics service is enabled. For more information on how to configure your libraries, see “Customizing and Porting DCS Libraries” on page 289.

### Adding a Metrics Port

Before you can interact with the Connexis metrics service, you must add a metrics port to the capsule in your model. You can add a metrics port manually or a the Connexis Capsule Configuration Tool.

To add a metrics port manually:

1. Open your model and ensure that the DCS model interface packages are shared (see “Sharing DCS Interfaces” on page 84).
2. Open the package Logical View::RTDInterface.
3. Drag a port from the RTDMetrics protocol into your model capsule and make the port non-wired with notification enabled.

To add a metrics port with the Connexis Capsule Configuration Tool:

1. Use the Connexis Capsule Configuration Tool to configure the newly created port (see “Configuring Connexis Capsules” on page 85).

The newly created and configured port is used to subscribe to the metrics service.

### Subscribing to the Metrics Service

All of the capsules that are subscribing to the Connexis metrics service must create a registration port that realizes the RTDMetrics protocol.

The following list defines the syntax used to register the subscriber port under various circumstances.

- `rTDMetrics.registerSAP("dcs:RTDMetrics");`

This form is used in detailed code to register the subscriber port to the metrics service of the local component instance.

**Note:** There is no "/" in the registration string after the colon.

- `rTDMetrics.registerSAP("dcs://<host>:<port>/RTDMetrics");`

This form is used in detailed code to register the subscriber port to the metrics service of another component instance.

- `dcs:RTDMetrics`

This form is used in the “Registration Override field of the port Specification Sheet. It is used to protect the port when automatic registration is used.

Once the port is bound, you can send the appropriate signals to obtain metrics data as described in the following section, Collecting and Processing Metrics.

### Collecting and Processing Metrics

To obtain metrics from inside your application, you must subscribe to the metrics service. This service is accessible through the RTDMetrics protocol. The interface defined by the the RTDMetrics protocol provides the following functions:

- Turns on/off gathering of raw metrics data
- Obtains metrics data constantly or periodically
- Clears collected metrics data

This interface is asynchronous, and is defined in more detail in Table 55 and Table 56. Table 55 summarizes the output signals sent by the application. Table 56 summarizes the input signals received by the application.

**Table 55** *RTDMetrics Out Signals*

<b>Signals</b>	<b>Description</b>
rtdMetricsCollectOn	Sent by the user application to turn metrics collection on for this session.
rtdMetricsCollectOff	Sent by the user application to turn metrics collection off for this session.

**Table 55** *RTDMetrics Out Signals*

<b>Signals</b>	<b>Description</b>
rtdMetricsClear	Sent by the user application to clear the metrics counter values for all metrics sessions.
rtdMetricsInterval	Sent by the user application to set the time interval at which collected metrics are sent to this session.
rtdMetricsGet	Sent by the user application to request the collection of metrics to this point.

**Table 56** *RTDMetrics In Signals*

<b>Signals</b>	<b>Description</b>
rtdMetricsCollectOnConfirm rtdMetricsCollectOnFail	Response sent by DCS to the user application to confirm/deny turning metrics collection on for this session.
rtdMetricsCollectOffConfirm rtdMetricsCollectOffFail	Response sent by DCS to the user application to confirm/deny turning metrics collection off for this session
rtdMetricsClearConfirm rtdMetricsClearFail	Response sent by DCS to the user application to confirm/deny clearing the metrics storage for all metrics sessions.
rtdMetricsIntervalConfirm rtdMetricsIntervalFail	Response sent by DCS to the user application to confirm/deny setting a time interval at which collected metrics will be sent to this session.
rtdMetricsGetConfirm rtdMetricsGetFail	Response sent by DCS to the user application to confirm/deny request for the collected metrics data.

By default, the DCS does not collect metrics. If you want to collect metrics during your application (for example, collect metrics on activities taking place prior to binding to the metrics service and turning collection on), use command line parameter `-CNXm=1`. This will turn on metrics collection when the DCS starts up. This should be set on the component instance with metrics that you want to collect.



The `RTDStats` and `RTDTransportStats` classes (see package `Logical View::RTDInterface` in your Connexis model) are used to define the metrics data provided by the metrics service. The following diagrams, Class diagram of the metrics classes and Class diagram of the metrics classes illustrate the relationship between the `RTDStats` and `RTDTransportStats` class and displays the corresponding methods and attributes.

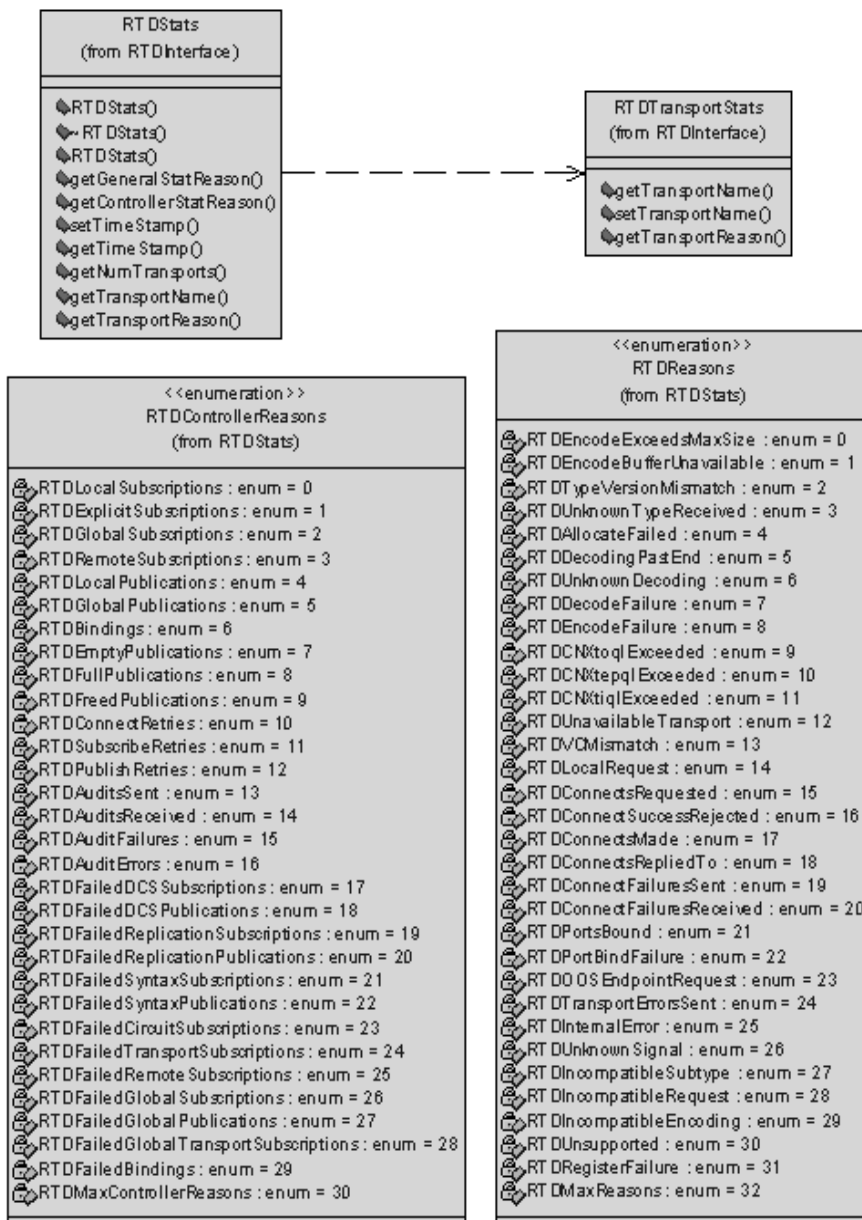
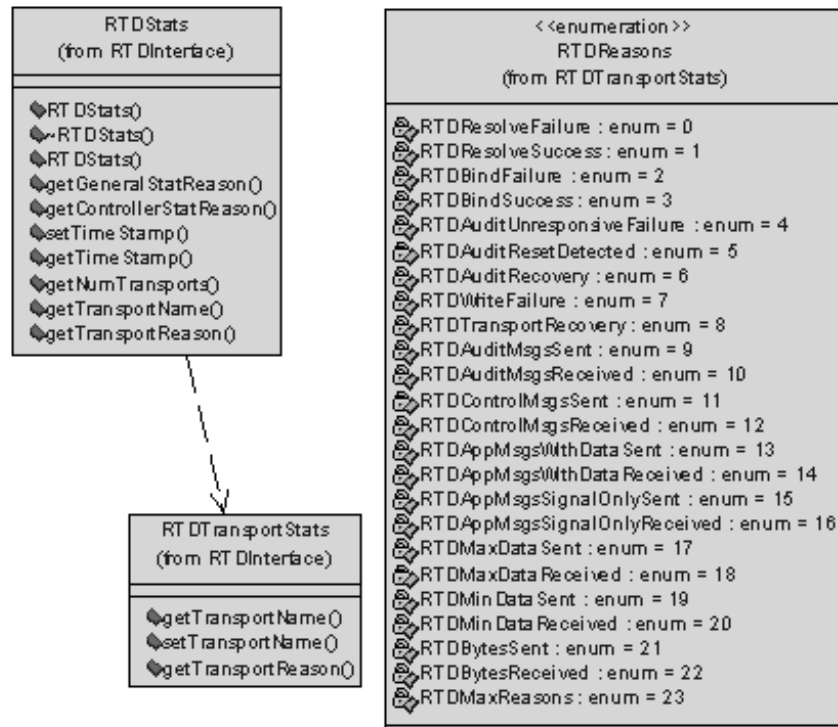


Figure 111 Class diagram of the metrics classes

The class diagram Figure 111 continues on Figure 112, showing the attributes of the RTDTransportStats class.



**Figure 112** Class diagram of the metrics classes

**Note:** An example of the usage of metrics can be seen in the model *metricsCollector* in the *\$RoseRT\_Home/CONNEXIS/C++/examples* directory.

## Using Metrics and the Connexis Viewer

Another way of obtaining metrics information on a component instance is by using the Connexis Viewer. Metrics collection is turned on when the metrics window opens. If you want information on metrics collected prior to the opening of the metrics window, specify the `-CNXm=1` command line argument on the component instance being monitored. This turns metrics collection on as soon as DCS starts.

The Viewer can be used at the same time as the metrics service that you registered. You can obtain metrics data from the metrics service and from the Viewer.

**Note:** *All the metrics sessions are updated when the metrics counters are reset from the Viewer or via the port interfaces.*



## Chapter 9

# Registration String Grammar

Registration String Grammar provides information on the Backus-Naur Form (BNF) Grammar for the registerSAP and registerSPP commands.

You can use the grammar below to validate your registration strings.

### Registration String Grammar for DCS Registrations

```
<dcx registration string> ::= dcs:[[<endpoint>]/]<service name>[(<option list>)]
```

```
<option list> ::= <option> [ <option list> ]
```

```
<option> ::= (locator_rank, integer)
           | (locator_transport, transport)
           | (connect_retries, integer)
```

```
<endpoint> ::= <cdm endpoint> | <custom endpoint>
```

```
<cdm endpoint> ::= cdm://<host>:<port>
```

```
<crm endpoint> ::= crm://<host>:<port>
```

```
<host> ::= host name | ip address
```

```
<custom endpoint> ::= <protocol name>://<address>
```

```
<service name> ::= <name>
```

```
<protocol name> ::= <name>
```

```
<address> ::= <restricted string>
```

`<port> ::= integer between 0 and 65535`

`<name> ::= alphanumeric string with optional underscores ("_")`

`<restricted string> ::= string without`

- comma ","
- parenthesis "(" or ")"
- white space



---

## Chapter 10

# Connexis Command Line Options

---

Command Line Options provides information about commonly-used combinations for specifying endpoints and locator options. Those combinations are:

- Component Instance with Fixed Endpoints (no locator service)
- Component Instance using CDM Endpoint, Locator using CDM
- Component Instance using CDM and CRM Endpoints, Primary Locator using CDM, Backup Locator using CRM
- Component Instance with CDM and CRM, CRM is Preferred Transport
- Miscellaneous Command Line Options

## Component Instance with Fixed Endpoints (no locator service)

---

**How do I configure my Connexis-enabled component instance so that it is using a single transport for a given component instance?**

**CDM:**

`-CNXep=cdm://<host>:<port>` (*recommended*)

For example: `-CNXep=cdm://alpha:3000`

**-OR-**

`-CNXep=cdm:<port>`

For example: `-CNXep=cdm:3000`

**CRM:**

-CNXep=crm://<host>:<port>

For example: -CNXep=crm://alpha:4000

**-OR-**

-CNXep=CRM://100.200.250.50:4000

*Note:* You need to specify the corresponding registration string in the registerSAP and registerSPP in your application.

**How do I configure my Connexis-enabled component instance so that it is using multiple transports for a given component instance, for example, CDM + CRM and so on?**

*Note:* CDM and CRM can only listen on one port each.

**CDM & CRM:**

-CNXep=cdm://<host>:<port> -CNXep=crm://<host>:<port>

For example: -CNXep=cdm://beta:10020 -CNXep=crm://beta:12200

---

## Component Instance using CDM Endpoint, Locator using CDM

---

**How do I configure my Connexis-enabled application so that it is using CDM or CRM for a given component instance and a single locator using the same transport?**

**Component instance with the locator:**

-CNXep=cdm://<host>:<port> -CNXlp

For example: -CNXep=cdm://gamma:11000 -CNXlp

**Component instance using the locator:**

In the example below, it is not mandatory to specify the -CNXep parameter when using CDM (for example, -CNXep=cdm); however, it is an example of good practice. You must specify this option when using explicit connections or if you wish to use the Connexis Viewer for tracing events and debugging.

-CNXep=cdm://<host>:<port1> -CNXlpep=cdm://<locator\_host>:<port2>

For example: -CNXep=cdm://theta:12000 -CNXlpep=cdm://gamma:11000



**Note:** For CRM, replace `CNXep=cdm` with `CNXep=crm`, and `CNXlpep=cdm` with `-CNXlpep=crm` in the examples above.

## Component Instance using CDM and CRM Endpoints, Primary Locator using CDM, Backup Locator using CRM

---

**How do I configure my Connexis enabled application so that it is using multiple transports and primary and backup locators?**

### Component instance with the primary locator:

```
-CNXep=cdm://<host>:<port1> -CNXep=crm://<host>:<port2> -CNXlp  
-CNXlbeep=crm://<backup_loc_host>:<port3>
```

For example:

```
-CNXep=cdm://alpha:8000 -CNXep=crm://alpha:8500 -CNXlp  
-CNXlbeep=crm://beta:9500
```

### Component instance with the backup locator:

```
-CNXep=cdm://<host>:<port4> -CNXep=crm://<host>:<port3> -CNXlb  
-CNXlpep=cdm://<primary_loc_host>:<port1>
```

For example:

```
-CNXep=cdm://beta:9000 -CNXep=crm://beta:9500 -CNXlb  
-CNXlpep=cdm://alpha:8000
```

### Component instance using the primary and backup locator:

In the example below, it is not mandatory to specify the `-CNXep` parameter when using CDM (for example, `-CNXep=cdm`); however, it is an example of good practice. You must specify this option when using explicit connections or if you wish to use the Connexis Viewer for tracing events and debugging.

```
-CNXep=cdm://<host>:<port5> -CNXep=crm://<host>:<port6>  
-CNXlpep=cdm://<primary_locator_host>:<port1> -CNXlbeep  
=crm://<backup_loc_host>:<port3>
```

For example:

```
-CNXep=cdm://gamma:10000 -CNXep=crm://gamma:10500  
-CNXlpep=cdm://alpha:8000 -CNXlbeep=crm://beta:9500
```

## Component Instance with CDM and CRM, CRM is Preferred Transport

---

### **How do I configure my Connexis enabled application so that CRM is the preferred transport?**

To make crm-based connections when other transports are also available, you can specify **CNXlpt=crm** at the primary and backup locators. The default is CNXlpt=cdm.

#### **Component instance with the primary locator:**

```
-CNXep=cdm://<host>:<port1> -CNXep=crm://<host>:<port2>  
-CNXlpt=crm -CNXlp -CNXlbep=crm://<backup_loc_host>:<port3>
```

For example:

```
-CNXep=cdm://alpha:8000 -CNXep=crm://alpha:8500 -CNXlpt=crm  
-CNXlp -CNXlbep=crm://beta:9500
```

#### **Component instance with the backup locator:**

```
-CNXep=cdm://<host>:<port4> -CNXep=crm://<host>:<port3>  
-CNXlpt=crm -CNXlb -CNXlpep=cdm://<primary_loc_host>:<port1>
```

For example:

```
-CNXep=cdm://beta:9000 -CNXep=crm://beta:9500 -CNXlpt=crm  
-CNXlb -CNXlpep=cdm://alpha:8000
```

**Note:** *If you wanted an crm-based connection (for example: crm) for a specific port, you can specify (locator\_transport, crm) as part of the registration string in the RegisterSAP call.*

## Miscellaneous Command Line Options

---

### **Can I specify different encoding, for example, CDR or ASCII, for different transports?**

No. Encoding applies to a component instance, and not per transport or per end point. As such, it is possible for component instance A to specify CDR encoding, and component instance B to specify ASCII encoding. In essence, the two component instances can talk to each other using two different encoding schemes. Each component instance can receive either format but send only the configured one.

Each encoding scheme has its advantages and disadvantages. For example, CDR is faster than ASCII. On the other hand, ASCII is easier to debug.

To indicate encoding preference, use the following:

**CDR:**

`-CNXtde=2` (this is the default)

**ASCII:**

`-CNXtde=1`

For example:

`-CNXep=10020 -CNXep=crm://localhost:13000`

`-CNXlpep=cdm://alpha:10000 -CNXlbep=crm://beta:11000 -CNXtde=1`

### When do I need to supply a CNXep?

You need to supply a CNXep when you want to listen at a pre-determined CDM port, for example:

- when you want to provide a service using the CDM transport, and clients of your service are not using the locator to resolve your location. In this case, when you start your component instance that provides the service, you need to supply the endpoint. That is, it will be listening at a pre-determined CDM port, for example, `-CNXep=9000`. You can then have the clients register for it specifying the pre-determined location of the service. For example, consider Application A, which provides service foo, it is started with a `-CNXep=9000` and does `registerSPP(dcs:foo)`. Now another application B wants to use this service. When B does the `registerSAP`, it uses `dcs:cdm://<host>:<port>/foo`. By having Application A listen at a pre-determined port (9000), it is easier to provide that information to Application B, such as via a command line argument, in a config file, and so on
- when a component instance provides locator services for other component instances (`-CNXlp`) which use the CDM protocol. You want to have it listen at a specific CDM port so that when you start those other component instances, you will know the port number to supply in the `-CNXlpep` and `-CNXlbep` parameters. You can also specify `"-CNXep"`, `"-CNXep=0"`, `"-CNXep=1"`. All of these result in a free port being selected. As well, if the port number you have provided is non-numeric, or outside the range of 0..65535, it is ignored and a free port is selected
- when you want to use the Viewer against that component instance

### **Can I use localhost or 127.0.0.1 for specifying endpoints? Are there any side effects?**

On Windows NT, `localhost` (defined in `C:\WINNT\system32\drivers\etc\Hosts`) is set by default to `127.0.0.1`, and refers to the machine on which the application is executing. `localhost` provides a convenient shorthand for referring to the host machine, while maintaining portability across Windows NT. You can use `localhost` in Connexis registration strings locally, that is, between subscribers and publishers residing on the same Windows NT machine. You cannot use `localhost` or `127.0.0.1` for registration across node boundaries, for example, for registering a subscriber on VxWorks against a publisher on a Windows NT target.

Explicit SAP registration for CDM with address `localhost` or `127.0.0.1` (for example, `"dcs:cdm://127.0.0.1:12345/foo"`) always results in a local loopback connection, regardless of whether or not the `CNXtluc` flag is set. It will never result in a direct local bind to the SPP.





---

## Chapter 11

# Connexis Messages, Errors, and Warnings

---

Where possible, Connexis provides detailed informational messages, errors, and warnings to make your development and debugging tasks easier. Three groups of messages are:

- Initialization Messages
- Initialization Errors
- Parameter Errors

### Initialization Messages

The following provides a description of some of the more common informational messages displayed by Connexis on startup.

**Table 57** *Connexis informational messages*

<b>Output</b>	<b>Description</b>
dcx: transport listening at [endpoint] <b>Note:</b> <i>The transport could be cdm, crm or your own customized transport.</i>	This is output once the transport starts up and begins listening at the endpoint. If it does not appear, your transport was probably not included.
dcx:CNXcmrs set to [size]	CDM maximum receive size specified was larger than the largest buffer available. Check your use of CNXtbp.
dcx:CNXtfms set to [size]	Transmit first message size was larger than the largest buffer available or the max message size. Check your use of CNXtmts and CNXtbp.

---

**Table 57 Connexis informational messages**

<b>Output</b>	<b>Description</b>
dcx:***** CNX endpoint port not specified - free port will be selected *****	Connexis will choose an unused port on which the CDM transport will listen.
dcx: target agent enabled	Indicates that the target agent is running. The target agent must be running if you want to use the Connexis Viewer.
dcx: locator running as primary	Confirmation that the locator was linked into the executable and is configured as primary.
dcx: locator running as backup	Confirmation that the locator was linked into the executable and configured as backup.
dcx: local locator not running (CNXlp or CNXlb required)	You are using one of RTDBase_Locator or RTDBase_Locator_Agent in your model. The locator was linked into the executable but has not been configured.
dcx: locator service not available	The locator is not available based on configuration parameters.
dcx: metric service enabled	This indicates that the metrics service is enabled.
dcx: connecting to primary locator at [endpoint] dcx: connecting to backup locator at [endpoint]	These two lines are output as a pair and indicate that the primary locator is remote (CNXlp) and the backup locator is remote as well (CNXlb).
dcx: ***** Parameter [<old parameter name>] not supported. Please use [<parameter name>=<value>] *****	Indicates that a parameter that is not supported with the current release has been used. When the DCS encounters a command line argument that is no longer supported, the DCS internally converts the parameter to the new format and indicates the new usage to the user.



## Initialization Errors

- The following banner is output in case of initialization failure:

```

dcs: *****
dcs: **** initialization failure - dcs not available ****
dcs: *****
dcs: **** banner provided for diagnosis purposes ****
dcs: **** use CNXd to display configuration ****
dcs: *****
dcs: !!!!! system failure when initializing the : <step> (<error>) !!!!!

```

where <step> is one of

- configuration: problem in parsing parameters
  - target agent: refers to target agent for Viewer
  - transport-capsule: refers to transport router
  - transport-callback: refers to the transport callback thread (input)
  - transport-helpers: refers to the transport helper thread (output)
  - controller: refers to registration control
  - locator: refers to the Connexis locator service
  - system: any other general error
- CDM failed during initialization - check port number

The error is caused by an inaccurate specification of the CNXep=<port> command line parameter. Check your CNXep specification.

Technically descriptive error messages have been added at points at which the initialization of the DCS could fail. These would most likely only be encountered if the system resources were not sufficient to handle the demands of the DCS system. Another use would be to quickly narrow down and pinpoint a startup error while performing a port of the DCS libraries to another platform.

## Parameter Errors

The following errors may be reported in case of a misconfiguration of the command line parameters.

**Table 58 Command line parameters misconfiguration errors**

<b>Output</b>	<b>Description</b>
dcs: **** multiply defined parameter [<name>=<value>] ignored ****	The following error is reported if you try to use a command line parameter multiple times with a component instance.
dcs: **** unknown parameter [<name>=<value>] ignored ****	The parameter you have specified is not a valid parameter. This check is performed for all parameters starting with CNX. For more information, see “Command Line Options Reference” on page 274. You can also output the list at runtime by specifying <i>CNXhelp</i> as a command line option.
dcs: **** CNXendpoint invalid port [<value>] ****	The port number specified for CNXep is invalid (non-numeric).
**** CNXendpoint (CNXep) invalid port [port #] - freeport will be selected ****	The end port specification contains a syntax error. Connexis will choose the port on which to listen.
dcs: **** # of mblks less than # of buffers in buffer pool ****	The Connexis Transport buffer pool is not setup properly. Check your use of <i>CNXtbp</i> .
dcs: **** Not enough buffers in buffer pool specified ****	The Connexis Transport buffer pool is not setup properly. Check your use of <i>CNXtbp</i> .
dcs: **** invalid buffer pool specified ****	The Connexis Transport buffer pool is not setup properly. Check your use of <i>CNXtbp</i> .
dcs: **** CNXcurs = UDP system receive buffer size must be > max receive msg size - using target default ****	UDP buffers are not properly engineered.
dcs: **** CNXcuts - UDP system Tx buffer size smaller than max buffer size defined in buffer pool - using system default ****	UDP buffers are not properly engineered.

**Table 58** *Command line parameters misconfiguration errors*

<b>Output</b>	<b>Description</b>
dcS: ***** CNXlpep ignored (CNXlp takes precedence over CNXlpep) *****	You are trying to specify a component instance as a primary locator, and at the same time, trying to tell it where to find the primary locator.
dcS: ***** CNXlb ignored (CNXlp takes precedence over CNXlb) *****	A component instance can either be a primary locator or a backup locator but not both.
dcS: ***** CNXlbep ignored (CNXlb takes precedence over CNXlbep) *****	You are trying to designate the component instance as the backup locator, and at the same time trying to point it to where the backup locator is located.
dcS: ***** CNXlp ignored (locator not present) *****	You are not using RTDBase_Locator or RTDBase_Locator_Agent in your model. One of these must be used to avail the locator capabilities.
dcS: ***** CNXlb ignored (locator not present) *****	You are not using RTDBase_Locator or RTDBase_Locator_Agent in your model. One of these must be used to avail the locator capabilities.
dcS: ***** CNXlpep missing (CNXlpep mandatory at backup locator) *****	You must specify a primary locator for the component instance with the backup locator.
dcS: ***** CNXlpep missing (CNXlpep mandatory when using backup locator) *****	You must specify a primary locator when using the backup locator capabilities.





## Chapter 12

# Connexis Customization Reference

---

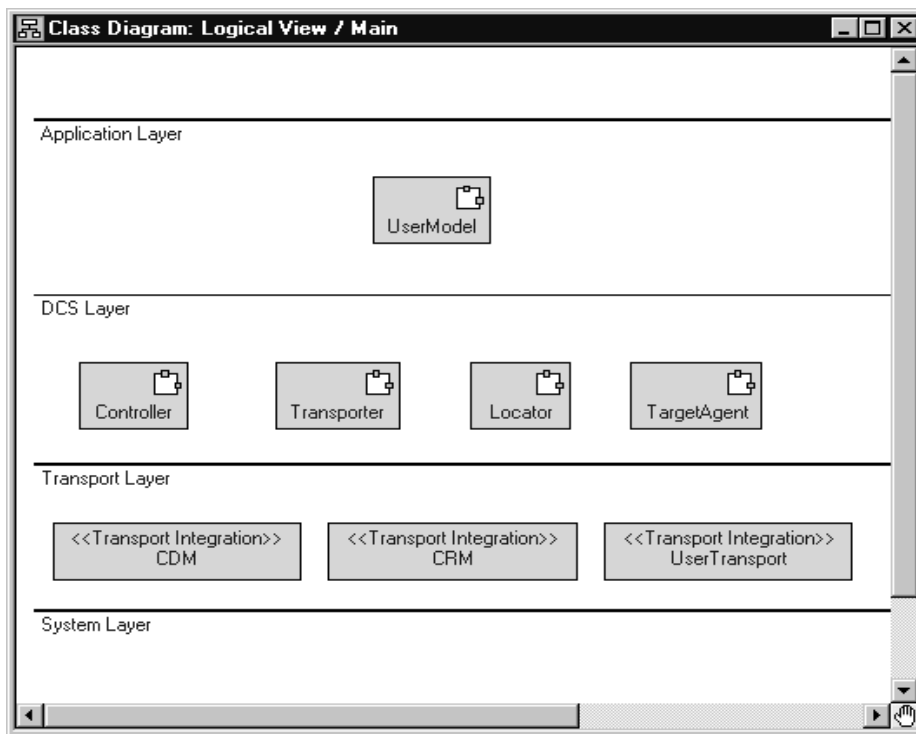
Connexis is a general purpose communication tool that can be customized to suit your needs. To make Connexis as adaptable as possible, multiple configuration parameters are provided and are described herein:

- **Engineering Rules Overview** - outlines the high-level configuration of the Connexis tool and describes the different components that can be configured. References are made to the detailed options that are presented in later sections.
- **Command Line Options Reference** - details the command line options that are available for configuring Connexis.

A summary of the parameters, outlining what behavioral aspects are affected by which parameters, is presented in the *Engineering Rules Overview* topic. For example, to find out what parameters can be used to reduce the memory used by the application, refer to the *Engineering Rules Overview* topic.

## Engineering Rules Overview

This section presents the high-level design of the Connexis tool and outlines aspects of the tool that can be configured using the options that are presented later in this chapter. Figure 113, illustrates the high-level architecture of a Connexis application. The following sections detail the aspects of the Connexis design that can be configured.



**Figure 113 DCS high-level design**

## Thread Configuration

The thread design of your application can have a significant impact on performance and on the resources that are required by your application. The following sections describe the thread usage in each of the layers:

- Process view of a Connexis application
- The application layer

### **Process view of a Connexis application**

This section describes the overall process view of a Connexis application.

The process view shown in Figure 114 illustrates the thread configuration for every Connexis component in a distributed application. If a distributed application had five Connexis components, each individual node would have a process view similar to that shown in Figure 114. The Controller\_Locator capsule runs on the thread on which the Connexis capsules that you are using (for example, RTDBase, RTDBase\_Agent, RTDBase\_Locator, or RTDBase\_Locator\_Agent) are incarnated.

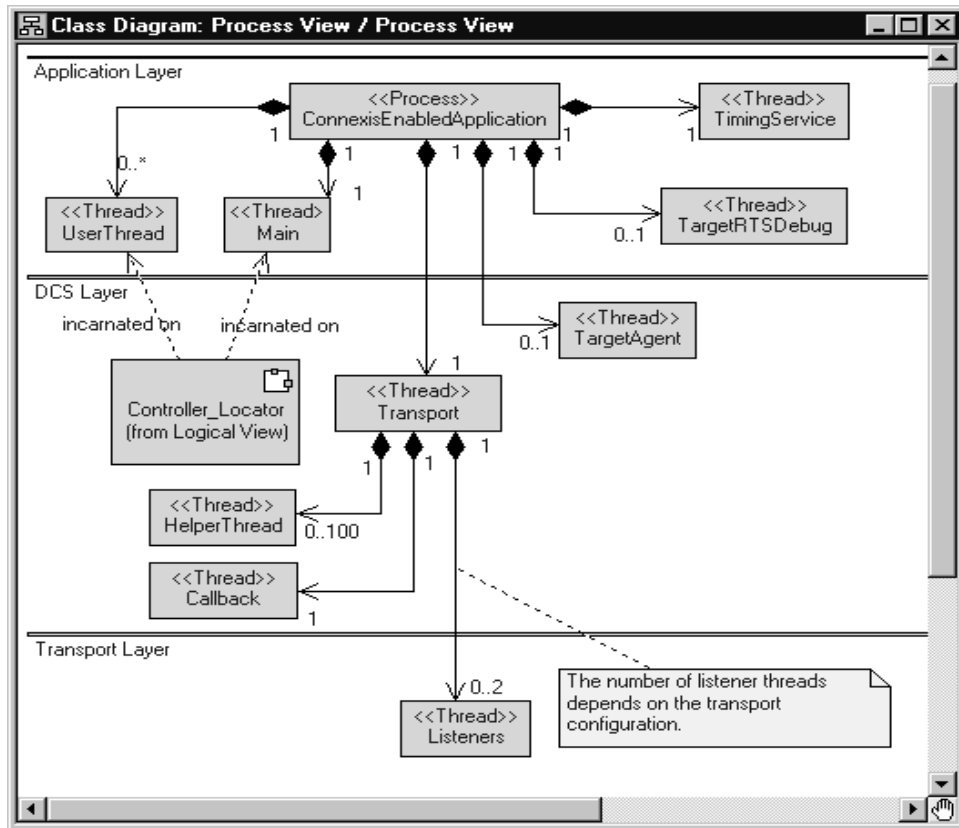


Figure 114 Connexis process view

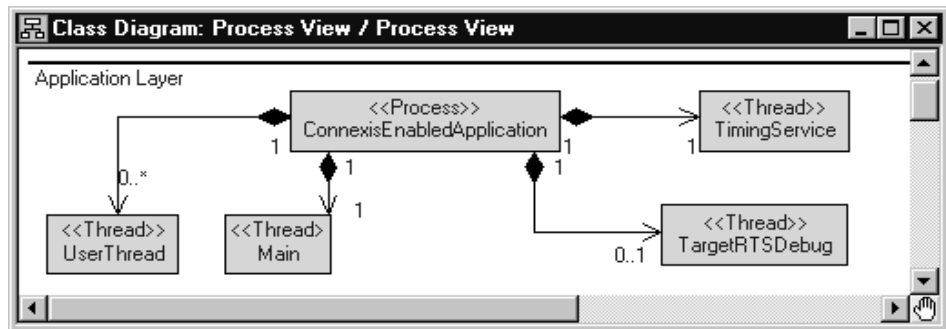
### Default number of threads

The number of user threads that exist in a particular Connexis component is determined by the requirements and design of the component. The number of helper threads associated with the Transport component is configurable but defaults to five. When the CDM or CRM transports are enabled, but are not configured to run on the tread of the transporter, additional threads are incarnated for each transport.



## The application layer

The Application layer consists of the threads that are used by the Rose RealTime Target RSL and the threads that are part of the design of the application. This configuration is illustrated in the following class diagram.



**Figure 115 Thread configuration of Application layer**

By default, there are only three threads created in a Rose RealTime model: the TimingService thread, the TargetRSLDebug thread, and the Main thread. The Main thread is where all application code is executed by default. The user model may contain any number of user threads. This is dependent on the design that has been created.

## DCS and transport Layer

The thread priorities for the threads in the DCS and Transport layers can be specified by using the following configuration options:

- Transporter - The priority of the main Transport thread is configured using the CNXtran\_thread\_priority (CNXttp) option.
- TargetAgent - The priority of the TargetAgent thread is configured using the CNXagent\_thread\_priority (CNXatp) option.
- helper thread priority - The priority of the helper threads is configured using the CNXtran\_helper\_thread\_priority (CNXthtp) option. This defaults to a priority that is higher than the transport thread.

**Note:** The “Callback” thread does not run and has no thread priority associated with it. It is provided so that the transport integration “callback” operations can send messages to the transporter capsule.

The thread priorities of the built-in transports (ex.: CDM and CRM) can be configured using the CNXtran\_priority (CNXtp) option. When applicable, user integrated transports are also be configured using the CNXtran\_priority option. If this option is not specified, the default value is the thread priority of the transporter (CNXtran\_thread\_priority).

The DCS Controller and Locator components are on the same thread and run on the thread that the DCS top-level capsule is incarnated.

The Transport Capsule contains a number of threads that are referred to as “helper” threads. The helper threads are used to handle any transport operations that are potentially blocking. The CDM and CRM transports use the helper threads to resolve host names supplied in explicit registrations. The CRM transport uses the helper threads when writing data to an endpoint.

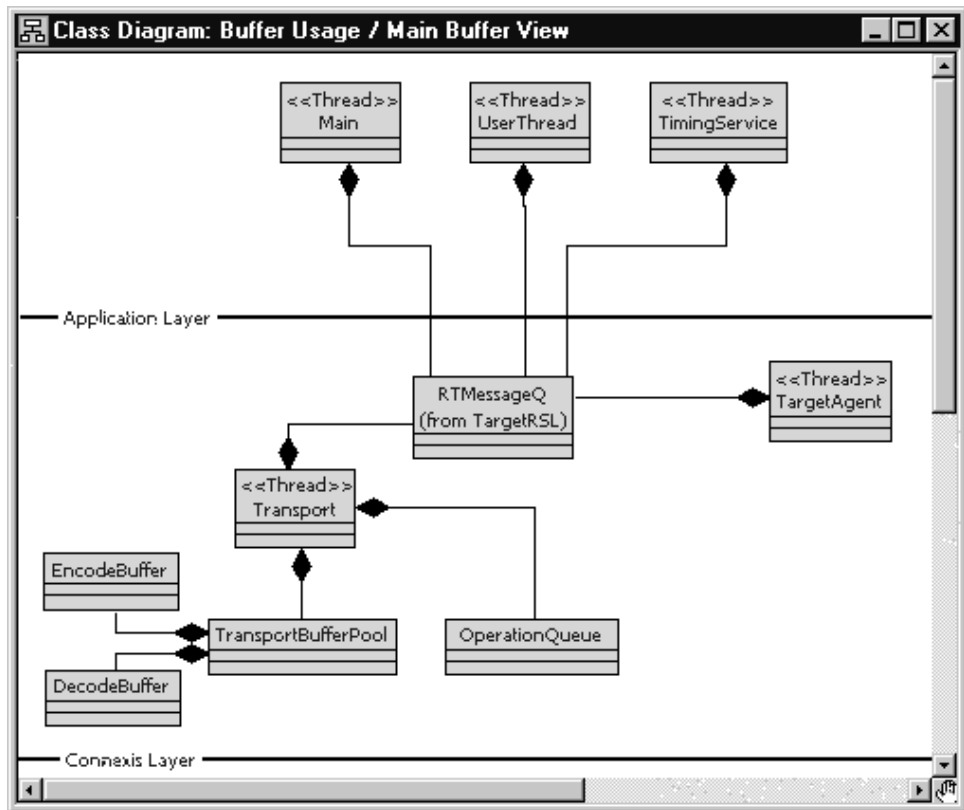
The number of helper threads is configured using the “CNXtran\_helper\_threads” command line option. The default value for this option is 5. The maximum number of helper threads that can be configured is 100. Setting CNXtht to a number greater than 100 results in only 100 helper threads being created.

## Buffer Configuration

In addition to the threads that are being used by Connexis, there are areas of the design where buffers are being used. These buffers are typically being used to buffer data that is either being sent or received from different processes in the distributed application. The size and number of many of these buffers is configurable. This section illustrates Connexis’ buffer usage and details where optimizations can be made by using configuration options.

### Overall buffer configuration of a Connexis application

This section describes the overall buffer usage of a Connexis-enabled application. Specific options that can be used to configure these buffers are presented in the following sections. A class diagram showing the overall buffer usage is presented in Figure 116.



**Figure 116** Buffer usage in Connexis application

### Application layer

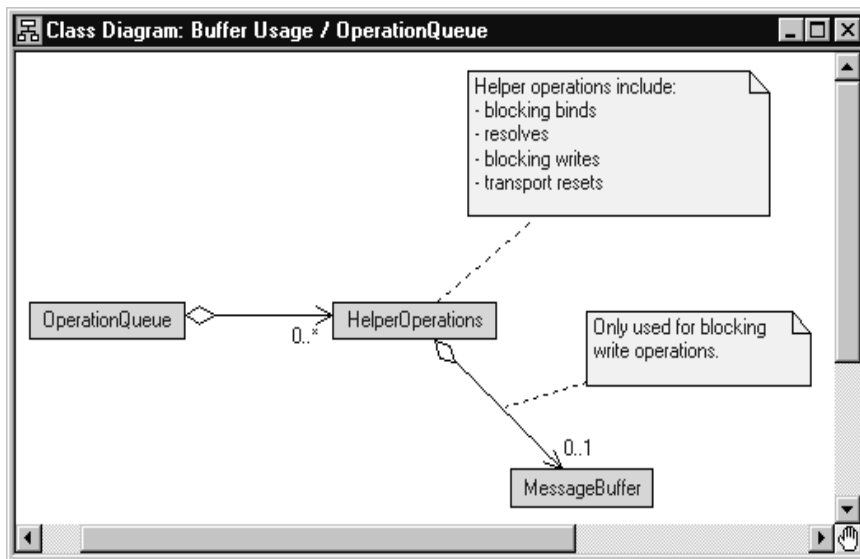
All of the message buffering that occurs in the Application layer is using the built-in Rose RealTime queuing mechanism. In this queuing scheme each thread in a Rose RealTime model has a priority queue. This queue maintains all of the messages that are destined for the capsules that are running on the thread and that have not been delivered yet. Connexis does not add any extra buffers in these cases.

## DCS layer

Most of the messaging that occurs in the DCS layer uses the built-in Rose RealTime message queues. The Transport capsule also maintains a transport buffer pool, and an Operation Queue. The transport buffer queue and the Operation Queue are used to buffer data and control messages that are being transmitted or received over a transport.

The buffers used for encoding and decoding are obtained from the buffer pool. The default buffer sizes that are allocated from the buffer pool for encoding and decoding are configured using the CNXtran\_first\_msg\_size (CNXtfms) and the CNXtran\_max\_transmit\_size (CNXtmts) of the transport. In the case of CDM, a decode buffer is reserved from the buffer pool and its size is configured using the CNXcdm\_message\_receive\_size (CNXcmrs) option.

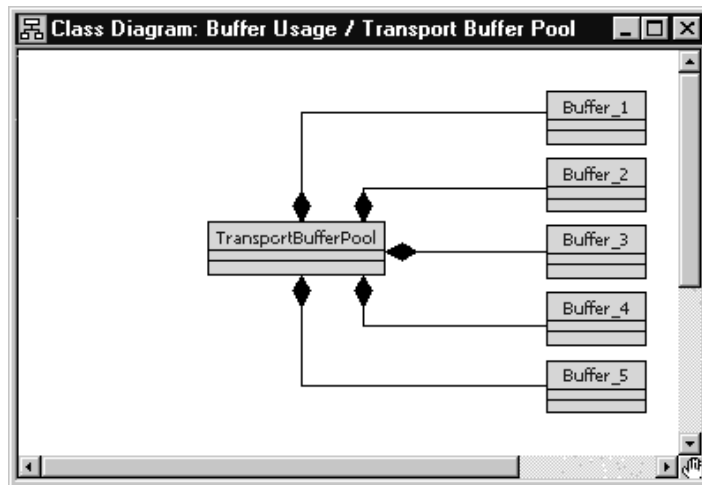
The design of the Operation Queue is illustrated in Figure 117.



**Figure 117 Operation Queue design**

The Operation Queue is used to buffer transport operations that are received while an endpoint is binding or being resolved. The size of the Operation Queue is specified using the CNXtran\_out\_queue\_limit (CNXtoql).

The transport commands that are queued are bind commands, which do not require a buffer and write commands. Some of the write commands require message buffers to hold the message payload. Specifically, if the message has data that is not sent using send scalar, a message buffer is required. The message buffer is retrieved from the transport buffer pool. The design of the transport buffer pool is shown in Figure 118.



**Figure 118** *Transport Buffer Pool design*

The Transport Buffer Pool maintains a set of buffers of varying sizes. When an transport integration write requires a buffer, the Transport Integration encodes the data into a buffer that it obtains from the Transport Buffer Pool. The encode is done in a buffer that most closely matches the size of the encoded data. This means that the encode is using a best fit algorithm to find the appropriate buffer.

The size and number of the different buffers in the buffer pool is configurable using the CNXtran\_buffer\_pool (CNXtpb) configuration option. The default value of this option is 64:1,600:10,4200:10,17000:2,32860:2,33000:2. This means that, by default, the buffer pool creates:

- 1, 64 byte buffer
- 10, 600 byte buffers
- 10, 4200 byte buffers

- 2, 17000 byte buffer
- 2, 32860 byte buffer
- 2, 33000 byte buffers

If the buffer size is not double word aligned, Connexis rounds up to the next double word boundary. In addition, each buffer has an overhead of 24 bytes associated with it due to its buffer control block. This means that the total amount of memory that is consumed by this configuration is:

- $(64 + 24) \times 1 = 88$
- $(600 + 24) \times 10 = 6240$
- $(4200 + 24) \times 10 = 42240$
- $(17000 + 24) \times 2 = 34048$
- $(32864 + 24) \times 2 = 65776$
- $(33000 + 24) \times 2 = 66048$

For a total of 214440 bytes.

### Connexis buffer usage

This section describes the strategies that are used by CDM Transport Integration to select buffers from the transport buffer pool for the different types of messages that can be sent. Table 59 presents the different types of messages that Connexis sends and their corresponding starting buffer sizes and maximum buffer sizes. Table 59 also indicates if the Operation Queue is used for a particular message type. The general algorithm that is used for all message types is that Connexis starts by trying to get a buffer that satisfies the criteria listed in the Starting buffer size column. If a free buffer of that size is not available, the next largest buffer available is used as long as its size is not greater than the value listed in the Maximum buffer size column.

If a buffer of that size cannot be found, Connexis looks for a larger buffer. This continues until the size of the buffer being requested is greater than the value listed in the Maximum buffer size column.

If your application is only using CDM, configure Connexis according to the following information:

- There is one decode buffer large enough to hold the biggest message that your application will receive. Use the `CNXcmrs` command line option to configure the receive buffer.

**Table 59 Buffer sizes used by different message types**

Message Type	Queue Used?	Starting buffer size	Maximum buffer size
CDM Audit	No	40 bytes	not applicable
CDM data	No	CNXcmts <sup>a,c</sup>	CNXcmts
CDM Control	No	CNXcmts <sup>a</sup>	CNXcmts

<sup>a</sup>If a free buffer that is  $\geq$  CNXtmts is not available and CNXtfms is  $<$  CNXtmts, Connexis re-attempts to obtain a buffer using the CNXtfms as the starting buffer size.

<sup>c</sup>Connexis encoding starts with a buffer that is  $\geq$  the size specified in the Starting buffer size column. If the encoded data exceeds the buffer size, a buffer twice as large is obtained (subject to the maximum buffer limit dictated) and the smaller buffer is released. Encoding continues with this process until a buffer cannot be obtained, or the encoded size exceeds the maximum encoded data size, or all of the data is encoded.

- There is one encode buffer large enough to hold the biggest message that your application will send. Use the CNXtmts command line option to configure the transmit buffer.
- There are a number of buffers that are approximately 400 bytes in size that can be used to hold queued connection requests. This is only required if host names are being used. If your application uses IP addresses these buffers are not required.

## Configuring the Number of Virtual Circuits

The pre-built Connexis library has a fixed number of virtual circuits which a Connexis-enabled model can use at run-time. The fixed number (200) is suitable for most applications and reduces the memory footprint of the run-time application.

If your application uses more than 200 connections, you must increase the number of connections, re-build your Connexis library and re-link your application.

To increase the number of virtual circuits:

1. Open the DCS model (\$ROSERT\_HOME/CONNEXIS/Model/DCS.rtmdl).
2. Open the specification for the Logical View::DCSComponents::DCSSysConfig::RTDConstants class.
3. Open the specification for the attribute rtdMaxCircuits.

4. Change the constant's default value from 200 to a number appropriate for your requirements.
5. Rebuild the Connexis library from the changed DCS model and link your application with the newly built library.

### Verifying Connections

The Audit functionality verifies that the connection is up and that the connection is in a state that allows it to go back into service. There are three types of periodic audits (handshake, connection, and none) and a reset audit available. The transport can also report when it has failed and when it has recovered.

With periodic audits the length of the audit period of a connection depends upon the current state of the connection. It is a function of the `auditISGranularity`, the `auditOOSGranularity` audit configuration options and the length of the `CNXtap`. The length of the `CNXtap` is the multiple of `CNXtap`  $\geq$  the granularity depending on the state.

#### Handshake audit

This audit determines when a transport has gone out of service. The handshake audit is usually used when the transport can not notify you that it has gone out of service through send return code or asynchronous notification of a failure.

Once a transport goes out of service, messages are sent until it goes back into service. The audit can be configured so that a re-resolve is triggered when out of service. If the address was originally unresolved then it will be reresolved and rebound.

Are You Alive (AYA) messages are sent and I Am Alive (IAA) response messages are expected in return. A handshake exchanges between two end points. If `piggyBackEnabled` is on, messages that are received count as IAA responses as well. The response must be received before the next audit period of the connection is over. If it is not received, the audit period is considered failed. The `auditsFailedForOOS` identifies the number of consecutive failed audit periods that may occur before the connection is considered failed. When a connection has failed `auditsPassedForIS` identifies the number of consecutive success audit periods needed for the connection to resume service. A successful audit period is one in which an IAA response is received for an AYA message.



AYA messages are sent only when messages have not been received from the other side during the last audit period. If messages have been received, during the period, but no messages were sent, IAA message are sent. This is an optimization to prevent the other side from having to send an AYA message in order to trigger this side to send a message.

YANTxEnabled identifies whether You Are Not Responsive (YAN) messages should be sent when a transport is going out of service. YANRxForceOOS indicates whether a received YAN message should trigger the current connection to go out of service. These are useful for keeping both ends of a connection in sync. It allows one side to notify the other that it considers the connection to be down, allowing the other side to release its resources.

### **Connection audit**

Connection audit generates messages during quiet periods, to monitor the status (up or down) of the transport.

During an audit period, if the connection is in service and no messages are sent or received, then an IAAnoise audit message is sent. If the transport is experiencing a failure, the message sends fails and the connection transitions to out of service. The recovery configuration defines how to put the transport back into service. When the transport has failed, the connection audit does not run.

### **Reset audit**

The Reset audit is used primarily in situations where the endpoint goes up and down faster than the audit can detect. When an application starts up it assigns itself a unique ID based on the clock and its IP address. This value is sent in all messages and to all destinations. If the reset audit is enabled and a message arrives from the sender with a different ID, it is decided that the sender has failed and has been restarted. All SPPs are released and all SAPs will rebind to an SPP. To use the Reset Audit with a connection-oriented transport, the transport needs to have the ability to release and then re-establish a connection to the same endpoint. If your network does store and forward messages, you may not want to use the reset audit either. In a store and forward network, it is possible old messages turn up with the old id and result in a working connection being taken down and restarted unnecessarily.

A reset audit check takes place when connection establishment messages are exchanged and when audit messages are exchanged. It is recommended that you use reset audit with handshake audits.

If your network does store and forward messages, you may not want to use the reset audit either. In a store and forward network, it is possible old messages turn up with the old id and result in a working connection being taken down and restarted unnecessarily.

## Command Line Options Reference

---

There are several areas where the performance and behavior of Connexis can be modified. The key areas are:

- System wide - options that do not apply to a specific component
- DCS - options that apply to the DCS
- Transporter options that apply to the transporter sub-system and affect all registered transports.
- Transport specific parameters -options that apply to a particular transport
- Target RSL - options that apply to the Rose RealTime Target RSL
- Locator - options that apply to the Connexis Locator
- Connexis Viewer / Target Agent - options that apply to the Connexis Viewer application and its target component

Options applying to each of these components are discussed in the following tables. Background information that is necessary for making the design trade-off decisions is also presented. Each set of configuration parameters is presented in a table format that outlines the name of the option, the argument type, a description of what the option does, and a default value.

## Setting Command Line Options

The general approach for using all of the mentioned command line options is to specify them on the command line. If this is not possible on your target platform, you must set the values of argv and argc using a supported method.

All of the global command line options that have arguments are set using the following syntax:

`<appname> -<command_line_option>=<value>`

The transport specific command line options that have arguments are set using the following syntax:

`<appname> -<command_line_option>=<transport name>:<value>`

The command line options that do not have arguments are set using the following syntax:

`<appname> -<command_line_option>`

**Note:** *The command line options are case sensitive (even on Windows NT).*

## System wide

Table 60 lists the options that apply to Connexis as a whole, not to a specific component.

**Table 60 System wide command line options**

Command Line Option	Description
CNXunique_id   CNXui	<p>This option is used to set a unique identifier for a Connexis endpoint. If this option is not specified by the user, Connexis generates a random pattern to use as the unique identifier.</p> <p>It is good practice to assign a logical name to the unique identifier because it makes recognizing the endpoints in the Viewer easier. For example, -CNXui=service1.</p> <p><i>Argument Type:</i> string <i>Default Value:</i> a random pattern</p>
CNXhelp   CNXh	<p>This option causes a brief output of help and default values for user parameters to be printed to the console.</p> <p><i>Argument Type:</i> none <i>Default Value:</i> none</p>
CNXdump   CNXd	<p>This option outputs the final configuration of both the global and transport specific configuration options once DCS has been initialized.</p> <p><i>Argument Type:</i> none <i>Default Value:</i> none</p>

**Table 60 System wide command line options**

<b>Command Line Option</b>	<b>Description</b>
CNXnobanner   CNXnb	<p>If this option is specified, the Connexis banner is not displayed on start up.</p> <p><i>Argument Type:</i> none <i>Default Value:</i> none</p>
CNXmetrics   CNXm	<p>This option allows you to start metrics collection as soon as DCS starts. This lets you collect metrics on activities which take place prior to turning metrics on in the Viewer or programmatically.</p> <p><i>Argument Type:</i> bool <i>Default Value:</i> 0 (false)</p>
CNXpsos_node   CNXpn	<p>This option only applies to the pSOS operating system. The pSOS software architecture allows for an application to be distributed across multiple nodes, each with a unique ID. This option is used by the DCS to identify the node ID on which a component instance is running. The default value assumes that the DCS is running in a single node configuration.</p> <p><i>Argument Type:</i> integer <i>Default Value:</i> 0</p>

## DCS options

The options contained in Table 61 are related to the DCS controller.

**Table 61 DCS command line options**

<b>Command Line Option</b>	<b>Description</b>
CNXdcs_audit_delay   CNXdad	The minimum time between audits for a given virtual circuit in milliseconds.  <i>Argument Type: integer</i> <i>Default Value: 1000</i>
CNXdcs_audit_interval   CNXdai	Minimum interval between auditing virtual circuits in seconds.  <i>Argument Type: integer</i> <i>Default Value: 100</i>
CNXdcs_audit_enabled   CNXdae	Enables or disables the DCS audit feature. If set to non-zero the DCS audit is enabled.  <i>Argument Type: BOOL</i> <i>Default Value: 1</i>
CNXdcs_conn_retry_delay   CNXdcrd	The retry timeout for transport connect messages. The transport name is qualified since this option is transport specific (ex.: -CNXdcrd=cdm:2000).  Time is specified in milliseconds.  <i>Argument Type: integer</i> <i>Default Value: 5000</i>

**Table 61 DCS command line options**

<b>Command Line Option</b>	<b>Description</b>
CNXdcs_retry_delay   CNXdrcd	<p>The retry timeout for transport control messages. The transport name must be qualified since this option is transport specific (ex.: - CNXdrcd=cdm:2000).</p> <p>Time is specified in milliseconds.</p> <p><i>Argument Type:</i> integer <i>Default Value:</i> 5000</p>
CNXdcs_locator_retry_delay   CNXdldr	<p>Specifies the retry delay for locator control messages. This value is expressed in milliseconds.</p> <p><i>Argument Type:</i> integer <i>Default Value:</i> 5000</p>

## Transporter options

Table 62 describes the command line options that are available for modifying the global DCS Transporter configuration settings.

**Table 62 Transporter global command line options**

<b>Command Line Option</b>	<b>Description</b>
CNXtran_num_mbks   CNXtnm	<p>Specifies the number of memory control blocks that are pre-allocated for the buffer pool of the transporter. The default value is the number of memory blocks in the buffer pool, configured using CNXtran_buffer_pool.</p> <p><i>Argument Type:</i> integer <i>Default Value:</i> sum (CNXtbp)</p>
CNXtran_log_bad_msgs   CNXtlbm	<p>If set to true, messages with bad types are logged.</p> <p><i>Argument Type:</i> BOOL <i>Default Value:</i> 1 (true)</p>

**Table 62** Transporter global command line options

Command Line Option	Description
CNXtran_default_local_use_transport (CNXtdlut)	<p>Configures the default transport used when a non-explicit subscription resolves locally. This causes two virtual circuits to be used per local DCS registration.</p> <p><b>Note:</b> Use the Viewer to view local messages. They are valuable for debugging. Local messages are not traceable through any other method.</p> <p><i>Argument Type:</i> string (transport name) <i>Default Value:</i> None</p>
CNXtran_local_loopback_enable (CNXtllle)	<p>Configures the loopback of local connections that result from an explicit subscription. This causes two virtual circuits to be used for each local DCS registration. The syntax is: -CNXtllle=&lt;transport&gt;:[0   1]</p> <p>An example such as “-CNXtllle=cdm:1,” indicates that any registration that resolves locally will be connected through the cdm transport.</p> <p><b>Note:</b> Use the Viewer to view local messages. They are valuable for debugging. Local messages are not traceable through any other method.</p> <p><i>Argument Type:</i> string (transport name) <i>Default Value:</i> None</p>
CNXtran_thread_priority   CNXttp	<p>Specifies the priority of the transporter thread.</p> <p><i>Argument Type:</i> integer <i>Default Value:</i> DEFAULT_MAIN_PRIORITY + 1</p>
CNXtran_stack_size (CNXtss)	<p>Specifies the stack size of the transporter thread.</p> <p><i>Argument Type:</i> integer <i>Default Value:</i> CNXTTP_STACK</p>

**Table 62** *Transporter global command line options*

<b>Command Line Option</b>	<b>Description</b>
CNXtran_default_encoding   CNXtde	Specifies the default encoding method. 1=ASCII, 2=CDR  <i>Argument Type:</i> integer <i>Default Value:</i> 2
CNXtran_helper_thread_priority   CNXthtp	Specifies the helper thread priority.  <i>Argument Type:</i> integer <i>Default Value:</i> DEFAULT_MAIN_PRIORITY + 2
CNXtran_helper_thread_stack_size   CNXthtss	Specifies the helper thread stack size.  <i>Argument Type:</i> integer <i>Default Value:</i> CNXTHTP_STACK
CNXtran_helper_threads   CNXtht	Specifies the number of helper threads that are used to buffer data from Connexis. This corresponds to the maximum number of blocking calls that can occur against the transport at any given time plus the number of CDM host name resolution requests at any given time.  <i>Argument Type:</i> integer <i>Default Value:</i> 5
CNXtran_out_queue_limit   CNXtoql	The maximum number of messages allowed in the Operation queue.  <i>Argument Type:</i> integer <i>Default Value:</i> 250
CNXtran_endpoint_queue_limit   CNXtepql	The maximum number of messages that can be queued per endpoint.  <i>Argument Type:</i> integer <i>Default Value:</i> 100



**Table 62** *Transporter global command line options*

<b>Command Line Option</b>	<b>Description</b>
CNXtran_buffer_pool   CNXtbp	<p>This parameter establishes the number and size of the buffers that are being managed by the transport buffer pool. The default specifies that 1, 64 byte buffer, 10, 600 byte buffers, 10, 4200 byte buffers, 2, 17000 byte buffers, 2, 32860 byte buffers and 2, 33000 bytes buffers be created.</p> <p><i>Argument Type:</i> string  <i>Default Value:</i>                      64:1,600:10,4200:10,17000:2,32860:2,33000:2</p>
CNXtran_audit_period   CNXtap	<p>Specifies how often to schedule the audit process. A value of 0 means that auditing is disabled. This value is specified in milliseconds</p> <p><i>Argument Type:</i> integer  <i>Default Value:</i> 250</p>
CNXtran_audit_throttle_handshake   CNXtath	<p>Specifies the maximum number of handshake audit messages per audit period. This provides flow control when many connections are being audited.</p> <p><i>Argument Type:</i> integer  <i>Default Value:</i> 10</p>
CNXtran_audit_throttle_conn   CNXtatac	<p>Specifies the maximum number of connection audit messages per audit period. This provides flow control when many connections are being audited.</p> <p><i>Argument Type:</i> integer  <i>Default Value:</i> 10</p>

## Transport specific options

Table 62 describes the command line options that are available for modifying transport specific options.

**Table 63 Transport component command line options**

Command Line Option	Description
CNXendpoint   CNXep	<p>This option is used to specify the Connexis endpoint used by the application. A Connexis endpoint has the syntax: [transport protocol://][hostname:]port. For example, cdm://host1:9999.</p> <p>The CNXep option can be specified once for each registered transport.</p> <p>In the case of CDM, if this option is not specified or is set to 0, Connexis allocates a free port on the local machine for the CDM transport.</p> <p><i>Argument Type:</i> string <i>Default Value:</i> transport specific</p>
CNXtran_first_msg_size   CNXtfms	<p>Specifies the first message size to use when encoding. The default is the smaller of 600 or CNXtmms.</p> <p><i>Argument Type:</i> integer <i>Default Value:</i> 600 or CNXtmms</p>
CNXtran_max_transmit_size   CNXtmms	<p>Specifies the maximum transmit message size to use when encoding. For transports other than CDM, defaults to the largest buffer in CNXtbp, after excluding 1 buffer of size CNXtmms and 1 buffer of size CNXcmrs.</p> <p>The maximum transmit size for the CDM and CRM transports is limited to 65535 bytes.</p> <p><i>Argument Type:</i> string <i>Default Value:</i> max(CNXtbp)</p>

**Table 63 Transport component command line options**

<b>Command Line Option</b>	<b>Description</b>
CNXtran_reset_audit_enabled   CNXtrae	<p>This option (when set) configures the DCS to detect if a connection has gone down and recovered before the transport audit could detect the failure. If this option is true and a reset is detected, the DCS resets the local circuits so that their connections can be re-established. The detection is in part triggered by transport audits so transport audits must be enabled for this audit to function.</p> <p>If you disable CNXtrae you should make sure that CNXdae is enabled so that failures are detected by the circuit audit.</p> <p><i>Argument Type:</i> BOOL <i>Default Value:</i> 1 (true)</p>
CNXtran_handshake_conn_audits_is   CNXthcai	<p>Specifies the number of audits that must pass before the transport can go in-service.</p> <p><i>Argument Type:</i> integer <i>Default Value:</i> 2</p>
CNXtran_handshake_conn_audits_oos   CNXthcao	<p>Specifies the number of handshake audits that must fail before a transport connection is marked out-of-service. <math>(CNXthcao + 1) \times CNXtcao</math> is the amount of time that the other application would have to be unresponsive before the connection is marked out-of-service.</p> <p><i>Argument Type:</i> integer <i>Default Value:</i> 4</p>

**Table 63 Transport component command line options**

<b>Command Line Option</b>	<b>Description</b>
CNXtran_conn_audit_period_is   CNXtcapi	<p>Specifies the audit period to use when the connection is in-service. This value is represented in milliseconds. No audit messages are sent when data is exchanged over the connection in both directions.</p> <p>If this option is not a multiple of CNXtap, the audit period is rounded up to a period that is divisible by CNXtap.</p> <p><i>Argument Type:</i> integer <i>Default Value:</i> 500</p>
CNXtran_conn_audit_period_oos   CNXtcapo	<p>Specifies the connection audit period to use when the connection is out-of-service. This value is represented in milliseconds.</p> <p><i>Argument Type:</i> integer <i>Default Value:</i> 500</p>
CNXtran_resolve_expiry   CNXtre	<p>Configures the amount of time for which a resolved endpoint address is valid. Any new connections established before the expiration time will use the cached resolved address and will not reresolved unless there is a transport failure. This value is represented in seconds.</p> <p><i>Argument Type:</i> integer <i>Default Value:</i> 30</p>
CNXtran_resolve_retry_delay   CNXtrre	<p>Configures the retry period for a failed address resolve operation. The period is specified in milliseconds.</p> <p><i>Argument Type:</i> integer <i>Default Value:</i> 5000</p>
CNXtran_resolve_on_handshake_audit_fail   CNXtrhaf	<p>Configures the DCS to reresolve an endpoint after this number of failed periods from CNXtcapo, a handshake audit failure. A value of 1 enables this functionality.</p> <p><i>Argument Type:</i> integer <i>Default Value:</i> 0 (disabled)</p>

**Table 63 Transport component command line options**

<b>Command Line Option</b>	<b>Description</b>
CNXtran_resolve_after_failure   CNXtraf	Configures the DCS to reresolve a transport endpoint after a transport failure. A value of 1 enables this functionality.  <i>Argument Type:</i> BOOL <i>Default Value:</i> 0
CNXtran_bind_retry_delay   CNXtbrd	Configures the retry timeout for the endpoint binding operation of a transport. The timeout period is specified in milliseconds.  <i>Argument Type:</i> integer <i>Default Value:</i> 500
CNXtran_priority   CNXtp	Specifies the transport thread priority.  <i>Argument Type:</i> integer <i>Default Value:</i> DEFAULT_CNXTTP_PRIORITY + 1

## CDM

Table 64 describes the parameters that apply to the CDM transport.

**Table 64 CDM command line options**

<b>Command Line Option</b>	<b>Description</b>
CNXcdm_max_rx_size   CNXcmrs	Maximum CDM receive size. Default to largest buffer defined in transport buffer pool. This decode buffer is used exclusively for incoming CDM messages.  <i>Argument Type:</i> integer <i>Default Value:</i> max(CNXtbp)

**Table 64 CDM command line options**

<b>Command Line Option</b>	<b>Description</b>
CNXcdm_udp_rx_size   CNXcurs	The UDP protocol receive buffer size. The default value is what is defined by the target environment.  <i>Argument Type:</i> integer <i>Default Value:</i> system
CNXcdm_udp_tx_size   CNXcuts	The UDP protocol transmit buffer size. The default value is what is defined by the target environment.  <i>Argument Type:</i> integer <i>Default Value:</i> system

## Locator

Table 65 describes the options that are available for customizing the DCS Locator service.

**Table 65 Locator command line options**

<b>Command Line Option</b>	<b>Description</b>
CNXlocator_primary   CNXlp	Specifies that this process should be made the primary locator.  <i>Argument Type:</i> none <i>Default Value:</i> none
CNXlocator_backup   CNXlb	Specifies that this process should be made the backup locator.  <i>Argument Type:</i> none <i>Default Value:</i> none
CNXlocator_primary_endpoint   CNXlpep	Specifies the endpoint of the primary locator (if this process is not the primary locator).  <i>Argument Type:</i> string <i>Default Value:</i> none
CNXlocator_backup_endpoint   CNXlocator_backup_endpoint	Specifies the endpoint of the backup locator (if this process is not the backup locator).  <i>Argument Type:</i> string <i>Default Value:</i> none

**Table 65 Locator command line options**

<b>Command Line Option</b>	<b>Description</b>
CNXlocator_retry_delay   CNXlrd	Specifies the amount of time, in milliseconds, to wait before retries. The value must be >50.  <i>Argument Type:</i> integer <i>Default Value:</i> 1000
CNXlocator_audit_delay   CNXlad	Specifies the amount of time, in milliseconds, to wait between audits of the Primary locator. This value must be >50.  <i>Argument Type:</i> integer <i>Default Value:</i> 2000
CNXlocator_audits_oos   CNXlao	Specifies the number of failed audits required to take the primary locator out of service. Using the default of 3, the primary locator would be taken out of service after the third consecutive audit had failed.  <i>Argument Type:</i> integer <i>Default Value:</i> 3
CNXlocator_preferred_transport   CNXlpt	Configures the preferred transport to be used for a binding when the transport is available to both the publisher and the subscriber. This option can only be set at the Primary or Backup locators.  <i>Argument Type:</i> string <i>Default Value:</i> cdm

### Connexis viewer/target agent

The options listed below apply to the DCS Target Agent component of the Connexis Viewer. These options are specified in the same way as other options, namely as command line options to your Connexis-enabled executable.

These options are used to configure the target agent for optimal use with the Connexis Viewer.

**Table 66 Connexis Viewer command line options**

<b>Command Line Option</b>	<b>Description</b>
CNXagent_thread_priority   CNXatp	Specifies the target agent thread priority.  <i>Argument Type:</i> integer <i>Default Value:</i> DEFAULT_MAIN_PRIORITY
CNXagent_trace_buffer_size   CNXatbs	Specifies the target agent trace buffer size in terms of the number of events that are stored. Trace events have a fixed size of 32 bytes.  <i>Argument Type:</i> integer <i>Default Value:</i> 1000
CNXagent_data_block_size   CNXadbs	Specifies the target agent data block size in bytes.  <i>Argument Type:</i> integer <i>Default Value:</i> 32
CNXagent_num_data_blocks   CNXandb	Specifies the number of data blocks that are allocated for the target agent.  <i>Argument Type:</i> integer <i>Default Value:</i> 1000
CNXagent_truncate_user_data   CNXatud	Specifies the number of bytes to keep before truncating user data. A value of -1 means that no truncation is performed.  <i>Argument Type:</i> integer <i>Default Value:</i> 256
CNXagent_auto_start   CNXaas	Tells Connexis to automatically start capturing events. The level can be set between 1 and 5 where 1 corresponds to <b>Basic</b> traces, 3 corresponds to <b>Operational</b> traces and 5 corresponds to <b>Advanced</b> traces. The preferred level is 3. For more information, refer to “Defining a Trace Filter for a Component Instance” on page 182.  <i>Argument Type:</i> integer <i>Default Value:</i> 0 (disabled)





## Chapter 13

# Customizing and Porting DCS Libraries

---

The Distributed Connection Service (DCS) libraries let you create a distributed Rose RealTime application. The DCS libraries work with the TargetRTS, allowing Rose RealTime unwired ports to be bound across process boundaries.

This chapter describes how to customize or port DCS libraries to a new target environment. The new target could be a new target configuration, or an OS or compiler upgrade of a supported DCS target configuration.

The information in this chapter is specifically designed for software developers familiar with the target environment to which they are porting. It assumes that you have significant knowledge and experience with the development environment, operating system, and target hardware. It is also assumed that you are familiar with the *"Rational Rose RealTime C++ Porting Guide"* and have completed and tested the TargetRTS port to the new target configuration.

This section also provides guidelines on how to build DCS libraries for a minimal configuration.

### **Common customizations for the DCS**

The DCS has been designed and implemented using Rose RealTime and is available in the form of a model. The most common customizations required are:

- Changing the compilation flags used to build the DCS library
- Updating the compiler version for the target configuration
- Building a minimal configuration of the TargetRTS and DCS libraries

### Other resources

Before customizing a target configuration or starting a port, ensure that you have the following documents and materials available:

- Rational Rose RealTime C++ Porting Guide
- Compiler documentation
- Simple Rose RealTime example models to verify the TargetRTS port
- Connexis "BasicTest" example model to verify the DCS port

### Operating system capabilities

UDP/IP and TCP/IP support are required to support CDM and CRM transports. While it is possible to complete a port without IP support, UDP/IP support is required if you need to observe your target using the Connexis Viewer. IP support is also required for UML-level debugging using Target Observability feature of Rose RealTime.

### What to do before calling Rational support

If you encounter any problems, follow the steps below before calling Rational support for help regarding a DCS port.

1. Follow the steps outlined in the section "What to do before calling Rational Support" in the *"Rose RealTime C++ Porting Guide."*
2. Verify that the TargetRTS port for the new target configuration is functional using the Rose RealTime example models.

## Porting the DCS to a New Target Configuration

---

To port the DCS to a new target configuration:

1. Create a TargetRTS library for the new target configuration.
2. Create DCS target specific header files for the new target configuration.
3. Load the DCS model.
4. Create a new C++ library component for the new target configuration.
5. Configure and customize the C++ library component settings.
6. Configure the DCS CDR encoding/decoding for the new target configuration.

7. Build the DCS library for the new target configuration.
8. Test the new target configuration.

## Creating a New TargetRTS Library

Follow the steps and instructions described in the “*Rational Rose RealTime C++ Porting Guide*” to configure or create a TargetRTS library.

The DCS library for a target platform depends on the TargetRTS for its target configuration and library settings. The TargetRTS provides several settings that the user can configure. The TargetRTS parameters and settings table lists the parameters and the settings that must be set for the DCS. The “*Rational Rose RealTime C++ Porting Guide*” provides a complete description of all the target settings.

**Table 67 TargetRTS parameters and settings**

Target Settings	Value	Descriptions
USE_THREADS	1	The DCS is only available for multi-threaded applications.
HAVE_INET	1	The DCS requires IP support for the Connexis Datagram Messaging (CDM) and the Connexis Reliable Messaging (CRM) transports.
OBJECT_ENCODE	1	The DCS requires IP support for the Connexis Datagram Messaging (CDM) and the Connexis Reliable Messaging (CRM) transports.
OBJECT_DECODE	1	Required so that a message received over the wire can be decoded into objects.
RTS_COMPATIBLE	600	Connexis is not available for ObjecTime Developer and there are no compatibility issues with v5.2

Compiler option settings that are common to the TargetRTS libraries, the DCS libraries, and the user's application should be configured using the LIBSETCCFLAGS macro in `$(RTS_HOME)/libset/<libset>/libset.mk`.

Compiler option settings that only apply to the TargetRTS libraries should be set in the LIBSETCCEXTRA macro in `$(RTS_HOME)/libset/<libset>/libset.mk`.

Compiler option settings that only apply to the DCS libraries should be configured in the DCS model. Customization of a DCS C++ library component is described in the section "Configuring the C++ Library Component Settings."

### Creating DCS Target Specific Header Files

Although most of the configuration of the DCS libraries is done within the DCS model, the DCS thread configurations are configured in the file `$RTS_HOME/target/<target>/RTDcsTarget.h`. The file `RTDcsTarget.h` contains specific operating system priority definitions and configuration of the stack size for DCS threads. The `RTDcsTarget.h` file also contains the definitions of the maximum and minimum values of the thread priorities for an operating system. Run-time argument processing uses these values to validate the run-time settings or the thread priorities for the DCS threads. The table below provides a list of constants that must be defined in `RTDcsTarget.h`.

**Table 68** *Constant definitions*

<b>Constant</b>	<b>Description</b>
<code>CNX_PRIORITY_MIN</code>	Defines the minimum allowable value for a thread priority
<code>CNX_PRIORITY_MAX</code>	Defines the maximum allowable value for a thread priority.
<code>CNX_PRIORITY_RAISE</code>	The default configuration for the DCS is for the priority of the helper threads to be higher than the priority of the transporter thread. The <code>CNX_PRIORITY_RAISE</code> constant is used to increment a thread priority. For OS targets in which the higher priority threads have lower numeric values, the value of <code>CNX_PRIORITY_RAISE</code> must be negative.
<code>DEFAULT_CNXHTP_PRIORITY</code>	Sets the default thread priority for the transporter thread.
<code>DEFAULT_CNXHTP_PRIORITY</code>	Sets the default thread priority for the helper threads. For optimal system performance, the helper threads should run at a higher priority than the transporter thread.

**Table 68** Constant definitions

Constant	Description
DEFAULT_CNXATP_PRIORITY	Sets the default thread priority for the target agent. The target agent is designed to be minimally intrusive to the application and should be running at a lower priority than the threads of the application.
CNXHTTP_STACK	Sets the stack size for the transporter thread.
CNXHTTP_STACK	Sets the stack size for the helper threads
CNXATP_STACK	Sets the stack size for the target agent thread.

## Loading the DCS Model

Before you load the DCS model, create new target configuration or customizations to an existing target configuration within the DCS model. Load the DCS model into a Rose RealTime session, found in the \$ROSE\_HOME/CONNEXIS/Model directory.

The Component View of the DCS model has packages containing the C++ library components for the supported DCS configurations. These packages are named after the target configurations they represent. For example, the package VXW54-ppc-cygnus-272-960126 represents the TORNADO2T.ppc-cygnus-2.7.2-960126 target configuration.

Before making any modifications to the target configurations, make a copy of the DCS model provided with the Connexis installation.

## Creating a C++ Library Component

Once the DCS model is loaded, you can modify an existing C++ library component or create a new one.

If you are modifying an existing target configuration, clone the TargetRTS with a new name and duplicate the DCS library component.

To clone the TargetRTS:

1. Select the component in the browser.
2. Duplicate the option from its context menu.

If you are creating a new target configuration, duplicate the DCS library component template provided in the **Component View::Component Generator** package. This generic template component is configured with the following information:

- references to all the DCS Logical View components required to provide the DCS functionality
- property settings for the library name (the default is `$(LIB_PFX)DCS$(LIB_EXT)`)
- compilation inclusion paths
- property settings for any component level inclusions
- component dependencies

### Configuring the C++ Library Component Settings

The following table describes the component properties that must be customized.

**Table 69 Customizing component properties**

<b>Component Property</b>	<b>Description</b>
C++ Compilation > TargetConfiguration	The <target> and <libset> settings of the TargetRTS configuration that we are building against.
C++ Generation > CodeGenMakeType	Specify the format of the makefiles to be generated by the toolset for the code generation phase of the build. For example, if you are using the GNU make utility in your environment, this property should be set to <code>Gnu_make</code> .
C++ Generation > CodeGenMakeCommand	Specifies the name of the make utility to be used by the toolset for the code generation phase. For example, <code>gmake</code> .
C++ Compilation > CompilationMakeType	Specify the format of the makefiles to be generated by the toolset for compilation phase of the build. For example, if you are using the GNU make utility in your environment, this property should be set to <code>Gnu_make</code> .
C++ Compilation > CompilationMakeCommand	Specifies the name of the make utility to be used by the toolset for the code compilation phase. For example, <code>gmake</code> .

**Table 69 Customizing component properties**

Component Property	Description
C++ Compilation > CompilationMakeArguments	You must specify RT_SRC_TGT=<target_base>. The DCS depends on TargetRTS files in the \$RTS_HOME/src/target directory. For example, RTtcp.h. The RT_SRC_TGT make variable is used to specify the target base.
C++ Compilation > CompileArguments	<p>If your component is not compiling, it may be a result of the RTD_CONNEXIS_BUILD constant not being set properly. The definition of this constant can be found in the C++ Compilation &gt; "Compile Arguments" field of the component and should be changed from \$(CNX_BUILD_NUM) to a user-defined integer value. This property is used to configure the C++ preprocessor macros that configure certain DCS capabilities.</p> <p>Viewer tracing is configured on the target using the RTD_TRACE macro. \$(DEFINE_TAG)RTD_TRACE=1 enables tracing. \$(DEFINE_TAG)RTD_TRACE=0 disables most traces (except errors and warnings), \$(DEFINE_TAG)RTD_TRACE=2 disables all traces.</p> <p>The metrics collection and reporting capabilities are configured using the RTD_STATISTICS macro. \$(DEFINE_TAG)RTD_STATISTICS=1 enables metrics collection and reporting. \$(DEFINE_TAG)RTD_STATISTICS=0 disables the metrics collection and reporting.</p> <p>Additional macros might be required to configure the CDR encode/decode capabilities for the target platform. These capabilities are described in "Configuring the CDR Encode/Decode Functionality" on page 296</p> <p><b>Note:</b> <i>If your component is not compiling, it could be a result of the RTD_CONNEXIS_BUILD constant not being set properly. This constant's definition can be found in the component's "C++ Compilation" &gt; "Compile Arguments" field and should be changed from \$(CNX_BUILD_NUM) to a user-defined integer.</i></p> <p>This property is also used to configure any compiler option settings that are only required for completion of the DCS libraries.</p>

### Configuring the CDR Encode/Decode Functionality

The CDR Encode/Decode functionality could require platform specific customizations depending on the capabilities of the platform. These customizations are accomplished by defining C++ preprocessor macros in the "C++ Compilation > CompileArguments" property of the DCS library component's specification sheet. The following customizations are available:

- Overriding the type for use when encoding 64-bit values. The default behaviour when the `RTD_LONGLONG_TYPE` macro is not defined is to encode/decode 64-bit values using the primitive "long long" type. This customization is required when the compiler does not provide support for "long long" types. Setting `$(DEFINE_TAG)RTD_LONGLONG_TYPE=0` will use "`__int64`" type to encode/decoding 64-bit values. Setting `$(DEFINE_TAG)RTD_LONGLONG_TYPE=1` will cause 64-bit values to be encoded/decoded using the primitive "double" type.
- Enabling the inclusion of `<sys/types.h>`. Some platforms require this inclusion to provide definitions of all the system types. Setting `$(DEFINE_TAG)RTD_INCLUDE_TYPES_IN_RTDPATFORMCONFIG` enables this capability.

### Creating a Minimal DCS Library Configuration

The DCS libraries provided with the Connexis installation are configured with extensive debugging information and capabilities. As the application becomes more mature, it may be necessary to recompile a minimal configuration of both the TargetRTS and DCS libraries in order to obtain better performance and a smaller memory footprint for deployment. The Rose for RealTime "C++ Language Guide" provides a description of how to create a minimal Target RTS library configuration.

The TargetRTS precompiler settings defined in Table 67, "TargetRTS parameters and settings" on page 291, must be set to support the DCS functionality.



Once a minimal Target RTS is configured, built, and tested. The DCS library corresponding to the TargetRTS library configuration can be built. For the DCS libraries, it is recommended that the following preprocessor settings be set for a minimal configuration:

- `$(DEFINE_TAG)RTD_TRACE=0`
- `$(DEFINE_TAG)RTD_STATISTICS=0`

These settings are described in Table 69, Customizing component properties.

### Building the Library

Once you build the C++ library component and the **Logical View::DCSComponents::DCSTransport::DCSEncodeDecode::RTDPlatformConfig** class is configured for the target platform, you can build the library.

To build the library:

1. Select the component in the browser
2. Select the **Build > Build** option from the context menu.

The library is built into the folder specified in the properties area of the component (**C++ Generation > OutputDirectory**).

Once the library has been built, copy it into the `$_ROSET_HOME/CONNEXIS/C++/lib/<target>.<libset>` directory.

**Note:** *If your component is not compiling, it could be a result of the `RTD_CONNEXIS_BUILD` constant not being set properly. This constant's definition can be found in the component's "C++ Compilation" > "Compile Arguments" field and should be changed from `$(CNX_BUILD_NUM)` to a user-defined integer.*

### Testing the Port

Test the DCS library port with the BasicTest model provided as part of the Connexis installation. This model is available in `$_ROSET_HOME/CONNEXIS/C++/Examples/BasicTest.rtmml`. A description of the BasicTest model is provided in the "Rational Connexis Release Notes and Installation Guide."





## *Chapter 14*

# *Using the Transport Integration Framework*

---

The Rational Connexis Transport Integration Framework (TIF) lets you add your own proprietary transports or other common transports for use in Connexis messaging. The TIF is designed to be flexible, allowing a variety of transports to be integrated. Transports may include Industry standard transports (UDP/IP, TCP/IP), operating system specific transports, or your own proprietary transport.

You might want to add your own transports for the following reasons:

- The application requires more real-time predictability than TCP/IP can provide.
- The application requires more reliability than CDM can provide.
- The application uses an embedded or proprietary protocol.
- TCP/IP is not available on the target system.

TIF lets transport specialists seamlessly integrate transports into Connexis. TIF is provided as a package of classes that are subclassed and implemented. The subclasses are packaged into a library and made available to Connexis-enabled applications. The viewer, locator, and other Connexis features are fully supported for any transport integrated into Connexis.

### Transport Integration Overview

---

The following overview identifies the steps in building a Transport Integration (TI) using the Transport Integration Framework (TIF). The steps to building a Transport Integration are as follows:

1. Verify that your transport works.  
It is important to ensure that your transport works before integrating it into the DCS using the TIF. It is difficult to test the transport and integration at the same time.
2. Understand the Transport Integration Framework.  
“DCS Architecture” on page 301 describes in detail how the DCS and the Transport Integration works together to establish connections and transfer messages between subscribers (SAPs) and publishers (SPPs).
3. Understand your transport.  
This includes the transport's properties and how to send and receive messages over it (see “Understanding your Transport” on page 305).
4. Implement the transport integration.  
Create subclasses and implement the abstract functions of the following classes:
  - RTDTransport
  - RTDTransportAddress
  - RTDTransportAddressFactory
  - RTDTransportEndpoint
  - RTDTransportEndpointFactoryCreate a class (or classes) that provides functionality of the transport.
5. Package the transport integration.  
Create a class (or subclasses) that provide the listening functionality of the transport.
6. Test the use of the integration of the transport under Connexis.

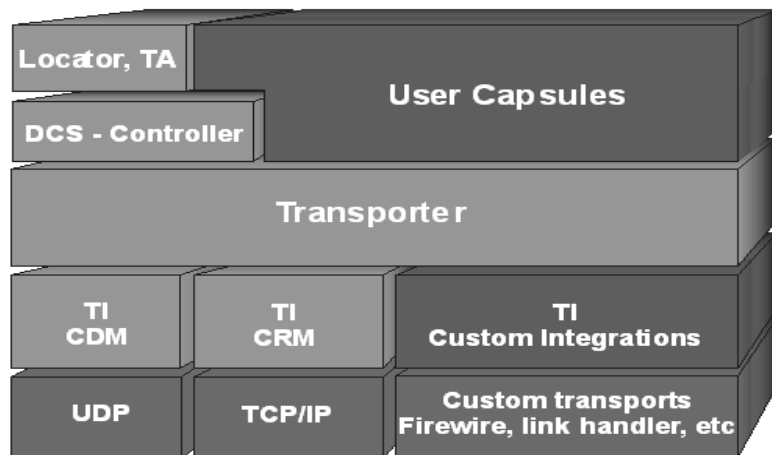
## DCS Architecture

The Connexis Transport Integration Framework (TIF) forms the basis of integration. A Transport Integration (TI) is the actual implementation of an instance of the TIF. The transports which come with Connexis (CDM based upon UDP and CRM based upon TCP/IP) have been integrated using the TIF. Figure 119, “Connexis High-Level Design,” on page 301, shows how the DCS fits into a DCS-enabled application. The Locator and Agent, included as part of the DCS, are special applications that access internal information about connections and uses of the DCS like a user application. User applications make use of the DCS when registering and deregistering SAPs and SPPs and when sending messages between SAPs and SPPs.

The Controller processes the registerSAP, registerSPP, deregisterSAP and deregisterSPP calls and establishes the virtual circuit between a SAP and SPP. If necessary a locator is contacted for global subscriptions and publications.

The transporter is responsible for setting up, auditing, and recovering connections. It is responsible for routing work requests like binds, resolves and sends to the appropriate Transport Integration.

The Transport Integration interfaces with the actual transport to resolve addresses, bind and reset connections, and send or receive messages.



**Figure 119 Connexis High-Level Design**

The Table 70, Connexis High-Level Design Chart, identifies what components of Figure 119 are DCS, Customer or Third-party components.

**Table 70 Connexis High-Level Design Chart**

<b>Connexis Components</b>	<b>Customer Components</b>	<b>Third-party components</b>
locator, TA	User Capsules	UDP
DCS - Controller	TI Custom Integrations	TCP/IP
Transporter		Custom transports
TI - CDM		
TI - CRM		

## Terminology

---

Throughout this chapter the following terms, defined in Table 71, are used.

**Table 71 Chapter Definitions**

<b>Term</b>	<b>Definition</b>
Address	The location of the component instance.
Endpoint	In the context of the Transport Integration Framework, an endpoint represents a connection over a transport from one component instance to another component instance.
Virtual Circuit	Represents a logical connection between a subscriber and a publisher.
Audit	Background activity to help monitor the availability of a transport during periods of inactivity.
Messages	Information to exchange between two component instances.
Audit Messages	Messages exchanged between two component instances in an effort to monitor the endpoint.
Control Messages	Messages exchanged between a DCS in different component instances, regarding a virtual circuit.

**Table 71 Chapter Definitions**

<b>Term</b>	<b>Definition</b>
Application Messages	Messages exchanged over a virtual circuit (between a publisher and a subscriber).
Transport Intergration	The actual implementation of TIF classes that allow a transport to be used transparently by a DCS enabled model.
TIF	The set of model interface elements and documentation that allows transports to be integrated with the DCS.

## Connection Lifecycle

When Connexis receives a RegisterSAP request, it resolves the address and a single endpoint is established from the resolved address. Once the endpoint is established, it is bound and messages are exchanged to obtain access to a service (a virtual circuit). Data messages are then exchanged between the SAP and SPP over the virtual circuit.

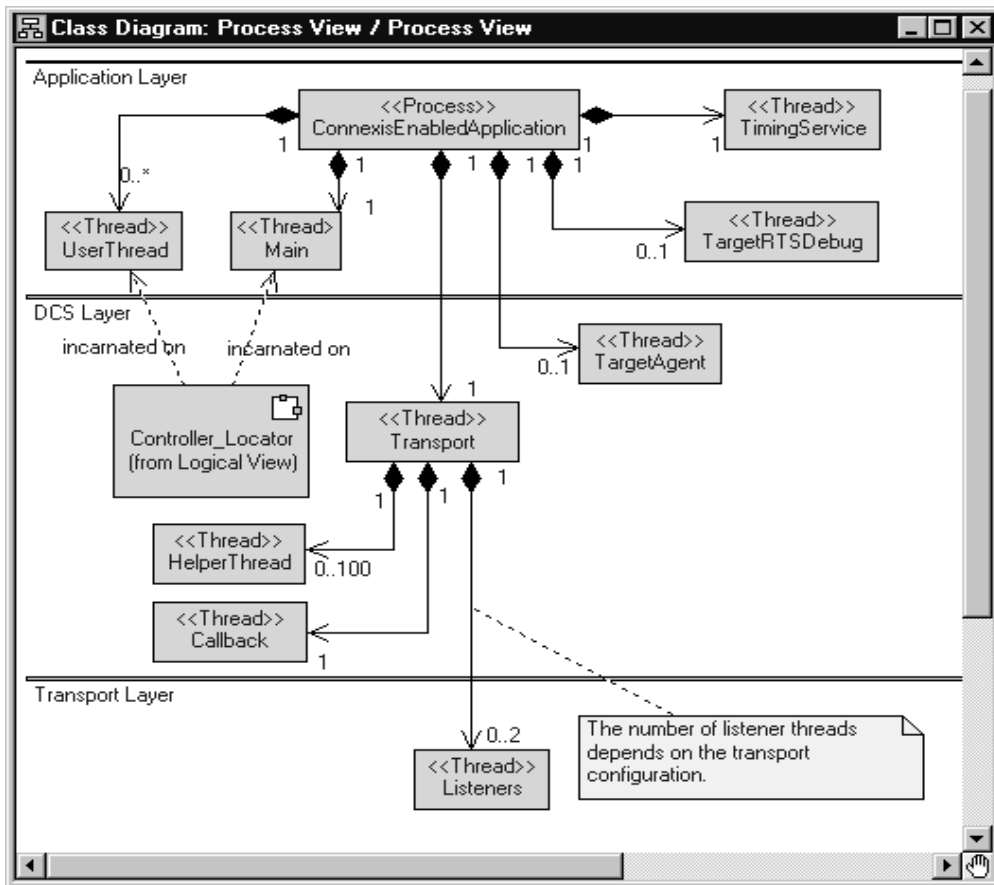
**Note:** *Multiple virtual circuits can use the same endpoint and messages consist of fixed-size control information and data.*

Messages sent over the virtual circuit could be Connexis control messages, Connexis audit messages or SAP/SPP messages. All messages need to be encoded before they are sent and decoded. The endpoint is monitored as long as there are established virtual circuits associated with it. If there is no activity over any of the virtual circuits the audit activity is triggered. The user is notified of the failure (rtunbound) of the transport and the recovery (rtbound) of the re-established connection with the virtual circuit.

Resource cleanup takes place periodically when there are no virtual circuits making use of an endpoint. In that case the endpoint is released.

## DCS Threading Model

The diagram below illustrates the DCS threading model (see Figure 120, Connexis Process View). The significant threads from the Transport Integration point of view are the Transporter thread and the pool of Helper threads.



**Figure 120 Connexis Process View**

If an address received in a registerSAP called is unresolved, a request to resolve it is queued for a helper thread. For blocking transports that are integrated into the DCS, the bind, send and reset requests take place on the helper thread. Only one helper thread at a time invokes these functions for a connection. If the transport is configured as non-



blocking, these requests are performed on the thread of the DCS transporter. The Transport Integration, in turn, may create additional threads for other processing, such as listening for messages. Alternatively, the wait and wakeup functions of the DCS transporter can be overridden to perform the "listening" operation for the transport. In this case, the work is performed on the thread of the transporter. User capsules can also be incarnated to be run on the thread of the transporter. The thread of the transporter can be obtained using the RTDInitStatus protocol. Take care to ensure none of these user capsules block. For more information on the DCS threading model, see "Connexis Customization Reference" on page 261.

## Understanding your Transport

---

When you implement the Transport Integration, you must decide how the transport is to be configured into DCS. You must have the following information about your transport before you use the TIF:

- "Determine the Name of your Transport and Protocols" on page 306.
- "Decide the String Format of the User-specified Address" on page 306.
- "Decide How to Validate the Address" on page 306.
- "Decide the Transformation of the Address" on page 307
- "Determine the Internal Representation of your Address" on page 308
- "Decide the Format of the Listening Point Information" on page 309.
- "Decide if your Transport is Blocking or Non-blocking" on page 309.
- "Decide the Recommended Address Resolution Configuration" on page 310.
- "Decide How the Transport will Recover from Transport Failures" on page 311.
- "Decide How to Audit your Transport" on page 311.
- "Decide the Format of your Messages" on page 312.
- "Decide Strategy for Listening for Messages" on page 313.



### **Example:**

The CRM validation of an address includes verifying:

- A single address is supplied.
- A host name or IP address is supplied.
- A numeric port number is supplied.
- The port is non-zero.

## **Decide the Transformation of the Address**

The address supplied is in a textual string format. It may require that all or a portion of the string be transformed into an internal transport-dependent form. A queue name may need to be transformed into an internal queue ID. An object name may be transformed into an object reference after looking it up in a naming service. A host name may be transformed into an IP address. An IP address and port may be transformed into a socket.

The address can be transformed into an internal form:

- When an instance of the `RTDTransportAddress` subclass is created
- At resolve time
- At bind time

The results of the transformation during resolve time should be stored in the `RTDTransportAddress` subclass. The results of the transformation done at bind time should be stored in the `RTDTransportEndpoint` subclass.

The address should be transformed at resolve time if any of the following situations apply:

1. If only part of the address needs to be "looked up" or transformed (for example resolving a host name), it should be performed at resolve time. The results of the lookup are cached and can be used by different addresses. For example: `crm://alpha:9090` and `crm://alpha:10002` are 2 different addresses. The host name "alpha" can be looked up once at resolve time and cached for use by both addresses.

2. If the transport is non-blocking and transformation is blocking, the look up should take place during resolve time. The resolve takes place on a separate thread. If the transport is marked as non-blocking, the bind takes place on the transporter thread being used to send or receive other messages.
3. If the different unresolved portions of an address can result in the same resolved value, consider performing the lookup in the resolve step. For example, if host names "alpha" and "CnxTest" both resolve to the same result, it is better to perform the lookup during resolve time, so that "crm://alpha:9000" and "crm://CnxTest:9000" would result in the same endpoint being used.

If the transformation is non-blocking and you never need to re-transform the address after a transport failure, or an audit failure, the transformation can take place when the `RTDTransportAddress` subclass is created.

If none of the above situations apply, the lookup should be done at bind time. For example a CORBA object name may be looked up only at bind time.

### **Example:**

For the CRM transport, if a host name is supplied as opposed to an IP address, the address is considered unresolved. Only the host name portion of the address needs to be resolved. Because multiple representations of an address may turn out to be the same address, the host name lookup will be done as part of the resolve step as opposed to the bind step. For example: `crm://alpha:9000`, `crm://mymachine:9000` and `crm://192.222.222.22:9000` could resolve to the same destination. Therefore the resolve is the best place to look up the host name so that only one endpoint is available for the same destination. The IP address will be transformed later to a socket during bind time.

## **Determine the Internal Representation of your Address**

The address supplied by an application is always in a textual string format. The transport that is integrated requires an address to be represented in a completely different form.

**Example:**

The internal representation of a CRM address uses the `RTinet_address` and `RTinet_port` classes/typedefs. The class also has a host attribute type of `RTString` that is used to hold the unresolved host name. The socket that is created by the connect is part of the internal representation of the endpoint.

**Decide the Format of the Listening Point Information**

Review the `-CNXep` parameter and decide the format of the listening point information. `-CNXep` has the form:

`-CNXep=<protocol>:<listeningaddress>`

**Note:** *It is the transport protocol that is supplied and not the transport name. If you chose the same value for both, the distinction is irrelevant.*

The transport integration is responsible for validating the listening point information supplied by a user. The endpoint supplied could be a complete address, or a portion of an address (such as a port number), or could be completely optional.

**Example:**

The CRM transport supports the following endpoint format:

`-CNXep=[crm[://host]:port]`

where `host` is a host name or IP address of the component instance's processor.

CRM supports a full address in the same format as used in the registration string. It also supports just the specification of a port number. The IP address is determined at startup to be the primary IP address of the board. If no address was supplied, the primary IP address and any free port is used as the listening address.

**Decide if your Transport is Blocking or Non-blocking**

A transport can be considered a blocking transport if it blocks one of the following operations: `bind`, `send` a message or `reset`.

If the transport is non-blocking, the message send performed is on the same thread as the transporter, preventing a context switch. If the transport is blocking, the message is first encoded by the TI on the transport thread. The message is then queued for the endpoint by the transporter. The message is later sent by the TI on the helper thread.

If the transport you are integrating is blocking, you must decide the stack size and priority of the threads (-CNXthts, -CNXthtp). The users of the transport decide the number of helper threads (-CNXtht), the size of the buffer pool (-CNXtbp) which holds the encoded messages until they are sent, the maximum queued messages (-CNXtoql) and the maximum queued messages per endpoint (-CNXtepql).

**Example:**

The CRM transport is blocking.

The CDM transport is non-blocking

### Decide the Recommended Address Resolution Configuration

When configuring the transport, information on address resolution is collected. During the configuration process, you need to validate and set the address expiry and the retry delay periods. See the description of RTDProfile for more information on the periods. Also, see the description of the -CNXtre and -CNXtrre parameters (see “Connexis Customization Reference” on page 261).

Ask yourself how frequently the result of the address resolution changes during the life of the process. When the resolve fails, is it possible, if retried later, to be resolved. If so, what is a reasonable time period to delay?

**Example:**

For CRM, the resolve step is a host name lookup. It is possible that during the life of the process that the network topology can change. This creates the possibility that a host name may resolve to one location at one point in time, but resolve later to a new location. The address expiry period can be non-zero. The CRM protocol may be used in situations where the network topology is known to never (or very infrequently) change and the user may want to override the settings on the command line.

## Decide How the Transport will Recover from Transport Failures

During the configuration of the transport, you need to describe how to recover from transport failures. An endpoint is considered to have had a transport failure if:

- A bind is unsuccessful (bind function reports `RTDFailure`).
- A write is unsuccessful (write function reports `RTDTransportFailure`).
- The transport notifies the DCS asynchronously that the transport has failed.

Once an endpoint has suffered a transport failure, the DCS can attempt to put the endpoint back into service, or it can wait until the endpoint is accessible again. You can specify how long to delay after a bind failure. You may also indicate if a transport failure should trigger the re-resolution of the destination address of the endpoint (if it was originally unresolved).

### **Example:**

For the CRM transport, the DCS attempts to put the endpoint back into service. Addresses should be re-resolved since the network topology can change.

For the CDM transport, transport failures do not happen. The CDM transport depends upon the handshake audit to determine when an endpoint is inaccessible.

## Decide How to Audit your Transport

The DCS supports two types of periodic audits, Handshake, Connection or None. See “Configuring the Number of Virtual Circuits” on page 271, for details on the nature of the audits.

If the transport being integrated already has the ability to detect failures when the transport is idle, use this functionality instead of the DCS audit facilities. When the transport detects a failure for an endpoint, notify the DCS of the failure through the `transportFailure` or `transportFailureRecovery` functions in the DCS API. The API is provided to the Transport Integration during startup. In the case of this transport the periodic audit type would be `noAudit`.

If the transport being integrated can detect failures when messages are sent, use the Connection audit. The Connection audit results in messages being sent to endpoint destinations when the application is not sending or receiving messages on that endpoint.

If the transport being integrated is unreliable and does not detect failures when writing or receiving messages, use the Handshake audit. The Handshake audit sends a message that triggers a response from the other end. If the response is not received, it indicates that the transport may have failed. When using the Handshake audit, consider enabling the Reset Audit as well. Do not use the Handshake audit if the reply to an audit message is received on a different endpoint than the originating message.

**Example:**

The CRM transport uses the Connection audit.

The CDM transport uses the Handshake audit and the Reset audit unless requested it not be used.

### Decide the Format of your Messages

There are two major message classes sent by DCS, Audit messages and Data messages.

An audit message consists of a header of audit-specific information, and optional data object and information about the data. Data objects are sent only in rare circumstances.

The Data messages category includes the DCS control messages and application data messages. A data message consists of a header structure of data message-specific information, a signal name, a data object and information about the data. Some of the data messages sent require that the address of the sender is known on the receiving side.

Depending on the transport and the deployment processor architecture, messages sent may need to be encoded/decoded. You may also have additional information that you want to be exchanged between component instances. You may also want to encrypt or compress the messages being sent over the transport.



### **Example:**

For the CRM transport, a common preface header is shared between the two message categories. This header contains the size of the message, version information (for future use), message type and message priority. The message type identifies what follows these 8 bytes (full word alignment).

If the message is an audit message, a second header follows, containing the audit header information and an offset in the message to the encoded data object.

If the message is a data message a second header follows, containing the data header information and an offset in the message to the encoded data object. A null terminated string containing the signal name follows the second header.

The attributes of the header are aligned on the appropriate boundaries. Prior to sending a message, the short and long attributes in the header are placed in network byte order. The origin of the message never needs to be sent since it can be determined from the socket on the receiver's side.

## **Decide Strategy for Listening for Messages**

In the transport integration you need to implement listening functionality for your transport. The DCS provides a set of functions to call when a message has been received by the transport. Listening functionality can be implemented to run on a thread created by the Transport Integration or in some cases on the DCS Transporter thread.

Does your transport use a callback type mechanism to notify you of messages received?

For example you register functions to be called. It calls known object methods (CORBA object). Your listening routine(s) dissect the message received and call the appropriate DCS API function with the decoded information. You would not make use of the custom controller.

Does your transport require that you do a blocking wait until a message arrives?

For example, do you receive on a socket, do a select on a set of sockets, wait for a message queue signal, etc.? If so, you require a thread that can wait on the object. The listening routine dissects the message and calls the appropriate DCS API function with the decoded information.

You can perform the listen operation on the thread of the transport, if the cases below apply. Otherwise create your own thread on which to listen. Ideally you want to listen on the thread of the transport to reduce the number of context switches.

- Does your transport support listening to multiple endpoints at once?

For example, receive from a UDP socket, or select on a set of sockets or wait on a queue of incoming messages.

- Are you are able to wake yourself up to do other processing? For example, you can send yourself a message from another thread or signal yourself from another thread.

If you want your transport to listen on the DCS transporter thread, set `useCustomController` to true and register a wait routine and a wakeup routine during configuration.

**Note:** *Note only one transport can be configured to listen on the transporter's thread since there is only one transporter.*

You will need to decide which transport listens on the transporter thread. This should be based on load and performance requirements.

Does your transport require a separate thread to listen on each individual endpoint from which messages can arrive. For example, select type functionality is not available. It is recommended that the `RTDEndpoint` subclass manages the creation and shutdown of the listening threads.

Does your transport require you to poll it to see when a message has arrived?

If so, you can create a thread that periodically polls to see if a message has arrived. If the `CNXtap` period is frequent enough for polling, you must consider placing the polling activity on the DCS transporter thread by setting `useCustomController` to true and register implement a processing routine that checks for new messages.

Refer to the Rational Rose RealTime documentation on the custom controller to understand how the functionality runs on the DCS Transporter thread.

### **Example:**

The CRM transport uses select to listen on a collection of sockets. Only one thread is needed to listen for messages. Sending the listener a short control message wakes it up. The CRM transport offers the flexibility to listen on the DCS Transporter thread or a separate thread, allowing a different integrated transport to listen on the Transporter thread. The endpoint notifies the listener when it starts listening on a particular socket and when to no longer listen on a particular socket.

## Integrating your Transport

---

This section explains how to integrate a transport into the DCS.

### **Setting up the Model**

Preparation:

- Decide the name of your transport.
- Make sure the transport works.

Steps:

1. Create a new model or use an existing model that has your transport implementation.
2. Share in the RTDTransportIntegrationClasses logical package and the RTDTIFComponents component package.

These packages contain the classes and library for the Transport Integration Framework. To share in these packages see “Adding Connexis Support to Your Model” on page 83.

3. Create a new package to contain your transport integration.
4. Create the new package in a class diagram and subclasses of the following Integration classes:
  - RTDTransportAddressFactory
  - RTDTransportAddress
  - RTDTransportEndpointFactory
  - RTDTransportEndpoint
  - RTDTransport

### **Example:**

The classes created for the CRM transport are:

- RTDCrmAddressFactory
- RTDCrmAddress
- RTDCrmEndpointFactory
- RTDCrmEndpoint
- RTDCrmTransport

**Note:** The prefix "RT" for class/capsule names is reserved for Rational RoseRT. Name your classes appropriately so there are no symbol conflicts.

## **Understand the Integrated Transport**

Read the section "Understanding Your Transport" and make decisions on how you want to represent your transport to the DCS.

## **Implementing the RTDTransportAddressFactory Subclass**

To implement the RTDTransport AddressFactory subclass:

1. Review the description of the RTDTransportAddressFactory class.
2. Determine the name of your transport and protocols.
3. Decide the format of the listening point information the user will supply.
4. Define the implementations of the abstract functions.
  - a. `newTransportAddress(RTDTransportId, const char * const)`
  - b. `newTransportAddress(const RTDTransportAddress &)`
  - c. `newLocalAddress(const RTDTransportId)`
  - d. `releaseTransportAddress(RTDTransportAddress &)`

The `newTransportAddress` and `releaseTransportAddress` functions create and release instances of the `RTTransportAddress` subclass.

The `newLocalAddress` function creates a `RTDTransportAddress` subclass object representing the endpoint on which this process is listening. The string format of the address (for example, result of the `endpoint()` function) is used by the application when publishing SPPs. It is a good idea to ensure the address supplied is distinct.

**Example:**

Typically, the local listening information is supplied by the user in the `-CNXep=<transport protocol>:<listening point information>` command line parameter. This information in turn is supplied to the transport in the `configureTransport` call.

In the CRM case, the `RTDCrmTransport::startTransport` function processes the `-CNXep` information supplied by the user and starts the transport. Once the transport is started, the actual listening point is known (`-CNXep` is optional for CRM). The `RTDCrmTransport` class makes the listening information available in a public static attribute (instance of the `RTDCrmAddress`).

`RTDCrmAddressFactory::newLocalAddress` returns a copy of this attribute. This is just one of many possible ways of obtaining access to the listening point. Choose which works the best for your design.

**Implementing the RTDTransportAddress Subclass**

To Implement the `RTDTransportAddress` subclass:

1. Review the description of the `RTDTransportAddress` class.
2. Decide the string format of the user-specified address.
3. Decide how to validate the address.
4. Decide what is the internal representation of the address of the transport, if any.
5. Decide the address transformation.
6. Create the necessary attributes/associations needed to contain the internal representation. You may also want to provide methods for accessing this information.
7. Define the constructors for the subclass.

The subclass requires 2 constructors, one accepts the transport ID and a string representation of the address and the other is a copy constructor.
8. Define the implementations for the abstract functions:
  - a. `unresolvedName`
  - b. `resolve`
  - c. `setResolved`
  - d. `sameResolved`

9. Define a function that validates a string representation of the address.

The definition of the function is as follows:

```
typedef RTDResult (*RTDAddressValidatorFcn) ( const char *
);
```

It should return RTDSuccess if the address is valid and RTDFailure if invalid. In cases of failure, it is possible to generate a trace event explaining the error found if so desired. The validation should not be blocking since it can be called from the transporter thread and the thread on which the RTDBase (or subclass) capsule was incarnated.

**Example:**

The CRM transport defines the validation function as a static function on the RTDCrmAddress class.

10. Define the class destructor as required.

**Example:**

The RTDCrmAddress class does not allocate any memory. The default destructor generated by Rational Rose RealTime is sufficient.

11. Assure that the class is sendable.

The C++ TargetRTS generateDescriptor property should be set to "True." The attributes added to the subclass need to be of types that can be sent (for example, your internal classes that have the generateDescriptor property set to true, Rose RealTime classes such as RTString or primitive data types such as int). You can also write your own encode/decode functions.

### Implementing the RTDTransportEndpointFactory Subclass

To implement the RTDTransportEndpointFactory subclass:

1. Review the description of the RTDTransportEndpointFactory class.
2. Define the implementation of the following abstract operations:
  - a. newTransportEndpoint
  - b. releaseTransportEndpoint

## Implementing the RTDTransportEndpoint Subclass

To implement the RTDTransportEndpoint subclass:

1. Review the description of the RTDTransportEndpoint class.
2. Review the description of the RTDConnexisApi class.
3. Decide if your transport is blocking or non-blocking.
4. Decide the format of your messages.
5. Define the constructors for the subclass.

The subclass requires a constructor that accepts the destination address (RTDTransportAddress subclass), a unique identifier (RTDConnectionId) and a pointer to the Connexis API.

6. Define the implementations for the following abstract operations:
  - a. bind
  - b. reset
  - c. sendData
  - d. queueData
  - e. sendQueueData
  - f. sendAudit
  - g. queueAudit
  - h. sendQueueAudit
  - i. reset

The bind and reset methods are called by the DCS. The remaining functions that are called depend upon whether or not the transport blocks when binding to an endpoint or sending a message.

If the transport can block when binding or sending messages, provide full implementation for queueData, sendQueueData, queueAudit, sendQueueAudit and stubs, sendData and sendAudit.

If the transport does not block when binding or sending messages, provide full implementations for sendData, sendAudit and stubs, queueData, sendQueueData, queueAudit, and sendQueueAudit.

### **Example:**

For CRM, full implementation has been provided for all the RTDCrmEndpoint abstract functions. Since the transport is configured as blocking, only the queueData, sendQueueData, queueAudit, and sendQueueAudit functions are called when a message is sent.

For CDM, full implementation has been provided for all the RTDCdmEndpoint abstract functions. Since the transport is configured as non-blocking, only the sendData and sendAudit functions are called when a message is sent.

7. Define the class destructor as required.

The class destructor should not be blocking. The reset function is called prior to the release of an endpoint. If the cleanup of an endpoint is blocking, it takes place in the reset function.

### Implementing the RTDTransport Subclass

To implement the RTDTransport subclass:

1. Review the description of the RTDTransport class.
2. Review the description of the RTDTIF class.
3. Review the description of the RTDProfile class.
4. Review the description of the RTDConnexisApi class.
5. Decide the format of the listening point information the user supplies.
6. Decide the format of your messages.
7. Decide the strategy that you will implement to listen on transport endpoints.
8. Define the constructor RTDTransport subclass.

The constructor of your transport class registers itself with the DCS. You may want to accept some additional configuration information in the parameters of the constructor.

#### **Example:**

The constructor of the RTDCrmTransport receives a flag indicating whether or not it should listen on the thread of the transporter or create its own thread for listening.

9. Create a wrapper class for the RTDTransport subclass.

User models reference this class. This allows them to transparently register the transport. It should have a single attribute that is a pointer to the RTDTransport subclass. The dependency should be a forward reference in the header and an inclusion in the implementation. The constructor of the class should create a new instance of the RTDTransport subclass.

10. Define the implementations for the following abstract operations:



- a. `configureTransport`
  - b. `startTransport`
  - c. `cnxDump`
  - d. `cnxHelp`
  - e. `shutdownTransport`
11. Define the listener functionality required by your transport.

### Building the Transport Integration

To build the transport integration:

1. Create a C++ Library Component.  
The Reference tab contains the package(s) containing the Transport Integration classes just implemented. It should not contain any of the classes in the `RTDTransportIntegrationClasses` logical package.  
Set any other build information specific to your transport (for example, the inclusion path for your header files of the transport, libraries the integration depends on, etc.)  
See “Connexis Customization Reference” on page 261 for information on the compiler flags required to enable metrics collection and tracing.
2. Create a dependency from your C++ Library Component on the `TransportIntegrationFramework` component in the `RTDTIFComponents` component package.
3. Build your C++ library component.  
The header file generated for the wrapper class and the library built should be placed in a location available to the models using the transport.

### Packaging the Transport Integration

Now that the Transport Integration library has been built you will want to try using the transport in a the DCS model. You will need to create some interfaces in order to make use of the library in another RoseRT application (refer to the “Generating and Sharing Library Interfaces” chapter in the Rational Rose RealTime, C++ Reference).

### Using the Transport Integration in Another Model

To use the transport integration in another model:

1. Share into the other model the logical and component packages just created (refer to the "Generating and Sharing Library Interfaces" chapter in the Rational Rose RealTime, C++ Reference).
2. In the capsule that contains the RTDBase capsule (or a subclass contained in that capsule), create an association with the type of your RTDTransport wrapper class.
3. On a component diagram, create a dependency from the executable component on the Transport Integration external library component.
4. Prepare documentation that describes the addressing format and any recommended parameter settings.

### Testing the Transport Integration

To test the transport integration:

1. Test your transport integration with a simple model.

**Example:**

Modify an example model that is known to work (BasicTest) with CDM or CRM to make use of your transport.

2. Test your Transport Integration as much as possible before including in a complex application. This might include testing in the following areas:
  - a. using the locator with your transport as the preferred transport (modify HelloConnexis)
  - b. transport failures and subsequent recovery
  - c. errors in command line arguments, and registration strings
  - d. heavy load situations

### TIF Classes

---

The following section describes the Transport Integration Framework classes that are to be subclassed.

---

**RTDTransportAddressFactory**The purpose of the address factory is to create and release instances of the `RTDTransportAddress` subclass. The functions should be re-entrant since addresses may be created and released by multiple threads. You can use `new` and `delete` to create the addresses, or you might want to use your own memory management routines to efficiently create and release addresses. The four operations that must be implemented in the subclass are:

---

**Function**

---

```
RTDTransportAddress * newTransportAddress( const RTDTransportId &
addrType, const char * const addr)
```

**Description**

This function is responsible for constructing an instance of the `RTDTransportAddress` subclass from a string representation of an address. The type supplied is the one that was assigned to the transport at configuration time. In the event you have more than one registered transport sharing the same address factory, you will be able to determine which transport address subclass to create. The address string supplied will have been validated previously by the address validation function supplied for the transport. The string representation supplied will include the protocol.

**Example:**

The `crm` address factory `RTDCrmAddressFactory` uses `new` to create instances of `RTDCrmTransportAddress`. It receives a string of the form `"crm://<host>:<port>"` (ie. `"crm:myhost:9000"` or `"crm:123.111.11.22:9000"`). It will supply the ID and `addr` values to the `RTDCrmAddress` constructor. The `cdm` address factory performs similar processing.

---

---

### **Function**

---

```
RTDTransportAddress * newTransportAddress( const  
RTDTransportAddress & address)
```

### **Description**

This function is responsible for constructing a copy of the transport address instance supplied. The instance supplied will be the transport specific subclass of RTDTransportAddress. In the event that you have registered your factory with more than one transport, the class RTDTransportAddress has a method transportId() which will return the ID of the transport the address represents.

### **Example:**

The crm address factory RTDCrmAddressFactory uses the operator new and the RTDCrmAddress copy constructor to construct a copy of the address supplied. Because the copy constructor of RTDCrmAddress is used, the cast address must be of type "const RTDCrmAddress &" prior to invoking it.

The cdm address factory performs similar processing.

---

---

**Function**

---

```
RTDTransportAddress * newLocalAddress( const RTDTransportId & type)
```

**Description**

This function is responsible for constructing the RTDTransportAddress subclass that represents the local endpoint address (for example, the address at which this component instance can be reached at). Essentially this is the resolved result of the information supplied via the CNXep parameter.

This address returned is used to determine whether explicit addresses are local. The string representation of the address returned is used when publishing services to the locator. The string format of the address (for example, the result of the endpoint() function) will be used by the application when publishing SPPs. It is a good idea to ensure the address supplied is distinct. The address returned is also used when performing loopback processing.

**Example:**

The RTDCrmTransport class creates during startup an instance of RTDCrmAddress that represents the local listening address. The newLocalAddress function calls newTransportAddress with the local listening address to obtain a copy. The cdm address factory performs equivalent processing.

---

**Function**

---

```
void releaseAddress( RTDTransportAddress * & address )
```

**Description**

The DCS transporter will call this function to release the addresses provided through the new functions above. This allows you to reclaim storage allocated for the address.

**Example:**

The RTDCrmTransport class uses delete to release the RTDCrmAddress instance. It also sets the address pointer to zero for safety. The cdm address factory performs equivalent processing.

---

## RTDTransportAddress

The purpose of RTDTransportAddress is to provide a common string representation of an address for use in the DCS as well as a transport dependent representation of the address for use by the transport integration.

The class is designed to be sendable and the subclass must also be designed to be sendable. The class will only be sent within the process in which it was created, not to other processes therefore the context information for local, resolved does not need to be re-determined after a send. It is sent in messages only when conveying the results of the resolve.

The base class address attributes are:

---

**Attribute**

---

RTDTransportId \_transportId

**Description**

This is the ID assigned to the transport when it was registered. It is typically used internally to lookup the properties of the transport and for reporting metrics. This should not need to be updated by the subclass.

---

---

**Attribute**

---

RTString \_endpoint

**Description**

The string representation of the address supplied. The string is what was supplied during an explicit sap registration with the "dcs:" prefix removed and the service name (and preceding "/" removed). This should not need to be updated by the subclass

---

---

**Attribute**

---

bool \_local

**Description**

Identifies if this address is equivalent to the listening address of the component instance. If the address matches the address that the transport is currently listening on, you should set this flag to true. Often the decision of whether or not an address is local or not can only be made after the address is resolved.

---

---

**Attribute**

---

bool \_valid

**Description**

Identifies if the address is valid or not.

---

---

**Attribute**

---

bool \_isResolved

**Description**

Identifies if the address requires resolution or not.

---

---

**Attribute**

---

bool \_originalAddressWasResolved

**Description**

Identifies if the string address from which the object was constructed was resolved or not. An address may originally be unresolved and then later become resolved (\_isResolved becomes true). Addresses that were originally unresolved may be re-resolved during transport recovery (depending on the transports configuration).

---

## Constructors

The subclass requires two constructors. One accepts the transport ID and a string representation of the address and the other is a copy constructor.

When constructing from a string representation, you can assume the string has been previously validated. The constructor is expected to construct the RTDTransportAddress base class with the transport ID and string.

The constructor should then determine if the address is resolved. If the address is not resolved, \_isResolved and \_originalAddressWasResolved flags should be set to false. The DCS transporter will call the resolve function from a helper thread or call setResolved later. If the address is already resolved, the \_isResolved and \_originalAddressWasResolved flags should be set to true.

If an address is resolved, it can be determined if the resolved address is local. A local address is an address that is equivalent to the address at which the current process is listening.

**Example:**

In the CRM case, the constructor parses the string supplied and extracts the IP address if present and the port number. If the address is resolved, it compares this address against the address that represents the local address (a public static attribute of `RTDCrmTransport`) to determine if it matches the listening address of the process. The `_local` flag is set accordingly. For example, if the application was listening at `crm://192.123.012.22:9080` and the address supplied was `"crm://192.123.012.22:9000"` the address resolves to the same machine, but not the same port (not the same process), so `_local` would be `false`.

The copy constructor is expected to construct the base class with a `RTDTransportAddress` object reference. It should also copy across any of the subclass's information. In the CRM case, the IP address and port information are copied across along with the unresolved host name.

Abstract functions requiring an implementation:

---

**Function**

---

```
const char * unresolvedName()
```

**Description**

If an address may be unresolved, this function must return the unresolved portion of the address. This value is used during comparisons when searching the cache for a resolved address, and for finding endpoints waiting for the result of the resolution. If the unresolved name is a substring of the `_endpoint` string, you will find it easiest to store the value in a separate `RTString`.

**Note:** *RTString* is used so that the class can easily be sent.

**Example:**

For CRM, if `_endpoint` was `"crm://ahost:9000,"` `"ahost"` would be the result.

---



---

**Function**

---

RTDResult resolve()

**Description**

This function should resolve the unresolved portion of the address and update the internal representation of the address, determine if the resolved address is local (for example, the listening point of the component instance) and set the `_isResolved` flag. The return value indicates success or failure.

This function will be called on a helper thread and its functionality can be blocking. The resolve can involve looking up a name in a naming service, looking up an IP address for a host name, etc. The resolve is expected to only be concerned with the `unresolvedName()` portion of the address supplied during construction.

If the unresolved portion of the address can be successfully resolved, the resolved address should be further examined to see if it is the same address that the transport is currently listening on and set the `_local` flag accordingly. The `_isResolved` flag should be set to true and `RTDSuccess` returned.

If it can not be resolved, the `_isResolved` and `_local` flags should be set to false and `RTDFailure` returned. In the failure case, it is strongly recommended that you generate an informative trace event so the users of your transport can determine that the address was not resolved.

Re-resolution of the address will be performed after a delay depending on the interest in the address and your configuration (for example, the function can be called multiple times in both success and failure situations). Multiple threads will not call the same function on an instance of the class.

**Example:**

For CRM, the host name is looked up to determine the IP address. The `sameAddress` function is called with the listening point of the transport (a static attribute of the `RTDCrmTransport` class) to determine if it is local or not. It will return `RTDSuccess` if it can determine the IP address and `RTDFailure` if it fails. The IP address is stored in the `RTDCrmAddress` class. When resolving the address, it only looks at the host name and ignores the port.

---

---

### Function

---

```
void setResolved( const RTDTransportAddress& resolvedAddress)
```

### Description

This function is supplied the results of a resolved address. It should update the internal representation with the results of the resolution. It must set the `_isResolved` flag to true. At this time you should also determine if the address is local, that is it is the address the transport is listening at, and set the `_local` flag accordingly.

### Example:

For CRM, the results of resolving a host name is the IP address. In this function the IP address is only copied. The port number is not copied since it is not part of the information being resolved. The `_isResolved` flag is also set to true. It is determined if the address is local or not by calling the `sameResolved` function with the listening point. The listening point is a static attribute of the `RTDCrmTransport` class.

---

---

### Function

---

```
RTDResult sameResolved( const RTDTransportAddress& rhs )
```

### Description

This function should compare the internal transport specific representation of the rhs against this objects internal representation, to see if they are the same. `RTDSuccess` is to be returned if the address is the same. `RTDFailure` is to be returned if the address is different.

If the transport does not have an internal representation of the address and only uses the endpoint string with which it was created, the function should return whether or not the two endpoint strings are equivalent (for example, the result of `sameUnresolved(rhs)`). The DCS only calls this function if the rhs is the same transport type as the object.

### Example:

In the CRM case the IP address and port numbers are compared to see if they are the same.

---

## RTDTransportEndpointFactory

The purpose of the endpoint factory is to create and release instances of the RTDTransportEndpoint subclass. The functions should be re-entrant since midpoints may be created and released by multiple threads. You can use new and delete to create the addresses, or you might want to use your own memory management routines to efficiently create and release addresses.

The abstract operations that must be implemented in the subclass are:

---

### Function

---

```
RTDTransportEndpoint* newTransportEndpoint(const  
RTDTransportAddress &, const RTDConnectionId &, const  
RTDConnexisAPI *)
```

### Description

This function is responsible for constructing an instance of the RTDTransportEndpoint subclass. The transport Address and ConnectionId are required by the underlying RTDTransportEndpoint subclass.

### Example:

For CDM, this function will construct a new instance of RTDCdmEndpoint off of the heap with the information supplied.

For CRM, the function will construct a new instance of RTDCrmEndpoint off of the heap with the information supplied. Due to the nature of the CRM transport, a list of endpoints is maintained. Since multiple threads can create and release a CRM endpoint, the update of the list is protected by a mutex.

---

---

### Function

---

```
void releaseEndpoint( RTDTransportEndpoint *& )
```

### Description

This function is responsible for releasing the storage allocated for the endpoint.

### Example:

For CDM, the endpoint was allocated from the heap and will be deleted. The pointer supplied is set to 0 for safety sake afterward.

In the CRM case, while the DCS is no longer referencing the endpoint, the CRM listener may still be referencing it. The listener is notified that the endpoint is no longer of interest and the deletion request is in a sense deferred until after the listener is no longer referencing the endpoint. The pointer supplied is still set to 0 for safety sake.

---

## RTDTransportEndpoint

This class is responsible for the binding and resetting the endpoint. It is also responsible for sending messages.

If the transport profile indicates that the transport is blocking, the functions will be run on one of the helper threads. Any of the helper threads may be calling the functions, but only one helper thread at a time will call the bind and send functions. If it is a non-blocking transport, the functions will be run on the thread of the transporter.

There are a number of abstract operations that need to be implemented for this class. When implementing these operations, you should update the metrics regarding the messages sent and received. Metrics regarding failed messages are collected by the DCS. You will also want to use trace macros to log the encoded data sent. Errors and other events should also be reported using the trace macros to provide detailed information to the users of the transport. Information logged with the trace macros is available in the viewer. See “Connexis Customization Reference” on page 261, for the compiler options required for collecting metrics and doing tracing.

---

The base class address attributes are:

---

**Base Class Attribute**

---

RTDConnectionId cid

**Description**

Unique identifier for the endpoint. The DCS will supply the unique value to the endpoint factory.

---

---

**Base Class Attribute**

---

RTDTransportAddress \* destination

**Description**

The address of the component instance the endpoint is to communicate with.

---

---

**Base Class Attribute**

---

bool bound

**Description**

Indication of whether the endpoint is bound or not. The endpoint subclass is responsible for maintaining this value.

---

## Constructor

The subclass requires a constructor that accepts the destination address (RTDTransportAddress subclass), a unique identifier (RTDConnectionId) and a pointer to the Connexis API. The base class constructor does not require as an argument the API pointer. You may want to keep the pointer for ease of access to the API. The transport address may or may not be resolved at construction time. The DCS will update the address later if unresolved. It will be resolved before bind and send functions are called. The DCS will also bind the endpoint prior to sending the initial message. The connection ID is a unique ID that is supplied to the endpoint for identification purposes. If there is a need to asynchronously notify the DCS of failures, this connection ID must be supplied.

Abstract functions requiring an implementation are as follows:

---

### **Function**

---

RTDResult bind()

### **Description**

This function returns the result of the bind. The bind function will be called before any messages are to be sent by the endpoint. The bind function is called just once (independent of the number of virtual circuits using the endpoint). After a transport failure, it will be called after the reset to put the endpoint back into service. The bound attribute must be updated to reflect the results of the bind.

### **Example:**

For the CRM transport it will perform a connect to obtain a connection to the destination identified by the transport address subclass.

For the CDM transport, the bound flag is set to true. There is no bind work required for the underlying UDP/IP transport.

---

### **Function**

---

void reset()

### **Description**

This function will be called to allow the endpoint to reset itself (unbind). After a reset, the destination address may be updated with a re-resolved address, the endpoint may be rebound, or the endpoint may be released. This function can be blocking if the transport has been configured as blocking. The releaser (destructor) of the subclass should not be blocking.

---

**Function**

---

RTDWriteResult sendData(RTDDDataHdr &, const char \* signal, void \* data, const RObject\_class \* type)

**Description**

This function will be called if the transport is non-blocking to send a message. The header information is expected to arrive intact at the destination. The header will indicate the type of data message (whether the originating address is required), the preferred encoding for the data and information about the virtual circuit.

Typical processing for this function involves creating a message and sending it. You can use the RTDMblk and RTDMemPool classes to make use of buffers setup through the -CNXtbp parameter. Since the transport is non-blocking you may want to obtain a single buffer during startup and use it exclusively. Creating the message will involve placing the information to be sent in your message layout. To encode the data object to be sent, use the encode API function. You will want to encode the other information in the message if you are not operating in a homogenous environment. You can also encrypt or compress the message at this time.

Just prior to sending the message, you should use the trace macros to log the data being sent. After the message is successfully sent, you should update the metrics with the information about the message sent. The write result returned by the function indicates success, transport failure, or transport failure/recovery.

When transport failure is returned the subscribers (SAPs) registered for the destination will become unbound. Once the DCS is able to put the endpoint back into service (for example, a reset, a successful bind), the DCS will re-establish the virtual circuit for the subscribers. All publishers (SPPs) that were bound to the destination will become unbound and available for use by other subscribers.

Transport failure/recovery means that the send of the message failed, but the transport has been recovered (for example, fail over). For example, if your transport address syntax supported alternate destinations, when one address is determined to have failed, the endpoint could fail over to the next address. The subscribers and publishers will become unbound as in a Transport failure situation. The DCS will immediately re-establish the virtual circuits for the subscribers.

---

---

### Function

---

```
RTDResult queueData( RTDDataHdr &, const char * signal, void * data,  
const RTOBJECT_class * type, mblk_t *& queueData, unsigned long &  
queueDataSize)
```

### Description

This function will be called if the transport is blocking. It is expected to prepare information to be queued in preparation to be sent later. This function is expected to encode at a very minimum the data object into a mblk. The header, signal, and the queue data are maintained in a queue until it is time to send the data. The function is called from the transporter thread so it should not block.

The function should return a pointer to the mblk containing the encoded data and the size of the information in the mblk. If the message is to be queued to be sent later (for example, a data object successfully encoded), then RTDSuccess should be returned. Otherwise RTDFailure should be returned and the message will be dropped.

### Example:

The CRM transport calculates the offset in the message at which to place the encoded data. It then calls the encode API function to encode the data object. If there is no data (for example, the application is sending just a signal, or scalar data) to be sent after the encoding, it returns RTDSuccess. It will obtain an mblk for the header information when it is time to send the data (CRM optimizes its use of the buffers). If there is data, then the header information is placed at the start of the mblk.

---



**Function**

---

RTDWriteResult sendQueueData( RTDDataHdr &, const char \* signal, mblk\_t \* queueData, const unsigned long& queueDataSize)

**Description**

This function will be called if the transport is blocking to send the queued data. The function is called from one of the helper threads and may block. The header information, signal and mblk previously created in the queue data step are supplied. The result indicates success, transport failure, transport failure/recovery. The caller of the function will free the mblk passed as an argument.

You will want to encode the other information in the message if you are not operating in a homogenous environment. You can also encrypt or compress the message at this time.

Just prior to sending the message, you should use the trace macros to log the data being sent. After the message is successfully sent, you should update the metrics with the information about the message sent. The write result returned by the function indicates success, transport failure, or transport failure/recovery.

When transport failure is returned the subscribers (SAPs) registered for the destination will become unbound. After the DCS is able to put the endpoint back into service (a reset, a successful bind), the DCS will re-establish the virtual circuit for the subscribers. All publishers (SPPs) that were bound to the destination will become unbound and available for use by other subscribers.

Transport failure/recovery means that the send of the message failed, but the transport has been recovered (fail over). For example, if your transport address syntax supported alternate destinations, when one address is determined to have failed, the endpoint could fail over to the next address. The subscribers and publishers will become unbound as in a Transport failure situation. The DCS will immediately re-establish the virtual circuits for the subscribers.

**Example:**

The CRM Transport creates the message if an mblk containing the message is not supplied. If an mblk is supplied the message was prepared in the queueData function. The message is encoded and then sent. The message is logged using the trace facilities and the metrics are updated.

---

---

### Function

---

RTDWriteResult sendAudit(RTDAuditHdr &, void \* data, const RTOBJECT\_class \* type)

### Description

Similar to the sendData function except it is audit information being sent. The resolved originating address must be available at the destination.

---

---

### Function

---

RTDResult queueAudit( RTDAuditHdr &, void \* data, const RTOBJECT\_class \* type, mblk\_t \*& queueData, unsigned long & queueDataSize)

### Description

Similar the queueData function except it is audit data that is being prepared to be queued. In most cases (100% if both ends have the same release of Connexis) no data is ever sent in an audit message.

---

---

### Function

---

RTDWriteResult sendQueueAudit( RTDDataHdr &, mblk\_t \* queueData, const unsigned long& queueDataSize)

### Description

Similar to the sendQueueData except it is for audit messages. Again the resolve local address is to be known on the other side.

---

---

## RTDTransport

The primary responsibility of this class is to configure, start and shutdown the transport. When a transport is registered with the DCS, a pointer to an instance of this class must be supplied.

---

### Function

---

RTDResult configureProfile( RTDTransportProfile &)

### Description

During the DCS setup, this function will be called prior to starting the transport to obtain additional configuration information. The information supplied will be pre-populated with information supplied during registration and from parameter parsing. You can override the information provided by parameter parsing and can perform any necessary transport specific validation of the parameter values. If the function returns a RTDSuccess, the transport will be started.

### Example:

The CRM transport saves the parameter information for later use. It then fills in the profile received with information about the transport. This includes creating the factory classes.

---

### Function

---

RTDResult startTransport( const RTDConnexisAPI \* )

### Description

The purpose of this function is to allow the transport to initialize itself. API supplied describes the interfaces to use to communicate with the DCS. This function is called from the transporter thread during startup.

The function should return RTDSuccess or RTDFailure. If the RTDSuccess is returned, the transport becomes available to the application. If it returns RTDFailure, the transport will not be considered as started and can not be used by the application. If the DCS was not able to start the transport, it will not shut it down.

### Example:

For CRM, the listening endpoint information is validated and a socket is created to listen for incoming connections. Depending on how CRM was configured a separate thread for the listener will be created or it will run on the transporter's thread.

---

---

### Function

---

RTDResult shutdownTransport( )

### Description

The DCS transporter will call this function during shutdown. The address and endpoint subclasses will be released prior to calling this function. You can not call any of the DCS functions at this point. You are expected to shutdown your transport cleanly and reclaim its resources. This includes deleting the RTDTransportAddressFactory and RTDTransportEndpointFactory objects supplied during configuration.

---

---

### Function

---

void cnxDump( )

### Description

This function will be called during startup if the end user of the application has used the -CNXdump command line parameter. This allows you to dump to the log any of the transport specific parameter setting that will be of use to the end user. It will be called during the DCS startup after configuration of the transport has taken place. Use the RTDTransport::log function to put the messages safely to the log.

---

---

### Function

---

void cnxHelp( )

### Description

This function will be called during startup if the end user of the application has used the -CNXhelp command line parameter. This allows you to put to the log any information specific to using your transport. For example, this would include information on command line parameters that your transport supports, format of the CNXep parameter if applicable, etc. Use the RTDTransport::log function to put the messages safely to the log.

---

## RTDTIF

Use this class utility to register the transport.

---

### Function

```
RTDResult registerTransport( const char * transportName, int
totalProtocols, char ** protocolList, RTDTransport * transport)
```

### Description

Transports must be registered prior to starting the DCS. That is, prior to the incarnation of RTDBase or related subclass (RTDBase\_Locator, RTDBase\_Agent, RTDBase\_Locator\_Agent). See the RTDTransportProfile class description for more information on transportName, totalProtocols and protocolList. The transport parameter is an instance of the RTDTransport subclass. During startup, the configure and startup functions on the transport instance will be called.

### Example:

During construction of the RTDCrm class, an instance of the RTDCrmTransport class is created. The register method on this class is called to have it register with the DCS. The static method RTDTIF::registerTransport is called. The user must only create an instance of the RTDCrm class prior to incarnating RTDBase or a related subclass.

---

## RTDTransportProfile

This class describes the transport to the DCS. It is initialized with default values and any of the settings that can be overridden by command line arguments. An instance of this class is provided during the configuration of the transport. The attributes include:

---

### Attribute

char \* transportName

### Description

The name of the transport supplied during registration

---

### Attribute

int totalProtocols

### Description

The number of protocols supported by the transport. This information was supplied during registration.

---

---

**Attribute**

---

char \* transportProtocols[totalProtocols]

**Description**

Array of the protocols supported by the transport This information was supplied during registration.

---

---

**Attribute**

---

RTDTransportID \*transportID

**Description**

The ID assigned by the DCS to this transport, during the registration process.

---

---

**Attribute**

---

RTDTransportEndpointFactory \* endpointFactory

**Description**

An instance of the endpoint factory subclass to be used by the DCS to create endpoints.

---

---

**Attribute**

---

RTDTransportAddressFactory \* addressFactory

**Description**

An instance of the address factory subclass to be used by the DCS to create addresses.

---

---

**Attribute**

---

int (\*RTDAddressValidatorFcn) ( const char \* ) addressValidator

**Description**

Pointer to an address validation function. This will be called to validate the address supplied in the registerSAP call.

---

---

**Attribute**

---

RTObject\_class \* addressTypeDescriptor

**Description**

Pointer to the type descriptor of the RTDTransportAddress subclass. This is required so that the address can be sent in messages. You should turn the Generate Descriptor flag on for the RTDTransportAddress subclass, Rational Rose RealTime creates a type descriptor with the name in the format:

RTType\_<name of your subclass>

---

---

**Attribute**

---

RTDResolveConfig addressResolutionConfig

**Description**

Contains information that governs how addresses should be resolved. It will be initialized with values supplied by the user on the command line. The fields contained are:

- addressExpiry (-CNXtre) period in seconds. Basically the length of time the address can be used in subsequent connect requests before requiring that it be re-resolved. If zero, the address does not expire. It will be re-resolved though if the transport recovery configuration dictates it.
  - retryDelay (-CNXtre) period in msec. Basically the time (rounded up by a factor of CNXtap) before the address should be re-resolved in the case where the address resolution failed. If zero, a request to re-resolve the address will be queued immediately.
-

---

### Attribute

---

RTDTransportRecoveryConfig transportRecoveryConfig

### Description

Contains information that describes how to recover from transport failures. It will be initialize with values supplied by the user on the command line. The fields contained are:

- `bindFailureRetryDelay (-CNXtbrd)` in msec. Indicates after a bind fails, how long to delay before re-attempting to put the connection back in service (by re-resolving or rebinding).
  - `resolveAfterTransportFailure (-CNXtraf)` indicates after a transport failure whether the address should be re-resolved. This is applicable if the address was originally unresolved. If the address is re-resolved, it will also be rebound irrespective of the `rebindAfterTransportFailure` setting.
- 

---

### Attribute

---

transportNotifiesRecovery

### Description

After a transport failure, indicates if the transport will notify of a recovery (after a re-resolve and re-bind as applicable are performed). This allows them to implement their own transport auditing if ours is not appropriate. If true the endpoint remains out of service until transport recovery notification is received. No messages including audit messages will be sent on the endpoint. If false then the connection goes back into service after a successful bind. If false and `rebindAfterTransportFailure` is also false and the address does not require re-resolving (originally resolved or `resolveAfterTransportFailure` is false) then the connection will go immediately back into service.

---

---

### Attribute

---

RTDTransportAuditType periodicAuditType

### Description

The type of audit to be performed on a periodic basis. The types of audits available are `handshakeAudit`, `connectionAudit`, or `noAudit` (requests no auditing be done). See the Verifying Connections section in the Engineering chapter for more information on periodic audits.

---



---

**Attribute**

---

RTDHandshakeAuditConfig handshakeAuditConfig

**Description**

Configuration for the handshake audit. It is ignored if the periodic audit type is not handshakeAudit. The configuration includes:

- **auditISGranularity (-CNXtcapi)** Used to determine how many CNXtap periods constitute an audit period when an endpoint is in service.
  - **auditOOSGranularity (-CNXtcapo)** Used to calculate how many CNXtap periods constitute an audit period when an endpoint is out of service.
  - **auditsPassedForIS (-CNXthcai)** Number of successful handshakes needed for an out of service endpoint to go back into service.
  - **auditsPassedForOOS (-CNXthcao)** Number of consecutive failed handshakes (periods in which an I Am Alive response was not received) which will trigger an endpoint to transition out of service.
  - **auditsFailedForReresolve (-CNXtrhaf )** Number of consecutive failed handshakes after which the destination address of the endpoint should be re-resolved. If the destination address of the endpoint was originally resolved, this has no effect.
  - **YANRxForceOOS** Indicates if a YAN (You Are Not responsive) audit message should transition the endpoint out of service. This is typically set to true.
  - **YANTxEnabled** Indicates if a YAN (You Are Not responsive) audit message should be sent when an endpoint transitions out of service. This is typically set to true.
  - **piggyBackEnabled** - Indicates if user messages should be counted as activity during an audit period. For efficiency purposes this is typically on.
-

---

### Attribute

---

RTDConnectionAuditConfig connectionAuditConfig

### Description

Configuration for the connection audit. It is ignored if the periodic audit type is not connectionAudit.

The configuration includes:

- `auditISGranularity (-CNXtcapi)` - Determines how many CNXtap periods constitute an audit period when an endpoint is in service.
  - `piggyBackEnabled` - Indicates if user messages should be counted as activity during an audit period. For efficiency purposes this is typically on.
- 

### Attribute

---

bool useCustomController

### Description

Identifies whether the transport integration would like to use a custom controller. If true, the transport can specify wait and wakeup functions for the DCS Transporter's peer controller. Using a custom controller allows the transport integration to perform listening operations on the same thread as the DCS Transporter thus avoiding a context switch on incoming messages. Since there is one Transporter capsule (and thread), only one set custom controller functions can be specified (over all the transports). By default, useCustomController is true if no other configured transport has indicated it is using a custom controller. Transports are configured sequentially in the same order as they are registered. See the Rational Rose RealTime documentation for further information on Peer Controllers and Custom Controllers.

---

---

**Attribute**

---

RTDResetAuditConfig resetAuditConfig

**Description**

Configuration of the reset audit. See the Verifying Connections section in the Engineering chapter for more information on the reset audit. The configuration includes:

- enableResetAudit (-CNXtrae) identifies if the reset audit is to be performed. resolveAfterResetDetected indicates if the address should be resolved again before placing the connection back in service after a reset. The address will only be re-resolved if it was originally unresolved when specified in the registration string. If the address is re-resolved, it will be rebound afterwards.
  - rebindAfterResetDetected identifies if a bind should take place before putting the connection back into service.
- 

---

**Attribute**

---

bool blockingTransport

**Description**

Identifies if transport blocks on binds or sending messages. This determines if the bind/send calls should be performed from the transporter's thread or by the pool of helper threads.

---

---

**Attribute**

---

void (\*RTDCustomControllerFcn) () customControllerWaitFunction

**Description**

Wait function to used if using a customController.

---

---

**Attribute**

---

void (\*RTDCustomControllerFcn) () customControllerWakeupFunction

**Description**

Wakeup function to be used if using a customController.

---

---

### Attribute

---

void (\*RTDCustomControllerFcn) ( ) customControllerProcessFunction

### Description

Process function to be used if using a customController.

---

---

### Attribute

---

RTDTransport \* transport

### Description

Subclass of the RTDTransport class that will be called to configure, start, shutdown the transport. This has been set based on the information supplied during registration.

---

---

### Attribute

---

RTDTransportParameters parameters

### Description

Contains current parameter settings for configuration information that may be of interest to the transport. The parameters settings supplied are:

- RTString endpoint - (-CNXep)
  - long maxMsgSize - (-CNXtmts)
  - short firstMsgSize - (-CNXtfms)
  - int threadPriority - (-CNXtp)
- 

## RTDConnexisAPI

An instance of this class is filled in by the DCS as part of the transport registration process. A pointer to the instance is supplied to the transport at initialization time and each time an instance of the RTDTransportEndpoint subclass is created. It contains the DCS interfaces available for use by the transport.

---

### Attribute

---

RTDTransportId transportId

### Description

ID assigned to the transport. To be used when reporting metrics.

---

---

**Attribute**

---

RTDResult (\*RTDRegisterEndpointFcn) ( RTDTransportEndpoint \*)  
registerEndpoint

**Description**

Allows the transport integration to register a endpoint created with the DCS Transporter. When there is no further interest in the endpoint, it will be released by the transporter through the transport endpoint factory for the transport.

**Example:**

The CRM transport may receive connect requests from other processes. When the connection is accepted, a socket is created. The socket information is placed in an endpoint representing the other destination and registered with the DCS transporter.

The CDM transport does not make use of this function. Initial messages from other component instances are passed like any other message to the DCS transporter. The first time the transporter sends a message to the originating destination, an endpoint will be created for the destination address via the address factory for the transport.

---

---

**Attribute**

---

RTDResult (\* RTDDataMsgReceiveFcn) ( const RTDMessageStatus status,  
const RTDDataHdr &, const char \* signal, void \*\* data, const  
RTOBJECT\_class \* type) dataMsgReceive

**Description**

When a RTDDataMsg message is received, the Transport Integration should call this function supplying the data message. It will need to extract the information from the message and decode the data object sent. If the decode failed (unknown encoding, etc. It can be conveyed in status). The other information is equivalent to what was passed on the sendData or queueData call. The caller of this function is responsible for releasing the storage for status, header and signal only (not the data and not the type).

---

---

### Attribute

---

```
RTDResult (* RTDDataWithSenderMsgReceiveFcn) ( const
RTDMessageStatus status, const RTDDataHdr &, const char * signal, void
** data, const RTOBJECT_class * type, RTDTransportAddress *)
dataWithSenderMsgReceive
```

### Description

When a RTDDataWithSenderMsg message is received, the Transport Integration should call this function or the dataWithSenderCidMsgReceive function supplying the data message along with the resolved address of the sender. The Transport Integration will need to extract the information from the message and decode the data object sent. If the decode failed (unknown encoding, etc. it can be conveyed in status). The other information is equivalent to what was passed on the sendData or queueData call. The caller of this function is responsible for releasing the storage for status, header, signal and transport address (not the data and not the type).

---

---

### Attribute

---

```
RTDResult (* RTDDataWithSenderCidMsgReceiveFcn) ( const
RTDMessageStatus status, const RTDDataHdr &, const char * signal, void
** data, const RTOBJECT_class * type, RTDTransportAddress *, const
RTDConnectionId &) dataWithSenderCidMsgReceive
```

### Description

When a RTDDataWithSenderMsg message is received, the Transport Integration should call this function or the dataWithSenderMsgReceive function supplying the data message along with the resolved address of the sender and the connection ID of the endpoint the message was received on. The Transport Integration will need to extract the information from the message and decode the data object sent. If the decode failed (unknown encoding, etc. it can be conveyed in status). The other information is equivalent to what was passed on the sendData or queueData call. The caller of this function is responsible for releasing the storage for status, header, signal, transport address and connection ID (not the data and not the type).

---

---

**Attribute**

---

```
RTDResult (* auditMsgReceiveFcn) ( const RTDMessageStatus, const
RTDAuditHdr &, void **, const RTOBJECT_class *, RTDTransportAddress *)
auditMsgReceive
```

**Description**

When an audit message is received, the transport should call this function (or the `auditWithCidMsgReceive` function) supplying the audit message and the resolved address of the sender. The Transport Integration will need to extract the information from the message and decode the data object sent. If the decode failed (unknown encoding, etc. it can be conveyed in status). The other information is equivalent to what was passed on the `sendAudit` or `queueAudit` call. The caller of this function is responsible for releasing the storage for status, header and transport address not the data and not the type).

---

**Attribute**

---

```
RTDResult (* auditWithCidMsgReceiveFcn) ( const RTDMessageStatus,
const RTDAuditHdr &, void **, const RTOBJECT_class *,
RTDTransportAddress *, const RTDConnectionId &)
auditWithCidMsgReceive
```

**Description**

When an audit message is received, the transport should call this function (or the `auditMsgReceive` function) supplying the audit message, the resolved address of the sender and the connection ID of the endpoint on which the message was received. The Transport Integration will need to extract the information from the message and decode the data object sent. If the decode failed (unknown encoding, etc. it can be conveyed in status). The other information is equivalent to what was passed on the `sendAudit` or `queueAudit` call. The caller of this function is responsible for releasing the storage for status, header and transport address and connection ID (not the data and not the type).

---

---

### Attribute

---

RTDResult (\* encodeFcn) (void \* unencodedData, const RObject\_class \* dataType, const unsigned char preferredEncoding, unsigned char & encodingUsed, mblk\_t \*& mblockOfEncodedData, const unsigned long offset, unsigned long & encodedDataSize, unsigned long & dataVersion, const unsigned long firstMsgSize, const unsigned long maxEncodedSize) encode

### Description

This function will encode the "unencodedData" data object of type "dataType" using the "preferredEncoding". It will return the actual encoding used in "encodingUsed". This "encodingUsed" information should be provided in the message sent (we suggest you store the value back in the header). It will also supply the "dataVersion" (sometimes used to store other information). This information should be provided in the message sent (we suggest you store the value back in the header). You may supply a mblk to encode the data into, or have the encode routine find an appropriately sized mblk. The encoding will return "mblockOfEncodedData" the mblk in which the data was encoded along with "encodedDataSize" the size of the encoded data. "offset" dictates where in the buffer the data should be encoded. This allows you to reserve room in the mblk for your message header information. The firstMsgSize and maxEncodedSize identify the initial buffer size to obtain and the maximum encoded size allowed.

If you use the encode function to encode the data, you must use the decode function to later decode it (even if the encodedDataSize is zero).

---

---

### Attribute

---

RTDMessageStatus (\* decodeFcn) (const unsigned char dataFormat, unsigned char \* encodedData, const unsigned long encodedDataSize, const unsigned long dataVersion, void\*\* decodedData, const RObject\_class \*\* decodedDataType) decode

### Description

This function will decode the "encodedData" data that has been encoded using "dataFormat" encoding. "dataFormat" corresponds to the "encodingUsed" value returned by the encode function. "encodedDataSize" identifies the size of the data. Decode returns "decodedData" (pointer to data object) and "decodedDataType" (type of object). The return value indicates the success of decoding the message. It should be passed to the DCS when supplying the message received.

---



---

**Attribute**

---

void (\* RTDTransportNotifyFcn) (const RTDConnectionId &)  
transportFailure

**Description**

This function should be used by the Transport Integration to report asynchronously a transport failure.

**Note:** *The failures that occur during sends should not use this function. The return code of the send function reports the failure. The connection ID supplied identifies the endpoint which failed.*

---

---

**Attribute**

---

void (\* RTDTransportNotifyFcn) (const RTDConnectionId &)  
transportFailureRecovery

**Description**

This function should be used by the Transport Integration to report asynchronously a transport failure and subsequent recovery. Note that failures and recoveries that occur during sends should not use this function. The send function's return code reports the failure and recovery. The purpose is to report the transport failed, but it has been re-established however there is no guarantee that it is with the same process. The subscribers (SAPs) and publishers (SPPs) will be unbound. The DCS will re-establish the virtual circuits for the subscribers.

---

---

**Attribute**

---

void (\* RTDTransportNotifyFcn) (const RTDConnectionId &)  
transportRecovery

**Description**

This function should be used by the Transport Integration to report asynchronously transport recovery. This function should only be used if the Transport Integration has been configured with "transportNotifiesRecovery" as true. The DCS will mark the endpoint as back in service and will re-establish the virtual circuits for the subscribers.

---

---

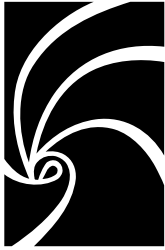
### **Attribute**

```
void (* RTDNotifyIncompatibleFcn) (const RTDTransportAddress *)  
notifyIncompatibleRequest
```

### **Description**

This function should be used by Transport Integration to send notification to the sender that it did not understand the message received (incompatible Transport Integration message formats). The caller of the function is responsible for releasing the address. The virtual circuit will be taken out of service.

---



## *Appendix A*

# *Comparison of TCP/IP and UDP/IP*

---

TCP/IP and UDP/IP are socket based IPC protocols. CRM is based on TCP/IP and CDM is based on UDP/IP. CRM and CDM reflect the properties of the underlying transports. Conceptually speaking, socket based IPC provides an interface similar to that of file I/O. Initially, a system call is used to create a socket. Internally, each process maintains a descriptor table, and whenever a socket is created, internal data structures are created and associated with the descriptor. The descriptor can then be used to manipulate the associated socket, just as one would use the file descriptor for performing file I/O. This hides the complexity of the inter-process communication by providing a very simple and familiar interface.

Both TCP and UDP have their advantages and disadvantages, and one or the other may be more suitable to a specific application. The main characteristics of the socket types are discussed below:

- **Transmission Control Protocol (TCP):**  
TCP uses IP, which provides the packet delivery services. TCP has the following characteristics:
  - Connection-oriented
  - Reliable
  - Flow-controlled
- **User Datagram Protocol (UDP):**  
UDP is also implemented on top of IP, and exhibits the following characteristics:
  - Connectionless
  - Unreliable (i.e. no guarantees regarding delivery)

The main difference between UDP and TCP from an application perspective is that TCP/IP is connection-oriented and reliable while UDP is connectionless and unreliable. The fact that TCP/IP is connection-oriented makes it impractical when you are dealing with a large number of connections.

For example assume that you were designing an IPC mechanism that was being used to provide communication between 100 nodes on a network. Further assume that each of these nodes needed to talk with every other node. This would result in a grand total of 4950 connections, each with a socket at both ends of the connection, for a total of 9900 sockets. Each socket requires an input and output buffer. Typical sizes for send and receive buffers for TCP/IP implementations range between 2K and 16K. These buffer sizes are configurable, but this would result in a memory usage across the entire system of:

- $2K \times 2 \text{ buffers} \times 99 \text{ sockets per node} \times 100 = 40M$  (for the 2K buffer)
- $16K \times 2 \text{ buffers} \times 99 \text{ sockets per node} \times 100 = 317M$  (for the 16K buffer)

This would result in per node memory usage of approximately 400K to 3M per node. This may be unacceptable for some embedded applications.

If UDP were used in this case these memory issues would not exist. With UDP, there is no acknowledgment of received packets. This usually means that you have to build the error handling and reliability specific code into the application.

There are also many cases where the error rate of the UDP connection is so low that the unreliable nature of UDP is not an issue. For example, if the network was operating over a backplane, it is quite common for the bus error rate to be less than the software error rate. Other examples of situations where UDP may be required (or preferable) to TCP/IP are:

- UDP must be used if the application uses broadcasting or multicasting of data packets.
- There are also some implementations of TCP that are very slow in comparison to UDP.

**A**

-a 27

adding

DCS Layer Notification 63

Address

definition 302

internal representation 308

transformation 307

user-specified 306

validation 306

Application layer 267

application layer (Connexis) 265

application layers

Connexis 13

Application Messages

definition 303

Audit

definition 302

Audit Messages

definition 302

**B**

Backus-Naur Form Grammar 245

binding failures 222

bindingNotification 113

bindingNotificationRequested 113

Bound Ports 227

broadcast

sends 132

buffer

configuration 266

count sizes 8

buffer configuration 266

**C**

C++ library

building library 297

C++ Library Component

configuring settings 294

creating 293

capsule

configuring for Connexis 85

initializing for Connexis 92

CDM 11, 87

CDM options 285

CDR

configuring encode/decode functionality 296

Circuit Binding Failures 222

- CNXep
  - when to supply 252
- CNXtepql Exceeded 224
- CNXtiql Exceeded 224
- CNXtoql Exceeded 224
- command line options
  - about 247
  - CNXagent\_auto\_start 288
  - CNXagent\_data\_block\_size 288
  - CNXagent\_num\_data\_blocks 288
  - CNXagent\_thread\_priority 265, 288
  - CNXagent\_trace\_buffer\_size 288
  - CNXagent\_truncate\_user\_data 288
  - CNXcdm\_max\_rx\_size 270, 282, 285
  - CNXcdm\_max\_tx\_size 271, 282
  - CNXcdm\_udp\_rx\_size 286
  - CNXcdm\_udp\_tx\_size 286
  - CNXdcs\_audit\_delay 277
  - CNXdcs\_audit\_enabled 277, 283
  - CNXdcs\_audit\_interval 277
  - CNXdcs\_cdm\_retry\_delay 277
  - CNXdcs\_locator\_retry\_delay 278
  - CNXdump 275
  - CNXendpoint 125, 154, 282
  - CNXhelp 275
  - CNXlocator\_audit\_delay 146, 287
  - CNXlocator\_audits\_oos 146, 287
  - CNXlocator\_backup 145, 147, 286
  - CNXlocator\_backup\_endpoint 146, 148, 149, 286
  - CNXlocator\_preferred\_transport 146, 287
  - CNXlocator\_primary 139, 145, 147, 148, 286
  - CNXlocator\_primary\_endpoint 126, 139, 146, 147, 286
  - CNXlocator\_retry\_delay 146, 287
  - CNXnobanner 276
  - CNXtran\_audit\_period 281, 284
  - CNXtran\_buffer\_pool 269, 281, 282
  - CNXtran\_cdm\_audit\_throttle 281
  - CNXtran\_cdm\_conn\_audit\_period 283, 284
  - CNXtran\_cdm\_conn\_audits\_is 283
  - CNXtran\_cdm\_conn\_audits\_oos 283
  - CNXtran\_default\_encoding 280
  - CNXtran\_endpoint\_queue\_limit 280
  - CNXtran\_first\_msg\_size 271, 282
  - CNXtran\_helper\_thread\_priority 265, 280
  - CNXtran\_helper\_threads 266, 280
  - CNXtran\_log\_bad\_msgs 278
  - CNXtran\_max\_msg\_size 282
  - CNXtran\_orb\_conn\_audit\_period 284
  - CNXtran\_out\_queue\_limit 268, 280
  - CNXtran\_reset\_audit\_enabled 283
  - CNXtran\_thread\_priority 265, 279, 285
  - CNXunique\_id 154, 166, 168, 178, 275
- command line options (Connexis) 250
- compiler version
  - updating 289
- component
  - configuring for Connexis 90
- component instance 56, 57
  - adding 177
  - changing properties 180
  - using CDM and CRM Endpoints 249

- using CDM Endpoint 248
  - with CDM and CRM 250
  - with fixed endpoints 247
- Component Instance defaults 159
- Configuration and Transports Settings 87
- configuring
  - component for Connexis 90
- conjugation names 42
- Connect Failures Received 227
- Connect Failures Sent 227
- connect\_retries 117
- connecting
  - wired ports 15
- Connection audit 273
- Connection Lifecycle 303
- connection patterns (Connexis) 108
- connections
  - explicit endpoint 124
  - explicit endpoint (Connexis) 7
  - local 119, 126
  - local (Connexis) 7
  - Locator 125
  - Locator (Connexis) 8
- Connexis
  - about 5
  - adding support for 59, 83
  - application layers 13
  - automatic versus Application registration 113
  - BasicTest Model 21
  - buffer usage 267, 268, 270
  - Client/Server pattern 108
  - command line options 261, 274
  - components 83, 85, 93
  - configuring a component 90
  - configuring capsules 85
  - connection options 118
  - connection patterns 108
  - converting models 99
  - create packages for a model 35
  - customization reference 261
  - datagram messaging 271
    - definition 11
  - DCS performance model 25
  - definitions 11
  - Development Approach 82
  - Enabled Components 91
  - engineering rules 261, 262
  - errors 255
  - fault-tolerance 9
  - initialization rules 93, 98
  - initializing capsule for 92
  - key benefits 5, 6, 7, 8
  - local connections 119
  - location transparency 7
  - locator service 17
  - messages 255
  - name resolution 118
  - overview 14
  - peer to peer pattern 109
  - ports 14
  - process view 263, 264, 274
  - reliability 9
  - support for distributed applications 9
  - TCP/IP 355
  - terminology 11
  - tutorial 31
  - UPD/IP 355
  - using 20
  - warnings 255

Connexis Datagram Messaging 11, 87

Connexis High-Level Design 301

- Connexis Locator Service 12
- Connexis Reliable Messaging 11, 87
- Connexis Viewer 9
- constructors (Connexis) 327
- contacting Rational technical publications iv
- contacting Rational technical support iv
- Control Messages
  - definition 302
- Controller 186
- Controller Audit 188
- creating
  - New TargetRTS Library 291
- CRM 11, 87
- crm 26
- CUID 160
  
- D**
- Datagram Messaging 187
- DCS 11, 15, 16, 68, 88, 112, 123, 127, 274
  - Agent 301
  - building the library 297
  - common customizations 289
  - creating target specific header files 292
  - definition 11
  - loadiing DCS model 293
  - Locator 301
  - Porting to a New Target Configuration 289
  - porting to a new target configuration 290
  - testing the port 297
  - Threading Model 304
  - Transporter configuration settings 278
- DCS and transport Layer 265
- DCS Architecture 301
- DCS command line options 277
- DCS Configuration 187
- DCS Interfaces
  - sharing 84
  - sharing into model 84
- DCS layer 268
- DCS libraries 289
  - building minimal configuration 289
  - customizing 289
  - porting 289
- DCS library 289
  - changing compilation flags 289
  - enabling metrics 238
- DCS Library Configuration 296
- DCS library port
  - testing 297
- DCS options 277
- DCS Performance Model 25
- DCS registration 245
- DCS Registrations
  - string grammar 245
- DCS threading model 304
- DCS Tracing Filters 186
- DCS with Locator 88
- DCS with Target Agent 88
- DCS with Target Agent and Locator 88
- defer
  - use of 133
- Defers 133
- deregisterSPP 112



Distributed Connection Service 11  
     *see DCS* 16  
 distributed Rose RealTime application  
     289  
     create 289  
 DNS 11  
 documentation feedback iv  
 Domain Name System 11  
 duplex locator service 11

**E**

Encode Buffer Unavailable 223  
 Encoding Exceeds Buffer Size 223  
 Endpoint  
     definition 302  
 endpoint 11, 82, 110, 118, 124  
     command line options 247  
     defined for transport integration 302  
     definition 11  
 error reporting RTDErrorType 104  
 errors  
     command line paramters 257  
     initialization errors 257  
     parameter errors 257

**F**

Fixed Initialization Order 98

**G**

getRegisteredName 113

**H**

Handshake audit 272

**I**

ILS 12, 112, 119, 123, 127  
     definition 12  
 Interaction Diagrams 202  
     generating 202  
 Internal Layer Service 12  
     *see ILS*  
 Inter-Process Communication 12  
 invoke 134  
     use of 132  
 Invokes  
     use of 132  
 IPC 5, 355  
     definition 12  
 isRegistered 112

**L**

-l 26  
 Load-sharing of Publishers 138  
 Locator 12, 187  
 Locator Audit 188  
 Locator Dynamics 140  
 Locator Failure 142  
 Locator Functionality 87  
 Locator options 286  
 Locator Service 8, 9, 31, 68, 82, 88, 110,  
     118, 123, 124, 126, 127, 135, 136,  
     138, 140, 141, 142, 144, 145, 147,  
     149, 150  
     about 7, 17  
     adding support for 136  
     back-up locator 17, 135  
     command line options 247  
     configuration 145, 147, 274, 286  
     definition 12

- failure 142
- parameter examples 149
- primary locator 9, 126
- rank 11, 118, 137
- usage scenarios 140, 144, 145

locator service 17

- using 17

locator\_rank 117

locator\_transport 117

## M

message

- decoding 7, 191, 193
- encoding 7, 191, 193, 280

Messages

- definition 302

messages

- format 312
- initialization messages 255
- listening strategy 313

Metrics

- Connexis Viewer 243

metrics

- processing 239
- subscribitng to service 238

Metrics Collection

- displaying 207
- saving 234
- starting 208
- stopping 234

Metrics Data

- obtaining 237

Metrics port

- adding 238

metrics port 238

Metrics Service 237

Metrics Support 154

Metrics Window

- Application Errors Information 228
- Application Incompatibility Information 232
- Audits Information 219
- DCS Errors Information 225
- Detailed Information 214
- Engineering Information 221
- Messages 216
- Summary Metrics Collection 210
- using 208

minimal DCS Library Configuration

- creating 296

Models

- HelloWorld 18
- Quick start 31

models

- converting connexis models 99

multiple publishers 131

## N

-n 26

Name Resolution 118

Name Service

- creating 150

notification 10, 12, 62, 93, 113, 121

- definition 12
- rtBound 10, 62, 66, 93, 133
- rtUnbound 10, 133
- turning on 61, 62
- use of 133

**O**

Object Information column 167

Operation Queue 268, 280

**P**

package

rationale for creating 37

sharing external 83

packages

removing shared 85

patterns

Client/Server (Connexis) 108

Peer to Peer 109

port

adding a metrics port 238

API 112, 115

bindingNotification() 113

        bindingNotificationRequested()  
            113

deregisterSAP() 112

deregisterSPP() 112, 137

getRegisteredName() 113

isRegistered() 112

        registerSAP() 68, 93, 112, 115,  
            118, 125, 126, 137, 138,  
            139, 141        registerSPP() 68, 69, 112, 115,  
            118, 124, 137, 138, 139,  
            141

Binding Failures 227

    publisher 10, 118, 124, 125, 126, 127,  
        137, 139, 141

Reference Trace 188

    subscriber 93, 110, 112, 118, 124,  
        126, 127, 136, 137, 139, 141

unwired end port

definition 13

wired end port 14

definition 13

ports

ranking published 137

replicated publisher ports 131

Preferences 159

select Session defaults 159

processor 7, 10, 13, 124

adding 175

changing properties 176

creating 56

removing 177

Protocol Messages Trace option 189

Publication 136

published ports

ranking 137

publishers

fully subscribed 141

load sharing 138

multiple 131

**Q**

Quick build 57

**R**

-r 26

race condition

locator 144

Ranking Published Ports 137

Rational technical publications

contacting iv

- Rational technical support
  - contacting iv
- reference tract 188
- registerSAP 112
- registerSPP 112
- registration 15, 17, 31, 67, 68
  - application 93, 113, 114, 115, 123
  - automatic 93, 109, 113
  - parameters 115, 116, 137
    - example 118
    - locator\_rank 117, 118, 137
    - locator\_transport 117, 118, 139
  - Publisher Registered with the DCS 128
  - Publisher Registered with the ILS 127
  - Publisher Registered with the Locator 130
  - string 7, 16, 68, 82, 110, 123, 124, 126, 127, 138
  - string grammar 245
  - summary 127
  - unwired port 110, 111
- removing
  - Shared Packages 85
- Replicated Publisher Ports 131
- Reset audit 273
- rtdAgentActive (out signal) 94
- rtdAgentActiveReply (in signal) 95
- rtdBackup Endpoinp (out signal) 94
- RTDBase 263
- RTDBase\_Agent 88, 263
  - Viewer requirements 153
- RTDBase\_Locator 69, 88, 126, 127, 136, 263
- RTDBase\_Locator\_Agent 126, 136, 263
  - Viewer requirements 153
- rtdCDMport (out signal) 94
- rtdCDMportReply (in signal) 95
- RTDConnexisAPI 348
- rtdDCSrunning (out signal) 94
- rtdDCSrunningReply (in signal) 95
- RTDErrorType Error Reporting 104
- RTDInitStatus protocol (Connexis) 93
- RTDInterface 20
- rtdLocator Available (out signal) 94
- rtdLocatorAvailable Reply (in signal) 96
- RTDMetrics In Signals 240
- RTDMetrics Out Signals 239
- rtdPrimary Endpoint (out signal) 94
- rtdPrimaryEndpoint Reply (in signal) 97
- RTDTIF 341
- RTDTransport 339
- rtdTransport Controller (out signal) 94
- RTDTransport subclass
  - implementing 320
- RTDTransportAddress 325
- RTDTransportAddress subclass
  - implementing 317
- RTDTransportAddressFactory subclass
  - implementing 316
- rtdTransportControllerReply (in signal) 97
- RTDTransportEndpoint 332
- RTDTransportEndpoint subclass
  - implementing 319
- RTDTransportEndpointFactory 331
- RTDTransportEndpointFactory subclass
  - implementing 318
- RTDTransportProfile 341
- rtdVClimit (out signal) 94

rtdVCLimitReply (in signal) 97  
RTProtocol interface 112

## S

-s 26  
SAP 12  
send  
    broadcast sends 132  
    data (Connexis) 134  
    data classes by value 134  
sending  
    data 134  
    Data Classes by Value 134  
Service Access Point 12  
Service Provisioning Point 12  
Session defaults 159  
signal names 42  
simplex locator service 12  
SPP 12  
Subscriber and Publisher Registrations  
    229  
Subscriber Losing Connection to a Pub-  
    lisher 142  
Subscription 137  
Subscriptions  
    queueing 125

## T

tagged-values 12  
Target Agent 8, 88, 136, 188  
    Viewer requirements 153  
Target Observability 9, 152  
Target RSL 12  
Target Run-time Service Libraries  
    *see Target RSL*

Target Run-time System Libraries 12  
TCP 12, 355  
TCP/IP 12, 355  
thread  
    configuration (Connexis) 262  
threads  
    configuration 262  
    DCSAndLocator 263  
    default number of (Connexis) 264  
    helper 118  
        priority 265  
    main 98, 265  
    TargetAgent  
        priority 265  
    TargetRSLDebug 265  
    timer 265  
    transport 265  
        priority 265  
TIF 13, 299  
    definition 303  
TIF Classes 322  
    RTDConnexisAPI 348  
    RTDTIF 341  
    RTDTransport 339  
    RTDTransportAddress 325  
    RTDTransportAddressFactory 323  
    RTDTransportEndpoint 332  
    RTDTransportEndpointFactory 331  
Tools Menu 159  
trace  
    define a 199  
    generating interaction diagrams from  
        output files 202  
    location settings 190

- port reference 188
- show data 197
- virtual circuit 192
- trace filters 185
- trace group
  - Network Data in 191, 193
  - Network Data out 191, 193
  - User Data in 190, 193
  - User Data out 191, 193
- trace levels
  - component instance
    - advanced 182
    - basic 182
    - disabled 182
    - operational 182
  - port reference
    - activity 192
    - disabled 192
    - signal 192
    - signal and data 192
  - virtual circuit
    - activity 194
    - disabled 194
    - signal 194
    - signal and data 194
- trace limit (Connexis) 160
- trace options 186
- traces
  - component instance 182
  - defining 182
  - port reference 188
  - virtual circuit 192
- Tracing defaults 159
- Transmission Control Protocol 12
- Transport 12
  - auditing 311
  - blocking/non-blocking 309
  - integrating 315
  - understanding 305
- transport 10
  - buffer pool 268, 269, 270
  - component 14, 16, 274
  - definition 12
- Transport Agent 87
- transport and protocols
  - naming 306
- transport buffer pool 269
- Transport Errors 226
- Transport failures
  - recovery 311
- Transport Integration
  - building 321
  - overview 300
  - packaging 321
  - significant threads 304
  - testing 322
  - using in another model 322
- Transport Integration Framework 299
  - overview 300
- Transport Integration Framework (TIF)
  - 13
- Transport Intergration
  - definition 303
- transport settings 87
- Transport specific options 282
- Transporter 186
- Transporter Audit 188
- Transporter options 278

transports  
    manually integrating into model  
        model  
            manually integrating trans-  
                ports (Connexis) 88

type descriptor  
    Version Mismatch 230

## U

UDP 13, 355

UDP/IP 355

UML 5, 6, 7, 10, 11, 13, 14, 16, 31

Unified Modeling Language 13  
    *see UML*

unwired port 13  
    registration 110

User Datagram Protocol 13  
    *see UDP*

## V

VC Mismatches 227

Viewer 88, 136  
    adding a component instance 177  
    adding a processor 175  
    adding support for 153  
    architecture 153  
    changing a component instance's  
        properties 180  
    changing a processor's properties 176  
    command line options required 154  
    component instance 168  
    configuration 274, 287  
    creating component instances 175

    creating processors 175  
    defining component instance trace  
        182  
    defining port reference trace 188  
    defining virtual circuit trace 192  
    duplicate CNX unique identifiers 156  
    log window 157  
    main menu 156  
    main window 156  
    named service 168  
    Object Information column 167  
    processor 168  
    registered end port 168  
    removing a processor 177  
    setting trace buffer size 191, 193  
    software errors 235  
    software warnings 235  
    starting 155  
    starting from deployment diagram  
        155  
    status bar 157  
    Target Agent  
        connecting to 171  
    trace pane 156  
    tree view 156  
    Viewer 8  
    virtual circuit 168

Viewer icons  
    component instance 163  
    Named services 165  
    port icons 165  
    processor 163  
    virtual circuit 166

- Viewer menus
  - File 158
  - Help 161
  - View 158
  - Windows 161
- Viewer popup menus
  - component instance 170
  - port reference 173
  - processor 169
  - session 168
  - virtual circuit 174
- Viewer trace window
  - component instance 194
  - virtual circuit 195
- Virtual Circuit
  - definition 302
- virtual circuit 9, 13, 118
  - definition 13
- Virtual Circuits 271
- VxWorks
  - inclusion path 26

## W

- wired port 13
- wired ports
  - connecting (Connexis) 15